

NOTES:  
 1. REFER TO PARTS LIST FOR COMPONENT VALUES  
 2. UNLESS OTHERWISE NOTED RESISTOR VALUES ARE IN OHMS, AND CAPACITOR VALUES ARE IN MICROFARADS.  
 3. VOLTAGE NOTATIONS ARE AS FOLLOWS:  
 ( ) ---TX HI POWER  
 [ ] ---LAMP ON  
 ( ) ---TX MID  
 [ ] ---UL (ON TIGHT)  
 ( ) ---SPU端子にプラグを付けた時  
 [ ] ---TX LOW  
 4. NO MARKING CAPACITORS AND RESISTORS ARE ALL CHIP PARTS.

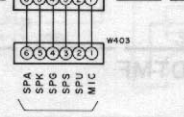

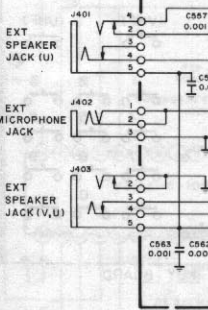
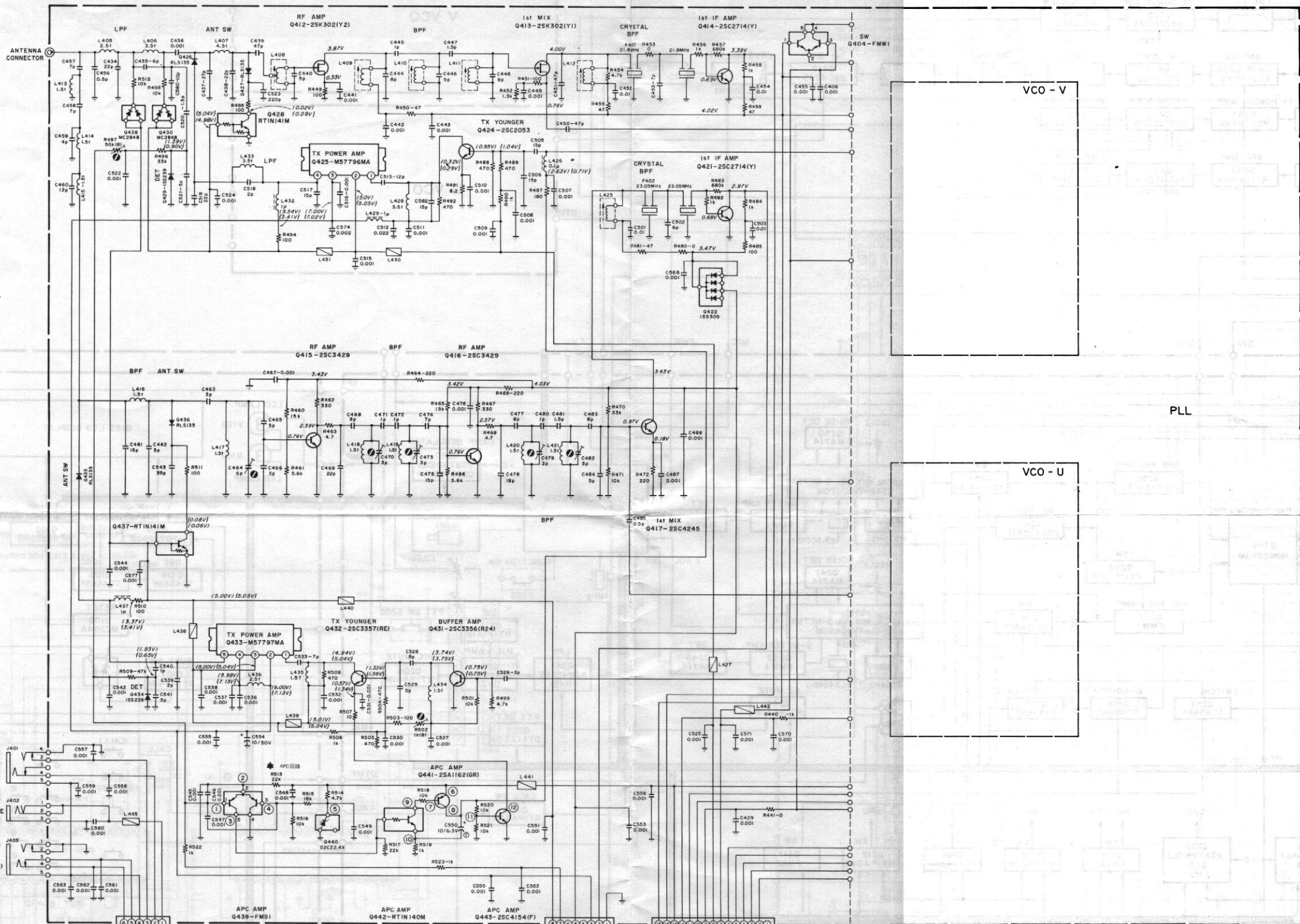

▲ APC 回路電圧 (V)

調整 ポイント	VHF			UHF		
	HI	MID	LO	HI	MID	LO
①	0.60V	0.67V	0.59V	0.67V		
②	1.15V	1.17V	1.15V	1.17V		
③	1.13V	0.52V	1.13V	0.42V		
④	0.61V	0.62V	0.62V	0.62V		
⑤	1.76V	1.76V	1.75V	1.78V		
⑥	5.01V	5.03V	5.02V	5.04V		
⑦	4.28V	4.37V	4.29V	4.46V		
⑧	4.93V	1.39V	4.93V	1.52V		
⑨	0.44V	4.21V	0.43V	4.45V		
⑩	0.39V	0.01V	0.39V	0V		
⑪	0.64V	0.55V	0.74V	0.65V		
⑫	0V	0V	0.16V	1.30V		

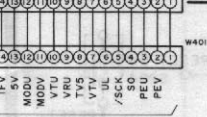
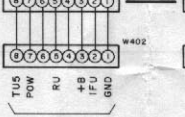

- NOTES:
1. REFER TO PARTS LIST FOR COMPONENT VALUES.
  2. UNLESS OTHERWISE NOTED RESISTOR VALUES ARE IN OHMS, AND CAPACITOR VALUES ARE IN MICROFARADS.
  3. VOLTAGE NOTATIONS ARE AS FOLLOWS:  
 ( ) ----- TX HI-POWER  
 < > ----- UL  
 NO MARKING ----- RX VHF UHF SQL OFF
  4. NO MARKING CAPACITORS AND RESISTORS ARE ALL CHIP PARTS.

**CONTROL**

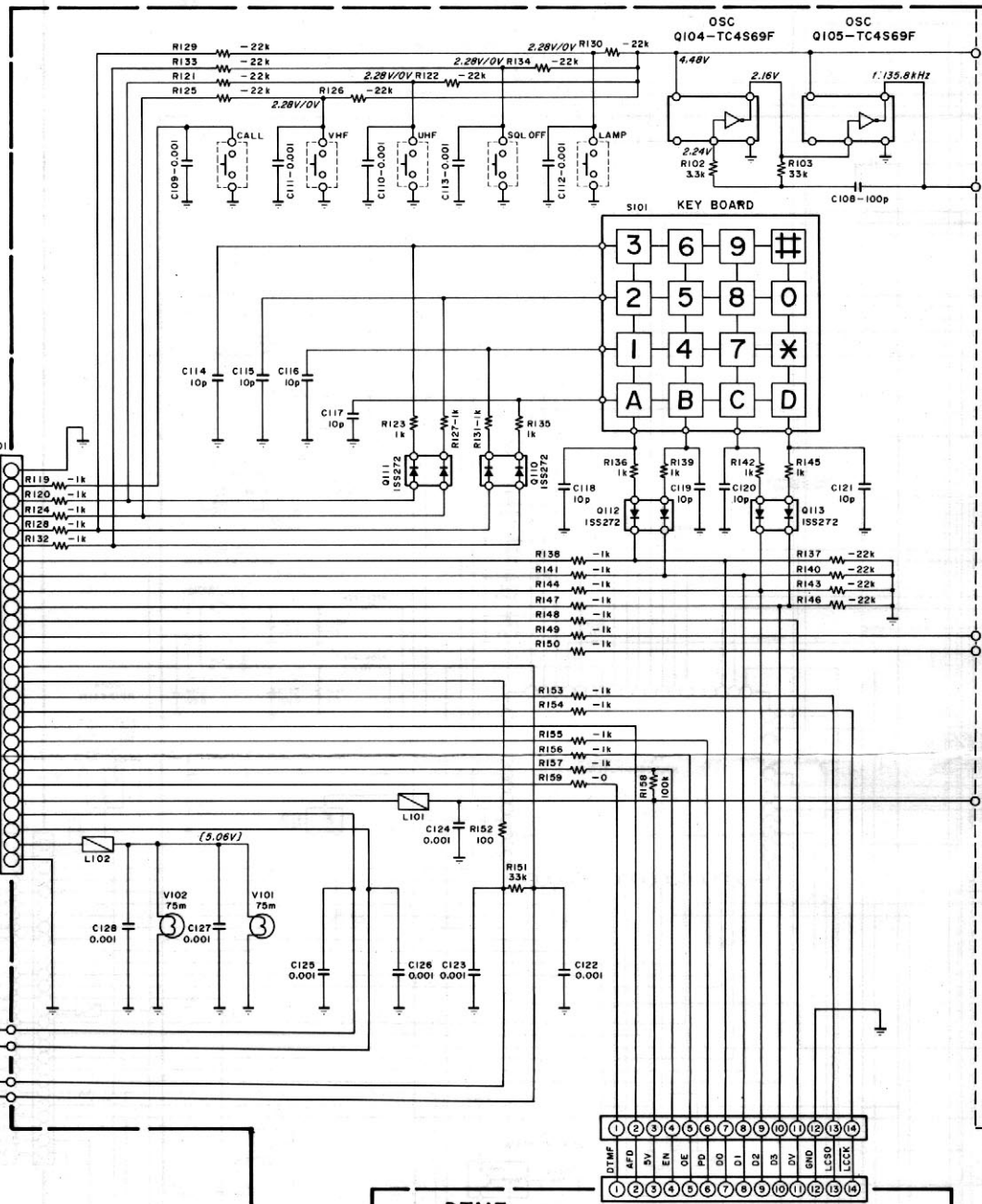

LCD



DTMF

Downloaded by  
 RadioAmateur.EU

# CTN520

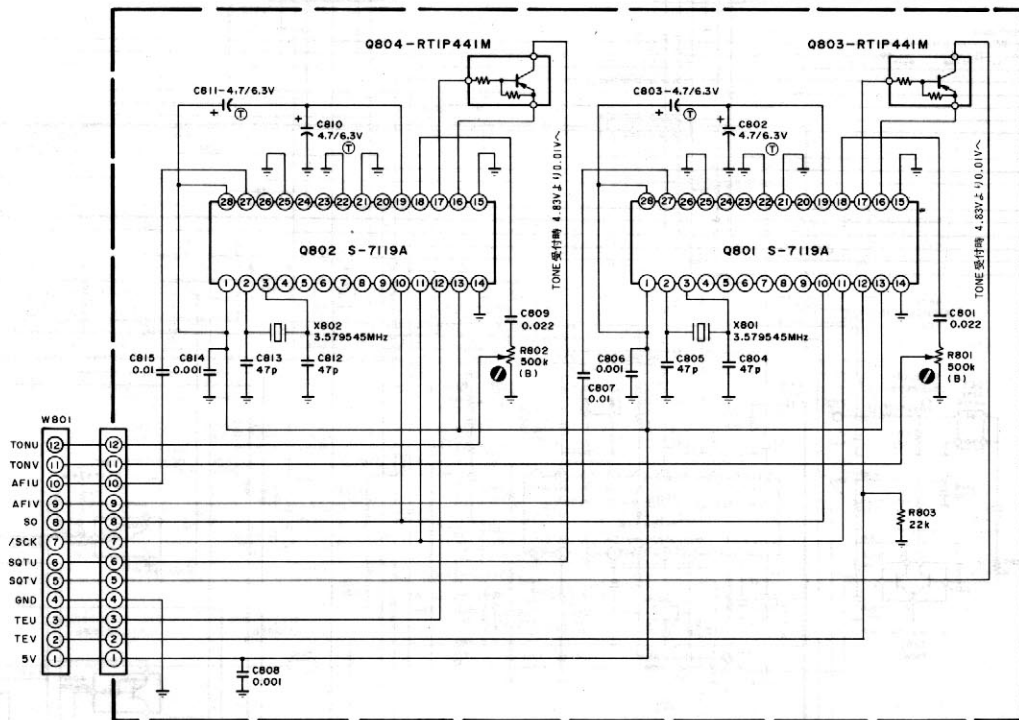

## Q801, Q802 VOLTAGE

PIN NO	TSQ OFF	TSQ RX	TONE TX
1	5.04V	5.03V	5.00V
2	3.17V	2.36V	2.33V
3	5.04V	2.45V	2.46V
4	5.01V	2.57V	4.97V
5	5.01V	5.00V	4.97V
6	5.01V	5.00V	4.97V
7	5.01V	5.00V	4.97V
8	5.01V	5.00V	4.97V
9	5.01V	5.00V	4.97V
10	0.01V	0.01V	0.01V
11	4.25V	4.25V	4.25V
12	0.01V	0.01V	0.01V
13	5.04V	5.03V	5.00V
14	0V	0V	0V
15	0V	0V	0V
16	0V	5.03V	4.81V
17	0V	TONE HI 5.03V	0.07V
18	0V	2.51V	2.50V
19	2.52V	2.51V	2.50V
20	0V	0V	0V
21	0V	0V	0V
22	0V	0V	0V
23	2.52V	2.51V	2.49V
24	5.01V	5.00V	4.97V
25	0V	0V	0V
26	2.26V	2.26V	2.24V
27	2.26V	2.25V	2.24V
28	5.04V	5.03V	5.00V

### NOTES:

1. REFER TO PARTS LIST FOR COMPONENT VALUES.
2. UNLESS OTHERWISE NOTED RESISTOR VALUES ARE IN OHMS, AND CAPACITOR VALUES ARE IN MICROFARADS.
3. NO MARKING CAPACITORS AND RESISTORS ARE ALL CHIP PARTS.



