

74477

**No. 1254
COMPLETE KIT WITH CASE,
HARDWARE**

SSB-CW-AM RECEIVER

Microprocessor-controlled,
15 Memories, dual conversion,
tunes 100 kHz to 30 MHz

TOKIT
by TEN-TEC

INSTRUCTION MANUAL

America's Best!

KIT Manual No. 74352
Price: \$10.00

Kit Assembly and Instruction Manual
for T-KIT Model No. 1254

SSB-CW-AM
Microprocessor-Controlled
100 kHz - 30 MHz Receiver



Guide to Table of Contents

The Table of Contents is printed on these upcoming pages:

I. GETTING STARTED Section	page 2
II. KIT ASSEMBLY Section (short form)	page 2
III. REFERENCE Section (short form)	page 2
(See first pages of Sections II and III for full contents)	
Table of charts and illustrations	page 3

T-KIT Limited Warranty: *inside back cover*

***IMPORTANT: Please read Warranty Terms
BEFORE starting kit assembly.***

. . . A quality electronics kit project from

T-KIT

a Division of TEN-TEC, Inc.
1185 Dolly Parton Parkway
Sevierville, Tennessee 37862
(423) 453-7172
Fax (423) 428-4483

Circuit board and manual Copyright © 1997. All Rights Reserved.
Manual text and design by Dan F. Onley, K4ZRA.

Table of Contents

Section I: GETTING STARTED

A. General Introduction to Receiver Design and Features	4
B. About this Manual and T-KIT	5
C. Working with the Kit Parts Before Assembly	6
D. Detailed Kit Parts List	8-13
E. Checklist of supplies and tools needed for assembly	14
F. Component Identification Information	15-17
G. Building Electronic Kits: The Essentials	18-19
H. Overview of Kit Assembly Phases	20

Section II: Kit Assembly and Alignment

Detailed Table of Contents	1
Installing Parts on the Boards	2
Phase 1.0 Display Board Assembly	3-10
Notes on Main Board Assembly	11-12
Phase 2.0 Logic Section and Display Drivers	14-24
Phase 3.0 VCO's and PLL ("Phase-Locked Loop")	26-35
Phase 4.0 Receiver Audio, AM and Product Detectors, 455 kHz IF Amplifier, AGC system	36-46
Phase 5.0 2nd Mixer, 2nd LO, Clarifier control	48-55
Phase 6.0 RF Input, 1st Mixer, 1st LO amplifier	56-63
Phase 7.0 Final Assembly and Alignment	64-72

Section III: Reference Information

Detailed Table of Contents	1
Specifications: T-KIT Model 1254	2
Model 1254 Operating Instructions	3-5
1. Functions of Primary Controls	
2. Storing Frequencies in Memory	
3. Recalling or Tuning Memory Frequencies	
4. Tuning AM signals	
5. Tuning SSB signals	
6. Tuning CW signals	
7. Microprocessor RESET	
8. Memory Battery Test	
Circuit Description	6-14
Model 1254 Receiver Block Diagram	8
Practical Operating Information	15-23
DC Power Supply, Audio, Antennas, Special installations, SWL basics and more	
GLOSSARY: Terms and Abbreviations	24-28
Component Reference Index	25-35
Troubleshooting Guide	36-39
<i>including</i> Chart of Significant Test Voltages	
Checking for Solder Bridges	40

Table of Illustrations, Charts and Diagrams

1 . Getting Started Section

Selected Component Illustrations

16-18

2. Assembly Section

Phase 1.0 schematic details	4
Phase 1.0 circuit board illustration	5
Fig. 1.1 : LED alignment	7
Fig. 1.2: Installation of J1 , J2	8
Fig. 1.3: Encoder wiring	9
Phase 2.0 schematic details	14
Phase 2.0 circuit board illustration	15
Fig. 2.1: Installation of P1, P2	17
Fig. 2.2: DC Power Input section	20
Phase 3.0 schematic details	26
Phase 3.0 circuit board illustration	27
Fig. 3.1: VCO-1 assembly	30
Fig. 3.2: VCO 2 assembly	31
Phase 4.0 schematic details	36
Phase 4.0 circuit board illustration	37
Fig. 4.1 : Headphone jack wiring	41
Phase 5.0 schematic details	48
Phase 5.0 circuit board illustration	49
Fig. 5.1: balun transformer details	51
Fig. 5.2: Installation of Q4, C63, Q7	53
Phase 6.0 schematic details	56
Fig. 6.1: RF Input Bandpass Filter Assembly	58
Fig. 6.2: First Mixer Assembly	60
Fig. 6.2b: Alignment Preview	61
Phase 6.0 Full circuit board illustration	62
Fig.7.1: Chassis and panel assembly overview	62
Table 7.1: Small hardware preview	66
Fig. 7.2: Functions of the chassis brackets	67

3. Reference Section

Fig. 1R: Frequency Display example	4
Fig. 2R: Spectrum plot examples	7
Fig. 3R: Block Diagram of Circuit Stages	8
Fig. 4R: PLL Block Diagram	9
Fig. 5R: A simple outdoor SWL antenna	16
Fig. 6R: DC power connector polarity	19
Fig 7R: Headphone jack wiring	21

Foldout Pages (after "Getting Started" section):

Mechanical Assembly Details

X-Ray View of Circuit Boards (color-coded)

A. Introduction to Model 1254 Receiver Features and Design

Building one's own receiver from a kit has launched countless thousands of people into communications careers or the hobbies of amateur radio and shortwave listening ("SWLing"). The Model 1254 combines the satisfaction of the kit-building experience with the performance features expected in a modern shortwave receiver. You will build a true dual-conversion superhet with precise microprocessor-controlled frequency synthesizer. Alignment is surprisingly easy and does not require complicated test equipment. Building this receiver yourself also gives you the assurance that you can maintain it in perfect working order for years to come.

General Features:

- Frequency coverage: 100 kHz to 30 MHz
- Choice of normal or fast tuning (2.5 kHz SSB, 5 kHz AM or 100 kHz in either mode)
- Fifteen programmable memories
- Convenient default or "empty" memory: 15 MHz (WWV)
- Synthesized 45-75 MHz local oscillator
- 45 MHz first IF
- 455 kHz second IF
- 4 kHz filter bandwidth combines good AM audio response with excellent SSB-CW selectivity
- Semiconductors: 10 IC 's, 26 transistors, 16 diodes
- Antenna connector can supply DC voltage for active antenna
- 1.5W audio output, built-in speaker, headphone jack
- Includes a wall-type 15VDC power supply but will operate from any 1 2-16 VDC 500 mA power source

You will build the Model 1254 in seven sections or phases, testing your work after completing each phase. We encourage you to study this entire manual before beginning construction.

- A detailed circuit description and block diagrams are provided in the Reference Section, Part 3 of this manual.
- If you have never built an electronics kit before, please see pages 18-19.
- See page 14 for tools and supplies required to build the kit and use the receiver.

B. About This Manual and T-KIT

This T-KIT Manual has THREE sections:

1. Getting Started

(This one, which includes the KIT PARTS information prior to any soldering.)

2. Kit Assembly

(Presented in seven step-by-step illustrated "Phases".)

3. Reference Information

(Such as operating instructions, circuit description, troubleshooting guide and much more.)

**We understand you may be anxious to get going!
When you are ready to do something instead of read,
Go straight to the KIT PARTS LIST,
Starting on Page 8. Use the check boxes
To make SURE you have every single part listed.
But, PLEASE READ
At least this very short "Getting Started" chapter
Before trying ANY soldering to the circuit boards!**

ALL of us "build kits" of many kinds. We do it every time we bring home a new box marked "some assembly required"! And most of us love to use our own Common Sense first to see how quickly we can put together that new bike, computer desk or some gadget before we ever look at the instruction sheets! This approach is fine for mechanical assembly projects, but it is disastrous for modern electronic kit projects.

**This book is the key to your success with the
Model 1254 Receiver Kit project you are starting.
It's a TWO-WAY DEAL.
You count on the information in this manual
And we now count on you to follow it.**

You just invested serious dollars in a box containing electronic and sheet metal parts plus this book. The same money could have gotten you a comparable receiver, maybe pre-owned, very nice and ready to use. But you still chose to build this kit. The main reason to build equipment such as the Model 1254 is usually the building experience itself. Plus some new electronics know-how and understanding which can come with such experience. The purposes of this manual are to help you have a kit-building experience which is both successful and enjoyable!

Electronic kit-building has changed dramatically during the 50 years since TEN-TEC's founder (Al Kahn, K4FW) gave a boxcar loaded with war surplus parts to some friends who started a company which became known as Heathkit™, so, the several generations of "the hams at TEN-TEC" are very aware of the standards remembered by all of us who enjoyed building major kit projects in decades gone by. Be assured that we refer to a large library of the most respected manuals of yesteryear as well as T-KIT customer comments in continuing to provide you with today's best in electronic kit projects.

Today's electronic parts are much smaller and more delicate than they were a few decades ago. This fact challenges today's kit-builders to become much more careful than in the past when identifying and installing circuit board components.

Those nice double-sided boards with the plated-through holes should be a further motivation for close attention to directions and parts identification. While soldering is fairly easy, **the "desoldering" process is extremely tedious**, often requiring the purchase of replacement parts.

On the other hand, we know you will appreciate the classic precision and sturdiness of your kit's metal enclosure hardware custom designed and manufactured here at TEN-TEC.

C. Working with the Kit Parts BEFORE beginning Assembly

- 1. Read the terms of the T-Kit Limited warranty Now! It explains both our responsibilities and yours.**
2. The success of your project depends on your willingness to study this manual. Check your kit package Now for any update sheet(s) to supplement this manual.
- 3. The bag containing the Display Board includes ALL parts used for the Display Board, Assembly phase 1.0. After checking the contents of the Display Board bag, keep those parts together and separate from all other kit parts.**

4. **Check and organize ALL Main Board parts per the Kit parts List before you start soldering.** Electronics hobbyists have many different ways of sorting and organizing small parts: standing them on a block of styrofoam or in the holes along the edge of corrugated cardboard, arranging them in an egg carton or muffin tin, or making logical piles in a small tray.
5. This kit manual offers you the further opportunity to "PRE-ORGANIZE" the parts exactly needed for each of the five Main Board Assembly Phases 2.0 through 6.0. After the sectional board drawings and schematics introducing each Assembly Phase, see the Quick Reference List of parts (with circuit functions) used for that phase.

There are a few VERY Small Parts . . .

The main goal, of course is to locate these and not to lose them!

- ferrite beads for C63 and Q7 (2)
- plastic crystal base insulators for Y1, Y3 (2)
- setscrew for main Tuning Knob

HARDWARE ITEMS

Please refer as needed to the "Model 1254 Mechanical Details" foldout page at the end of this section to see how all major parts and sections of your receiver go together. Sizes and descriptions of smaller hardware items such as screws are specified clearly in instruction steps.

6. **If you believe any parts are missing from your kit package, the warranty explains how to contact us for replacement parts.**
7. We encourage you just to take your time with this project. Build it for the sake of the building experience. You'll use the receiver for years, but you'll only build it once. It really is worth your time to learn about it as you build it!

D. T-KIT Model 1254 Receiver KIT PARTS LIST

1. Check and organize all parts before starting construction.
2. **See T-KIT Warranty if you believe any parts are missing. The Warranty explains how to contact us.**
3. If “***” appears in the "Schematic" column for a common part value, please refer to the Component Reference Index (in "Reference" section) to see all uses of that value.

A. Model 1254 Front Display Board Kit

(These are packed together in one bag. Keep them together, separate from the other kit parts.)

Quantity	Description and Value	Schematic	Part No.
8	Resistor: 33 ohm (orange-orange-black) 1/4watt.....	R1-R8	30120
1	Resistor: 1K (brown-black-red) 1/8 watt.....	R9	30138
4	1N4148 silicon diode	D1-D4	28001
2	Green LED	D5-D6	28082
6	LED Display	U1-U6	28201
4	Mini pushbutton switches, momentary	SW1-4	32113
4	Switch button keycap	for SW1-4	38235
2	8 position pin header socket	J1, J2	35277
1	Rotary Encoder	EN1	32122
1	3-wire plug assembly (for encoder)		86085-02
1	SPDT toggle switch	DC power	32121
1	2-wire (red) plug assembly (power switch)		86085-01
1	Insulating sleeve (for power switch, phone jack) 5"Piece		44035
1	Display circuit board, 2-sided, plated-through holes		78092D

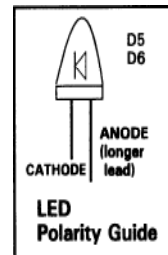
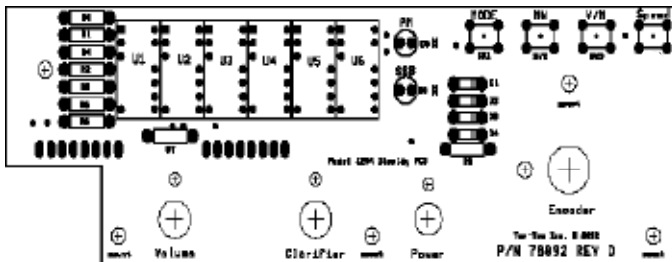

B. Main Receiver Circuit Board Parts

● Fixed Resistors

The 3 color bands denote resistance value. The 4th band (gold) denotes 5% tolerance. All resistors are 1/4-watt unless specified otherwise.

Quantity	Description and Value	Schematic	Part No.
4	□ "zero ohm" jumper (single black band)	JMP1-3, R66	30353
2	□ 4.7 ohm (yellow-violet-gold)	R1, R45	30111
3	□ 47 ohm (yellow-violet-black)	R28, 34, 40	30122
12	□ 100 ohm (brown-black-brown)	***	30126
2	□ 150 ohm (brown-green-brown).....	R20, R21	30128
6	□ 220 ohm (red-red-brown).....	***	30130
5	□ 470 ohm (yellow-violet-brown)	***	30134
5	□ 1K (brown-black-red)	***	30138
2	□ 1.5K (brown-green-red)	R16, R17	30140
4	□ 2.2K (red-red-red).....	R47, 61, 85, 87	30142
5	□ 4.7K (yellow-violet-orange)	***	30146
18	□ 10K (brown-black-orange).....	***	30150
1	□ 15K (brown-green-orange)	R15	30076
5	□ 22K (red-red-orange).....	***	30154
12	□ 47K (yellow-violet-orange)	***	30157
1	□ 150K (brown-green-yellow)	R44	30163
1	□ 220K (red-red-yellow)	R49	30077
1	□ 1 megohm (brown-black-green).....	R48	30173
1	□ 10 megohm (brown-black-blue).....	R2	30185

● Disc Ceramic Capacitors

Quantity	Description and Value	Schematic	Part No.
1	□ 1 pF	C55	23247
1	□ 2 pF	C30	23301
1	□ 3 pF	C23	23248
1	□ 8 pF	C57	23250
3	□ 10 pF	C24, 27, 28	23251
1	□ 15 pF	C52	23253
1	□ 18 pF	C31	23302
2	□ 20 pF	C94, C95	23254
1	□ 27 pF	C19	23375
4	□ 33 pF (wider lead spacing)	C21, 22, 77, 78	23376
1	□ 33 pF (narrow lead spacing)	C5	23246
4	□ 47 pF	C54, 56, 70, 73	23378
1	□ 56 pF	C83	23379
2	□ 75 pF	C39, C84	23382
2	□ 100 pF (marked 101)	C91, C92	23385
1	□ 150 pF (marked 151)	C37	23388
4	□ 180 pF (marked 181)	C37, 40, 71 72	23389

Disc capacitors cont.

Quantity	Description and Value	Schematic	Part No.
1	220 pF (marked 221)	C36	23396
14	.001 μ F (marked 102)	***	23245
8	.01 μ F (marked 103)	***	23260
26	0.1 μ F (marked 104)	***	23261

● Film Capacitors (5% tolerance)

Quantity	Description and Value	Schematic	Part No.
2	.0022 μ F (marked 221)	C89, C90	23286
1	.0068 μ F (marked 682)	C74	23338
2	.047 μ F (marked 473)	C10, 12	23291
1	.01 μ F (marked 103)	C11	23340
1	0.47 μ F (marked 474)	C9	23330

● Other Capacitors

Quantity	Description and Value	Schematic	Part No.
1	Trimmer capacitor, 5-40 pF	C2	23413
2	1 μ F electrolytic	C8, C93	23264
4	10 μ F electrolytic	C18, 32, 45, 98	23266
8	33 μ F electrolytic	***	23308
4	470 μ F electrolytic	C1, 43, 51, 106	23228

● Inductors

Quantity	Description and Value	Schematic	Part No.
1	0.12 μ H unshielded adjustable coil	L11	21180
1	Shield can for L11	(L11)	38131
2	0.25 μ H unshielded adjustable coil	L9, L10	21059
2	Shield cans for L9, L10	(L9, L10)	38226
3	Shielded 455 kHz adjustable coil	T2, T3, T7	21093
1	0.1 μ H coil shielded (5 pins, no marking)	T6	21194
1	VCO coil, 48-58 MHz (white, 3 wires, more turns) ...	L3	85421-01
1	VCO coil, 58-75 MHz (white, 3 wires, fewer turns) ...	L2	85421-02
1	0.27 μ H molded inductor (red-violet-silver-gold)	L4	21105
4	0.39 μ H molded inductor (orange-white-silver-gold)	L5, 13, 14, 17	21107
1	0.47 μ H molded inductor (yellow-violet-silver-gold) ..	L8	21108
2	0.56 μ H molded inductor (green-blue-silver-gold)	L7, L15	21109
1	1.0 μ H molded inductor (brown-black-gold-gold)	L18	21112
2	4.7 μ H molded inductor (yellow-violet-gold-gold)	L6, L19	21120
1	6.8 μ H molded inductor (blue-gray-gold-gold)	L16	21122
3	100 μ H molded choke (brown-black-brown-gold)	L1, L12, L20	21164
2	Balun transformer, bifilar	T1, T8	21152
3	Balun transformer, trifilar	T4, T5, T9	21153
2	Ferrite bead (.120X.060X.085)	at Q4, Q7	21090

See page 16 for help in identifying molded inductors!

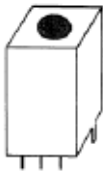









SORTING THE SHIELDED COILS

1. T2, T3, T7: 455 kHz transformers (3) are factory-shielded
2. T6 is the pre-shielded coil larger than T2, T3, T7.
3. L9 and L10 are identical; add shield "cans" during assembly.
4. L11 is the small adjustable coil, shield added during assembly.

See Page 17 for VCO coil details (L2, L3)

● **Integrated Circuits**









Quantity	Description and Value	Schematic	Part No.
1	 PIC16C57-XT/P microcontroller IC (pre-programmed)	U2	98394-1.0
1	 MC7805CT (or LM340T-5) 5-volt regulator IC	U1	25095
2	 MC1350P IF Amp IC	U8, U9	25062
1	 MC145170P1 PLL synthesizer IC	U3	25296
1	 NE612AN (orSA612AN) mixer-oscillator	U7	25319
1	 SN74LS47N BCD decoder IC	U4	25336
1	 BA618 LED display driver IC	U5	25341
1	 NJM7810FA voltage regulator IC	U10	25400
1	 NTE 1852 audio amplifier IC	U6	25356

Mounting hardware for U10 (packed with IC's):

Quantity	Description and Value	Part No.
1	 #4-40 3/8" screw, phillips (zinc)	60003
1	 #4 lock washer, internal tooth	51002
1	 #4-40 hex nut	54002



















About IC Sockets: T-KIT s include DIP sockets for ICs only if we consider a socket essential for that kit design, such as the U2 microprocessor in this receiver. Out technicians find that sockets can cause more problems than permanently installed IC's.

● **Transistors and Diodes**

Quantity	Description and Value	Schematic	Part No.
15	 2N4124 NPN transistor	***	25258
3	 2N5087 PNP transistor	Q10, Q17, Q18	25001
6	 J310 JFET transistor	***	25115
1	 BF988 dual-gate MOSFET transistor	Q4	25388
1	 MP5A14 transistor	Q19	25253
8	 IN4148 silicon diode	D1,4,5,10,11,12 ,15,16	28001
2	 BA479 PIN diode	D13, D14	28062
2	 1N753A zener diode, 6.2 volt	D6, D7	28055
1	 1N748A zener diode, 3.9 volt	D17	28021

See page 17 for help in identifying diodes!

● **Other Components, Board-Mounted Hardware:**

Quantity	Description and Value	Schematic	Part No.
1	 Circuit Board for Model 1254		78138
1	 28 pin IC socket for microprocessor U2	(U2)	27021
2	 10K potentiometer (volume, clarifier controls)	R73, R82	30267
NOTE: (The mounting nuts and washers for the volume and clarifier controls may be pre-attached or included with other hardware.)			
1	 100 ohm trimmer potentiometer (1st mixer balance)	R70	30856
1	 Crystal, 3.579545 MHz	Y1	48079
1	 Crystal, 44.545 MHz	Y3	48235
1	 455 kHz ceramic resonator {marked 4558K}	Y2	48228
1	 45 MHz crystal filter (crystal case, 3 leads)	FL1	48339
1	 455 kHz IF filter (Murata CFR455I)	FL2	48284
2	 2-pin PC-mount terminal (DC switch, speaker)	J2, J5	35065
2	 3-pin PC-mount terminal (encoder, phone jack)	J4, J6	35066
1	 RCA phono jack (antenna)	J3	35238
1	 Coaxial DC power jack	J1	35266
2	 Right-angle 8 pin header	P1, P2	35276
2	 Crystal base insulator	for Y1, Y3	38229
4	 RF shield main enclosure		91744
2	 RF shield top cover		91745
1	 9-volt battery snap (for memory backup battery)		35174
1	 Insulator pad HC-45U		38262

LOOK AHEAD . . .

To the “Component Reference Index”!









This **Parts List** shows the quality of each type of part supplied in your kit. The **Component Reference Index** in the Reference Section, Part 3 of this manual, keyed to the schematic diagram, identifies the assembly step for each part as well as Descriptive information about each part. This Index is your assurance (and ours!) That every component is accounted for in the Assembly Steps, cross-checked to the Full schematic and sectional schematic diagrams.

EXAMPLE:















C1	470/16v el.	2-30	23228	Filter Cap for display driver
C2	5-40 pF var.	2-33	23413	Master clock (adjust to 3.5800 MHz)
C3	0.11tF	2-23	23261	Bypass on PLL chip
C4	33/16v el.	2-31a	23308	Bypass on PLL chip

C. Chassis Parts and Other Hardware





See Foldout titled "Mechanical Assembly Details" inserted at the end of this section. This drawing will help you identify major mechanical parts.

Quantity	Description and Value	Schematic	Part No.
1	 Front panel assembly for Model 1254		93341-1A
1	 Plastic insert for front panel headphone jack		93367
1	 Rear panel		93342-CN1A
1	 Left side chassis panel		93116
1	 Right side chassis panel		93109
1	 Speaker/battery shelf		93110
1	 Steel bottom shell cover		93111-CN
1	 Steel top shell cover		93112-CN
1	 3" round speaker		47011

Hardware Parts Bag:

Quantity	Description and Value	Schematic	Part No.
1	 1/8" panel-mount phone jack	J8	35298
1	 .050" hex allen wrench (for front panel knobs)		38040
4	 Rubber bumper feet (self-adhesive)		42001
4	 #4 lock washer (split style)		51058
8	 #4-40 1/4" screw, phillips (zinc)		60001
4	 #4-40 1/4" screw, phillip, (black)		60032
8	 #4-40 3/16" undercut ("countersink") screw		60080
4	 #4 self-threading screw (to secure front panel)		65009
1	 #4-40 Setscrew (for Tuning knob - SEE NOTE BELOW)		65015
2	 Control knob		81559
1	 3-wire plug assembly (headphone jack)		86085-3
1	 2-wire plug assembly (speaker)		86085-4
1	 Tuning knob		93029
1	 TEN-TEC logo		98228
1	 Tinted, screened display lens		98393

D. Standard Accessories

Quantity	Description and Value	Schematic	Part No.
1	 Model 1254 instruction manual		74477
1	 Model 1254 Quick Reference Guide and SWL Log		74353
1	 Model 1254 full schematic/construction overview sheet		74354
1	 15VDC @800mA wall-plug power supply		21195

Suggestion: Use the allen wrench supplied to install the No. 65015 setscrew into the Tuning Knob NOW, so it will not be lost!

E. What YOU provide to build and operate this T-KIT Model 1254 Receiver

REQUIRED, NOT SUPPLIED

- 9-volt battery (memory backup)
- Antenna(s) for bands of interest
- thin-diameter rosin core solder
- contact cement (to secure panel jack insert, speaker and logo)

RECOMMENDED, NOT SUPPLIED:

- masking tape (to protect front panel during final assembly)
- headphones with 1/8" stereo plug

MINIMUM TOOLS FOR KIT ASSEMBLY:

- 25 to 35 watt soldering iron
- diagonal cutters or wire "nippers"
- needle-nose pliers
- utility (household) pliers
- adjustable wire stripping tool
- insulated alignment tools (may be home made from plastic stirrer, etc.)
- medium phillips and slotted screwdrivers

MINIMUM TEST EQUIPMENT:

- VOM or DVM for DC voltage measurements

OPTIONAL TEST EQUIPMENT:

- Frequency counter
- RF signal generator

HELPFUL ADDITIONAL TOOLS

- miniature alligator clip jumper leads
- desoldering tool
- illuminated magnifier

F. Model 1254 Receiver Parts Identification Notes

We rely on you to know already what a resistor, transistor, IC "chip" and other common electronic parts "look like."

REMINDER: Both the back and inside front covers of this manual provide some light-hearted help on basic parts identification.

Each assembly step provides useful help in identifying any part, whether by shape, color-code, manufacturer's markings, or other description.

Since correct parts installation is the key to this Receiver working perfectly, we encourage you to refer to the following Parts Identification Notes whenever you feel it necessary.

Table 1-A

RESISTORS:

The Main Board uses only 1/4-watt resistors, while the Display Board uses smaller 1/8-watt resistors packed in the bag with the Display Board itself. Each instruction step lists the first THREE color bands, assuming the fourth band to be gold (5% tolerance). Just be careful about that third "multiplier" band. For example, your kit uses 4.7, 47, 470, 4.7K and 47K resistors, each for very different purposes.

Table 1-B

MOLDED INDUCTORS

(also called "CHOKES").

These parts are readily recognized because:

1. They are packed with other coils, transformers, etc.
2. While similar to resistors, they have "bullet"-shaped ends.
3. The body consistently has a green-bluish color.

While these parts follow the resistor color code chart for value identification, we will be the first to agree with you that these color bands really can be **HARD** to read. **EXAMPLE:** red, orange and brown can each look like some shade of mud. NO, your eyesight is NOT the problem!

We suggest:

1. Sort all the inductors by quantity required in the Parts List.
2. Set aside (and mark on paper) those which are completely clear to you.
3. Compare PAIRS of bands and pay close attention to the 3rd (multiplier) band
4. A "Process of Elimination" is the easiest way to resolve questions.

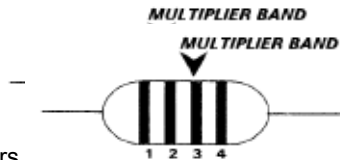

Table 1-C

Diode Identification Guide

The main board uses eight 1N4148 diodes easily recognized as identical to the four diodes installed on the Display Board. The Zener, and Varactor diodes must be identified exactly. Here's some help:

TYPE	Body Type/Color	Cathode Band
1N4148 (8)	Glass, copper-color inside	Black
Zener (3)	Silver-gray 6.2V marked "1N 75 3A- nnn" (D6, D7) 3.9V marked "1N 74 8A- nnn" (D17)	Grayish black
BA479 (2)	Glass	Black Grey

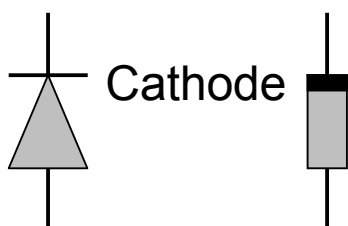

Table 1-D

TRANSISTORS

This Receiver uses FIVE transistor types for many different circuit functions. We use only well-marked factory-fresh transistors, so just make sure you pick the correct one specified by each assembly step.

2N4124 (NPN)
2N5087 (PNP)
 also:
MPSA14 (Q19)



J310
JFET
(Q2,Q3,Q7,
Q20,Q21,Q27)

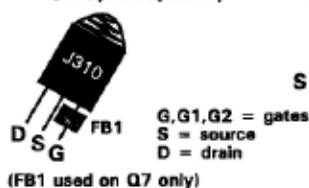

BF988
MosFET
(Q4)

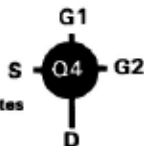

Table 1-E

CERAMIC DISC CAPACITORS

The vast majority of capacitors in this circuit are the ceramic disc type. Our protocol is to identify those in picofarads up to 99 pF simply as 1 pF or 33 pF, etc. There may be one letter to identify temperature characteristics (e.g. 33J = 33 pF.) From 100 pF (marked 101) on up to capacitors in the μF range, we provide the exact part marking (101, 102, 103, 151, 181, etc.) minus any letter. **All disc capacitors are specified to fit the exact lead spacing on the board: if a capacitor seems too big or too little for the spacing, you have selected the wrong part!**

Table 1-F

MYLAR FILM CAPACITORS

These capacitors have shiny, thick, rectangular bodies with value markings just like on the ceramic disc capacitors. In this kit design, the mylar film parts (used in the PLL filter and RF bandpass filter) have values different from any of the disc capacitors, with the sole exception of C11, .01 μF .

Table 1-G

ELECTROLYTIC CAPACITORS

These cylinder shaped parts are easy to recognize from their longer (+) leads and clearly marked wide negative band. In this kit, just be sure to identify an install correctly those smallest 1 μF and 10 μF capacitors as specified in the directions.

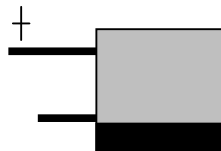
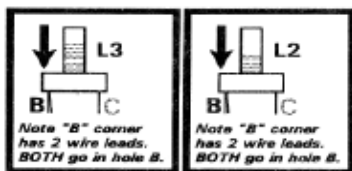

Table 1-H

“SPECIAL” PARTS

“Special” parts include crystals, filters, balun transformers which are identified clearly by a manufacturer's number on the part itself OR by detailed description in a kit assembly step. We give you plenty of help in the assembly instructions for identifying and installing these parts correctly.



*The VCO coils (Phase 3.0) are wound on WHITE forms easily identified:
L3 (VCO-1): BROWN paint dot
L2 (VCO-2): RED paint dot*

G. Building Electronic Kit Projects: THE ESSENTIALS

If you've never built an electronics kit before, you are a GOOD candidate for successful construction of this receiver - because we think you'll rely on this instruction manual very diligently. ("Experienced" builders tend to be more inclined to shortcuts which can lead to mistakes!)

Both this manual and the engineering discipline for this receiver were done with YOU very much in mind. We won't insult you by claiming that "anybody" can build this receiver: you'll certainly need the knowledge and skills you gained by working for your ham license or studying electronics theory, and you'll want to allow for a little more assembly time than may be needed by those with more building experience"

Aside from the willingness to follow the directions in this manual, the main skill you need is that of soldering. Here, it's a very good idea to get some practice before working on the receiver circuit boards. Building some simpler T-KIT projects is, of course, a great way to get into kit building. Another way is to take a circuit board from any discarded radio or other electronics device and then remove a number of parts by melting their solder connections. Re-install some or all of the parts, doing so until your solder connections look as clean and professional as the factory work. Don't hesitate to ask an electronics repair technician to critique your work or show you a few tips.



Kit-Building Tips . . .

1 . Please USE the bits of knowledge and wisdom capsulized on the back cover of your T-KIT Instruction Manual! You'll find resistor color-codes, soldering tips and more!

2. **Unfamiliar Words:** We try to use plain language throughout this manual, but electronics does have its special terms and abbreviations. A "glossary" useful to this receiver project is printed in the REFERENCE SECTION (Part 3) of this manual.

3. **SOLDERING:** If you are inexperienced, ask any electronics technician to show you how it's done, then do practice soldering/de-soldering on a junked circuit board before working on your kit. Here's what is important:

- ✓ Keep the soldering iron tip CLEAN, using a damp sponge
- ✓ Let the heated connection itself melt the solder, not the iron tip
- ✓ Use a thin diameter of rosin-core solder
- ✓ Use VERY good lighting; NEVER be embarrassed to use a magnifier!

WORTH REPEATING

Let the heated connection itself melt the solder, NOT the iron tip!

4. **DE-SOLDERING** is the opposite of soldering and is a more tedious procedure. Again, a repair technician can show you the best technique. Take care not to damage circuit board pads or traces - save yourself from desoldering agony by installing the right part the right way the first time!

5. Except for P1 , P2 and J5 mounted on the bottom ("solder side") of the board, **ALL Main Board parts are inserted into the top silkscreened side**, with leads passing through the holes to the bottom solder side. (This advice may seem insulting, but some folks DO carefully mount and solder all parts on the copper side of the board and wonder why the kit won't work!)

6. **Insert all parts as close to the board surface as possible** before soldering and trimming. Excess wire length above the board can cause unwanted oscillations.

7. **Reminder about your Kit Manual:** NEVER "Solder first and ask questions later" ! The Success of your project depends on your willingness to study our published directions attentively. Check your kit package for any update sheet(s) to supplement this manual. **Use the double □ □ check blocks** to review your work (ideally with someone else) before connecting voltage.

8. **TOOLS:** Page 14 lists the "minimum" tools needed for this particular project. However, you'll appreciate owning a more varied collection of small tools for electronics work: the selection at Radio Shack™ is good, with the lower-priced versions being quite sufficient. If buying your first voltmeter ("multitester"), you may find the "analog" meter type easier to use at first than the digital type.

H. Model 1254 SWL Receiver Kit Assembly OVERVIEW

- ✓ **You will build the Display Board first** and then occasionally plug it into the Main Board for further testing. To get a good fit of the LED's and 3-digit displays, you'll be handling the front panel and display lens - be VERY careful not to touch these with your soldering iron!
- ✓ **After finishing PHASE 2.0 (Logic and DC Power Input sections)**, the powered-up Display Board plugged to the Main Board (via P1, P2) can now simulate all receiver functions or features described in the Operating Instructions in the Reference section, though not executing them.
- ✓ **Finishing PHASE 3.0** requires VCO coil adjustments done with a simple voltmeter measurement at "VCO TP." Individual board drawings are provided as a help for correct assembly of the two shielded VCO sections.
- ✓ **Completing Phase 4.0** lets you verify that the audio amplifier, product detector and Second IF amplifier work properly. This Phase also includes the AGC and uses the largest number of parts of any of the assembly sections.
- ✓ **Phase 5.0:** Finishing this section results in a non-tuneable receiver with full sensitivity capable of receiving a **45 MHz** test signal, with the Clarifier control operational. Mixing the **45 MHz** 1st output with the **44.545** 2nd LO produces the **455 kHz** signal detected and amplified in the Phase 4.0 circuitry. The receiver is designed to generate its own **45 MHz** test signal.
- ✓ **Phases 6.0 and 7.0: (RF Input and First Mixer sections, Final Assembly):** You're **ALMOST ready to start using your receiver, so don't rush these building phases!** This work brings in the antenna signals through the shielded Bandpass Filter circuitry to the First Mixer (also shielded), where received signals are mixed with the tuneable **45-75 MHz** LO signal from the VCO's. This mixing results in a **45 MHz** 1st IF signal fed to the input of the circuitry you built in **Phase 5.0**. Very simple alignment is done in Phase 7.0 with the receiver mostly assembled. The result is a frequency-synthesized dual-conversion receiver rivaling radio sets costing much more.



See following foldout page for details on the major mechanical parts used to finish your receiver in Phase 7.0.

Model 1254 Receiver Kit Assembly Steps and Illustrations

Installing parts on the boards	2
Preview of Display Board Assembly	3
<input type="checkbox"/> Phase 1.0: Display Board Assembly	
<input type="checkbox"/> Sectional Schematic	4
<input type="checkbox"/> Parts Quick-Reference and Display Board Pictorial	5
<input type="checkbox"/> Step-by-Step Assembly	6-10
<input type="checkbox"/>	
Notes on Main Board Assembly	11-12
Phase 2.0: Logic Section and Display Drivers	
<input type="checkbox"/> Sectional Schematic and Circuit Board Pictorial	14-15
<input type="checkbox"/> Quick-Reference Parts List	16
<input type="checkbox"/> Step-by-Step Assembly	17-20
<input type="checkbox"/> <i>Note on Circuit Function Demonstrations</i>	21-22
<input type="checkbox"/> Phase 2.0 Progress Test	23-24
Phase 3.0: VCO's and PLL ("Phase-Locked Loop")	
<input type="checkbox"/> Sectional Schematic and Circuit Board Pictorial	26-27
<input type="checkbox"/> Quick-Reference Parts List	28-29
<input type="checkbox"/> Step-by-Step Assembly	30-33
<input type="checkbox"/> Phase 3.0 Progress Test:	34-35
Phase 4.0: Receiver Audio, AM and Product Detectors, 455 kHz IF Amplifier, AGC circuit	
<input type="checkbox"/> Sectional Schematic and Circuit Board Pictorial	36-37
<input type="checkbox"/> Quick-Reference Parts List	38-39
<input type="checkbox"/> Step-by-Step Assembly	40-45
<input type="checkbox"/> Progress Tests: Audio, p. 41, IF amplifier, p. 45-46	
Phase 5.0: 2nd Mixer, 2nd LO, Clarifier control	
<input type="checkbox"/> Sectional Schematic and Circuit Board Pictorial	48-49
<input type="checkbox"/> Quick-Reference Parts List	50
<input type="checkbox"/> Step-by-Step Assembly	51-53
<input type="checkbox"/> Progress Test:	54-55
Phase 6.0: RF Input, 1st Mixer, 1st LO amplifier	
<input type="checkbox"/> Sectional Schematic	56
<input type="checkbox"/> Quick-Reference Parts List	57
<input type="checkbox"/> Bandpass filter pictorial and assembly steps	58-59
<input type="checkbox"/> First mixer pictorial and assembly steps	60-61
<input type="checkbox"/> Installation of remaining parts	62-63
Phase 7.0: Final Assembly and Alignment	64-72
Model 1254 Receiver Alignment	68-69

Before you do ANY soldering, we remind you again to do the following:

- Check and organize your kit parts in whatever way is most convenient for you. A special IDENTIFICATION GUIDE is provided after the Parts List.
- Go through this entire manual: familiarize yourself with its organization and illustrations.
- Prepare a clean, well-lighted workspace.
- Study the **ASSEMBLY OVERVIEW** (Getting Started Section, Page 20)
- Build the Display Board FIRST. All its parts are packed with the board itself, and it is a good orientation project.

Installing Parts on the Circuit Boards:

When we say "**INSTALL**" a part, this is what we mean:

- Choose correct part value
- Insert in correct PC Board location
- Insert correctly, if there is a right way and wrong way such as for diodes, IC's, electrolytic capacitors, transistors etc.
- Insert the part as far as it can go into the board.
- Solder all wires or pins
- Trim or "nip" excess wire lengths

USE ROSIN-CORE SOLDER ONLY.
of a type intended for electronic PC-board assembly.
(Available at electronics distributors or Radio Shack" stores.)
DO NOT use hardware store solder, paste or flux,
Solder contains LEAD: wash hands before eating!

Model 1254 SWL Receiver
PREVIEW of
Phase 1.0 Display Board Assembly

- ✓ The Display Board is a useful "warmup" project before getting started on the more complex Main Board. It will be plugged in temporarily for Progress Tests in Phases 2.0 through 5.0 and installed permanently at the end of Phase 6.0.
- ✓ To help you make a good beginning, this Preview and Phase 1.0 assembly directions provide a bit more detail than will be needed for most Main Board assembly steps. This board appears simple, using only a handful of parts. However, correct construction is vital to the success of this kit project and the reliability of your Model 1254 Receiver.
- ✓ All parts used for the Display Board are packed together with the board itself . Except for the common 1N4148 diode, all parts in the Display Board kit are unique to this assembly phase, even the resistors! (The display board uses 1/8 watt resistors, while all other resistors are 1/4 watt.)

KIT PARTS REQUIRED for Phase 1.0:

- Display Board Parts Kit
- Model 1254 Front Panel
- Model 1254 Front Panel Display Lens

PROCEDURES REQUIRED:



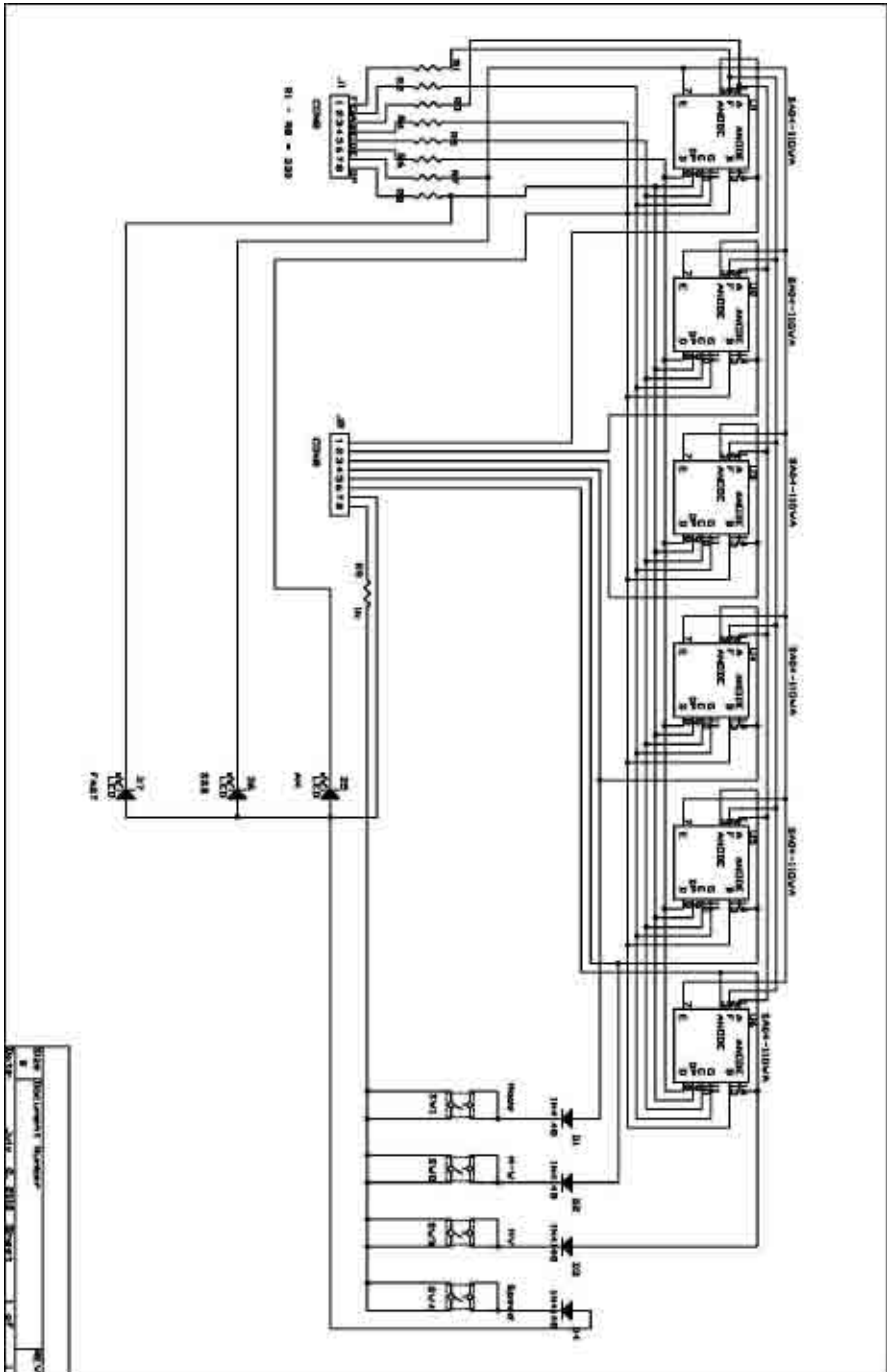





















- Installing all Display Board parts, with special attention to
- directions for Display LED's U1-U6, LED's (D5-D6) and J1 , J2
- Wiring and mounting of the ENCODER
- Wiring and mounting of the DC Power Switch



1254 – Assembly – 4

QUICK REFERENCE SUMMARY

PHASE 1.0: Display Board

	EN1	Encoder	Freq/Memory TUNE
	D1	1N4148	pushbutton switch multiplexing diode
	D2	1N4148	"
	D3	1N4148	"
	D4	1N4148	"
	D5	Green LED	AM mode indicator
	D6	Green LED	SSB mode indicator
	U1-U6	Display LED	frequency display
	R1	33 ohm, 1/4watt	LED display current limiting
	R2	33 ohm, 1/4 watt	"
	R3	33 ohm, 1/4 watt	"
	R4	33 ohm, 1/4 watt	"
	R5	33 ohm, 1/4 watt	"
	R6	33 ohm, 1/4 watt	"
	R7	33 ohm, 1/4 watt	"
	R8	33 ohm, 1/4 watt	"
	R9	1K, 1/4 watt	multiplexing resistor
	SW1	momentary	MODE
	SW2	"	MW
	SW3	"	V/M
	SW4	"	Tuning SPEED
	S1	SPDT Toggle	DC power
	J1	8-pin socket	mates P1 on main board
	J2	8-pin socket	mates P2 on main board

Phase 1.0: Display Board

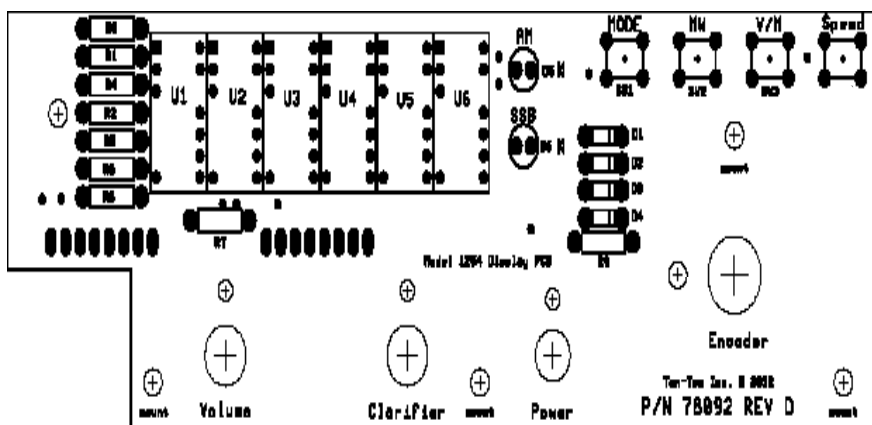

PHASE 1.0

Display Board Assembly

All parts used for the Display Board are packed together with the board itself . Except for the common 1N4148 diode, all parts in the Display Board kit bag are unique to this assembly phase, even the resistors! (The display board uses 1/8 watt resistors, while all other resistors are 1/4 watt.)

All parts except J1 and J2 are mounted on what we will refer to as the FRONT or silkscreened side of the display board, with soldering done on the back side. J1 and J2 are mounted on the back, soldered on the front.

INSTALLING U1-U6 DISPLAY LED MODULES:

☐☐ 1-1. The pin arrangements of U1-U6 permit only one possible orientation on the board. Insert **U1** in its board position, making very sure all four support legs are squarely seated on the board. Solder ONE pin in each row. Before further soldering, CHECK carefully to make sure the display is squarely against the board. If necessary, reheat and adjust the two connections. Because of the length of the pins, you will probably find it easiest to nip excess length after soldering each pin, to provide clearance to solder the next connection. Solder and nip all pins of U1.

☐ ☐ 1-2. Install **U2-U6** exactly as explained in 1-1 for U1.

CAUTION: To install the LED indicators, you will be working with the receiver's front panel to get a good fit. Be VERY careful with your soldering iron tip during these processes so as not to scar (melt) the front panel!

☐ ☐ 1-3a. **Preparation to install LED's:**

Lay the receiver's molded front panel face down on a clean, non-abrasive surface. (A dry wash cloth works nicely, or use the packing foam from your kit.)

❑ ❑ 1-3b. Examine one of the small LEDs and the LED outlines illustrated in Figure 1.1 **Notice that the anode and cathode ends of the LED's are clearly silkscreened on the board. The anode is the LONGER of the two LED leads.**

Figure 1.1

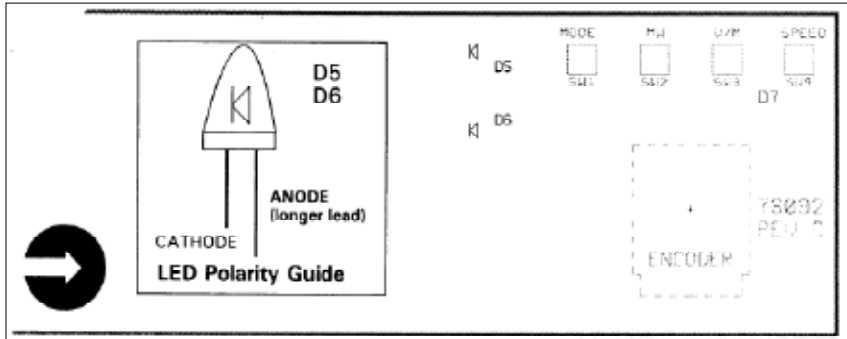

❑ ❑ 1-4. **LED Installation Procedure.** First, insert all 3 LED's with correct anode orientation per Step 1-3 and Fig. 1.1. Don't push them in very far, because they need to extend into the front panel for a good fit.

Seat the plastic lens for the 6-digit display in its panel position and then lay the display board into the panel. (Remove the protective paper from the lens.) While holding the board and panel face down, slide all 3 LED's into their panel positions as far as they can go. Solder ONE side of each LED and check front panel for a good fit. Resolder any LED which needs adjusting and then solder all remaining wires. **Before trimming**, check to make sure that all the longer anode leads are oriented in the same direction per Fig. 1.1.

❑ ❑ 1-5. Green LED D5 installed per Steps 1-3 and 1-4.

❑ ❑ 1-6. Green LED D6 installed per Steps 1-3 and 1-4.

❑ ❑ 1-8. **Set aside the front panel and display lens carefully so they will not be scratched.**

INSTALLING SOCKETS J1 and J2:

❑ ❑ 1-9. Read First: Sockets J1 and J2 are inserted on the back (non-screened) side of the display board and soldered on the front. It is important that the edges of J1 and J2 be squarely against the rear of the board to ensure a good fit to the right-angle pin plugs on the main board.

Figure 1.2



IMPORTANT: Examine these sockets and notice the row of openings and tiny metal tabs on one side. These tabs will protrude when the sockets are mated to plugs. Therefore install the sockets with the tab rows facing UP, so there is no chance that extended spring tabs can short against the main board.

- ❑ ❑ 1-10. Insert socket J1 and solder the two end pins. Check for squareness and resolder if necessary. Then solder the remaining 6 pins; no trimming is required.
- ❑ ❑ 1-11. Install socket J2 exactly as explained in steps 1-9,10.

Install the following 1/8 watt resistors:

- ❑ ❑ 1-12. Resistor **R1, 33 ohm** (orange-orange-black).
- ❑ ❑ 1-13. Resistor **R2, also 33 ohm**.
- ❑ ❑ 1-14. Resistor **R3, also 33 ohm**.
- ❑ ❑ 1-15. Resistor **R4, also 33 ohm**.
- ❑ ❑ 1-16. Resistor **R5, also 33 ohm**.
- ❑ ❑ 1-17. Resistor **R6, also 33 ohm**.
- ❑ ❑ 1-18. Resistor **R7, also 33 ohm**.
- ❑ ❑ 1-19. Resistor **R8, also 33 ohm**.
- ❑ ❑ 1-20. Resistor **R9, 1K (brown-black-red)**.

Install the following diodes, type 1N4148, making sure to position the banded ends (cathodes) as outlined on the board:

- ❑ ❑ 1-21. Diode **D1, type 1N4148**.
- ❑ ❑ 1-22. Diode **D2, type 1N4148**.
- ❑ ❑ 1-23. Diode **D3, type 1N4148**.
- ❑ ❑ 1-24. Diode **D4, type 1N4148**.
- ❑ ❑ 1-25. The four push-button switches snap into place neatly, but insert them carefully so as not to crumple any of the mounting legs. Each switch must rest flush against the surface of the board. Solder all four pins for each switch.

- ❑ 1-26. Install switch **SW1** (MODE) per Step 1-25.
- ❑ 1-27. Install switch **SW2** (MW) per Step 1-25.
- ❑ 1-28. Install switch **SW3** (V/M) per Step 1 -25.
- ❑ 1-29. Install switch **SW4** (SPEED) per Step 1-25.

❑ **IMPORTANT SOLDERING TIP!** Examine the Rotary Encoder: regardless of whether the 3 silver terminals appear to you to be tarnished, rub them anyway with a clean pencil eraser. This will make for much easier soldering.

Figure 1.3. Encoder cable connections

❑ 1-30. Strip 1/8" of insulation from each of the 3 wires of the cable/plug assembly.

❑ 1-31. Study the A-B markings on the encoder and compare to Figure 1.3.

❑ 1-32. The 3 wires should be inserted from the back and soldered on the front side. Insert the red wire and the white A and gray B wires EXACTLY how Figure 1.3 depicts the front of the encoder and design of the plug.

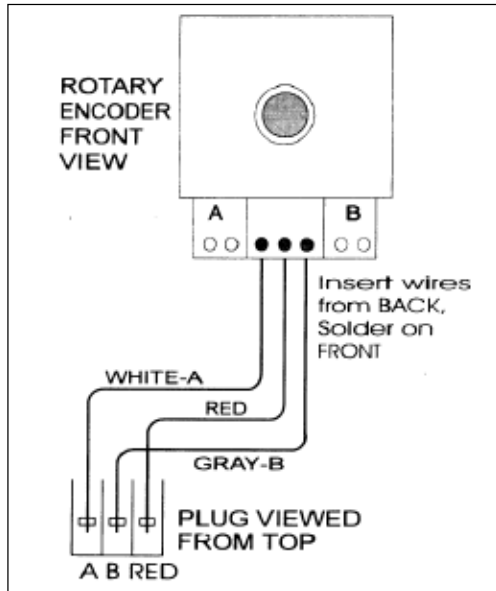

❑ 1-33. Mount the rotary encoder to the display board with the lock washer and nut provided. The washer goes on the front side of the board. (If you wish, the large tuning knob may be mounted temporarily to the encoder shaft for easy tuning during progress tests).

❑ 1-34. Mount the SPDT power switch on the display board. Both the tabbed "alignment" washer and the lock washer should be on the FRONT side of the display board. Be sure to get this switch mounting and wiring done correctly, because you will be instructed in Phase 5.0 to cut off the un-used switch lug.

❑ 1-35. Strip 1/8" insulation from the ends of both red wires of the pre-assembled power switch cable.

☐ ☐ 1-36. Cut two 1/2" lengths of insulating sleeve and slip one on each of the two switch wires.

☐ ☐ 1-37. Solder one wire to the center lug of the SPDT switch.

☐ ☐ 1-38. Solder the other red wire to the bottom switch lug. The bottom lug is identified per mounting done in step 1-34.

☐ ☐ 1-39. Slide the insulating sleeves over the completed switch connections.

☐ ☐ 1-40. Double-check all your work and set the display board aside until it is needed for various tests. It will be mounted permanently after completion of the work in Phase 6.0. Do not attempt to mount the front panel to the display board until instructed to do so in Phase 7.0.

Model 1254 Main Circuit Board Assembly

In discussing the Display Board, we referred to the "front" and "back" sides of the board. In the Main Board assembly steps, we will refer to the silkscreened side as the TOP and the solder side as the BOTTOM. However, when the display board is plugged in and facing you correctly, the component or top side of the main board actually faces downward!

VERY IMPORTANT: Take the time to study the board itself and all board drawings in this manual. Some silkscreened component outlines or identifications may be obscured by the space required for the plated-through pads. Therefore, you must consult the circuit board outline drawings printed in this manual.

NEVER GUESS about the identification or orientation of a part if it is not absolutely clear on the board silkscreen.

Conventions used in this Instruction Manual

Our primary goal is accuracy of parts selection and correct installation, NOT the fastest possible "stuffing" of the board. That's why a numbered instruction is provided for each part, and why we follow a specific pattern for listing instruction sequences for similar groups of parts such as resistors or disc capacitors.

● Groups of similar parts:

Our assembly lists of similar parts begin with the lowest value of resistance or capacitance, etc., and go up in value, grouping identical values together, starting with the lowest designator number. For example:

Install the following 1/4-watt resistors:

- 2-1. Resistor **R1, 4.7 ohm** (yellow-violet-gold).
- 2-2. Resistor **R10, 470 ohm** (yellow-violet-brown).
- 2-3. Resistor **R4, 10K**, (brown-black-orange).
- 2-5. Resistor **R9, also 10K**.

- 2-8. Resistor **R5, 47K** (yellow-violet-orange).
- 2-9. Resistor **R6, also 47K**.
- 2-10. Resistor **R2, 10 megohm** (brown-black-blue).

● **About the Circuit Board Drawings:**

The sectional circuit board drawings are adapted directly from the silk-screening on the board itself, but they have been modified in two important ways:

1. Component "designators" (C1, R1, Q1, etc.) are consistently within the outline of the part for maximum convenience in identifying a part's real location. On the board itself, many such designators are off to the side, for two reasons. First, screening over plated holes is not good manufacturing practice. Second, it helps to see some clear designators AFTER parts-installation is finished.
2. USEFUL NOTES AND SKETCHES have been added to the sectional board drawings. As needed, we refer to these in the Assembly Instructions.

● **The Quick-Reference Summaries**

A **Quick Reference Summary** of the parts used in each Assembly Phase is printed at the beginning of the instructions for that phase. It may be used first as a guide to gathering parts for this phase. It is provided as an extra help in double-checking correctness of parts values with brief notes on the function of each part. These summaries are adapted from the complete Component **Reference Index** in the Reference Section of this manual.

● **Main Board Soldering Hints**

In addition to all our nagging about avoiding solder bridges, here's a tip about working with this double-sided board with plated-through holes. Many of the solder pads are elongated with two or more holes. When soldering a part to such a multi-connection pad or connected group of pads, just be careful to use the minimum solder needed for a good connection, because it is VERY easy for excess solder to flow into an empty hole. Such extra solder must be "de-soldered" before using that mounting hole.

We discourage those "I know best" marathons in which "board-stuffing" for this whole receiver might be done in a long evening. BUT we do NOT expect you to insert, solder and trim just one part at a time. We suggest inserting 3-5 parts, bending the leads to hold them well, double-check, then solder and trim. In choosing the kit-building experience, we are not trying to outpace the robotic manufacturing processes used at TEN-TEC and worldwide!

● This space is for your notes

**Phase 2.0 Assembly
begins on page 14 ►**

Phase 2.0 Schematic Diagram Details

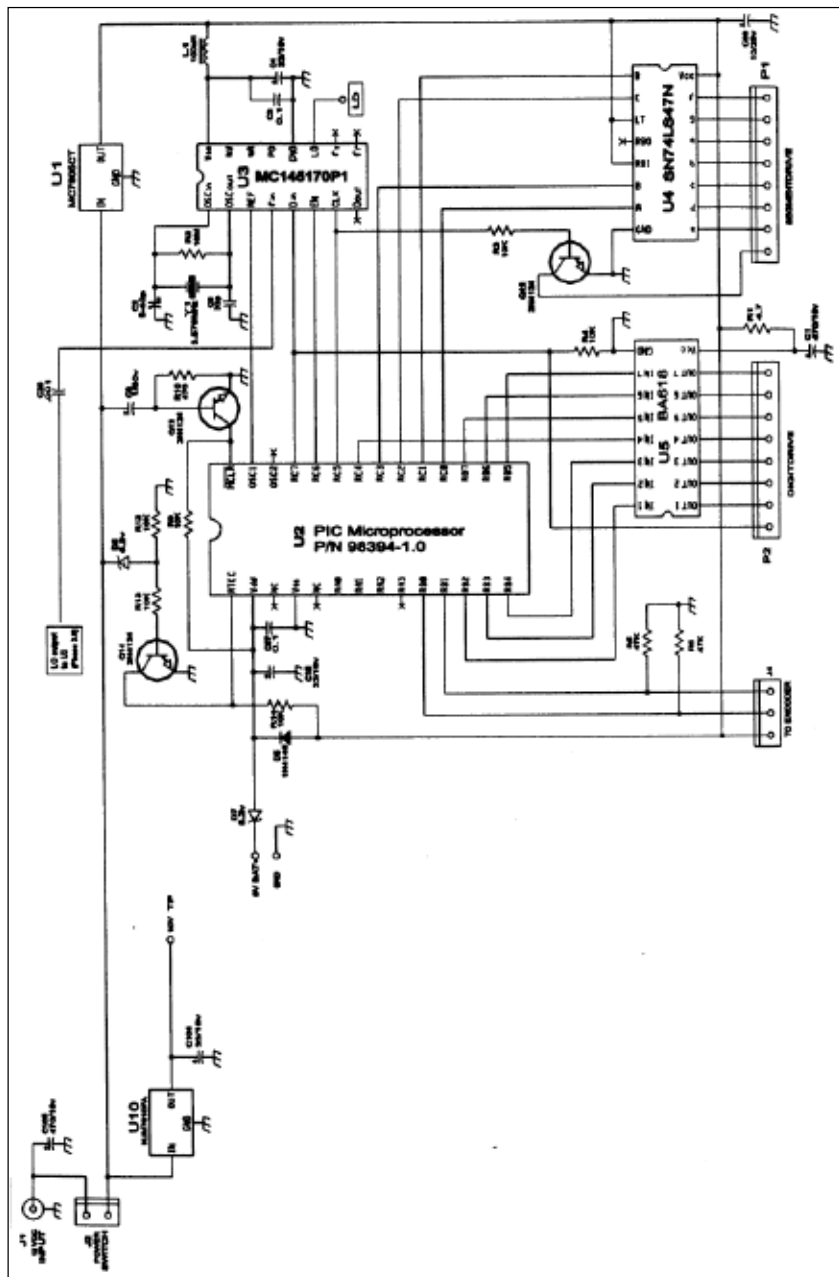

Phase 2.0

Display Driver, Microprocessor and DC Power Input Circuits

PLL synthesizer IC U3 and some of its supporting parts are included, in this phase because its 3.580 MHz reference oscillator also supplies the microprocessor clock signal.

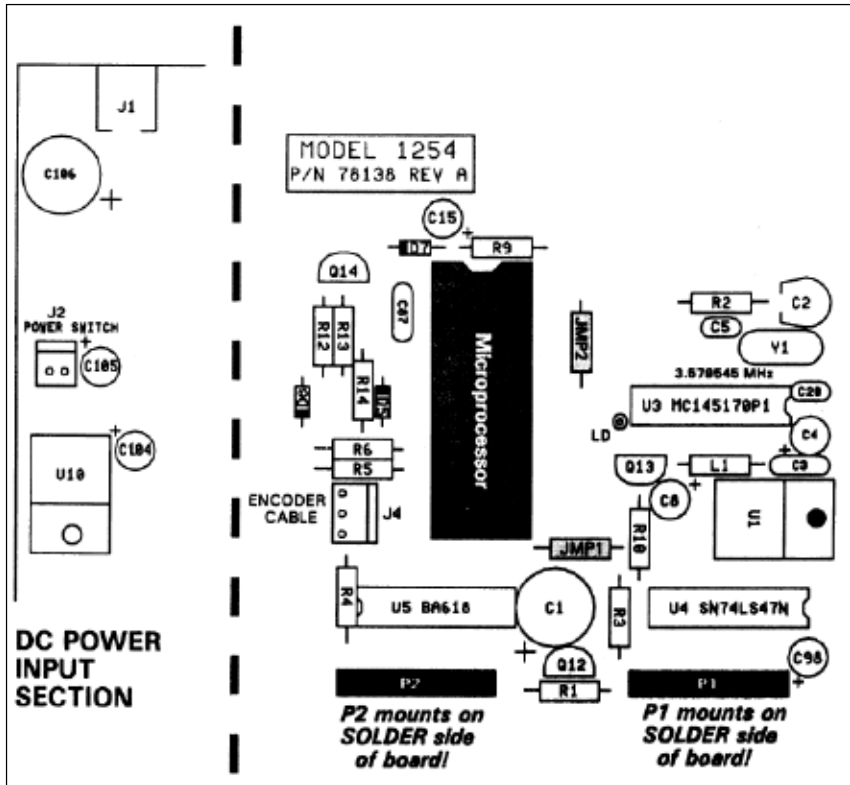

QUICK REFERENCE SUMMARY

Phase 2.0: Frequency Synthesizer and DC Input

<input type="checkbox"/>	C1	470/16v el.	Filter Cap for display driver
<input type="checkbox"/>	C2	5-40 pF var.	Trimcap for master clock (adjust to 3.58 MHz)
<input type="checkbox"/>	C3	0.1µF	Bypass on PLL chip
<input type="checkbox"/>	C4	33/16v el.	Bypass on PLL chip
<input type="checkbox"/>	C5	33pF	Shunt cap on clock crystal
<input type="checkbox"/>	C8	1/50v el.	Reset coupling cap
<input type="checkbox"/>	C15	33/16v el.	Vdd supply bypass for µP
<input type="checkbox"/>	C20	.001µF	Couples PLL to VCO circuits
<input type="checkbox"/>	C87	.01µF	Supply bypass for U2
<input type="checkbox"/>	C98	10/25v el.	Supply bypass on U4
<input type="checkbox"/>	C104	33/16v el.	Bypass on output of U10
<input type="checkbox"/>	C105	33/16v el.	Bypass on input of U10
<input type="checkbox"/>	C106	470µf/16v el.	Main DC input bypass
<input type="checkbox"/>	D5	1N4148	Supply summing diode for U2
<input type="checkbox"/>	D6	6.2V zener	Supply turn-off detector
<input type="checkbox"/>	D7	6.2V zener	Backup battery summing diode
<input type="checkbox"/>	J1	DC jack	Coaxial DC power connection
<input type="checkbox"/>	J2	2-pin	DC power switch connection
<input type="checkbox"/>	J4	3-pin	Encoder cable connection
<input type="checkbox"/>	L1	100 µH	RFC for U3 DC supply
<input type="checkbox"/>	P1	8-pin header	Mates Display Board J1 (install on solder side!)
<input type="checkbox"/>	P2	8-pin header	Mates Display Board J2 (install on solder side!)
<input type="checkbox"/>	Q12	2N4124	Decimal point current sink
<input type="checkbox"/>	Q13	2N4124	Power-on reset transistor
<input type="checkbox"/>	Q14	2N4124	Power-down detector
<input type="checkbox"/>	R1	4.7 ohms	Supply lead to U5
<input type="checkbox"/>	R2	10 megohm	Clock oscillator for U3
<input type="checkbox"/>	R3	10K	Display decimal point
<input type="checkbox"/>	R4	10K	Pull-down for pushbuttons
<input type="checkbox"/>	R5	47K	Pull-down for encoder
<input type="checkbox"/>	R6	47K	" "
<input type="checkbox"/>	R9	10K	Pull-up for reset pin
<input type="checkbox"/>	R10	470	Pull-down for Q13
<input type="checkbox"/>	R12	10K	Power-off detector
<input type="checkbox"/>	R13	10K	Power-off detector
<input type="checkbox"/>	R14	10K	Pull-up on RTCC pin
<input type="checkbox"/>	U1	MC7805CT (U1 also may be LM340T-5)	5V regulator for synthesizer circuitry
<input type="checkbox"/>	U2	PIC16C57	8-bit microprocessor (P/N 98384)
<input type="checkbox"/>	(U2)	28-pin DIP socket for U2 Microprocessor	
<input type="checkbox"/>	U3	MC145170P	PLL synthesizer
<input type="checkbox"/>	U4	SN74LS47N	LED segment driver
<input type="checkbox"/>	U5	BA618	Digit driver
<input type="checkbox"/>	U10	NJM7810A	10V voltage regulator
<input type="checkbox"/>	Y1	3.579546 MHz	Synthesizer clock set to 3.58 MHz (use base insulator)
<input type="checkbox"/>	JMP1	"zero ohm resistor" (black band)	
<input type="checkbox"/>	JMP2	"zero ohm resistor" (black band)	

Phase 2.0 Assembly Steps

Before You Start: A *Quick Reference Summary* of the parts used in Phase 2.0 is printed on page 16. It may be used first as a guide to gathering parts for this phase. It is provided as an extra help in double-checking correctness of parts values with brief notes on the function of each part.

CAUTION!

Do NOT attempt to install P1 and P2 until instructed to do so and you understand the directions thoroughly.

Install the following $\frac{1}{4}$ -watt resistors:

- 2-1. Resistor **R1, 4.7 ohm** (yellow-violet-*gold*)
- 2-2. Resistor **R10, 470 ohm** (yellow-violet-*brown*)
- 2-3. Resistor **R3, 10K** (brown-black-orange)
- 2-4. Resistor **R4, also 10K.**
- 2-5. Resistor **R9, also 10K.**
- 2-6. Resistor **R12, also 10K.**
- 2-7. Resistor **R13, also 10K.**
- 2-8. Resistor **R14, also 10K.**
- 2-9. Resistor **R5, 47K** (yellow-violet-orange).
- 2-10a. Resistor **R6, also 47K.**
- 2-10b. Resistor **R2, 10 megohm** (brown-black-blue).

- 2-11. Install *electrolytic capacitor C98, 10 μ F*, being sure to insert the longer (+) lead as shown on the board.

- 2-12. **READ FIRST :** When installing the right-angle headers (P1 and P2), it is important that they sit squarely against the board for a good fit to the display board. **VERY IMPORTANT: P1 and P2 are MOUNTED on the BOTTOM side of the board as illustrated below and should be soldered from the top side.**

Installing P1 at this time presumes that R3 and C98 are already installed, making the holes used for P1 perfectly clear when viewed from the bottom side of the board.

Fig. 2.1: Installation of P1 and P2 on solder side of board



- □ 2-13. Install right-angle header **P1** per Step 2-12.
- □ 2-14. Install right-angle header **P2** per Step 2-12.
- □ 2-15. Install the 28-pin DIP socket supplied for the U2 PIC microprocessor, with the notched end aligned per the notch outlined on the board. Insert carefully, making sure all pins mate their holes with no pin bent back under the socket. Use good lighting and a clean solder tip to avoid making solder bridges.
Do NOT insert U2 until instructed to do so.

□ □ 2-16. Install **U4, type 74LS47N**, making sure that its notched or dotted end is oriented toward the right-side edge of the board as designated by the notch outlined on the board.

□ □ 2-17. Install **U5, type BA618**, making sure that its notched or dotted end is oriented as outlined on the board.

□ □ 2-18. Install **U3, type MC145170P1**, making sure that its notched or dotted end is oriented as outlined on the board. Solder U5 directly to the board; do not use a socket.

□ □ 2-19. Slide voltage regulator **U1, type 7805CT (or LM340T-5)**, into its position as far as you can push it. Then bend it back so that its heatsink and hole line up with the groundplane area and mounting hole in the board. Later, a screw will be secured through U1 to the aluminum side panel.

□ □ 2-20. Solder and trim the 3 leads of voltage regulator U1.

Install the following ceramic disc capacitors:

□ □ 2-21. Capacitor **C5, 33 pF**. (*narrow* lead spacing, NOT the 33 pF capacitors used for C21 ,C22, etc.).

□ □ 2-22. Capacitor **C20, .001 μF** (marked 102).

□ □ 2-23. Capacitor **C3, 0.1 μF** (marked 104).

□ □ 2-24. Capacitor **C87, also 0.1 μF**.

Review Table 1-C in “Getting Started” as needed before installing diodes D5, D6, and D7 in the following steps:

□ □ 2-25. Install diode D5, type 1N4148, with correct cathode polarity as outlined on the board.

□ □ 2-26. Install 6.2V zener diode D6, type 1N753A, with correct cathode polarity as outlined on the board.

□ □ 2-27. Install 6.2V zener diode D7, type 1N753A, with correct cathode polarity as outlined on the board.

- 2-28. Install **JMP1** , a "zero ohm resistor" (one black band.)
- 2-29. Install **JMP2** per step 2-28.
- 2-30. Install electrolytic capacitor **C1,470 μF** , being sure to insert the longer (+) lead as shown on the board.
- 2-31a. Install electrolytic **C4, 33 μF** per Step 2-30.
- 2-31b. Install electrolytic **C15, also 33 μF** .
- 2-32. Install electrolytic **C8, 1 μF** per Step 2-30. (Be careful not to mix up the small 1 μF and 10 μF electrolytics.)
- 2-33. Install **trimmer capacitor C2**; its flat side faces R2 as shown on the board. Insert the part gently so as not to bend its mounting terminals.
- 2-34. Slip a crystal base insulator over the leads of crystal **Y1, 3.579545 MHz**. This insulator is white or clear plastic in the shape of the crystal base.
- 2-35. Install crystal Y1, making sure you select the 3.579 MHz crystal and not Y3 to be used in the 1st IF section.
- 2-36. Install transistor **Q12, type 2N4124**, with the flat side toward R1 as outlined on the board.
- 2-37. Install transistor **Q13, type 2N4124**, with the flat side toward U3 as outlined on the board.
- 2-38. Install transistor **Q14, type 2N4124**, with the flat side oriented as outlined on the board.
- 2-39. Install the three-pin terminal **J4** with the vertical locking tab toward the socket for U2 as outlined on the board.
- 2-40. Install L1 , **100 μH RF choke** (brown-black-brown-gold).
- 2-41. Double-check all work you have done so far.
- 2-42. Remove the PIC microprocessor from its protective Foam, check all 28 pins for straightness, and straighten any pin which appears to need it. Insert U2 into its socket with the notched end toward D7 as plainly outlined on all drawings and the board silkscreen.

28. DC Power Circuitry

The following parts are installed near the left rear of the board.

□ □ 2-43. Install the two-pin terminal **J2** with the vertical locking side toward the back end of the board as outlined and illustrated in Figure 2.2.

Figure 2.2

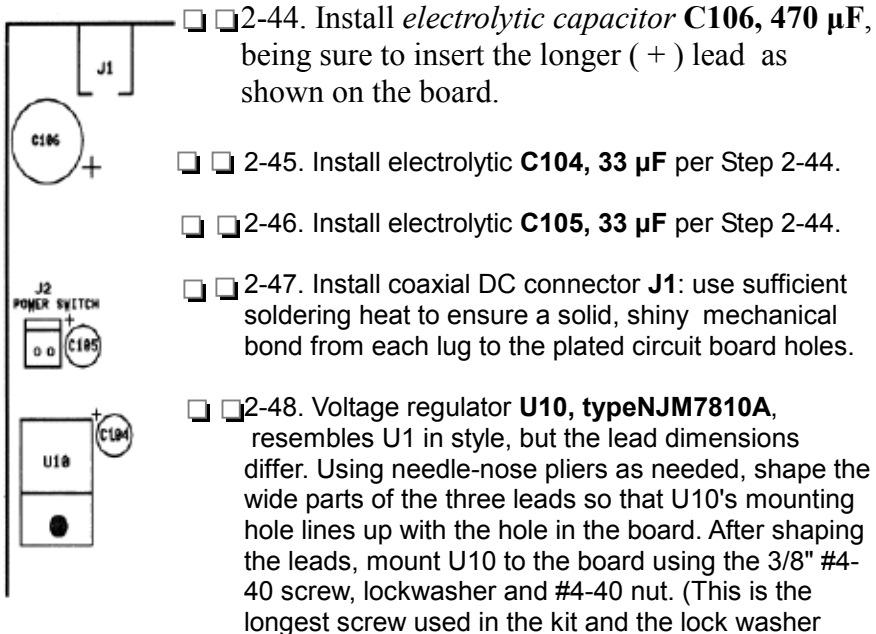

□ □ 2-49. Install the 10 volt regulator **U10** as explained in 2-48. Solder all three leads and trim away the excess lengths.

OPTIONAL: For Educators and Experimenters

Circuit Stage Demonstrations

Each Phase of the receiver construction process adds several related circuit stages. In most cases, these circuit sections are capable of "doing something" of possible interest to you if connected to external test equipment of some kind. For example, you can hear an oscillator signal using another receiver, Or use a signal generator to hear that an IF section is working.

Each Assembly Phase for your receiver kit includes "Progress Test" procedures. Our goal in such tests is to verify that the completed circuit section simply "works" as engineered. We specify the simplest possible testing to do this, such as a meter reading. From experience, we find it best not to include nonessential circuit performance demonstrations as part of kit building Progress Tests.

Setting up a useful circuit demonstration may require more external equipment than you have on hand or is really needed. The following testing suggestions are provided for those builders who enjoy observing or demonstrating what various sections of the receiver can "do." These possible demonstrations are NOT mentioned in the Progress Tests: it is up to YOU to return to this section of the manual after each Progress Test and determine whether you want to try out these suggestions.

Phase 2.0: Frequency Synthesizer

The 3.58 MHz clock oscillator may be heard using another receiver tuned to that frequency. C2 may be adjusted to exactly 3.5800 MHz using this method. The real adjustment of C2 is done with the receiver completed and tuned to WWV.

Phase 3.0: 45-75 MHz local Oscillator and PLL

The synthesized LO tunes 45 MHz above the frequency indicated on the display, i.e. 45-75 MHz. In addition to the option of checking the LO output with a frequency counter, the LO signal may be heard with any receiver capable of tuning in the 45-75 MHz range. Even an ordinary TV set can be used. simply run a jumper wire from the "FREQ TIP" to the VHF antenna input and tune the 1254 per the following table:

Display	LO Output (MHz)	NOTES
0.000.0	45.000	Test signal: 1 st IF (Phase 5.0)
0.100.0	45.100	
5.000.0	50.000	6 meter ham band (50-54 MHz)
10.250.0	55.250	TV channel 2 video
14.750.0	59.750	TV channel 2 audio
16.250.0	61.250	TV channel 3 video
21.750.0	65.750	TV channel 3 audio
22.250.0	67.250	TV channel 4 video
26.750.0	71.750	TV channel 4 audio

Phase 4.0: 455 kHz 2nd IF

An RF signal generator tuned to 455 kHz can be coupled to the input of U7 at C40 after completing Phase 4B.

A nearby general coverage HF receiver or transceiver can be tuned to 455 kHz to confirm oscillation of ceramic resonator Y2. NO adjustment on the 1254 board is required or provided for.

An RF signal generator tuned to 455 kHz can be used as a short-range "transmitter" (1 to 3 feet) after completing Phase 4C. Connect a foot or two of wire to serve as its "transmitting antenna."

Find the CENTER pad for T7 (not yet installed) in the row of 3 pads nearest J5/J6. Here, you will simply touch a test probe from your meter to serve as a "receiving antenna." It does not matter whether the test lead is connected to your meter.

With this set-up, the 1254 should easily detect the nearby 455 kHz test signal. (Coincidentally, the T-KIT Model 1050 "Universal BFO", with its tuneable 452-457 kHz output, works very nicely for such demonstrations.)

Phase 5.0: 45 MHz 1st IF

At this point the receiver can easily detect the output of an RF signal generator tuned to 45 MHz.

REMINDER: This is the ONLY discussion in this manual of what we consider to be optional circuit section demonstrations for those builders or educators who wish them. They are not needed in the Progress Tests.

Phase 2.0 Progress Test

- 2-50. Carefully plug the Display board into the sockets on the solder side of the board. With the display facing you correctly, the solder side of the main board faces up.
- 2-51. Plug the encoder cable into J4.
- 2-52. Plug the power switch cable into J2.
- 2-53. Connect the 1 SVDC power supply module to J1.
- 2-54. Turn on DC power: the display should read 15.000.0 (MHz), and only the [AM] or [SSB] LED should be lit. **If the display reads differently, perform the Microprocessor Reset (also explained in the Operating Instructions) as follows:**
 - Turn off DC power
 - Press and hold both the [Mode] and [MW] switch buttons
 - Turn on DC power
 - Release the switch buttons
- 2-55. Press the [MODE] button to select SSB mode and turn the encoder shaft or knob slightly clockwise: the display should advance to 15.002.5, 15.005.0, 15.007.5 and so forth in 2.5 kHz steps. If the displayed frequency went DOWN (i.e. to 14.997.5, etc.), this means that the A and B wires to the encoder are reversed. If this is so, turn off DC power and fix that problem before proceeding.
- 2-56. Press the [MODE] button to select AM mode; turning the encoder shaft should advance the display in 5 kHz steps, such as 15.010.0, 15.015.0, 15.020.0, etc.
- 2-57. Press the [SPEED] switch button. The "FAST" LED below it should light up, and you should observe tuning in 100 kHz steps such as 15.100.0, 15.200.0, etc. You will notice that only a few gentle turns of the tuning control shaft easily moves you several MHz in either direction.
- 2-58. Set your VOM or DVM to read DC voltage. Locate the "10V TP" test point and measure the voltage between that pad and ground. Any of the four mounting holes on the board is a convenient ground. The reading should be about 10 volts DC.

At this point, further testing of this circuitry consists simply of *just playing with it as much as You care to!* For example, you can turn to the Operating Instructions in the Reference Section and try out the **[MW]** and **[V/M]** functions.

You can use the **[MW]** (Memory Write) function to store frequencies in memory, but keep in mind that the stored information will be lost when power is turned off, because the memory backup battery is not yet in use.

DO NOT install the 9-volt memory battery snap until instructed to do so in Phase 7.0. Its wires will not withstand all the board handling yet to be done.

☐ ☐ 2-60. Unplug and set aside the front display board before beginning Phase 3.0.

This space is for your notes

Phase 3.0 Assembly
begins on page 26 ►

Phase 3.0 Schematic Details

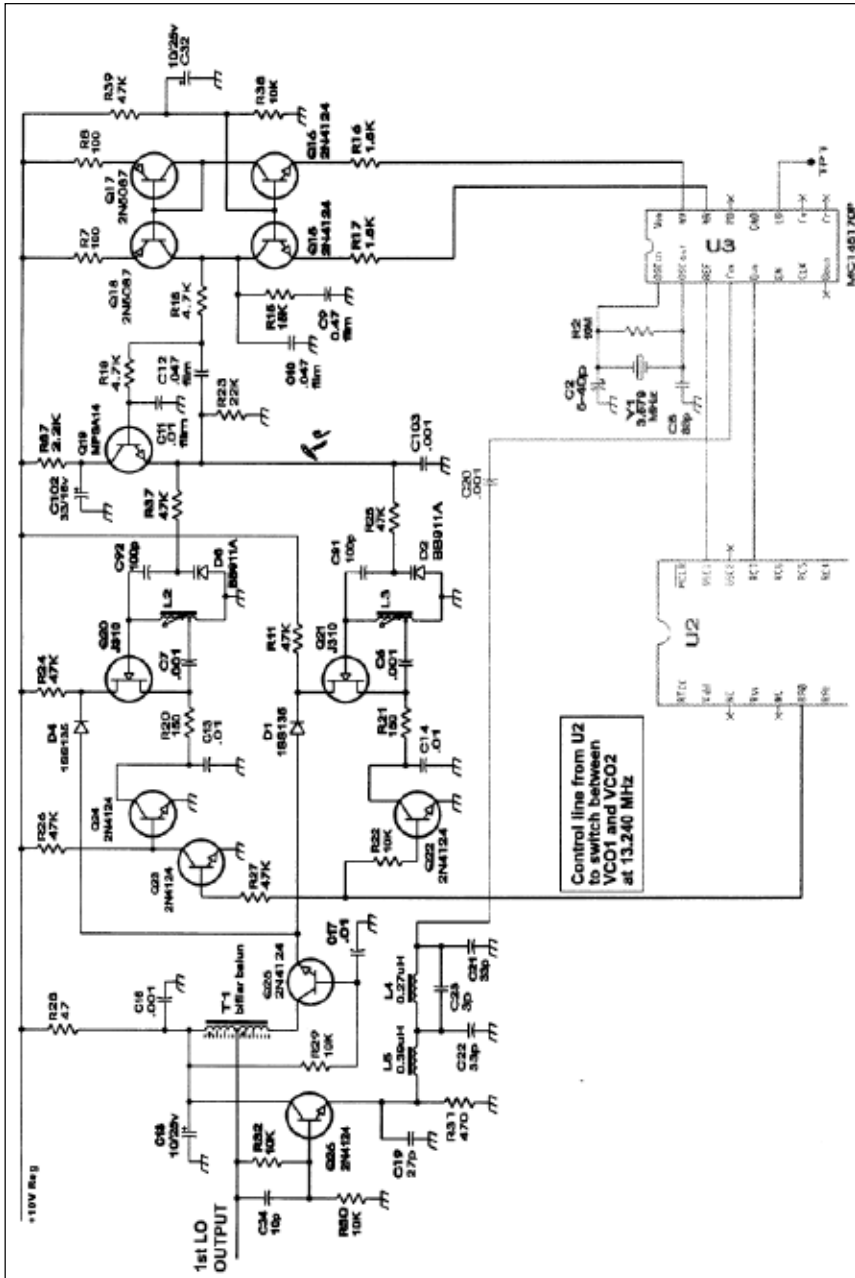

Phase 3.0 VCO's and PLL Circuit

The VCO's (Voltage Controlled Oscillators) will be permanently enclosed in metal shields only after their operation is thoroughly verified in Phase 7.0. Four different transistor types are used in Phase 3.0: be sure to identify them correctly and to orient them as outlined on the board. Consult Figures 3.1 and 3.2 carefully as you work on the VCO's, which we'll do first.

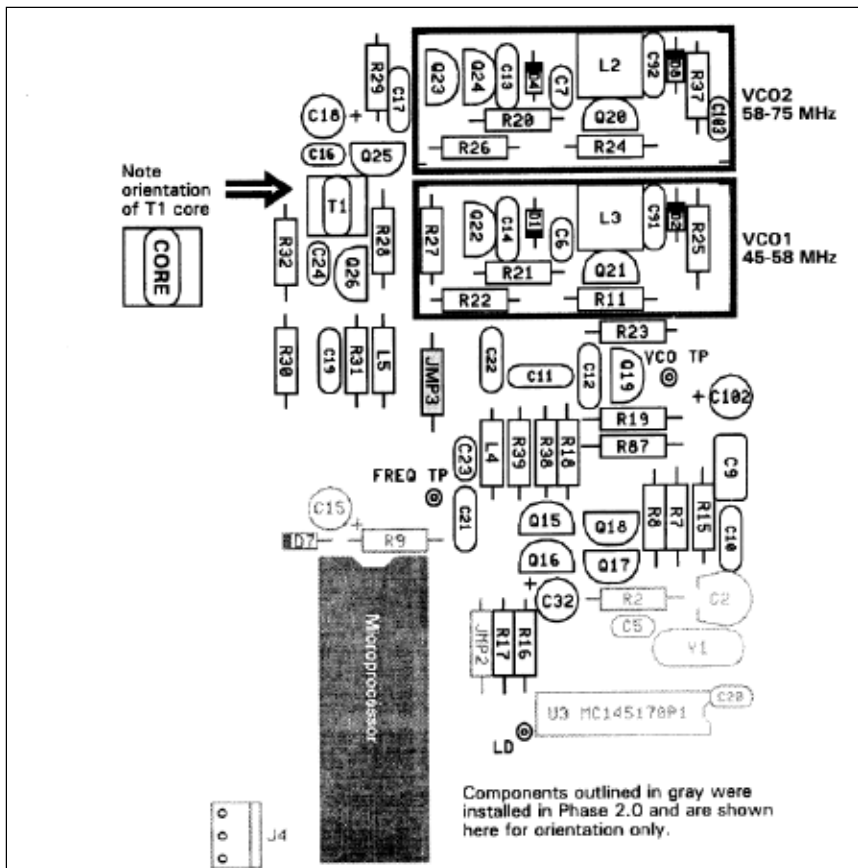

QUICK REFERENCE SUMMARY

Phase 3.0: VCO's and PLL Circuit

<input type="checkbox"/>	C6	.001 μ F	DC block on VCO
<input type="checkbox"/>	C7	.001 μ F	" " "
<input type="checkbox"/>	C9	0.47 μ F film	PLL loop filter
<input type="checkbox"/>	C10	.047 μ F film	" " "
<input type="checkbox"/>	C11	.01 μ F film	PLL active filter
<input type="checkbox"/>	C12	.047 μ F film	" " "
<input type="checkbox"/>	C13	.01 μ F	VCO bypass cap
<input type="checkbox"/>	C14	.01 μ F	" " "
<input type="checkbox"/>	C16	.001 μ F	Supply bypass for Q25
<input type="checkbox"/>	C17	.01 μ F	Base bypass for Q25
<input type="checkbox"/>	C18	10/25v el.	Supply bypass for Q25
<input type="checkbox"/>	C19	27 pF	VCO bypass filter
<input type="checkbox"/>	C20	.001 μ F	VCO coupling cap to PLL
<input type="checkbox"/>	C21	33 pF	VCO lowpass filter
<input type="checkbox"/>	C22	33 pF	VCO lowpass filter
<input type="checkbox"/>	C23	3 pF	VCO lowpass filter
<input type="checkbox"/>	C24	10 pF	Coupling cap into Q26
<input type="checkbox"/>	C32	10 μ F el.	Base bypass on charge pump
<input type="checkbox"/>	C91	100 pF	VCO varactor coupling cap
<input type="checkbox"/>	C92	100 pF	" " "
<input type="checkbox"/>	C102	33/16v el.	Collector bypass on Q19
<input type="checkbox"/>	C103	.001 μ F	RF bypass on VCO tuning line
<input type="checkbox"/>	D1	1N4148	VCO switching diode
<input type="checkbox"/>	D2	Factory Installed	
<input type="checkbox"/>	D4	1N4148	VCO switching diode
<input type="checkbox"/>	D8	Factory Installed	
<input type="checkbox"/>	JMP3	"0 ohm"	circuit board jumper
<input type="checkbox"/>	L2	VCO coil	VCO-2 coil
<input type="checkbox"/>	L3	VCO coil	VCO-1 coil
<input type="checkbox"/>	L4	0.27 μ H	PLL feedback lowpass filter
<input type="checkbox"/>	L5	0.39 μ H	" " " "
<input type="checkbox"/>	Q15	2N4124	PLL charge pump
<input type="checkbox"/>	Q16	2N4124	" " "
<input type="checkbox"/>	Q17	2N5087	" " "
<input type="checkbox"/>	Q18	2N5087	" " "
<input type="checkbox"/>	Q19	MPSA14	PLL active loop filter
<input type="checkbox"/>	Q20	J310	VCO-2
<input type="checkbox"/>	Q21	J310	VCO-1
<input type="checkbox"/>	Q22	2N4124	VCO enable transistor
<input type="checkbox"/>	Q23	2N4124	" "
<input type="checkbox"/>	Q24	2N4124	" "
<input type="checkbox"/>	Q25	2N4124	First LO amplifier
<input type="checkbox"/>	Q26	2N4124	VCO buffer for PLL
<input type="checkbox"/>	R7	100	PLL Charge pump
<input type="checkbox"/>	R8	100	PLL Charge pump
<input type="checkbox"/>	R11	47K	Pull-up for VCO
<input type="checkbox"/>	R15	15K	PLL damping resistor
<input type="checkbox"/>	R16	1.5K	Charge pump input
<input type="checkbox"/>	R17	1.5K	Charge pump input
<input type="checkbox"/>	R18	4.7K	Active loop filter input
<input type="checkbox"/>	R19	4.7K	Active loop filter
<input type="checkbox"/>	R20	150	VCO source resistor

Phase 3.0 QUICK REFERENCE SUMMARY, cont.

<input type="checkbox"/>	R21	150	VCO source resistor
<input type="checkbox"/>	R22	10K	VCO select
<input type="checkbox"/>	R23	22K	Active loop filter emitter
<input type="checkbox"/>	R24	47K	VCO pull-up resistor
<input type="checkbox"/>	R25	47K	Varactor bias resistor
<input type="checkbox"/>	R26	47K	VCO switching
<input type="checkbox"/>	R27	47K	VCO switching
<input type="checkbox"/>	R28	47	Supply resistor for Q25
<input type="checkbox"/>	R29	10K	Base bias for Q25
<input type="checkbox"/>	R30	10K	Bias for Q26
<input type="checkbox"/>	R31	470	Emitter resistor for Q26
<input type="checkbox"/>	R32	10K	Bias resistor for Q26
<input type="checkbox"/>	R37	47K	Varactor bias resistor
<input type="checkbox"/>	R38	10K	Charge pump bias
<input type="checkbox"/>	R39	47K	Charge pump bias
<input type="checkbox"/>	R87	2.2K	Collector feed for Q19
<input type="checkbox"/>	T1	bifilar balun	LO output

Phase 3.0 Assembly

This receiver uses two voltage-controlled oscillator (VCO) circuits to cover the total tuning range. We'll begin with VCO-1 which uses adjustable coil L3 to tune the 45-58 MHz 1st LO range.

3A. VCO-1 Components

Adjustable coil L3 is marked with a brown paint dot and is the VCO coil with the greater number of windings. The "B" corner has two wire leads, as indicated in Figure 3.1.

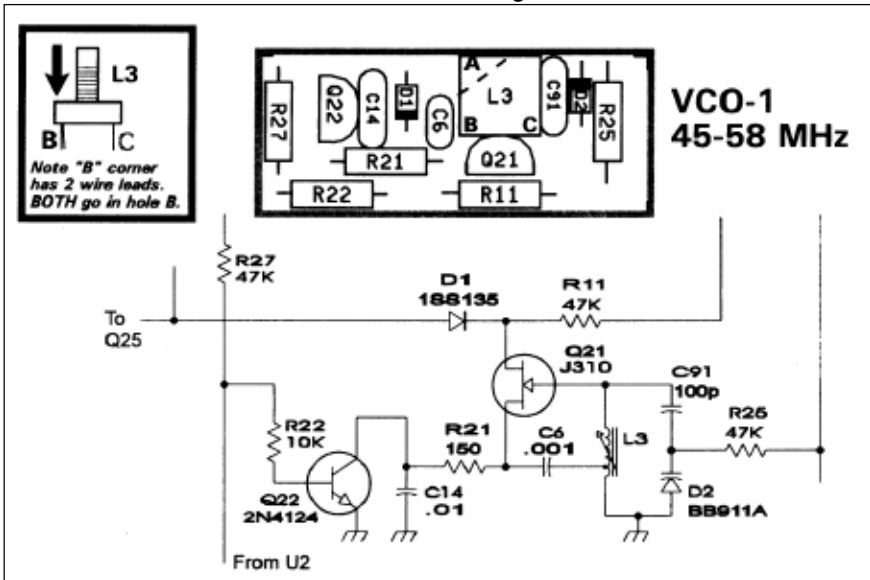

3-2. Identify and install VCO coil L3 per step 3-1 and Fig. 3.1. **Before soldering, make sure the coil base is seated FIRMLY against the board.** A solid mechanical fit is needed for these VCO coils to minimize vibration.

- 3-3. Identify and install JFET transistor Q21, type J310.
- 3-4. Identify and install NPN transistor Q22, type 2N4124.

Refer to PARTS IDENTIFICATION GUIDE for help in identifying diode D1

- 3-5. Diode D2 is factory installed.
- 3-6. Identify and install PIN diode D1, type 1N4148.

Install the following resistors:

- 3-7. Resistor **R21**, **150Ω** (brown-green-brown).
- 3-8. Resistor **R22**, **10K** (brown-black-orange).
- 3-9. Install **R11**, **47K** (yellow-violet-orange).
- 3-10. Install **R25**, also **47K**.
- 3-11. Install **R27**, also **47K**.

Install the following disc capacitors:

- 3-12. Capacitor **C91**, **100 pF**.(marked 101).
- 3-13. Capacitor **C6**, **.001 μF** (marked 102).
- 3-14. Capacitor **C14**, **.01 μF** (marked 103).
- 3-15, 16. *reserved*

38. VCO-2 Components

- 3-17. Adjustable coil **L2** is the VCO coil with the fewer number of windings and marked with a **RED** paint dot. The "**B**" corner has two wire leads, as indicated in **Figure 3.2**.

Figure 3.2

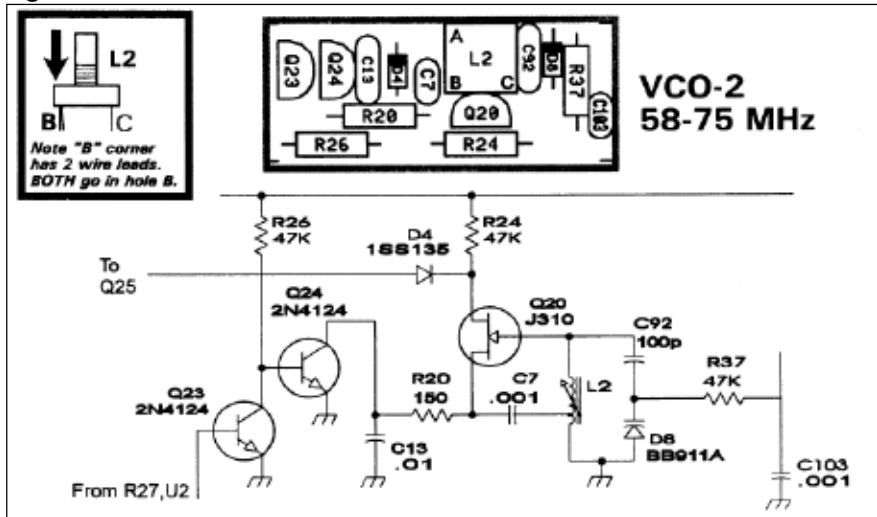

- 3-18. Identify and install **VCO coil L2** per step 3-17 and Fig. 3.2. **Make sure the coil base is seated FIRMLY** against the board.
- 3-19. Identify and install JFET transistor **Q20**, type **J310**.
- 3-20. Identify and install NPN transistor **Q24**, type **2N4124**.
- 3-21. Identify and install NPN transistor **Q23**, type **2N4124**.

- 3-22. Diode **D8, is factory installed.**
- 3-23. Identify and install PIN diode **D4, type 1N4148.**

Install the following resistors:

- 3-24. Resistor **R20, 150 Ω** (brown-green-brown).
- 3-25. Resistor **R24, 47K** (yellow-violet-orange).
- 3-26. Resistor **R26, also 47K.**
- 3-27. Resistor **R37, also 47K.**

Install the following disc capacitors:

- 3-28. Capacitor **C92, 100 pF**.(marked 101).
 - 3-29. Capacitor **C7, .001 μ F** (marked 102).
 - 3-30. Capacitor **C103, also .001 μ F.**
 - 3-31. Capacitor **C13, .01 μ F** (marked 103).
- 3-32. The preceding steps complete installation of all VCO parts within the shield enclosures. Recheck component selection and the quality of solder connections before proceeding. *Do NOT install the shielding until instructed to do so.*

3C. PLL Circuit Completion

- 3-33. Install PNP transistor **Q17, type 2N5087.**
 - 3-34. Install PNP transistor **Q18, also type 2N5087.**
- 3-35. Install NPN transistor **Q15, type 2N4124.**
- 3-36. Install NPN transistor **Q16, also type 2N4124.**
- 3-37. Install transistor **Q19, type MPSA14.**
- 3-38a. Install NPN transistor **Q25, type 2N4124.**
- 3-38b. Install NPN transistor **Q26, also type 2N4124.**
- 3-39. Examine transformer T1, the pre-assembled bifilar balun and its silkscreen outline on the board. The oblong ferrite core of T1 must be oriented as outlined on the board and noted in the drawing on page 27.
- 3-40. Install **bifilar transformer T1** per 3-39.

Install the following 1/4 watt resistors:

- 3-41. Resistor **R28, 47 ohm** (yellow-violet-black).
- 3-42. Resistor **R7, 100 ohm** (brown-black-brown).
- 3-43. Resistor **R8, also 100 ohm.**
- 3-44. Resistor **R31, 470 ohm** (yellow-violet-brown).
- 3-45. Resistor **R16, 1.5K** (brown-green-red).
- 3-46. Resistor **R17, also 1.5K.**
- 3-47. Resistor **R87, 2.2K** (red-red-red).

- 3-48. Resistor **R18, 4.7K** (yellow-violet-red).
- 3-49. Resistor **R19, also 4.7K**.
- 3-50a. Resistor **R29, 10K**, (brown-black-orange).
- 3-50b. Resistor **R30, also 10K**.
- 3-51. Resistor **R32, also 10K**.
- 3-52. Resistor **R38, also 10K**.
- 3-53. Resistor **R15, 15K**, (brown-green-orange).
- 3-54. Resistor **R23, 22K** (red-red-orange).
- 3-55. Resistor **R39, 47K** (yellow-violet-orange).

- 3-56. Install inductor **L4, 0.27 μ H** (red-violet-silver-gold).
- 3-57. Install inductor **L5, 0.39 μ H** (orange-white-silver-gold).

- 3-58. Install C9, the large **mylar film 0.47 μ F** capacitor (marked 474).

- 3-59. Install C10, the mylar film **.047 μ F** capacitor (marked 473).

- 3-60. Install capacitor C12, also mylar film **.047 μ F**.

- 3-61. Install **C11, .01 pF** mylar film (marked 103). [Be sure to use a film type capacitor, **not** ceramic disc for C11.]

- 3-62. Install **electrolytic** capacitor **C32, 10 μ F**, with correct (+) polarization as outlined on the board.

- 3-63. Install electrolytic capacitor **C18, 10 μ F**, per step 3-62.

- 3-64. Install electrolytic capacitor **C102, 33 μ F**, per step 3-62.

Install the following disc ceramic capacitors:

- 3-65. Capacitor **C23, 3 pF**.
- 3-66. Capacitor **C24, 10 pF**.
- 3-67. Capacitor **C19, 27 pF**.
- 3-68. Capacitor **C21, 33 pF**.
- 3-69. Capacitor **C22, 33 pF**.
- 3-70. *reserved*
- 3-71. Capacitor **C16, .001 μ F** {marked 102}.
- 3-72. Capacitor **C17, .01 μ F** (marked 103).

- 3-73. Install **"0 ohm" jumper JMP3**.

- 3-74. **Read entire text before soldering:** Solder a 1/2" length of bare wire (trimmed from a part already installed) to the pad marked "VCO TP" near 019. This is the VCO Test Point to

which you will connect your voltmeter to do the L2 and L3 VCO coil adjustments. If more convenient for your test leads, you can also solder a length of insulated hookup wire instead, and trim it shorter after completing the adjustment.

☐ ☐ 3-75. Solder a 1/2" length of bare wire (trimmed from a part already installed) to the pad marked "FREQ TP".

VCO Test and Alignment

Adjustment of VCO coils L2 and L3 requires an alignment blade of the CORRECT SIZE to fit the slot in the slug. A blade that is too small can easily crack the slug. If you cannot find the right size tool, use sandpaper to shape carefully the tip of a plastic beverage stirrer or wooden kabob stick.

☐ ☐ 3-76. Re-attach the Display Board and reconnect the encoder plug to J4 as in Phase 2.0 testing.

☐ ☐ 3-77. With power switch turned off, reconnect the red wire switch plug to J2, and reconnect the wall transformer power supply to J1.

☐ ☐ 3-78. Connect your meter's red + lead (DC volts range) to the VCO test point and ground. You will be observing voltages in the 2.5 to 8 volt range.

☐ ☐ 3-79. Turn on DC power. Again, the frequency display should read 15.000.0 MHz. If not, perform the Processor Reset explained in the Operating Instructions (Reference Section) and in the Phase 2.0 test.

☐ ☐ 3-80. Tune down to 100 kHz. (Use FAST tuning mode!)

☐ ☐ 3-81. Using the proper size of alignment tool, adjust VCO coil L3 for a reading of 2.0 VDC at the VCO TP.

☐ ☐ 3-82. If you do NOT observe at least 2 volts DC present at the VCO test point, there is a problem. Turn off DC power and thoroughly recheck your work.

☐ ☐ 3-83. With 2.0 VDC at the VCO TP for 100 kHz, start tuning upward in frequency. You should observe a gradual rise in voltage: about 4.5 volts at 7.000 MHz. The maximum will be about 8.5 volts \pm .5 volt at 13.235 MHz.

□ □ 3-84. Tune from 13.235 MHz to 13.240 MHz. You will likely observe a sharp downward shift in DC voltage at the VCO Test Point, indicating that VCO-2 has been switched in.

□ □ 3-85. Adjust VCO-2 coil L2 as needed for a DC voltmeter reading of 2.5 volts at 13.240 MHz. As you tune higher, you should observe a gradual rise in voltage: about 5.5 volts at 19.000 MHz. The maximum will be about 8.0 volts ± .5 volt at 30.000 MHz.

□ □ 3-86. If you have a frequency counter, connect it to "FREQ TP. " Tune to several of the sample frequencies shown in Table 3.1 to confirm that the selected display frequency results in the corresponding LO output frequency.

Table 3.1

Displayed Frequency vs. Local Oscillator Output		
Display	LO Output (MHz)	NOTES
0.000.0	45.000	Test signal: 1st IF (Phase 5.0)
0.100.0	45.100	
1.000.0	46.000	
2.000.0	47.000	
5.000.0	50.000	6 meter ham band (50-54 MHz)
10.000.0	55.000	
15.000.0	60.000	
20.000.0	65.000	
30.000.0	75.000	

The preceding is all that is needed to do basic VCO alignment. A slight touchup will be done after installing the VCO shield assembly, done in Phase 7.0, as part of final alignment.

□ □ 3-87. Turn off DC power; unplug and set aside the display board.

Phase 4.0 Assembly
begins on page 36 ►

Phase 4.0 Schematic Details

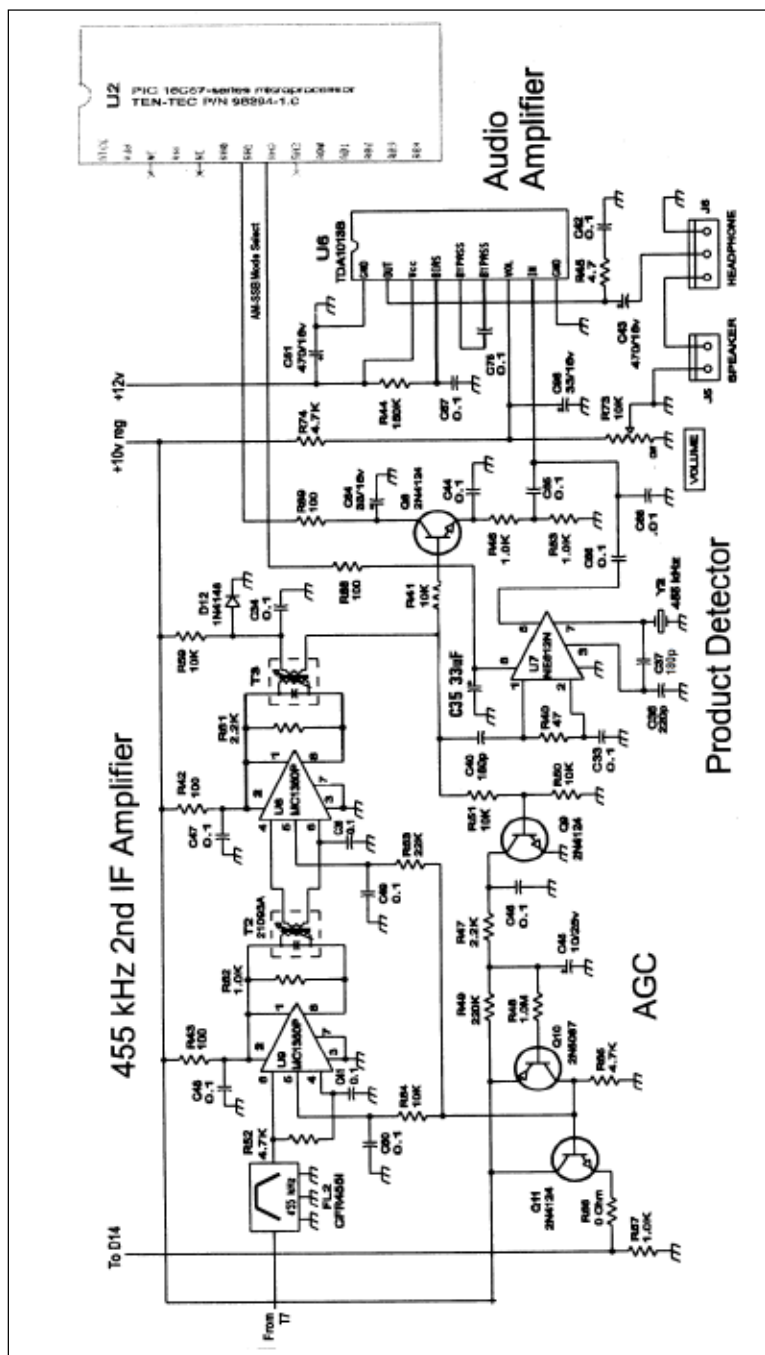

Phase 4.0

Audio Section, AGC, 455 kHz 2nd IF

After part 4A this phase is completed, we can test for audio output and proper operation of the volume control. When this phase is completed, the receiver also can detect a 455 kHz signal such as from its 2nd mixer (Phase 5.0) in either AM or SSB mode.

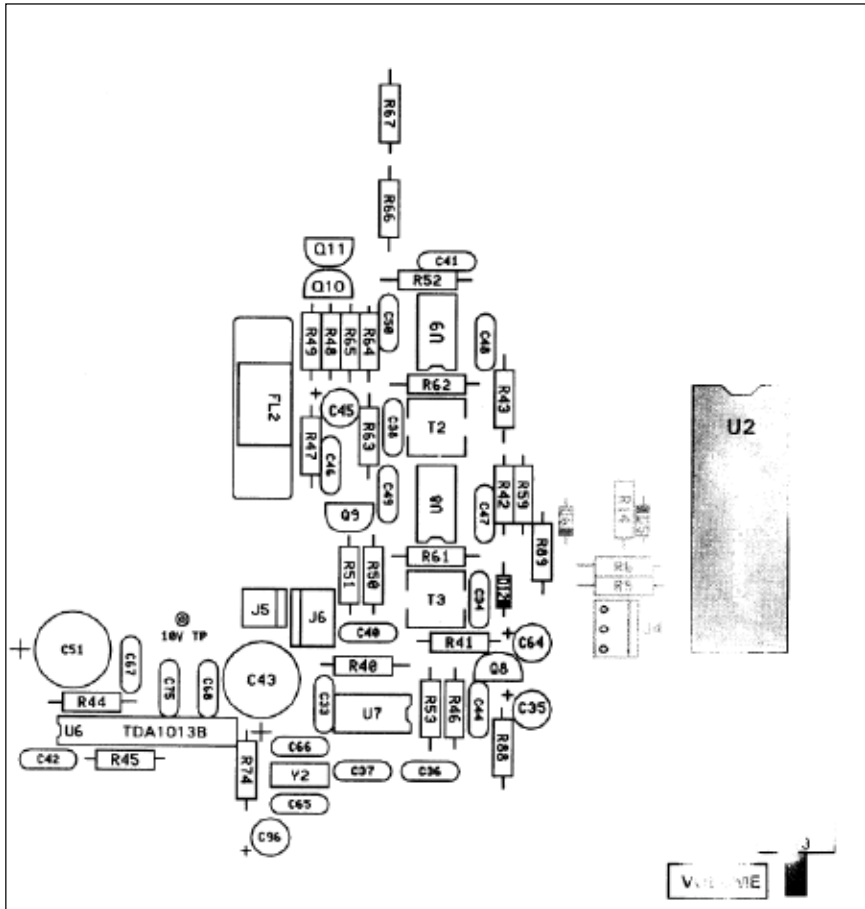

Phase 4.0 QUICK-REFERENCE SUMMARY

Before You Start: The following Quick Reference Summary of the parts used in Phase 4.0 may be used first as a guide to gathering parts for this phase. It is provided as an extra help in double-checking correctness of parts values with brief notes on the function of each part.

<input type="checkbox"/>	C33	0.1 μ F	Input bypass on U7
<input type="checkbox"/>	C34	0.1 μ F	Bypass on output of T3
<input type="checkbox"/>	C35	33/16v el.	Supply bypass on U7
<input type="checkbox"/>	C36	220 pF	Oscillator cap on U7
<input type="checkbox"/>	C37	180 pF	“ “ “
<input type="checkbox"/>	C38	0.1 μ F	Bypass on input of U8
<input type="checkbox"/>	C40	180 pF	Coupling cap into U7
<input type="checkbox"/>	C41	0.1 μ F	Input bypass on U9
<input type="checkbox"/>	C42	0.1 μ F	High frequency shunt on U8
<input type="checkbox"/>	C43	470/16v el.	Audio output coupling cap
<input type="checkbox"/>	C44	0.1 μ F	RF bypass on Q8 base
<input type="checkbox"/>	C45	10/25v el.	AGC time constant cap
<input type="checkbox"/>	C46	0.1 μ F	RF bypass on Q9
<input type="checkbox"/>	C47	0.1 μ F	Supply bypass on U8
<input type="checkbox"/>	C48	0.1 μ F	Supply bypass on U9
<input type="checkbox"/>	C49	0.1 μ F	RF bypass on U8
<input type="checkbox"/>	C50	0.1 μ F	RF bypass on U9
<input type="checkbox"/>	C51	470/16v el.	Supply bypass on U6 audio IC
<input type="checkbox"/>	C64	33/16v el.	Collector bypass on Q8
<input type="checkbox"/>	C65	0.1 μ F	Output coupling from Q8 AM detector
<input type="checkbox"/>	C66	0.1 μ F	Output coupling from product detector
<input type="checkbox"/>	C67	0.1 μ F	Turn-on cap for U6
<input type="checkbox"/>	C68	.01 μ F	Bypass on input to U6
<input type="checkbox"/>	C75	0.1 μ F	Interstage coupling on U6
<input type="checkbox"/>	C98	33/16v el.	Filter cap on volume control
<input type="checkbox"/>	D12	1N4148	Forward bias for AM detector
<input type="checkbox"/>	T2	455 kHz coil	455 kHz IF amplifier
<input type="checkbox"/>	T3	455 kHz coil	“ “
<input type="checkbox"/>	U6	NTE1852	Audio amplifier
<input type="checkbox"/>	U7	NE612N	Product detector
<input type="checkbox"/>	U8	MC1350P	IF amplifier
<input type="checkbox"/>	U9	MC1350P	IF amplifier
<input type="checkbox"/>	Q8	2N4124	AM detector
<input type="checkbox"/>	Q9	2N4124	AGC rectifier
<input type="checkbox"/>	Q10	2N5087	AGC integrator
<input type="checkbox"/>	Q11	2N4124	AGC voltage follower
<input type="checkbox"/>	R40	47	Input resistor to U7 product detector
<input type="checkbox"/>	R41	10K	Input resistor to AM detector
<input type="checkbox"/>	R42	100	Supply to U8
<input type="checkbox"/>	R43	100	Supply to U9
<input type="checkbox"/>	R44	150K	Power-on bias to U6
<input type="checkbox"/>	R45	4.7	High frequency shunt on U6

Phase 4.0 Quick Reference, cont.

<input type="checkbox"/>	R46	1.0K	AM detector emitter resistor
<input type="checkbox"/>	R47	2.2K	AGC discharging resistor
<input type="checkbox"/>	R48	1.0 M	AGC time constant
<input type="checkbox"/>	R49	220K	AGC charging resistor
<input type="checkbox"/>	R50	10K	AGC rectifier pull-down
<input type="checkbox"/>	R51	10K	AGC input resistor
<input type="checkbox"/>	R52	4.7K	IF amp input load
<input type="checkbox"/>	R53	1.0K	AM detector emitter resistor
<input type="checkbox"/>	R59	10K	Forward bias for AM detector
<input type="checkbox"/>	R61	2.2K	IF amp output load, U8
<input type="checkbox"/>	R62	1.0K	IF amp output load, U9
<input type="checkbox"/>	R63	22K	AGC input resistor, U8
<input type="checkbox"/>	R64	10K	AGC input resistor, U9
<input type="checkbox"/>	R65	4.7K	AGC pull-down resistor
<input type="checkbox"/>	R66	0 ohm	Front end AGC voltage divider
<input type="checkbox"/>	R67	1.0K	Front end AGC pull-down
<input type="checkbox"/>	R73	10K var	Front panel volume
<input type="checkbox"/>	R74	4.7K	Volume control pull-up
<input type="checkbox"/>	R88	100	Power feed for product detector
<input type="checkbox"/>	R89	100	Power feed for AM detector
<input type="checkbox"/>	FL2	CFR455I	455 kHz filter
<input type="checkbox"/>	J5	2-pin header	Internal speaker cable connector
<input type="checkbox"/>	J6	3-pin header	Headphone jack cable connector
<input type="checkbox"/>	Y2	455 kHz	Oscillator for product detector

Phase 4.0 Assembly Steps

Section 4A. Audio Amplifier Circuit

U6 is a self-contained audio amplifier SIP (single inline pin) IC, using only a volume control and a very few resistors and capacitors to complete a 1.5 watt audio amplifier. We will assemble this circuitry plus the speaker/headphone connections now, then test their functioning, to confirm audio amplifier performance before adding further stages to the receiver.

4-1a. Examine amplifier IC U6, type TDA1013B and notice its notched/ banded end is similar to other IC's used in the circuit. Insert this end per the notched end on the silkscreen (nearest the space for C79) . **Solder carefully to avoid bridges, because shorts can permanently damage U6!**

4-1b. Install audio IC **U6**, type **NTE1852** per 4-1a.

4-2. Install **J6**, the three-pin connector for the headphone jack cable. Align the locking end as outlined on the board, just as you did when installing the jack for the encoder cable.

4-3. **READ before soldering:** on the **BOTTOM** solder-side of the board, insert **J5**, the 2-pin header (just like the power switch connector) for connecting the built-in speaker. Soldering is done on the top (component) side. Align the locking end of J5 as outlined on the top side. This header must be on the solder-side for proper connection to the speaker when installed permanently.

Install the following *electrolytic* capacitors with correct polarity:

- 4-4. Capacitor **C96**, **33 μ F**.
- 4-5a. Capacitor **C43**, **470 μ F**.
- 4-5b. Capacitor **C51**, **also 470 μ F**.

Install these supporting parts for U6:

- 4-6. Resistor **R45**, **4.7 ohms** (yellow-violet-gold).
- 4-7. Resistor **R74**, **4.7K** (yellow-violet-red).
- 4-8. Resistor **R44**, **150K** (brown-green-yellow)
- 4-9. Ceramic disc capacitor **C42**, **0.1 μ F** (marked 104).
- 4-10. Capacitor **C67** , **also 0.1 μ F**.
- 4-11. Capacitor **C75**, **also 0.1 μ F**.

- 4-12. Install **10K potentiometer R73**, the volume control, making sure that all three solder tabs are squarely into the board as far as they can go, to ensure a proper fit to the display board.

❑❑ 4-13. Strip 1/8" insulation from the ends of the black and white wires of the 2-conductor speaker cable. Solder the stripped ends to the two terminals of the 3" speaker supplied in the kit. (White is "+", black is "-", but speaker polarity is not critical in this application.)

❑❑ 4-14. Strip 1/8" insulation from all three ends of the wires of the 3-wire headphone jack cable. Solder the stripped ends to the 1/8" jack as illustrated in Figure 4.1.

Decide NOW if this jack should be wired for stereo (normal) or mono 1/8" plugs. (A mono plug will short out the jack if wired for stereo.)

Figure 4.1: Headphone Jack Wiring Options

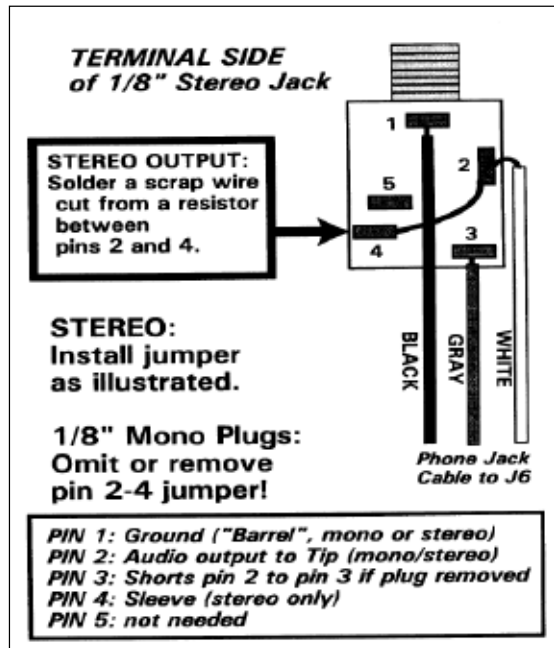

Progress Test 4A: Audio Amplifier

❑❑ 4-15. Connect the headphone jack cable assembly to J6. **This connection MUST be made** regardless of whether you have headphones or plan to try them out later. This is because the stereo jack's internal switching routes the amplifier output to the J6 speaker connection with no plug inserted in the stereo jack.

❑❑ 4-16. Connect the receiver speaker to J5 on the solder-side on the board and turn the volume control fully counter-clockwise.

☐ ☐ 4-17. Reconnect the 15 volt DC supply to J1 as for the phase 3.0 VCO tests. For this test, re-attaching the Display Board is optional, but DO connect the power switch plug to J2. If you do attach the display board, handle the volume control gently.

☐ ☐ 4-18. Turn on DC power, then advance the volume control. You should hear only a faint hiss which grows stronger with the turning of the volume control. Hold a small screwdriver by its shaft and touch the pad for C66 (not yet installed) which is nearest audio IC U6. Your body contact with this input to U8 should produce a fairly loud hum (60 Hz AC house wiring).

☐ ☐ 4-19. If you do NOT obtain these test results, recheck and correct your work before proceeding. The intentional AC hum and the soft background hiss are the only sounds you should hear. i.e., there must be no squeals or "putt-putt" motorboating sounds.

During further assembly, handle the hoard carefully so that the Volume Control leads are not bent hack and forth. The Clarifier control will be mounted in Phase 5.0 and will require similar carefulness.

Section 4B.

Product Detector and AM Detector Section

☐ ☐ 4-20. Install **U7, the NE612AN or SA612AN 8-pin DIP IC**, aligning the notched or dotted end as outlined on the board.

☐ ☐ 4-21 . Install transistor **Q8, NPN type 2N4124**.

☐ ☐ 4-22. Install **Y2, the 455 kHz oscillator device** (ceramic resonator, rectangular plastic case, 2 pins, marked 455BK).

Install the following 1/4-watt resistors:

☐ ☐ 4-23. Resistor **R40, 47 ohm** (yellow-violet-black).

☐ ☐ 4-24. Resistor **R88, 100 ohms** (brown-black-brown).

☐ ☐ 4-25. Resistor **R89, also 100 ohms**.

☐ ☐ 4-26. Resistor **R46, 1K** (brown-black-red).

☐ ☐ 4-27. Resistor **R53, also 1K**.

☐ ☐ 4-28. Resistor **R41, 10K** (brown-black-orange).

Install the following ceramic disc capacitors:

- 4-29. Capacitor **C37, 150 pF** (marked 151).
- 4-30. Capacitor **C36, 220 pF** (marked 221).
- 4-31. Capacitor **C40, 180 pF** (marked 181).
- 4-32. Capacitor **C33, 0.1 μ F** (marked 104).
- 4-33. Capacitor **C44, also 0.1 μ F**.
- 4-34. Capacitor **C46, also 0.1 μ F**.
- 4-35. Capacitor **C65, also 0.1 μ F**.
- 4-36. Capacitor **C66, also 0.1 μ F**.
- 4-37. Capacitor **C68, 0.01 μ F**.

Install the following *electrolytic* capacitors with correct polarity:

- 4-38. Capacitor **C35, 33 μ F**.
- 4-39. Capacitor **C64, 33 μ F**.

Progress Test 4B

PROCEDURE:

- 4-40. Reconnect the speaker Headphone jack cable power switch plug, and DC power supply
- 4-41. Reconnect the Display Board as in Phase 2.0 testing.
- 4-42. Find the pad for R41 (not yet installed) nearest to C40, 180 pF, very close to the headphone jack connector. This pad is common to C40, the input coupling capacitor for U7.
- 4-43. Turn on DC power to the 1254 board. Adjust the volume control to maximum. Set [MODE] to SSB.
- 4-44. Touch one end of a test lead to the pad for R41 nearest C40. In SSB mode, you will hear a very slight increase in hiss level. Place the other end of the test wire next to the 6-digit LED display. You should hear low-level musical tones, which are harmonics of the LED multiplexing circuit.
- 4-46. If you get the above-described result, turn off DC power, disconnect all cables from the 1254 board, and proceed to part 4C of Phase 4.0. If not, the first thing to do is to review all parts installed in part 4B.
- 4-46-49. *reserved*

Section 4C: IF Amplifier and AGC

- 4-50. Install **U8, a MC1350P 8-pin DIP IC**, being the notched or dotted end as outlined on the board.

- 4-51. Install **U9, a MC1350P 8-pin DIP IC**, being the notched or dotted end as outlined on the board.

- 4-52. Install transistor **Q9, NPN type 2N4124**.
- 4-53. Install transistor **Q11, NPN type 2N4124**.

- 4-54. Install transistor **Q10, PNP type 2N5087**.

- 4-55. Install diode **D12, type 1N4148**, with correct cathode band orientation as outlined on the board.

- 4-56. Install the **455 kHz filter FL2 (labeled CFR455-I)**. Its pin arrangement permits only one possible orientation. Simply ignore the group of small circuit board holes covered by the filter case.

- 4-57. Install **T2, a 455 kHz shielded transformer**. Its pin arrangement permits only one possible orientation. (While the markings may vary, these transformers have 5 pins, 2 shield tabs and are the only parts in the kit which will fit here.)

- 4-58. Install **T3, a 455 kHz shielded transformer**, per the information in the preceding step.

Install the following 1/4-watt resistors:

- 4-59. Resistor **R66, "0 ohm"** (one black band).
- 4-60. Resistor **R42, 100 ohms** (brown-black-brown).
- 4-61. Resistor **R43, also 100 ohms**.
- 4-62. Resistor **R62, 1K** (brown-black-red).
- 4-63. Resistor **R67, also 1K**.
- 4-64. Resistor **R47, 2.2K** (red-red-red).
- 4-65. Resistor **R61, also 2.2K**.
- 4-66. Resistor **R52, 4.7K** (yellow-violet-red).
- 4-67. Resistor **R65, also 4.7K**.
- 4-68. Resistor **R50, 10K** (brown-black-orange).
- 4-69. Resistor **R51, also 10K**.
- 4-70. Resistor **R59, also 10K**.
- 4-71. Resistor **R64, also 10K**.
- 4-72. Resistor **R63, 22K** (red-red-orange).
- 4-73. Resistor **R49, 220K** (red-red-yellow).
- 4-74. Resistor **R48, 1 megohm** (brown-black-green).

Install these 0.1 μ F disc capacitors (marked 104):

- 4-75. Capacitor **C34, 0.1 μ F.**
- 4-76. Capacitor **C38, 0.1 μ F.**
- 4-77. Capacitor **C41, 0.1 μ F.**
- 4-78. Capacitor **C47, 0.1 μ F.**
- 4-79. Capacitor **C48, 0.1 μ F.**
- 4-80. Capacitor **C49, 0.1 μ F.**
- 4-81. Capacitor **C50, 0.1 μ F.**
- 4-82. *reserved*

- 4-83. Install electrolytic capacitor **C45, 10 μ F** with correct (+) polarity.

Final (4C) Phase 4.0 Progress Test

Some technicians may feel the only way to fully prove to all your senses that all the circuitry built in Phase 4.0 is working properly is to see if a nearby 455 kHz signal can be detected. An RF signal generator is the usual source for such a signal.

HOWEVER, this circuit is engineered to permit an extremely SIMPLE test at this point!

If this section of the receiver has problems, no further amount of work on the mixers or 45 MHz 1st IF can fix problems in THIS section.

PROCEDURE:

- 4-84. Reconnect: speaker headphone jack cable, power switch plug DC power supply and the Display Board

- 4-85. Turn on DC power to the 1254 board. Adjust the volume control to its midway point. If you can recall what you heard in previous tests, you should notice a sharp increase in background noise level introduced by adding the IF amplifier section.

- 4-86. Touch a meter test probe or even a screwdriver as you did for the audio amplifier to the lead of R52 nearest Q10. You should note a sharp increase in background noise. This indicates that the IF amplifiers are working correctly.

- 4-87. Switch the [MODE] button back and forth between AM and SSB while still holding a probe at R52. In AM mode, you should hear mainly a loud hum. In SSB mode, the sound changes to a hiss.

☐ ☐ 4-88. If there is NO or very little sound in SSB mode, there is a problem in the circuitry associated with U7, the Product Detector.

☐ ☐ 4-89. If you get the above-described result, turn off DC power, disconnect all cables from the 1254 board, set aside the display board, and proceed to Phase 5.0! If not, please read on.

Building the T-KIT Model 1254 Receiver: An “INTERMISSION”

In this receiver project, it is impossible to say which is the most important or critical phase. That's because EVERY circuit section must perform correctly if this Receiver is to work as designed.

Hopefully, you found Phases 1.0 and 2.0 easy and fun: the microprocessor and front panel display do their thing, and we were off to a great start, thanks to digital technology.

The VCO/PLL circuitry in Phase 3.0 generates the RF tuning signal ("LO") essential for mixing and converting signal from your antenna, first to 45 MHz and then again to 455 kHz and then again to intelligible audio.

Phase 4.0 is very important simply because it is the meeting ground between your ear and all other "superheterodyne" activity converging on it from the other circuit phases. If you did not obtain the best results explained for Phase 4.0, go over all parts installed in this phase, using the double-check blocks for the assembly steps, Then review the work using the Quick-Reference list of Phase 4.0 parts at the beginning of this section.

If you know for sure that Phases 2.0, 3.0, and 4.0 work exactly as explained in their Progress tests, then the upcoming work of building up two mixer sections and RF input should make clearer sense to you now.



This space is for your notes

Phase 5.0 Schematic Details

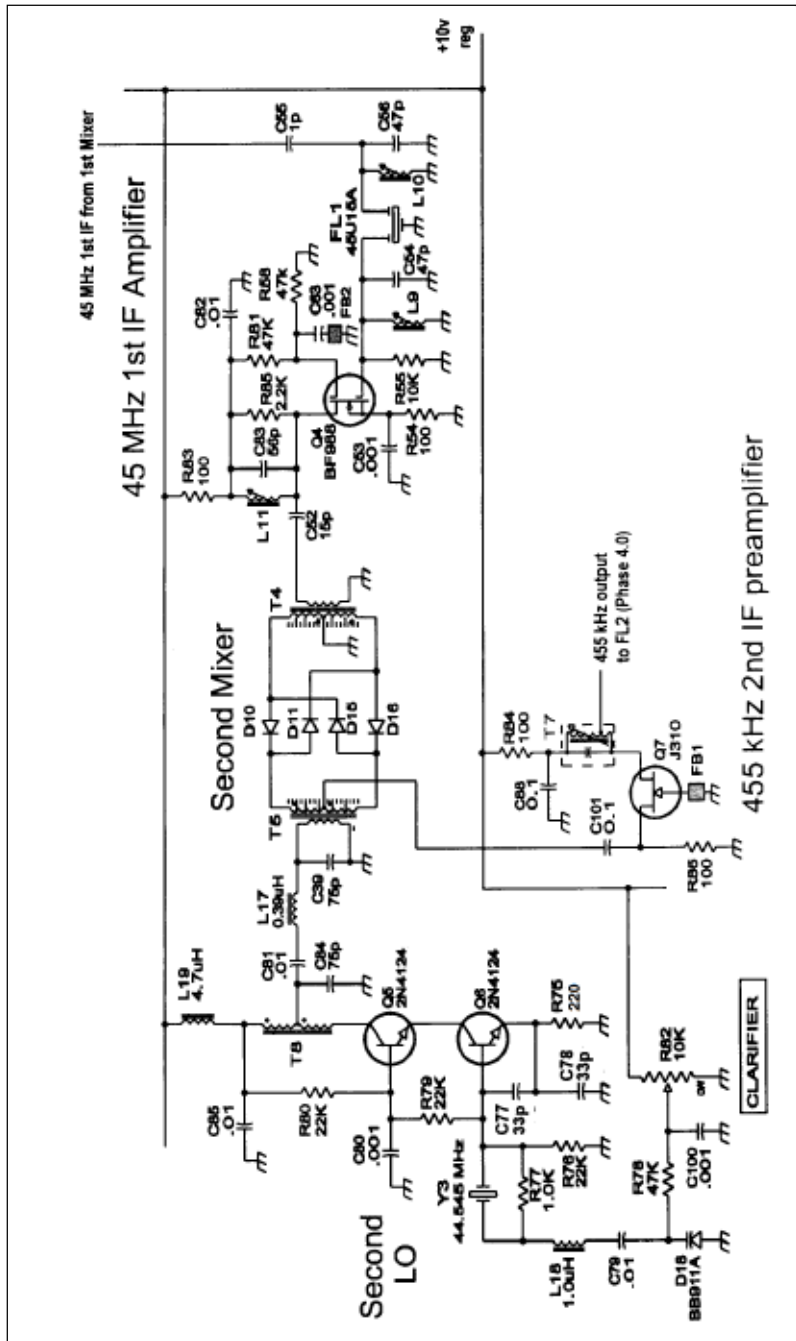

Phase 5.0 Second Mixer and 45 MHz First IF

The result of successful completion of this assembly phase will be a receiver circuit capable of detecting very strong nearby 45 MHz signals in either AM or SSB-CW mode. The Model 1254 has a built-in 45.000 MHz test signal capability.

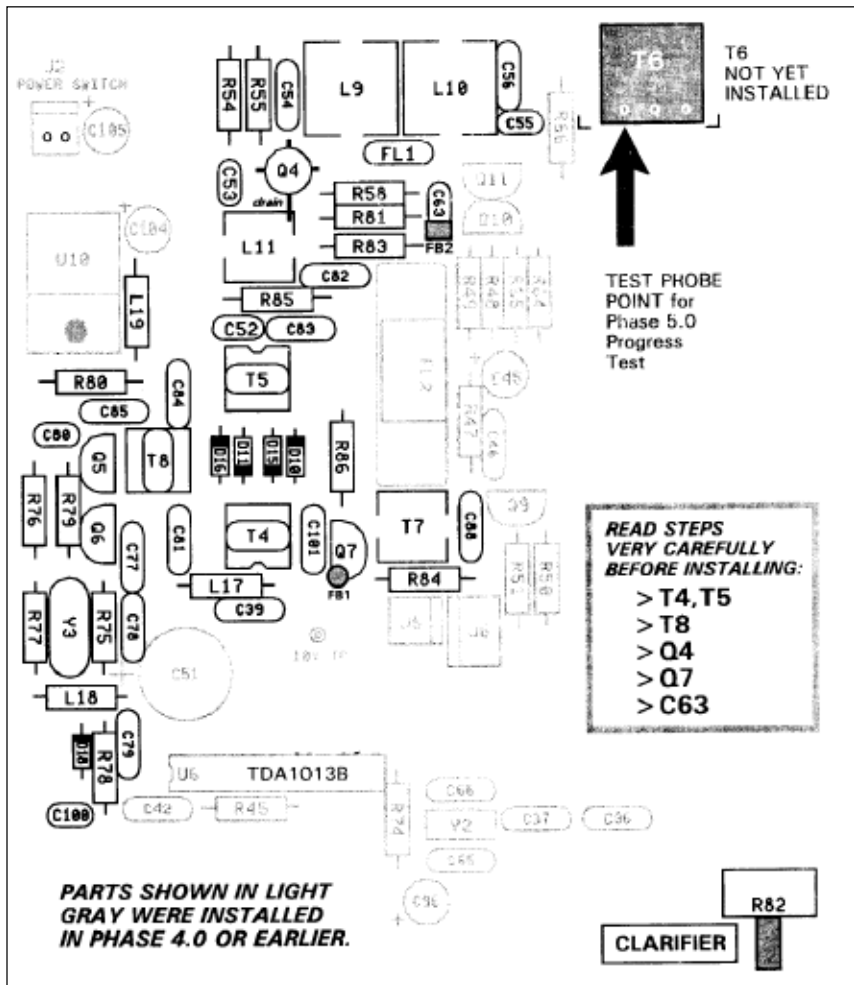

Phase 5.0 QUICK-REFERENCE INFORMATION

□	C39	75 pF	Second LO output filter
□	C52	15 pF	Output coupling cap from Q4
□	C53	.001 μ F	Source bypass cap on Q4
□	C54	47 pF	Resonating cap on input of Q4
□	C55	1 μ F	Input cap to FL1
□	C56	47 pF	Resonating cap on input to FL1
□	C63	.001 μ F	Gate-2 bypass on Q4
□	C77	33 pF	Second LO capacitor at Q6 base
□	C78	33 pF	" " "
□	C79	.01 μ F	Coupling cap to clarifier varicap
□	C80	.001 μ F	Base bypass on Q5
□	C81	.01 μ F	Second LO output coupling cap
□	C82	.01 μ F	Supply bypass for Q4
□	C83	56 pF	Output resonating cap for Q4
□	C84	75 pF	Second LO output filter
□	C85	.01 μ F	Supply bypass for Q5
□	C88	0.1 μ F	Supply bypass for Q7
□	C100	.001 μ F	Bypass cap on clarifier control
□	C101	0.1 μ F	Coupling cap into Q7
□	D10	1N4148	Second mixer diode
□	D11	1N4148	Second mixer diode
□	D15	1N4148	Second mixer diode
□	D16	1N4148	Second mixer diode
□	D18	Factory Installed	
□	L9	0.25 μ H	45 MHz filter
□	L10	0.25 μ H	45 MHz filter
□	L11	0.12 μ H	Mixer circuit
□	L17	0.39 μ H	Mixer out
□	L18	1.0 μ H	Y3 crystal tuning network
□	L19	4.7 μ H	DC power RF choke
□	T4	trifilar balun	2nd mixer transformer
□	T5	trifilar balun	2nd mixer transformer
□	T7	455 kHz coil	455 kHz output from mixer to 2nd IF
□	T8	bifilar balun	2nd LO output transformer
□	Q4	BF988	First IF amplifier
□	Q5	2N4124	Second LO buffer
□	Q6	2N4124	Second LO oscillator
□	Q7	J310	455 kHz IF preamplifier
□	R54	100	Source resistor for Q4
□	R55	10K	Gate load for Q4
□	R58	47K	Gate 2 bias for Q4
□	R75	220	Second LO emitter resistor
□	R76	22K	Second LO bias
□	R77	1.0K	Crystal shunt resistor
□	R78	47K	Clarifier varactor bias
□	R79	22K	Second LO bias
□	R80	22K	Second LO bias
□	R81	47K	Gate 2 bias for Q4
□	R82	10K variable	Front panel Clarifier control
□	R83	100	Supply feed for Q4
□	R84	100	Supply feed for Q7
□	R85	2.2K	Drain load for Q4
□	R86	100	Source resistor for Q7
□	FL1	45U1A	45 MHz crystal filter
□	Y3	44.545 MHz	Second LO
□	FB1	ferrite bead	put on gate lead of Q7
□	FB2	ferrite bead	put on lead closest to "FB2" on board

Phase 5.0 Assembly Steps

Before You start: The preceding **Quick Reference Summary** of the parts used in Phase 5.0 may be used first as a guide to gathering parts for this phase. It is provided as an extra help in double-checking correctness of parts values with brief notes on the function of each part.

Install mixer diodes **D10-11, D15-16, type 1N4148**, making sure to align the black cathode bands exactly as outlined on the board:

- 5-1. Diode **D10, type 1N4148**.
- 5-2. Diode **D11, type 1N4148**.
- 5-3. Diode **D15, type 1N4148**.
- 5-4. Diode **D16, type 1N4148**.

Figure 6.1

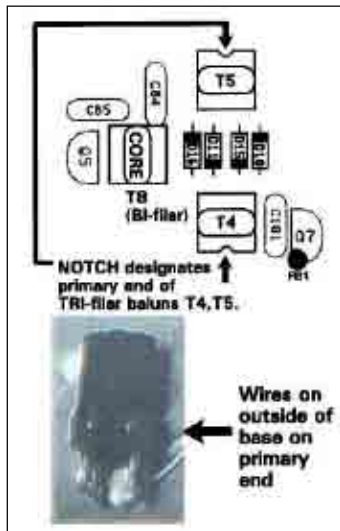

5-5. Select T4 and T5, the pre-assembled trifilar (3 winding) balun transformers, noting that they have SIX pins. Notice carefully which end of the plastic base has the two yellow/gold primary wires coming from the ferrite core over the base to two pins. These two transformers must be installed with these primary ends furthest from the mixer diodes as indicated by the notches in the board silkscreen and Figure 5.1.

5-6. Install trifilar balun transformer T4 per 5-5.

5-7. Install trifilar balun transformer T5 per 5-5.

5-8a. Examine transformer T8, the pre-assembled bifilar balun (4 pins) and its silkscreen outline on the board. The ferrite core of T8 must be oriented as outlined on the board and noted in Figure 5.1.

- 5-8b. Install transformer **T8** per 5-8a.
- 5-9. Install transistor **Q5, NPN type 2N4124**.
- 5-10. Install transistor **Q6, NPN type 2N4124**.

Install the following 1/4-watt resistors:

- 5-11. Resistor **R54, 100 ohms** (brown-black-brown).
- 5-12. Resistor **R83, also 100 ohms**.
- 5-13. Resistor **R84, also 100 ohms**.
- 5-14. Resistor **R86, also 100 ohms**.
- 5-15. Resistor **R60, 220 ohms** (red-red-brown).
- 5-16. Resistor **R75, also 220 ohms**.
- 5-17 Resistor **R77, 1K** (brown-black-red).
- 5-18. Resistor **R85, 2.2K** (red-red-red).
- 5-19. Resistor **R55, 10K** (brown-black-orange).
- 5-20. Resistor **R76, 22K** (red-red-orange).
- 5-21. Resistor **R79, also 22K**.
- 5-22. Resistor **R80, 22K**.
- 5-23. Resistor **R58, 47K** (yellow-violet-orange).
- 5-24. Resistor **R78, also 47K**.
- 5-25. Resistor **R81, also 47K**.

Install these ceramic disc capacitors:

- 5-26. Capacitor **C55, 1 pF**.
- 5-27. Capacitor **C52, 15 pF**.
- 5-28. Capacitor **C77, 33 pF**.
- 5-29. Capacitor **C78, 33 pF**.
- 5-30a. Capacitor **C54, 47 pF**.
- 5-30b. Capacitor **C56, 47 pF**.
- 5-31. Capacitor **C83, 56 pF**.
- 5-32. Capacitor **C39, 75 pF**.
- 5-33. Capacitor **C84, 75 pF**.
- 5-34. Capacitor **C53, .001 μ F** (marked 102).
- 5-35. **DO NOT install C63, .001 μ F, until instructed.**
- 5-36. Capacitor C80, also .001 μ F.
- Capacitor **C100, also .001 μ F**.
- Capacitor **C79, .01 μ F** (marked 103).
- Capacitor **C81, also .01 μ F**.
- Capacitor **C82, also .01 μ F**.
- Capacitor **C85, also .01 μ F**.
- Capacitor **C88, 0.1 μ F** (marked 104).
- Capacitor **C101, also 0.1 μ F**.

Install these molded inductors:

- 5-44. Coil **L17, 0.39 μ H** (orange-white-silver-gold).
- 5-45. Coil **L18, 1.0 μ H** {brown-black-gold-gold}.
- 5-46. Coil **L19, 4.7 μ H** (yellow-violet-gold-gold).
- 5-47. Install 455 kHz transformer T7 (identical to T2 and T3 installed in Phase 4.0).
- 5-48. Install the unshielded slug-tuned coil L11, being sure it is seated squarely on the board before soldering. (L11 is similar to but smaller than coils L9 and L10).

- ❑ ❑ 5-49. Install the unshielded slug-tuned coil **L9**, being sure it is seated squarely on the board before soldering.
- ❑ ❑ 5-50. Install the unshielded slug-tuned coil **L10**, being sure it is seated squarely on the board before soldering.
- ❑ ❑ 5-51. Slip the smallest shield can over L11 and the two larger shield cans over L9 and L10. These cans fit snugly over the inductors. Make sure all three are seated squarely on the board, then solder all six mounting tabs.
- ❑ ❑ 5-52. Diode **D18**, is factory installed.

**Correct installation of Q4, Q7 and C63
require careful attention to the following directions
while referring to Figure 5.2.**

Figure 5.2: Q4, Q7, C63

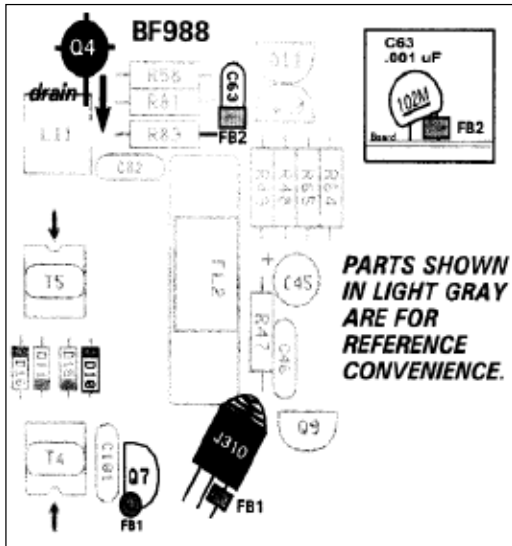

- ❑ ❑ 5-53. Examine Q4, type BF988, noting that the tab for the drain is longer than the other three. It must be aligned as illustrated in Figure 5.2. If you live in a dry climate, discharge static electricity from your hands and tools before handling Q4. The imprinted side of Q4 faces up. Bend all four tabs straight down from the transistor body, insert, then solder all four connections.

- ❑ ❑ 5-54. Capacitor C63, .001 μF (marked 102), requires a ferrite bead on the lead nearest the "FB2" label on the board. Simply slip the bead on the lead, seat the capacitor as far as both leads can go down, and solder both leads in the normal way.
- ❑ ❑ 5-55. JFET transistor of, type J310, is installed in the normal manner but with a ferrite bead slipped over the gate (grounded) lead as illustrated in Figure 5.2.

5-56. Install **FL1, the 45 MHz crystal filter (45U1A)**, which looks like a small crystal but with three leads.

5-57. Slip a base insulator over the leads of crystal **Y3. 44.545 MHz**, then install Y3 in the normal manner.

5-58. Install **10K potentiometer R82**, the Clarifier control. Before soldering, make sure the control is mounted squarely against the board, to assure proper mating to the display board.

5-59a. Now that you have connected the Display Board several times for previous Progress Tests, you should be satisfied that the DC on-off power switch is wired correctly. This means one red wire to the center terminal, and the other to the bottom when the display board faces you correctly.

5-59b. If all is well per 5-59a, use your cutter or nipper to REMOVE the unused (UPPER) lug of the power switch. Doing so will prevent the unneeded lug from pushing into the nearest parts on the main board when mounted permanently.

Phase 5.0 Progress Test

At this point in the project, we have a complete signal path from the input of the 45 MHz IF out to the speaker. We cannot tune the receiver because there is no mixer stage Yet. However, we can tune the synthesizer output down to 45.000 MHz to generate a built-in test signal.

5-60. Remove any mounting nuts and washers from the Volume and Clarifier controls and set them aside. Reconnect the display board, being gentle with the controls as the shafts are passed through their holes.

5-61. Reconnect these cables: Encoder Headphone jack
 Internal Speaker DC power switch

5-62. Reconnect the 15VDC power supply to J1. Turn on the power switch and adjust the volume control for moderate background noise. Set the Mode switch to SSB.

5-63. Touch the probe of one of your voltmeter leads to the LEFT pad in the row of three pads within the outline for transformer T6. This has the effect of connecting a short "antenna" directly to the input of the 45 MHz 1st IF through C55.

☐ ☐ 5-64. Touching the probe as explained above should cause a very distinct increase in background noise level. Adjust coils L9 and L10 for maximum noise level. If you can do this, you have confirmed that there is a functioning signal path from C55 through all the circuitry you installed in Phase 4.0 and 5.0 to the audio amplifier. (If there is any local noise or static which would cause interference in any other radio, you will hear that too! for example: lightning, noise from appliances, power lines, etc.)

☐ ☐ 5-65. Lay your test lead wire so that it is near the LED frequency display. With the probe touching the left T6 pad, you should hear a strong music-like blend of tones which are harmonics of the multiplexing signals which illuminate the display, as explained in the "Circuit Description". Rotating the clarifier control should change the pitch of the tone(s) you are hearing. Rotating the tuning control will cause audible clicks.

☐ ☐ 5-66. Press the [SPEED] button for FAST (100 kHz) tuning steps as indicated by the LED below the switch button. Tune down until the display reads 0.000.0. The synthesizer is now programmed to a frequency of 45.000 MHz, and the output level is strong enough to be picked up by the Q4 circuitry. (NOTE: the synthesizer cannot be tuned below the 100 kHz limit using 2.5 or 5 kHz steps.) The 45.000 MHz LO signal should be very strong, and you can adjust its pitch with the clarifier control.

If you have observed the test results explained here, you can proceed with confidence to the RF input and First Mixer sections which will combine the signals from an antenna with the LO output of the 45-75 MHz frequency synthesizer, feeding the 45 MHz IF, resulting in a completed receiver!

☐ ☐ 5-67. Disconnect the DC supply, disconnect all cables and set aside the display board.

Phase 6.0 Assembly
begins on page 56 ►

Phase 6.0 Schematic Details

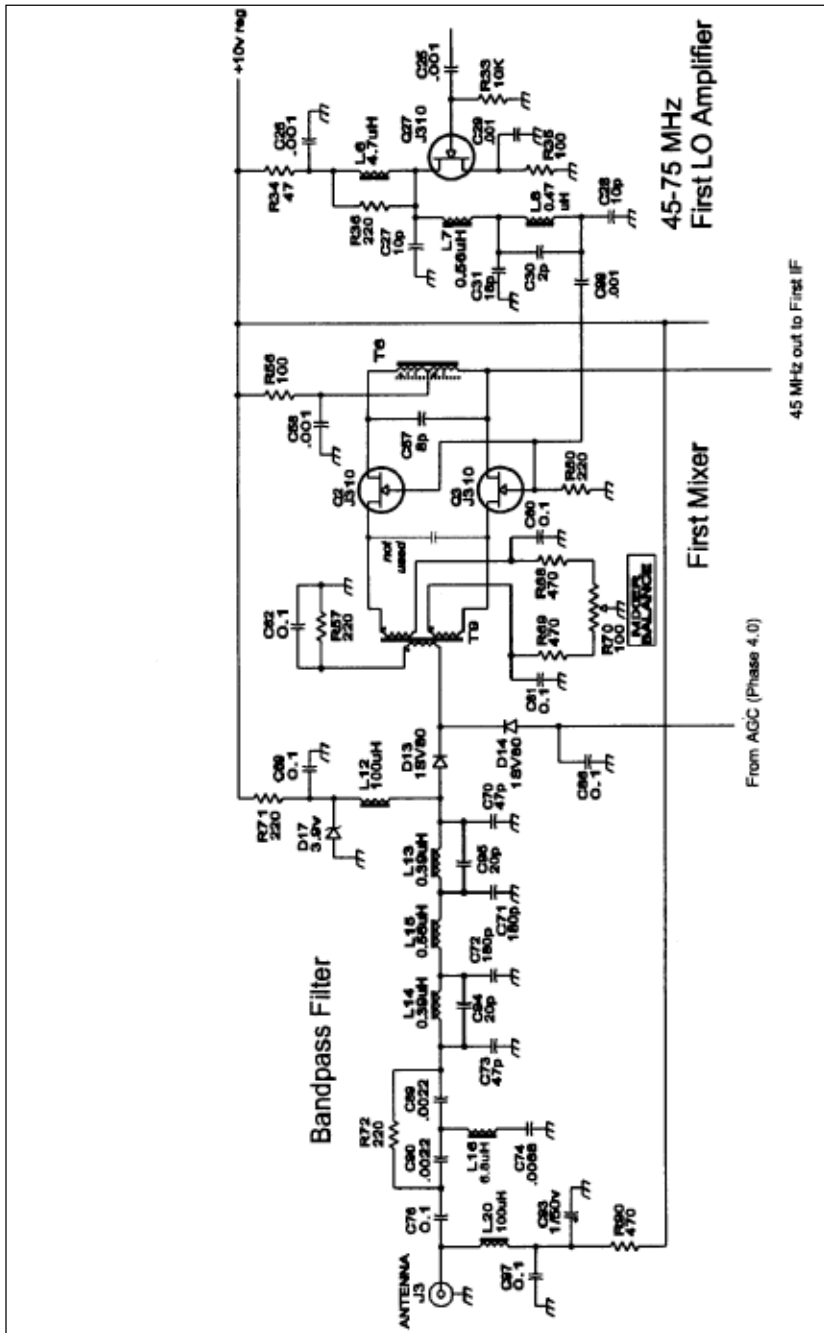

Phase 6.0 QUICK-REFERENCE INFORMATION

<input type="checkbox"/>	C25	.001 μ F	Coupling cap into Q27
<input type="checkbox"/>	C26	.001 μ F	Supply bypass for Q27
<input type="checkbox"/>	C27	10 pF	1st LO output filter
<input type="checkbox"/>	C28	10 pF	" " "
<input type="checkbox"/>	C29	.001 μ F	Source bypass on Q27
<input type="checkbox"/>	C30	2 pF	1st LO output filter
<input type="checkbox"/>	C31	18 pF	" " "
<input type="checkbox"/>	C57	8 pF	Resonating cap on mixer T6
<input type="checkbox"/>	C58	.001 μ F	Supply bypass on first mixer
<input type="checkbox"/>	C60	0.1 μ F	RF bypass on mixer transformer
<input type="checkbox"/>	C61	0.1 μ F	" " " "
<input type="checkbox"/>	C62	0.1 μ F	" " " "
<input type="checkbox"/>	C69	0.1 μ F	" " " "
<input type="checkbox"/>	C70	47 pF	RF Input lowpass filter
<input type="checkbox"/>	C71	180 pF	" " "
<input type="checkbox"/>	C72	180 pF	" " "
<input type="checkbox"/>	C73	47 pF	RF Input lowpass filter
<input type="checkbox"/>	C74	.0068 μ F film	AM broadcast notch
<input type="checkbox"/>	C76	0.1 μ F	Antenna input coupling cap
<input type="checkbox"/>	C86	0.1 μ F	RF bypass on AGC diode Q14
<input type="checkbox"/>	C89	.0022 μ F film	AM broadcast input filter
<input type="checkbox"/>	C90	.0022 μ F film	" " "
<input type="checkbox"/>	C93	1/50v el.	Supply bypass for active antenna DC
<input type="checkbox"/>	C94	20 pF	Antenna input lowpass filter
<input type="checkbox"/>	C95	20 pF	" " " "
<input type="checkbox"/>	C97	0.1 μ F	Supply bypass for antenna DC
<input type="checkbox"/>	C99	.001 μ F	First LO output coupling cap
<input type="checkbox"/>	D13	BA479G	Front end AGC series diode
<input type="checkbox"/>	D14	BA479G	Front end AGC shunt diode
<input type="checkbox"/>	D17	3.9V zener	Front end AGC bias
<input type="checkbox"/>	L6	4.7 μ H	LO amplifier DC supply choke
<input type="checkbox"/>	L7	0.56 μ H	LO output lowpass network
<input type="checkbox"/>	L8	0.47 μ H	" " "
<input type="checkbox"/>	L12	100 μ H	Front-end AGC RFC
<input type="checkbox"/>	L13	0.39 μ H	RF input bandpass filter
<input type="checkbox"/>	L14	0.39 μ H	" " "
<input type="checkbox"/>	L15	0.56 μ H	" " "
<input type="checkbox"/>	L16	6.8 μ H	AM broadcast notch with C74
<input type="checkbox"/>	L20	100 μ H	RFC for active antenna DC supply
<input type="checkbox"/>	T6	1 μ H w/CT	First mixer input
<input type="checkbox"/>	T9	trifilar balun	First mixer output
<input type="checkbox"/>	Q2	J310	First Mixer with Q3
<input type="checkbox"/>	Q3	J310	First Mixer with Q2
<input type="checkbox"/>	Q27	J310	First LO output amplifier
<input type="checkbox"/>	R33	10K	Gate pull-down tor Q27
<input type="checkbox"/>	R34	47	Supply resistor tor Q27
<input type="checkbox"/>	R35	100	Source resistor tor Q27
<input type="checkbox"/>	R36	220	Drain load tor Q27
<input type="checkbox"/>	R56	100	Supply resistor for first mixer
<input type="checkbox"/>	R57	220	Front end AGC return
<input type="checkbox"/>	R60	220	Output load for first LO
<input type="checkbox"/>	R68	470	First mixer balance
<input type="checkbox"/>	R69	470	First mixer balance
<input type="checkbox"/>	R70	100 trimmer	Mixer balance adjustment
<input type="checkbox"/>	R71	220	Front end AGC forward bias
<input type="checkbox"/>	R72	220	AM broadcast attenuator
<input type="checkbox"/>	R90	470	Source resistor fol antenna DC

Phase 6.0

RF Input Circuit and First Mixer

For your convenience, the complete hoard drawing for Phase 6.0 is presented on Page 62 after we finish the two shielded sections for which separate drawings are provided.

Phase 6.0 Assembly

Before You Start: The preceding Quick Reference Summary of the parts used in Phase 6.0 may be used first as a guide to gathering parts for this phase. It is provided as an extra help in double-checking correctness of parts values with brief notes on the function of each part.

6A. Shielded RF Input Bandpass Filter

This circuitry will be enclosed within a shield just like the VCO's. Therefore, careful attention to correct parts selection is especially important. Figure 6.1 is provided for your convenience.

Figure 6.1

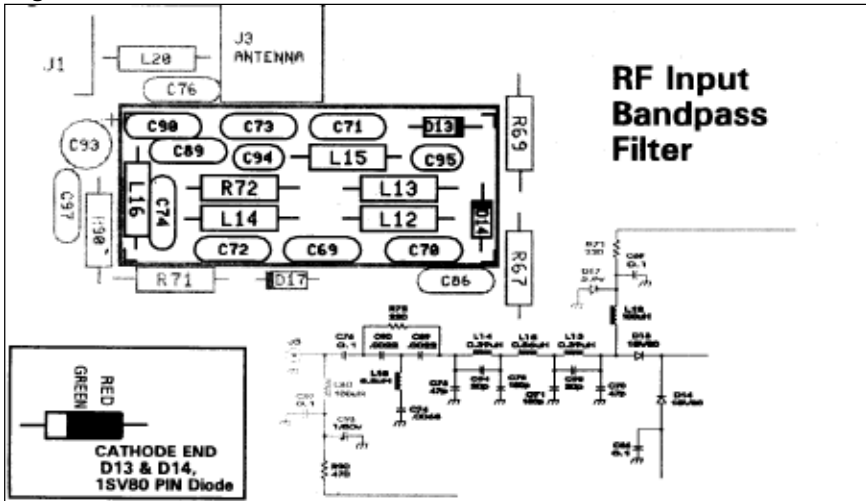

Install these mylar film capacitors:

- 6-1. Capacitor **C89, .0022 μ F** (marked 222).
- 6-2. Capacitor **C90, also .0022 μ F**.
- 6-3. Capacitor **C74, .0068 μ F** (marked **682**).

Install these ceramic disc capacitors:

- 6-4. Capacitor **C94, 20 pF**.
- 6-5. Capacitor **C95, 20 pF**.
- 6-6. Capacitor **C70, 47 pF**.
- 6-7 Capacitor **C73, 47 pF**.
- 6-8. Capacitor **C71, 180 pF** (marked 181).
- 6-9. Capacitor **C72, also 180 pF**.
- 6-10. Capacitor **C69, 0.1 μ F** (marked 104).

- 6-11. Install resistor **R72 220 ohms** (red-red-brown).

6-12. Carefully identify PIN diode D13, type BA479G (Black body, red cathode band, middle green band) and install with correct cathode polarity.

6-13. Install diode D14, also type BA479G per 6-12.

Install the following molded inductors:

- 6-14. **L13, 0.39 μ H** (orange-white-silver-gold).
- 6-15. **L14, also 0.39 μ H**.
- 6-16. **L15, 0.56 μ H** (green-blue-silver-gold)
- 6-17 **L16, 6.8 μ H** (blue-gray-gold-gold).
- 6-18. **L12, 100 μ H** (brown-black-brown-gold).

6-19. After carefully double-checking the parts just installed for correct values, install a shield enclosure, soldering all four mounting tabs. It is not necessary to bend these tabs before soldering. No top cover is used on this shield or on the 1st Mixer section to be built next.

REMINDER: Handle the board carefully to prevent damage to the mounting lugs of the Volume and Clarifier controls.

68. Shielded First Mixer Section

This circuitry will be enclosed within a shield just like the VCO's. Therefore, careful attention to correct parts selection is especially important. Figure 6.2 is provided for your convenience. The complete Phase 6.0 parts placement drawing is on page 58.

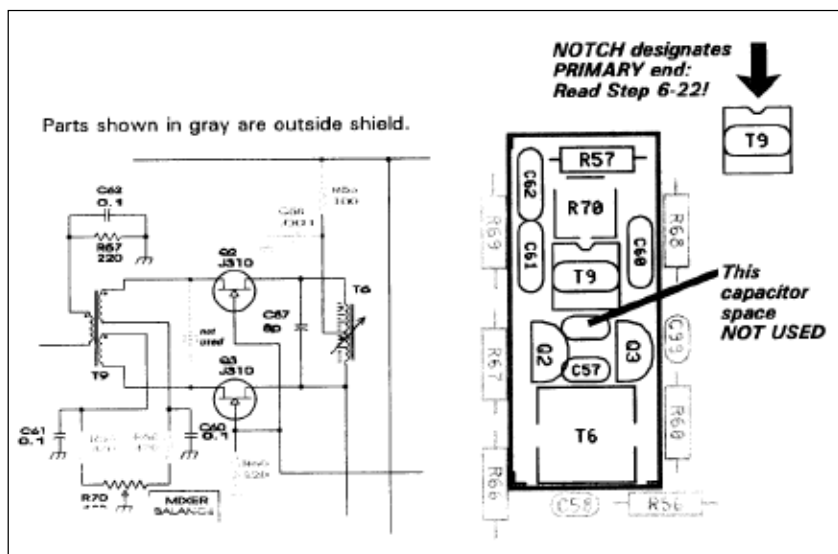

Figure 6.2

- 6-20. Install the **100 ohm trimmer potentiometer R70**. Be careful not to damage the mounting legs when inserting. Correctly installed, it is normal to have some space between the the board and the base of the trimmer.
- 6-21 . Install the **shielded adjustable coil T6**, similar in style but larger than the 455 kHz transformers installed in Phase 4.0.
- 6-22. Install **T9**, a pre-assembled **trifilar balun** transformer, with SIX pins, (identical to T4 and T5 installed in Phase 5.0). Notice carefully which end of the plastic base has the two copper-colored primary wires coming from the ferrite core over the base to two pins. **This transformer must be installed with this primary end nearest trimmer R70 as indicated by the notches in the board silkscreen and Figure 6.2.**
- 6-23. Install resistor **R57, 220 ohms** (red-red-brown).

Install the following ceramic disc capacitors:

- 6-24. Capacitor **C57, 8pF.**
- 6-25. Capacitor **C60, 0.1 μ F** (marked 104).
- 6-26. Capacitor **C61, also 0.1 μ F.**
- 6-27. Capacitor **C62, also 0.1 μ F.**

NOTE: There is an unlabeled outlined for a capacitor next to C57 which would serve as a shunt across trifilar balun T9. However, further engineering determined no capacitor is needed here, and this is the-only such "vacancy" on the entire 1254 circuit board.

- 6-28. Install transistor Q2, JFET type J310, being sure to orient the flat side as outlined.
- 6-29. Install transistor Q3, JFET type J310, being sure to orient the flat side as outlined

- 6-30. After carefully double-checking the parts just installed for correct values, install a shield enclosure, soldering all four mounting tabs. No top cover is used here.

Figure 6.2b

Alignment Preview

After Phase 6.0 is finished and panel/chassis sections installed, the Model 1254 is aligned simply by adjusting these coils for peak signal strength.

T6
T9
L10
T7

R70 is adjusted for minimum background noise at 300 kHz

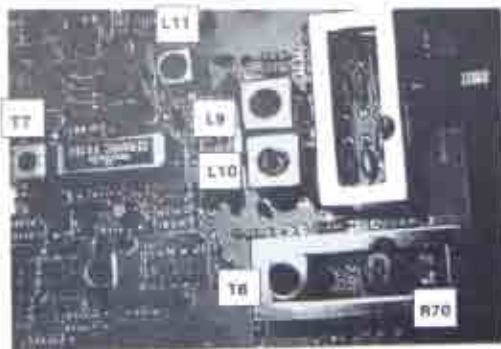

6C. Components Outside the Shielded Enclosures

Figure 6.3

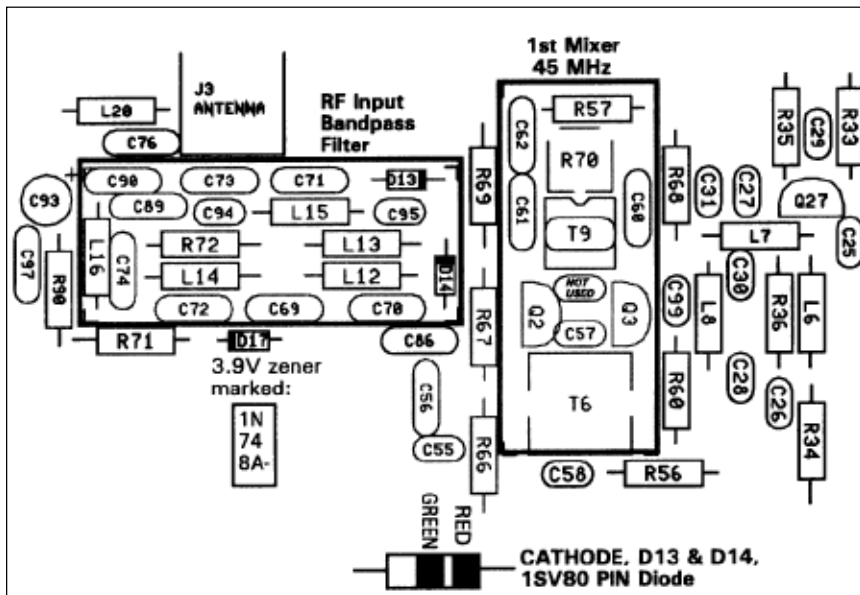

Install these 1/4-watt resistors:

- 6-31. Resistor **R34**, 47 ohms (yellow-violet-black).
- 6-32. Resistor **R35**, 100 ohms (brown-black-brown).
- 6-33. Resistor **R56**, also 100 ohms.
- 6-34a. Resistor **R36**, 220 ohms (red-red-brown).
-
- 6-35. Resistor **R71**, also 220 ohms.
- 6-36. Resistor **R68**, 470 ohms (yellow-violet-brown).
- 6-37. Resistor **R69**, also 470 ohms.
- 6-38. Resistor **R90**, also 470 ohms.
- 6-39. Resistor **R33**, 10K (brown-black-orange).

Install these ceramic disc capacitors:

- 6-40. Capacitor **C30**, 2 pF.
- 6-41. Capacitor **C27**, 10 pF.
- 6-42. Capacitor **C28**, 10 pF.
- 6-43. Capacitor **C31**, 18 pF.
- 6-44. Capacitor **C25**, .001 μ F (marked 102).
- 6-45. Capacitor **C26**, also .001 μ F.
- 6-46. Capacitor **C29**, also .001 μ F.
- 6-47. Capacitor **C58**, also .001 μ F.

Ceramic disc capacitors, cont.

- 6-48. Capacitor **C99, also .001 μ F.**
- 6-49. Capacitor **C76, 0.1 μ F** (marked 104).
- 6-50. Capacitor **C86, also 0.1 μ F.**
- 6-51. Capacitor **C97, also 0.1 μ F.**

- 6-52. Install **electrolytic** capacitor **C93, 1 μ F** with correct polarity.

- 6-53. Install 3.9v zener diode **D17 , type 1N748A.** (Review p. 62 if you have any question about identifying this diode.)

Install these molded inductors:

- 6-54. Coil **L8, 0.47 μ H** (yellow-violet-silver-gold.)
- 6-55. Coil **L7, 0.56 μ H** (green-blue-silver-gold.)
- 6-56. Coil **L6, 4.7 μ H** (yellow-violet-gold-gold.)
- 6-57. Coil **L20*, 100 μ H** (brown-black-brown-gold.)

*Note: L20 supplies DC voltage to the antenna jack to power a remote active antenna circuit. It is not essential to the receiver circuit and may be omitted.

- 6-58. Install transistor **Q27, JFET type J310.**

Please Read First

6-59. The RCA-type antenna jack J3 will be subjected to considerable stress over the life of the receiver as different connectors or adapters are used. Therefore, we recommend that its installation be as solid as possible, which means that it must be flush against the board with strong solder connections.

- 6-60. Install antenna jack J3 per 6-59. Make sure that solder flows generously around the pins and solder pads.

6-61. Your 1254 Receiver is "built," now needing only the adjustment of a few coils and the addition of cabinet hardware to make it useful and attractive. This remaining work should be pure fun, so we encourage you to take your time and enjoy the results.

☐ Phase 7.0

Final Assembly of Model 1254 Receiver

ALIGNMENT SUGGESTION:

The completed Model 1254 Receiver can indeed be fully aligned and tested NOW while still in "board form" before adding the front panel and other hardware. Doing it this way seems advisable ONLY if you have nagging doubts about a previous circuit phase test and if you feel the added hardware might interfere with testing and possible parts replacement in confined areas, especially near the front panel. However, if all previous "Progress Tests" have worked well for you, you'll probably prefer the satisfaction of doing the final checkout of a mostly-assembled receiver, nearly ready to use -- for real!

If you prefer the conservative approach, perform Step 7-1a, then perform all Final Alignment instructions in Part 7B. If all goes well, return to step 7-1b to continue Final Assembly.

☐ ☐ 7-1a. Plug the Display Board into the Main Board and secure both the Volume and Clarifier controls to the Display Board with the flat washers and mounting nuts supplied. Reconnect the Power Switch and Encoder Cables.

7A: Front Panel and Chassis Installation

Suggestion: Read over all the following panel assembly directions and see Figures 7.1 and 7.2 BEFORE starting. Also, you may wish to wrap the outer sides of the front panel with masking tape to prevent scuffing during further assembly.

☐ ☐ 7-1b. Lay the front panel face down on a protective cloth, and notice the 5 support posts for the mounting screws. Mounting the panel to the display board may be easier if you first "exercise" the 5 mounting holes in the posts simply by screwing in and removing a #4 self-tapping ("sheet metal") screw. Do this for each post.

☐ ☐ 7-2. Remove any knobs you may have attached to the display board controls.

☐ ☐ 7-3. Check all control and switch nuts for normal tightness.

- ❑ 7-4. Make sure none of the LED wires have been bent.
- ❑ 7-5. Set the display lens in position, making sure that the "AM-SSB" lettering is facing correctly. The lens is locked into place by carefully melting with your soldering tip the 6 molded posts inside the panel along the sides and bottom of the lens. (If you are reluctant to do it this way, you have the option of securing the lens to the panel with very small drops of contact cement at the edges.) Wipe the inside of the lens clean of any fingerprints.
- ❑ 7-6a. Glue the front panel headphone jack insert in place. This is a custom-molded washer-like plastic part. (The large hole in the front panel is designed to accept connectors of various types using the proper insert.) Use just a drop or two of any fast-drying glue such as contact cement dried properly on both surfaces. **Do not use "superglue" here -- there is too much risk of damaging the front panel surface.**

Figure 7.1

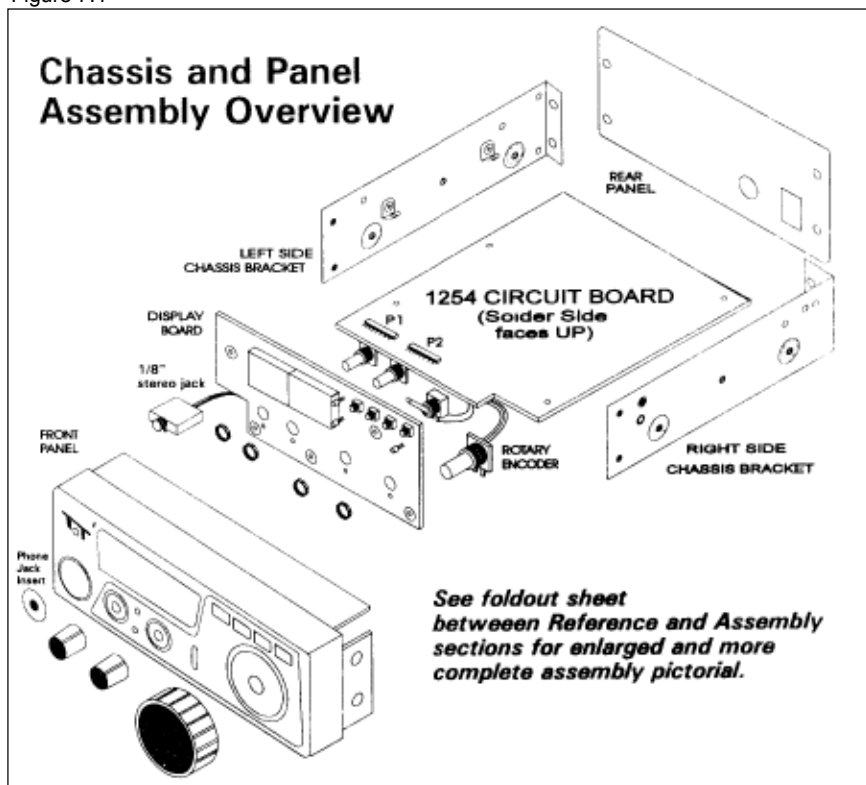

☐ ☐ 7-6b. Let the glue for the jack insert dry as needed. While you are waiting, we again encourage you to read the remaining instructions and study the drawings. Glue is also used to secure the TEN-TEC logo and to mount the speaker to its aluminum support shelf. You may wish to study those instructions and take care of those chores now.

☐ ☐ 7-7. Mount the 1/8" stereo jack (cable unplugged) to the panel hole created by the special insert. The body of the jack should be parallel to the top and bottom of the front panel. Tighten the jack's mounting nut very carefully to avoid scratching surrounding areas.

☐ ☐ 7-8. Press the four "key cap" buttons onto the button switches on the Display Board.

Table 7.1: SMALL HARDWARE PREVIEW

#	Description	P/N	Function
8	#4-40 1/4" screw, phillips [zinc]	60001	Circuit board mounting (4) Mount rear panel ends of chassis brackets (4)
4	#4-40 1/4" screw, phillips, [black]	60032	Mount top and bottom shells to chassis brackets in final assembly
8	#4-40 3/16" undercut ("counter-sink") screw	60080	Mount front panel to chassis ends (4) Mount Speaker/Battery shelf to chassis (4)
4	#4 split lockwasher	51058	Use between #60001 screws and top of board to mount circuit board.
5	#4 self-threading ("sheet metal") screw	65009	Mount Display Board to front panel

NOTE: a #4-40 screw, phillips, #4 internal tooth lock washer, and #4-40 hex nut were included in the Semiconductor package and should have been used already to mount Voltage Regulator U10.

☐ ☐ 7-9. Keeping a #4 self-threading screw and small screwdriver handy, fit the panel to the display board, gently guiding the SPEED LED as needed. While holding everything together, install the screw in the center mounting hole near the Clarifier control.

☐ ☐ 7-10. Install additional #4 self-threading screws in the other four mounting holes in whatever order is most convenient.

- □ 7-11. Tighten all 5 Display Board mounting screws.
- □ 7-12. Install the the Volume and Clarifier control knobs. Before tightening the setscrews, line up the index stripes correctly in reference to the silkscreened dot markings on the panel.
- □ 7-13. The large Tuning knob can be mounted to the encoder shaft in any way convenient to you. Allow enough clearance so the back of the knob does not scrape against the panel.

Figure 7.2

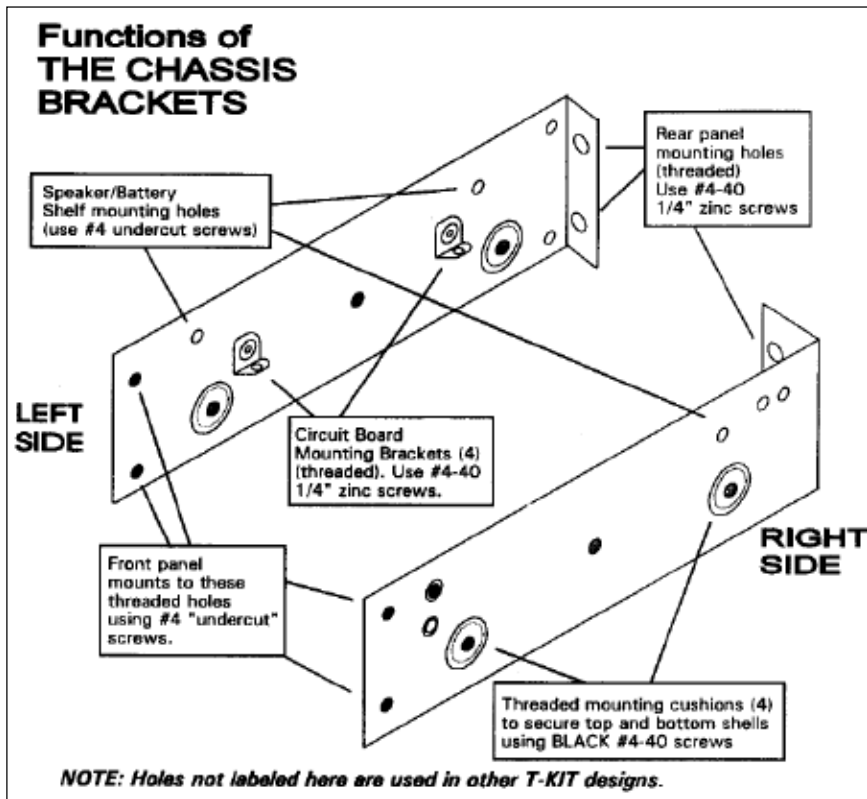

- □ 7-14. Attach the Left Side chassis panel bracket to the circuit board using two 1/4" #4-40 screws and two #4 lock washers.
- □ 7-15. Secure the front panel to the left side panel using two #4-40 undercut screws.

- ☐ ☐ 7-16. Mount the RIGHT side panel to the board using two 1/4" #4-40 screws and two #4 lock washers.
- ☐ ☐ 7-17. Secure the front panel to the right side panel using two #4-40 undercut screws.
- ☐ ☐ 7-18. Mount the rear panel to the ends of the two side panels, using four 1/4" #4-40 screws.
- ☐ ☐ 7-19. Set the VCO-1 shield enclosure in place on the top side of the board.
- ☐ ☐ 7-20. While holding the shield in place, solder all four mounting legs on the bottom side, leaving them straight (i.e., there is no need to bend them). Use a minimal amount of solder to get good connections to the groundplane.
- ☐ ☐ 7-21 . Set the VCO-2 shield enclosure in place on the top side of the board and solder the mounting legs as for VCO-1.
- ☐ ☐ 7-22. **The following procedure is OPTIONAL but is suggested if the primary use of your receiver will be vehicle-mounted.**
To assure maximum VCO stability, you can do exactly what we do in factory-built equipment. Use a hot-melt glue gun to flow glue liberally around the outside of each VCO coil. it's OK if glue also covers some of the nearby parts. The idea is to increase the body weight and mass of the coil itself , further securing it to the board. Be sure not to get any glue inside the coil, which would interfere with any further adjustment. Again, this procedure is NOT NECESSARY for ordinary receiver operation.
- ☐ ☐ 7-23a. Set the VCO-1 top cover in place so that L3 remains accessible through the hole. Solder the cover to the main shield. Soldering each of the 4 corners is sufficient.
- ☐ ☐ 7-23b. Install the VCO-2 top cover per 7-23.
- ☐ ☐ 7-24. Reconnect the headphone jack cable to J6 and be sure that the Power Switch and Encoder cables are plugged in.

7B: Model 1254 Receiver Alignment

- ☐ ☐ 7-25. Reconnect DC power and turn on the receiver. Connect your DC voltmeter to the VCO test point and ground as you did in Phase 2.0.
- ☐ ☐ 7-26. Turn on the receiver and tune to 100 kHz.

7-27. If needed, re-adjust L3 for a VCO voltage of 2.5 volts DC at 100 kHz. As you observed in Phase 3.0, increasing the frequency will increase the VCO voltage to a maximum of about 8.0 volts at 13.2 MHz.

7-28. If needed, re-adjust L2 for a VCO voltage of 2.5 volts DC at 13.240 MHz. As you observed in Phase 3.0, increasing the frequency will increase the VCO voltage to a maximum of about 8.0 volts at 30.000 MHz.

7-29. Connect an antenna to the receiver and tune anywhere between 5 and 15 MHz where your own experience would expect to find signals at this time of day or night. If shortwave is new to you, tune between 8 and 15 MHz during daylight and between 5 and 10 MHz at night.

7-30. Tune in any signal, any mode, which you would like to use as a test signal. Choose one you can hear well enough, but not too strong.

7-31. Adjust the following coils for maximum signal strength

T6 **L9** **L10** **L11** **T7**

7-32. In AM Mode, tune in the strongest WWV signal for the time of day and your location, most typically at 5, 10, 15 or 20 MHz. Make sure the display indicates the WWV exactly, such as 15.000.0 MHz. Follow this procedure to set trimmer capacitor C2 correctly (3.58 MHz synthesizer clock):

- TOOL: jeweler's screwdriver or alignment tool
- Select SSB Mode
- Set the Clarifier control to its midpoint or 12:00 position
- Slowly rotate trimmer C2 until the carrier tone {whistle} of WWV is at lowest musical pitch ("null").
- Rotating the Clarifier control in either direction should result in a higher pitch sound of the WWV carrier.

7-33. Use FAST Tuning to go down to 300 kHz and select SSB mode. Adjust trimmer potentiometer R70 for lowest background noise level.

7-34. At this stage of receiver completion, no useful adjustment of 455 kHz transformers T2 and T3 makes any performance difference. If you noted any signal strength increase during Phase 4.0 tests, let those settings stand. Otherwise, just set the T2 and T3 slugs about one turn below being flush with the top of the coil form.

- 7-35. Turn off and disconnect DC power.

7C: Final Assembly Procedure

- 7-36. With the bracket ends of the speaker facing down, set the speaker in its mounting hole. If you wish, pencil a circle around the outer rim to indicate gluing area.
- 7-37. Use any glue which you like working with to secure the speaker to the shelf. ("Super glue" is NOT at all useful for this procedure") We suggest contact cement, coating both surfaces, because it is commonly available, very handy for other jobs and fast-drying. A bit of silicone caulk also can be used. While you are waiting for the glue to dry, there are other little things that can be done.
- 7-38. Mount the four self-adhesive rubber bumper feet to the bottom cabinet shell.
- 7-39. Recheck all screws for reasonable tightness.
- 7-40. With considerable pride, attach the TEN-TEC logo to the front panel in the corner above the microphone jack. Use a bit of contact cement on the back of the logos and between the two mounting holes. DO NOT USE SUPERGLUE: discoloration or other damage may result.
- 7-41. The 9-volt memory backup battery is secured to the underside of the speaker shelf, using several turns of electrical tape through the slots.
- 7-42. Solder the battery snap wires with correct (+ red) (-black) polarity. These wires are installed on the solder trace side of the board and may be soldered on either side of the board.
- 7-43. Plug in the speaker cable to J5 and mount the speaker shelf to the side panels using four #4-40 undercut screws.
- 7-44. Recheck that the power switch, headphone jack and encoder cables are plugged in securely.
- 7-45. Set the receiver into the bottom shell, noting that the front of the shell is the end with no folded seam.

☐ ☐ 7-46. Place the top shell in position and complete the assembly with the four black #4-40 screws, Note that the screws go through both cabinet sections into the side chassis panels for excellent mechanical durability.

**This completes construction
of the T-KIT Model 1254 SWL Receiver.
We thank you very much for
your trust in T-KIT products by TEN-TEC!**

***See REFERENCE SECTION,
Part III of this Manual,
For all Model 1254 Operating Instructions,
Discussion of features
And troubleshooting guide***



This space is for your notes

**Section 3:
REFERENCE INFORMATION
for T-KIT Model No. 1254**

**SSB-CW-AM
Microprocessor-Controlled
100 kHz - 30 MHz Receiver**

Specifications: T-KIT Model 1254	2
Model 1254 Operating Instructions	
1. Functions of Primary Controls	3
2. Tuning AM signals	3
3. Storing Frequencies in Memory	4
4. Recalling or Tuning Memory Frequencies	4
5. Tuning SSB signals	5
6. Tuning CW signals	5
7. Microprocessor RESET	5
8. Memory Battery Test	5
Circuit Description	6-14
Block Diagram	8
Practical Information for Receiver Use	
Connecting Antennas	15-18
"Active Antenna" Notes	17
DC Power Supply Considerations	19
"Mobile SWLing"	20
External Audio Connections	21
Receiving Digital/SSTV modes	21
SWL basics and Communications Applications	22
Beyond 30 MHz . . . and Below 100 kHz	23
Terms & Abbreviations	24-28
Component Reference Index	28-35
Troubleshooting Guide	36-38
Chart of Significant Voltages	38
Modification Notes	39
Checking for Solder Bridges: (right-reading view of solder-trace side, main board)	40

Model 1254 Receiver Specifications and Features

- **Frequency coverage:** 100 kHz to 30 MHz
- **Modes:** AM, SSB/CW
- **Main Tuning:** Normal or Fast tuning (2.5 kHz SSB, 5.0 kHz AM, or 100 kHz steps for either mode)
- **"Clarifier" Control:** for ± 1.5 kHz SSB/CW fine tuning between 2.5 kHz steps.
- **Front panel controls:** On/off switch, Tuning, Volume, Clarifier, Mode Select, Memory Write (MW), VFO/Memory tuning select (V/M), Tuning Rate Select (SPEED)
- **Memories:** 15 programmable memories
- **Circuit:** Synthesized 45-75 MHz local oscillator
- 45 MHz first I-F, 455 kHz second I-F
- **Sensitivity:** AM mode: 2.5 μ V for 10 dB SNR at 30% modulation
SSB/CW mode: 0.5 μ V for 10 dB SNR
- **Selectivity:** 4 kHz @ -6 dB
- **Frequency/Memory Display:** 6-digit green LED with mode indicators

- **Power supply:** 12-15 VDC, 250 mA current consumption with no signal present; 15VDC @ 800 mA wall transformer supply included with kit.
- **Antenna connector:** 50 ohm input, RCA-style phono jack
- **Audio:** 1.5 watts audio output to internal speaker, plus 1/8" stereo phone jack for standard personal headphones or direct feed to 4-8 ohm external speaker, data interface or both.
- **Semiconductors:** 10 IC's, 26 transistors, 16 diodes
- **Compact Size:** 2.25" x 6.5" x 6.5" (HWD)
- **Construction:** Steel clamshell case, aluminum chassis, custom-molded front panel.



Model 1254 Receiver Operating Instructions

1. Control Functions

The **TUNE** control performs two functions:

- Direct frequency tuning
- Memory Tuning (Memories 01 through 15)

The **VOLUME** control sets the receiver audio gain.

The **CLARIFIER** control permits fine-tuning of SSB and CW signals within the 2.5 kHz tuning steps in SSB mode.

The **POWER** switch simply turns on the receiver on and off .

The **[MODE]** pushbutton selects between AM and CW-SSB reception modes. The current mode is always shown in the frequency display window.

The **[MW]** ("Memory write") button stores the current frequency and reception mode in any memory location you choose. See "storing Frequencies in Memory" for detailed instructions.

The **[V/M]** switch toggles between Frequency Tuning ("VFO") and Memory Tuning. See "Tuning Mode Indicator" below. When [V/M] is in Memory Tune mode, the Tuning Control is used to select the desired memory.

The **Tuning Mode Indicator** is the LED decimal point to the right of the last digit of the display. It is ON for direct frequency tuning and OFF for memory tuning.

The **[SPEED]** button toggles the [FAST] 100 kHz step tuning mode on and off as indicated by the FAST LED indicator.

2. Tuning AM Signals

Set the Clarifer control to its 12:00 position. Select AM with the [MODE] button. The receiver will tune in 5 kHz steps unless [FAST] 100 kHz tuning is selected. Adjusting the Clarifier control may have a slight effect on signal quality but this control is intended primarily for SSB-CW fine tuning.

3. Storing Frequencies in Memory

To place the currently displayed frequency and reception mode in memory, do the following:

- Press **[MW]**: the most-recently addressed memory location will be displayed.
- Rotate the TUNE control to the memory you wish to use, either an empty location or to replace an unneeded frequency.
- Press **[MW]** again to store the frequency and return the receiver to normal tuning mode.

4. Recalling and Tuning Memory Frequencies

To scroll through or listen to the frequencies in memory:

- Press **[V/M]** to enter Memory Tune mode as indicated by the Tuning Mode Indicator being toggled OFF by.
- Rotate the tuning knob to select a memory location. The display will momentarily indicate the location, then display the stored frequency and reception mode.
- Press **[V/M]** again to exit the memory tune mode and return to the original VFO frequency

Figure 1R: Model 1254 Display and Mode Selection

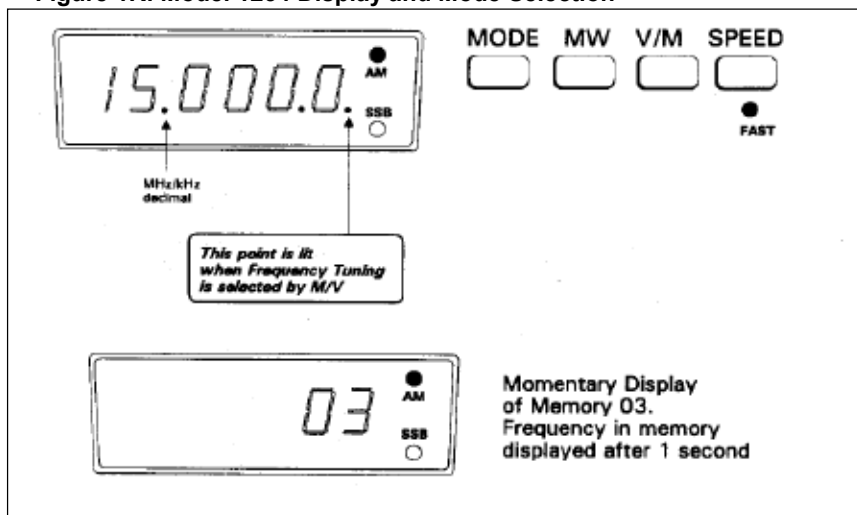

5. Tuning SSB Signals

Set the Clarifier control to its 12:00 position. Select SSB Mode and tune to a signal of interest. Use the Clarifier control to adjust for intelligible voice audio. Tune up (clockwise) for USB signals and down for LSB signals. If you are tuning the Clarifier clockwise and the signal still seems "out of reach," turn the Main Tuning one step higher and then re-tune the desired signal. Similarly, if you are tuning lower, then turn Main Tuning one step lower.

6. Tuning CW and RTTY/Data Signals

Set the Clarifier control to its 12:00 position. Select SSB Mode and tune to a signal of interest. Use the Clarifier control to adjust for desired audio pitch. If you are tuning the Clarifier clockwise and the signal still seems "out of reach," turn the Main Tuning one step higher and then re-tune the desired signal with the Clarifier. Similarly, if you are tuning lower, turn Main Tuning one step lower"

7. Microprocessor RESET

A "power-on reset" is a quick way to clear all the memories. This procedure can also be used to recover from fault conditions caused perhaps by power supply line noise. The symptom or evidence that something is not right with the microprocessor can be an unusual or blank frequency display or locked-up tuning. To RESET the microprocessor, do the following:

- Turn off the front panel DC power switch
- Press and hold down both [MODE] and [MW]
- Turn ON the power switch
- Release [MODE] and [MW] pushbuttons
- Expect to see the 15.000 MHz default display
- Reprogram the memory channels as desired

8. Memory Battery Test

At intervals comfortable to you, at least once a year, check the condition of the memory backup battery with your VOM/DVM or a reliable battery tester. To preserve stored memories, the battery removal, test and replacement should be done (carefully!) while the receiver is TURNED ON.

Model 1254 Receiver Circuit Description

Before we begin a stage by stage description of the circuitry in this receiver, let's take a broader view of how shortwave receivers are designed in general. This should help show how signals actually make their way from the antenna to the speaker.

Depending on their intended function, radio receivers can be designed using several different electronic architectures. Very simple receivers can be built from kits or your own parts using classic autodyne, TRF, regenerative or direct-conversion designs. Such receiver projects continue to provide the fun of discovering how radio originated and how simple it can be.

However, the most common approach used in shortwave receivers is called the superheterodyne method, usually referred to as "superhet." In this approach, incoming signals from the antenna are translated in frequency by a special stage of circuitry called a mixer. A radio frequency (RF) mixer is essentially a high speed switching circuit that combines the incoming signals with a local oscillator (LO) which is generated within the receiver.

This mixing process results in a frequency conversion to an Intermediate Frequency (IF). A superhet receiver typically may be single, double or triple conversion: the Model 1254 is a double-conversion receiver with a 45 MHz first IF and a 455 kHz second IF.

The simple receiver most closely related to the superhet is the direct conversion design in which a variable LO is mixed with incoming signals from the antenna. The resulting "IF" is in the audio spectrum range and is amplified directly for listening.

The local oscillator must be a very clean and stable sinewave because any undesirable characteristics on this signal would be transferred to the received signal by the mixing process. Most modern receivers use a "synthesizer" to generate this signal. The synthesizer circuit is able to tune the local oscillator in very accurate steps and also hold the oscillator on frequency with very little drift.

Mathematically, the mixer multiplies the instantaneous values of the LO and the input together. The result is a pair of output bands that are the sum and difference, in frequency, of the input and the LO. The LO frequency range is chosen so that one of these bands can be separated out for further amplification and

processing. This is illustrated with some example spectrum plots in Figure 2R.

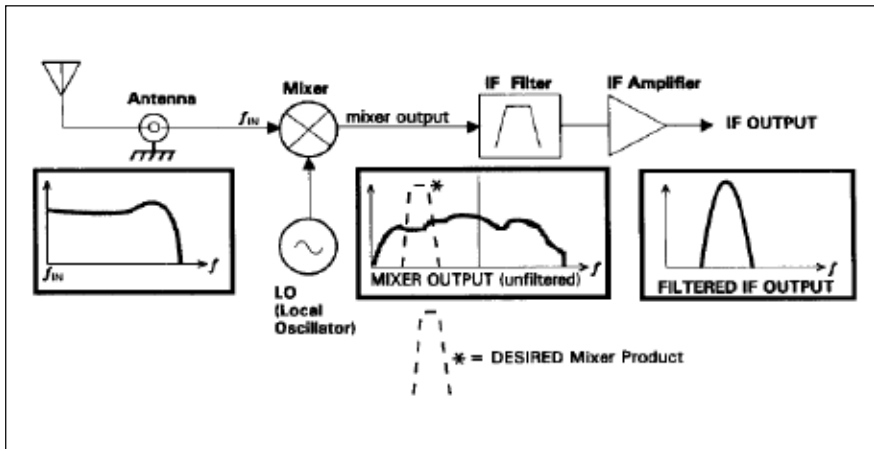

Fig. 2R: Spectrum Plot examples

The stage of selectivity and gain that follows the mixer is called the intermediate frequency (IF) amplifier. Notice how the position of the local oscillator determines which part of the incoming spectrum falls within the bandwidth of the IF amplifier. As the LO is tuned, individual signals can be separated out for amplification and detection.

The typical receiver will use at least two mixers and two of these intermediate frequency stages to convert an incoming signal down to audio. The desired tuning range of the receiver and the availability of certain standard filter frequencies is usually what determines the selection of the IF frequencies.

Let's now study the Block Diagram of the Model 1254 receiver shown in Figure 3R. We will follow the signal path from antenna to speaker, and explain the reasoning behind the design of each stage.

Figure 3R: Model 1254 Block Diagram

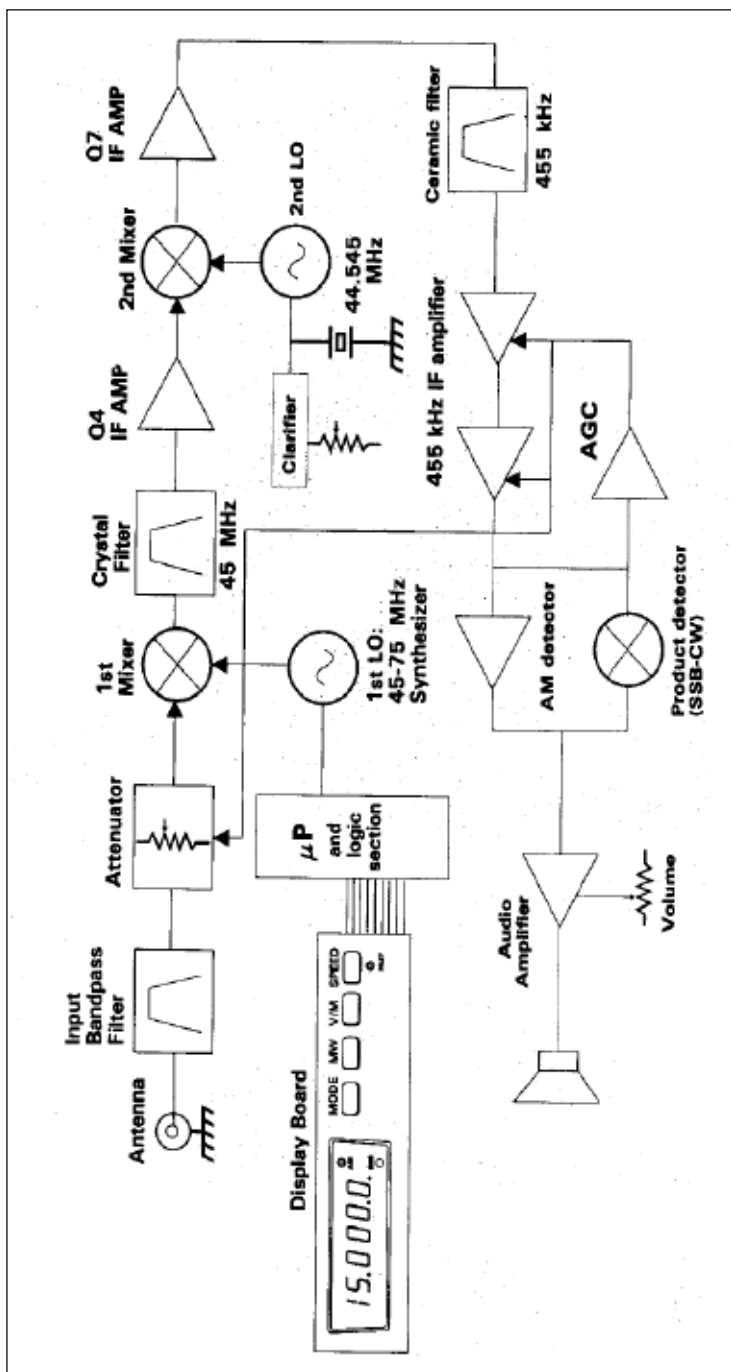

The first stage in the Model 1254 is an input bandpass filter. Since we are not interested in signals beyond the 0.100 to 30 MHz tuning range of the receiver, this filter protects the mixer from energy outside this range. In particular, the filter must suppress any energy that occurs at the first IF frequency- We would not want input signals at the IF frequency leaking-past the first mixer and directly into the IF amplifier. The ability of a receiver to ignore an input at its first IF frequency is called "IF rejection". The 1254 has an IF rejection of about 40 dB which means it takes an input 40 dB greater (a factor of ten thousand in power) than the basic sensitivity to produce an equivalent volume in the speaker.

This filter must also suppress what is called the "image response" of the receiver. This image occurs because for a given LO frequency there will always be two input frequencies that convert to the IF. Lets take an example that would apply to this design. Lets say that you have tuned to the WWW broadcast at 15.000 MHz. The LO generated by the receiver to tune this frequency would be 60.000 MHz so that the difference product from the mixer falls at the first IF frequency of 45 MHz. There is another input frequency however, 105.000 MHz, that would also create a difference of 45 MHz. This is the image response that must be controlled by the input filter. Good image rejection in this receiver is especially important since the image occurs in the FM broadcast band where there will be some rather strong signals. The image rejection in the 1254 is typically 70 dB.

The 1254 also has a variable attenuator ahead of the first mixer. The purpose of this stage is to limit the peak-to-peak amplitude of AM signals once they have been tuned in. Because the information on an AM signal is contained in the shape of its modulated envelope we don't want these signals to be so large that they saturate any of the receiver stages. This would cause clipping of the waveform and result in distorted audio.

The variable attenuator uses a couple of special "PIN" diodes. These devices, D13 and D14 in the schematic, are designed to exhibit a variable resistance to RF signals depending on the DC current that flows through the diode junction. The bias current for these diodes comes from the AGC (Automatic Gain Control) circuitry further down the receive signal path. This circuit continuously measures the strength of the received signal and adjusts the overall gain of the receiver to keep the audio volume relatively constant. If a received signal is especially strong, the AGC will activate the attenuator to keep the amplitude within a range that the receiver can handle.

This brings us to the first mixer stage which is made up of JFET transistors Q2 and Q3 and transformers T6 and T9. This circuit takes an incoming signal and combines it with the local oscillator to create a replica that is shifted up to the first IF frequency of 45.000 MHz. The output of the mixer feeds a crystal bandpass filter, FL1. The bandwidth of this filter is about 15 kHz. This is actually much wider than is really necessary for shortwave reception but it is about the minimum bandwidth that can be achieved with this type of low cost filter. The output of the filter is amplified by transistor Q4. This is a dual-gate MOSFET stage and was chosen because the input impedance is very high and provides a good impedance match for the filter. The frequency response of the crystal filter is very dependent on impedance matching so we have included adjustments, L9 and L10, to optimize the shape of the filter.

The next stage is the second mixer. There are several good reasons to make this second frequency conversion. First, we must get our desired signal down to a frequency where it will be easy, and inexpensive, to further filter and amplify. There is a type of filter component based on ceramic resonant circuits that is widely available at 455 kHz. It makes sense to take advantage of these parts to accomplish the narrow filtering we need for AM and sideband reception. Furthermore, we still need a lot of voltage gain to get weak radio signals up to a level that will be easy to demodulate and gain is easier to accomplish at a lower frequency. We also use this second conversion to provide fine tuning. Since the first LO is synthesized and can only tune in discreet 2.5 kHz steps, we've added a clarifier adjustment on the second LO to fill in between the steps. This is not so important on AM mode but it is on sideband. Proper sideband reception requires that the receiver be tuned exactly to the frequency that recreates the original harmonic relationships in the transmitted voice.

The second mixer is built with the widely used "diode ring" circuit. In this approach, a strong local oscillator signal supplies the drive to alternately switch four diodes, D10-D11 and D15-D16, on and off. This switching action, together with the phasing of the two transformers, T4 and T5, causes the input signal and LO to be multiplied together. For this stage we have chosen an LO frequency of 44.545 MHz so that the difference product between the first IF and this second LO will occur at 455 kHz.

The second local oscillator is crystal controlled. This Colpitts type oscillator circuit is built around transistor Q6. The other transistor, Q5, acts as a buffer amplifier to boost the output up

to a level sufficient to drive the diodes. A variable capacitance diode, "varactor", in series with the crystal gives this oscillator approximately ± 1.5 kHz of adjustment range for fine tuning. This varicap device exhibits a variable capacitance depending on the reverse bias voltage from the front panel clarifier control.

The output of the second mixer, at 455 kHz, feeds a grounded gate JFET amplifier, Q7. This stage provides a proper impedance termination for the mixer and adds a little gain before the ceramic filter FL2. The frequency response of this filter is what determines the selectivity of the receiver. We have chosen a 4 kHz bandwidth to provide good audio response for AM broadcast and also good selectivity for single sideband signals.

Two IF amplifiers, U8 and U9, follow the filter and provide most of the gain in the entire receiver. There are several reasons for placing this amplification behind the narrow filter and it is common practice to do this. First, the receiver does not waste effort amplifying signals that you have not tuned in and that could overload high gain stages. It also allows the inclusion of an Automatic Gain Control (AGC) that regulates the volume of the received signal in the speaker. Because the signal strength between one radio signal and the next can vary over such a wide range, receivers need some system to level the output volume as you tune across the band. These IF amplifiers have a gain setting input pin that allows this feature.

The amplified IF signal from transformer T3 feeds an AGC rectifier circuit made up of Q9, Q10 and Q11. These transistors provide a feedback voltage to the gain setting pin of the IF amplifiers and to the front end attenuator. This feedback action holds the IF output constant over nearly a 100 dB range of input signal strength. The reaction time of the AGC allows it to quickly reduce the gain, so that strong signals don't cause a sudden burst of audio. The release is slower however, so that the background noise is not constantly jumping around as signals come and go.

There are two types of demodulators connected to the IF output. For AM signals, an envelope detector, 08, is used to extract the audio waveform. This is simply a halfwave rectifier built from a transistor that is biased up just to the point of conduction. This technique extends the sensitivity of the detector by eliminating the usual 0.75 VDC voltage drop that would occur with a plain diode detector.

Sideband or CW reception requires a more complex type of demodulator called a product detector. This stage is similar to a

mixer except that the output occurs directly at audio frequencies. The IC mixer circuit U7 is ideal for this stage. It contains both the mixer and a built in oscillator for generating the LO. A ceramic resonator, Y2, sets the frequency of the LO directly in the center of the second IF filter response. This allows the detector to demodulate both upper and lower sideband signals.

The outputs of the two detectors are summed together but only one is activated at a time by the microprocessor. They are selected according to the mode of reception. An audio amplifier IC, U8, boosts the low level audio signal to drive the built-in speaker. A DC-controlled volume pin on the audio amplifier is used to set the output volume.

The remaining circuitry in this receiver lies outside of the main signal path. This includes the microprocessor, the display driver and the phase locked loop chip that runs the synthesizer. Most operations of the receiver are controlled by pre-programmed software instructions executed by the PIC16C57 microprocessor, U2. This processor is an OTP ("one-time-programmable") version of the Microchip Technology PIC series of CMOS micro-controllers. The device's 2K ROM is permanently programmed at TEN-TEC with the instruction code to run the receiver's numerous features and the chip's 80 byte RAM provides room to store 15 frequencies.

Notice on the schematic that there are a few extra components forming support circuitry for the processor. Transistor Q14 monitors the power supply voltage and signals the processor when power has been turned off. This advanced warning allows the processor to store the current operating frequency and enter a low current sleep mode. This routine only takes a few microseconds so the processor is already in standby mode by the time the supply voltage begins to drop. At this point, the nine volt battery takes over and supplies the back up voltage to preserve the memories. Another transistor, Q13, generates the wake-up command. When power is switched on, the processor receives a "Master Clear" pulse. This signals the processor to recall the last used frequency and mode so that it is ready to operate. Other connections to the processor include two lines from the tuning encoder, several lines to the display driver chips U4 and U5, and a clock signal that is provided by the synthesizer IC U3.

The frequency display in this receiver is multiplexed to reduce power consumption and lower the number of connections between the display and processor. Multiplexing means that

only one digit is actually lit at a time. The processor continuously scans through all six digits very rapidly however so they appear to be lit simultaneously. As each digit is enabled by the high current driver IC U5, the processor feeds a BCD output to the 7 segment decoder U4. This chip then lights the individual segments needed to form each number. A separate transistor, Q12, operates the decimal point.

Let's go back now and discuss the details of generating the first LO signal. As we have mentioned, this oscillator is phase-locked for accuracy and stability. The circuitry responsible for this task is mostly contained in the phase-locked-loop chip U3. This IC contains a reference crystal oscillator, programmable dividers and phase detector. The major sections of the synthesizer are shown in block diagram form in Figure 4R.

Fig. 4R: Synthesizer Block Diagram

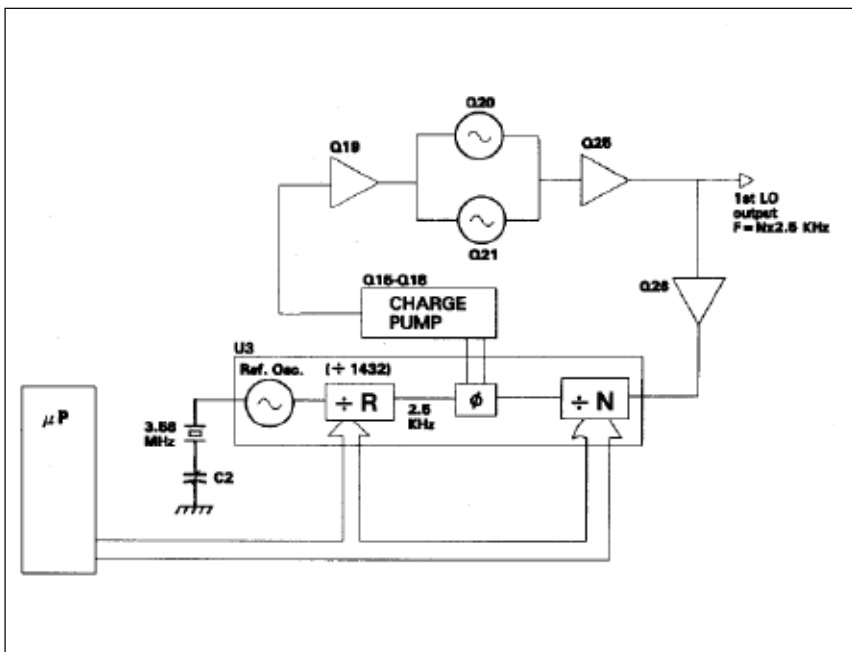

The reference oscillator determines the overall accuracy of the receiver and for this reason we have included a trimmer capacitor, C2, for setting this frequency. Specifically, we are using a 3.579545 MHz crystal which is a standard part used in television sets. The trimmer is used to set the crystal slightly off frequency, to 3.580 MHz. The oscillator is then divided down by a factor of 1432 to provide a 2.500 kHz signal to one side of

the phase detector. This division ratio is programmed into the reference divider at power on and sets the size of the tuning steps.

The other input to the phase detector comes from a second divider that monitors the LO output. Its division ratio depends on the receiver frequency and is automatically updated by the processor as the receiver is tuned up or down. The phase detector compares the two inputs and generates a correction pulse that controls a network of four transistors, Q15-Q18. This circuit then outputs a DC voltage that is filtered and applied back to two voltage controlled oscillators (VCO's).

The required first LO tuning range of 45.100 MHz to 75.000 MHz is fairly wide, so we use two oscillators, Q20 and Q21, to cover this range. The oscillators use varactor diodes D2 and D8, that resonate with a tuning coil that is adjusted once during alignment. The filtered DC voltage from the charge pump is applied to the varicaps and determines the output frequency of the oscillator. This voltage control feature is what allows the phase locked loop to move and hold the oscillators onto the desired frequency.

Let's say that one of the oscillators has tried to drift off frequency slightly or that the tuning knob has been moved one step. In either case, there is suddenly a frequency difference between the two inputs to the phase detector. This causes an output to the charge pump telling it to adjust the tuning voltage to the oscillator either up or down depending on the direction of the error. The new tuning voltage brings the frequency back to a value that reestablishes equilibrium at the phase detector. These adjustments occur at a rate equal to the step size. In our case that means 2500 times a second. It is this constant feedback action that holds the output of the LO steady.

RF Input Circuit note: L30, C97, C93 and R90 supply DC voltage to antenna jack J3, to permit powering of external "active antenna" circuitry (optional).

CONNECTING ANTENNAS

The Model 1254 receiver is designed to work best with 50-ohm antennas resonant at the desired receiving frequency. In practice, a wide variety of antenna designs, both indoor and outdoor, will give good results. Receive-only antennas may be modeled on various ham radio transmit designs but may be constructed with lighter, less expensive materials such as hookup wire and TV/VCR coax or even lightweight shielded audio cable.

IMPORTANT: We recommend that ANY antenna used for the Model 1254 be coax-fed and located at least 15 feet away from the receiver. Antennas located too close to the receiver will pick up harmonics of the LED display multiplexing. This may be especially true in the case of "active" antennas.

The best results will be obtained with outdoor antennas which are located away from noise Sources such as fluorescent lights, dimmers, computer devices, power lines and motors. Directional loop antennas may be of interest for optimum reception at lower frequencies (100 kHz through 4 MHz.)

In designing any antenna, be aware that a low-current voltage (about 4 VDC) is present at the receiver's antenna input jack for the purpose of powering an external active antenna, as discussed on. This voltage is not dangerous, and the receiver cannot be damaged even if the antenna input is shorted directly to ground, as in the case of many loop antenna designs.

CAUTION 1:

**Use care and common sense when putting up outdoor antennas.
Be certain that your wires, antenna or ladder
cannot come into contact with electrical power lines.
You can be KILLED by accidental contact with power lines.**

CAUTION 2:

**Outdoor antennas should include some form of
LIGHTNING PROTECTION.
Disconnect and ground your antennas when not in use
or when you think a thunderstorm is developing.
Even indirect strikes or static electricity buildup on your antenna
can cause damage to your receiver**

Antenna Resources for Beginners:

Antenna experimentation, design and maintenance are at the heart of the hobby of ham radio. Experienced hams or avid SWL's in your own town are probably the best resource for help in planning and putting up a SWL antenna suitable for your particular residence. Useful information may also be found in these publications:

ARRL Handbook for Radio Amateurs (any edition)

ARRL Antenna Handbook (any edition)

Antennas.' Selection and Installation (RadioShack™ No. 62-1083)

Listening to Shortwave Radio (RadioShack™ No. 62-1021).

Internet: Enter "SWL Antenna" in any major search engine (Alta Vista, Yahoo, etc.) and see what's new. There's plenty there.

If you still are wondering what might make a good and safe first antenna (outdoor) for your new SWL hobby, you won't be disappointed with the simple design illustrated in Figure 5R. Essentially it is an end-fed random wire with earth ground connected to the coax shield. If the wire slopes down from its feed point (such as a roof peak or balcony) to a fence or other support, it could be called some form of "Sloper," a style of antenna popular with hams. The purpose of the recommended switching is to provide a convenient way to short the antenna directly to ground for lightning protection. The switch should be conveniently located: even an inexpensive household wiring switch in a utility box may be used.

Figure 5R: A simple outdoor SWL antenna

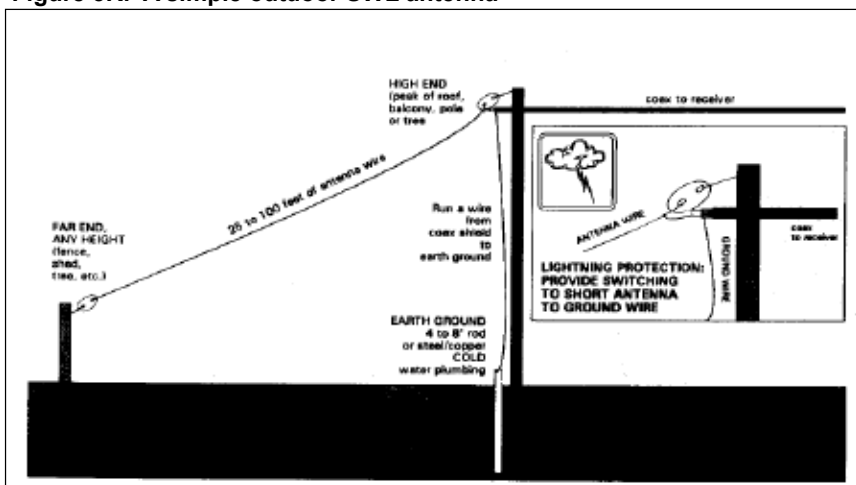

"Active" Antennas

As already mentioned, any antenna should be located as far away from the receiver as possible to minimize multiplexing interference generated by the receiver itself. This applies especially to "active" antenna devices, both commercially-designed and homemade.

The least expensive active antenna on the market is the T-KIT Model 1552, a module board kit supplied without enclosure or telescoping whip. Its performance compares very favorably with all commercial and kit models currently available. For reasons already explained, we recommend against mounting the Model 1552 board inside the receiver case. The Model 1552 Active Antenna may be powered a 9 volt battery OR by the DC voltage available at the Model 1254 antenna input.

To use the Model 1552 with this receiver, we suggest:

1. Build up the Model 1552 board per its instructions. Install the 9 volt battery snap in series with a switch if you intend to use a battery. If not, solder a jumper wire from the pad marked " + 12VDC" to the pad marked "TO RECEIVER" common to C3.
2. If you wish to power the 1552 from the Model 1254 receiver, be sure that L20 is installed per Step 6-57 and that a shielded cable is used for interconnection, with reliable grounding at both ends.
3. Use your meter to confirm that the 1552 is getting DC voltage from the 1254, which will read about 8 volts with the 1552 gain control turned down, and about 3 volts with the gain control fully clockwise.
4. Mount the board with whip antenna into the intended enclosure with at least 15 feet of shielded cable for connecting to the receiver.

Active antennas are fun for experimenting and can be convenient for casual reception of strong signals when traveling. However, receiving weaker signals simply requires more antenna length. Even an indoor dipole or other wire antenna with 20 feet or more of wire generally will outperform any active antenna.

Active Antenna Notes:

Antenna Connection and Switching Suggestion

The RCA-type phono jack on the rear panel of the Model 1254 is intended for "normal use," which means occasional plugging and unplugging a lightweight shielded cable terminated in an RCA-

type plug. It is not designed to withstand repeated manipulation of, for example, RG-8 coax with a PL259 plus the required phono plug adapter. If you expect to use or try out a variety of antennas, especially those intended primarily for ham transceiver use, we suggest that you build up a simple "antenna utility box" for use with your receiver.

Such a box would be connected to your receiver via a few feet of lightweight shielded cable with RCA plug. The box itself can provide as many cable connectors and switches as you want, plus a master grounding switch. Some audio or cable TV switch boxes from sources such as RadioShack™ might do exactly what you need.

Your Antenna Design Notes:

DC POWER SUPPLY Considerations

For immediate convenience, the Model 1254 Receiver is supplied with a wall-type 15VDC 800 mA power supply. The 1254 receiver is also designed to operate from any 12 to 16 volt properly-filtered DC power source or a suitable vehicle battery system. The power supply should have a 600 mA capacity to operate the receiver properly.

BE EXTREMELY CAREFUL ABOUT CORRECT POLARITY before plugging in coaxial-type connectors from other DC supplies. Check the DC polarity very carefully with your VOM before connecting unknown DC sources, because + DC on the outer barrel is as common as + DC on the inner connector!

Figure 6R: DC Power Connector

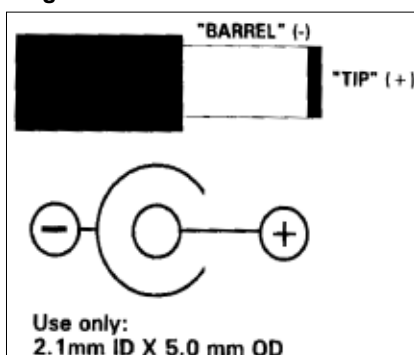

Be especially careful to follow the polarity shown in Fig. 6R, because the receiver has no built-in reverse-polarity protection. If you wish to fuse your power Source, we recommend using a fast-blow (type AGC 1) 1 amp fuse.

For portable operation, the battery may be a lead-acid vehicle type, gel cell pack, or any other battery configuration capable of supplying 12-16VDC at the required current. The following information may be helpful in planning battery capacity for portable operations:

Model 1254 Typical Current Drain:

Receiver on, no volume	200 mA
Moderate or headphone volume	300-400 mA
Maximum volume	400-600 mA

IMPORTANT: If DC power to the receiver is supplied from a vehicle's electrical system or generator, always turn on the receiver AFTER starting the vehicle or generator.

Mobile SWLing

The rugged steel case and 12VDC power requirement of your receiver might give you the idea that the Model 1254 would be a nice addition to a car, RV, etc. We think this receiver is ideal for such installations for those very reasons.

The center holes in the sides of your receiver case match threaded inserts in the chassis which will accept standard #6-32 machine screws. This permits the use of simple "L" brackets or other common hardware to mount the receiver in various ways. We suggest using rubber washers or grommets between such hardware and the receiver case to protect the paint finish.

If extra security or easy removeability are important in your situation, various styles of equipment brackets are available at automotive parts suppliers, CB dealers and RadioShack™ stores.

A variety of ham radio mobile antennas are available for all of the HF bands. For receiving purposes, an 80 or 40 meter antenna should give satisfactory performance on all bands.

If DC power to the receiver is supplied from a vehicle's electrical system, turn on the receiver only AFTER starting the engine. Failure to follow this procedure will result in frequent microprocessor resets and eventual damage to the receiver!

If you experience ignition-related interference, we suggest trying the various solutions provided for that purpose for other kinds of mobile electronics equipment.

External Audio Connections

The receiver audio amplifier supplies about 3 volts rms into loads down to 4 ohms, more than adequate output for external speaker or headphones.

The panel-mounted 1/8" stereo jack permits the use of inexpensive personal stereo headphones and also offers convenient access directly to the audio amplifier output for external speakers, data modems or interfaces, etc.

The receiver audio output is monaural ("mono.") Stereo wiring of this jack is popular because the stereo configuration is emerging as the standard for personal stereo and computer audio applications. For example, find a bargain on a "deluxe" computer speaker system and listen to your Model 1254 explode into house-filling sound! However, the mono 1/8" plug is still a standard for most communications applications (extension speakers, etc.)

A single jumper wire on the jack itself determines whether the front -panel jack is set up for stereo or mono output. Review Assembly Steps 4-14 ff. if you need to change. If the jack is wired for stereo, a mono 1/8" plug will short the output.

Receiving Packet/Digital Modes/SSTV

ALL information about data communications receiving should be obtained from the documentation for your TNC or modem and software. Extremely simple op-amp audio interface circuits permit the use of digital/SSTV software with no need for TNC or modem. To try such interfaces and software, We suggest wiring a 1/8" stereo plug with one side feeding the computer interface and the other side to speaker or headphones. Listening to a signal while observing the computer screen will help you gain the knack of proper tuning. TEN-TEC Technical Assistance cannot provide further information on data-related devices connected to the receiver.

SWL Information and Logging

Any issue of the Popular Communications or Monitoring Times magazines will provide plenty of basic information on Short Wave Listening (SWL) as a hobby with enthusiasts worldwide. Like amateur radio, there are various specializations within the SWL hobby such as collecting OSL cards, listening for exotic broadcasts or to communications from airliners, embassies, world hot spots, revolutionaries, "pirate" (unlicensed) stations, etc.

Regardless of your level of SWL interest, you likely will want to keep a log of interesting signals you hear. A minimal log would include the station identification, time, date, frequency and your own remarks. The style of log is totally a matter of personal preference. It can be a simple notebook, or a log form such as the start-up logbook supplied with this kit, or some kind of computer application.

Various ham and SWL logging programs can be downloaded from BBS and internet sites. Most are shareware, meaning that you would pay the author a royalty fee you continue using a program beyond the specified trial period. A logging "program" is basically a customized "information manager." Many of them have elaborate searching and cross-referencing features, compatibility with databases such as call-books, QSL-printing and other conveniences. Perhaps all you want is a neat method of keeping a record of the most interesting broadcasts you hear. Take a look at all those general-purpose programs on your computer: card file, address book, database, spreadsheet, even word-processing. Very likely, you will get good ideas on how to customize a program file structure to serve as a perfectly good SWL log.

The Model 1254 as a "Communications" Receiver

The Model 1254 is engineered strictly as a receiver for SWL and monitoring purposes. It has no built-in features designed for two-way communications. However it is inevitable and also in the very nature of the ham hobby that some builders will want to try out this compact receiver together with a transmitter for on-the-air communications. It is your responsibility to provide for T-R switching, receiver muting and front-end protection, frequency spotting, sidetone and other operating features taken for granted in typical transceiver design.

Beyond 30 MHz . . .

Your Model 1254 can be used with a receiving converter or even a transverter to receive VHF signals, particularly on the amateur 6 meter (50-54 MHz) and 2 meter {144-148 MHz) bands. The following T-KIT products will work nicely with the Model 1254 to permit monitoring of the 6 meter and 2 meter bands. Keep in mind that transverters are designed (and priced) to handle transmit as well as receive frequency conversion.

T-KIT Model:	1254 Tune:	Receive:
1061 6 meter converter	28-30 MHz	50-52 MHz
1208 6 meter transverter	14-18 MHz	50-54 MHz
1210 2 meter transverter	28-30 MHz	144-146 MHz

When used with a converter or transverter, your receiver becomes what is known as a "Tunable IF". You need to translate the indicated frequency of your receiver to the intended conversion frequency.

. . . and Below 100 kHz!

We did NOT design the Model 1254 to receive signals below 100 kHz. The microprocessor control of the frequency synthesizer stops one step below the 100 kHz limit, which would be 97.5 kHz in SSB mode or 95 kHz in AM mode - OR "0.000.0" kHz when tuned one step down in FAST tuning mode. When you reach "000.0 kHz" using FAST tuning, you will hear the very strong 45 MHz 1st LO signal, intended as a test signal during receiver construction. From this point, you can switch off FAST Tuning and tune UP in 2.5 or 5 kHz steps, but NOT down.

There indeed ARE some radio signals below 100 kHz including WWVB at 60 kHz in Colorado, possible NASA-sponsored experiments and miscellaneous RF devices. We remind you that this tuning capability is beyond the intended design and purpose of the Model 1254. You will need to experiment with the sensitivity below 100 kHz.

SOME HELP WITH TERMS & ABBREVIATIONS

The following are intended to be helpful descriptions, not formal definitions. We try to use plain language as much as possible in this manual, avoiding unnecessary jargon.

Active Antenna ► A combination of a very short antenna, such as a telescoping whip, and electronic circuitry designed to correct shortened antenna impedance mismatch and provide amplification or gain.

ALIGN, Alignment ► The process of adjusting coils or trimmers (either capacitors or resistors) in an RF electronics circuit for best performance. This process is done either by ear or in reference to test instruments. The Model 1254 alignment procedure is as simple as it can get for a circuit design of this level of sophistication.

AM ("Amplitude Modulation") ► Changing the transmitter output power level in exact step with speech or sound variations. In contrast, FM (frequency modulation) varies the transmit frequency in exact step with speech or sound variations. Also see SSB.

BFO ► "Beat Frequency Oscillator." See CLARIFIER below.

BOARD ► Generally refers to "PC-board" or "printed circuit board."

BUFFER ► An electronic circuit stage, a sort of "referee" that tells its input and output not to mess with each other. Think about such a task! It may also provide amplified output of the incoming signal.

CARRIER ► Transmitted RF signal that is NOT "modulated." It is heard as a steady tone in SSB-CW mode or as a sort of hum in AM mode.

CCW ► see CW below.

CLARIFIER ► A control for minor frequency adjustment of an IF oscillator, thereby emulating a "Beat Frequency Oscillator" (BFO) in traditional receiver design.

"CW" ► TWO common meanings in electronics: "Continuous Wave" for the communicating of morse code signals, or "Clockwise" to designate a point on a variable control. "CCW" therefore means "counterclockwise."

DIP ► "Dual Inline Package," referring to IC's and their sockets or any other component ("DIP Switch," etc.). The "line" refers to rows of PC-board or perfboard holes that are 0.1" apart. "Dual" means two rows. Therefore "SIP" would mean a SINGLE row device.

FILTER-ACTIVE
FILTER-CERAMIC
FILTER-CRYSTAL
FILTER-HI-PASS
FILTER-LOW-PASS
FILTER-BANDPASS
FILTER-PASSIVE

Filters are used in DC, Audio and RF circuits. Understanding them is essential electronics know-how.

FREQUENCY SYNTHESIS ► To “synthesize” anything is to create an imitation or simulation from something else. The “basic” ways for generating useful RF frequencies are a crystal oscillator or the L-C oscillator where the frequency is determined by coil (L) and capacitor ©. However we can process the output of an L-C oscillator through digital circuitry to simulate many different, precise crystal-like frequencies, using only one crystal as a reference standard. See also PLL, PHASE DETECTOR, VCO.

GROUND PLANE ► ALL sections of a circuit board which are mechanically or electrically connected to DC and RF ground. In the 1254 receiver design, almost ALL of the top or upper side (component side) of the board is a groundplane. The term is also used in antenna design: if your antenna has a vertical radiating element, plus four (or more) horizontal elements connected to RF ground, the horizontal elements are called a “groundplane.”

HIGH ► In solid-state logic circuitry, to say a given device pin or circuit point is at a “logic high” is to say that it shows a + DC supply voltage at that point. Switching to the opposite state (LOW) or back again for some specific purpose is a fundamental capability of the circuit.

IF (Intermediate Frequency) ► In any superheterodyne receiver, and IF is the frequency resulting from *mixing* an incoming signal with the signal from an LO within the receiver. The Model 1254 has two IF's: 45 MHz and 455 kHz. See also LO, Mixer, Superhet.

JUMPER ► Any wire soldered to interconnect points in a circuit not otherwise connected by board traces or other wiring. Your kit uses “zero ohm resistors” which are short jumper wires in a resistor body painted with one black band.

L-C ► A tuned circuit made of inductor (L) and capacitor ©.

LOCAL OSCILLATOR (LO) ► An oscillator in a superhet receiver whose output is mixed with another signal such as antenna input. See SUPERHET.

LOCK ► The condition in a phase-locked-loop (PLL) in which all sections are working together as intended and designed.

LOOP FILTER ► (See PLL). The output of a PLL phase detector is in the form of pulses. The frequency of those pulses depends on the reference frequency. The loop

filter smooths out these pulses into a clean DC control voltage for the VCO. (See: VCO)

LOW ► see HIGH.

LSB (Lower Sideband) ► See SSB.

MICROPROCESSOR (μP), also Microcontroller ► A miniaturized computer circuit capable of being programmed to perform control functions in a circuit. In the Model 1254, it is the U2 μP which makes possible both the sophistication and the low price of this receiver.

MIXER ► A circuit section which gets two or more inputs and delivers a single output. The output is equal to the sum of the input frequencies and also to the difference between them.

MODULATION ► see also: CW, AM. "Modulation" is simply the process of imposing variations on a steady RF signal from an audio source such as voice, music or data (see: AFSK).

MULTIPLEXING ► has several meanings in electronics, such as to carry out several functions simultaneously through a single line or channel. Very high speed multiplexing is the technique used to light the receiver's digital display.

ORIENT, orientation ► When we ask you to "orient" a kit part one way or the other, we're just asking you to get it RIGHT per all the "orientation" illustrations or explanation which we provide.

PACKET ► Rapid transmission of intelligible computer-generated data in groups or bursts of a fixed length called "packets."

PHASE DETECTOR ► In a frequency synthesizer, the phase detector compares the signal from a reference oscillator to the signal from a programmable counter and sends a corrected control voltage to the L-C section of a VCO. Thus, it can be considered a phase "corrector." See also: VCO, PLL, VARACTOR.

PLATED-THROUGH ► a style of circuit board manufacturing in which traces on both sides of the board are interconnected by a coating of solder around the inside of each hole.

POLARITY ► Refers to the "+" and "-" sides of batteries, power supplies, power cables, electrolytic capacitors, etc.

PLL "Phase-Locked Loop," ► a frequency-output circuit in which an oscillator output is analyzed by counters and a phase detector which control and correct the voltage supplied to varactor diode(s) which determine oscillator frequency.

PRESCALE, Prescaler ► a circuit or device which divides an incoming frequency down to a lower frequency so that it can be handled more easily by later digital counting circuitry or devices. This function is built into U3.

REFERENCE FREQUENCY ► a precise, known frequency, usually crystal controlled, compared with another frequency, as is done in a PLL circuit. See PHASE DETECTOR, PLL.

RX ► Abbreviation for receive, receiver, receiving.

SELECTIVITY ► The filtering capability of a receiver's IF or audio stages, or external devices, to control, or help you manage, how many signal pitches you hear at the same time. The selectivity of a receiver may be fixed ("pre-set") or adjustable. A fixed filter might optimize all 500 Hz audio signals while rejecting all other signals above or below 500 Hz. A variable filter lets you select a particular "frequency response" for your receiver such as 500, 600 or 800 Hz, and so forth. Your Model 1254 receiver is specified at "4 kHz @-6dB," which means

SHIELD ► The outer braid of audio or RF coaxial cable, or the aluminum case enclosing a coil or transformer. The metal case of a receiver also performs an important RF shielding function. The shield blocks or protects a coil from the effect of nearby objects that would change its inductance. The shielding on cable prevents the inner wire from radiating (RF) or from picking up stray radiation such as AC hum.

SIDEBAND ► See SSB.

SIP ► "Single In-Line Pin": Example: U6. [See: DIP].

SSB ("Single Sideband") ► A transmitted signal, usually voice, in which both the carrier and one of the two sidebands are suppressed or greatly reduced. Such signals require less bandwidth for efficient communication but are not suitable for broadcast quality needs such as music. The transmitted signal may be either lower sideband (LSB) or upper sideband (USB). See also AM.

SUPERHET ► a receiver circuit with one or more oscillator-mixer sections which converts the RF energy from the antenna to a different RF frequency before demodulation. This is called an "intermediate frequency" (IF). Your receiver is a dual-conversion superhet. The first IF is 45MHz, and the second IF is 455 kHz.

SWL (Shortwave listening) ► The popular hobby of just LISTENING to shortwave communications or broadcasts. If you hear an especially interesting transmission, you can pursue a "QSL card" confirmation from the transmitting station that what you heard is confirmed by their own records, or you can just note what you heard in your own logbook, OR you can discuss what you heard with other SWL enthusiasts via SWL periodicals, BBS, email or other internet connections.

TIN ► In soldering, to "tin" a wire or copper surface is to heat the wire or surface with the soldering iron so they become coated with a thin layer of solder.

TRIMMER ► either a capacitor or resistor, miniature and variable, intended to permit exact, final adjustment of circuit values.

UNLOCK, unlocked ► refers to the condition in a PLL (phased locked loop) where one or more elements of the loop become defective or incorrect, preventing the phase detector from supplying the correct control voltage to the oscillator for the intended frequency of operation.

USB (Upper Sideband) ► See SSB.

VARACTOR ► a diode whose capacitance can be varied in step with the amount of DC voltage applied to it. The higher the voltage, the lower the capacitance. Also called "varicap." See also VCO, Clarifier.

VCO ► "Voltage Controlled Oscillator," an oscillator whose frequency is varied by DC voltage applied to varactor diodes, which change capacitance in step with the voltage level.

ZENER DIODE ► a diode designed to have a very specific reverse breakdown voltage. This property makes the zener diode ideal for simple voltage regulators or precise voltage drop elements.

About the Component Reference Index

The Kit Parts List in the "Getting Started" section shows the quantity of each type of part supplied in your kit. The following Component Reference Index, keyed to the schematic diagram, identifies the assembly step for each part as well as descriptive information about the parts. Add your own notes as you grow more familiar with the circuit. This Index is your assurance (and ours!) that every component is accounted for in the Assembly Steps, cross-checked to the full schematic and sectional schematic diagrams.

A " * * * " for any part value in the Parts List simply means that more than 4 or 5 of that value are used in the circuit and can be identified in the Component Index as well as on the schematic diagram and in the assembly steps.

T-KIT Model 1254 Receiver

COMPONENT REFERENCE INDEX

(See Kit Parts List for TEN-TEC part numbers not repeated below.)

CAPACITORS (el. = electrolytic; film = mylar film; all others are disc ceramic)

Reference	Description	Step No.	Part No.	Circuit Notes:
C1	470/16v el.	2-30	23228	Filter Cap for display driver
C2	5-40 pF var.	2-33	23413	Master clock (adjust to 3.5800 MHz)
C3	0.1 μ F	2-23	23261	Bypass on PLL chip
C4	33/16v el.	2-31a	23308	Bypass on PLL chip
C5	33 pF	2-21	23246	Shunt cap on clock crystal
C6	.001 μ F	3-13	23245	DC block on VCO 1
C7	.001 μ F	3-29	23245	" " " "
C8	1/50v el.	2-32	23264	Reset coupling cap
C9	0.47 μ F film	3-58	23330	PLL loop filter
C10	.047 μ F film	3-59	23291	" " " "
C11	.01 μ F film	3-61	23340	PLL active filter
C12	.047 μ F film	3-60	23291	" " " "
C13	.01 μ F	3-31	23260	VCO bypass cap
C14	.01 μ F	3-14	23260	" " " "
C15	33/16v el.	2-31b	23308	Vdd supply bypass for μ P
C16	.001 μ F	3-71	23245	Supply bypass for Q25
C17	.01 μ F	3-72	23260	Base bypass for Q25
C18	10/25v el.	3-63	23266	Supply bypass for Q25
C19	27 pF	3-67	23375	VCO lowpass filter
C20	.001 μ F	2-22	23245	VCO coupling cap to PLL
C21	33 pF	3-68	23376	VCO lowpass filter
C22	33 pF	3-69	23376	VCO lowpass filter
C23	3 pF	3-65	23248	VCO lowpass filter
C24	10 pF	3-66	23251	Coupling cap into Q26
C25	.001 μ F	6-44	23245	Coupling cap into Q27
C26	.001 μ F	6-45	23245	Supply bypass for Q27
C27	10 pF	6-41	23251	1st LO output filter
C28	10 pF	6-42	23251	" " "
C29	.001 μ F	6-46	23245	Source bypass on O27
C30	2 pF	6-40	23301	1st LO output filter
C31	18 pF	6-43	23302	" " "
C32	10 μ F el.	3-62	23266	Base bypass on charge pump
C33	0.1 μ F	4-32	23261	Input bypass on U7
C34	0.1 μ F	4-75	23261	Bypass on output of T3
C35	33 μ F el.	4-38	23308	Supply bypass on U7
C36	220 pF	4-30	23396	Oscillator cap on U7
C37	150 pF	4-29	23388	" " "
C38	0.1 μ F	4-76	23261	Bypass on input of U8

Reference	Description	Step No.	Part No.	Circuit Notes:
C39	75 pF	5-32	23382	Second LO output filter
C40	180 pF	4-31	23389	Coupling cap into U7
C41	0.1μF	4-77	23261	Input bypass on U9
C42	0.1μF	4-9	23261	High frequency shunt on U8
C43	470/16v el.	4-5a	23228	Audio output coupling cap
C44	0.1μF	4-33	23261	RF bypass on Q8 base
C45	10/25v el.	4-83	23266	AGC time constant cap
C46	0.1μF	4-34	23261	RF bypass on Q9
C47	0.1μF	4-78	23261	Supply bypass on U8
C48	0.1μF	4-7s	23261	Supply bypass on U9
C49	0.1μF	4-80	23261	RF bypass on U8
C50	0.1μF	4-81	23261	RF bypass on U9
C51	470i16v el.	4-5b	23228	Supply bypass on U6 audio IC
C52	15 pF	5-27	23253	Output coupling cap from Q4
C53	.001μF	5-34	23245	Source bypass cap on Q4
C54	47 pF	5-30a	23378	Resonating cap on input of Q4
C55	1 pF	5-26	23247	Input cap to FL1
C56	47 pF	5-30b	23378	Resonating cap on input to FL1
C57	8 pF	6-24	23250	Resonating cap on mixer T6
C58	.001μF	6-47	23245	Supply bypass on first mixer
C59	not used			
C60	0.1μF	6-25	23261	RF bypass on mixer transformer
C61	0.1μF	6-26	23261	" " " "
C62	0.1μF	6-27	23261	" " " "
C63	.001μF	5-54	23245	Gate-2 bypass on Q4 with FB2
C64	33/16v el.	4-39	23308	Collector bypass on Q8
C65	0.1μF	4-35	23261	Output coupling from Q8 AM detector
C66	0.1μF	4-36	23261	Output coupling from product detector
C67	0.1μt	4-10	23261	Turn-on cap for U6
C68	.01μF	4-37	23260	Bypass on input to U6
C69	0.1μF	6-10	23261	Bypass on front end AGC
C70	47 pF	6-6	23378	RF Input lowpass filter
C71	180 pF	6-8	23389	" " "
C72	180 pF	6-9	23389	" " "
C73	47 pF	6-7	23378	RF Input lowpass filter
C74	.0068μF film	6-3	23338	AM broadcast notch
C75	0.1μF	4-11	23261	Interstage coupling on U6
C76	0.1μF	6-49	23261	Antenna input coupling cap
C77	33 pF	5-28	23376	Second LO capacitor at Q6 base
C78	33 pF	5-29	23376	" " " "
C79	.01μF	5-38	23260	Coupling cap to clarifier varicap
C80	.001μF	5-36	23245	Base bypass on Q5
C81	.01μF	5-39	23260	Second LO output coupling cap
C82	.01μF	5-40	23260	Supply bypass for Q4

Reference	Description	Step No.	Part No.	Circuit Notes:
C83	56 pF	5-31	23379	Output resonating cap for Q4
C84	75 pF	5-33	23382	Second LO output filter
C85	.01μF	5-41	23260	Supply bypass for Q5
C86	0.1μF	6-50	23261	RF bypass on AGC diode D14
C87	0.1μF	2-24	23261	Supply bypass for U2
C88	0.1μF	5-42	23261	Supply bypass for Q7
C89	.0022μF film	6-1	23286	AM broadcast input filter
C90	.0022μF film	6-2	23286	" " " "
C91	100 pF	3-12	23385	VCO varactor coupling cap
C92	100 pF	3-28	23385	" " " "
C93	1/50v el.	6-52	23264	Supply bypass for antenna DC
C94	20 pF	6-4	23254	Antenna input lowpass filter
C95	20 pF	6-5	23254	" " " "
C96	33/16v el.	4-4	23308	Filter cap on volume control
C97	0.1μF	6-51	23261	Supply bypass for antenna DC
C98	10/25v el.	2-11	23266	Supply bypass on U4
C99	.001μF	6-48	23245	First LO output coupling cap
C100	.001μF	5-37	23245	Bypass cap on clarifier control
C101	0.1μF	5-43	23261	Coupling cap into Q7
C102	33/16v el.	3-64	23308	Collector bypass on Q19
C103	.001μF	3-30	23245	RF bypass on VC0 tuning line
C104	33/16v el.	2-45	23308	Bypass on output of U10
C105	33/16v el.	2-46	23308	Bypass on input of U10
C106	470μF el.	2-44	23228	Main DC input bypass



DIODES

D1	1N4148	3-6	28001	VCO switching diode
D2		3-5		Factory Installed
D3	<i>not used</i>			
D4	1N4148	3-23	28001	VCO switching diode
D5	1N4148	2-25	28001	Supply summing diode for U2
D6	6.2V zener	2-26	28055	Supply turn-off detector
D7	6.2V zener	2-27	28055	Backup battery summing diode
D8		3-22		Factory Installed
D9	<i>not used</i>			
D10	1N4148	5-1	28001	Second mixer diode
D11	1N4148	5-2	28001	Second mixer diode
D12	1N4148	4-55	28001	Forward bias for AM detector
D13	BA4796	6-12	28062	Front end AGC series diode
D14	BA4796	6-3	28062	Front end AGC shunt diode
D15	1N4148	5-3	28001	Second mixer diode
D16	1N4148	5-4	28001	Second mixer diode
D17	3.9V zener	6-53	28021	Front end AGC bias
D18		5-52		Factory Installed

INDUCTORS

Reference	Description	Step No.	Part No.	Circuit Notes:
L1	100 μ H	2-40	21164	RFC for U3 DC supply
L2	VCO coil	3-18	85421-1	VCO-2 coil
L3	VCO coil	3-2	85421-2	VCO-1 coil
L4	0.27 μ H	3-56	21105	PLL feedback lowpass filter
L5	0.39 μ H	3-57	21107	" " " "
L6	4.7 μ H	6-55	21120	LO amplifier DC choke
L7	0.56 μ H	6-54	21109	LO output lowpass network
L8	0.47 μ H	6-56	21108	" " " "
L9	0.25 μ H	5-49	21059	45 MHz filter
L10	0.25 μ H	5-50	21059	45 MHz filter
L11	0.12 μ H	5-48	21180	Mixer circuit
L12	100 μ H	6-18	21164	Front-end AGC RFC
L13	0.39 μ H	6-14	21107	RF input bandpass filter
L14	0.39 μ H	6-15	21107	" " " "
L15	0.56 μ H	6-16	21109	" " " "
L16	6.8 μ H	6-17	21122	AM broadcast notch with C74
L17	0.39 μ H	5-44	21107	Mixer out
L18	1.0 μ H	5-45	21112	crystal tuning network
L19	4.7 μ H	5-46	21120	DC power RF choke
L20	100 μ H	6-57	21164	RFC for antenna DC
T1	bifilar balun	3-40	21152	LO output transformer
T2	455 kHz coil	4-52	21093	455 kHz IF amplifier
T3	455 kHz coil	4-53	21093	" "
T4	trifilar balun	5-6	21153	Second mixer with diodes
T5	trifilar balun	5-7	21153	Second mixer with diodes
T6	1 μ H w/CT	6-21	21194	First mixer input
T7	455 kHz coil	5-47	21093	Second IF output transformer
T8	bifilar balun	5-8	21152	Second LO output
T9	trifilar balun	6-22	21153	First mixer output

INTEGRATED CIRCUITS

U1	MC7805CT	2-19	25095	5V regulator for synthesizer circuitry
U2	PIC16C57	2-42	25317	8-bit microprocessor (P/N 98394)
U3	MC145170P1	2-18	25296	PLL synthesizer
U4	SN74LS47N	2-16	25336	LED segment driver
U5	BA618	2-17	25341	Digit driver
U6	NTE1852	4-1	25356	Audio amplifier
U7	NE612/SA612	4-20	25319	Product detector
U8	MC1350P	4-50	25069	IF amplifier
U9	MC1350P	4-51	25069	IF amplifier
U10	NJM7810J	2-48	25400	10V voltage regulator

TRANSISTORS

Reference	Description	Step No.	Part No.	Circuit Notes:
Q1	<i>not used</i>			
Q2	J310	6-28	25115	First Mixer with Q3
Q3	J310	6-29	25115	First Mixer with Q2
Q4	BF988	5-53	25388	First IF amplifier

Reference	Description	Step No.	Part No.	Circuit Notes:
Q5	2N4124	5-9	25258	Second LO buffer
Q6	2N4124	5-10	25258	Second LO oscillator
Q7	J310	5-55	25115	455 kHz amplifier
Q8	2N4124	4-21	25258	AM detector
Q9	2N4124	4-52	25258	AGC rectifier
Q10	2N5087	4-54	25001	AGC integrator
Q11	2N4124	4-53	25258	AGG voltage follower
Q12	2N4124	2-36	25258	Decimal point current sink
Q13	2N4124	2-37	25258	Power-on reset transistor
Q14	2N4124	2-38	25258	Power-down detector
Q15	2N4124	3-35	25258	PLL charge pump
Q16	2N4124	3-36	25258	" " "
Q17	2N5087	3-33	25001	" " "
Q18	2N5087	3-34	25001	" " "
Q19	MPSA14	3-37	25253	PLL active loop filter
Q20	J310	3-19	25115	VCO-2
Q21	J310	3-3	25115	VCO-1
Q22	2N4124	3-4	25258	VCO enable transistor
Q23	2N4124	3-21	25258	" " "
Q24	2N4124	3-20	25258	" " "
Q25	2N4124	3-38a	25258	First LO amplifier
Q26	2N4124	3-38b	25258	VCO buffer for PLL
Q27	J310	6-58	25115	First LO output amplifier

RESISTORS

Reference	Description	Step No.	Part No.	Circuit Notes:
R1	4.7	2-1	30111	Supply lead to U5
R2	10meg	2-10b	30185	Clock oscillator for U3
R3	10K	2-3	30150	Display decimal point
R4	10K	2-4	30150	Pull-down for pushbuttons
R5	47K	2-9	20157	Pull-down for encoder
R6	47K	2-10a	20157	" "
R7	100	3-42	30126	PLL Charge pump
R8	100	3-43	30126	PLL Charge pump
R9	10K	2-5	30150	Pull-up for reset pin
R10	470	2-2	30134	Pull-down for Q13
R11	47K	3-9	20157	Pull-up for VCO
R12	10K	2-6	30150	Power-off detector
R13	10K	2-7	30150	Power-off detector
R14	10K	2-8	30150	Pull-up on RTCC pin
R15	15K	3-53	30076	PLL damping resistor
R16	1.5K	3-45	30140	Charge pump input
R17	1.5K	3-46	30140	Charge pump input
R18	4.7K	3-48	30146	Active loop filter input
R19	4.7K	3-49	30146	Active loop filter
R20	150	3-24	30128	VCO source resistor
R21	150	3-7	30128	VCO source resistor
R22	10K	3-8	30150	VCO select
R23	22K	3-54	30154	Active loop filter emitter
R24	47K	3-25	20157	VCO pull-up resistor
R25	47K	3-10	20157	Varactor bias resistor
R26	47K	3-26	20157	VCO switching

Reference	Description	Step No.	Part No.	Circuit Notes:
R27	47K	3-11	20157	VCO switching
R28	47	3-41	30122	Supply resistor for Q25
R29	10K	3-50a	30150	Base bias for Q25
R30	10K	3-50b	30150	Bias for Q26
R31	470	3-44	30134	Emitter resistor for Q26
R32	10K	3-51	30150	Bias resistor for Q26
R33	10K	6-33	30150	Gate Pull-down for Q27
R34	47	6-31	30122	Supply resistor for Q27
R35	100	6-32	30126	Source resistor for Q27
R36	220	6-34a	30130	Drain load for Q27
R37	47K	3-27	20157	Varactor bias resistor
R38	10K	3-52	30150	Charge Pump bias
R39	47K	3-55	20157	Charge Pump bias
R40	47	4-23	30122	Input resistor to U7 product detector
R41	10K	4-28	30150	Input resistor to AM detector
R42	100	4-60	30126	Supply to U8
R43	100	4-61	30126	Supply to U9
R44	150K	4-8	30163	Power-on bias to U6
R45	4.7	4-6	30111	High frequency shunt on U6
R46	1.0K	4-26	30140	AM detector emitter resistor
R47	2.2K	4-64	30142	AGC discharging resistor
R48	1 megohm	4-74	30173	AGC time constant
R49	220K	4-73	30077	AGC charging resistor
R50	10K	4-68	30150	AGC rectifier pull-down
R51	10K	4-69	30150	AGC input resistor
R52	4.7K	4-66	30146	IF amp input load
R53	1.0K	4-27	30140	AM detector emitter resistor
R54	100	5-11	30126	Source resistor for Q4
R55	10K	5-19	30150	Gate load for Q4
R56	100	6-33	30126	Supply resistor for first mixer
R57	220	6-23	30130	Front end AGC return
R58	47K	5-23	20157	Gate 2 bias for Q4
R59	10K	4-70	30150	Forward bias for AM detector
R60	220	6-34b	30130	Output load for first LO
R61	2.2K	4-65	30142	IF amp output load, U8
R62	1.0K	4-62	30140	IF amp output load, U9
R63	22K	4-72	30154	AGC input resistor, U8
R64	10K	4-71	30150	AGC input resistor, U9
R65	4.7K	4-67	30146	AGC Pull-down resistor
R66	0 ohm	4-59	30353	Front end AGC voltage divider
R67	1.0K	4-63	30140	Front end AGC Pull-down
R68	470	6-36	30134	First mixer balance
R69	470	6-37	30134	First mixer balance
R70	100 var	6-20	30856	Mixer balance trimmer
R71	220	6-35	30130	Front end AGC forward bias
R72	220	6-11	30130	AM broadcast attenuator
R73	10K var	4-12	30267	Front Panel volume
R74	4.7K	4-7	30146	Volume control Pull-up
R75	220	5-16	30134	Second LO emitter resistor
R76	22K	5-20	30154	Second LO bias
R77	1.0K	5-17	30140	Crystal shunt resistor

Reference	Description	Step No.	Part No.	Circuit Notes:
R78	47K	5-24	20157	Clarifier varactor bias
R79	22K	5-21	30154	Second LO bias
R80	22K	5-22	30154	Second LO bias
R81	47K	5-25	20157	Gate 2 bias for Q4
R82	10K var	5-58	30267	Front panel clarifier pot
R83	100	5-12	30126	Supply feed for Q4
R84	100	5-13	30126	Supply feed for Q7
R85	2.2K	5-18	30142	Drain load for Q4
R86	100	5-14	30126	Source resistor for Q7
R87	2.2K	3-47	30142	Collector feed for Q7
R88	100	4-24	30126	Power feed for product detector
R89	100	4-25	30126	Power feed for AM detector
R90	470	6-38	30134	Source resistor for antenna DC

■ OTHER COMPONENTS

Reference	Description	Step No.	Part No.	Circuit Notes:
FL1	45U1A	5-56	48339	45 MHz crystal filter
FL2	CFR455I	4-56	48284	455 kHz filter
Y1	3.579545 MHz	2-35	48079	Synthesizer clock set to 3.58 MHz
Y2	455 kHz	4-22	48228	Oscillator for product detector
Y3	44.545 MHz	5-57	48235	Second LO
J1	Coaxial DC	2-47	35266	DC power input
J2	2-pin header	2-43	35065	Power switch cable connector
J3	phono jack	6-83	35238	antenna connector
J4	3-pin header	2-39	35066	Encoder cable connection
J5	2-pin header	4-3	35065	speaker cable connection
J6	3-pin header	4-2	35066	headphone jack cable connector
P1	right-angle	2-13	35276	connector to display board
P2	right-angle	2-14	35276	" " "

■ DISPLAY BOARD

Reference	Description	Step No.	Part No.	Circuit Notes:
EN1	Encoder	1-36	32112	Freq/Memory TUNE
D1	1N4148	1-21	28001	pushbutton switch multiplexing diode
D2	1N4148	1-22	"	" " " " "
D3	1N4148	1-23	"	" " " " "
D4	1N4148	1-24	"	" " " " "
D5	green LED	1-5	28082	AM mode indicator
D6	green LED	1-6	"	SSB mode indicator
U1	LED	1-1	28201	frequency/memory display
U2-U6	LED	1-2	28201	frequency/memory display
J1	8-pin socket	1-10	35277	mates P1
J2	8-pin socket	1-11	35277	mates P2
R1-R8	33 ohm, 1/8W	1-12-19	30120	LED current limiter
R9	1K, 1/8W	1-20	30138	multiplexing resistor
SW1	momentary	1-26	32113	MODE
SW2	"	1-27	"	MW
SW3	"	1-28	"	V/M
SW4	"	1-29	"	Tuning SPEED
S1	SPDT	1-30		DC on-off

Model 1254 Receiver

TROUBLESHOOTING GUIDE

This section presumes that the receiver has been working and that you now suspect a problem. Problems encountered DURING kit assembly phases should be corrected before progressing to the next assembly phase.

1. Look for the simple and obvious first:

- Power supply or batter connection problem
- Blown power supply fuse
- Broken antenna coax connection
- Defective headphone or speaker cable

2. Many typical problems can be resolved by consulting the Troubleshooting Chart on the following page.

3. Diagnosis of other possible problems is done best by reviewing the Circuit Description (Reference Section) and the progress tests after each kit assembly phase. Selection of correct component values is very important, which is why double-checking is recommended throughout the building process.

4. If you are not the original builder of the kit, we suggest the following procedures in this order:

- Check for +5VDC at the LD (“lock detect”) test point.
(Lack of LD voltage indicates PLL or VCO problem.)
- Perform the voltage checks including VCO alignment per page 37
- Explore any circuit section showing drastically different voltage readings.
- Review the Progress Tests at the end of each Assembly Phase.
- Examine boards for cold solder joints, solder bridges, damaged hookup wire jumpers. Touch up as needed.
- Review correct polarity or orientation of all parts.

If none of the above helps, it's time to review the Component Index and kit assembly phases to see if any incorrect part values were installed. Yes, check every part!

5. Parts Replacement. The most likely cause of component failure in this circuit design would be incorrect values installed for some other component(s). Therefore replacing a bad part should also include the discipline of checking the values installed for parts immediately associated with that failed component. Also, if you find a wrong value installed in one place, you should wonder where the correct value was installed.

Use care and **PATIENCE** in desoldering parts. The plated-through holes make it a challenge: using a “solder sucker” or “solder wick” braid is recommended.

Most common parts in this receiver may be replaced with their off-the-shelf equivalents: resistors, capacitors, transistors, diodes, and so forth. The only parts for which TEN.TEC is the sole source is the pre-programmed U2 microprocessor IC and the fabricated steel, aluminum or plastic parts of the enclosure. All parts used in the receiver may be ordered by TEN-TEC part number as specified in the Parts List or Component Index. Minimum order charges may be applicable.

T-KIT Technical Assistance may be contacted at (423) 453-7172, Monday through Friday, during normal business hours.

1254 Troubleshooting Chart

No Speaker Audio	Make sure that the headphone jack cable is plugged into J6 and that the headphone jack is wired correctly.
External speaker with 1/8" mono plug does not work	Front panel jack is wired for stereo. Change the speaker plug to stereo, or change jack wiring per page 21.
Only one side of stereo phones or stereo speakers is working.	Front panel jack is wired for mono. Change the jack wiring to stereo per page 21.
Signals seem very weak compared to other receivers	1. Make sure coils T6, T9, L10, L11 and T7 have been peaked for maximum signal strength. 2. Connect a 0.1µF capacitor directly from the antenna to the 1st Mixer input (cathode of PIN diodes D13 or D14). If this results in a significant increase in signal strength, there is an error in the shield bandpass filter section.
Erratic or blank display	Perform Microprocessor Reset
Stored frequencies not in memory when receiver is turned back on.	1. Memory backup battery bad or not installed. 2. Check battery snap connector.
Signals seem somewhat off frequency compared to other receivers.	1. Make sure C2 is adjusted to WWV (Assembly, p. 69). 2. Be sure you understand function of Clarifier control.
Numerous heterodyne or "birdie" signals when using indoor or active antenna	Antenna is too close to receiver and may be picking up display multiplexing harmonics. We recommend at least 15 feet away with coax feed.
Very strong signal at 455 kHz	This is normal: the 455 kHz product detector oscillator (Y2) is being picked up at the RF input.

Model 1254: Selected DC Voltage Measurements

Measuring point	Typical VDC	Your reading
Q5 base	5.0	
Q7 course (at R86)	1.2	
T7 (cold end)	8.9	
U9 pin 4	3.0	
pin 6 (measuring here will generate noise)	3.0	
pins 1 and 2	9.0	
U8 pin 4	3.0	
pin 6 (measuring here will generate noise)	3.0	
pins 1 and 2	9.0	
T3 (measure at anode of D12)	0.6	
D7 cathode	3.8	
D14 anode with NO signal	1.0	
D14 anode (maximum voltage with strong signal)	4.3	
Junction of R57 and C62	2.9	
Q2 gate	0.6	
Q3 gate	0.6	
Q27 at bottom of R34	9.2	
Q27 at R35/C29	1.8	
Q26 emitter	4.0	
Q25 base	6.5	
Q19 collector	9.8	
Q15 base	1.7	
Q16 base	1.7	
Junction of R1 and C1	4.8	
U2, pin 4	4.0	
VCO test point	See Phase 3.0	
+ 10V TP	10.0	

Modifications to the Original Receiver Design

It is in the very nature of hobby electronics to "customize" equipment, especially that which we build ourselves. It is good practice, to make written notes about any changes or additions you make to the original design, even simple ones such as auxiliary DC, audio or antenna connections. We recommend that you have the receiver working perfectly per our kit instructions before doing any modifications.

Model 1254 Modifications Notes

CHECKING FOR SOLDER BRIDGES

This view of the main circuit board solder-side traces is exactly as you would view the board itself, with no need to look "through" the board from top to bottom. If you wonder whether certain points should be joined by solder, compare what you see on the board with this view of the traces.

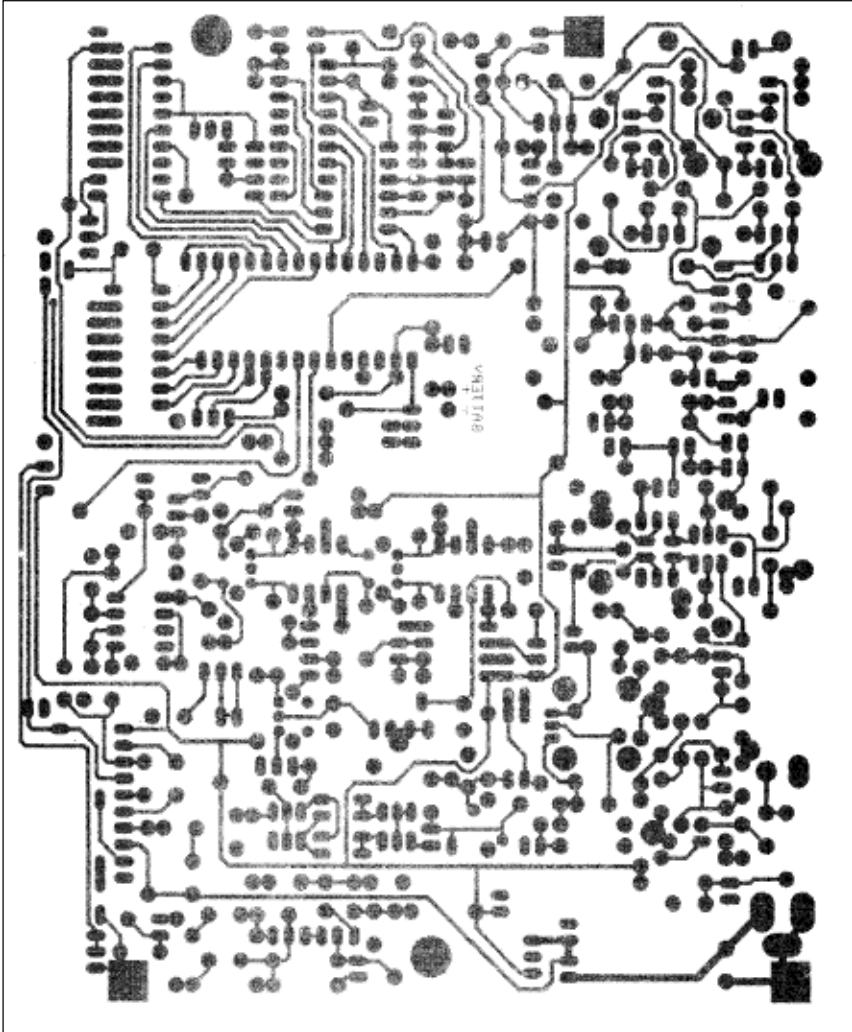

T-KIT Limited Warranty

Please read carefully BEFORE building your Kit

This limited warranty applies solely to KITS sold by TEN-TEC, Inc. under the trade name :T-KIT". The terms of this warranty do not apply to other products of any kind manufactured by TEN-TEC Inc., nor shall any other warranties published by TEN-TEC Inc., or any TEN-TEC customer service policies for its manufactured products, be construed as applicable to T-KIT products.

- 1. All components and hardware supplied as parts of a kit are warranted to be free from manufacturing defect for one year from date of purchase.*
- 2. The original purchases has the option of examining the kit and manual for 30 days. If you choose within this period not to construct the kit, you may return the entire un-assembled kit at your expense for full credit toward any other TEN-TEC product, or a refund, less original shipping/handling charges.*
- 3. This warranty is voided if acid-core solder is used in construction. USE ROSIN CORE SOLDER ONLY, of a grade designed for electronic PC-board assembly. WARNING, solder contain lead, which is known to cause birth defects or other reproductive harm. Avoid breathing solder fumes which may cause pulmonary irritation or damage. After handling any solder, wash hands with soap and water before eating.*
- 4. TEN-TEC Inc. warrants this device to function as described in its documentation provided that it is assembled and used correctly in accord with all printed directions. It is your responsibility to follow all directions in the instruction manual to identify components correctly and to use good workmanship and proper tools in construction this kit.*
- 5. We do not accept the return of partially-assembled kits for repair or refund.*
- 6. If you believe a kit part is missing, do a thorough sorting of all parts, checking each off on the parts list in the manual. Check all bags, envelopes and boxes carefully. Simply call or email service@tentec.com and we will promptly replace any missing part. Even if you find an exact replacement part locally, please notify us so we can assist other customers.*
- 7. If your kit does not work after final assembly, please follow these steps in order:*
 - A. Double check every step in the assembly manual and any troubleshooting tips provided.*
 - B. Ask an experienced ham or hobbyist friend to review your work. A fresh set of eyes can catch a detail which you may have overlooked.*
 - C. If necessary, you are welcome to call TEN-TEC service at 865-453-*

7172 *Technical assistance is not available on the 800 Sales lines.*

8. *Factory inspection and service. If you wish to return a kit for professional inspection or repair there is a minimum charge of \$XXXX. There is no need to call or write for authorization, simply send your kit with a note explaining the problem and provide authorization to make repairs at prevailing ship rates.*
9. *TEN-TEC, Inc. reserves the right to revise this limited warranty, to change or discontinue any kit product or revise its instruction manual with no liability to previous purchasers.*
10. *TEN-TEC, Inc. is not liable for any consequences from use or abuse of any T-KIT or part contained therein.*

**T-KITS by TEN-TEC
A division of TEN-TEC inc.
1185 Dolly Parton Parkway
Sevierville, TN 37862
865-453-7172**