K7QO's TT13XX Assembly Notes

Version 1.0

January 20, 2009

by

Chuck Adams, K7QO

k7qo@commspeed.net

Contents

1	Introduction	5
2	Tools	7
3	Phase 1.0 - Keying and DC Input Circuits	37
4	Phase 2.0 - VFO and Buffer and RF Amplifier Circuits	97
5	Phase 3.0 - Transmit Mixer and 10.1MHz Filter Circuits	159
6	Phase 4.0 - 14.318MHz Receiver IF Stages	179
7	Phase 5.0 - Receiver BFO and Audio Amp Stages	227
8	Phase 6.0 - Audio Preamp/Filter and AGC	247
9	Phase 7.0 - Transmit Driver, RF Amp and Output Filter	279
10	Final Assembly	319
11	RG-174 Coax Preparation	329

Chapter 1

Introduction

This is a manual showing a multitude of photographs during the construction of the TenTec 1330 30-meter transceiver. It is not meant to be a replacement of the manual, but to be used as a visual aid for any builder of the rig. If there is a question about a step, the TenTec manual takes priority over what I did.

The construction of any kit is not a timed exam. There is no need to rush the construction process. The extra time spent in double checking your work before committing to the installation of a part will be rewarded with not having to come back and correct any mistakes.

I'll take a few photographs and explain how I do soldering and you should note that solder will, most of the time, flow through the hole in the printed circuit board and join the component lead to the solder pad on the component side of the board. This also means that if you have to come back and remove a part you will have to do a little more work and use more care in doing so. But the resulting work looks like the soldering was done by a commercial wave soldering machine.

Enjoy the kit and I hope that this work on my part will help you do a better job and give you excellent results.

Chapter 2

Tools

The tools required to build this kit are rather simple and inexpensive. There is not need for soldering stations costing more than the kit and you can get just as good results as the next person.

You will need the following.

- Solder Iron.
- Electronic Solder.
- Diagonal Cutters.
- Chain-Nose Pliers.
- Lead Bender (Optional).
- Magnifying Glass or Loupe.
- Hobby Knife.
- Wire Stripper.



Figure 2.1: Soldering Iron used in this Manual.

The soldering iron above is one purchased at a local Home Depot in the tools department. It cost less than \$15.00 at the time of purchase and hopefully the cost hasn't gone up.

It does not take an expensive soldering station to do an excellent construction job on this kit.

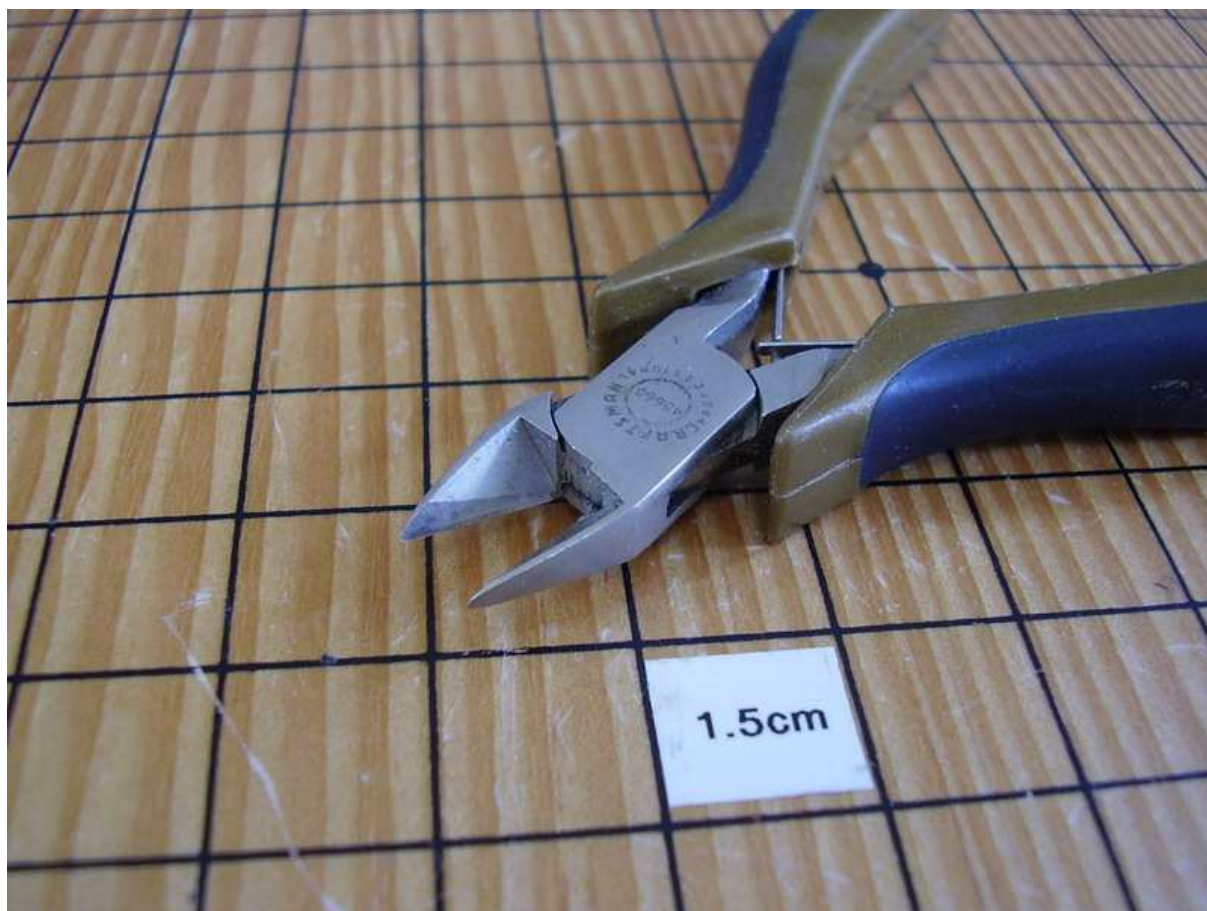

Figure 2.2: Diagonal Cutters.

Here are a pair of diagonal cutters purchased from Sears and carry the Craftsman brand. These are great for cutting leads after they have been soldered.

Do not use these for anything else but electronic construction and cut nothing but wires of components. Do not cut steel wire with them or they will be damaged.

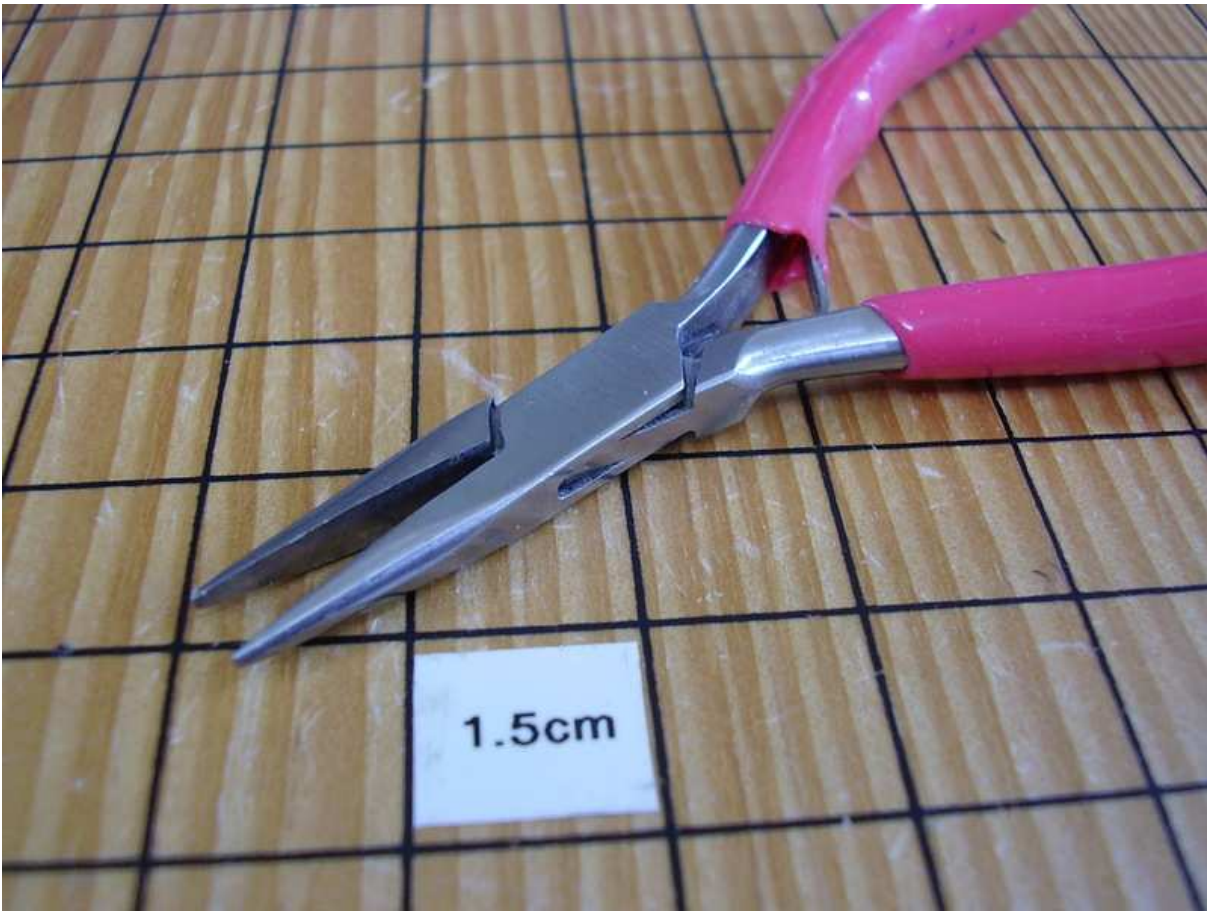

Figure 2.3: Chain-Nose Pliers.

The above are chain-nose pliers obtained from a bead store. The kind of bead store that has a variety of beads for making bracelets for teenagers.

These are smaller than needle-nose pliers and they are used mainly by jewelers for working on decorative chains and necklaces that require small areas of contact for metal work.

They are not that expensive either.



Figure 2.4: Kester Solder.

Use solder intended only for electronic assembly. My preference is for tin and lead based solder with some silver content.

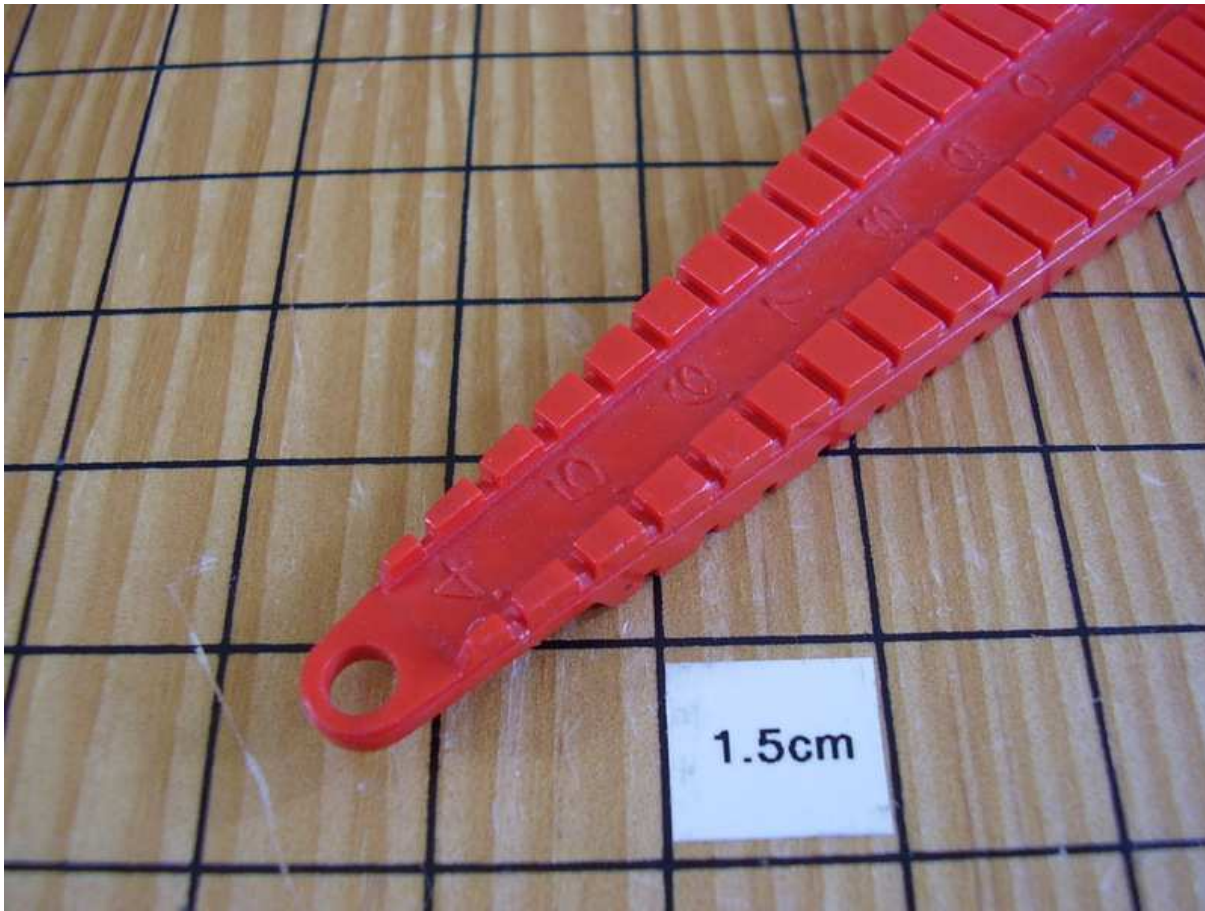

Figure 2.5: Lead Bender.

A lead bender allows you to bend the component leads on resistors to the same length. Most of the resistors are set with 0.4" spacing.



Figure 2.6: Wash Cloth.

Most builders clean their soldering iron tip with a wet sponge between solder applications. I choose to just swipe the tip across a heavy duty washcloth. It does not lower the iron temperature and is very cheap.



Figure 2.7: Exacto Hobby Knife.

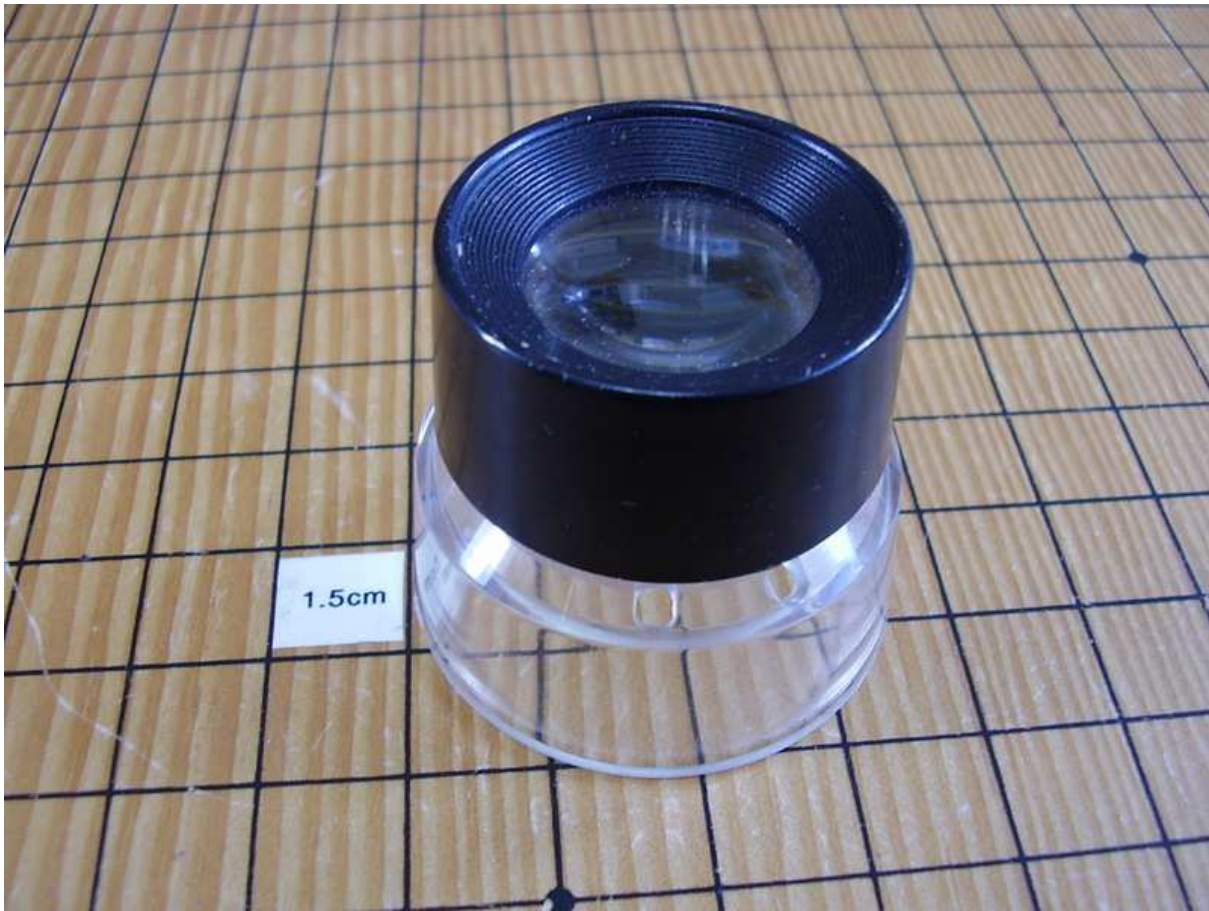

Figure 2.8: Ten Power Loupe.

I found this magnification lens at a dollar store. I use it to double check solder connections and for possible shorts on the board. And for parts identification for transistors and very small parts that are marked with laser etchings that are very difficult to see.

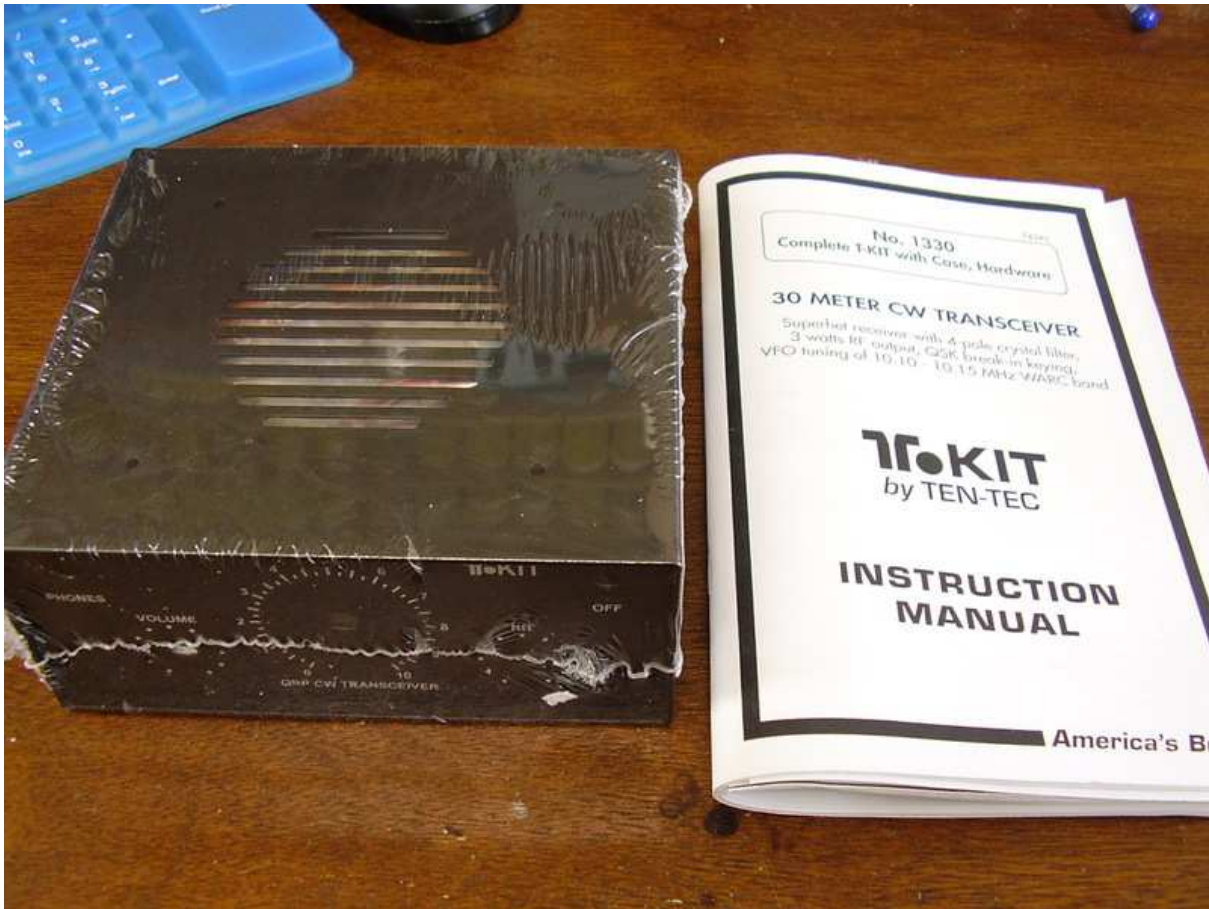

Figure 2.9: Shrink Wrapped Transceiver and Manual.

The above shows the kit and manual removed from the shipping carton.

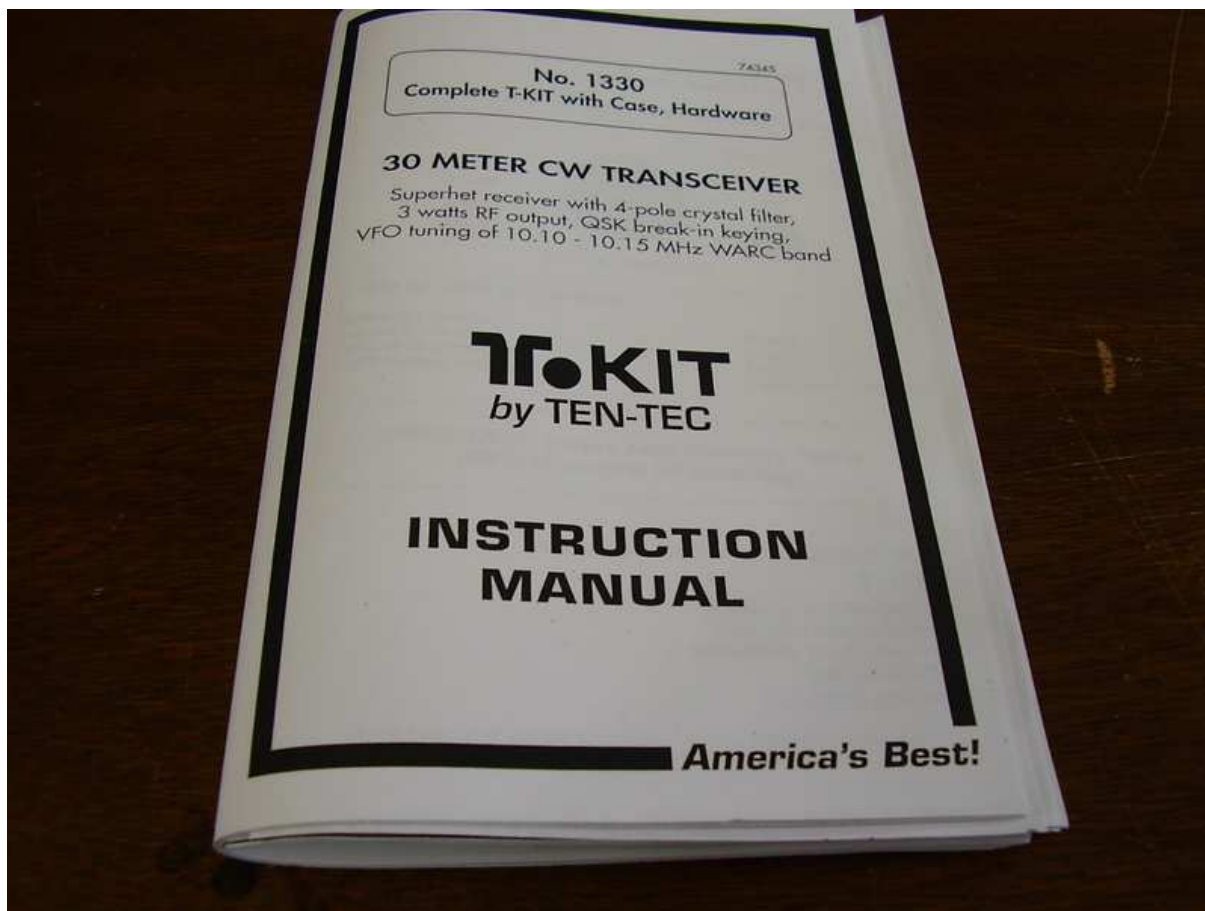

Figure 2.10: Construction Manual.

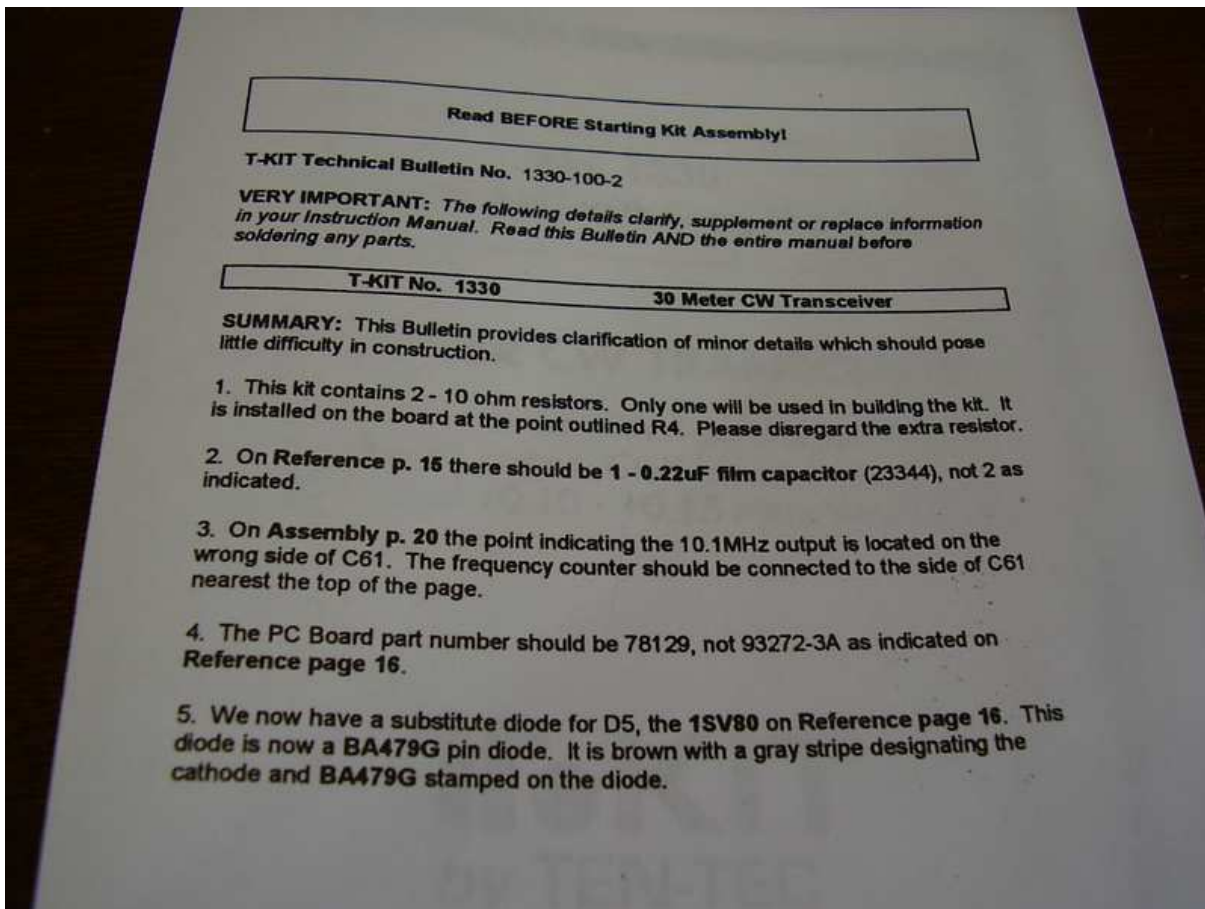

Figure 2.11: Corrections to Manual.

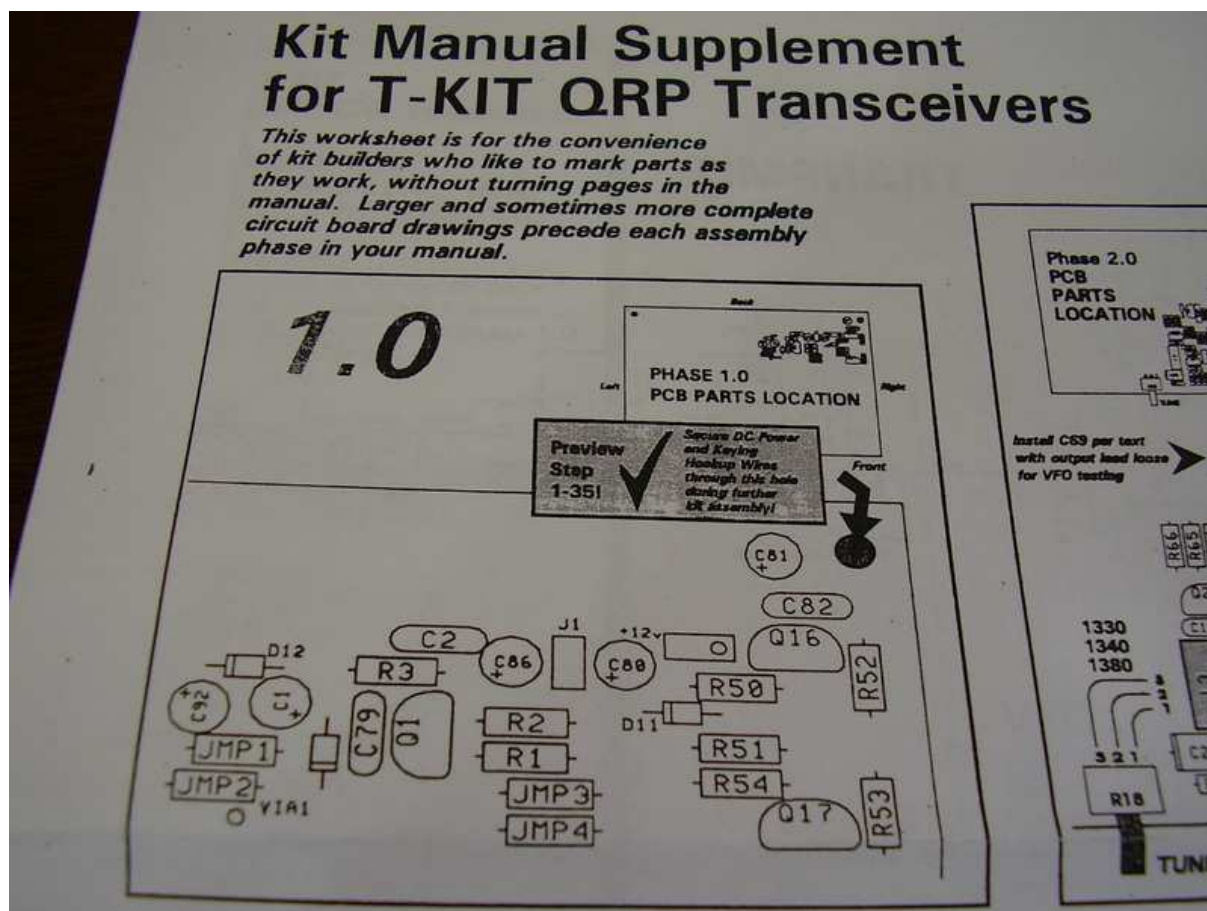

Figure 2.12: Kit Supplement Manual.

A large page called the kit supplement manual contains diagrams for each phase of the building process. This page will keep you from having to page back and forth in the construction manual to look at parts locations.

If you don't mind, you may use a highlighter to highlight parts as they are installed. This adds to the time it takes to finish the kit, but I find that it is useful to help concentration and to avoid as many errors as possible.

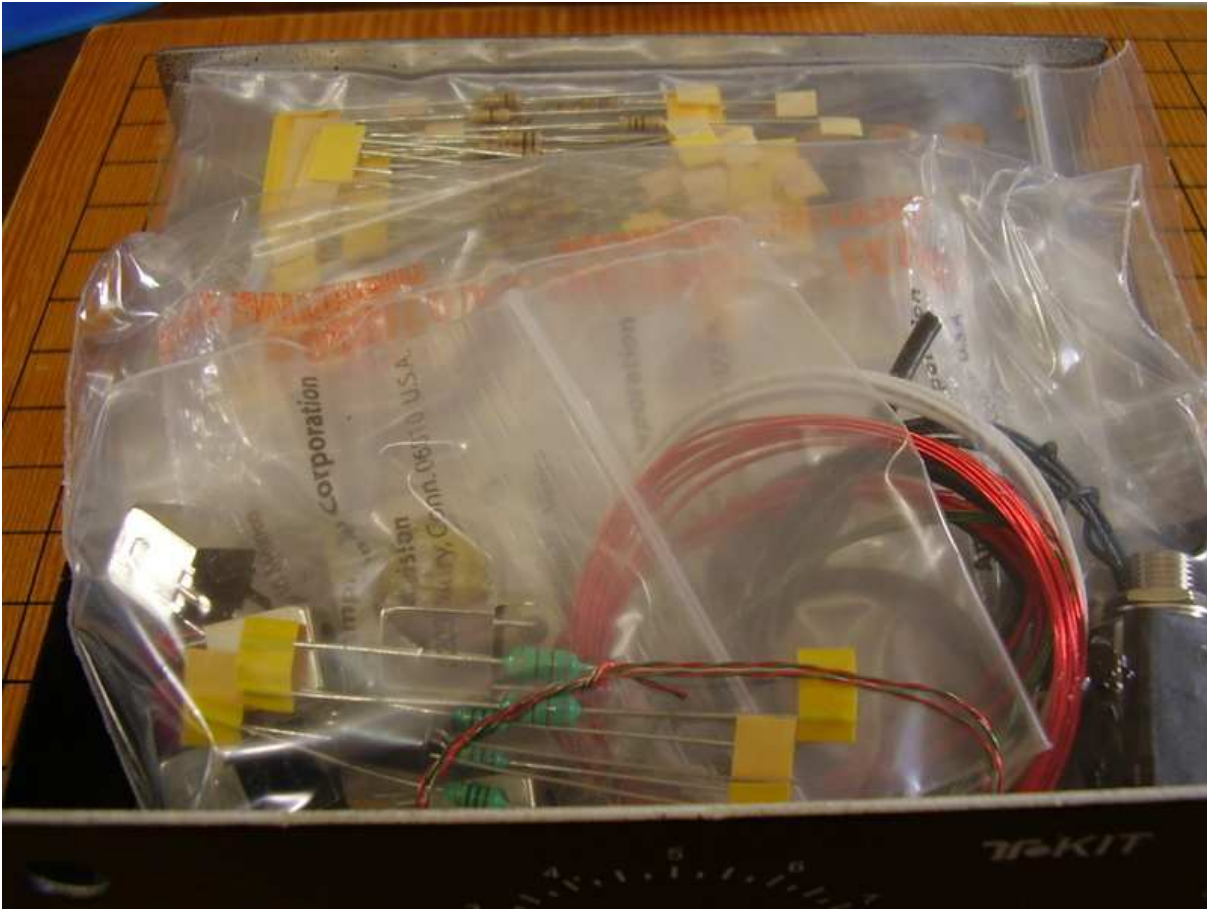

Figure 2.13: Case Cover Removed.

The components are shipped in bags and are in the case. I recommend that you do not remove parts from the bags until you need them. This will keep you from losing them and getting confused.



Figure 2.14: Shielded Inductors, Wire and Hardware.

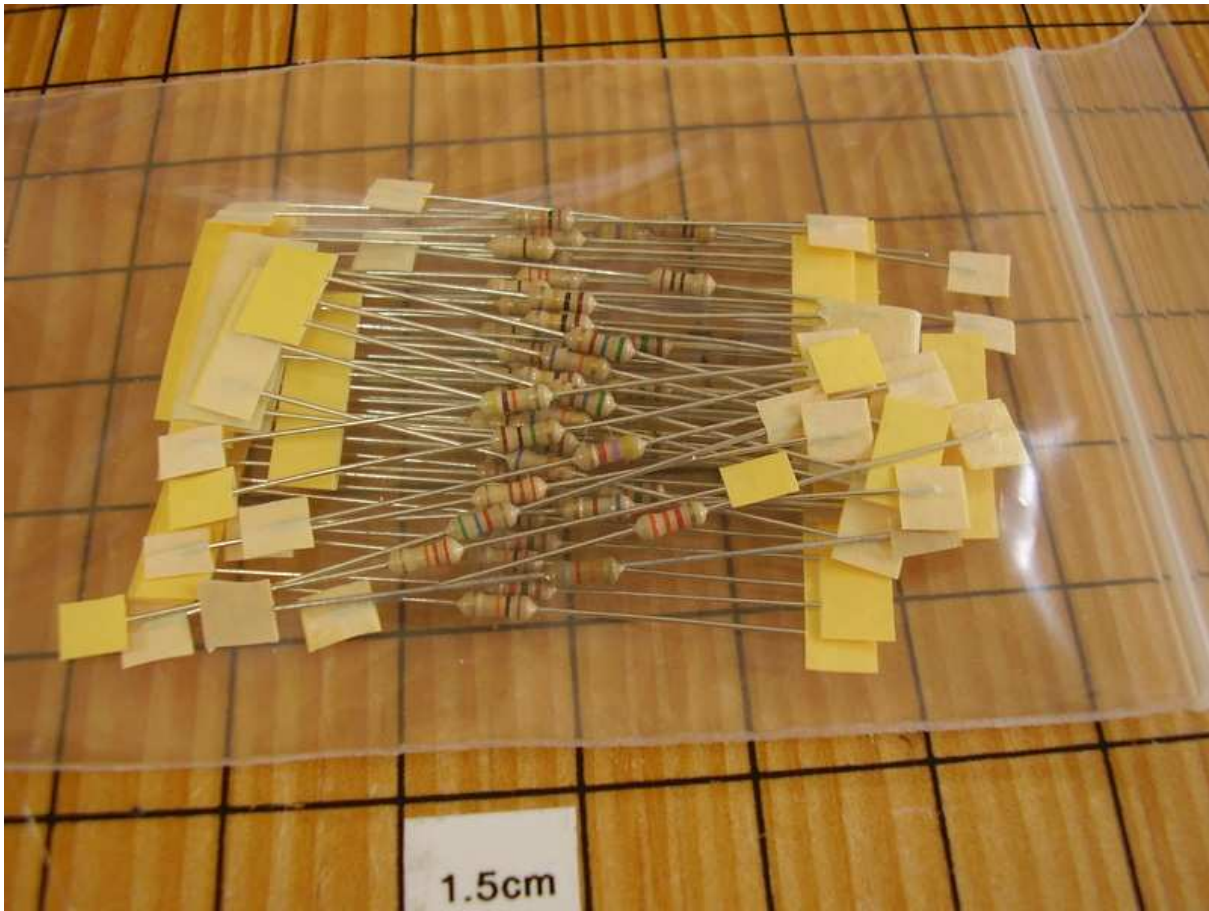

Figure 2.15: Resistors.

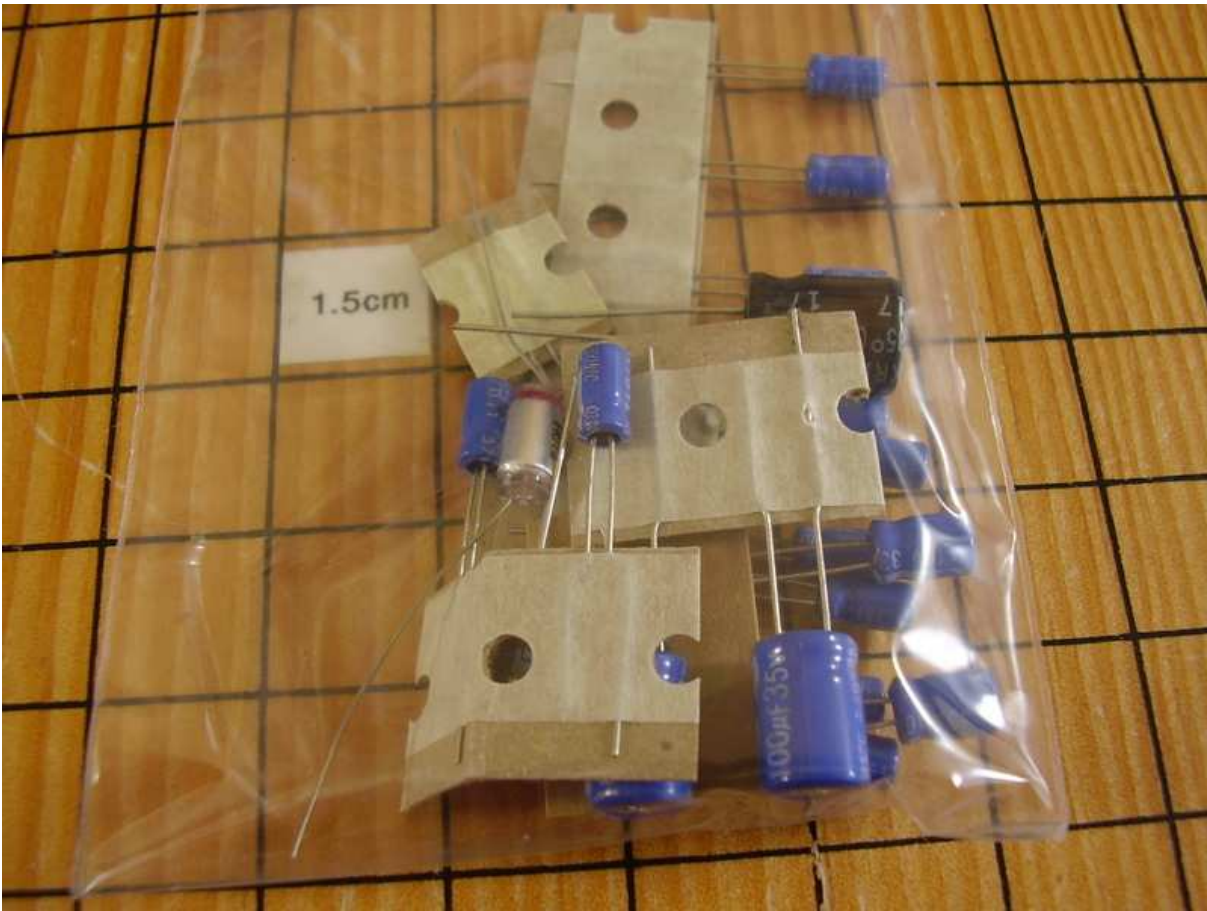

Figure 2.16: Electrolytic Capacitors.



Figure 2.17: Electrolytic Capacitors.



Figure 2.18: Disc and Mylar Capacitors.

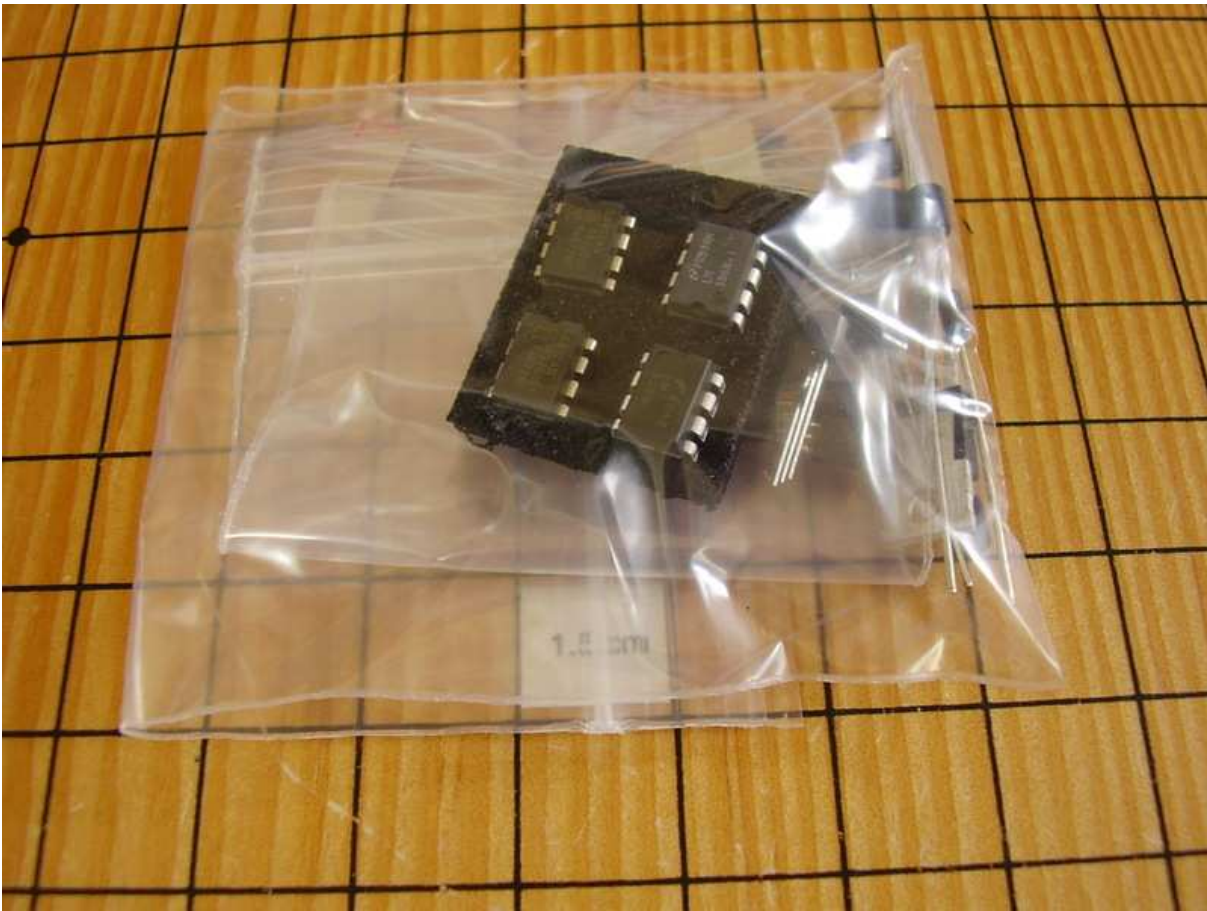

Figure 2.19: Integrated Circuits.



Figure 2.20: Diodes and Transistors.

These are in the same bag as the integrated circuits. I just turned the bag over for this photograph.



Figure 2.21: Hardware and Crystals.



Figure 2.22: Knobs and Mounting Hardware.



Figure 2.23: Printed Circuit Board.

This is the side that will have the components after they are installed.

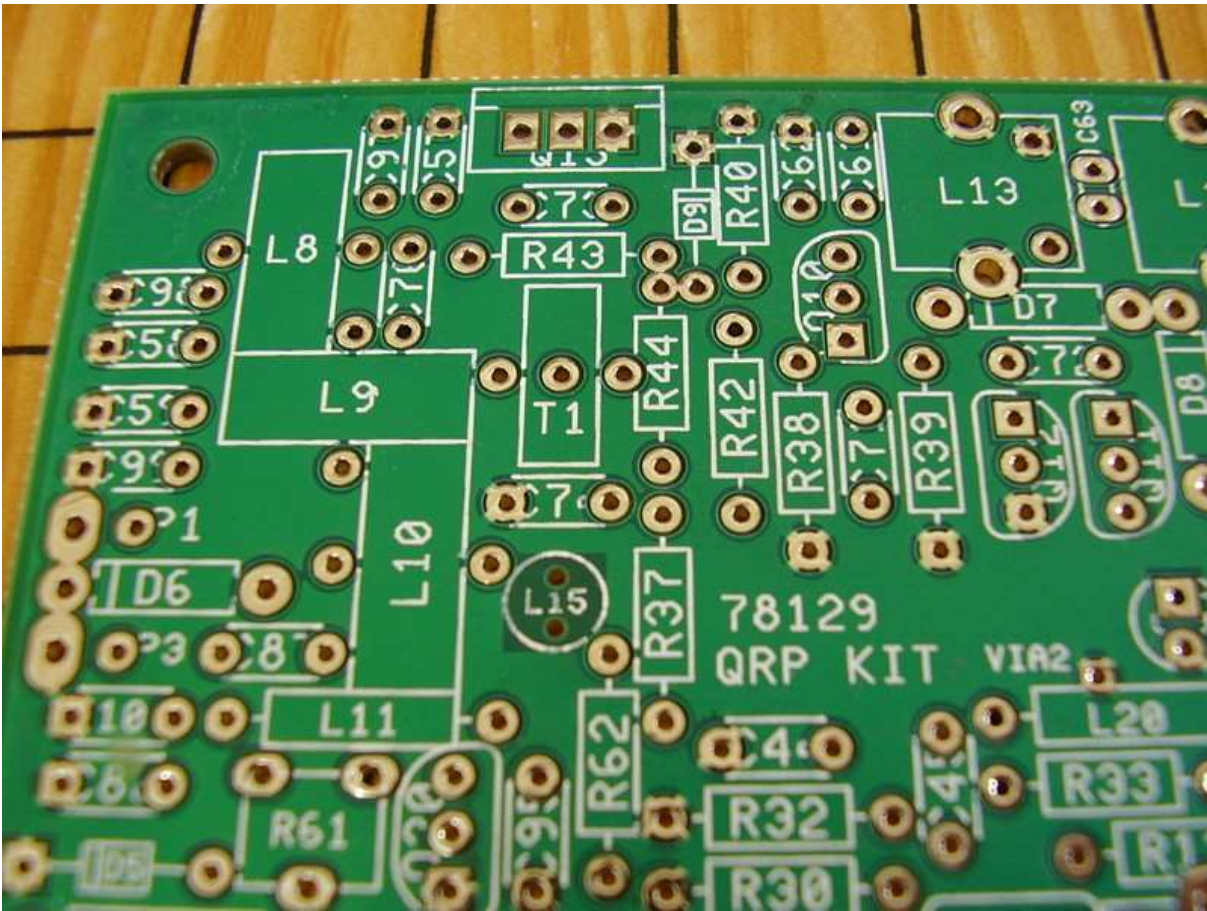

Figure 2.24: Upper Left Hand Quadrant.

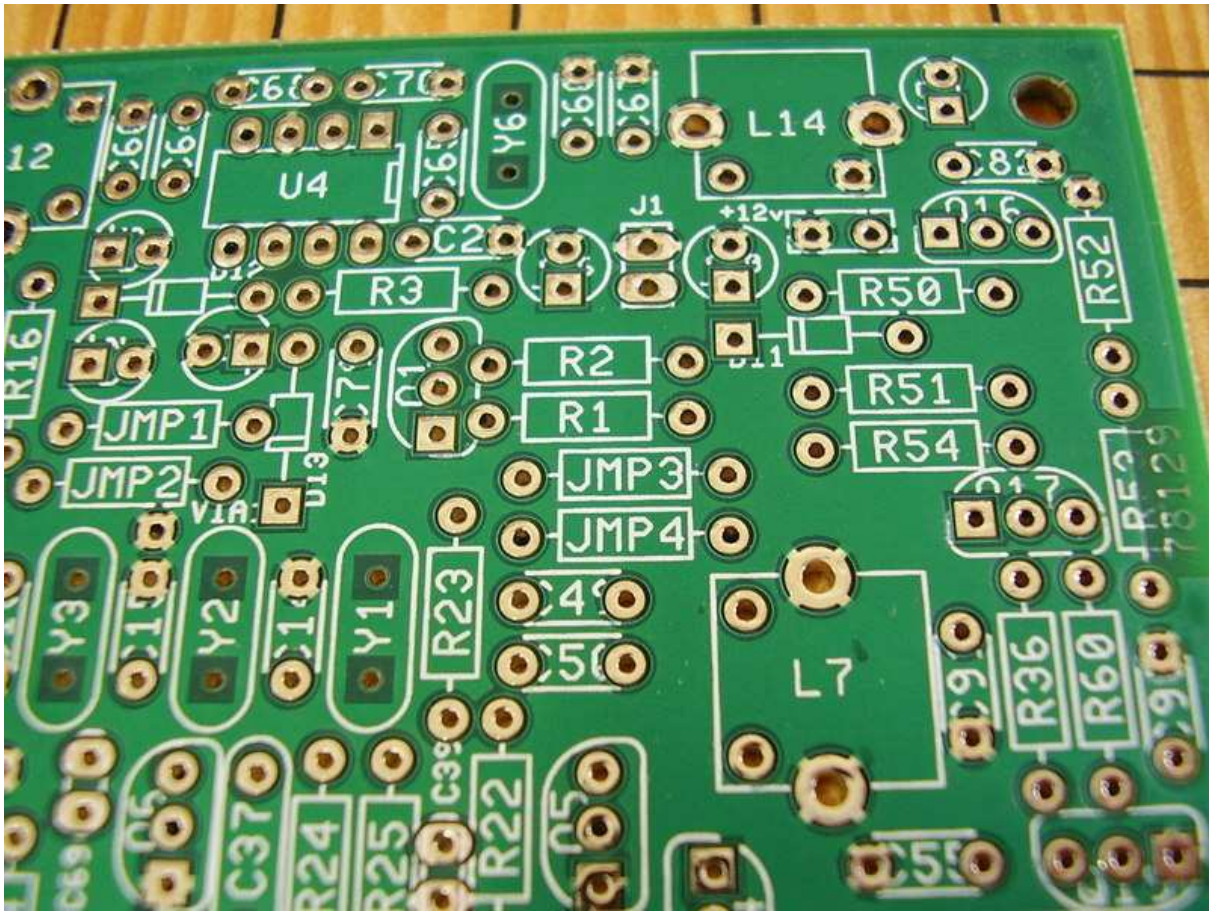

Figure 2.25: Upper Right Hand Quadrant.

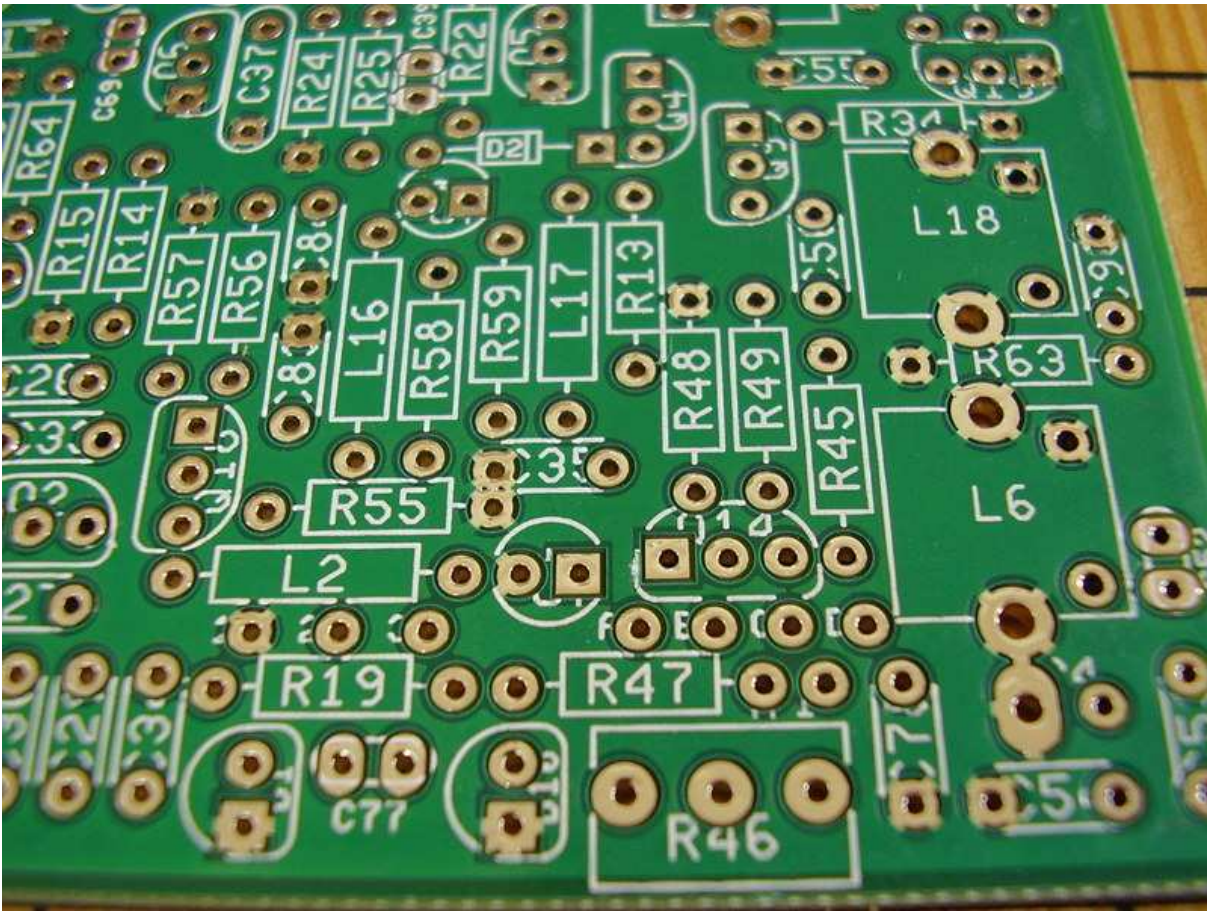

Figure 2.26: Lower Right Hand Quadrant.

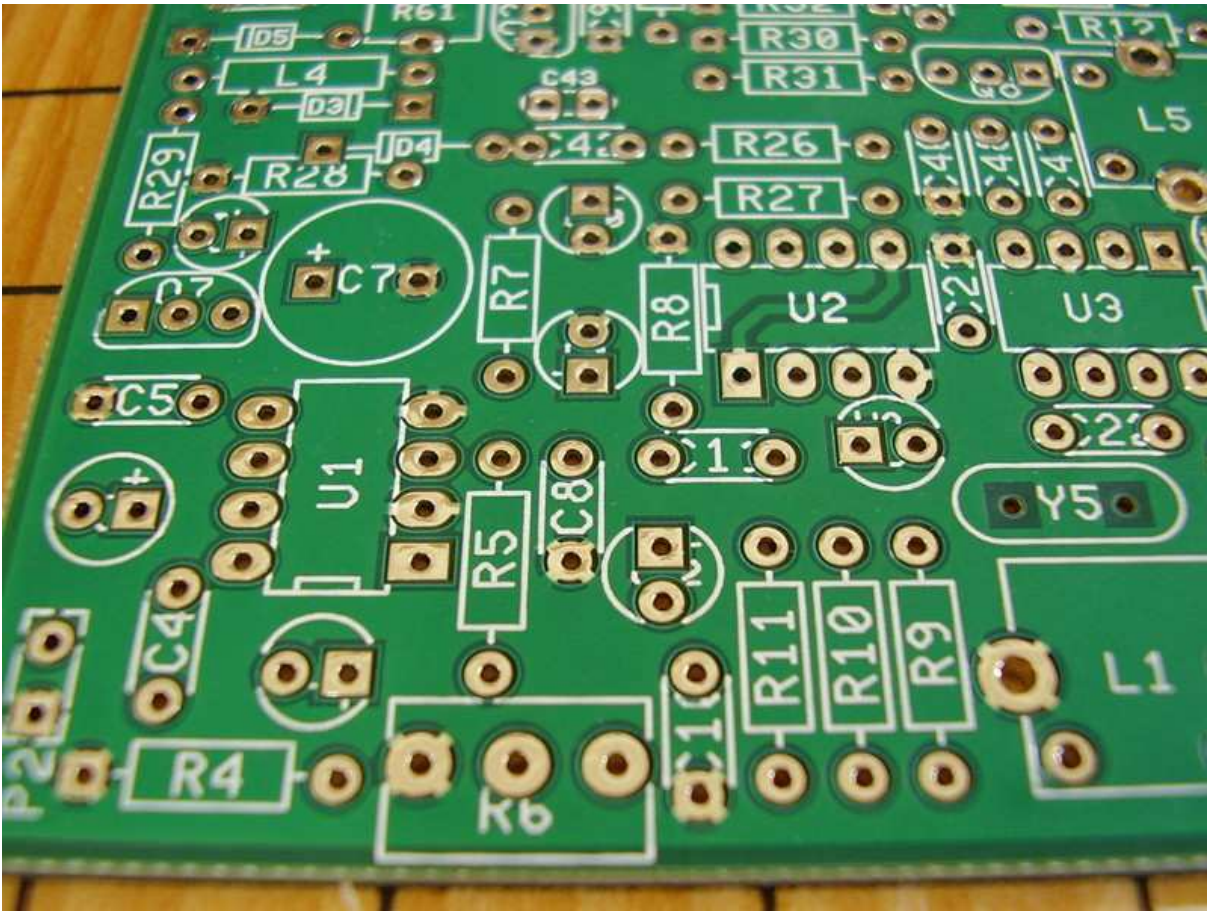

Figure 2.27: Lower Left Hand Quadrant.

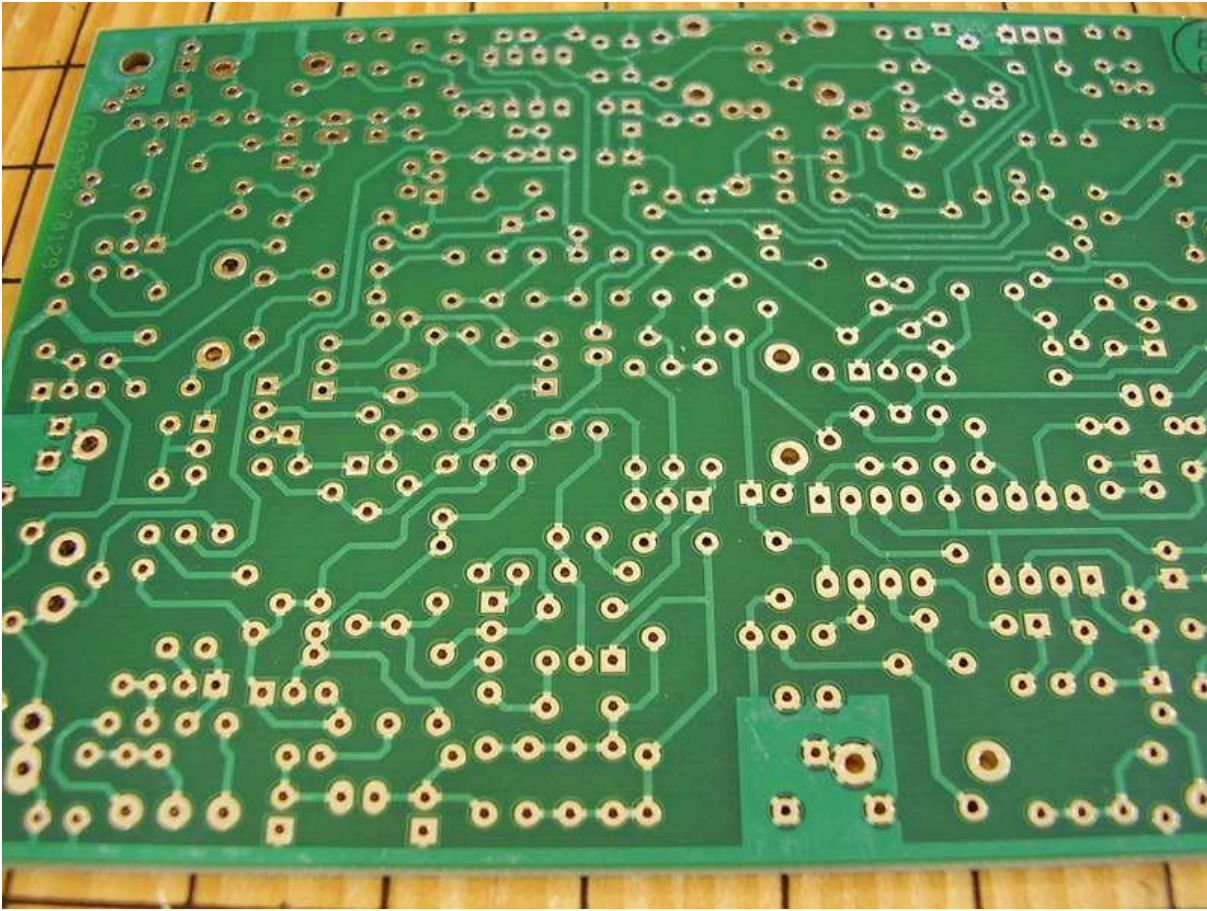

Figure 2.28: Bottom of Printed Circuit Board.

This is the side that we will apply solder to and heat to install the parts one at a time.



Figure 2.29: 2N2124 Transistors.

I mark the bags with part numbers, either with a small label as shown above or a magic marker pen. Keeps me from making a mistake and speeds up the process of parts selection by not having to use the magnifier over and over.

Chapter 3

Phase 1.0 - Keying and DC Input Circuits

Phase 1.0 will install the parts needed for the transceiver keying and DC input circuits. Here is the schematic for the section being built. The schematic is slightly different from the TenTec manual visually, but it is the same circuit.

PHASE 1.0

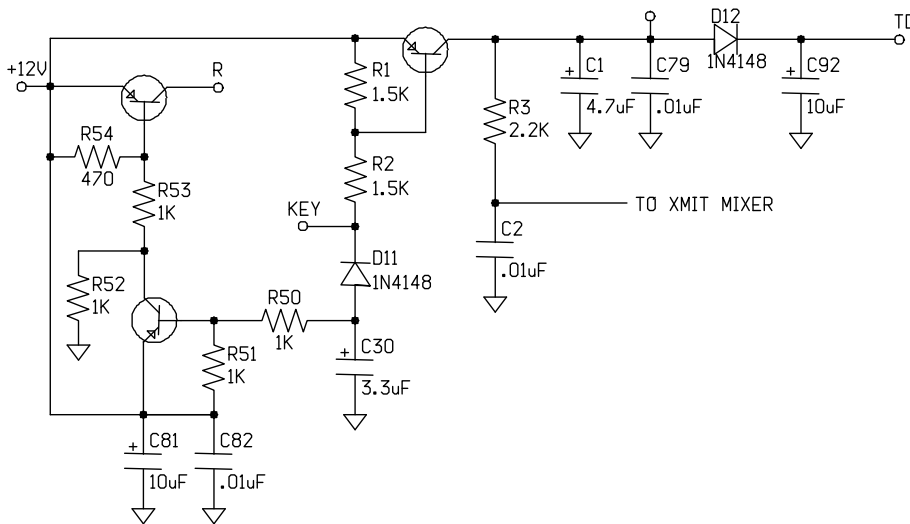

Figure 3.1: Phase 1.0 Schematic.

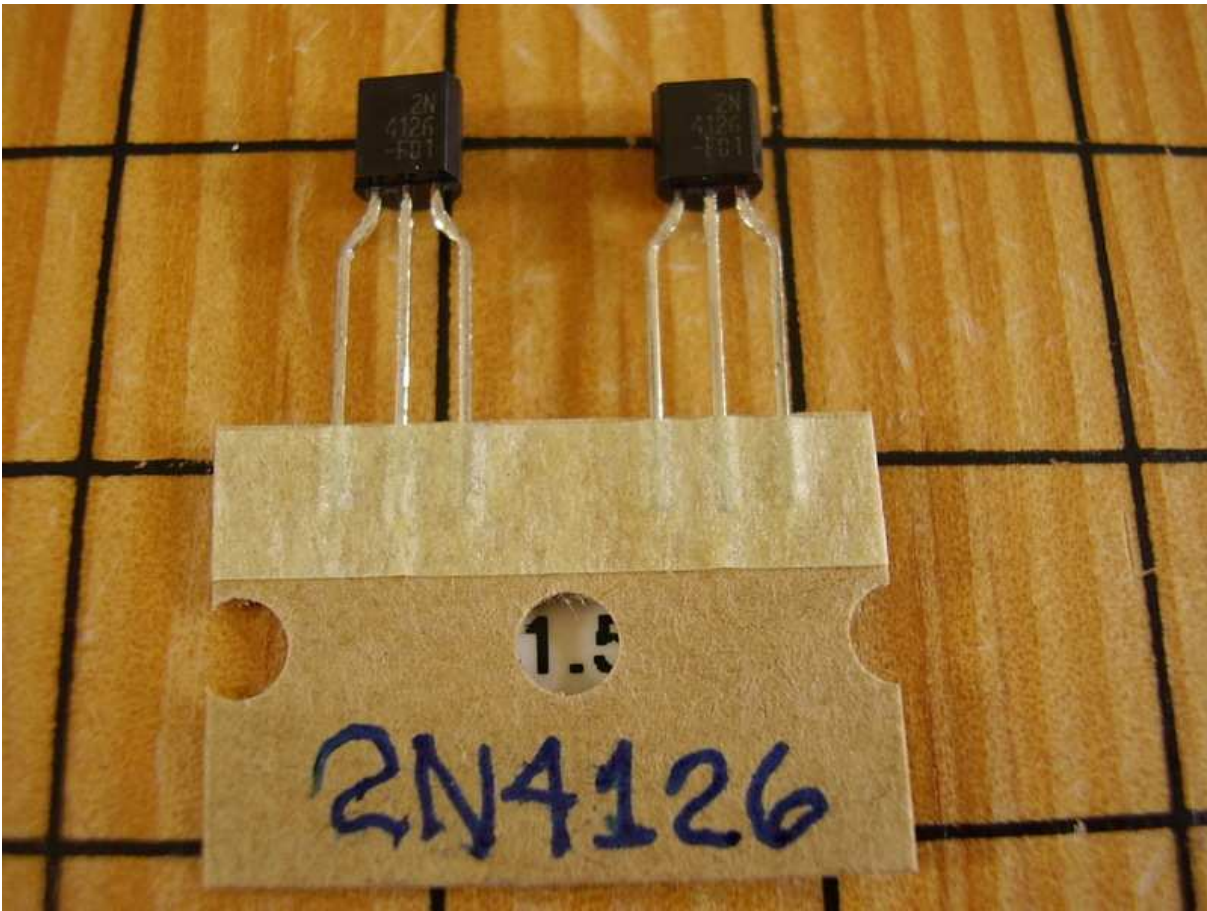

Figure 3.2: 2N4126 Transistors.

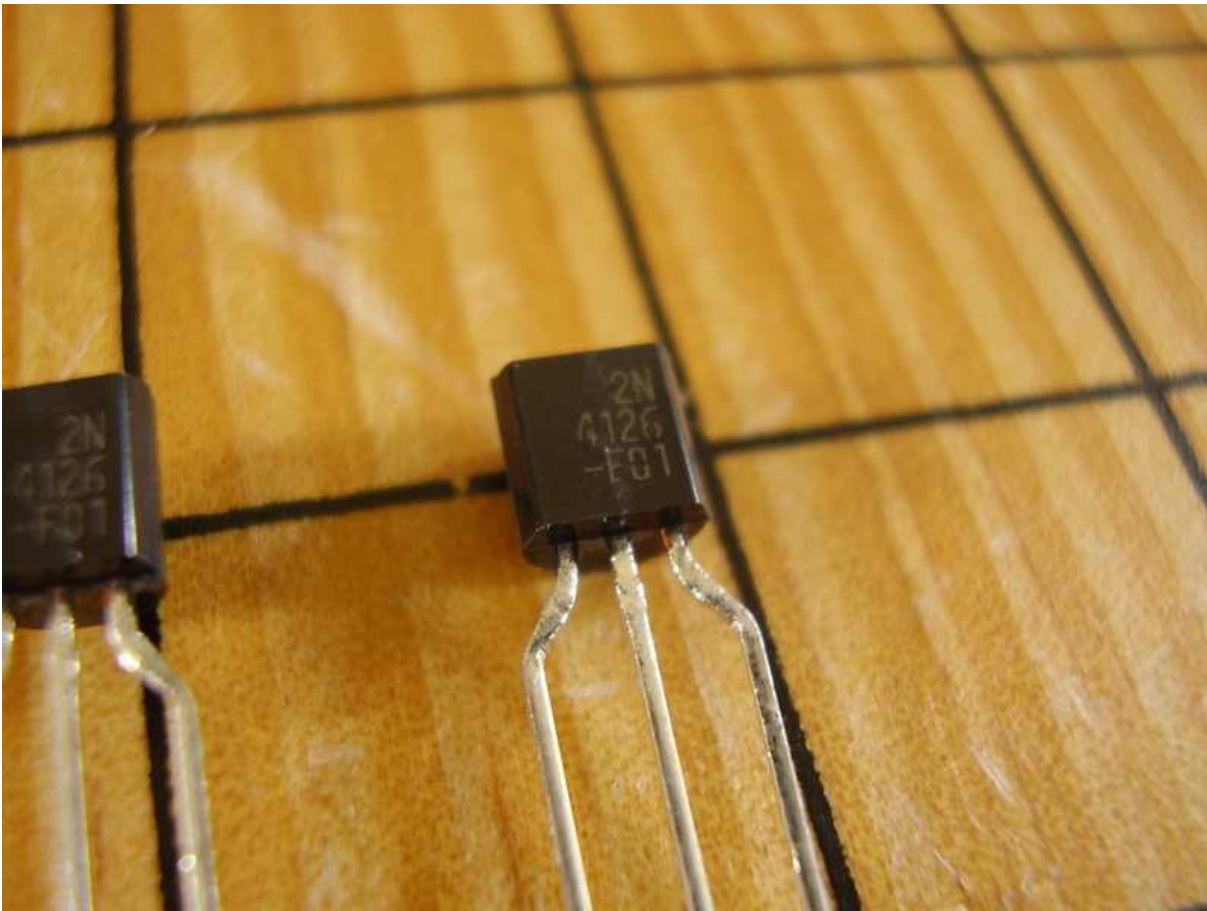

Figure 3.3: Closeup of 2N4126 Transistors.

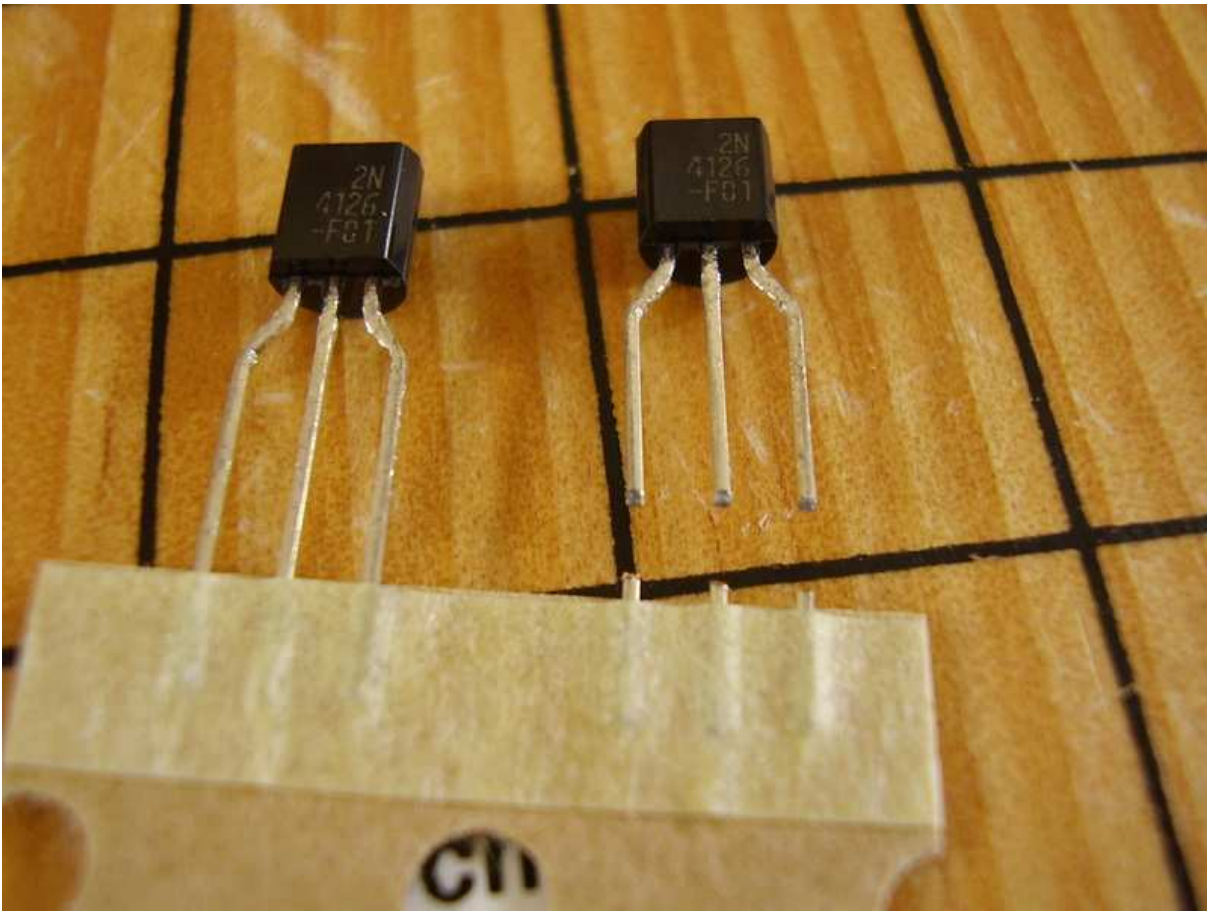

Figure 3.4: 2N4126 Transistor Removed.

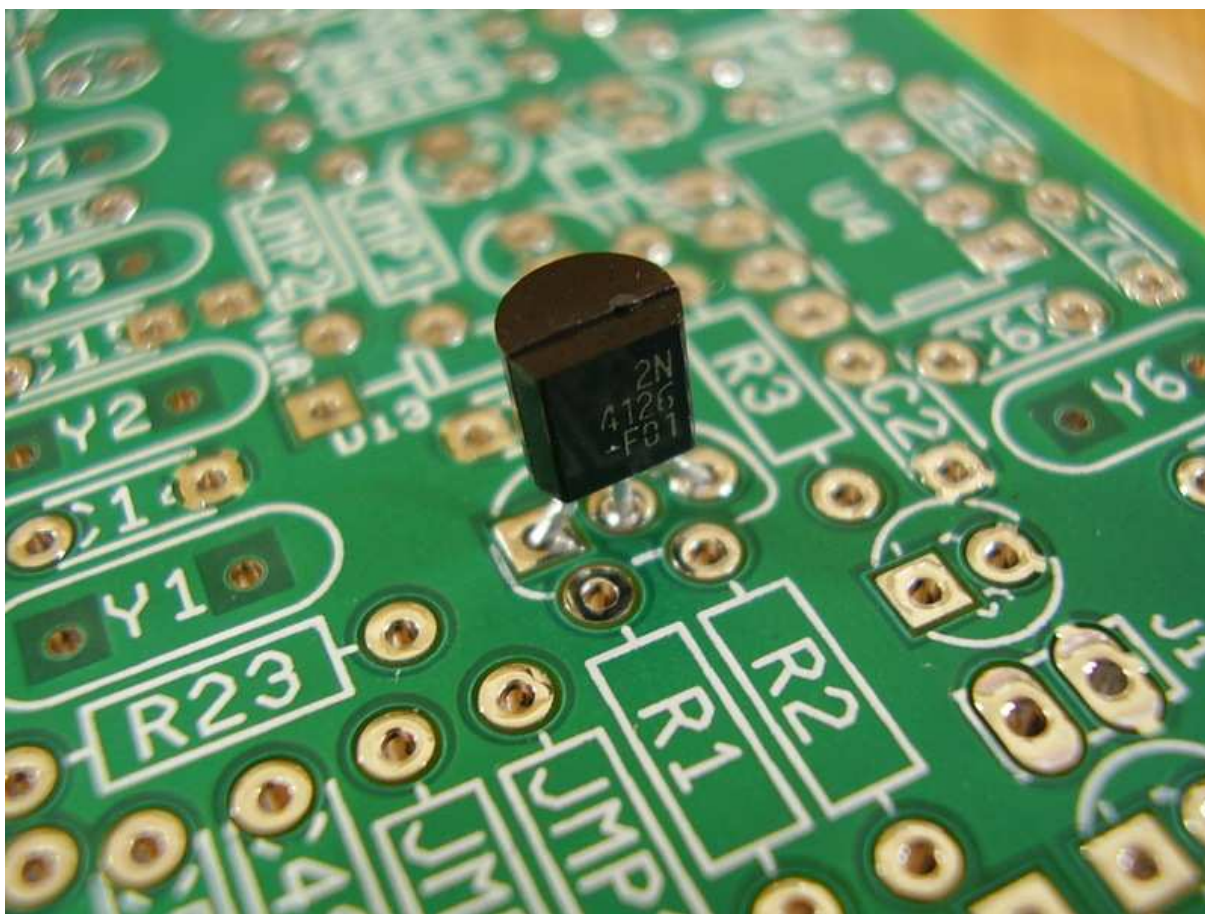

Figure 3.5: 2N4126 Transistor in Place.

Place the transistor in the proper holes and hold it in place and then bend the two outer leads about 45 degrees to hold in place as shown in the next slide. I do not bend them further, just in case I later need to remove the part.

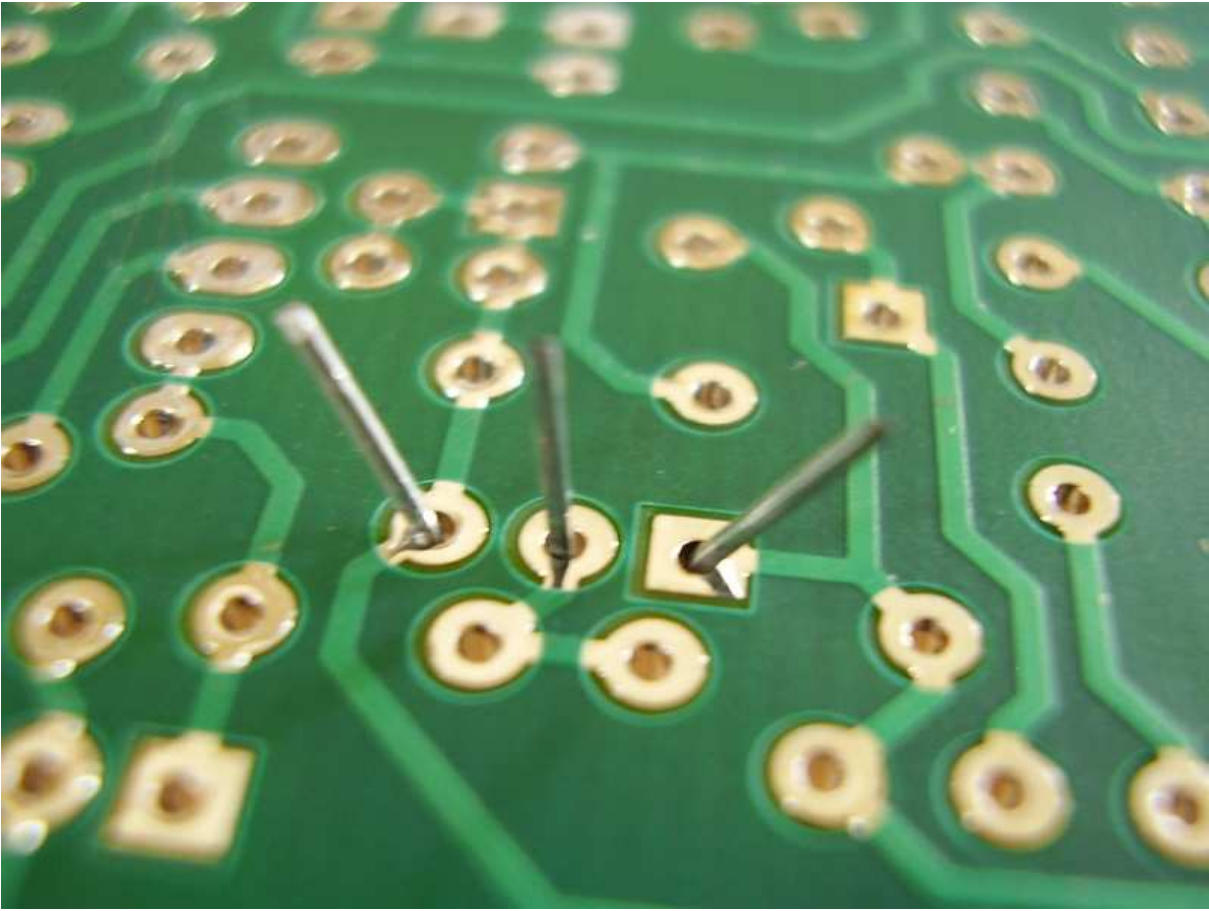

Figure 3.6: Bend outside leads 45 degrees.

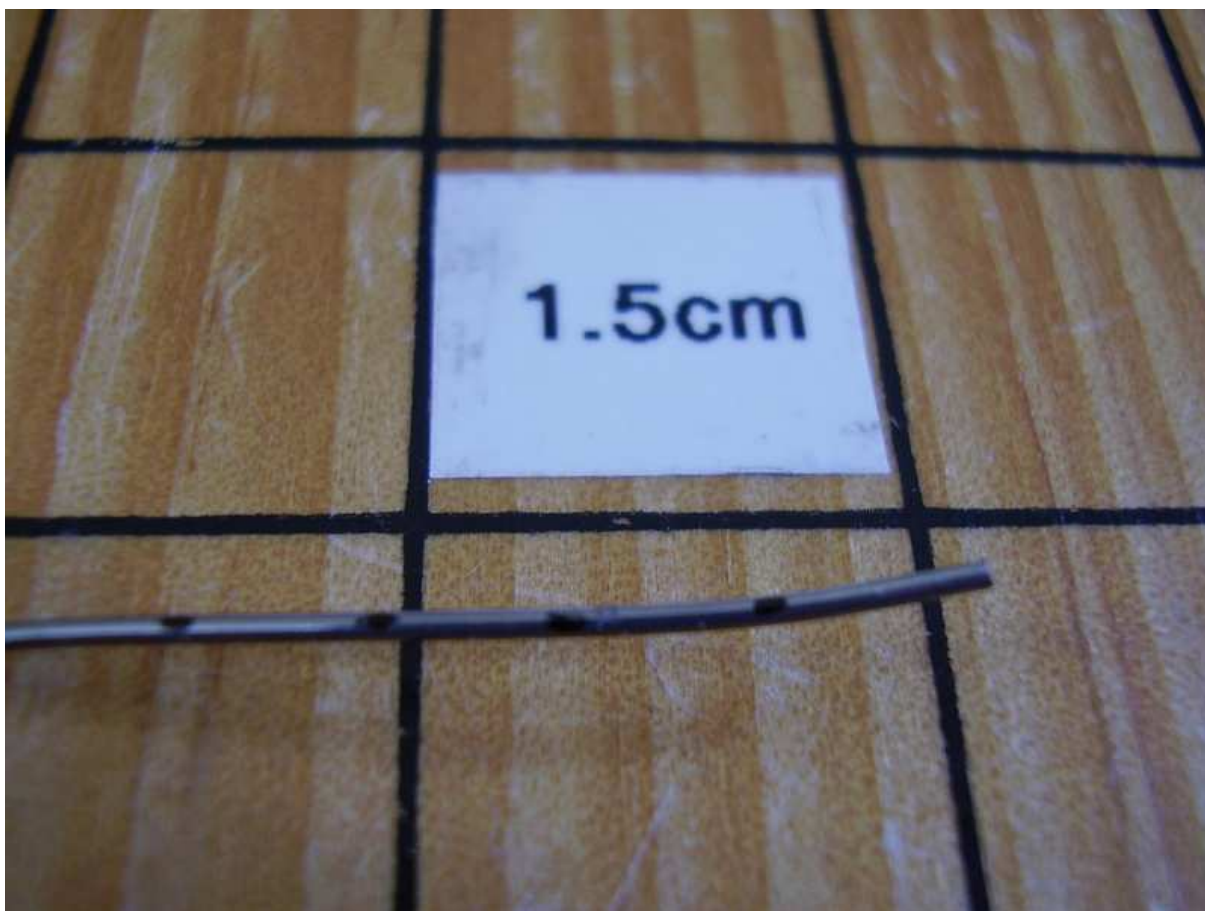

Figure 3.7: 0.5cm Solder Markings.

You might want to experiment with your first soldering by marking 1/2 cm lengths on the solder. Then, while following the soldering instructions in the manual, use about 1 cm to make the first soldering joint. I use about 1cm and I use what I call the 3-second rule. I heat the lead and pad about 3 seconds while applying a small amount of solder (the 1cm). Beginners tend to use too much and it doesn't help and using too much can cause more problems than it solves.

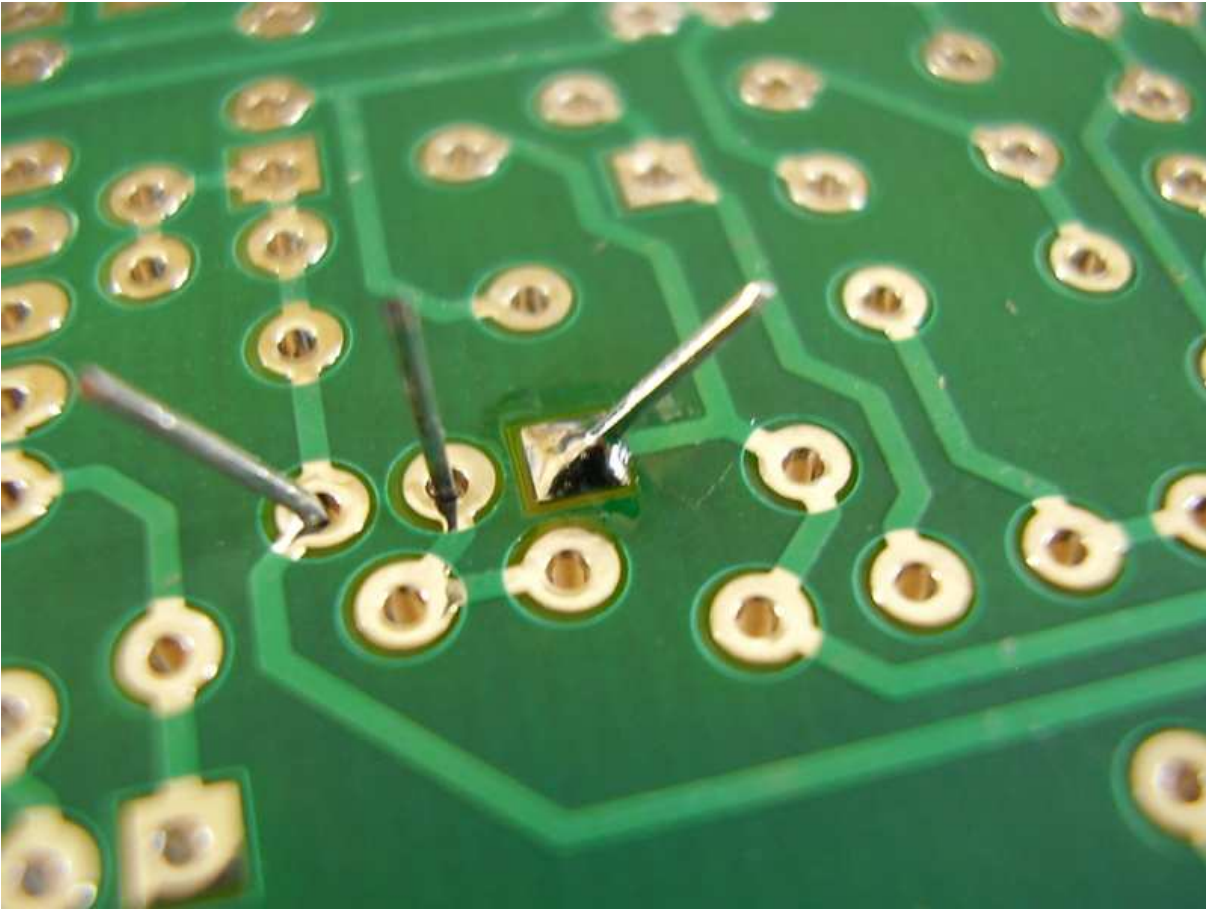

Figure 3.8: One Soldered Lead of Transistor.

Here is the soldered lead using the technique described.

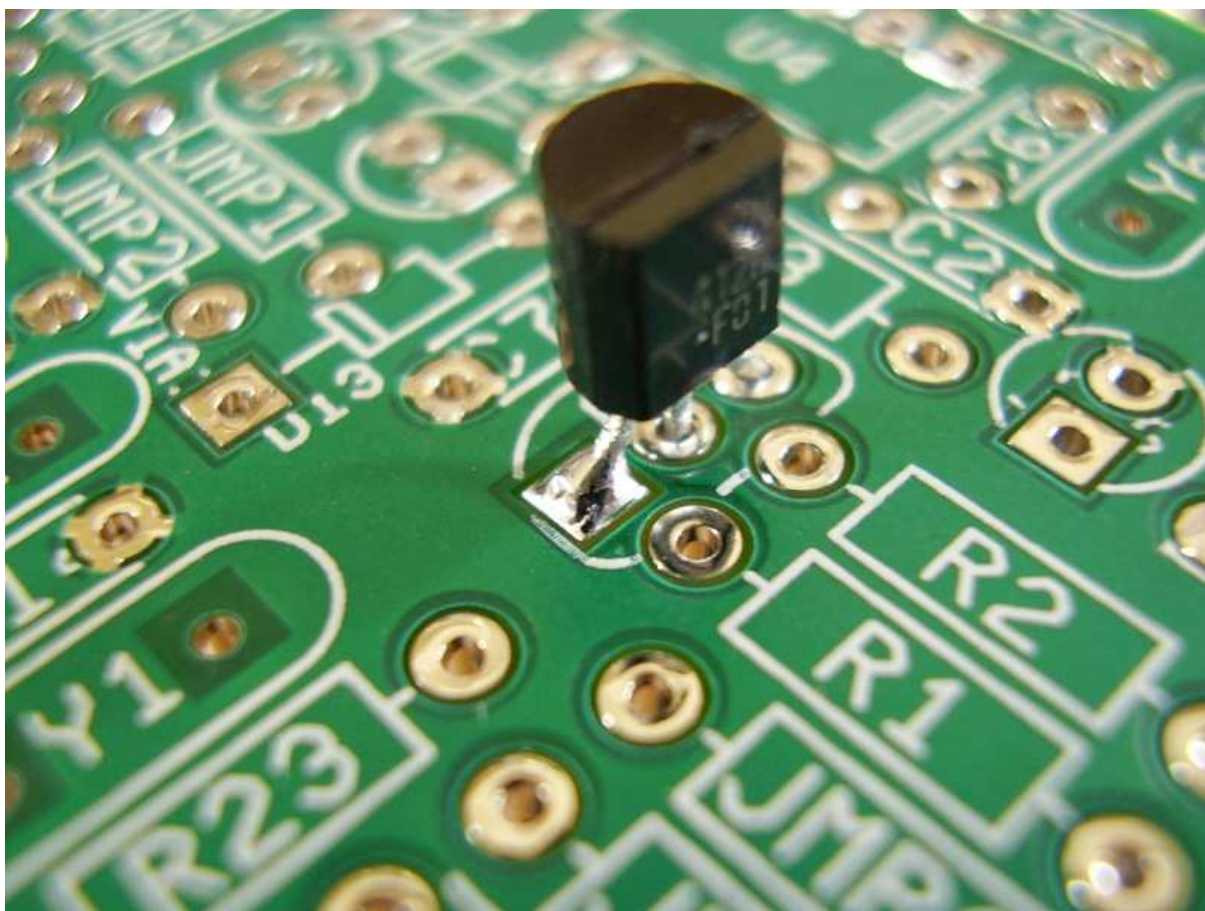

Figure 3.9: Component Side of Board.

Here is what the top side of the board looks like. The reason for the solder on the top side is mainly due (I think) the use of solder with 2 per-cent silver and when heating the lead and pad, make sure that you not cover too much of the hole so that the solder can 'wick' through to the other side. You do not have to have this good a soldering connection and it takes a lot of practice and a lot of time to do this.

And a warning. If you get this kind of soldering connection, remember it may take a lot of work to undo it, so double check parts values and location and don't lose your concentration.

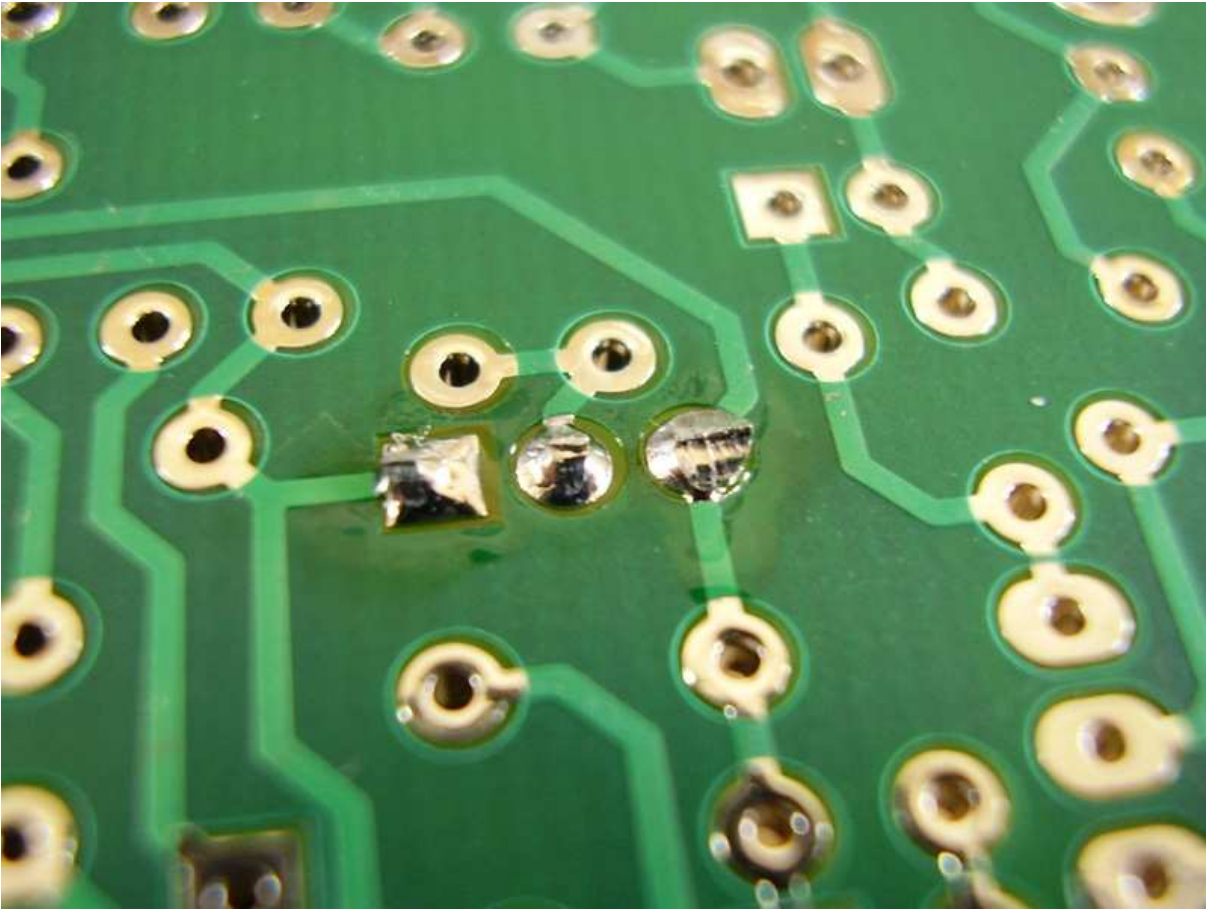

Figure 3.10: Cut Leads.

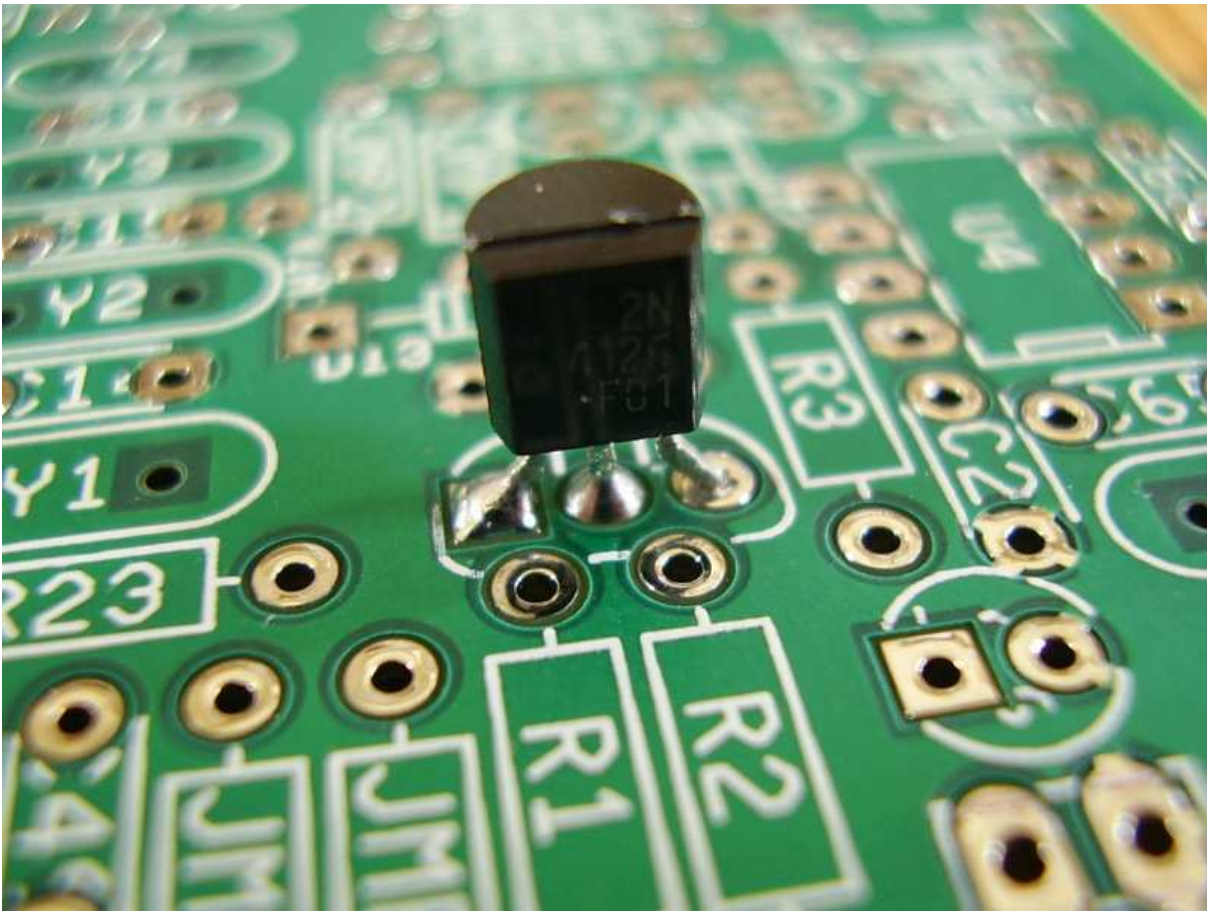

Figure 3.11: Component Side.

You can see the right-hand connection did not quite wick through like the other two, but it is not an issue, so move on to the next part.

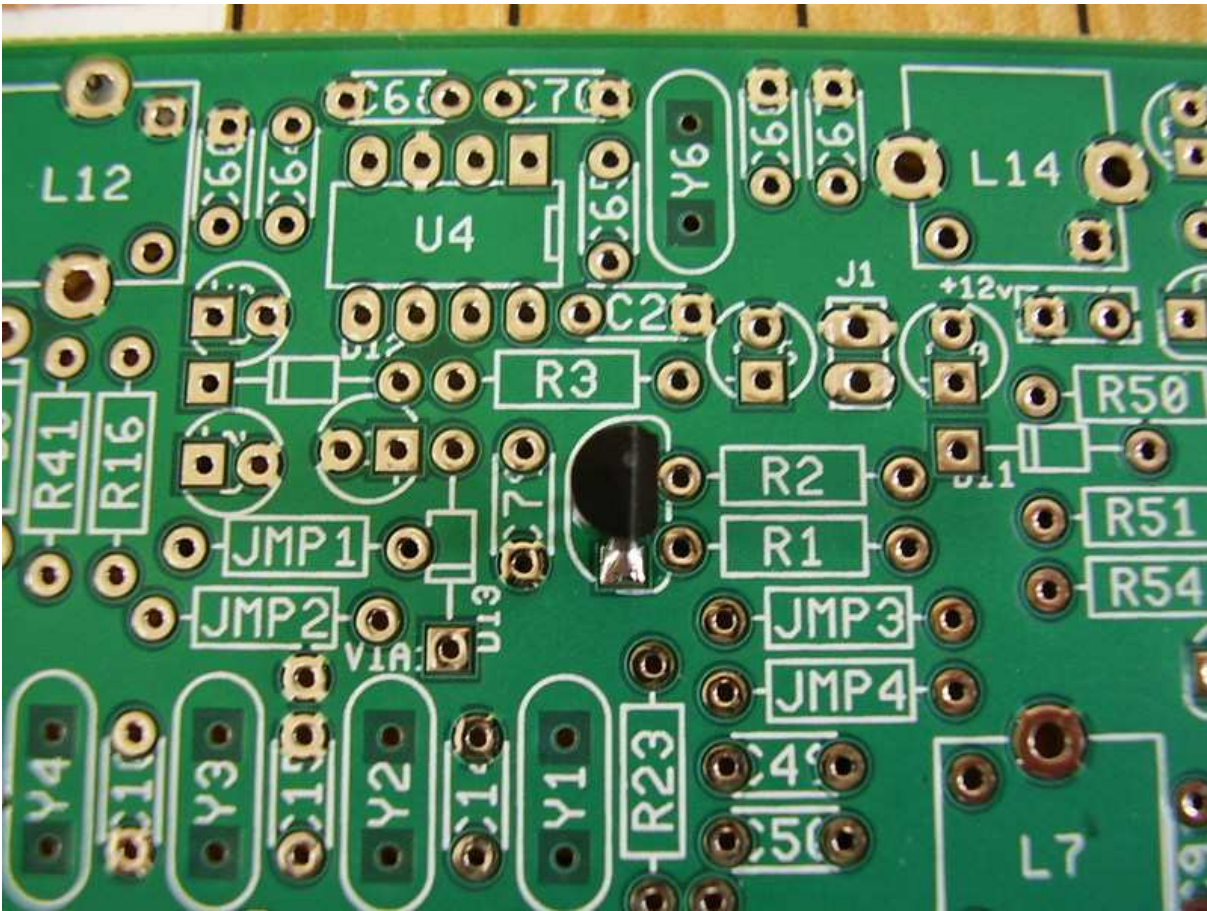

Figure 3.12: Top View.

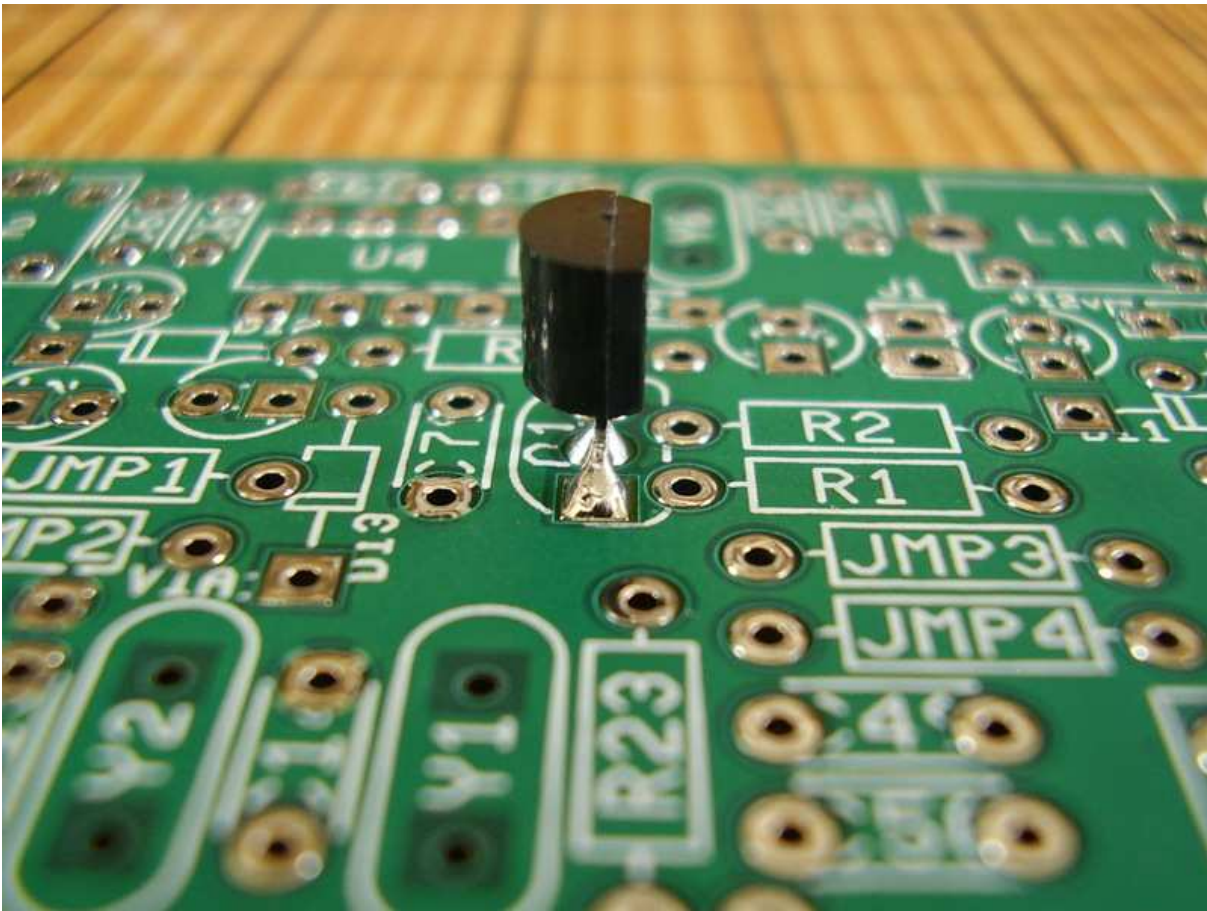

Figure 3.13: Side View.

I like to have parts vertical and aligned with the silk screened outline on the board.

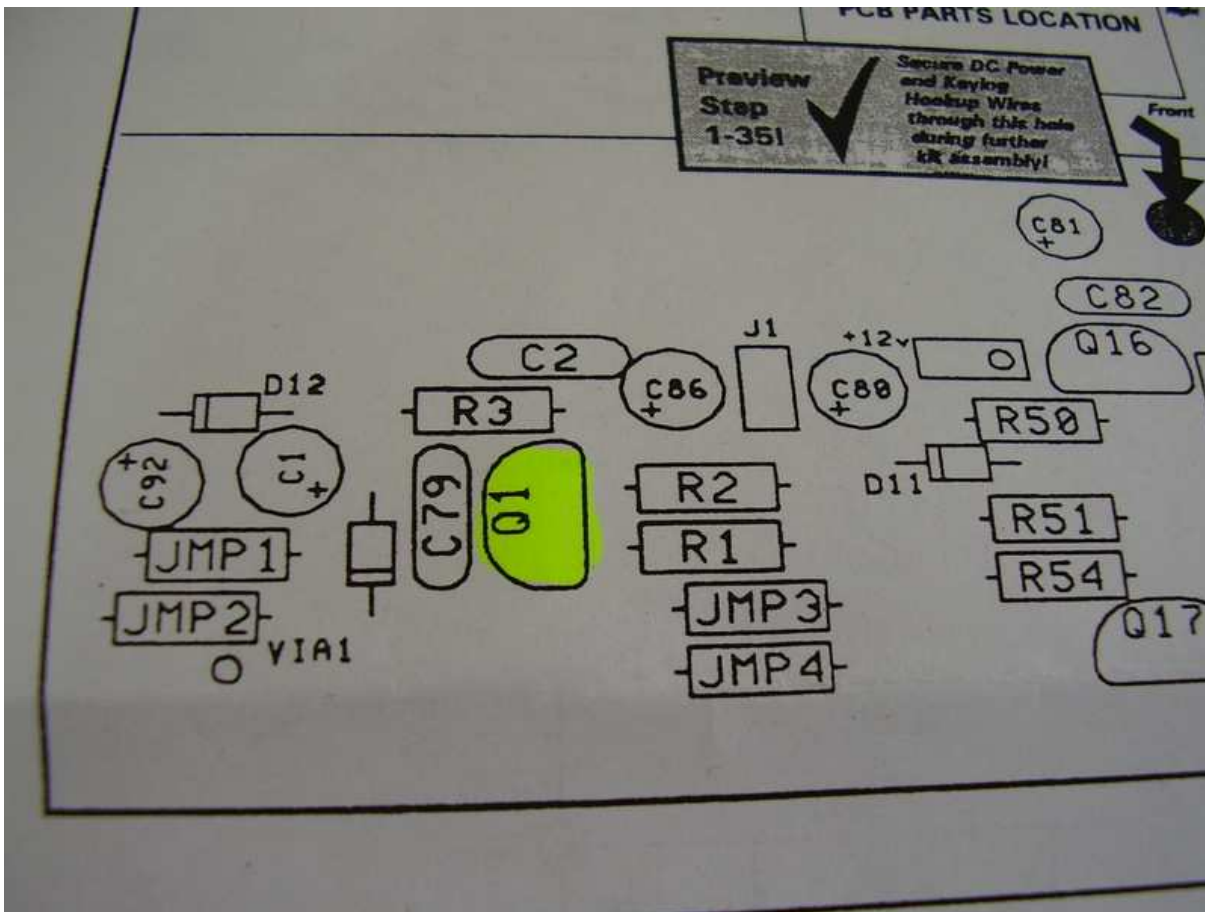

Figure 3.14: Highlighted Q1.

It helps me to highlight parts as I go along to keep track and later make the next part location easier to find.

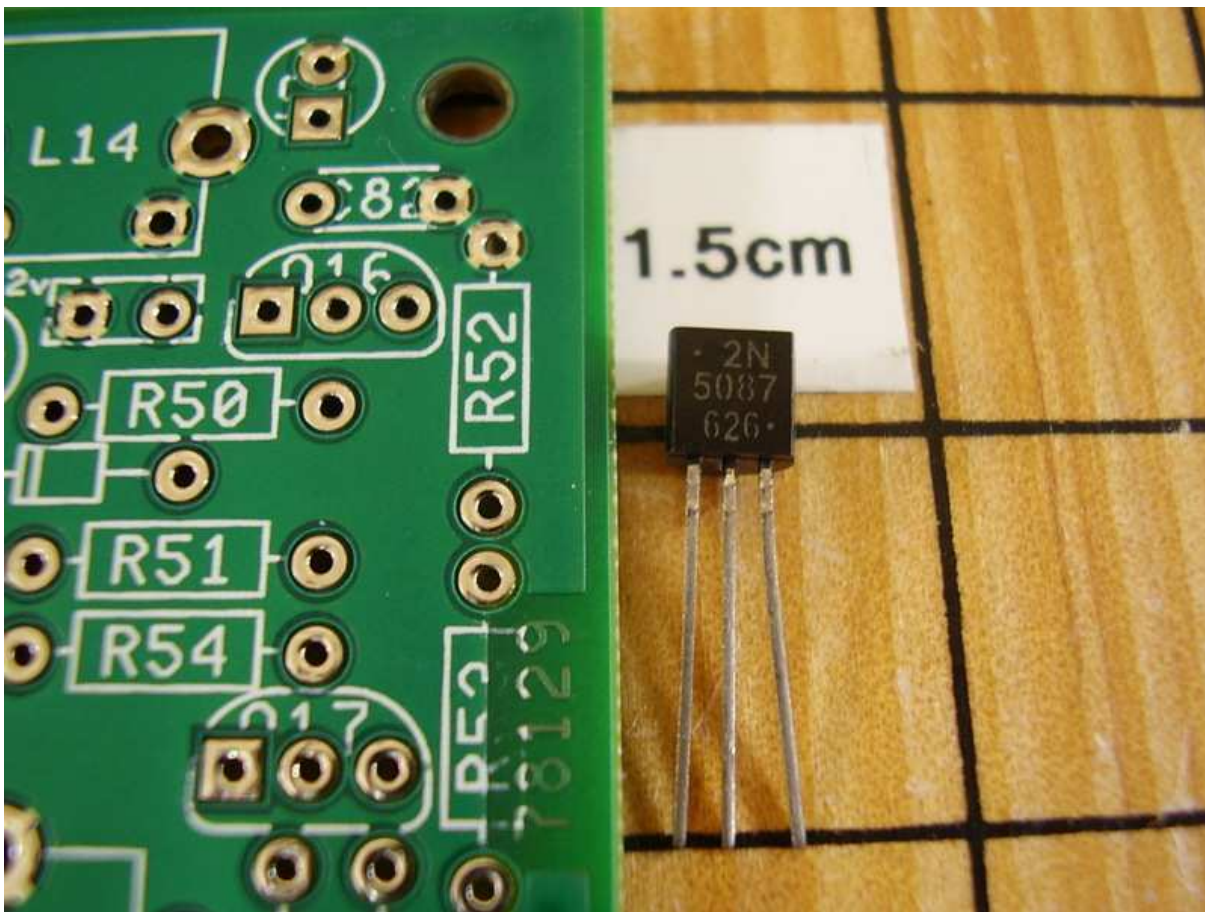

Figure 3.15: 2N5087 Transistor.

This transistor does not have its leads formed as the 2N2124 did. Don't try to bend the leads to the same form. Just insert the leads into the printed circuit board and gently (very gently) push it into place as shown in the next slide. It will easily move down until about 2mm or so and the tension will increase. Go no further as you may damage the part.

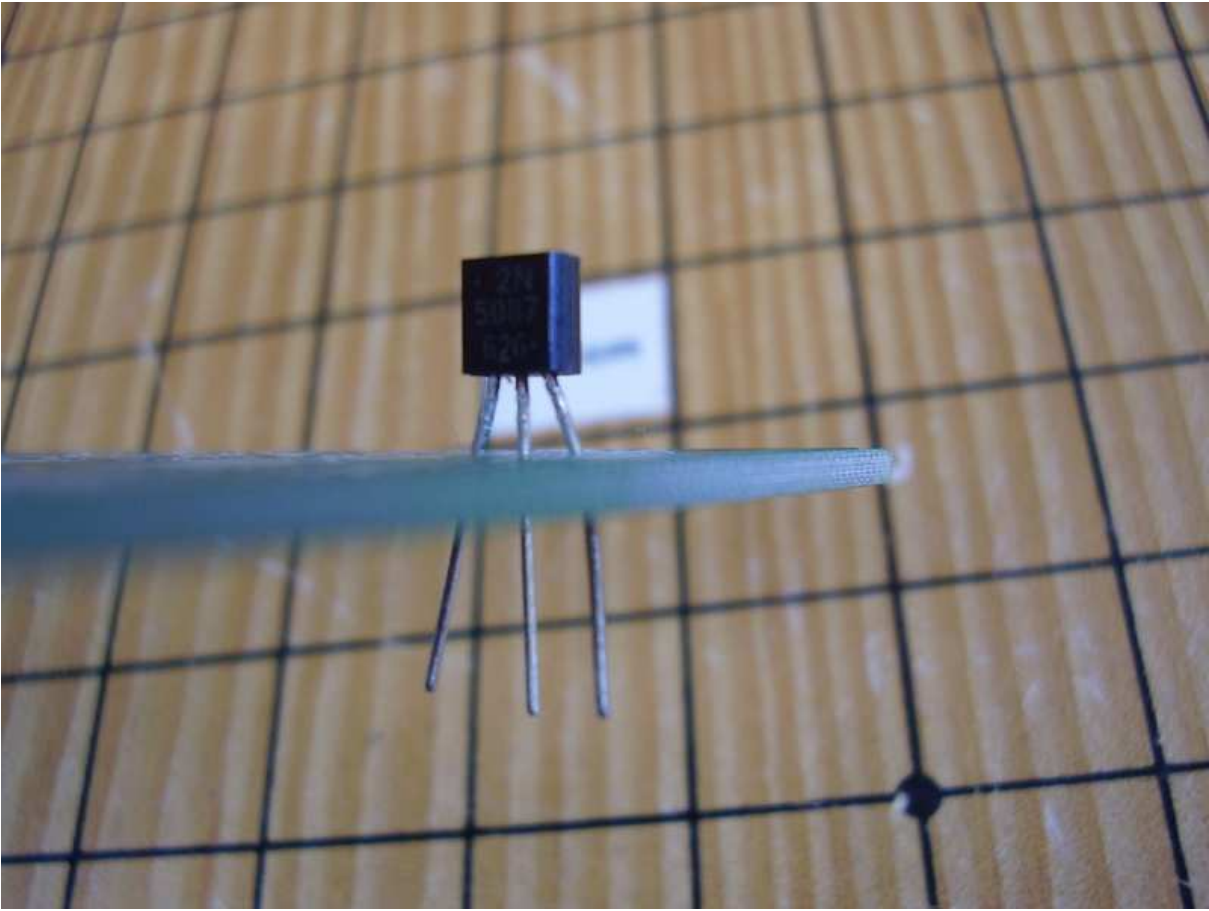

Figure 3.16: Side View.

Here it is in place.

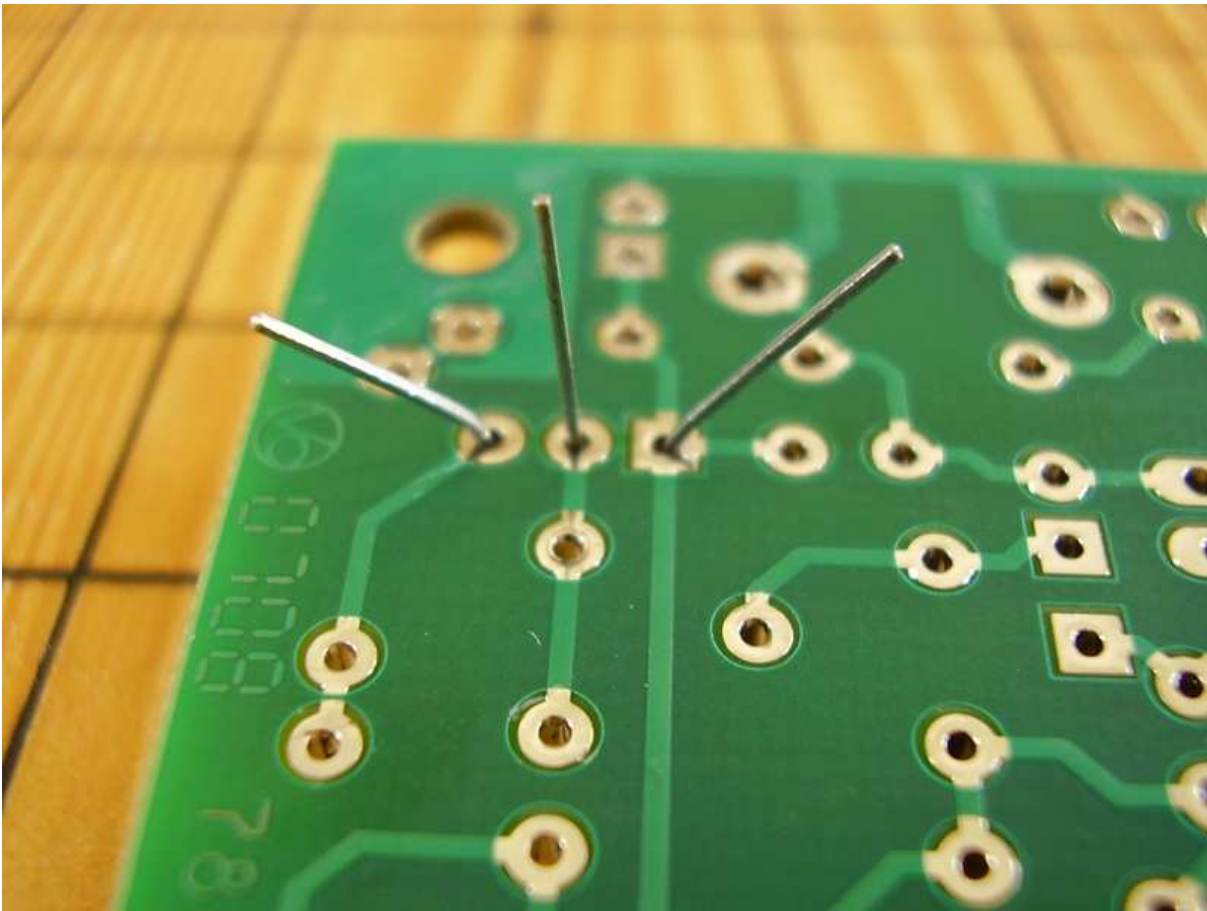

Figure 3.17: 45 Degree Bends.

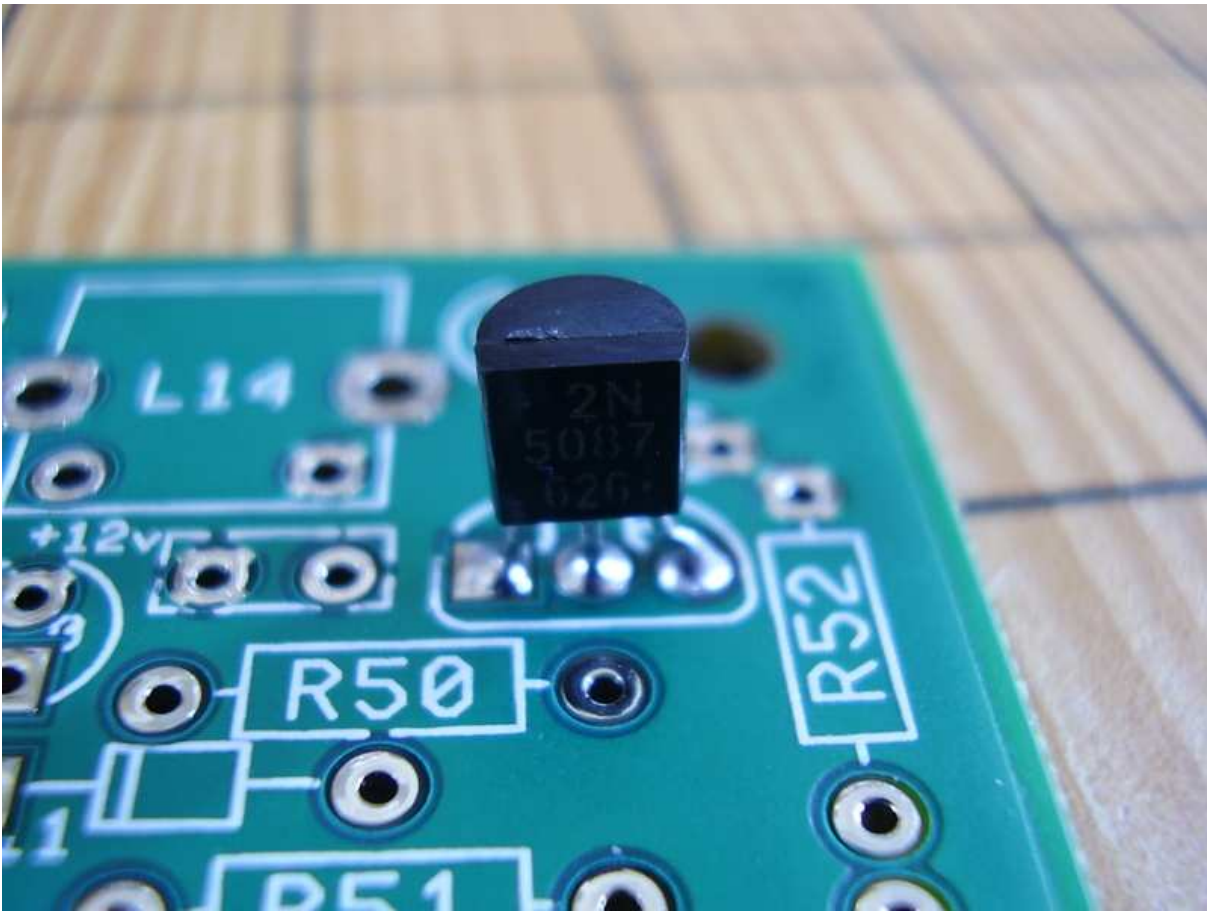

Figure 3.18: [1-2] Q16 Soldered Leads.

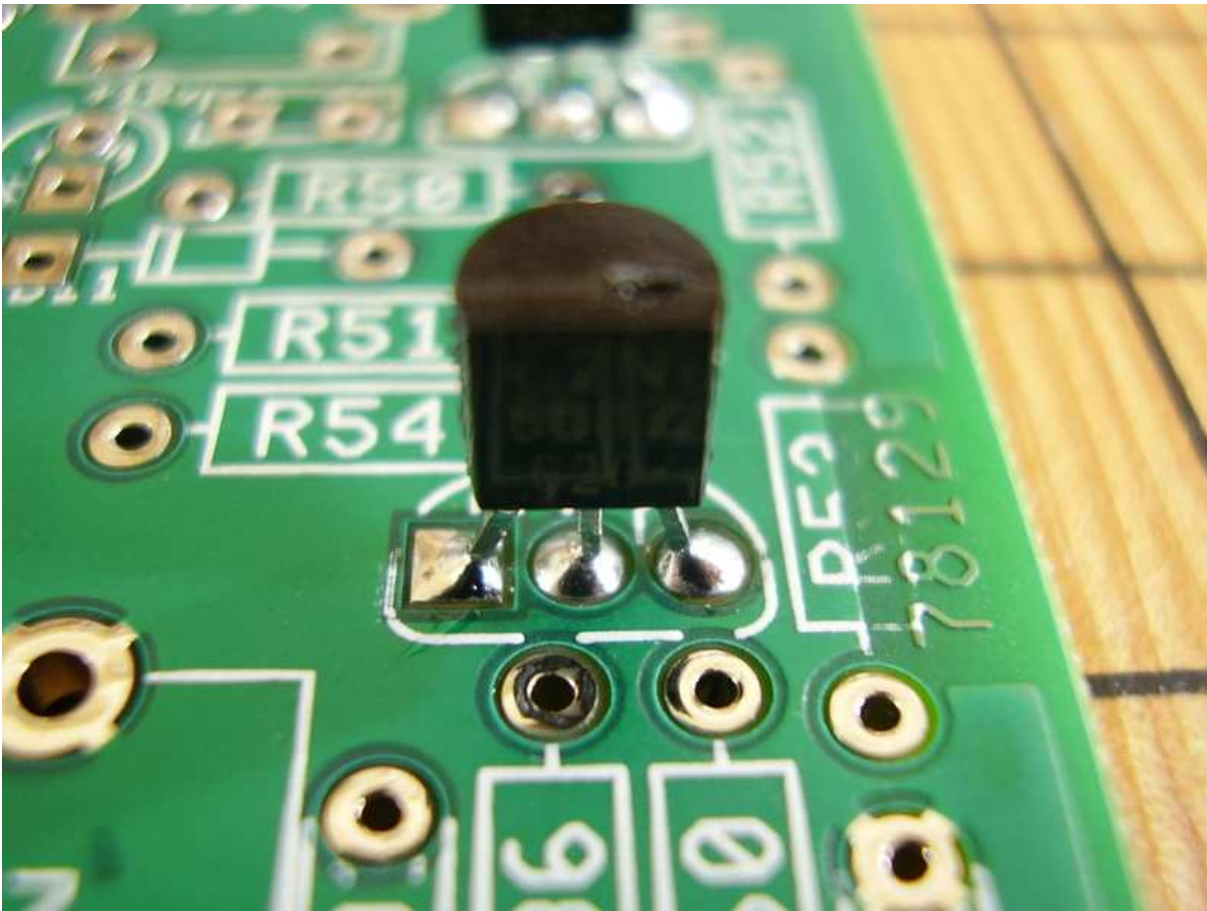

Figure 3.19: [1-3] Q17 Soldered in Place.

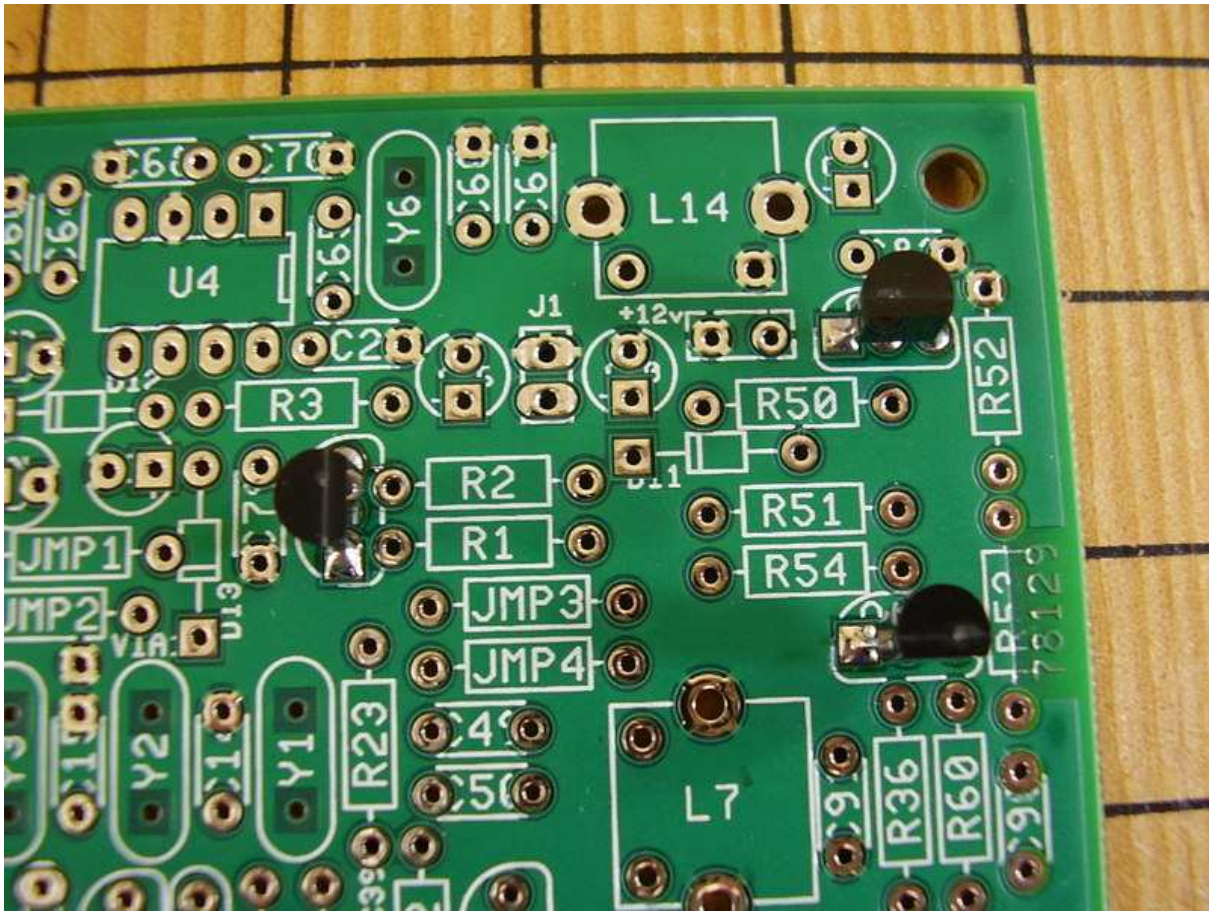

Figure 3.20: Top View of Q1, Q16 and Q17.



Figure 3.21: 1N4148 Diodes.

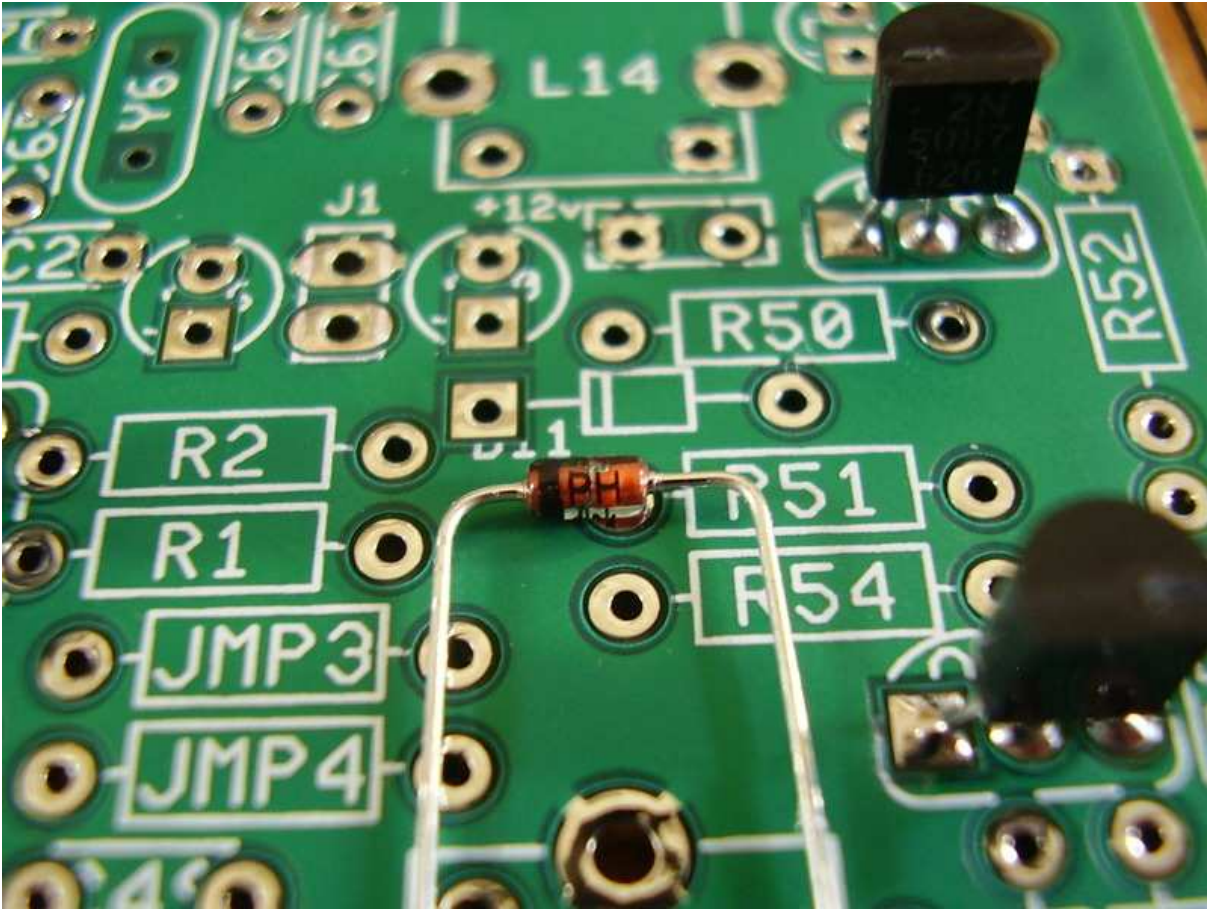

Figure 3.22: 1N4148 and D11 Outline.

I use the lead bender to bend the leads to this shape. It takes the end part of the bender to do this above the hole to get the right length, or you can just use the chain-nose pliers to gently bend the leads.

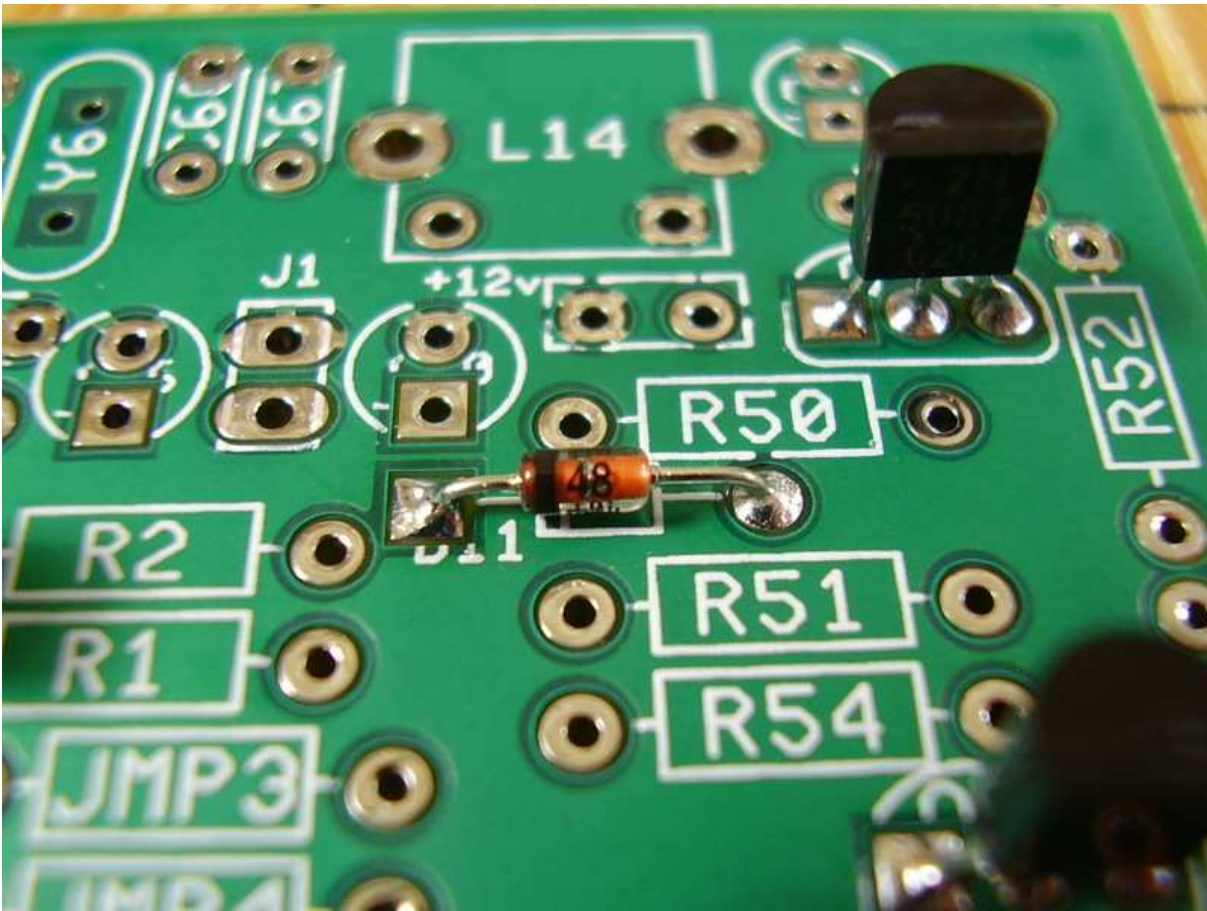

Figure 3.23: [1-4] D11 Installed.

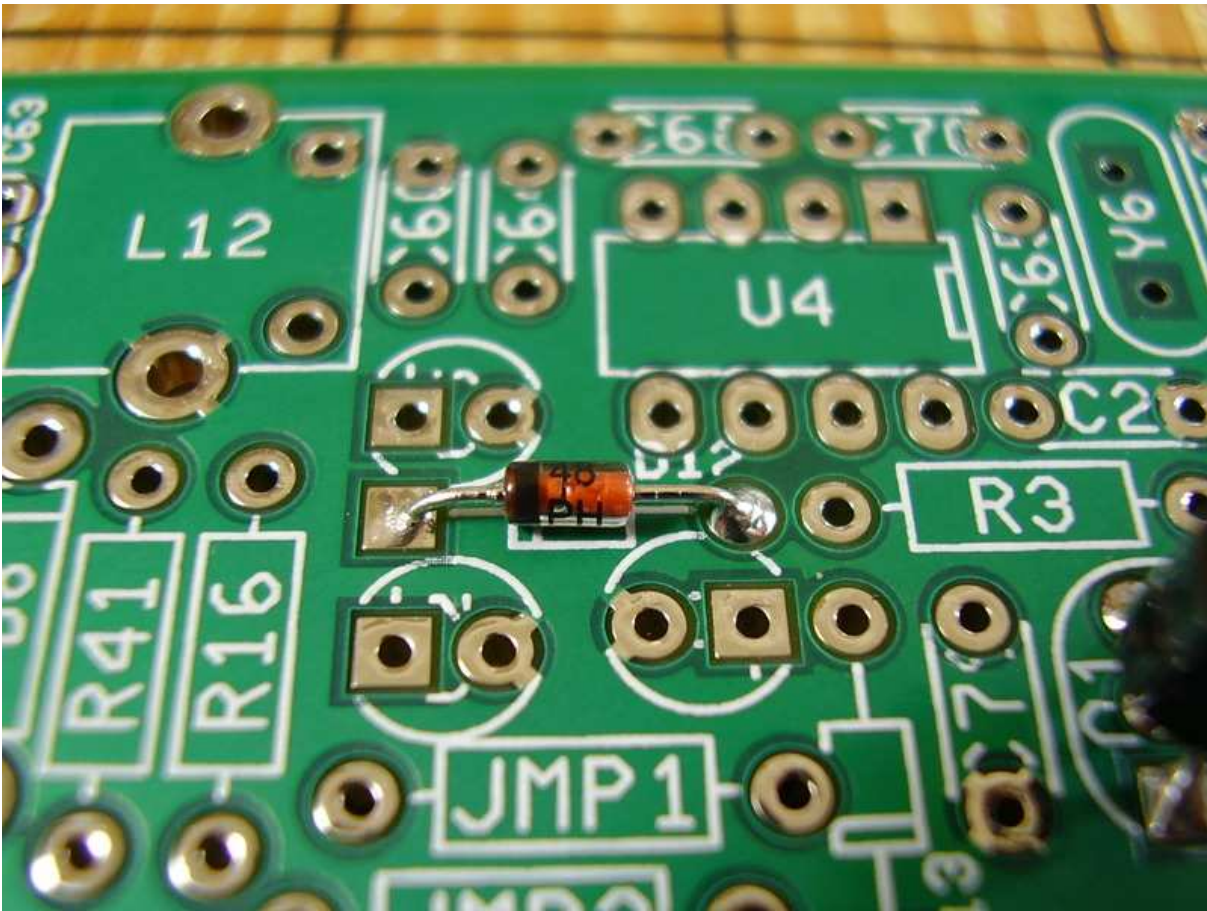

Figure 3.24: [1-5] D12 1N4148 Diode.

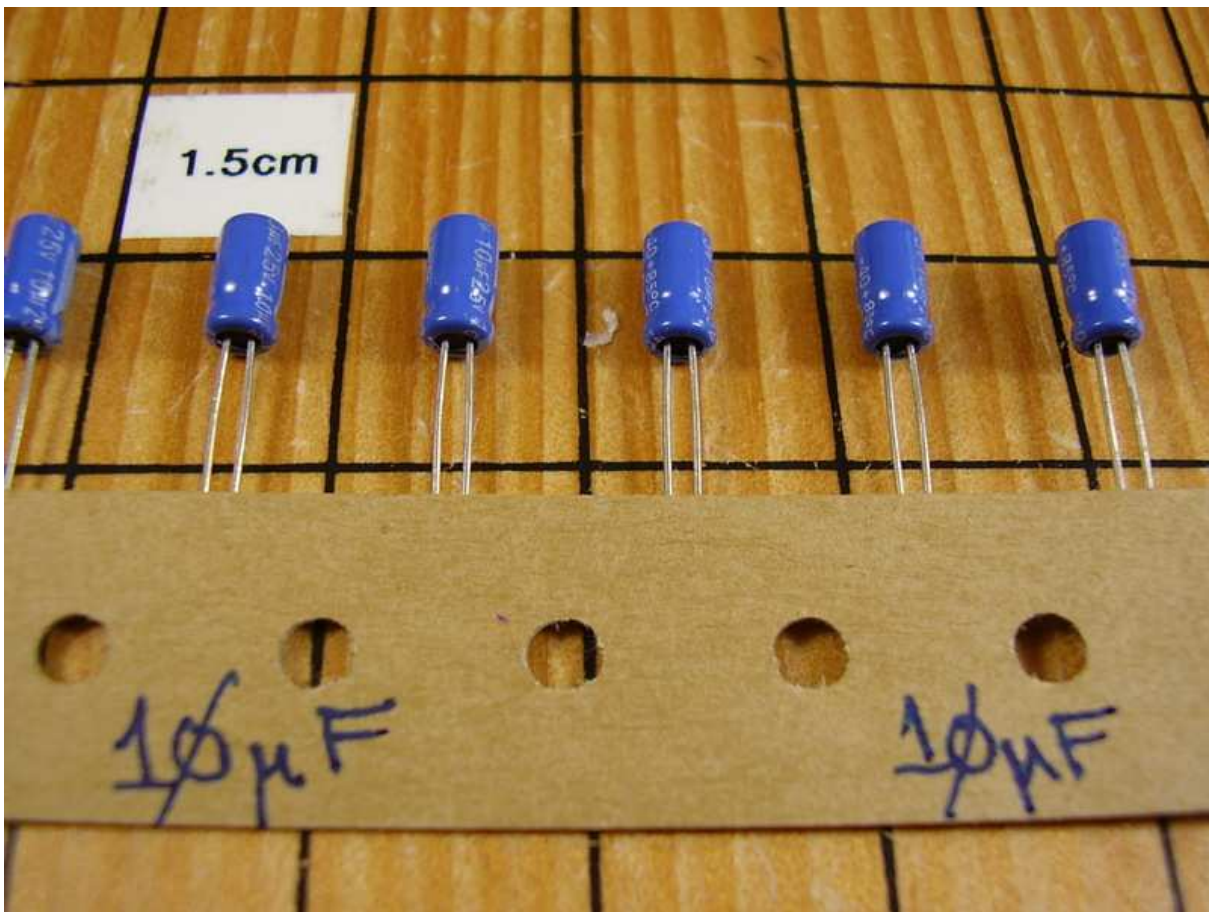

Figure 3.25: $10\mu F$ Capacitors.

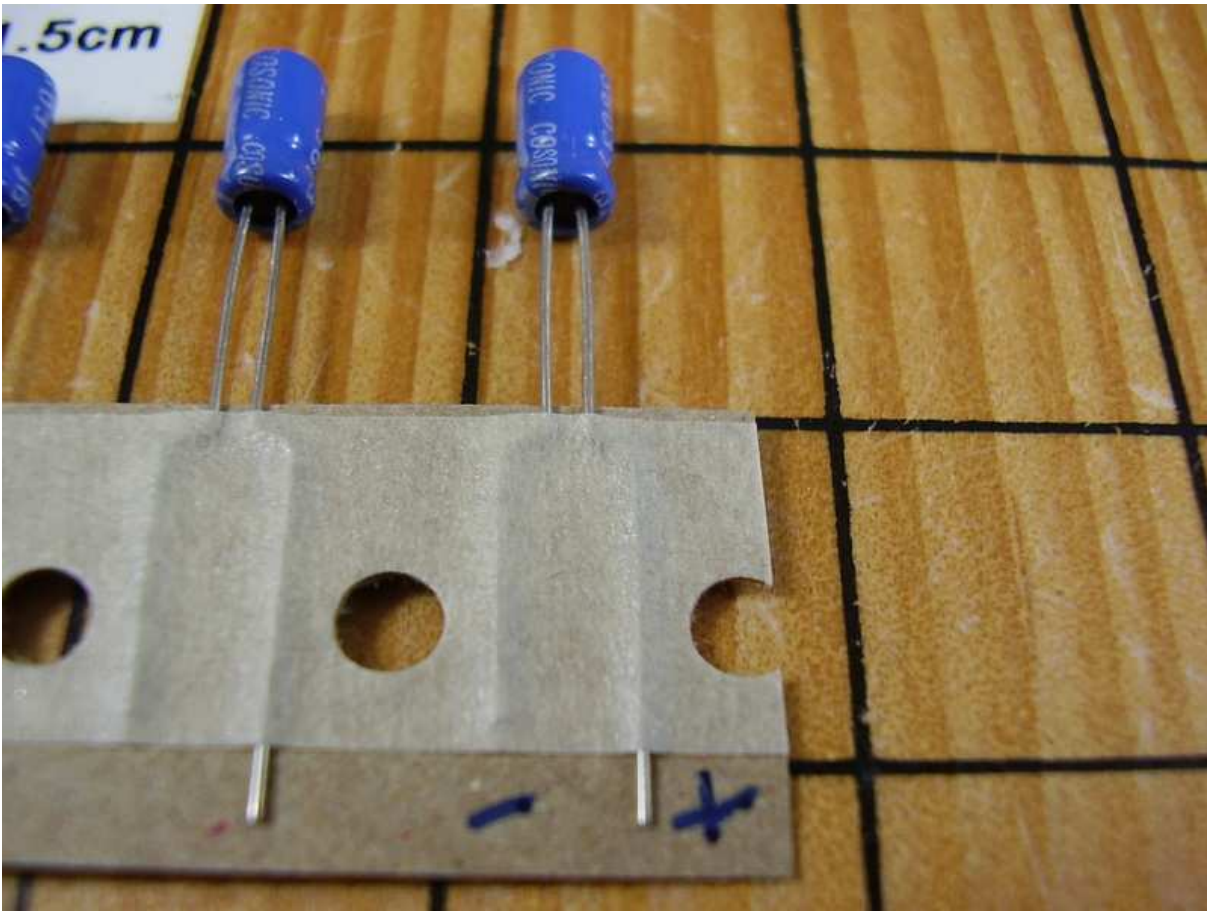

Figure 3.26: Positive (+) and Negative (-) Leads.

On the tape side of the strip you can see the short vs. long length of the lead. The positive lead (+) is the longer lead and you can also see the band on the negative side (-) with the negative sign.

When you cut the cap from the strip you won't have the length indicator, so observe the markings on the cap. The negative lead goes into the hole with the circular pad. The positive lead goes in to the hole on the pc board with the square pad.

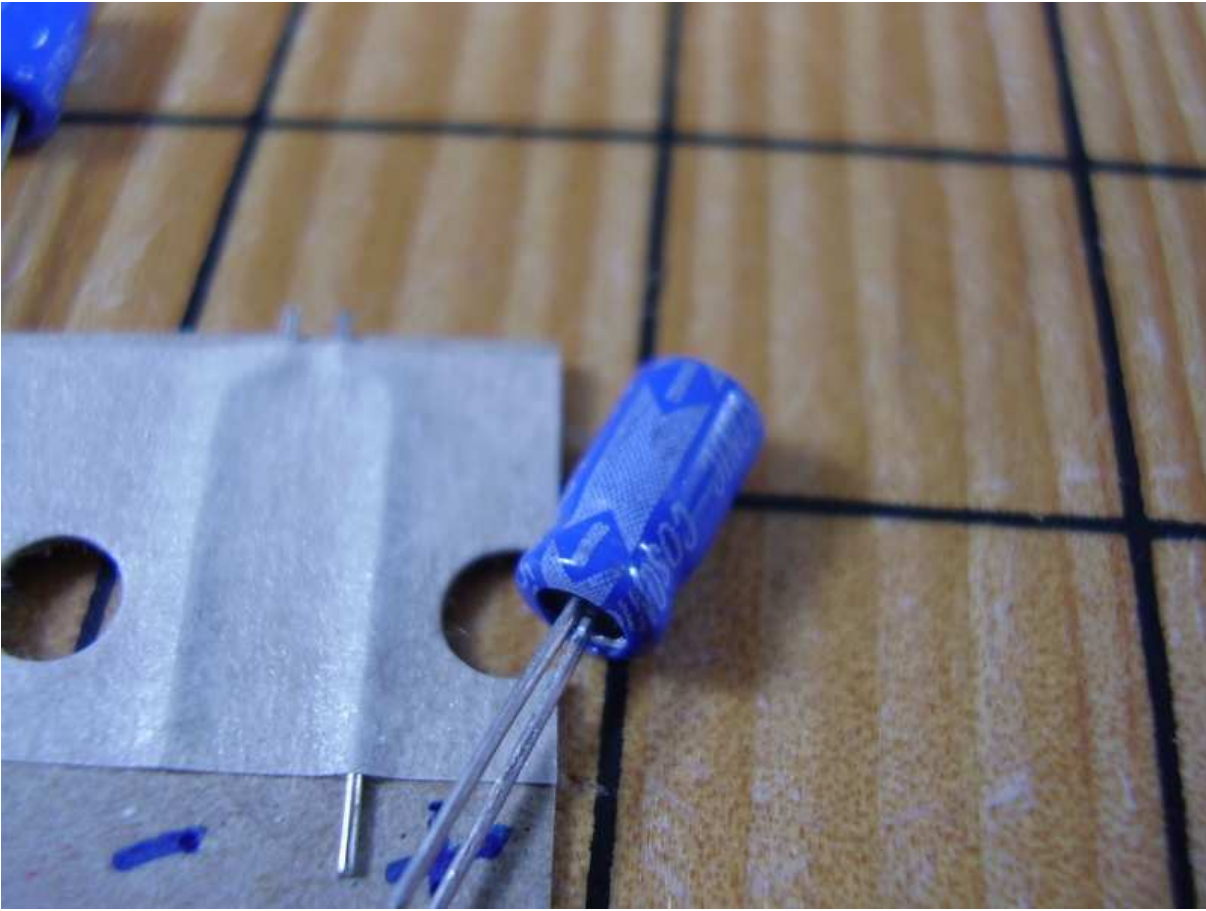

Figure 3.27: $10\mu F$ Cap Cut From Strip.

Note the negative marking on the case to indicate the lead that is the negative lead of the capacitor.

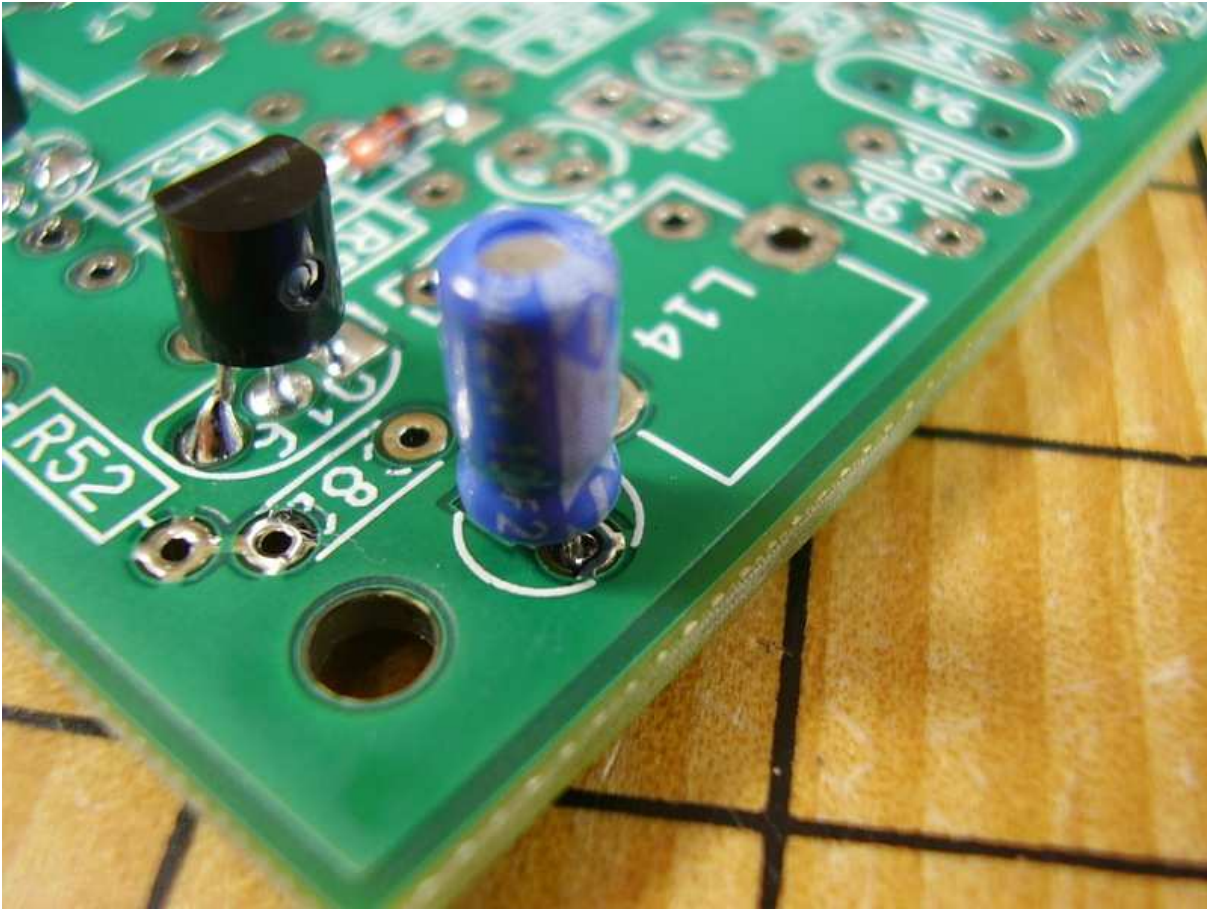

Figure 3.28: [1-7] C81 Installed.

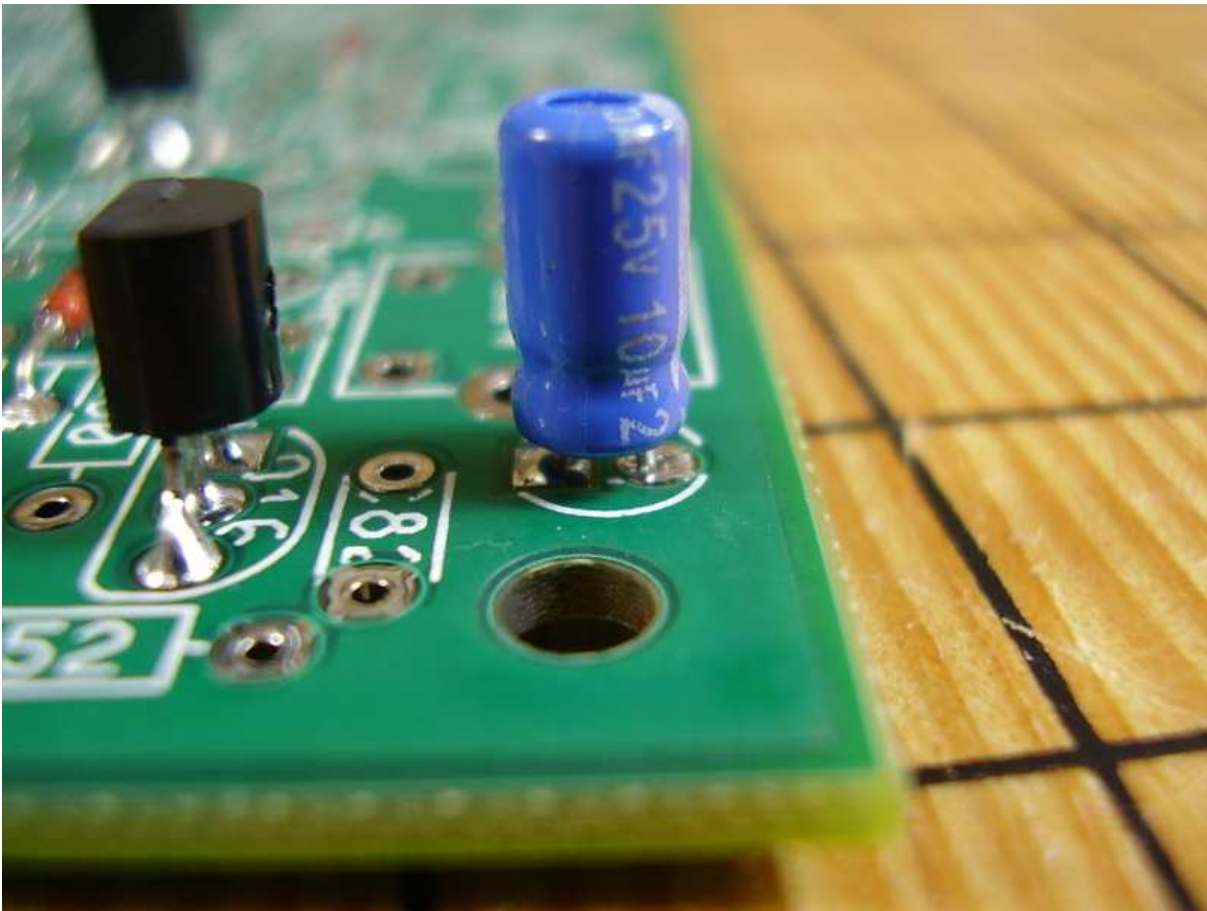

Figure 3.29: Side View of C81.

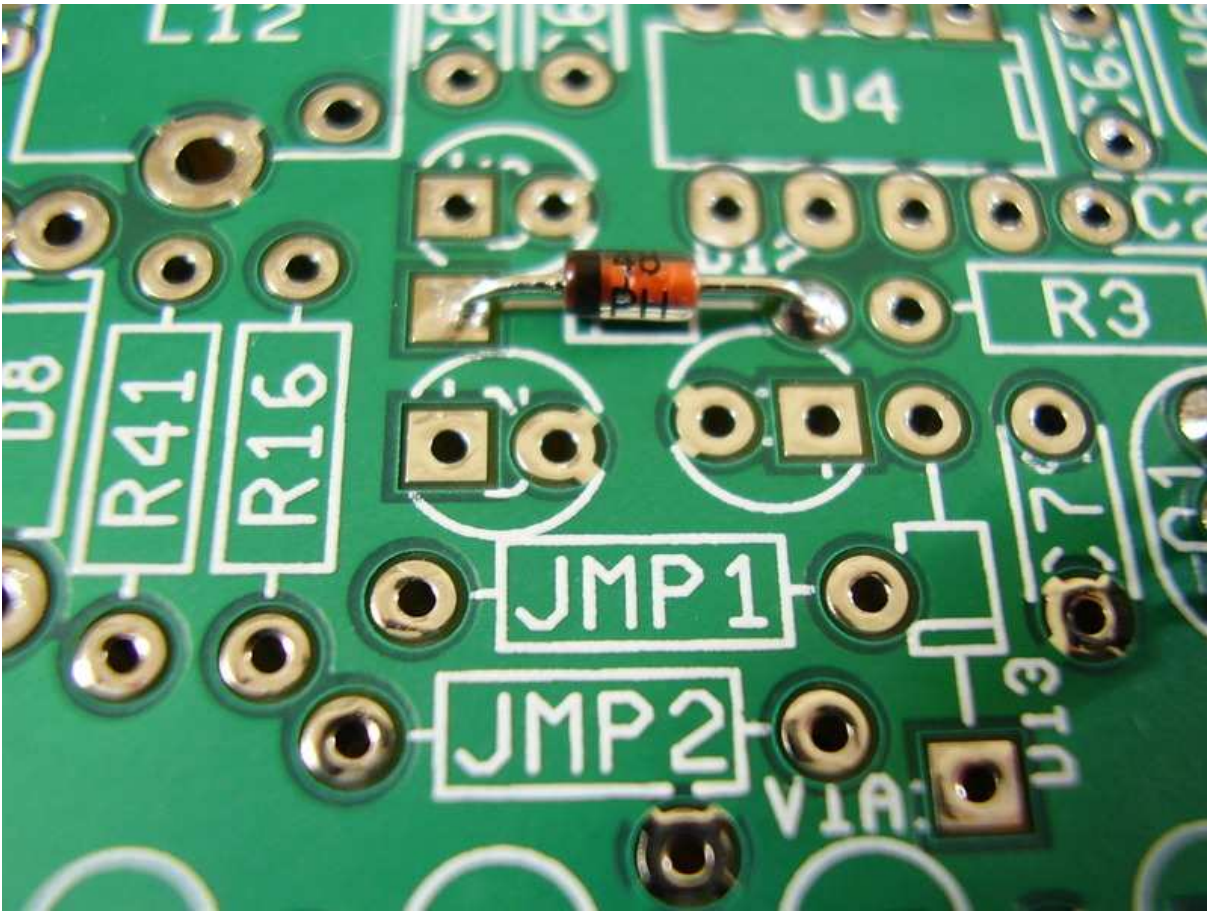

Figure 3.30: C92 Location.

C92 is located just below the diode and the left circular outline. Note the circular and square pads.

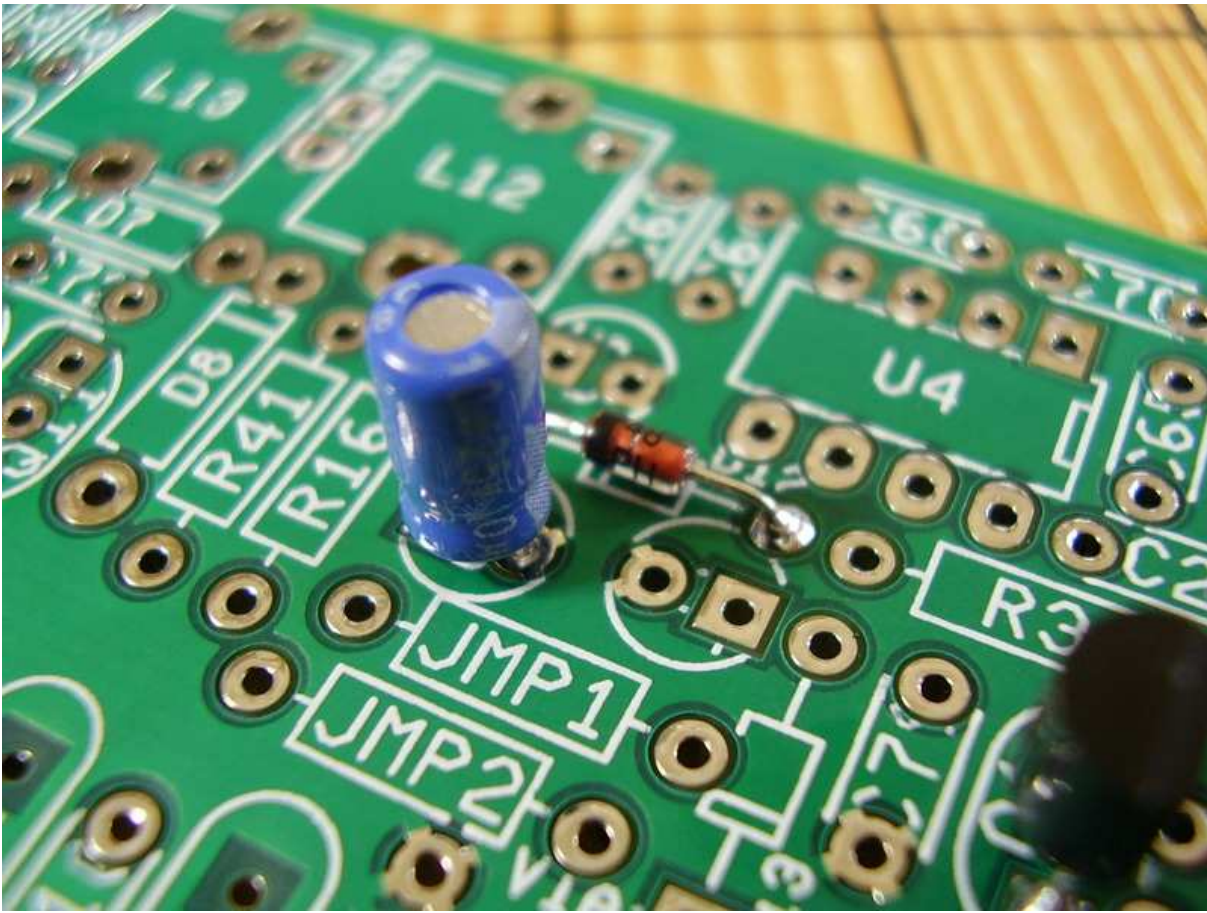

Figure 3.31: [1-8] C92 Installed.

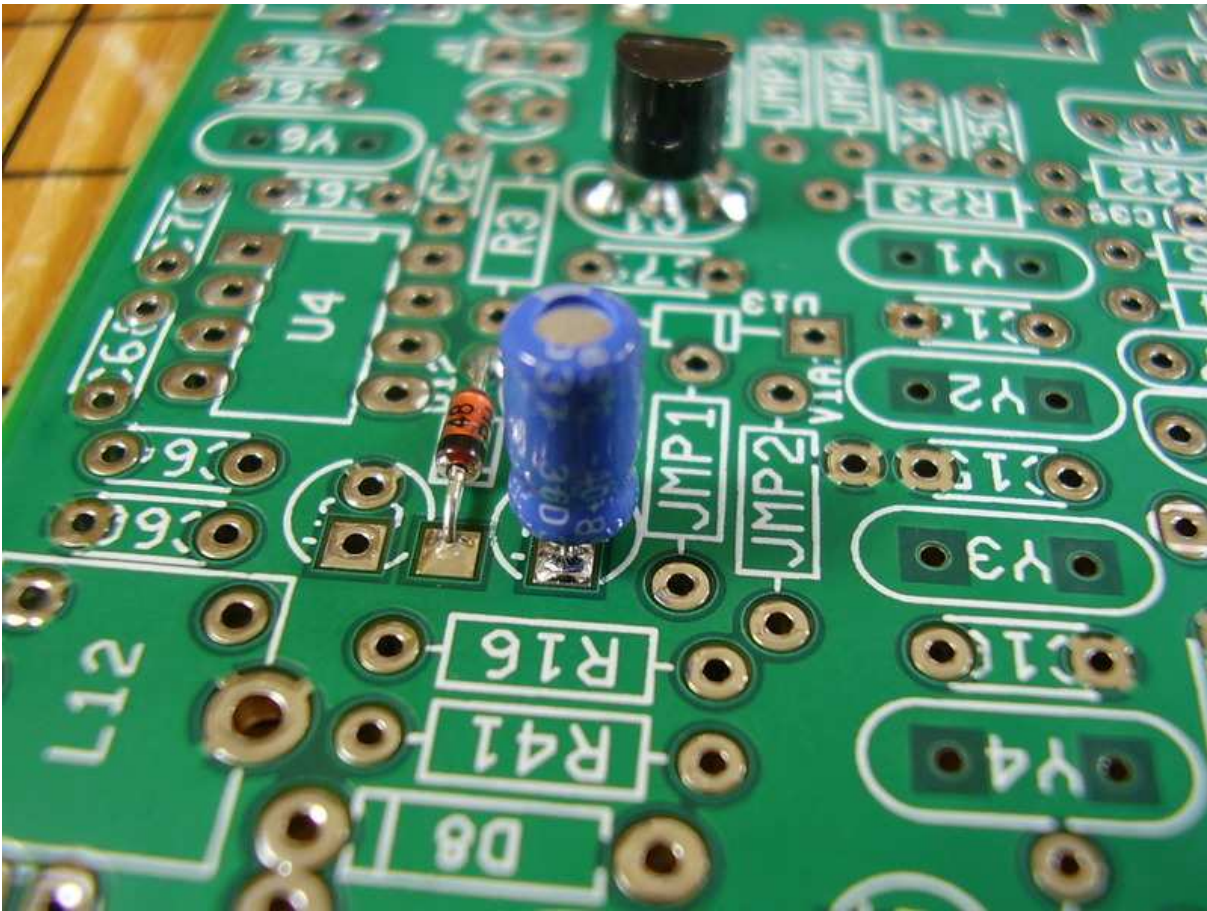

Figure 3.32: Side View C92.

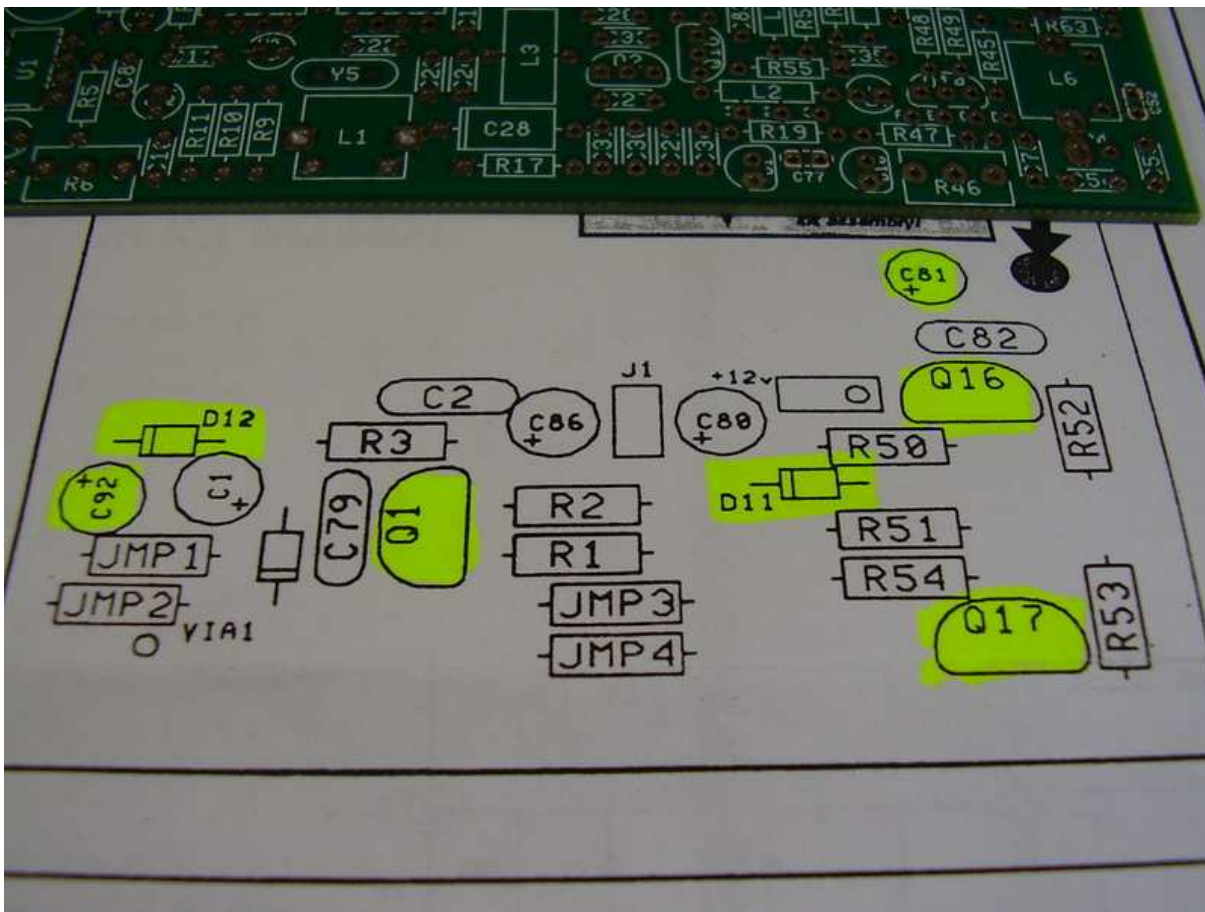

Figure 3.33: Highlighted Supplemental Diagram.

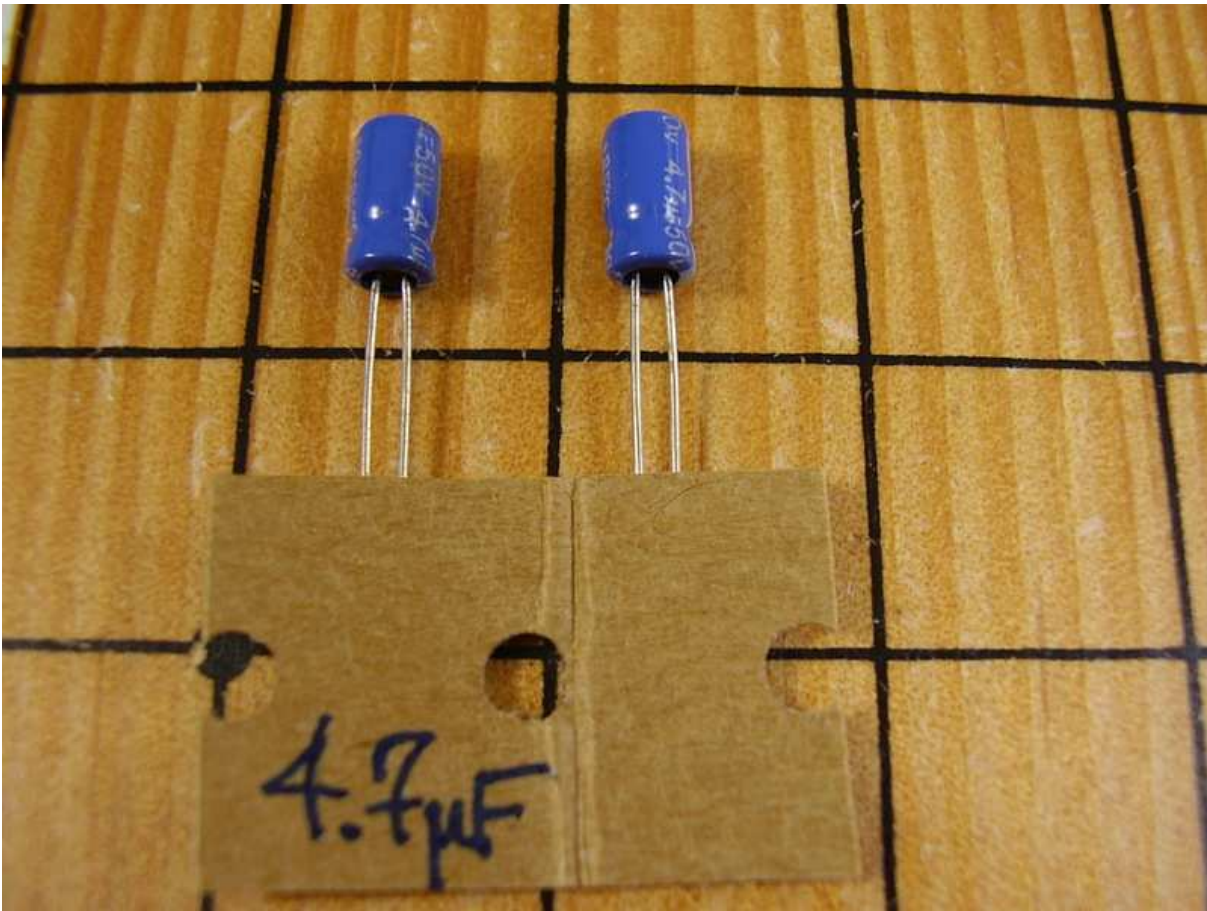

Figure 3.34: $4.7\mu F$ Caps.

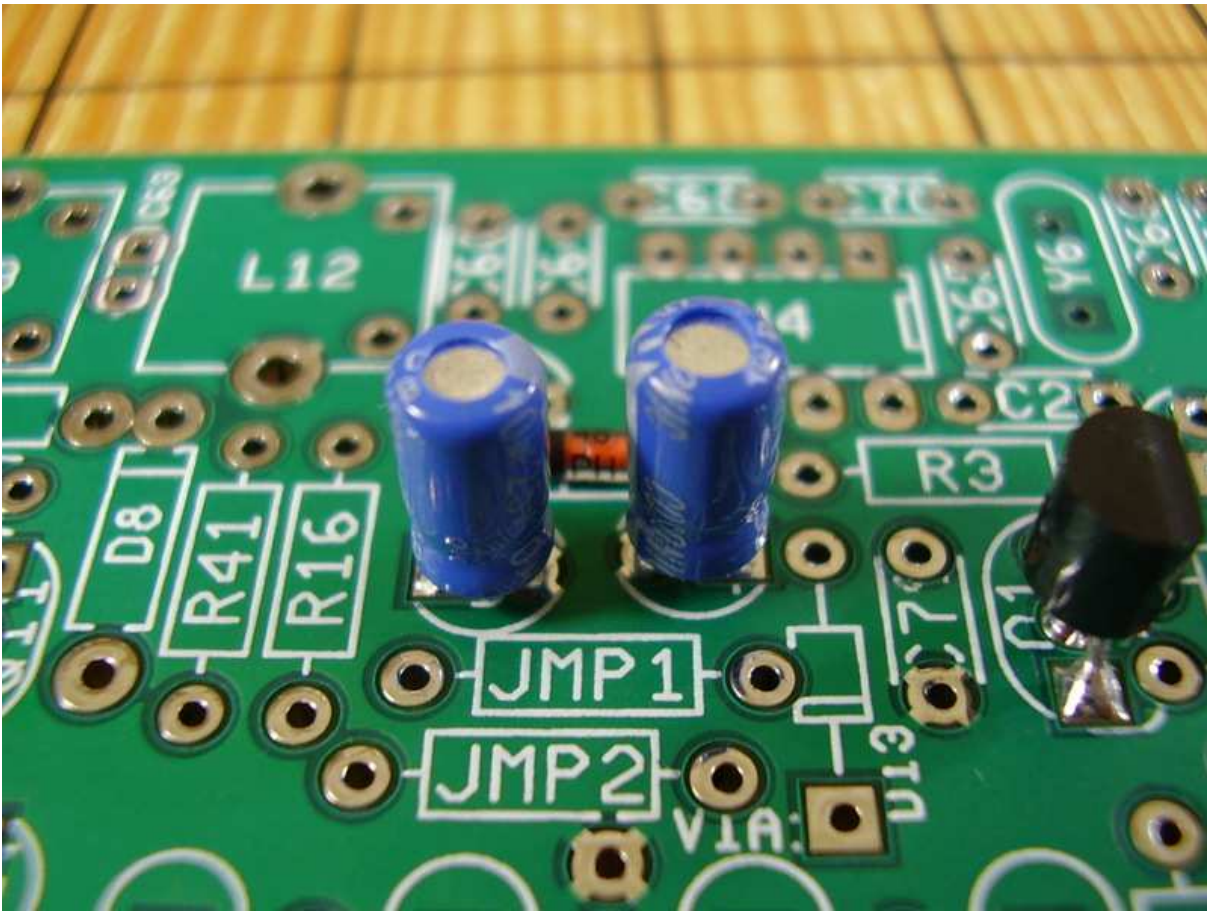

Figure 3.35: [1-9] C1 Installed.

C1 is the right hand electrolytic cap.

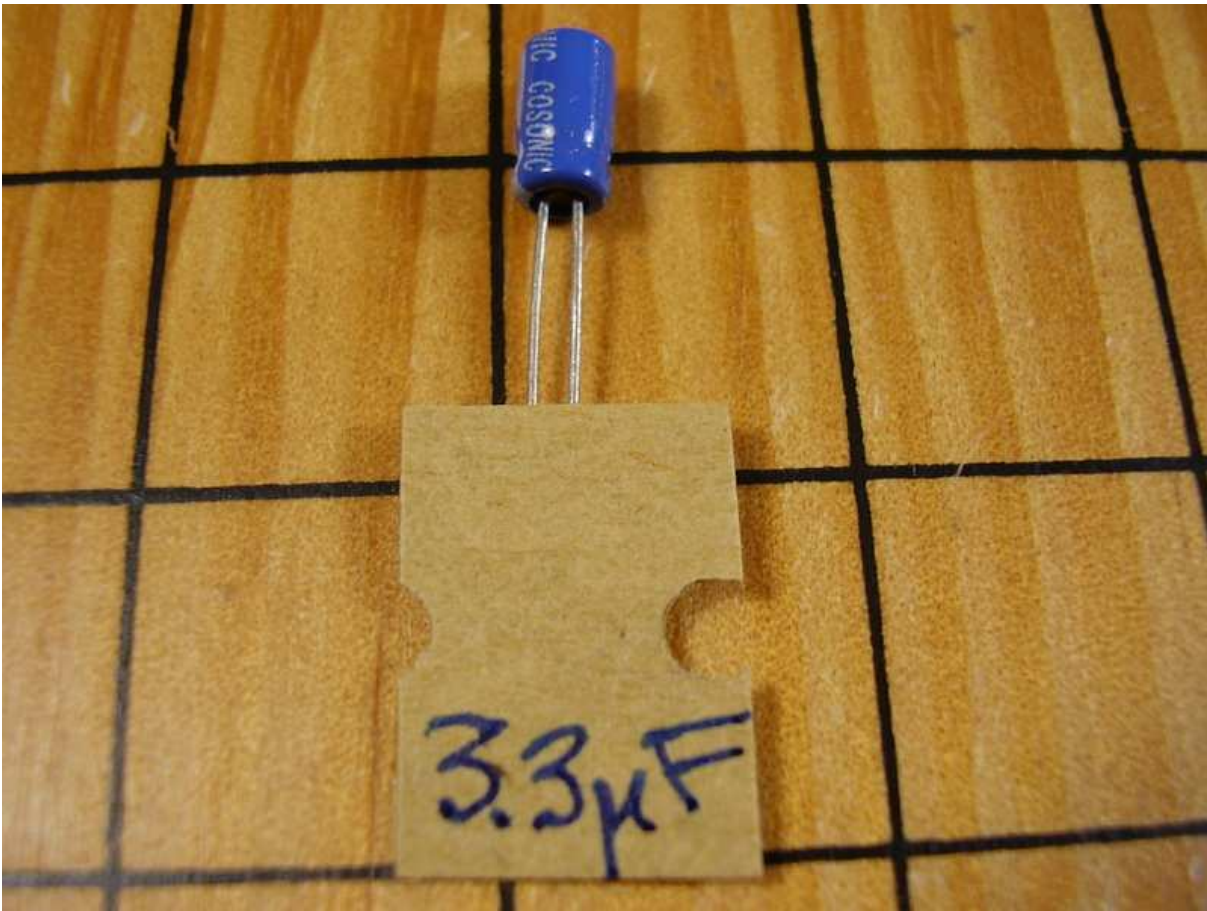

Figure 3.36: $3.3\mu F$ Electrolytic Cap.

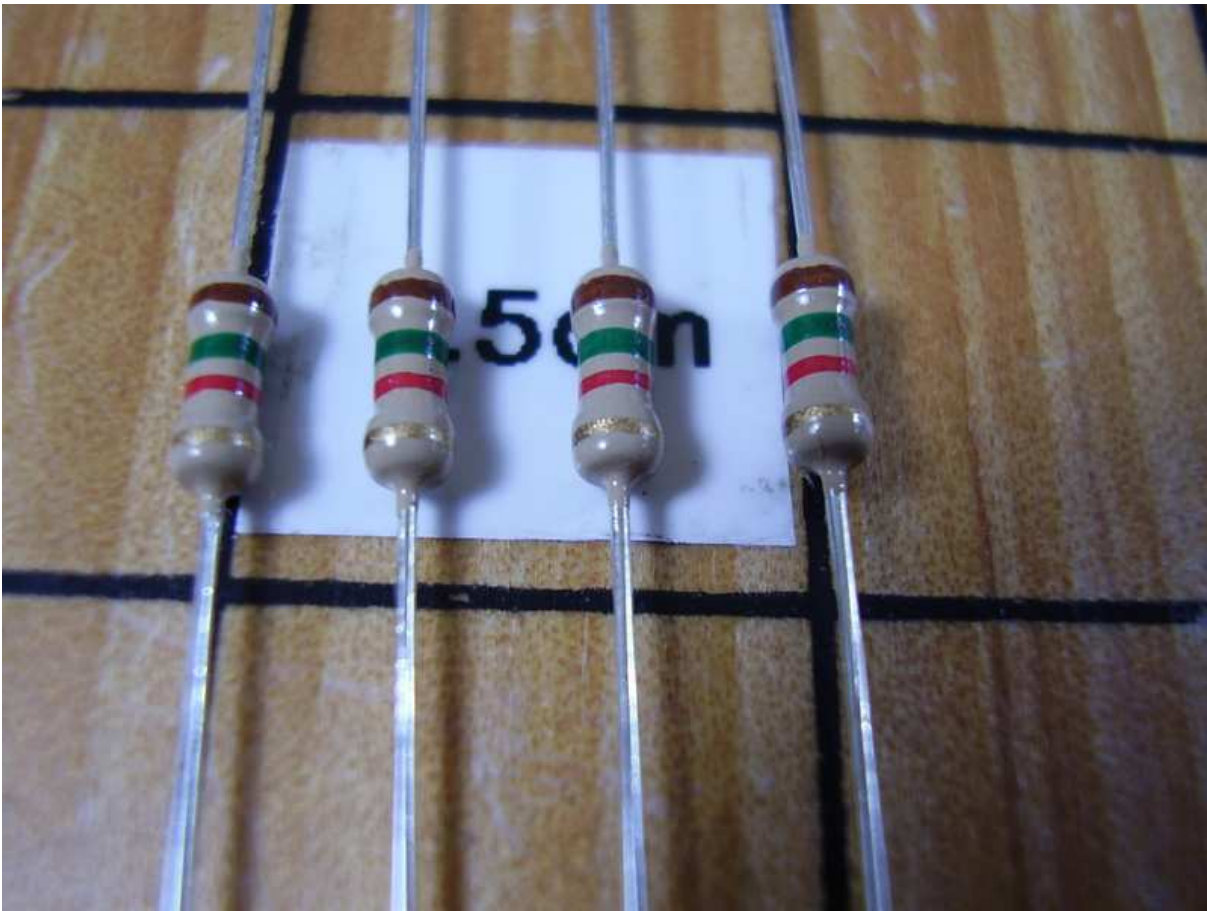

Figure 3.38: 1.5K Resistors.



Figure 3.39: 1.5K Resistors Marked.

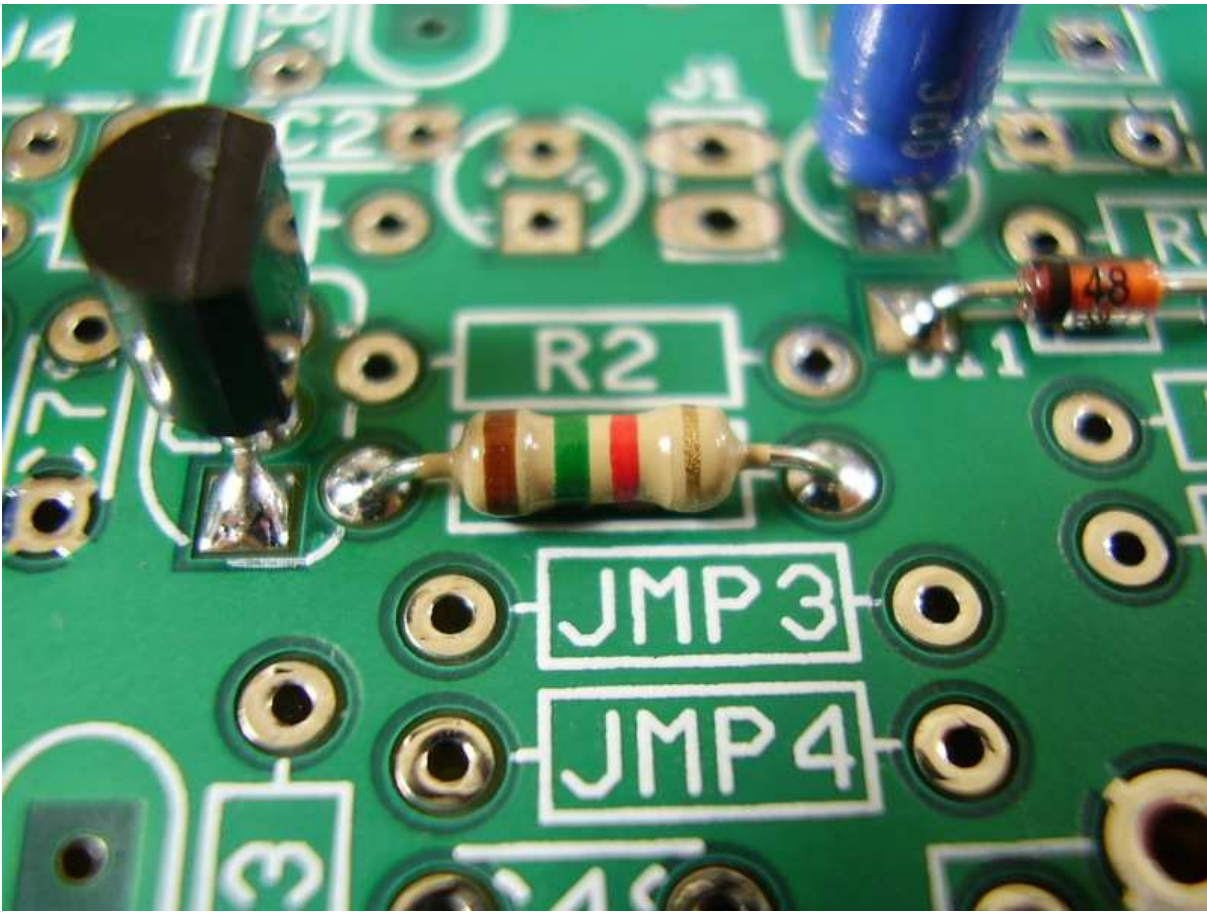

Figure 3.40: [1-11] R1.

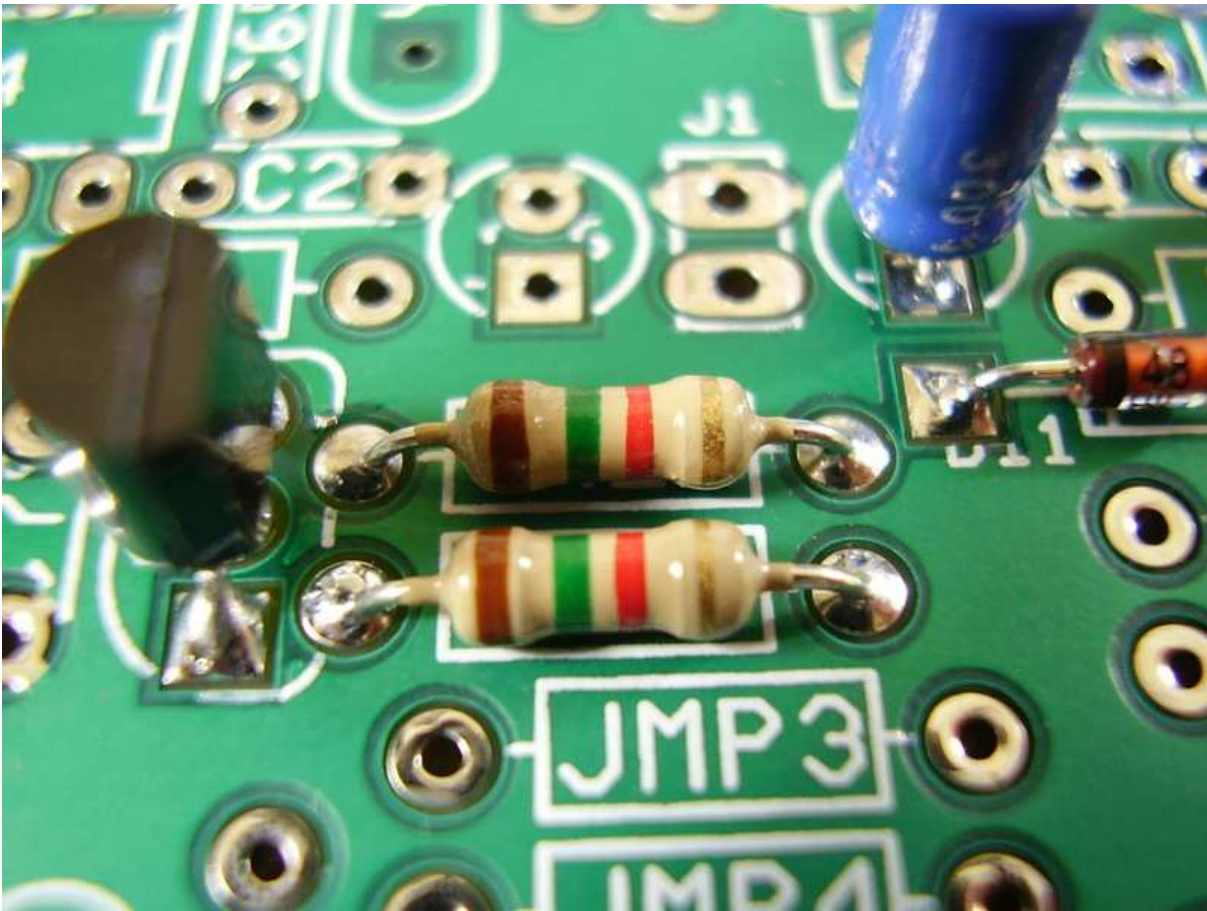

Figure 3.41: [1-12] R2.

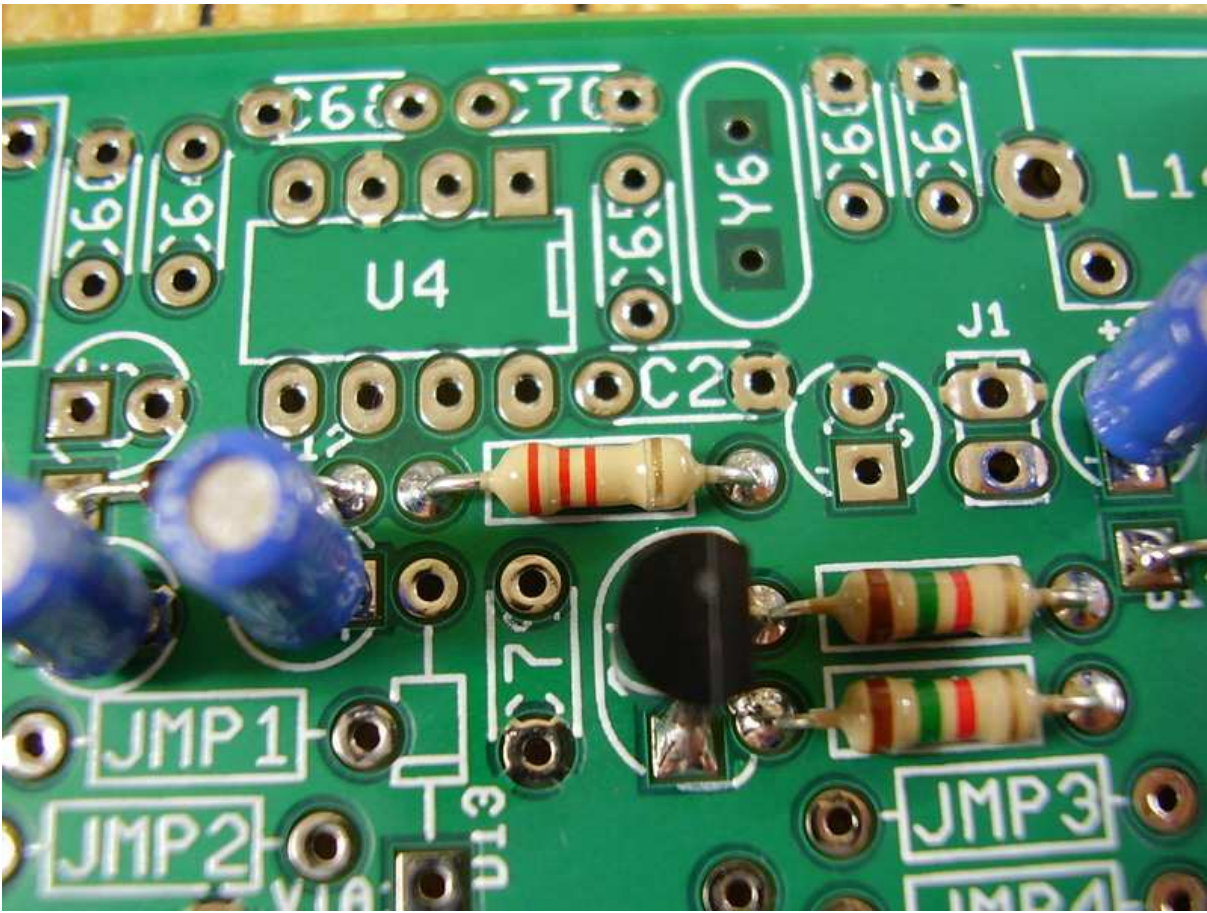

Figure 3.42: [1-13] R3.

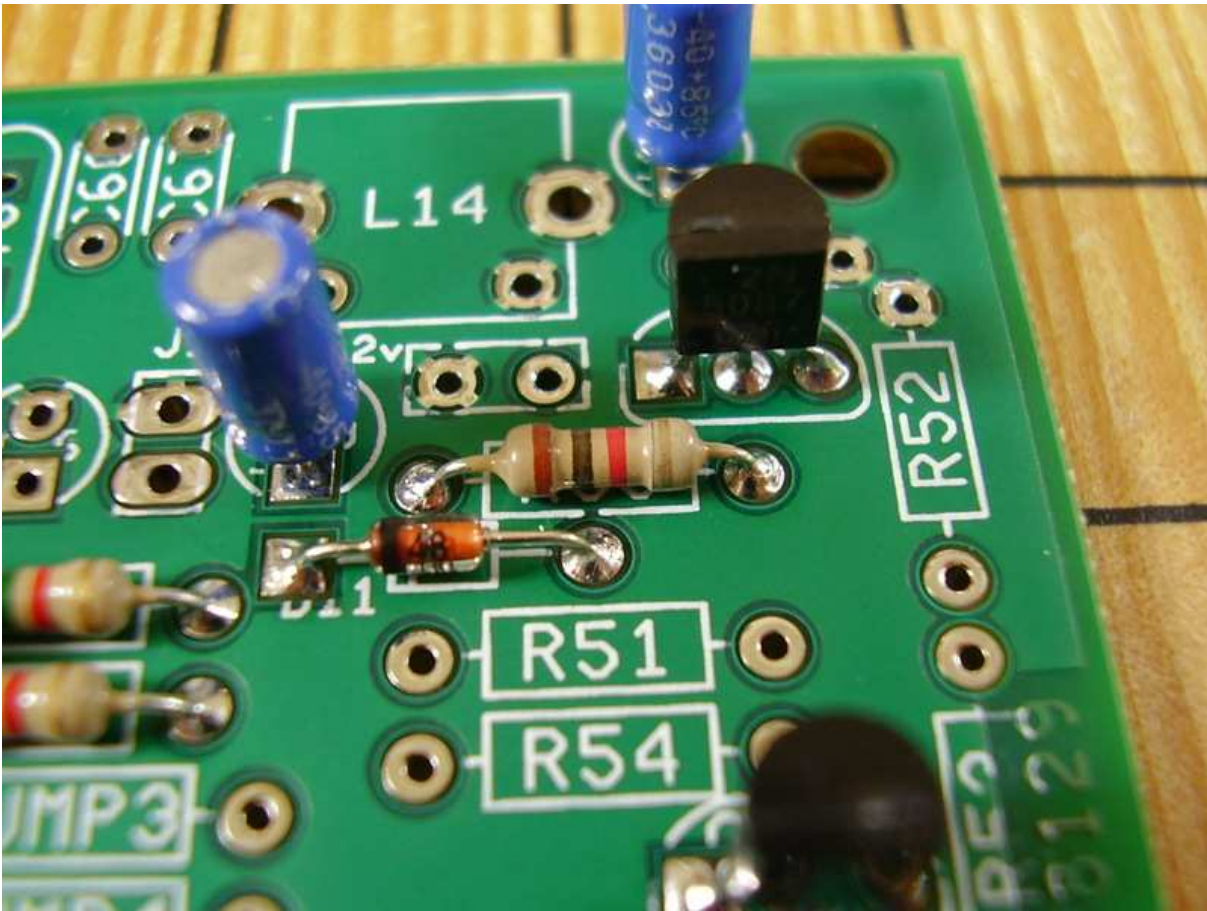

Figure 3.43: [1-14] R50.

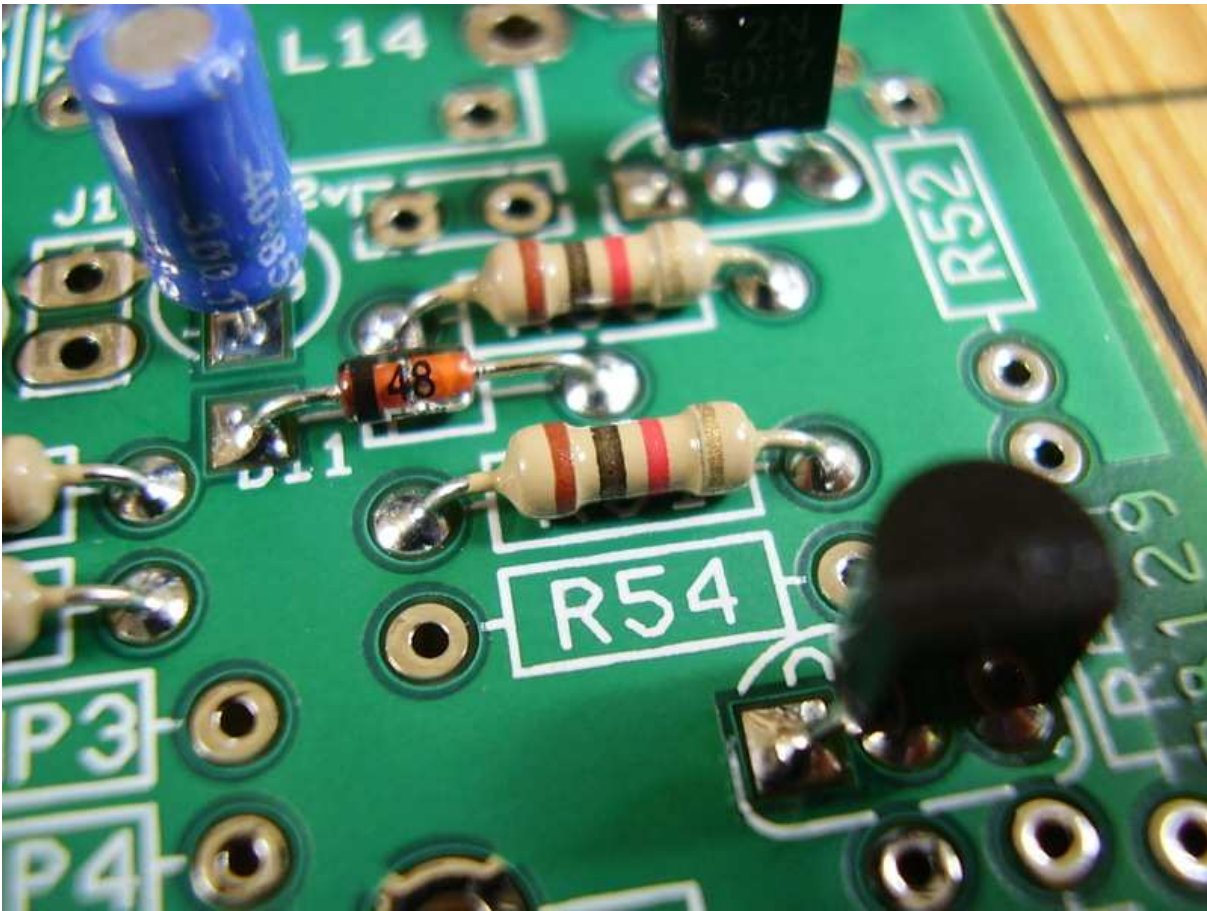

Figure 3.44: [1-15] R51.

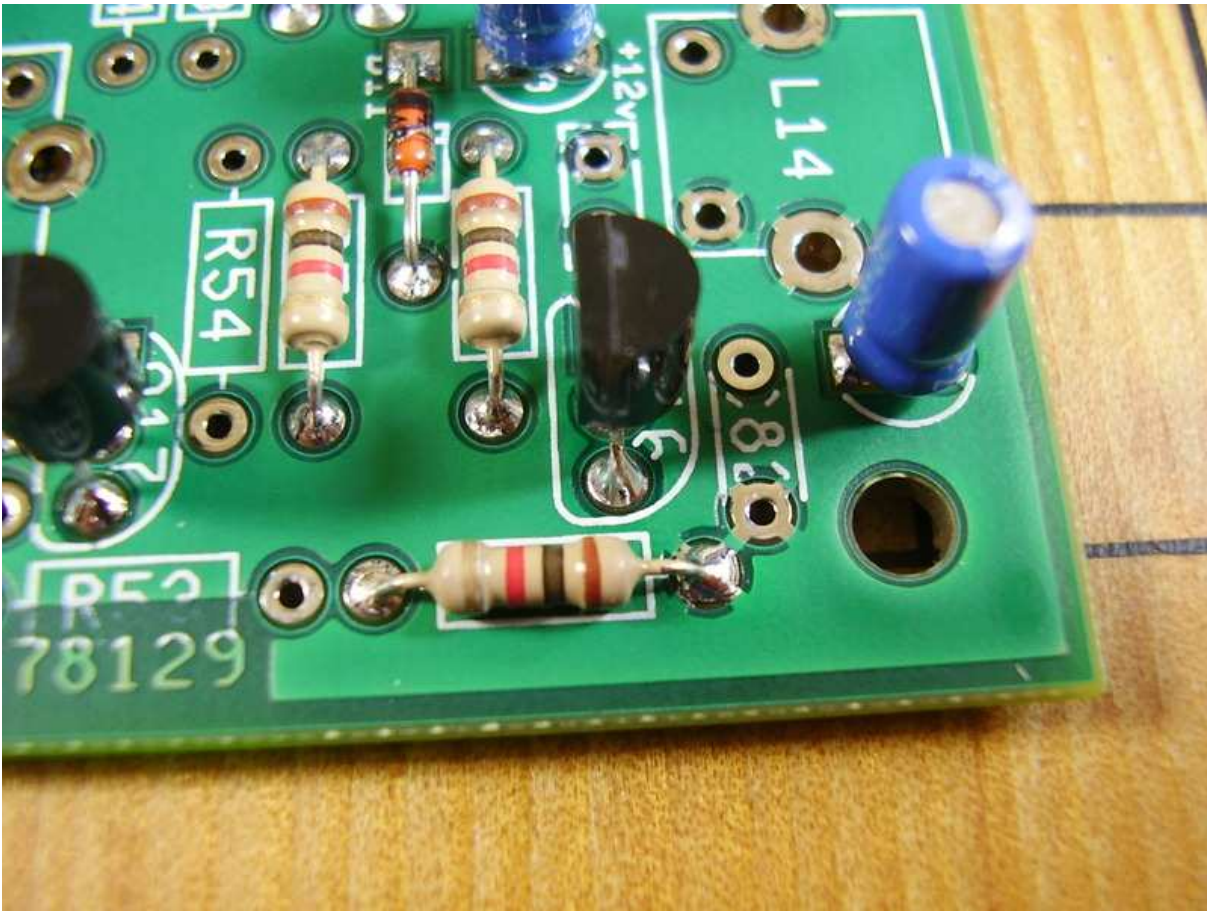

Figure 3.45: [1-16] R52.

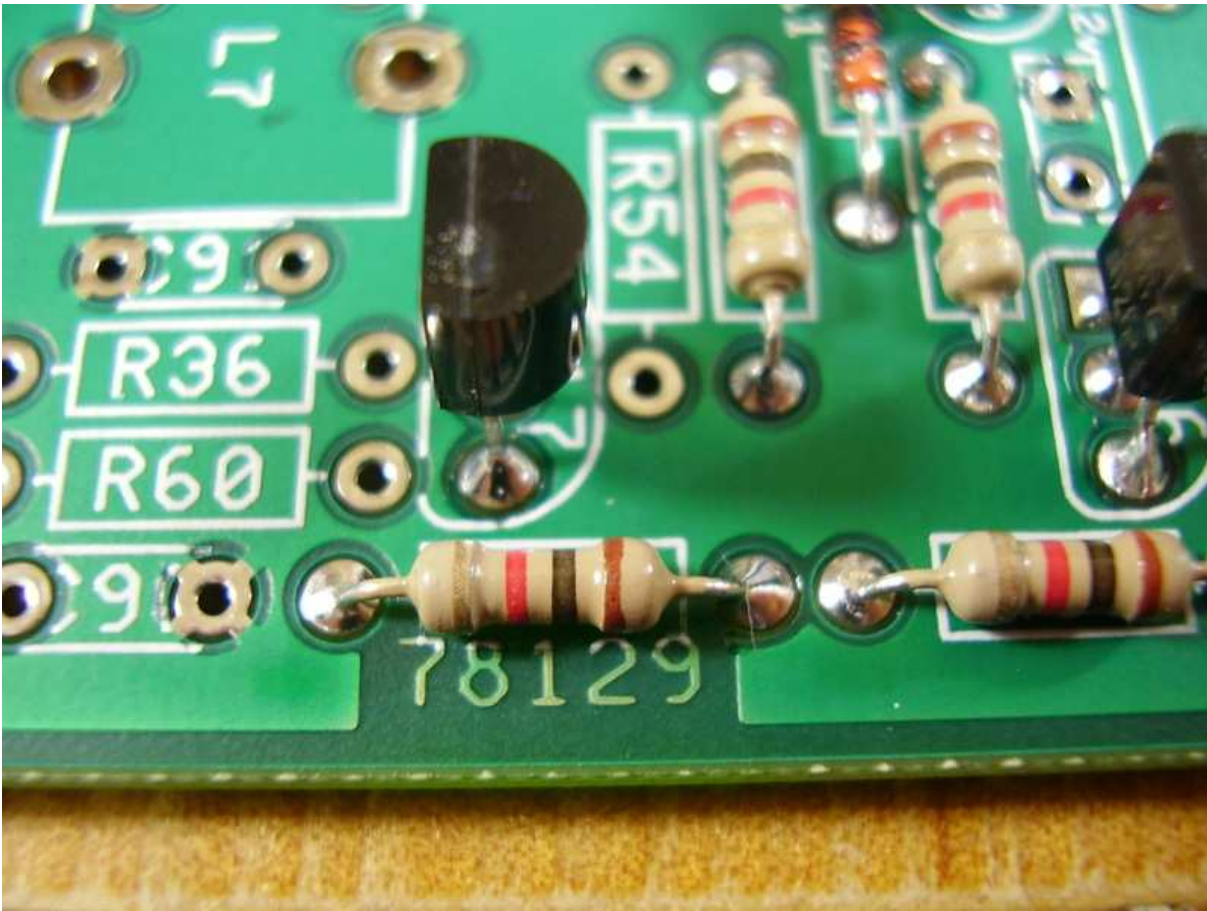

Figure 3.46: [1-17] R53.

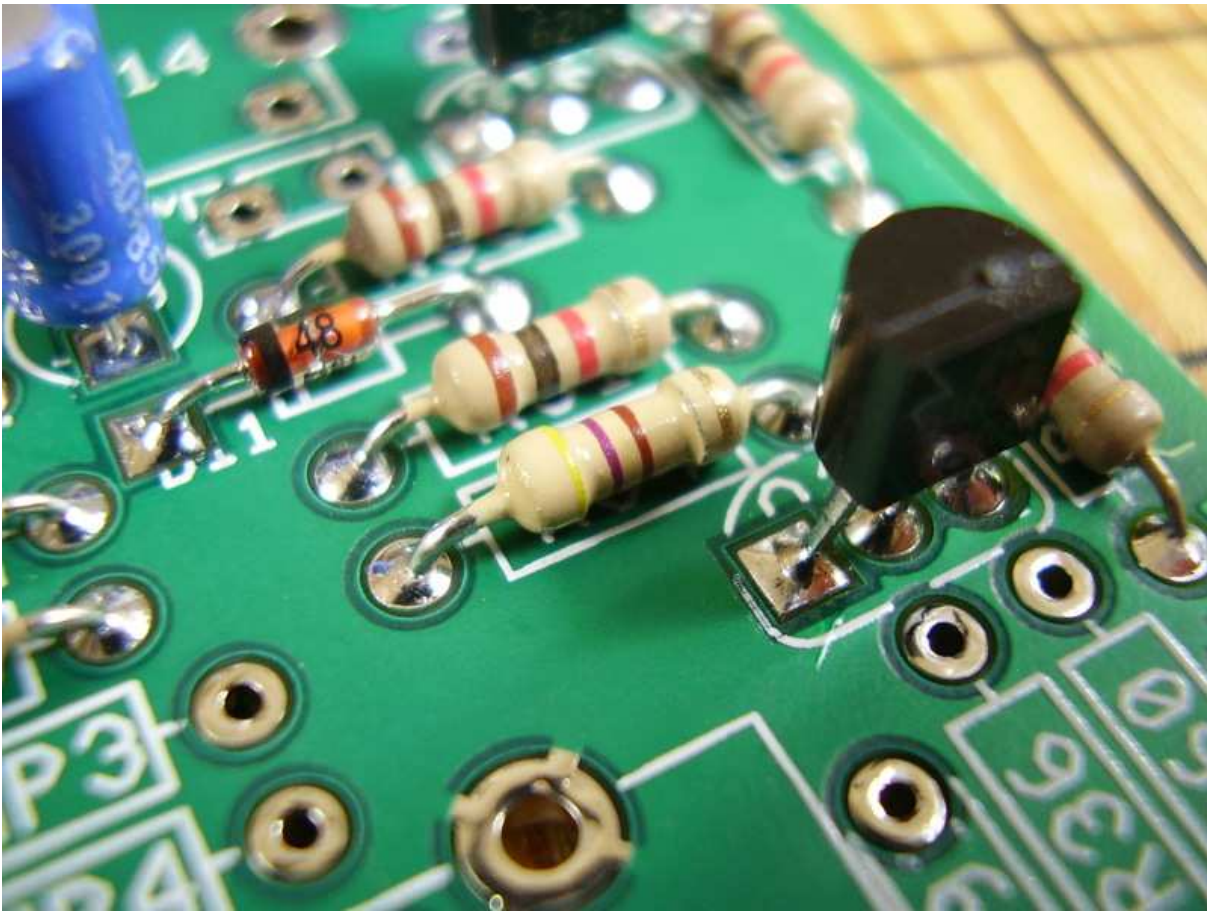

Figure 3.47: [1-18] R54.



Figure 3.48: 0 Ohm Resistors.

These resistors will be used in place of wires to connect one path to another. Saves time in making up insulated wires and cutting them to length.

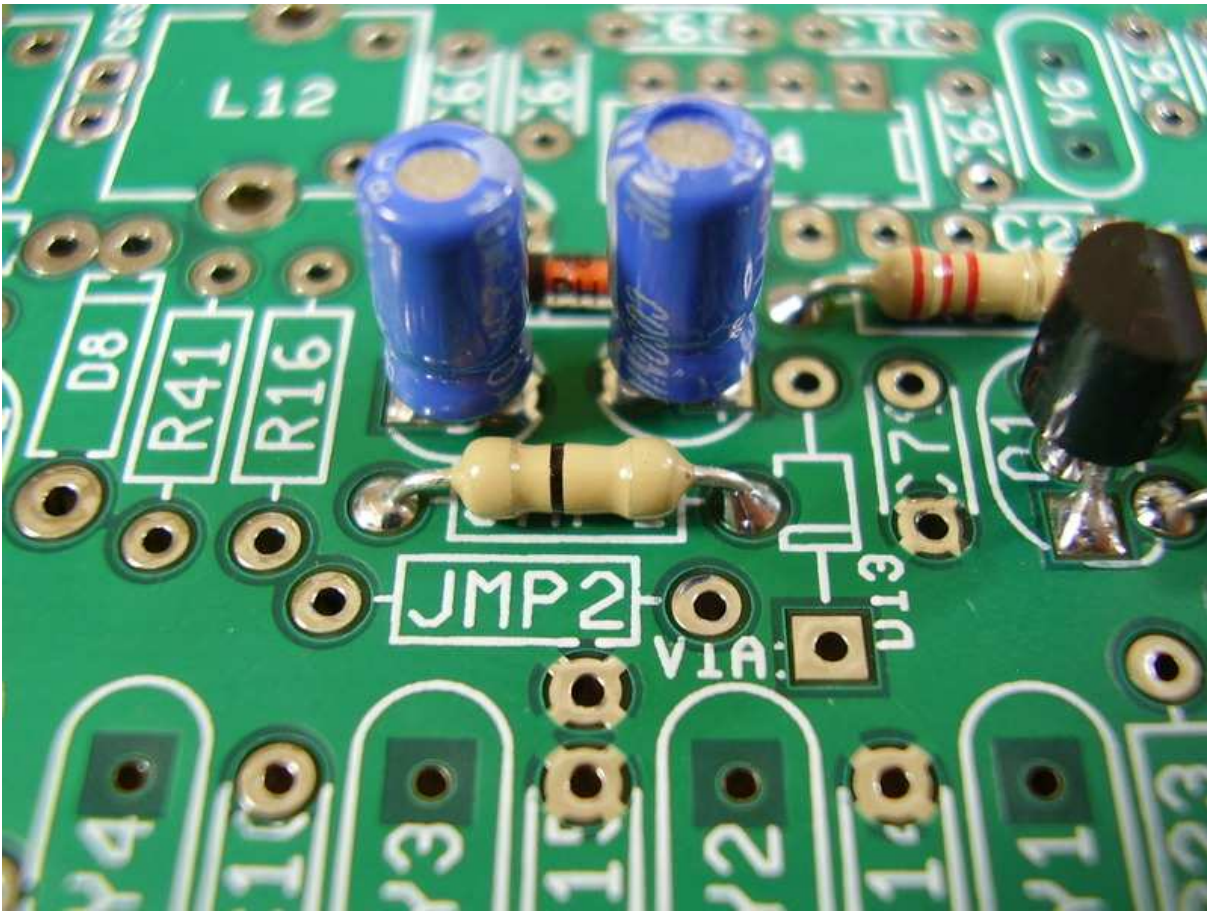

Figure 3.49: [1-19] JMP1.

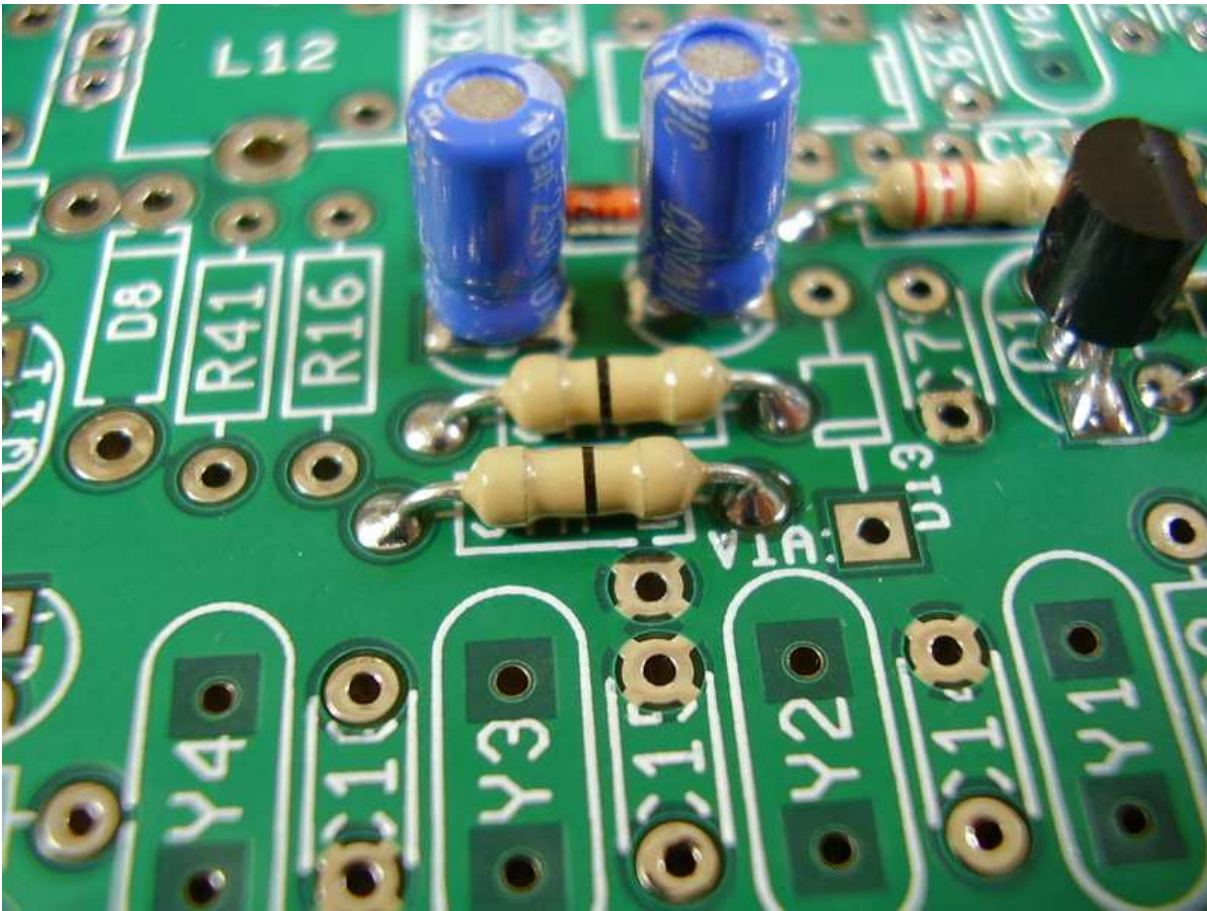

Figure 3.50: [1-20] JMP2.

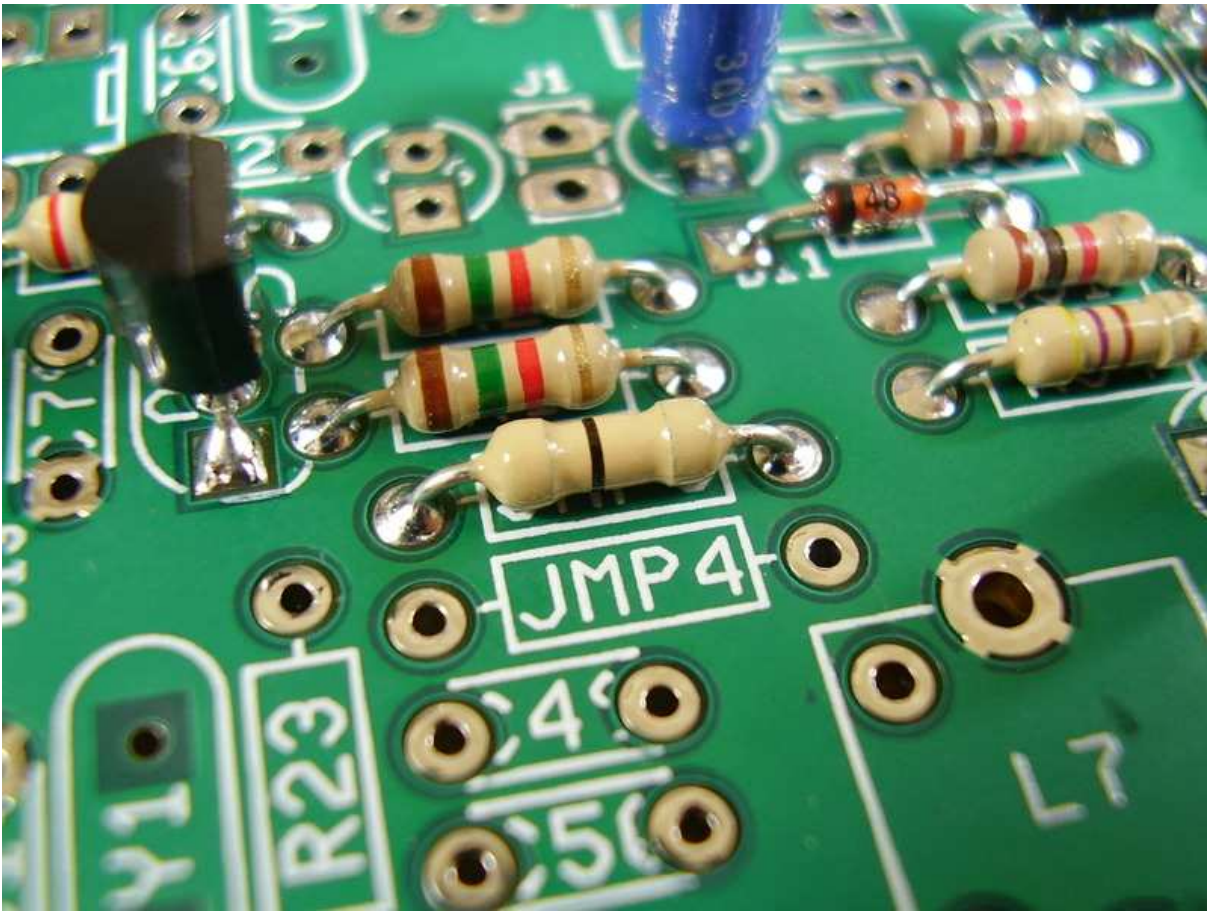

Figure 3.51: [1-20] JMP3.

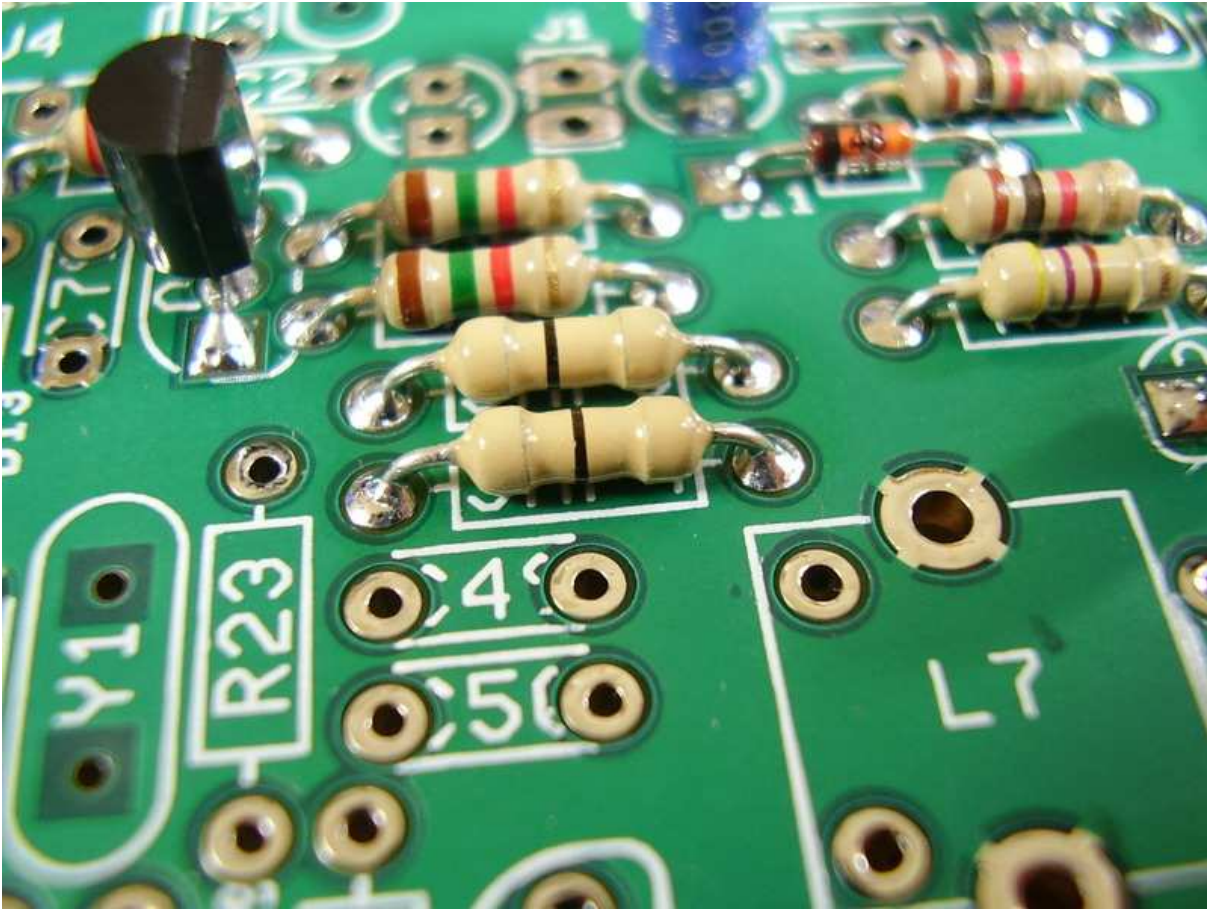

Figure 3.52: [1-20] JMP4.



Figure 3.53: Bag of $0.01\mu\text{F}$ Disc Caps.

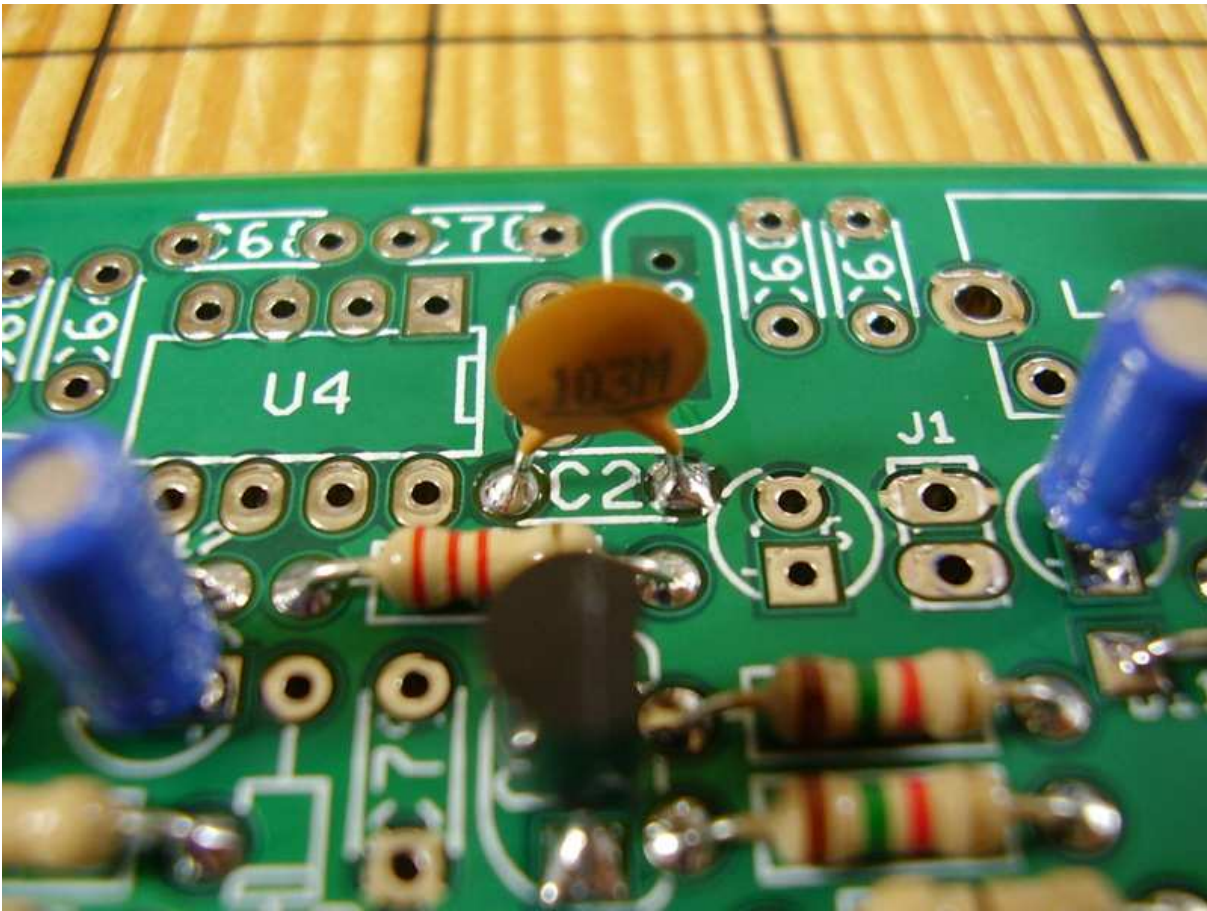

Figure 3.54: [1-23] C2.

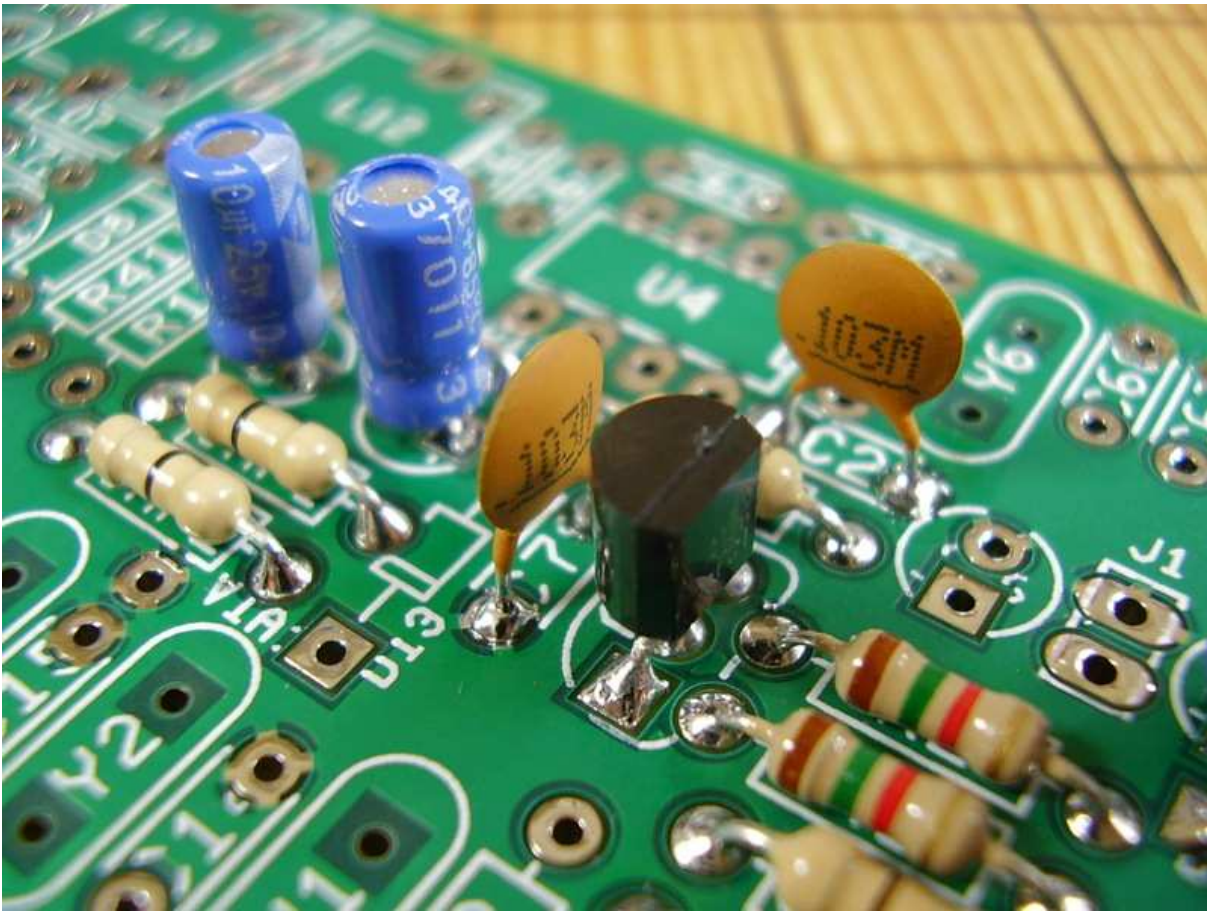

Figure 3.55: [1-24] C79.

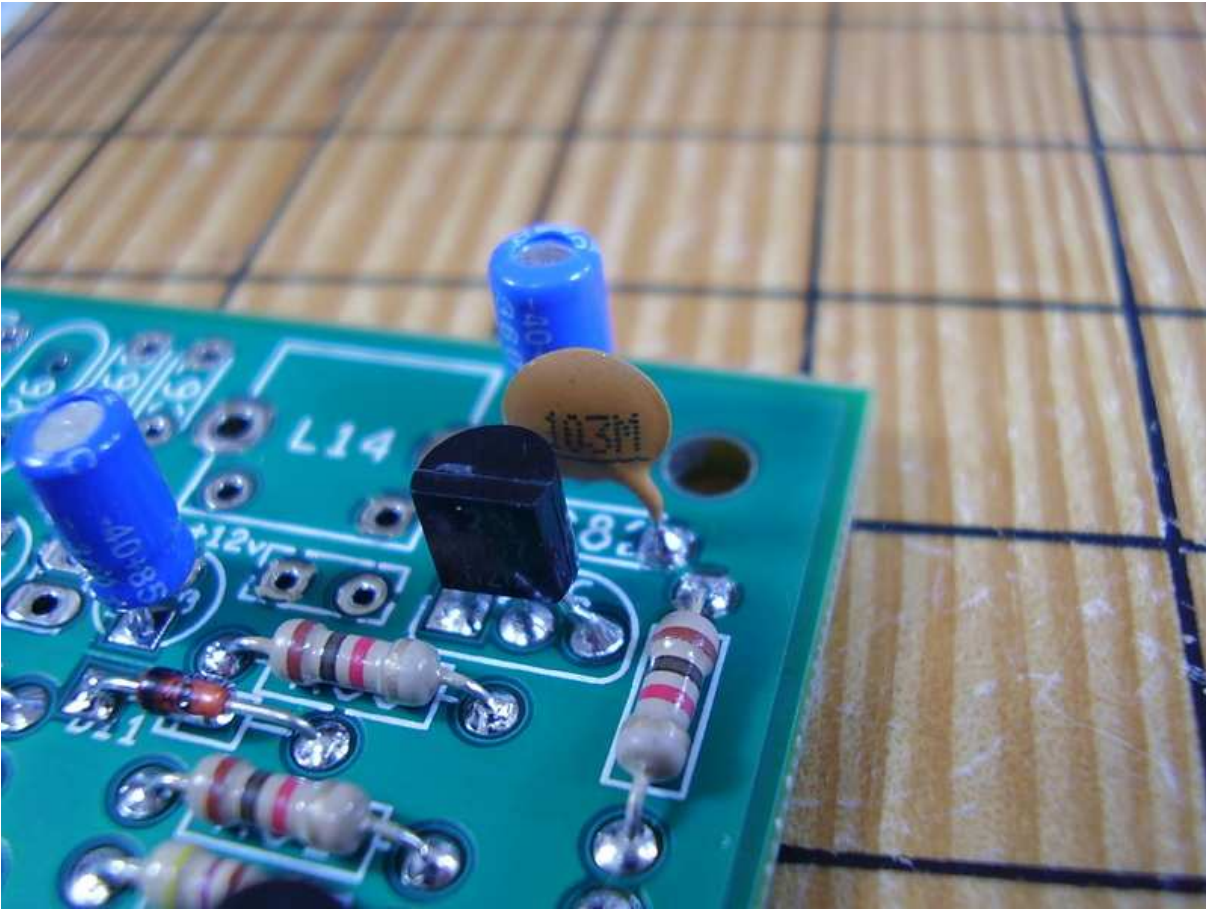

Figure 3.56: [1-25] C82.

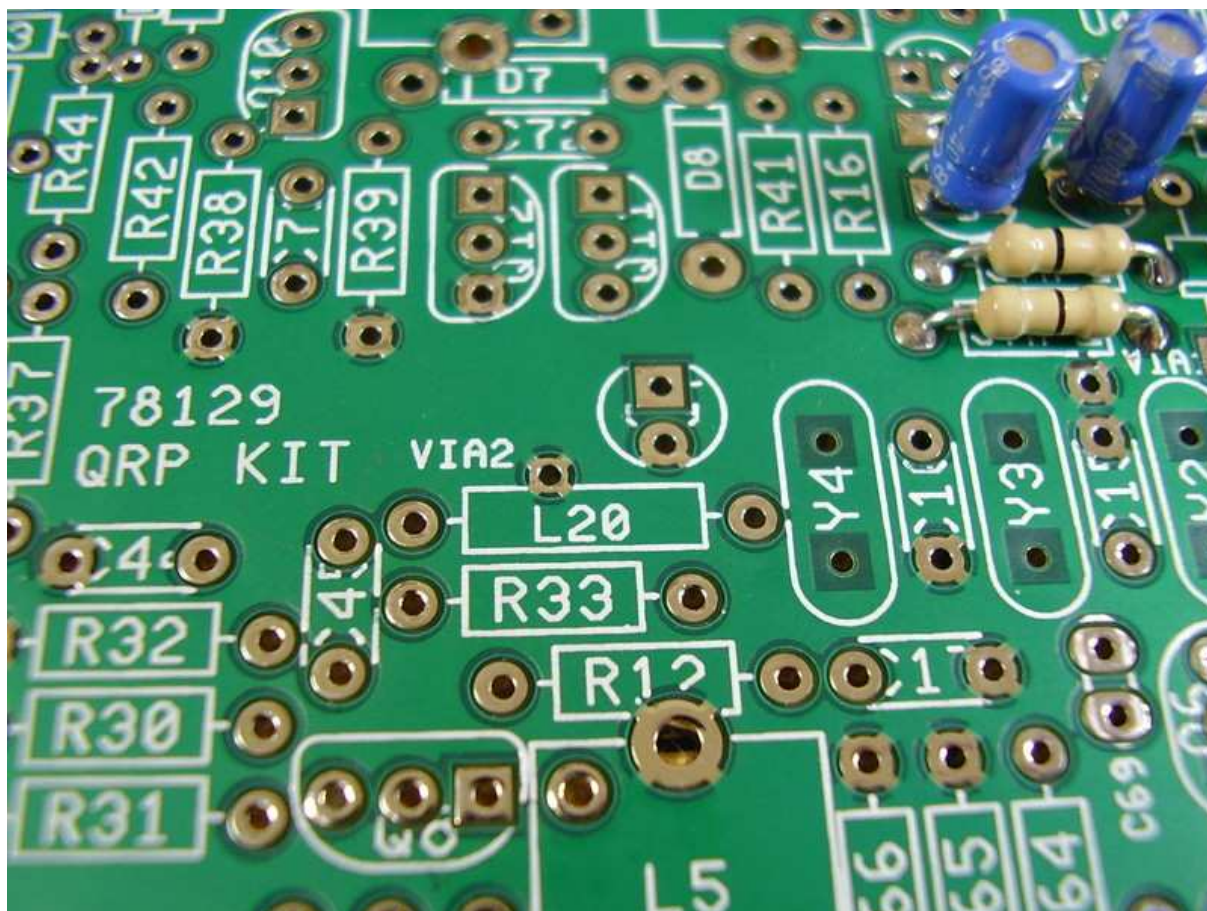

Figure 3.57: L20 Location.

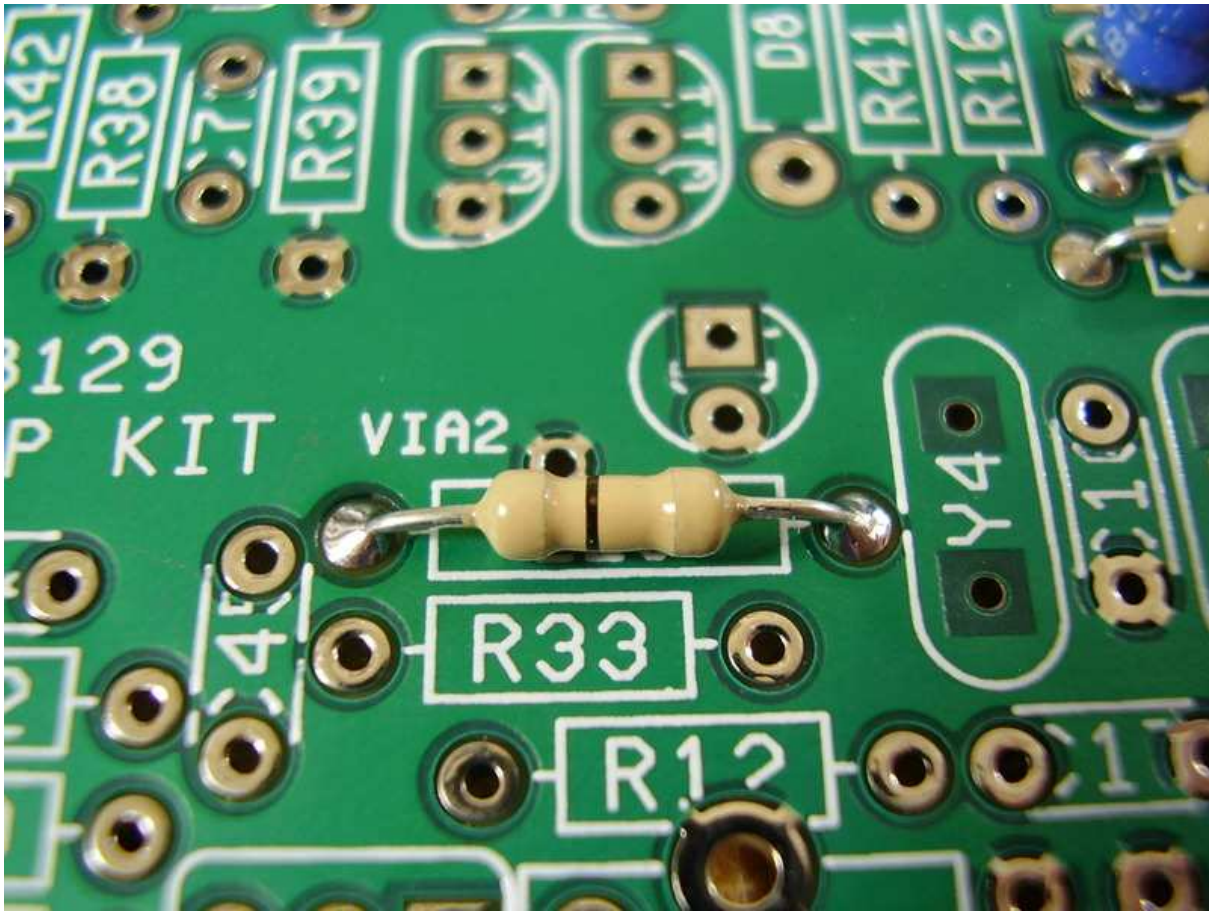

Figure 3.58: [1-28] 0 Ohm Resistor for L20.

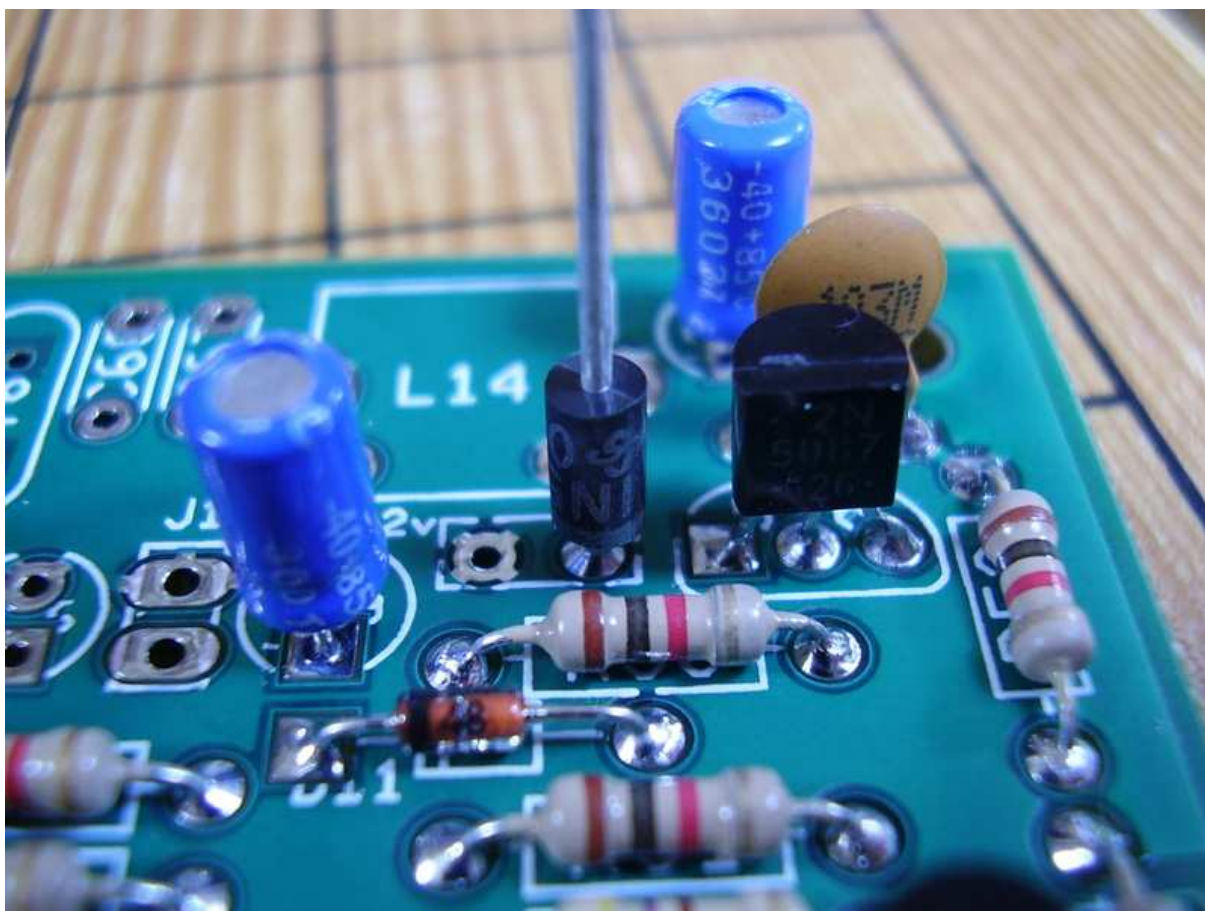

Figure 3.59: [1-31] +12V Input Location.

In order to prevent damage, if the power supply should be connected backwards, I use either a 1N4001 diode or a Schottky diode (1N5817 or similar) to prevent current flow if reverse polarity is applied. If you ever hook up the power source backwards, you will do damage to parts of the transceiver and will have to replace the parts. It is worth the extra effort to do this. Note the direction of the diode.

If you don't have the parts, then follow the instructions with the kit and just be careful when it comes to applying power to the rig.

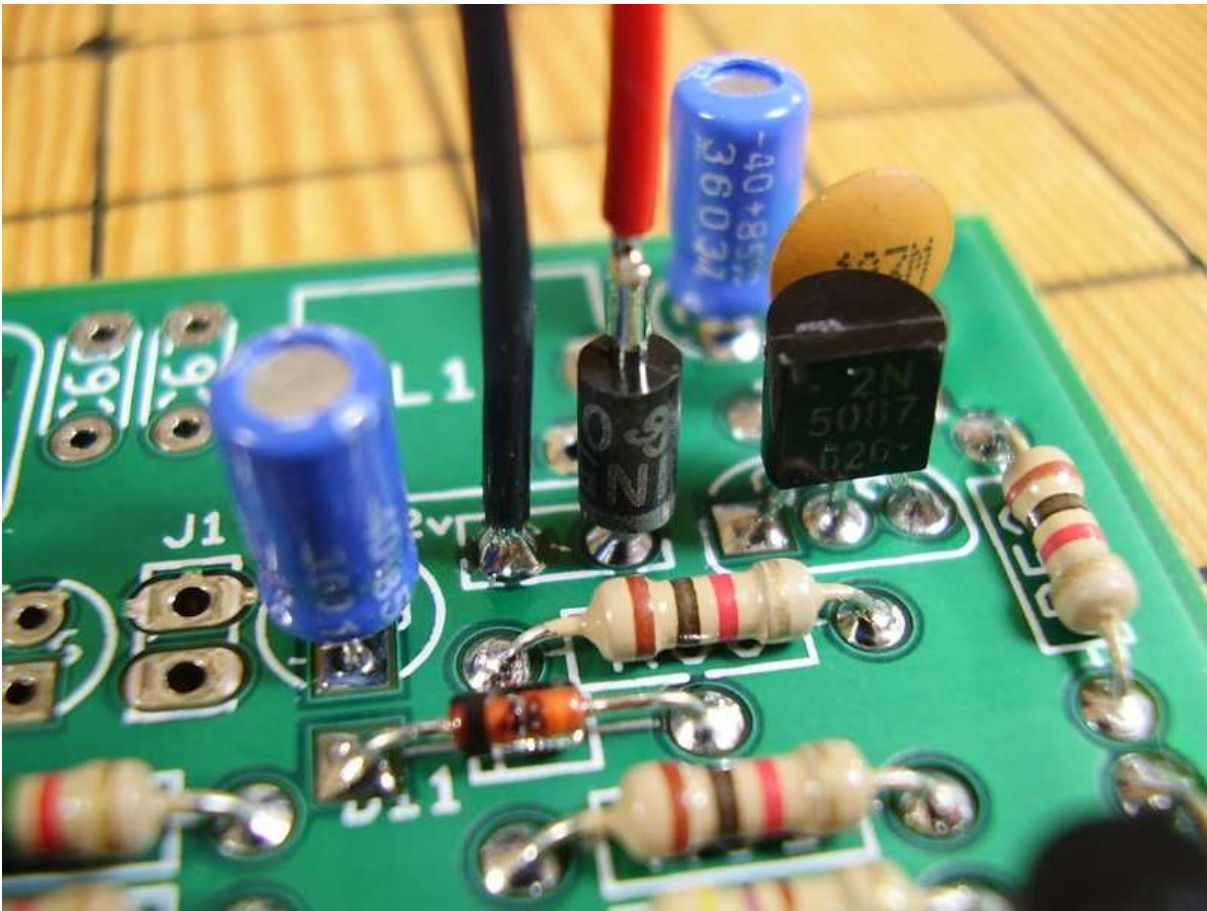

Figure 3.60: [1-32] -12V Input Location.

Chapter 4

Phase 2.0 - VFO and Buffer and RF Amplifier Circuits

In this section we will build the variable frequency oscillator, an RF buffer, RF amplifier and RF filter circuits. The variable frequency oscillator controls the operating frequency of the transceiver and is the heart of the rig. It must be stable, i.e. not vary over time and must be free of harmonics to meet standards set by the FCC for on the air operation.

The TenTec manual describes the operation of the circuit and I will go into details here.

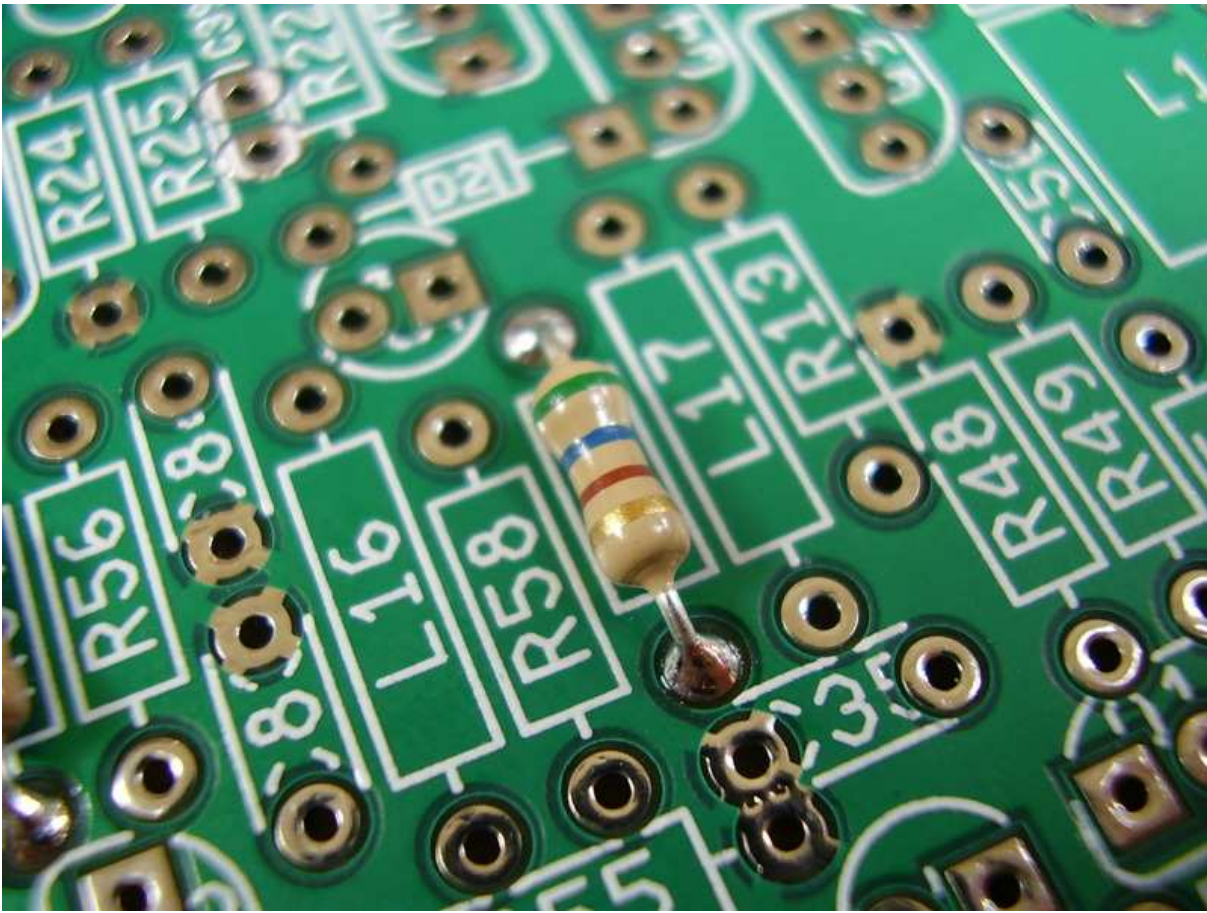

Figure 4.1: [2-3] R59 560 Ohms .

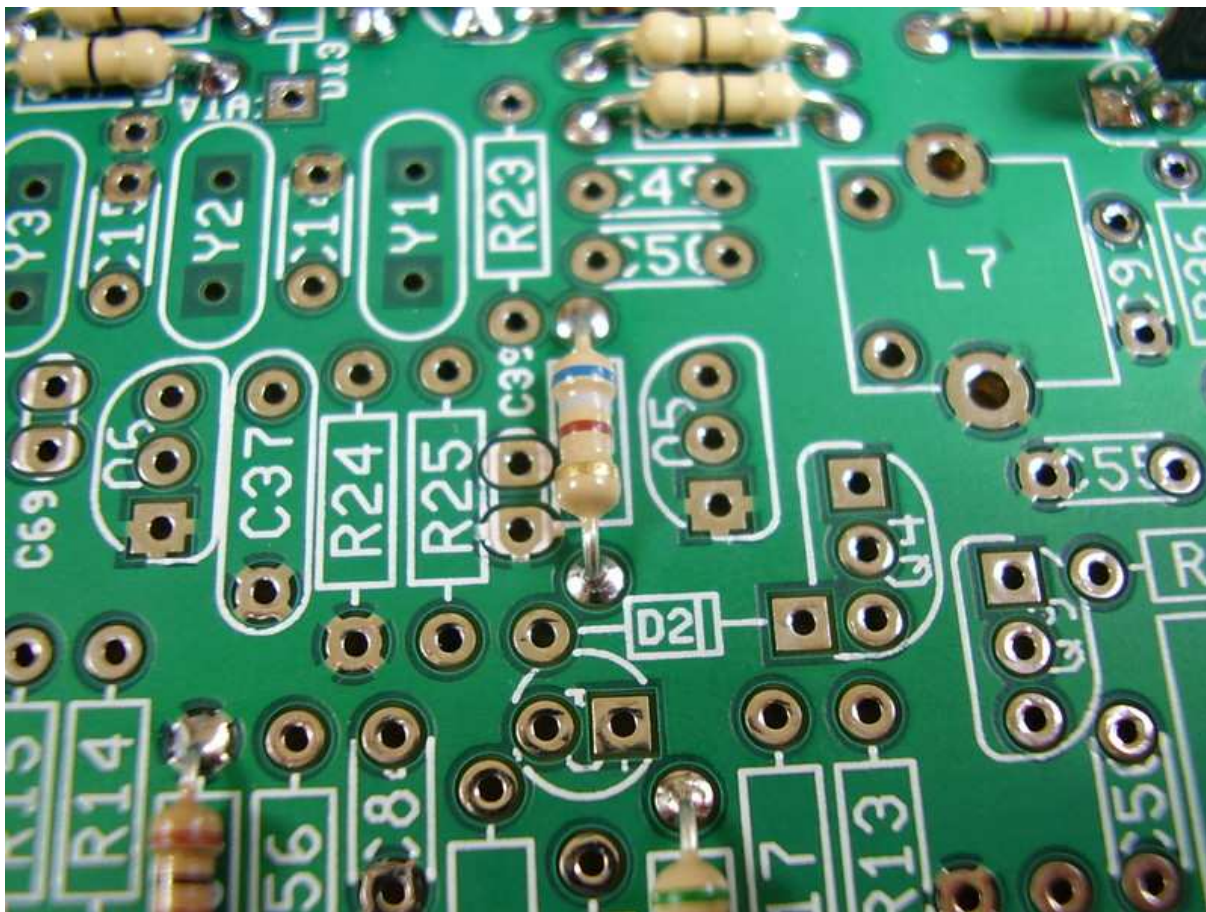

Figure 4.2: [2-4] R22.

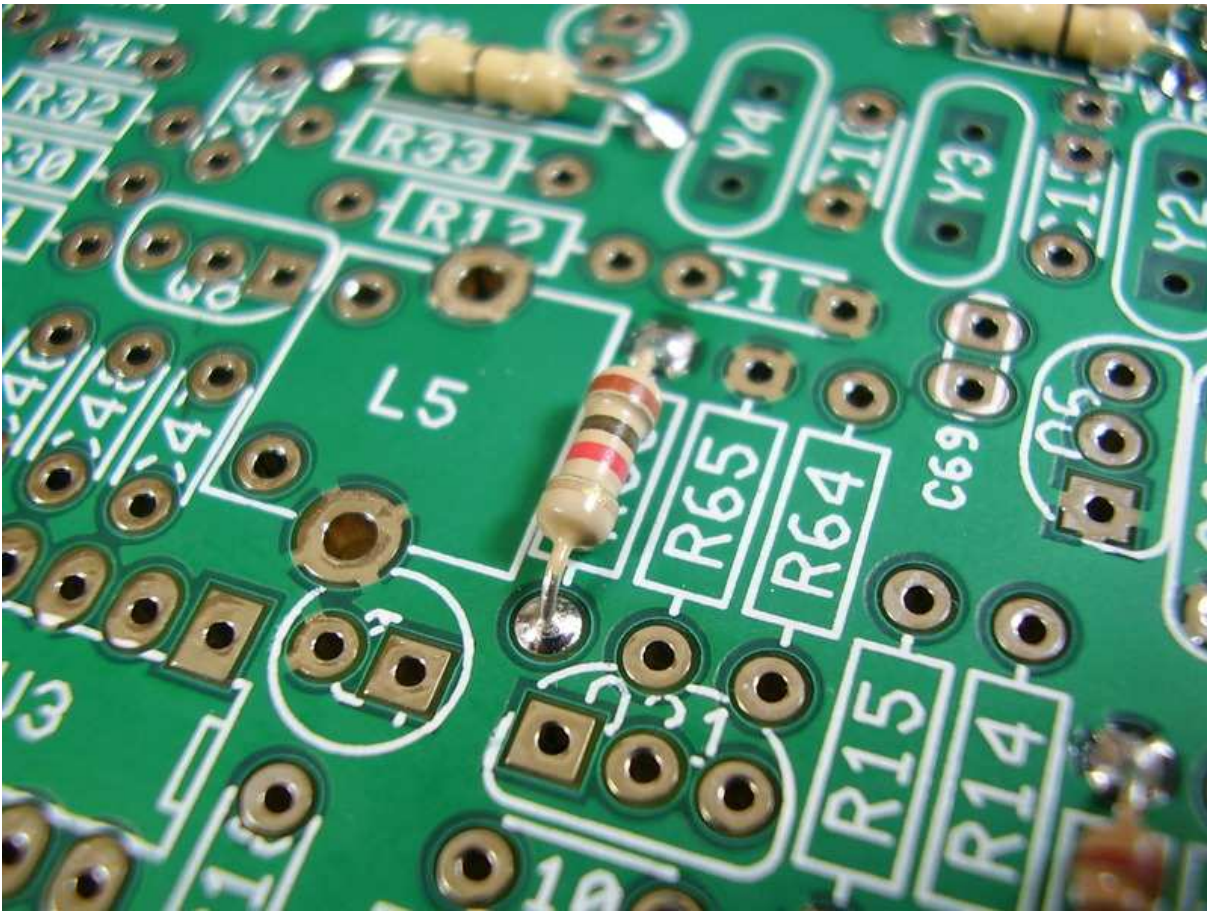

Figure 4.3: [2-5] R66.

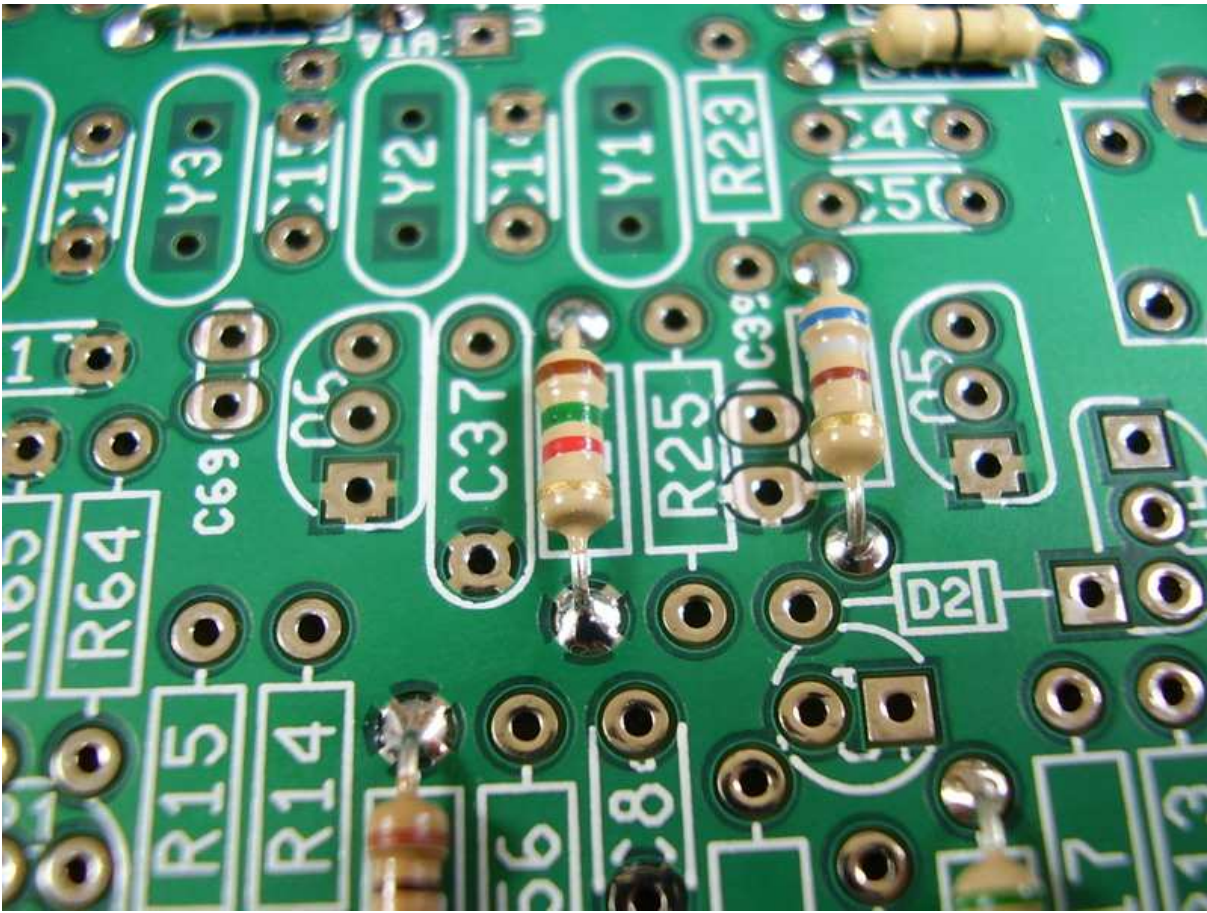

Figure 4.4: [2-6] R24 1.5K.

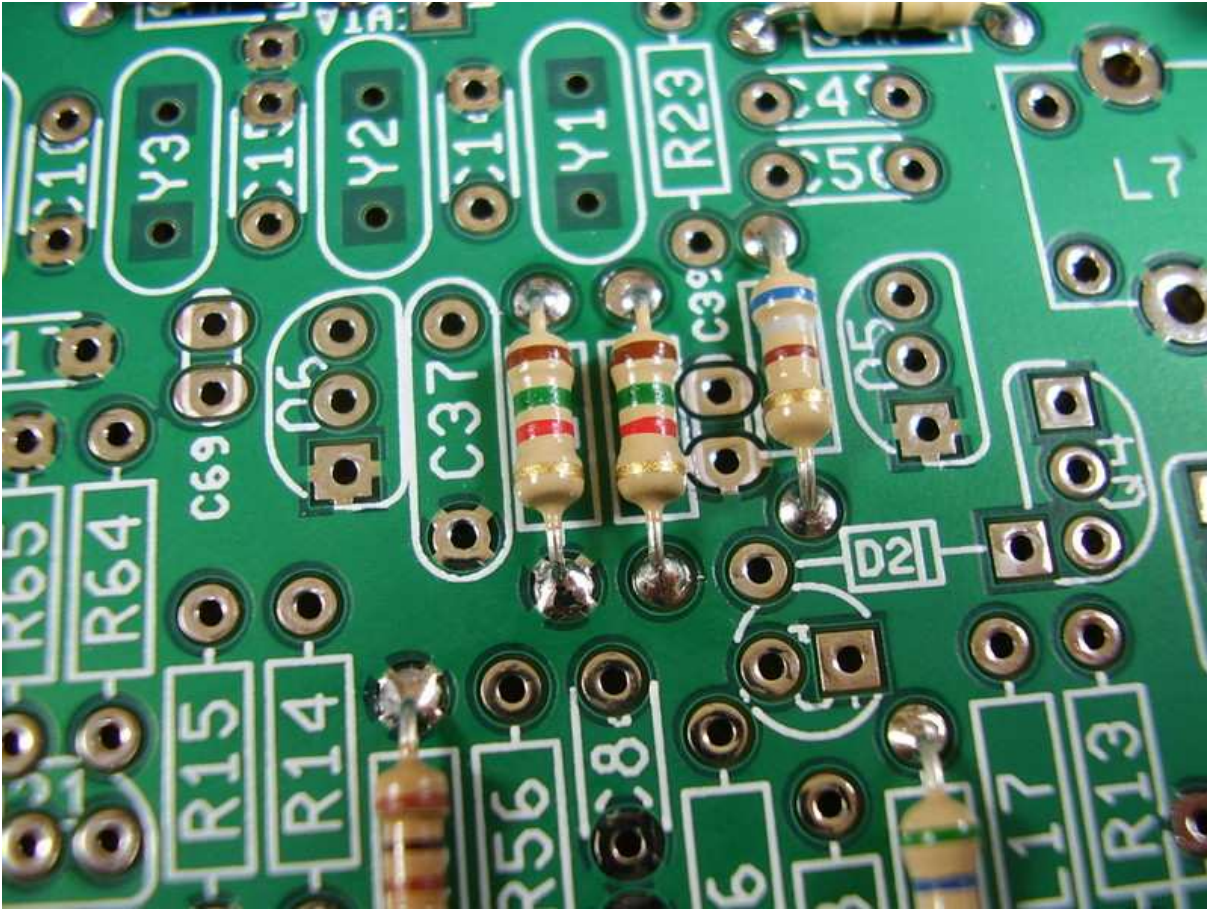

Figure 4.5: [2-7] R25 1.5K.

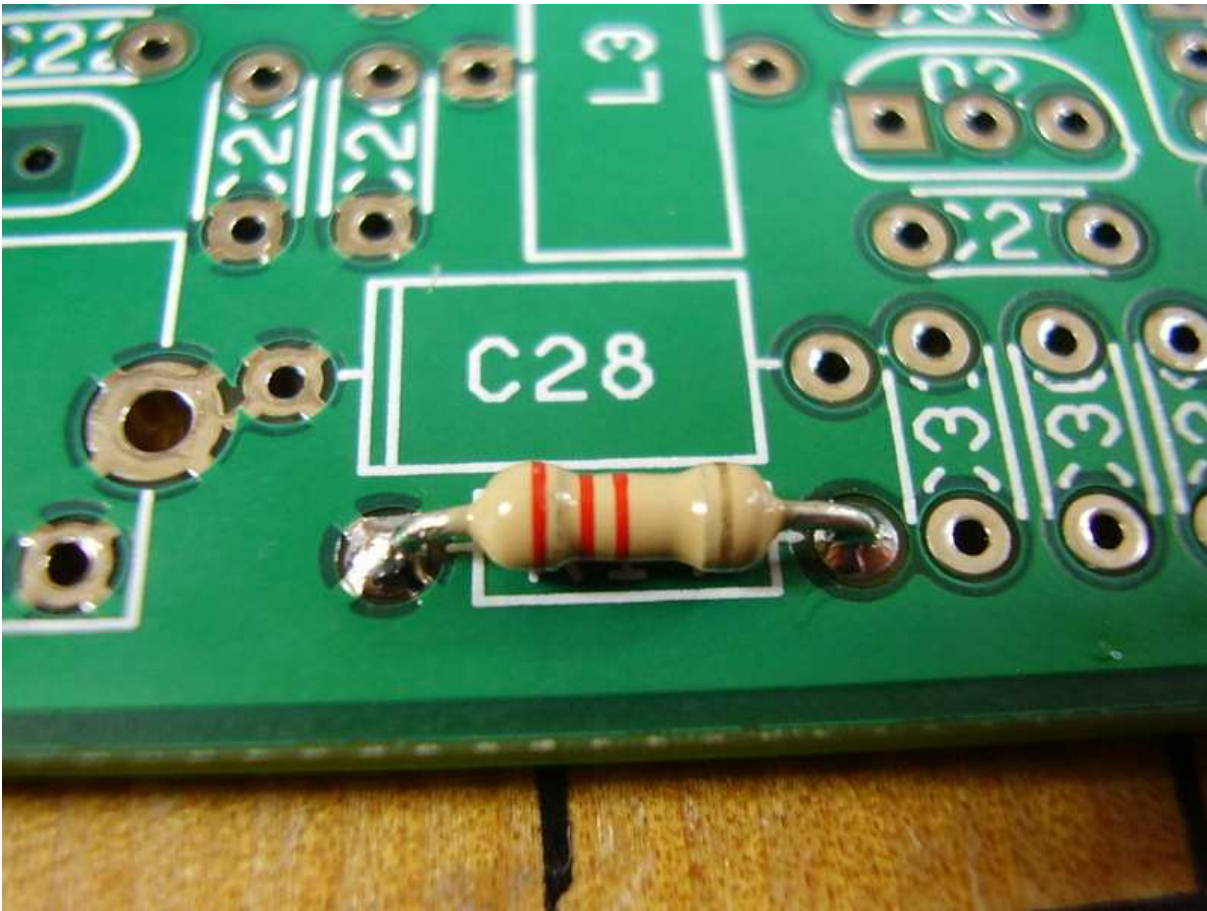

Figure 4.6: [2-8] R17 2.2K.

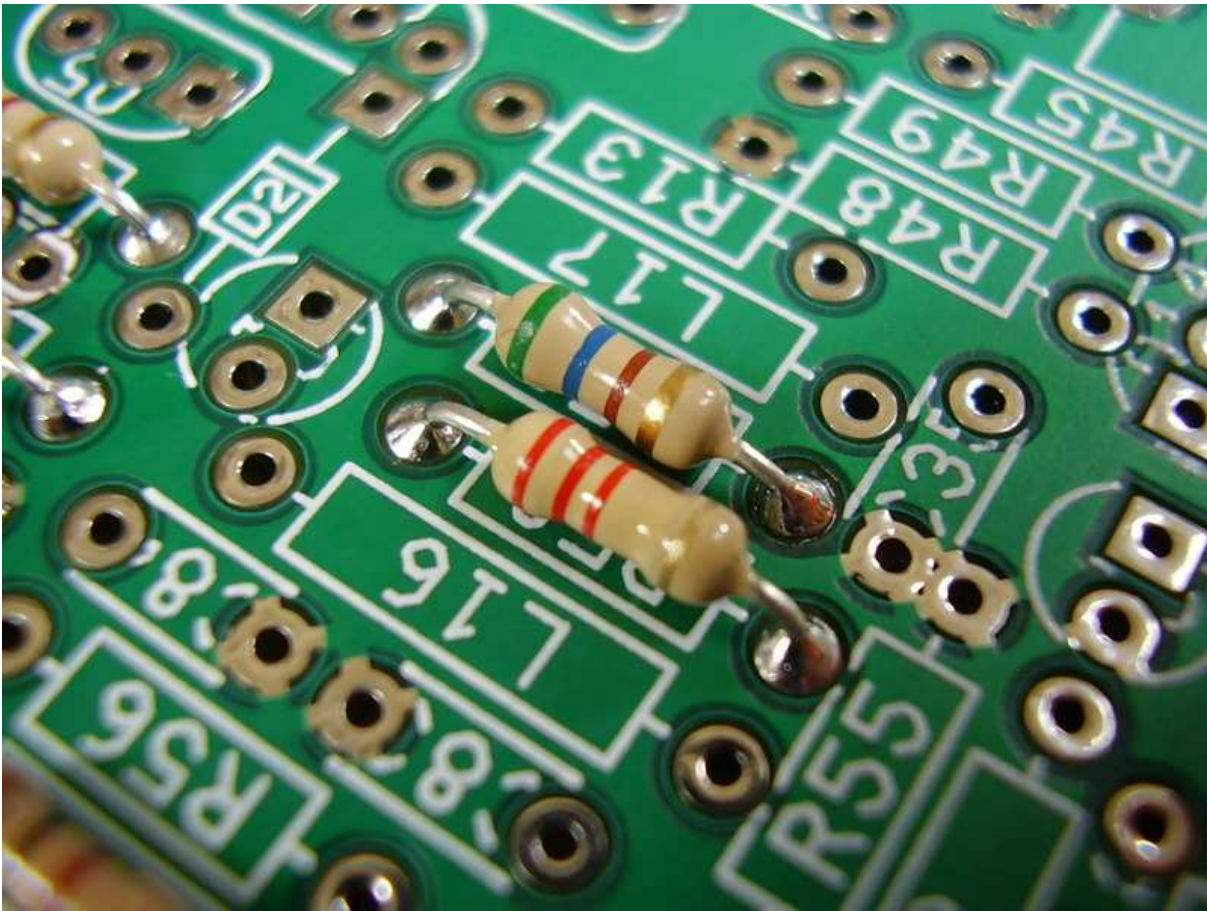

Figure 4.7: [2-9] R58 2.2K.

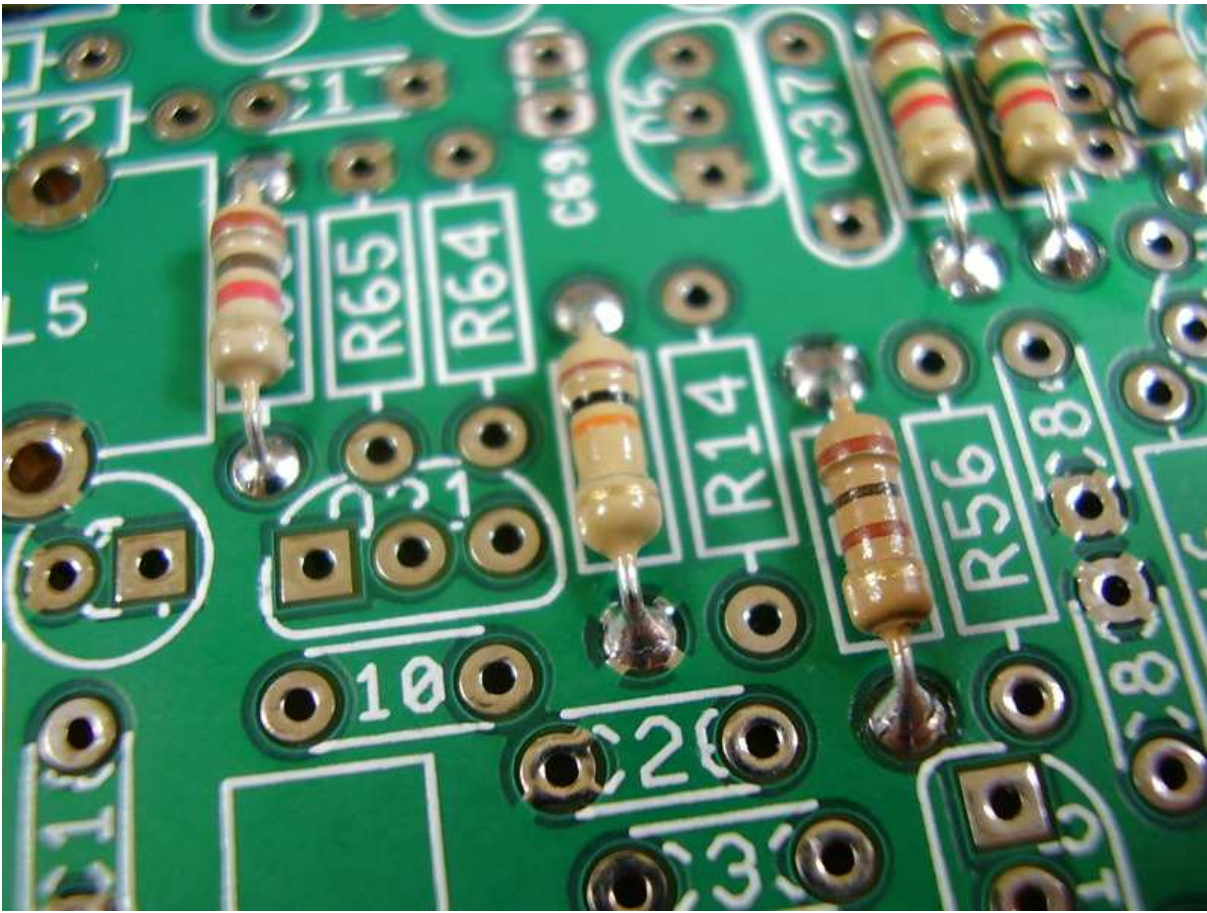

Figure 4.8: [2-10] R15 10K.

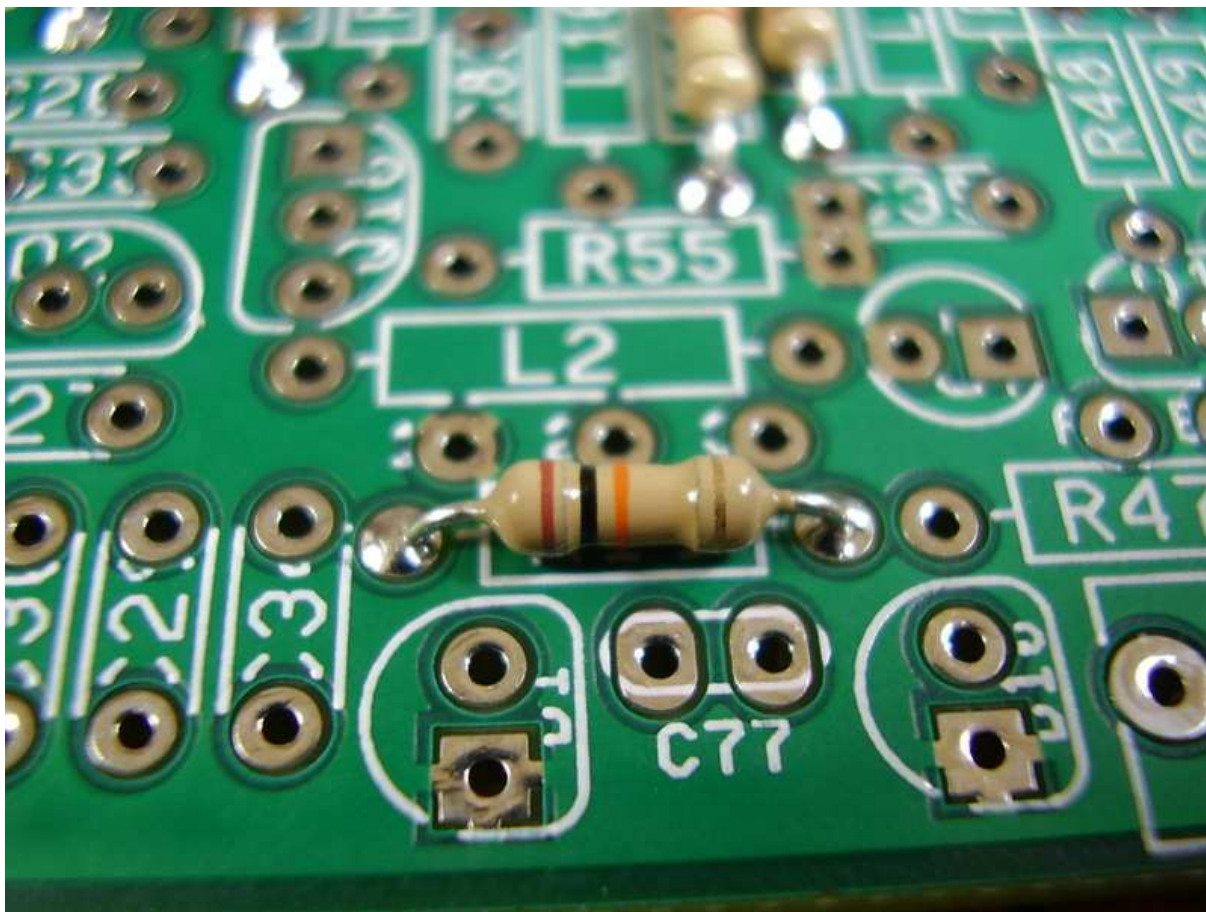

Figure 4.9: [2-11] R19 10K.

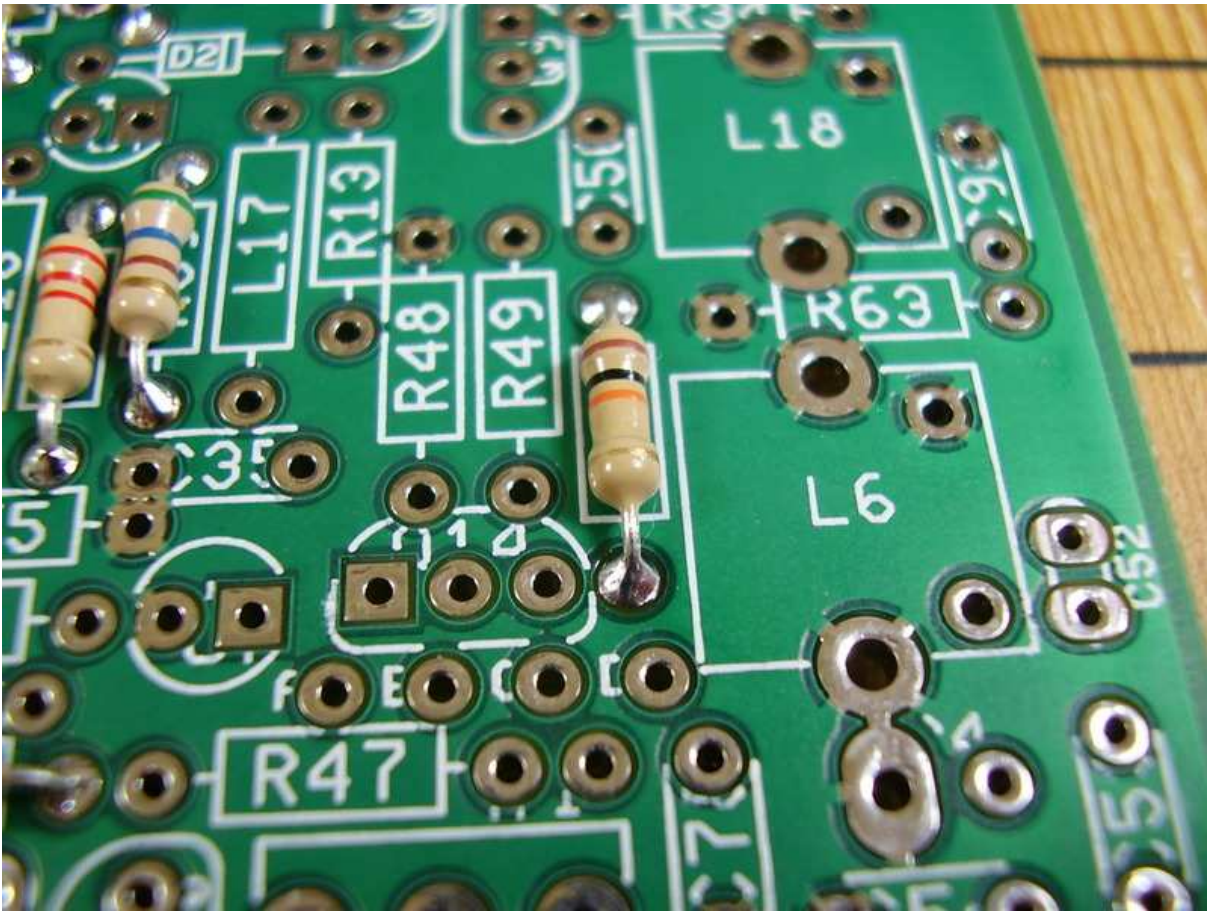

Figure 4.10: [2-12] R45 10K.

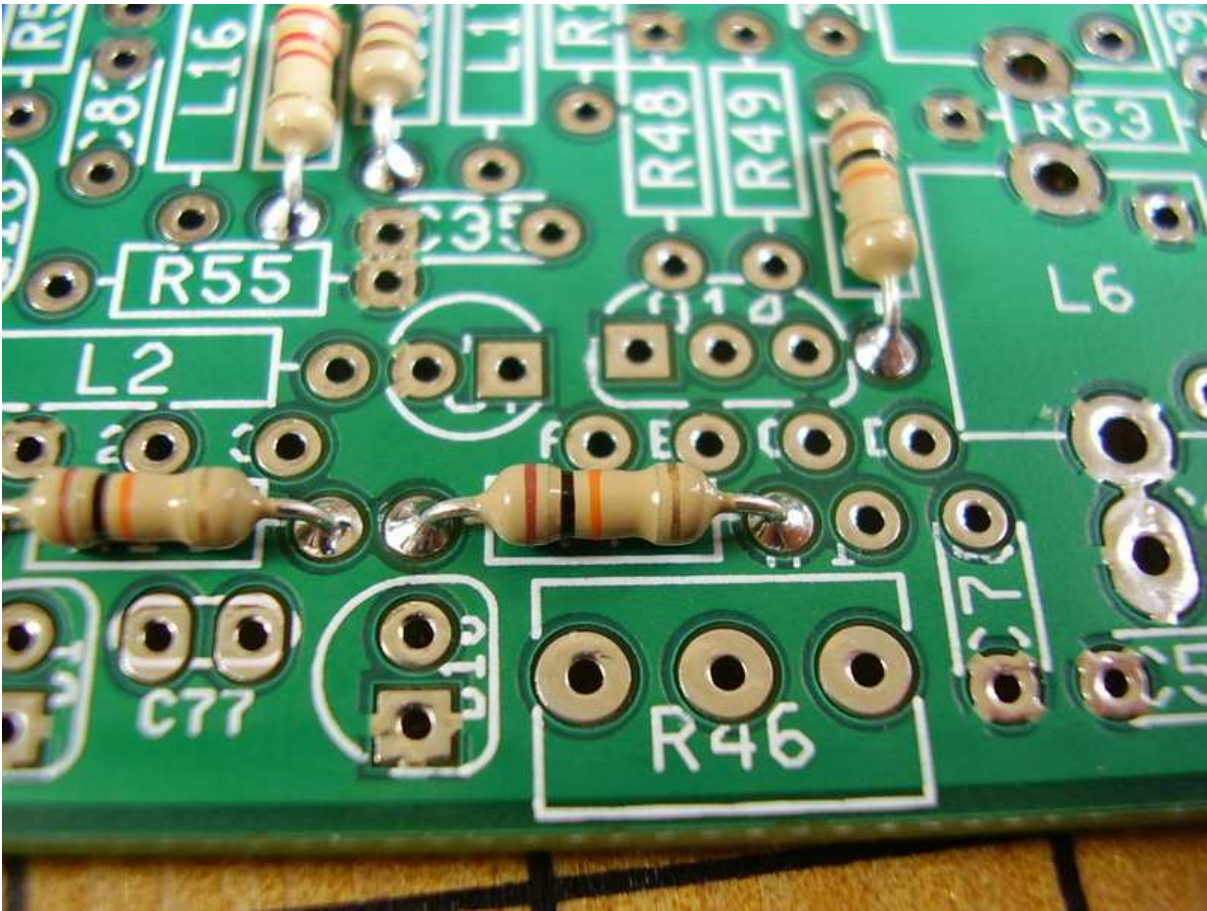

Figure 4.11: [2-13] R47 10K.

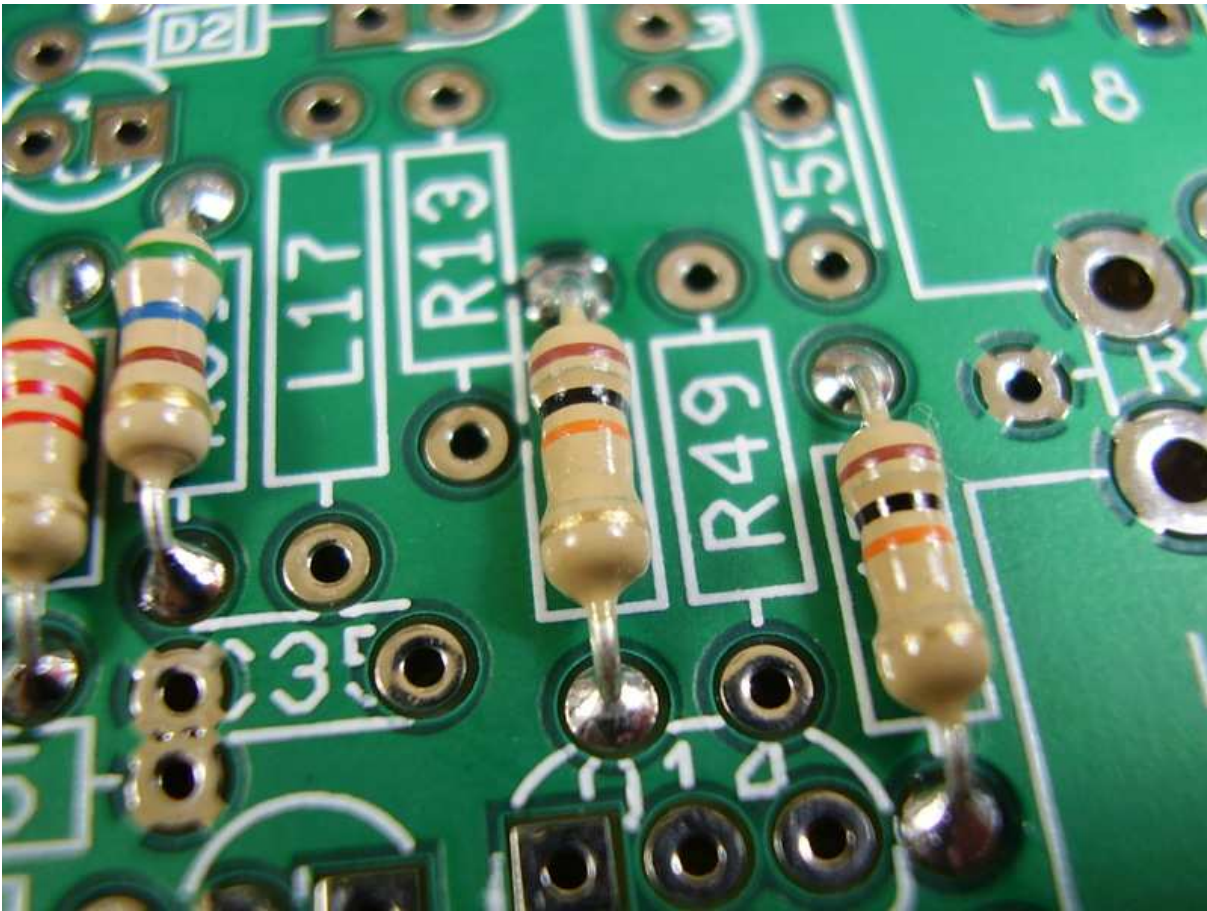

Figure 4.12: [2-14] R48 10K.

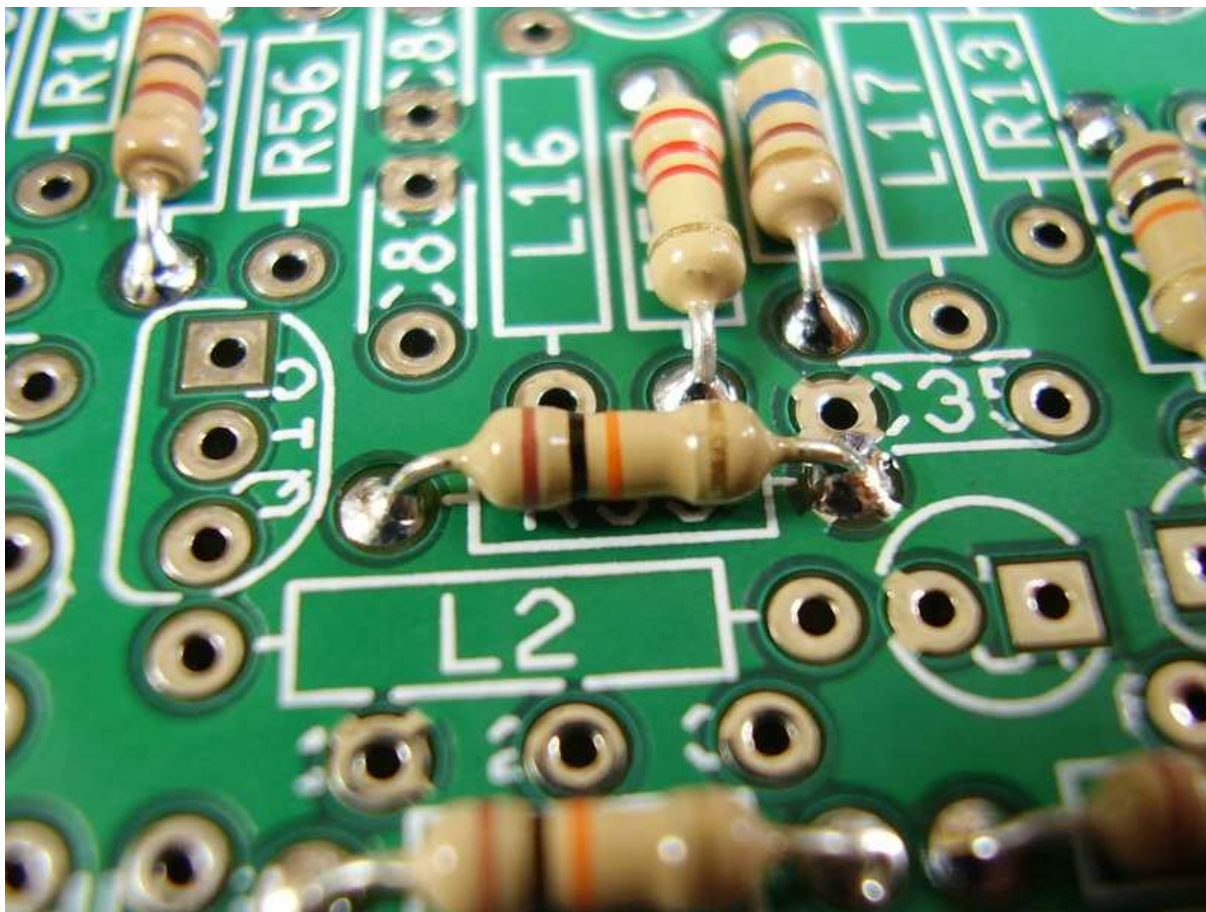

Figure 4.13: [2-15] R55 10K.

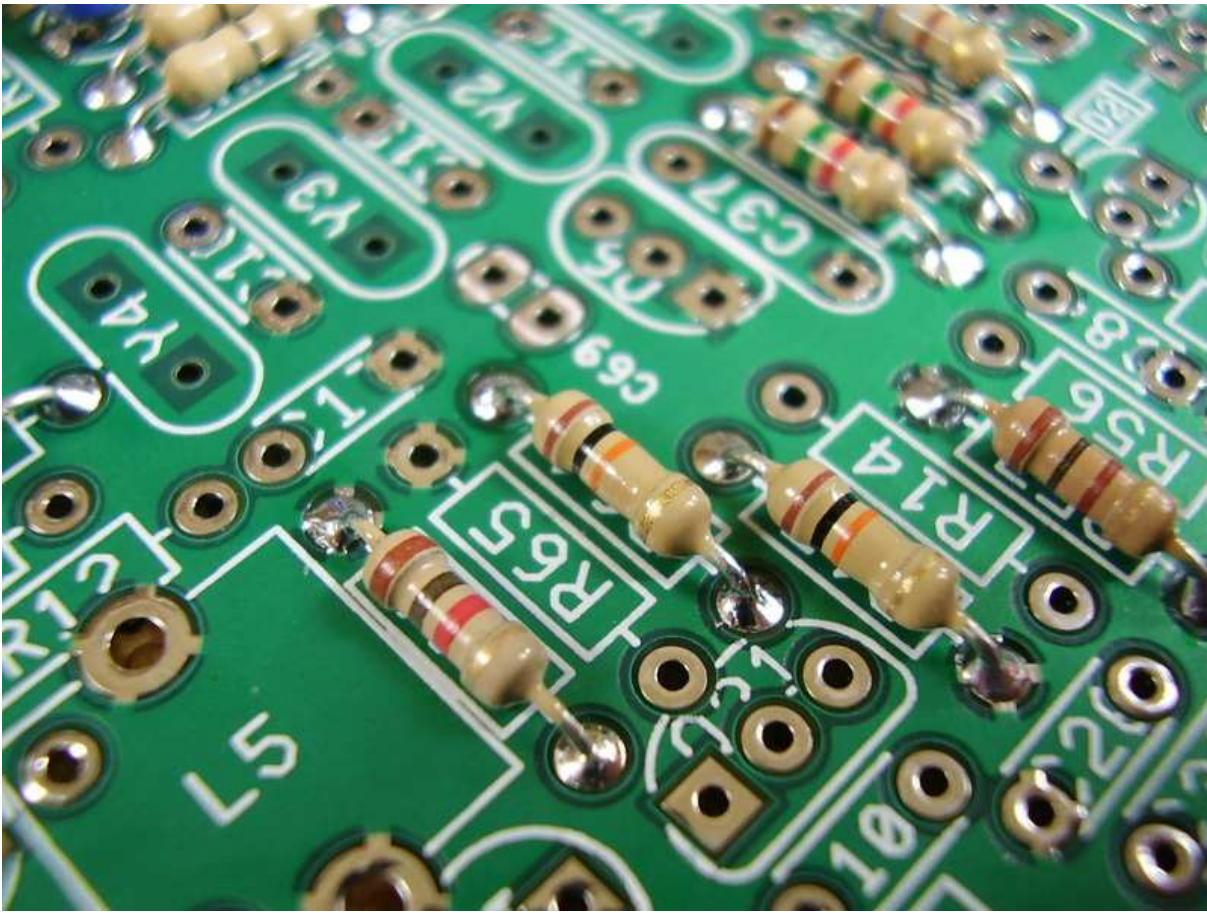

Figure 4.14: [2-16] R64 10K.

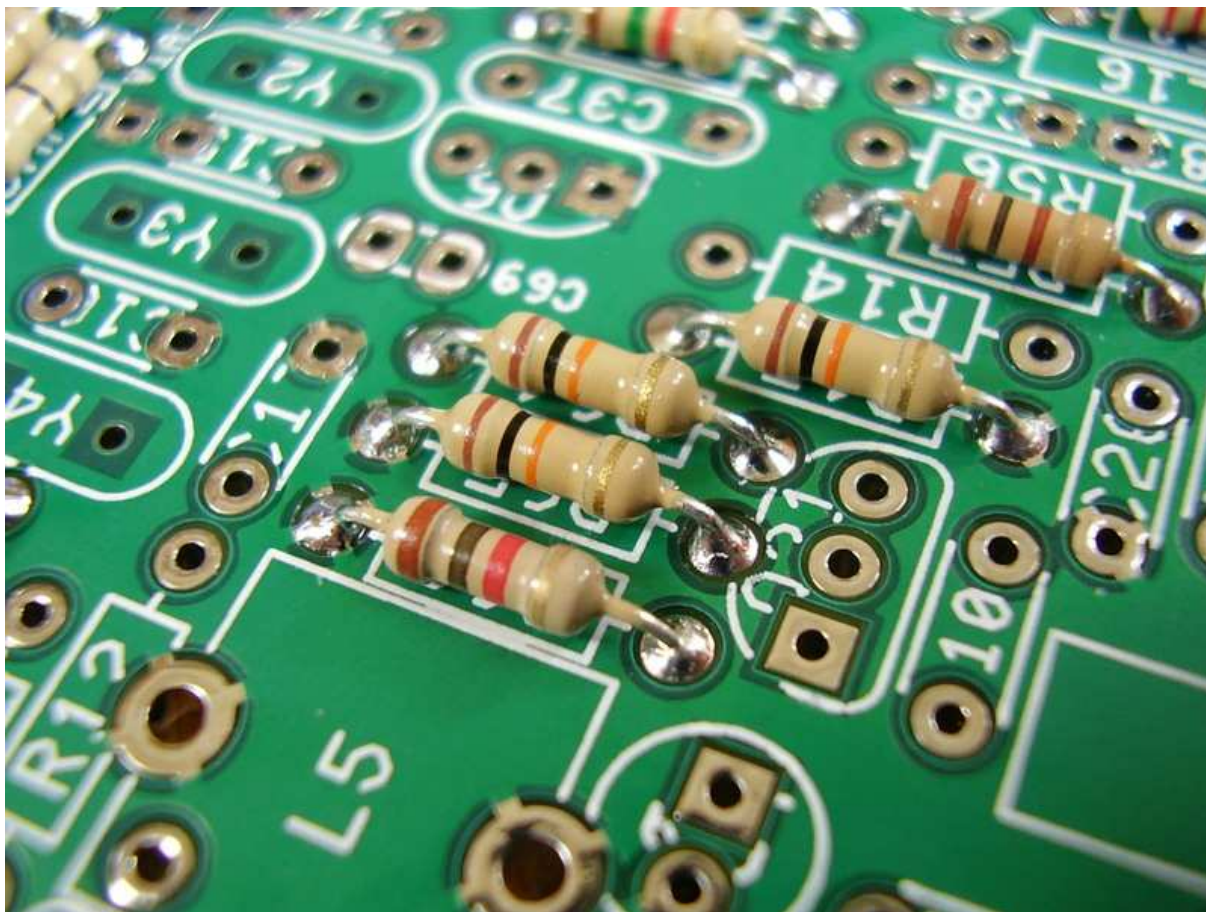

Figure 4.15: [2-17] R65 10K.

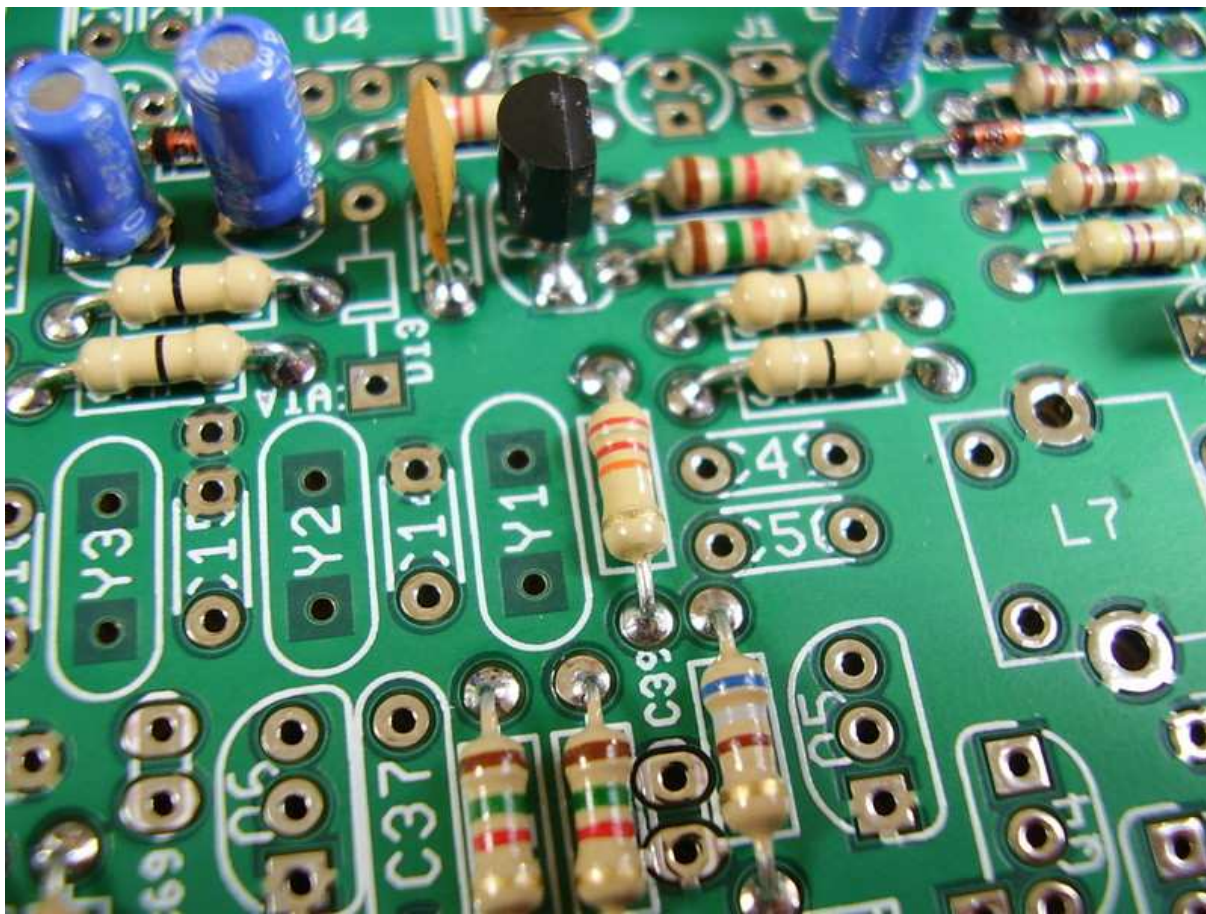

Figure 4.16: [2-18] R23 22K.

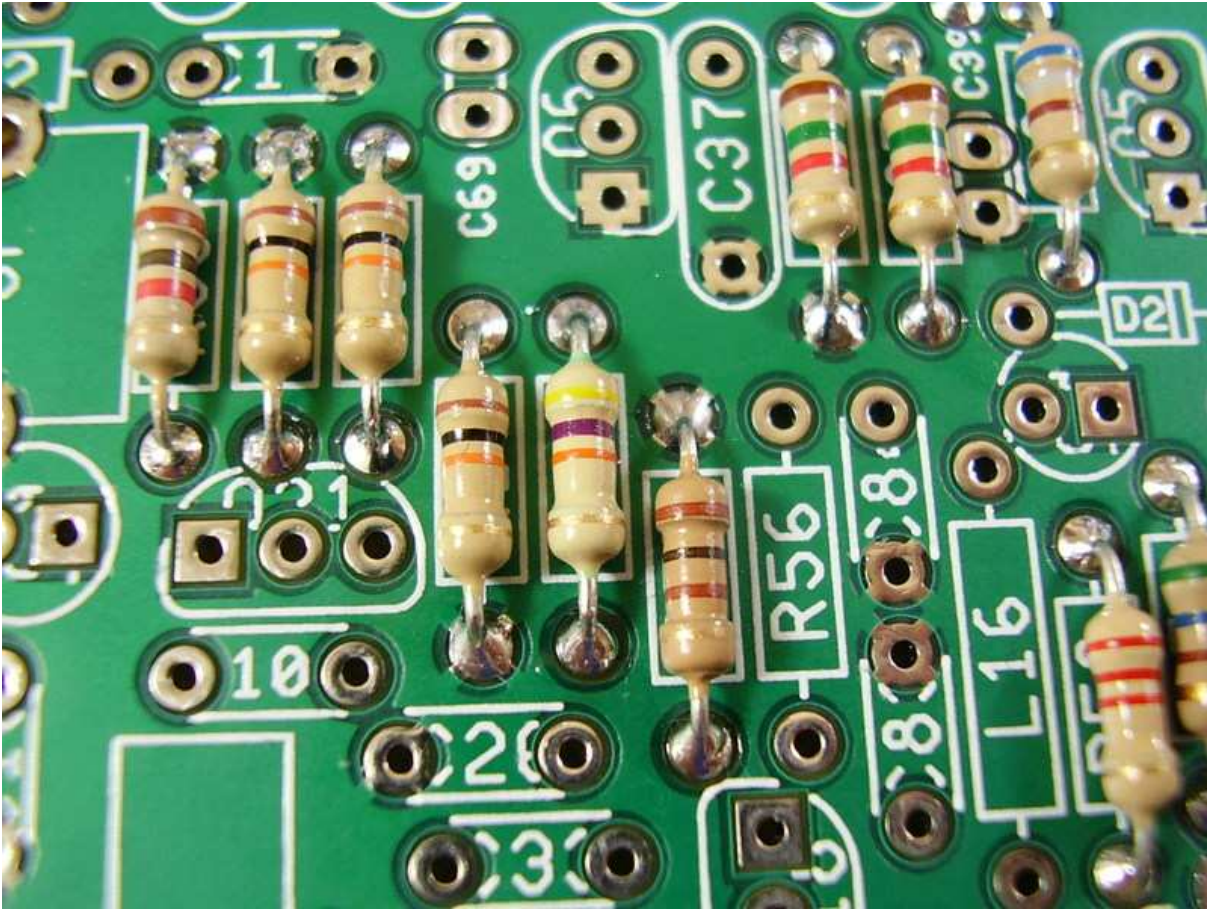

Figure 4.17: [2-19] R14 47K.

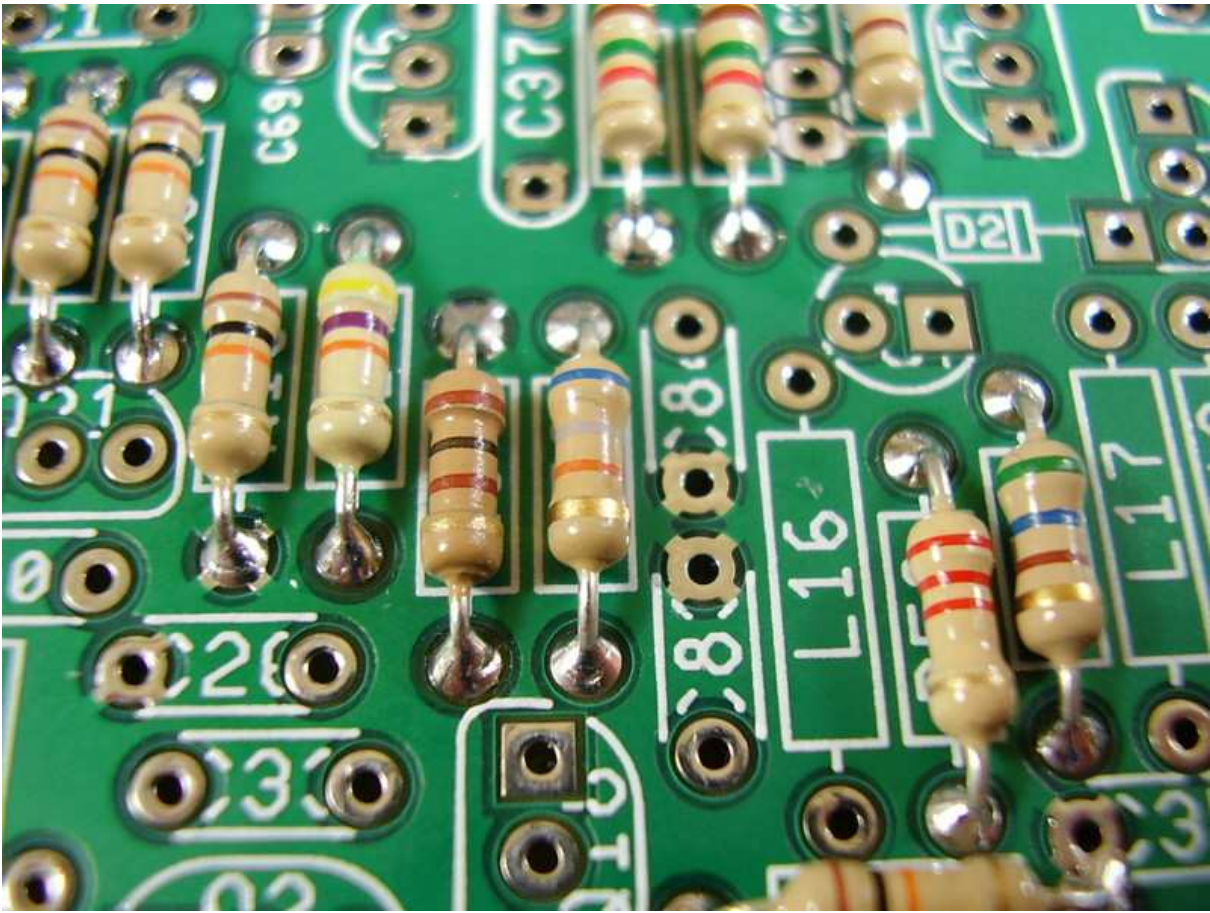

Figure 4.18: [2-20] R56 68K.

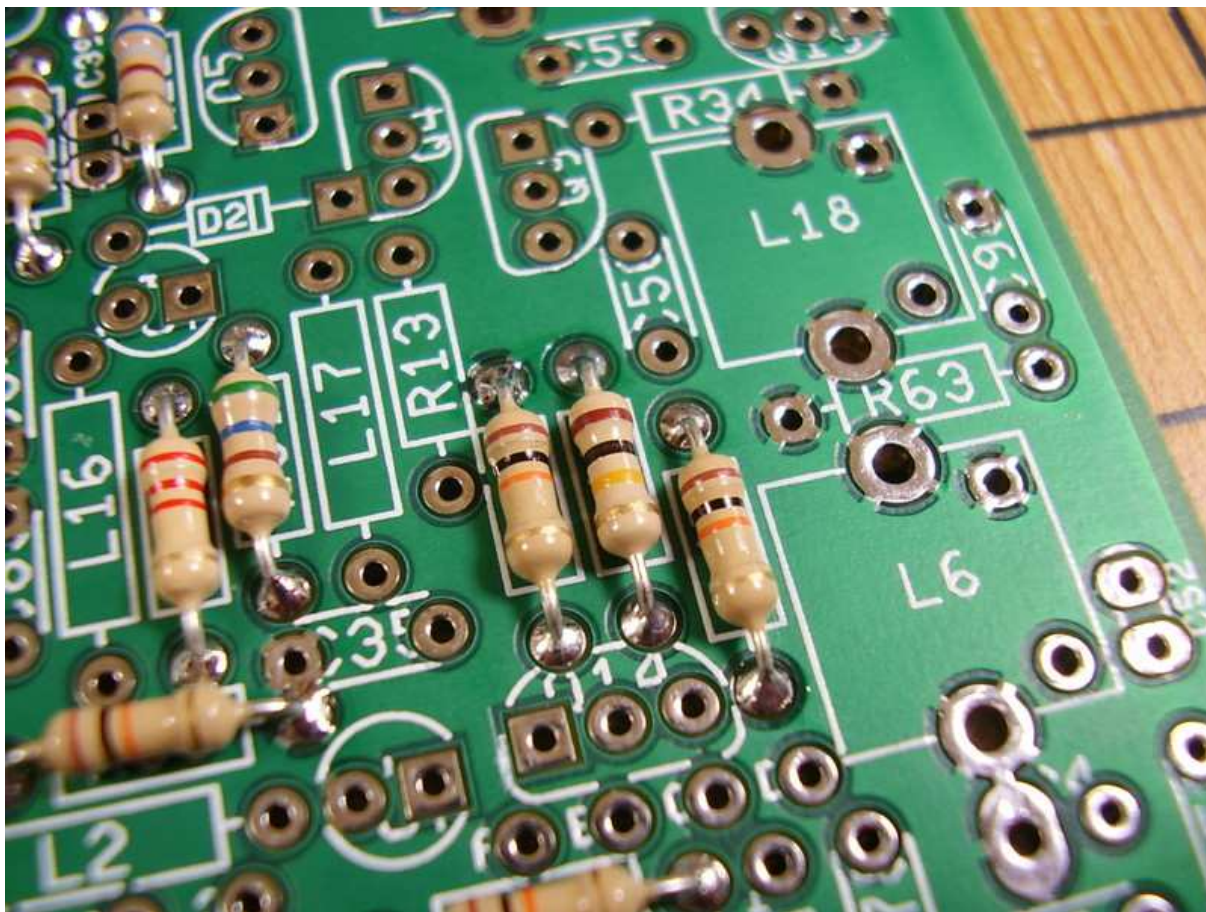

Figure 4.19: [2-21] R49 100K.

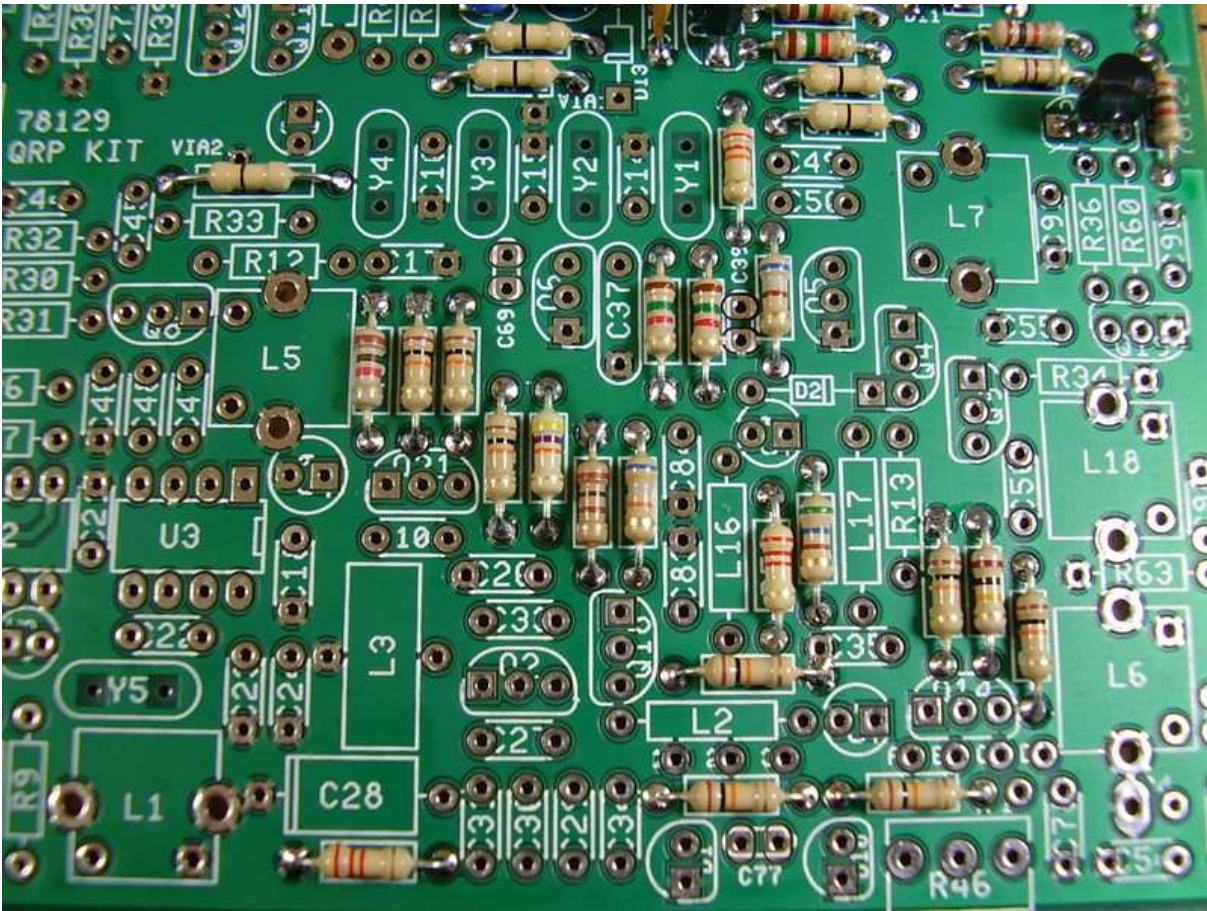

Figure 4.20: Area Currently Installed.



Figure 4.21: $10\mu\text{H}$ Molded Inductor.

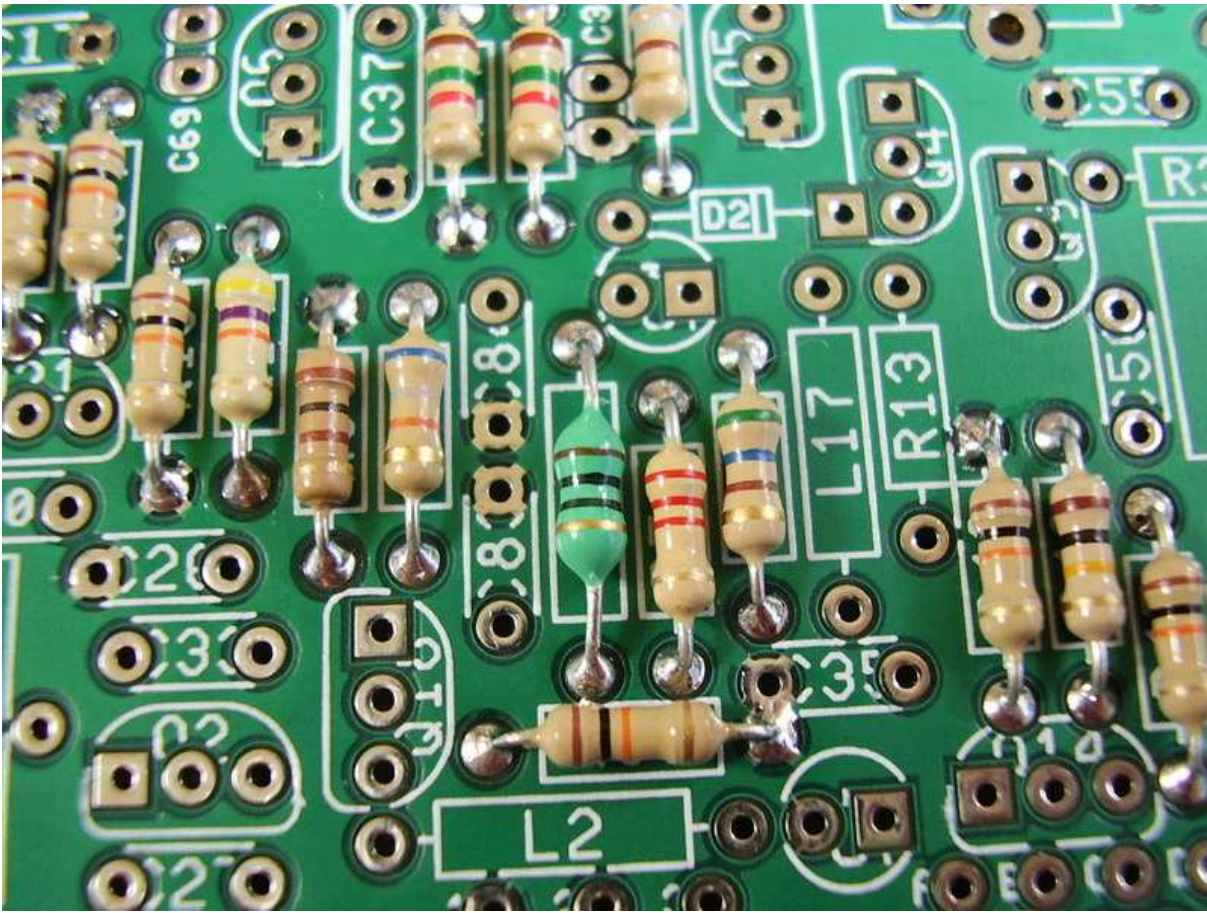

Figure 4.22: [2-22] L16 $10\mu\text{H}$.

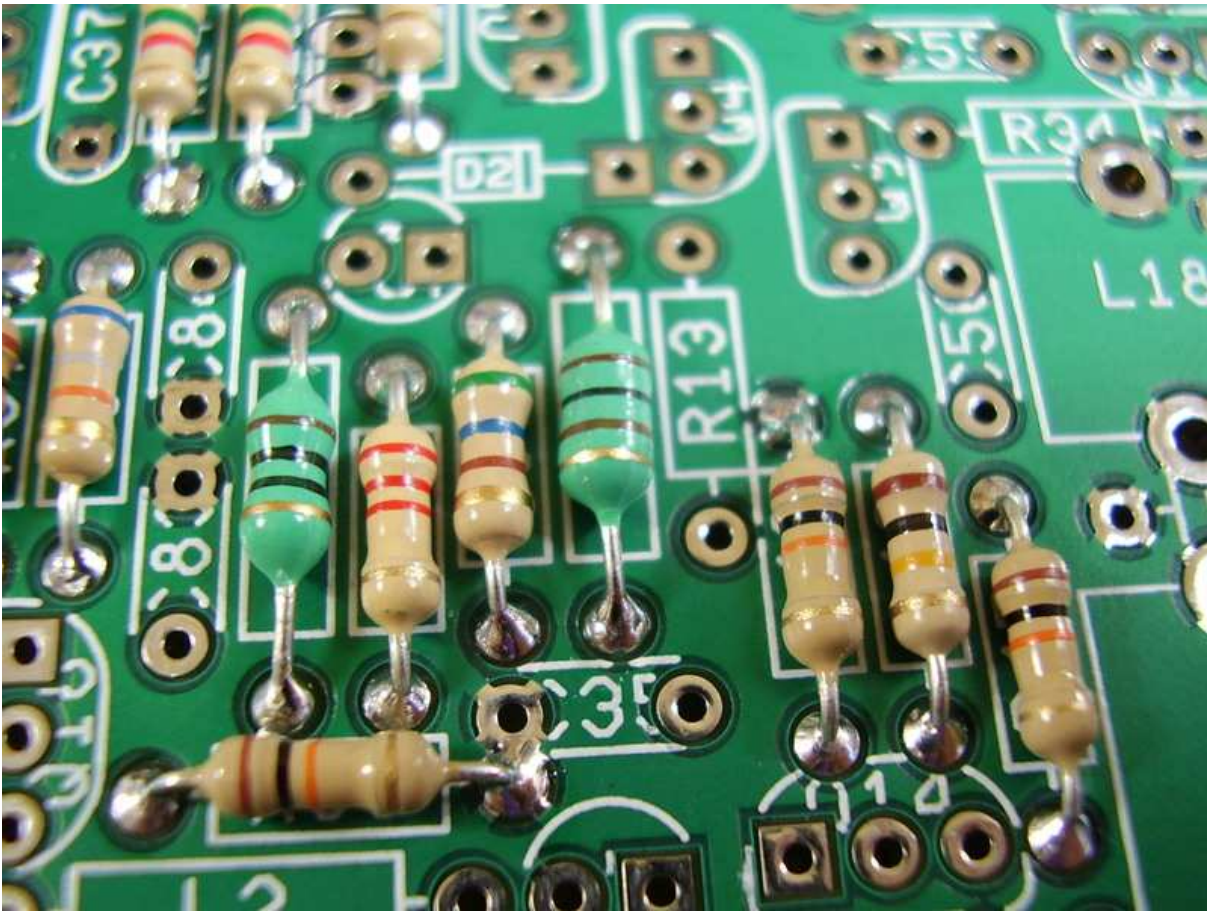

Figure 4.23: [2-23] L17 $100\mu\text{H}$.

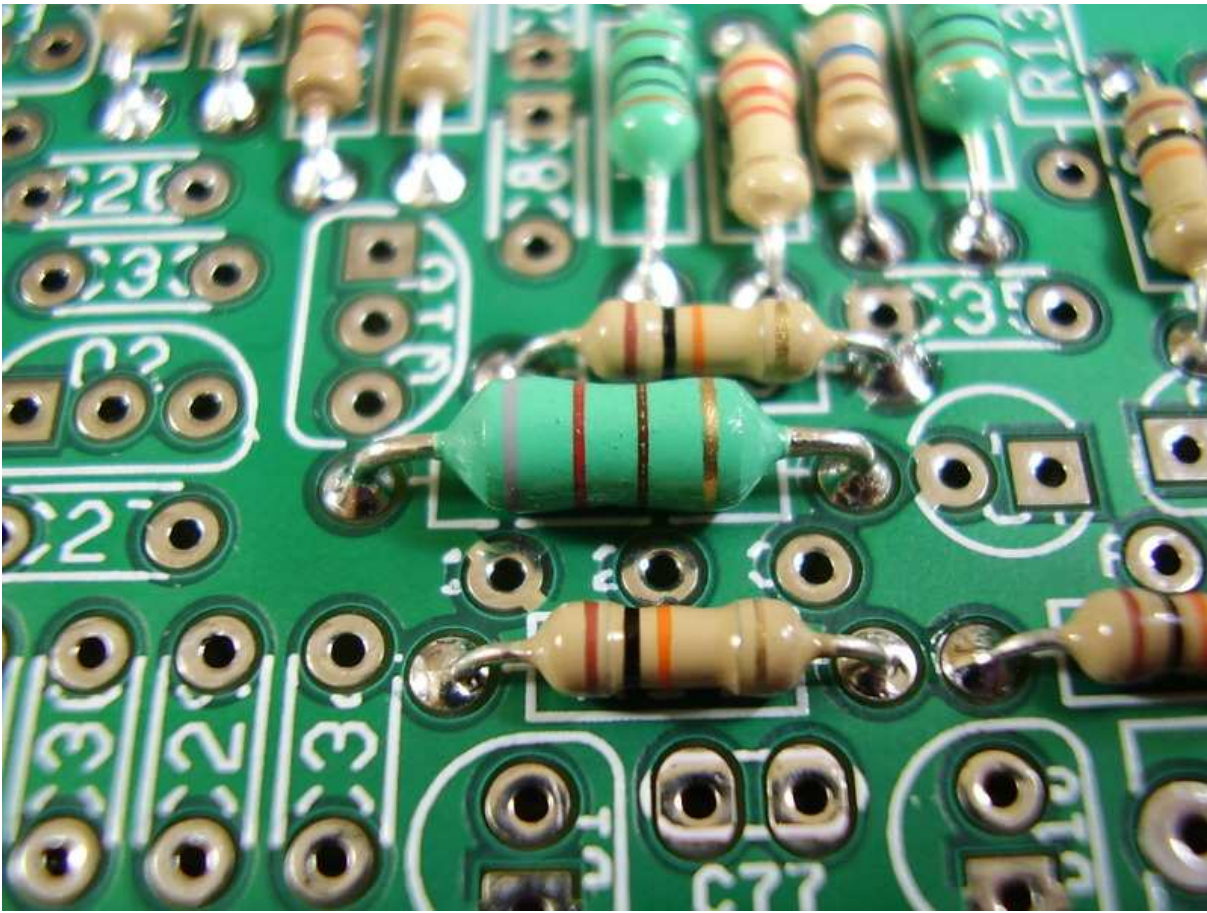

Figure 4.24: [2-24a] L2 $820\mu\text{H}$.

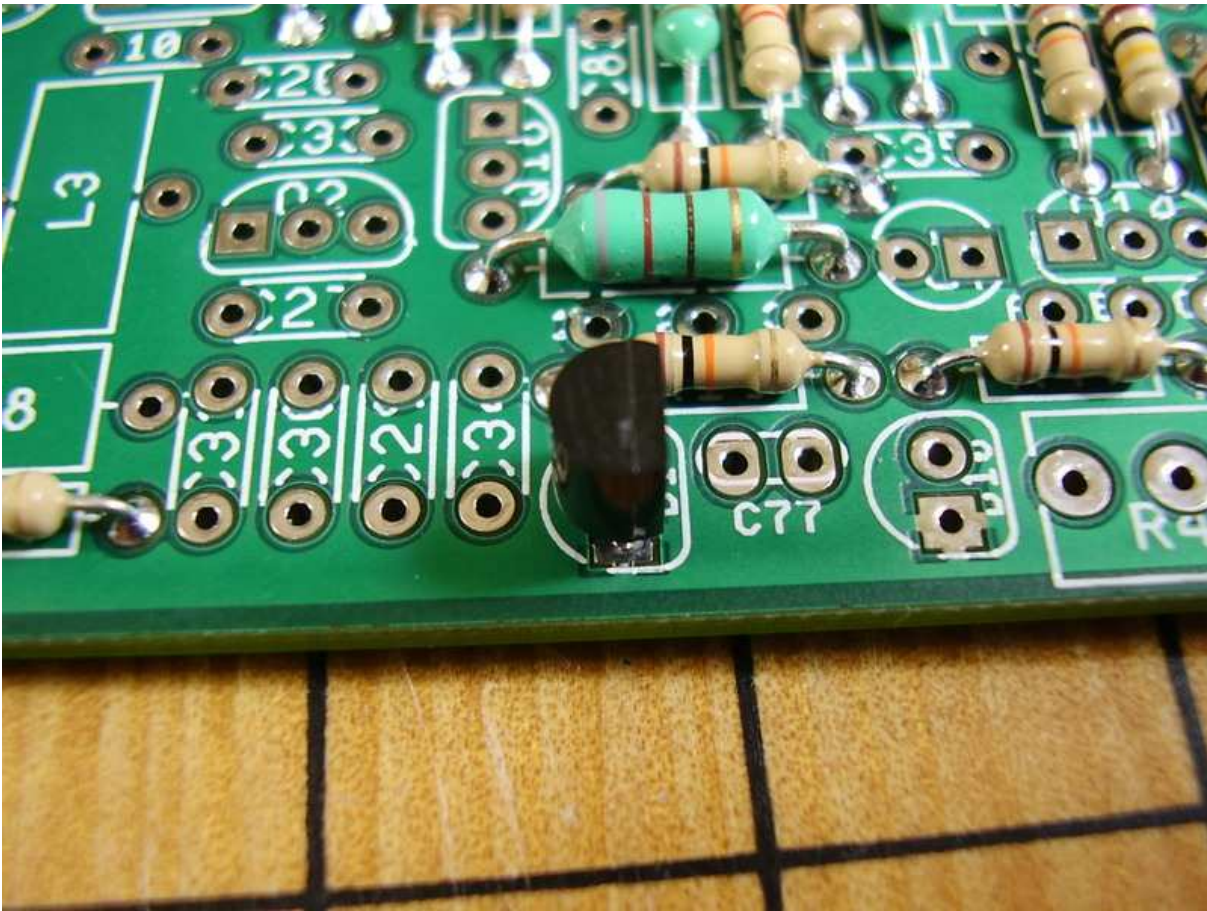

Figure 4.25: [2-25a] D1 MV209 Varactor Diode.

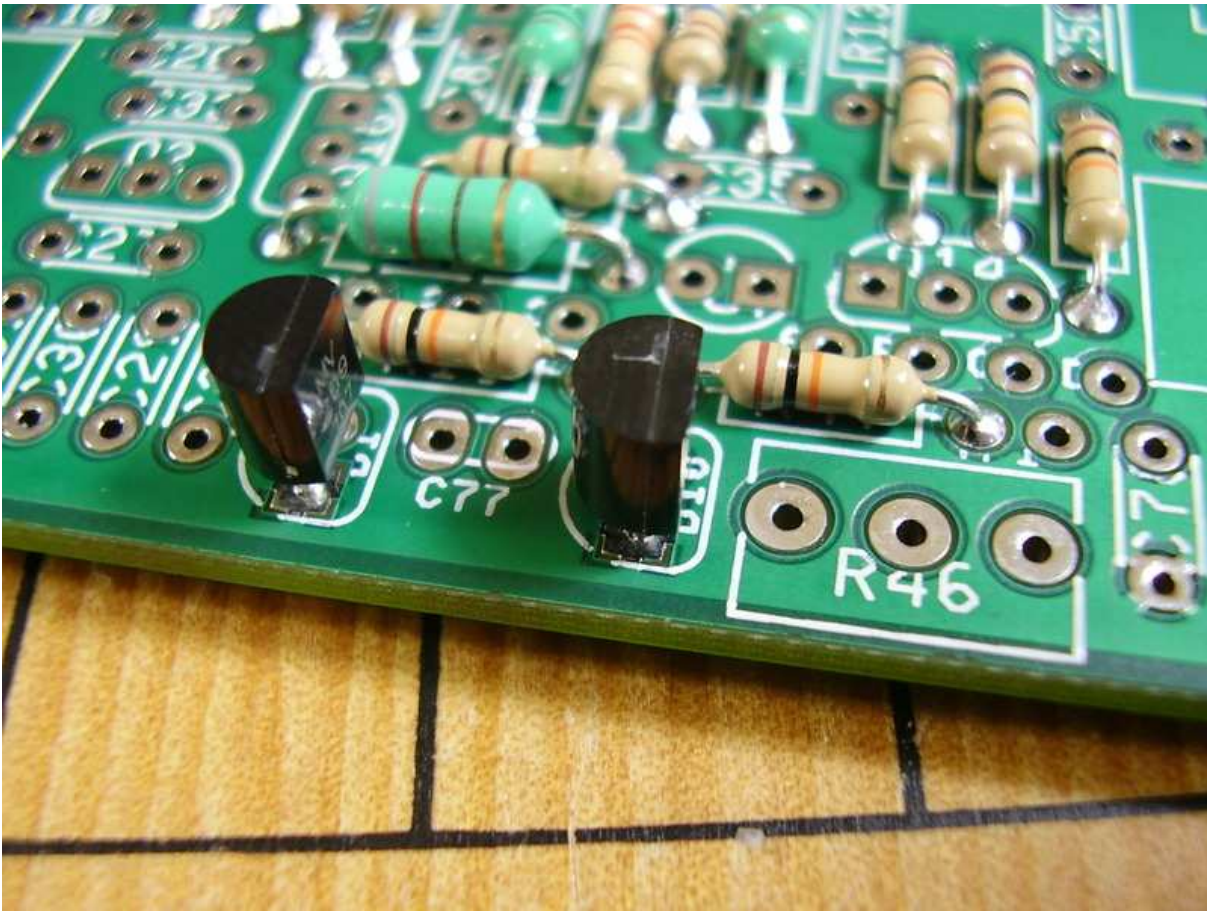

Figure 4.26: [2-25b] D10 MV209 Varactor Diode.

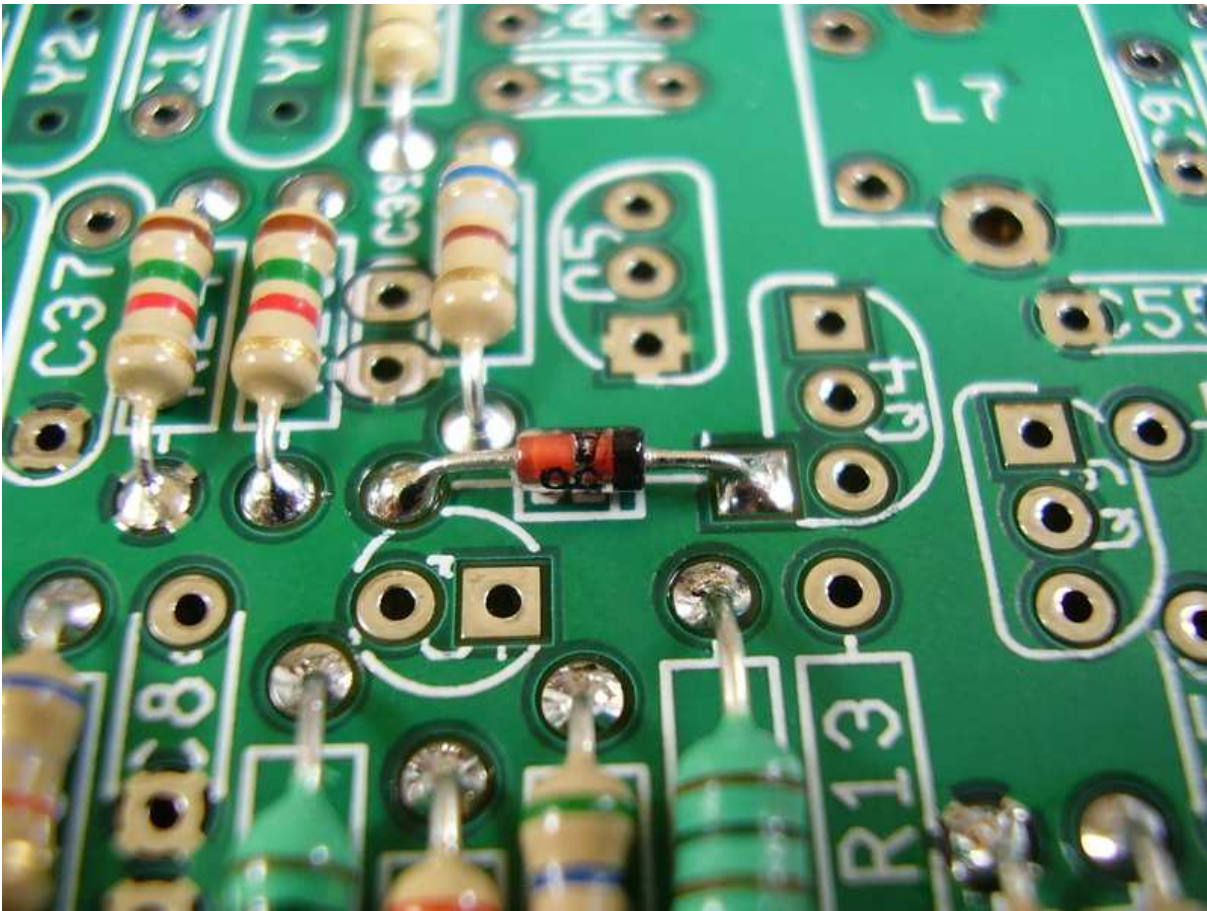

Figure 4.27: [2-26] D2 1N756A Zener Diode.

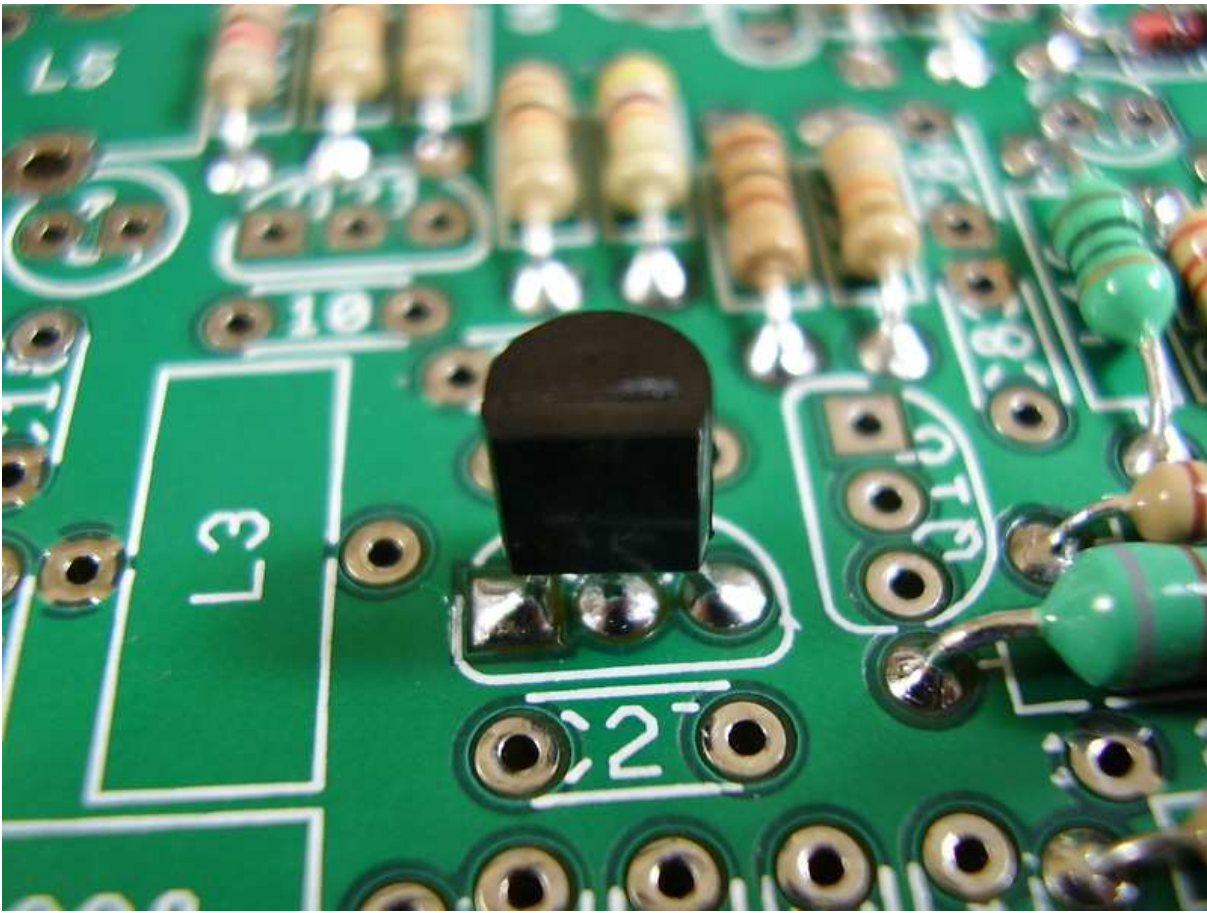

Figure 4.28: [2-27] Q2 2N4124 Transistor.

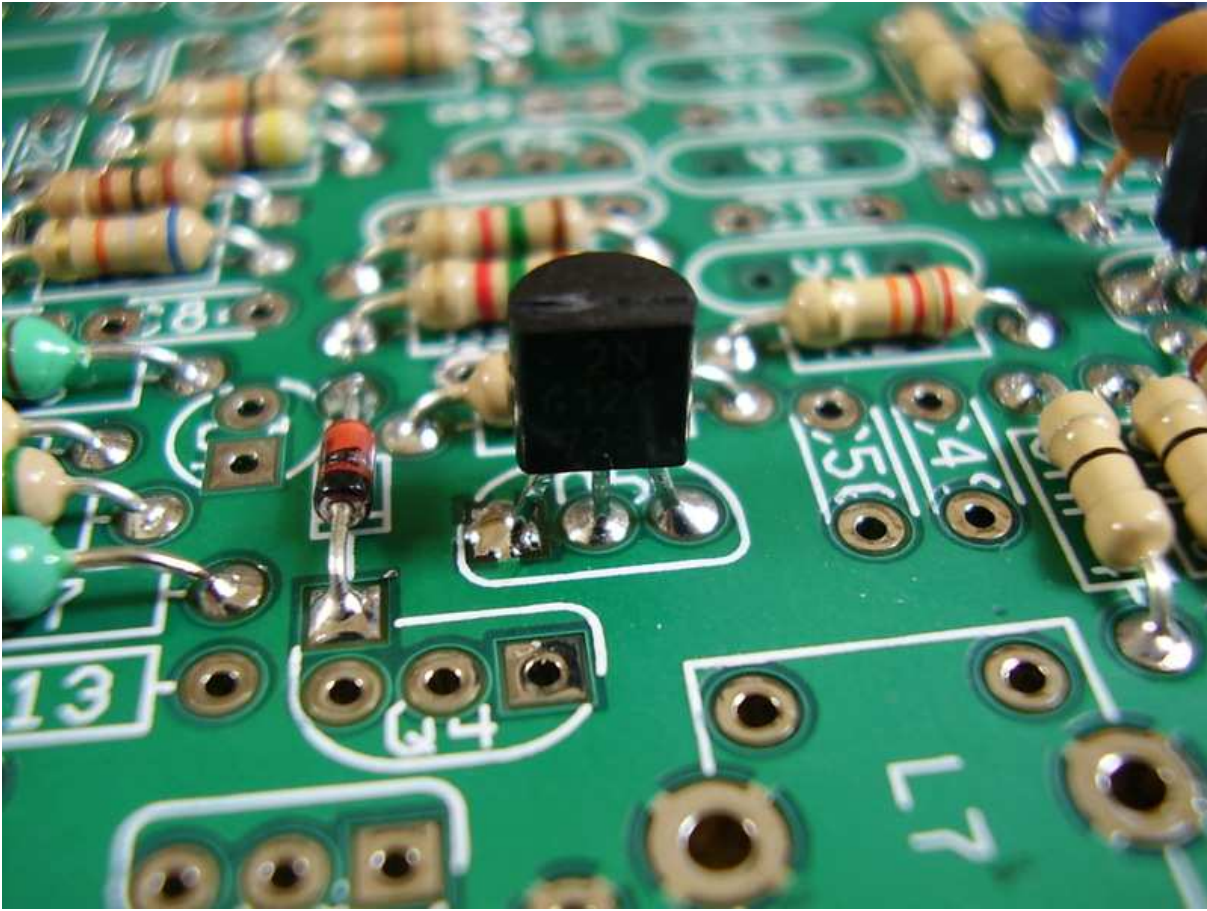

Figure 4.29: [2-28] Q5 2N4124 Transistor.

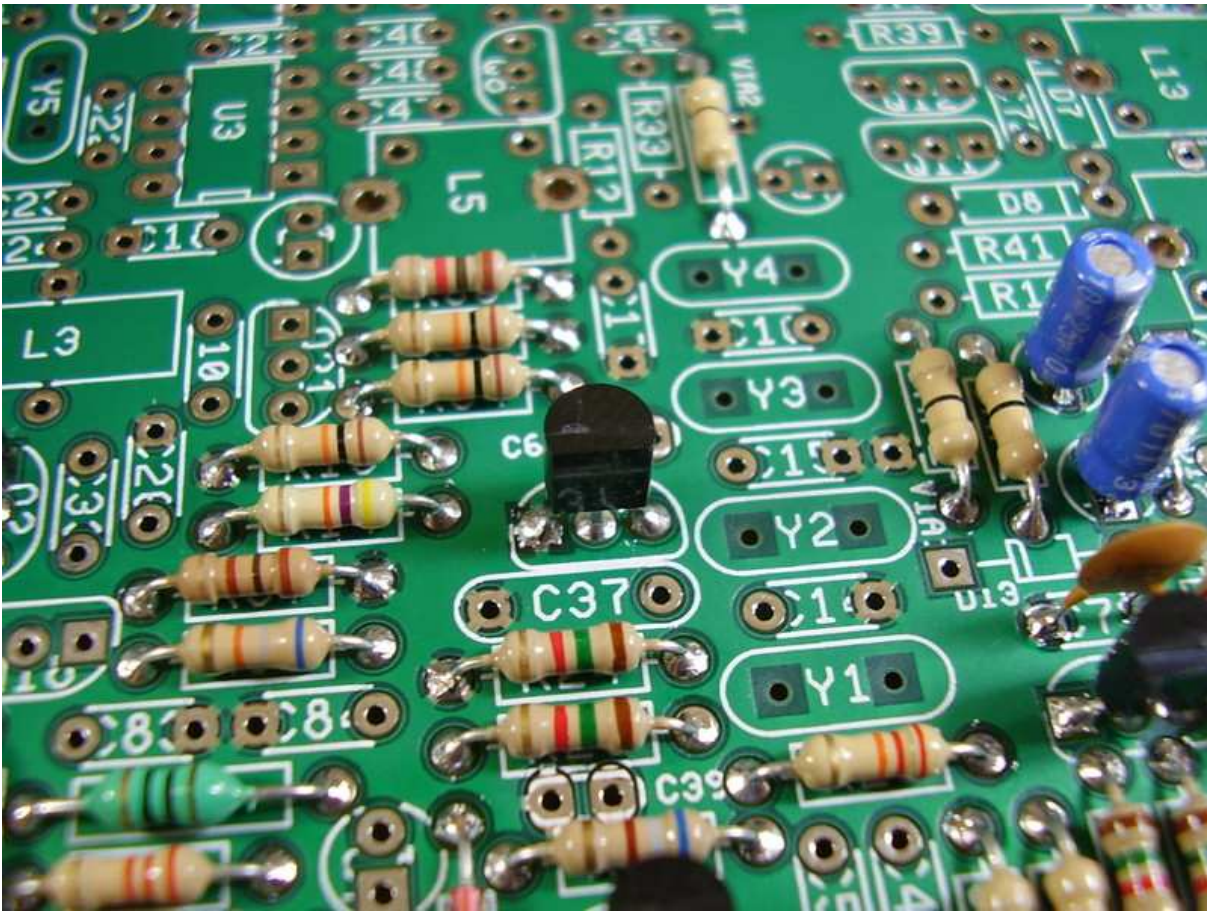

Figure 4.30: [2-29] Q6 2N4124 Transistor.

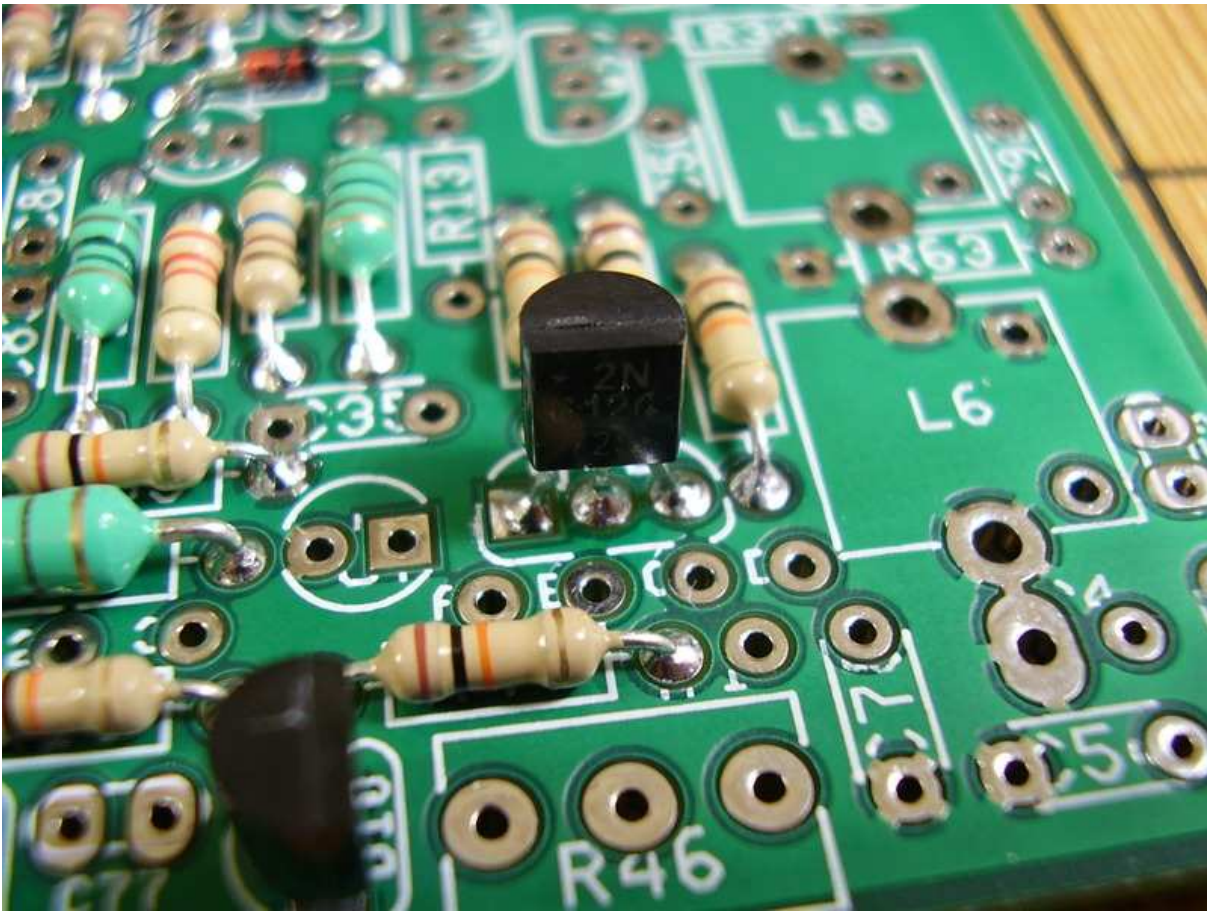

Figure 4.31: [2-30] Q14 2N4124 Transistor.

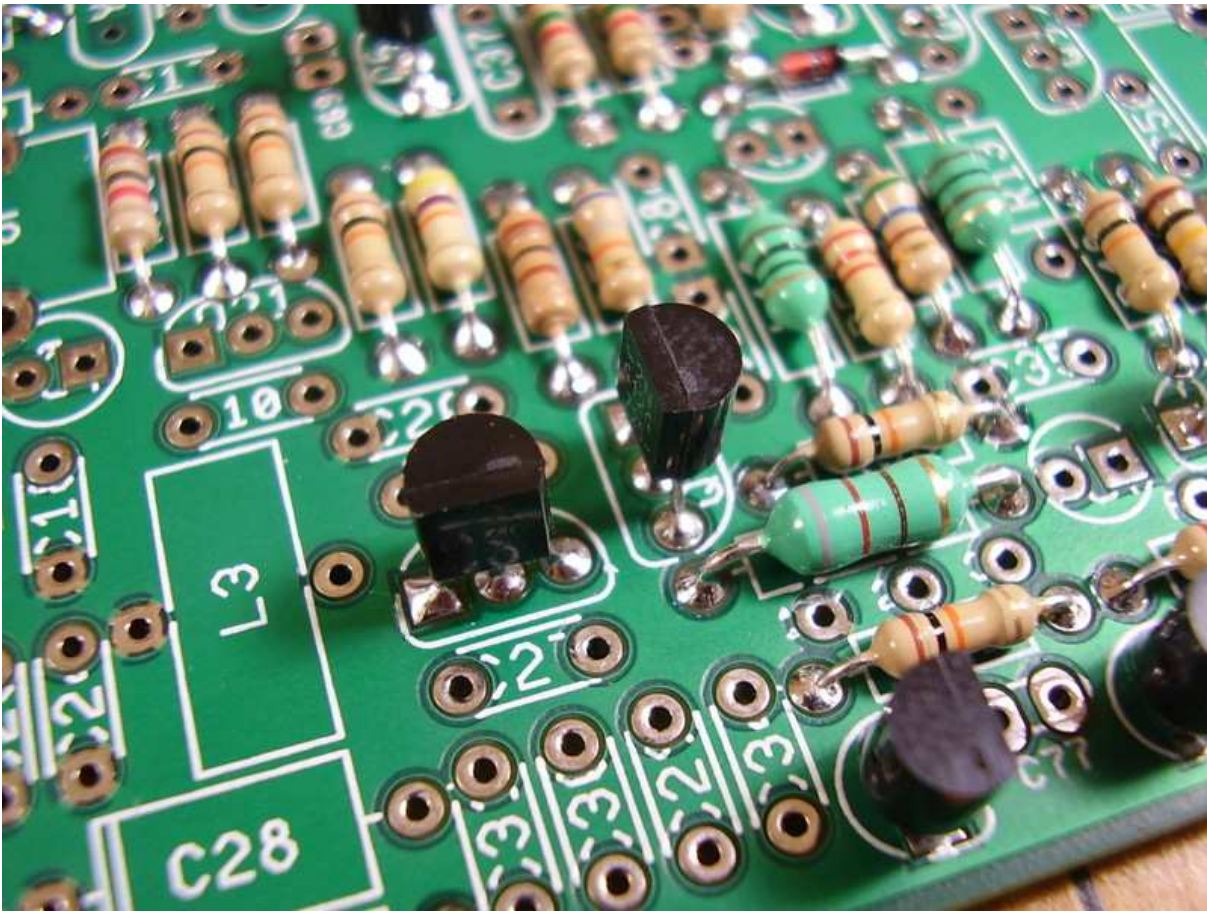

Figure 4.32: [2-31] Q18 2N4124 Transistor.

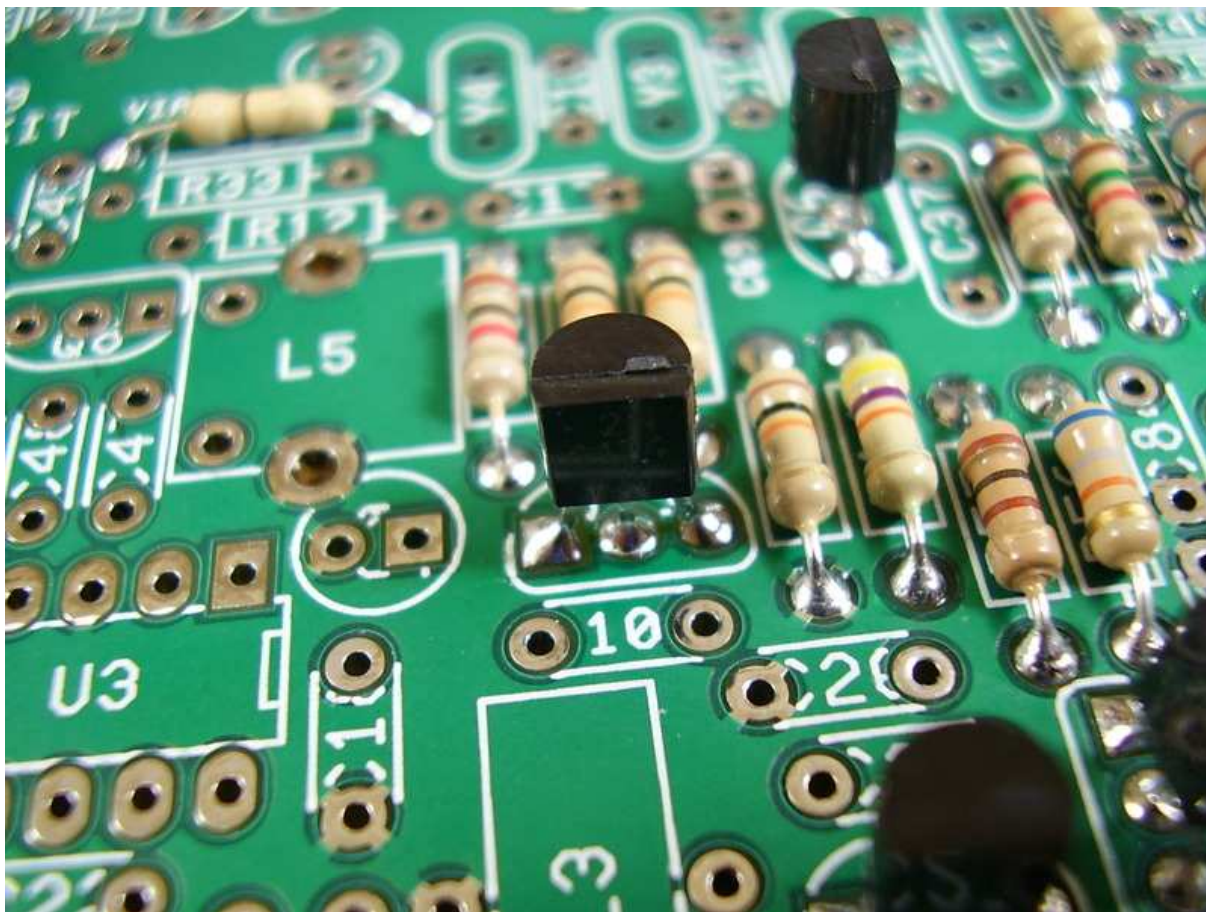

Figure 4.33: [2-32] Q21 2N4124 Transistor.

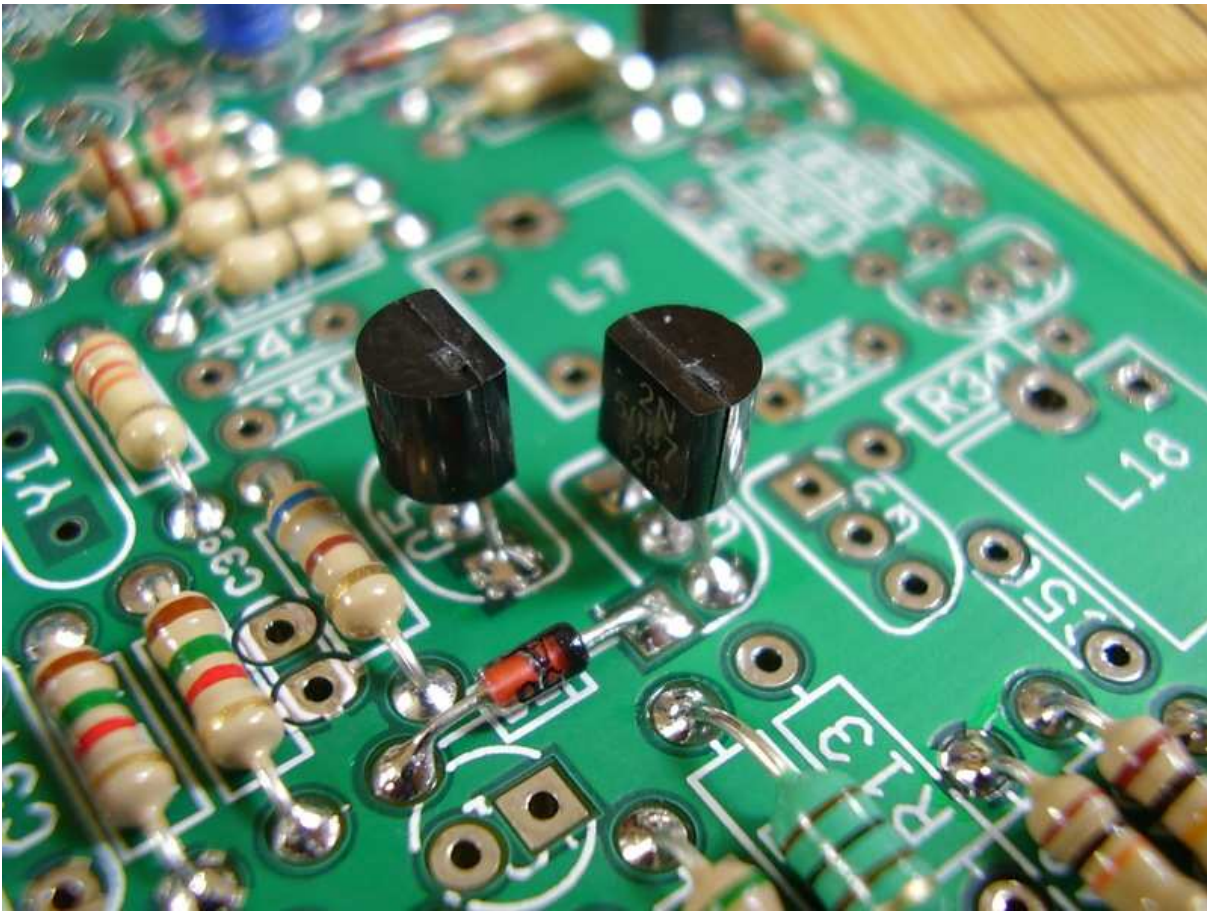

Figure 4.34: [2-33] Q4 2N5087 Transistor.

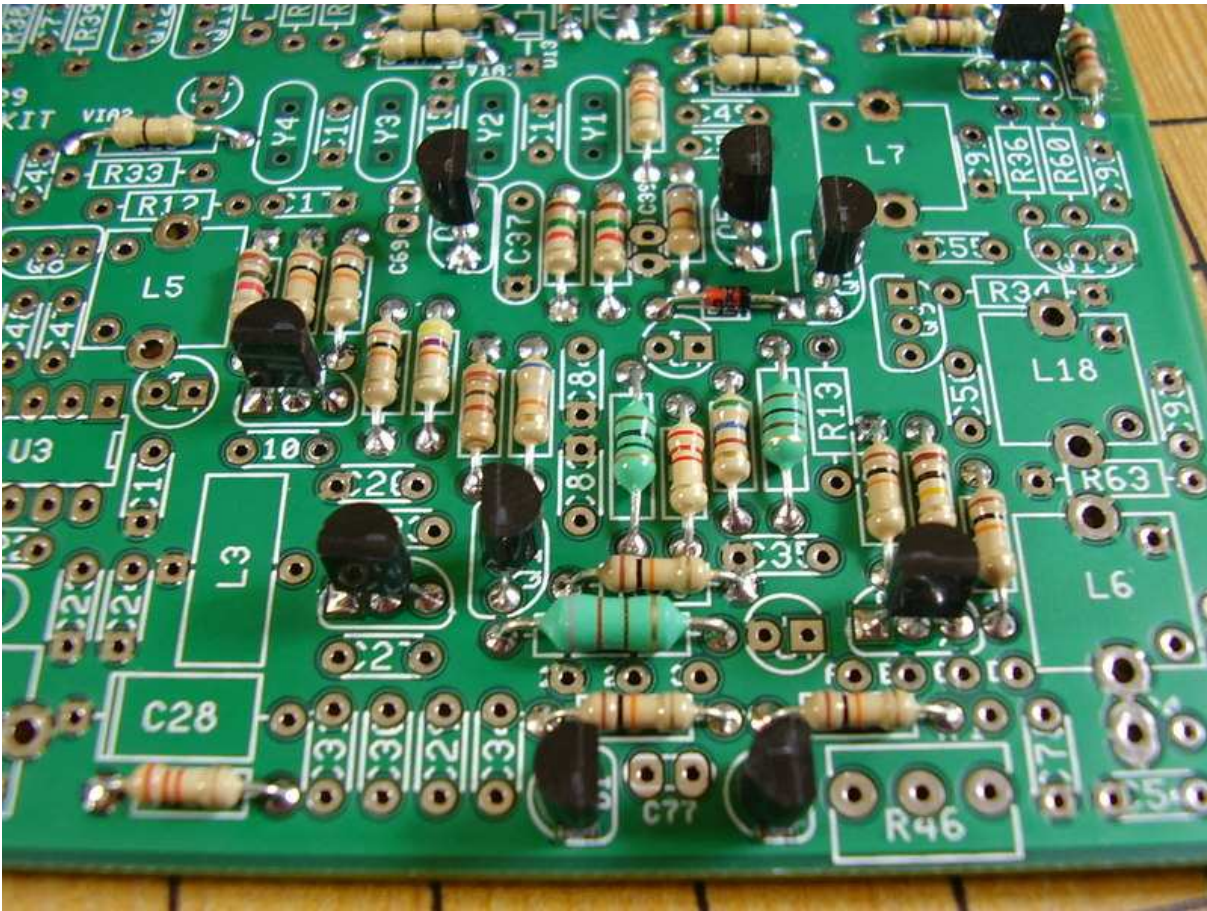

Figure 4.35: Area Photograph of Installed Components.

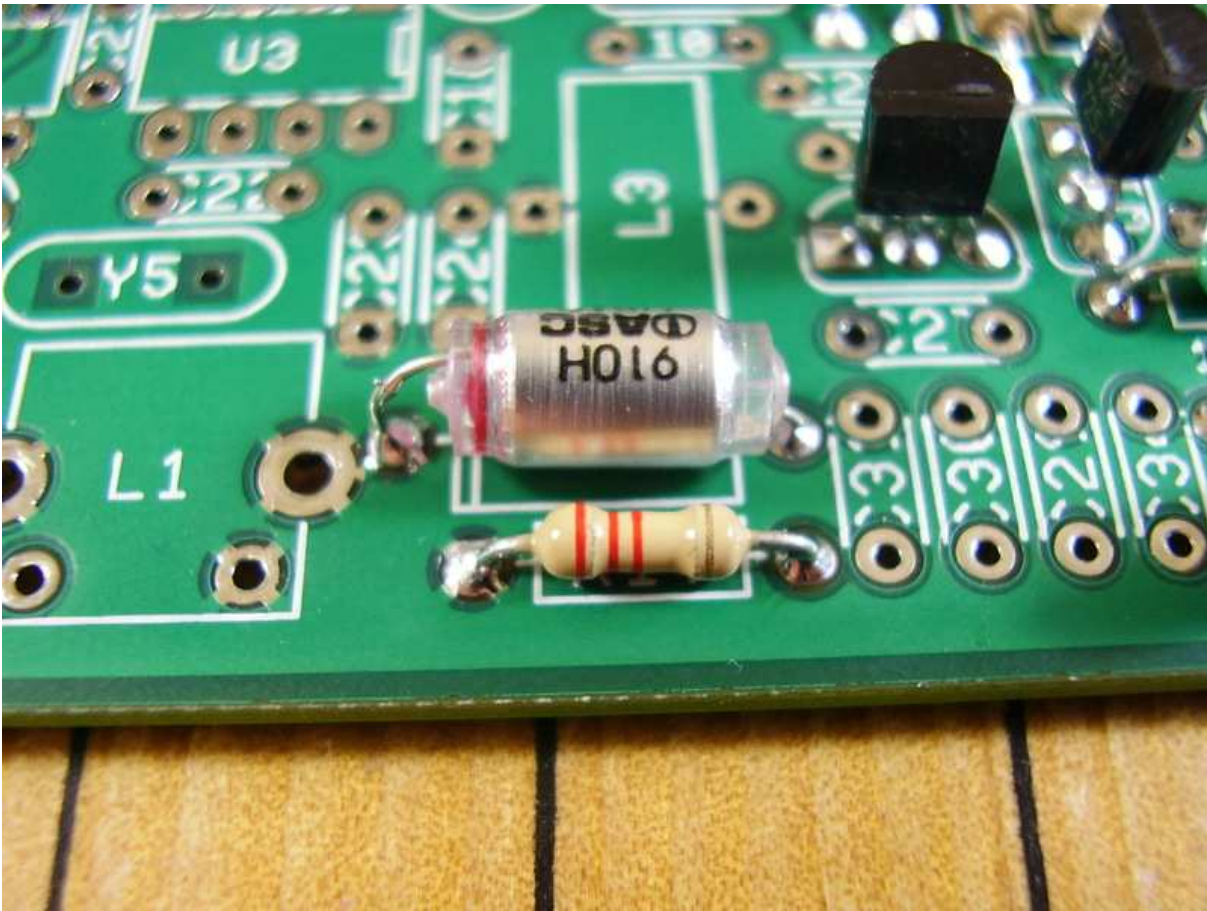

Figure 4.36: [2-34] C29 150pF Polystyrene Capacitor.



Figure 4.37: Photo of 150pF N80 Disc Caps.

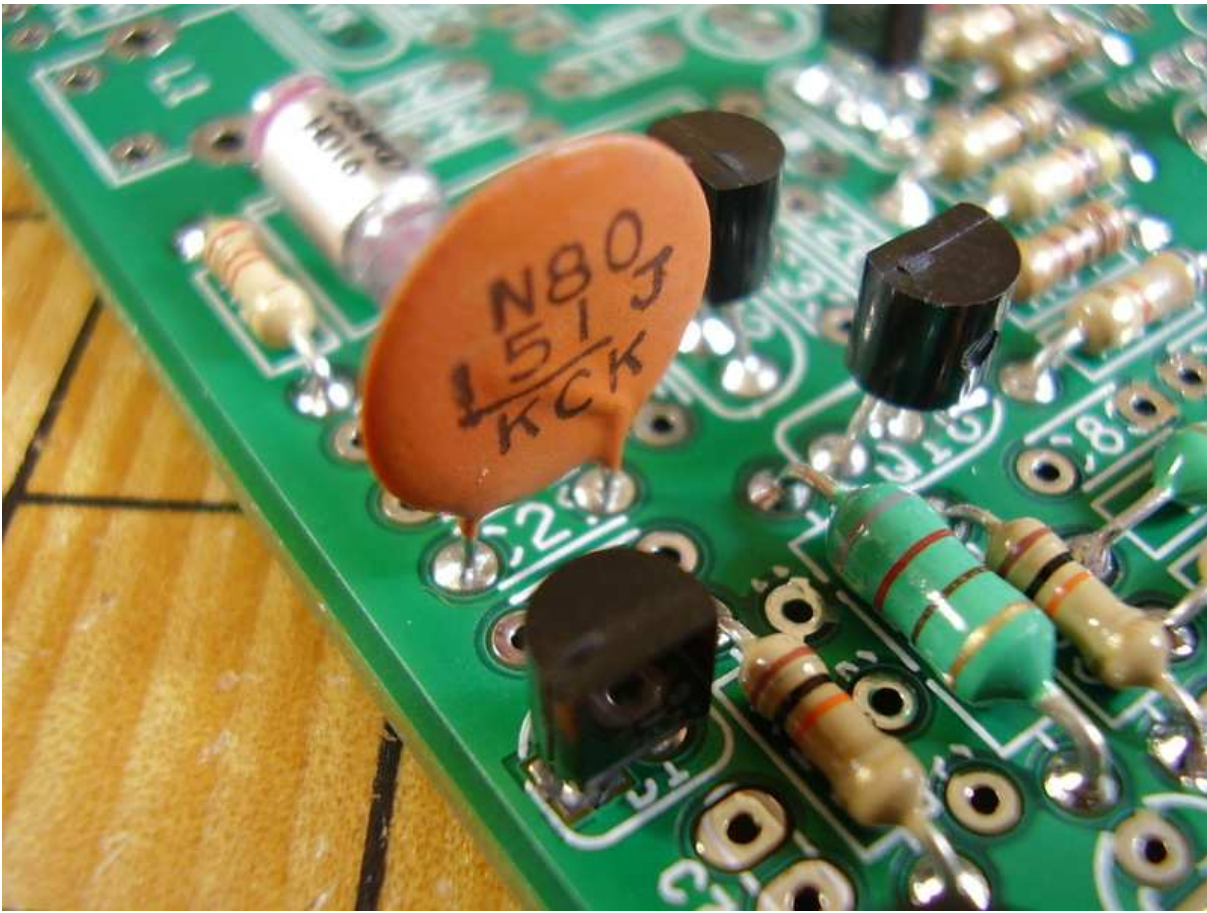

Figure 4.38: [2-35] C29 150pF N80 Disc Cap.

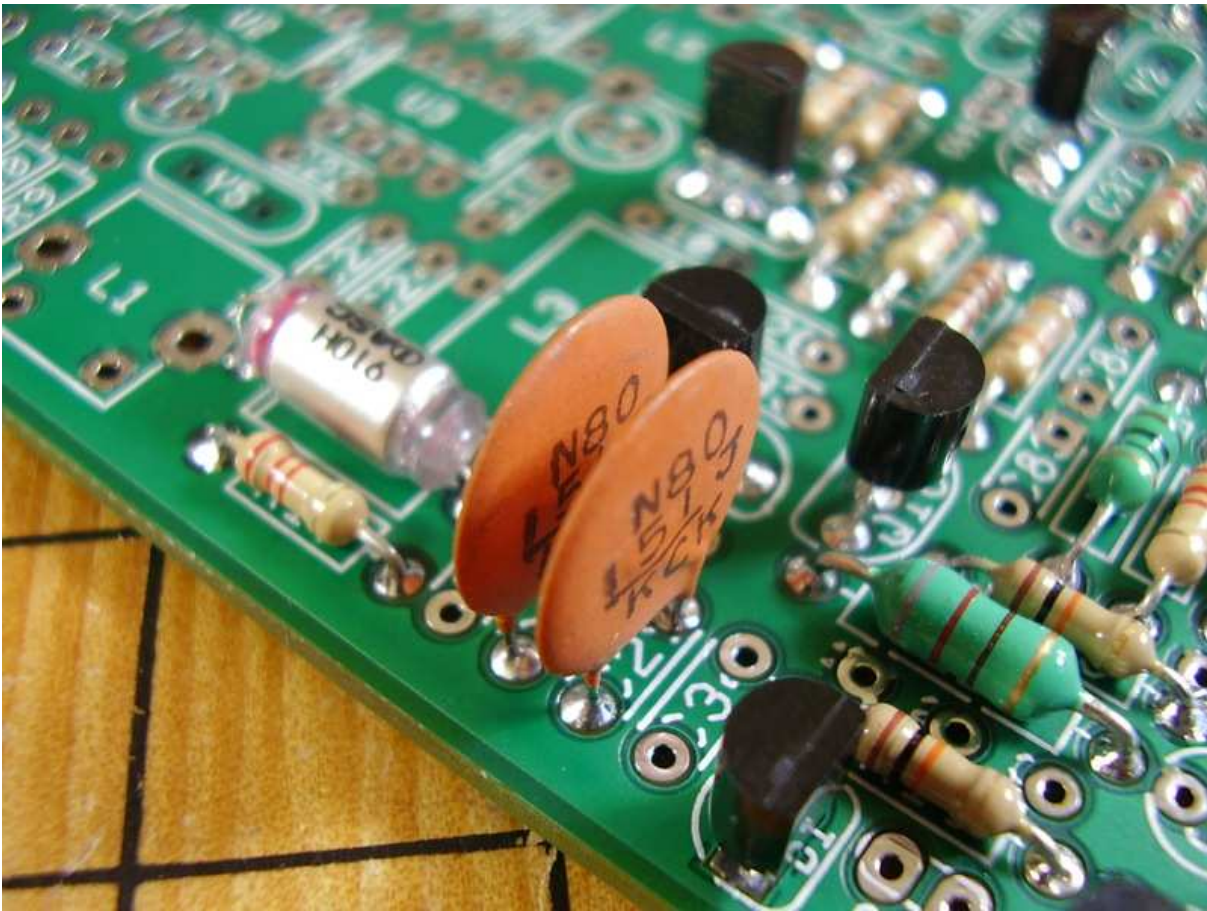

Figure 4.39: [2-36] C30 150pF N80 Disc Cap.

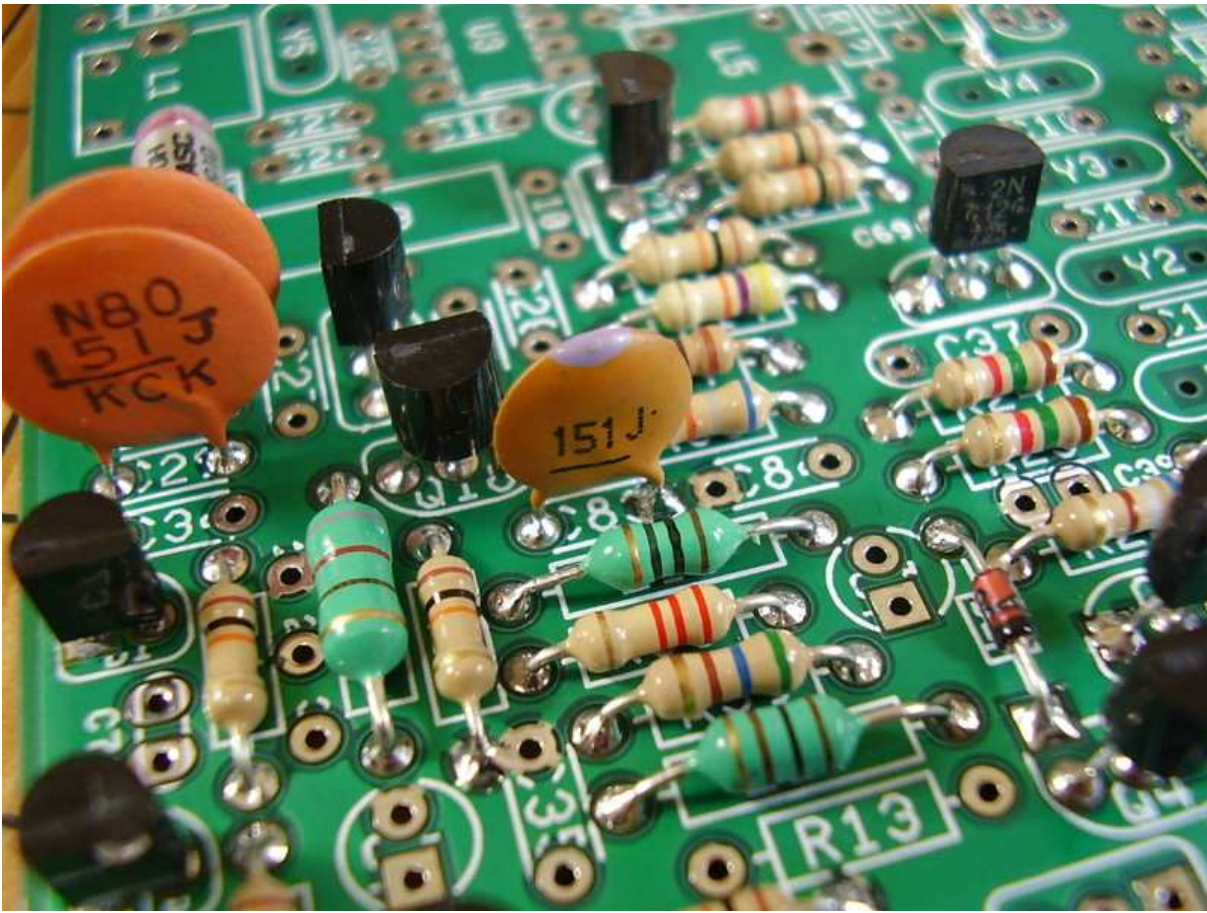

Figure 4.40: [2-37] C83 150pF NPO Disc Cap.

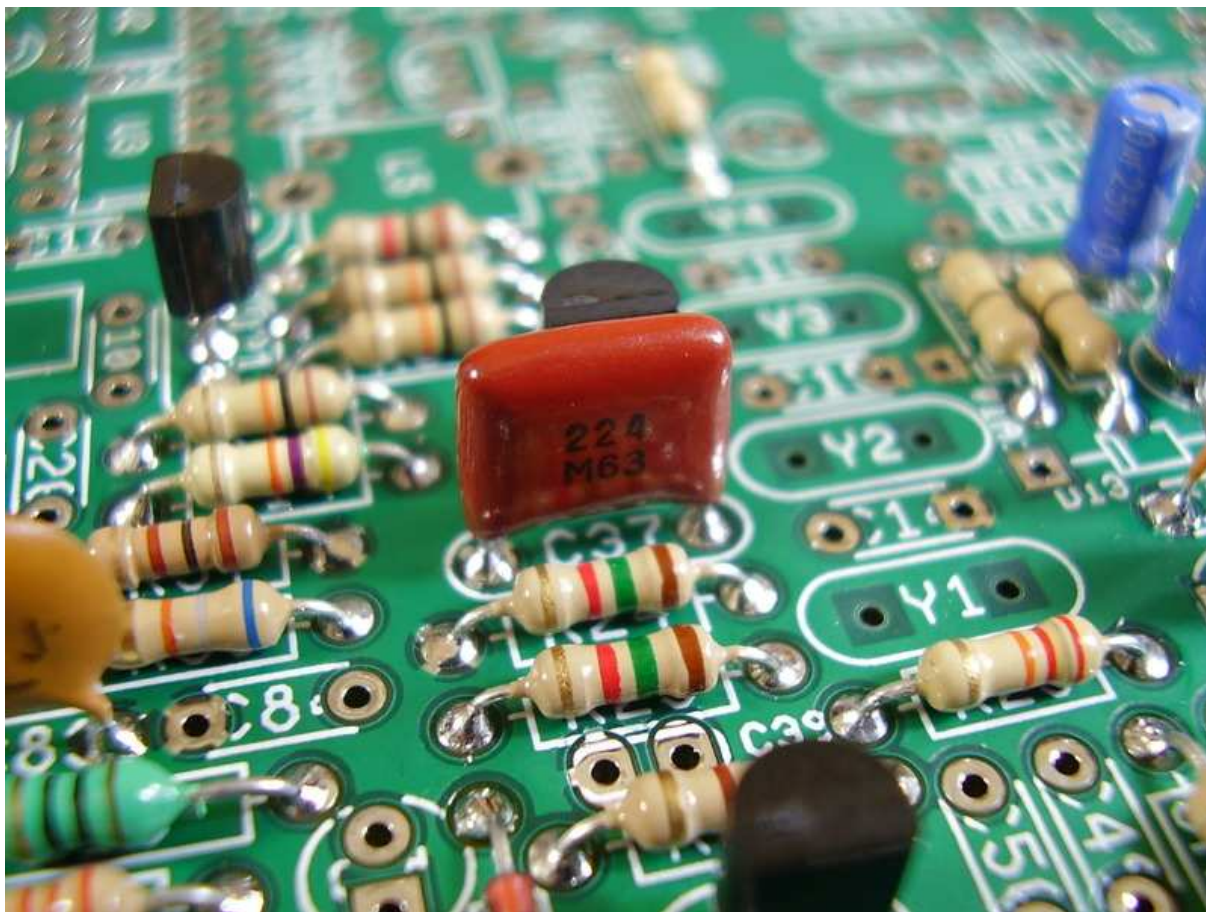

Figure 4.41: [2-38] C37 $.22\mu\text{F}$ Mylar Cap.

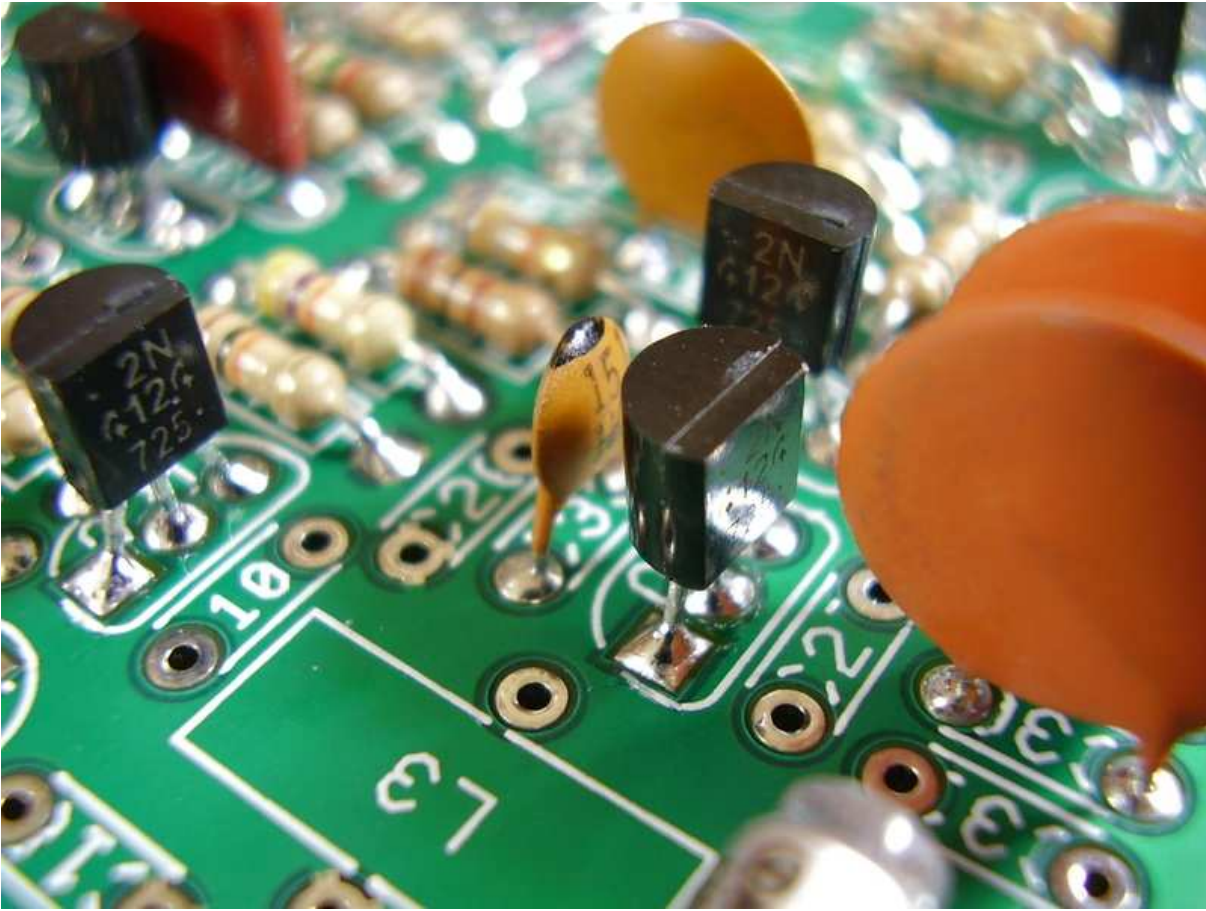

Figure 4.42: [2-39] C33 15pF.

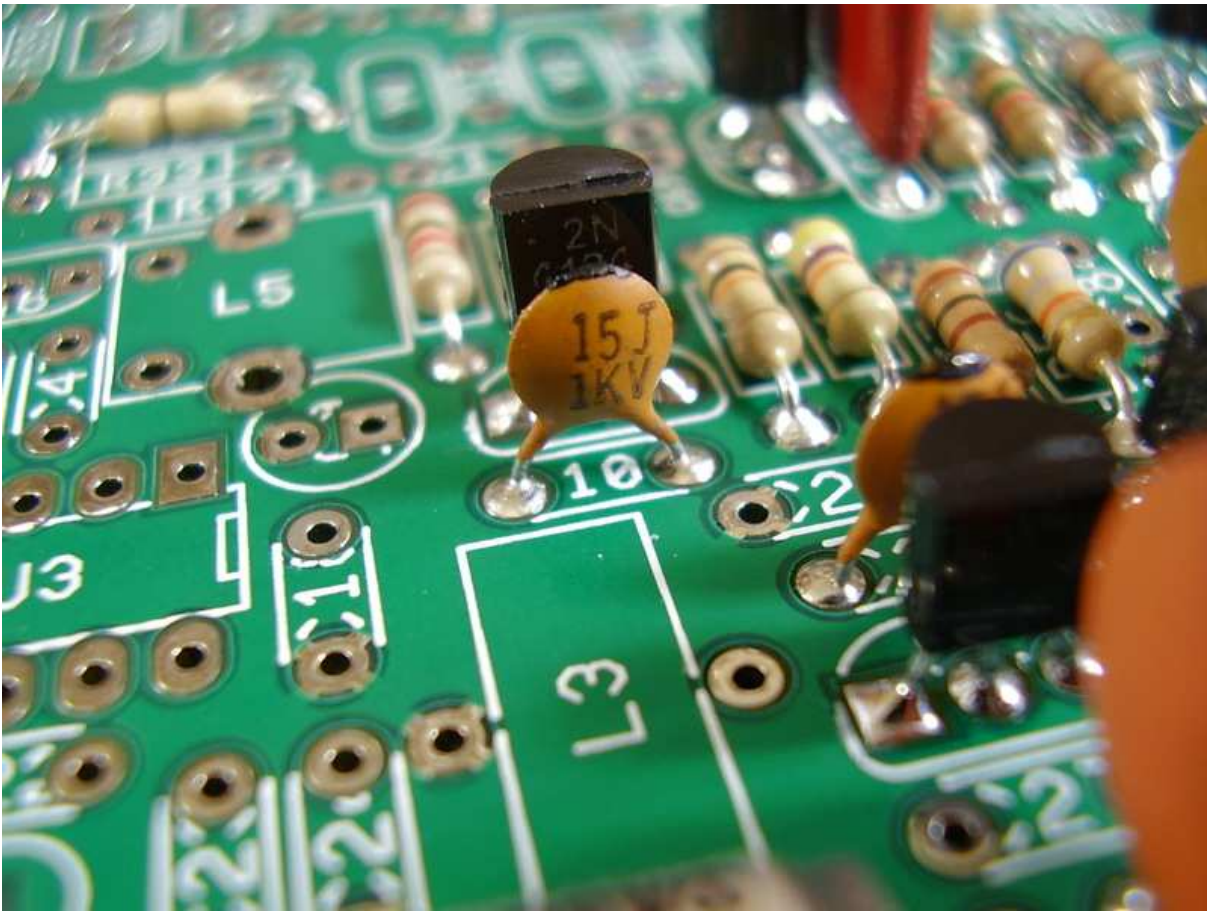

Figure 4.43: [2-40] C101 15pF.

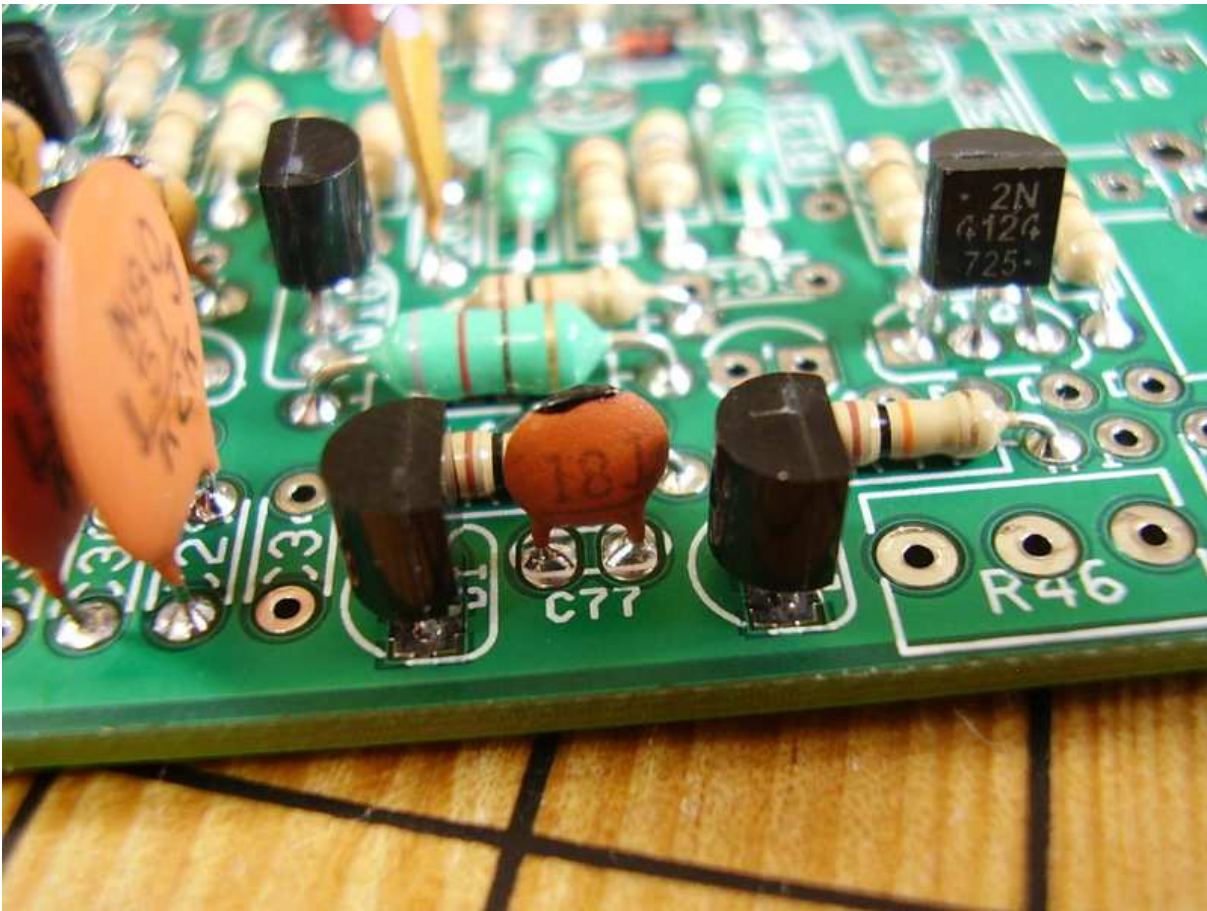

Figure 4.44: [2-41] C77 18pF.

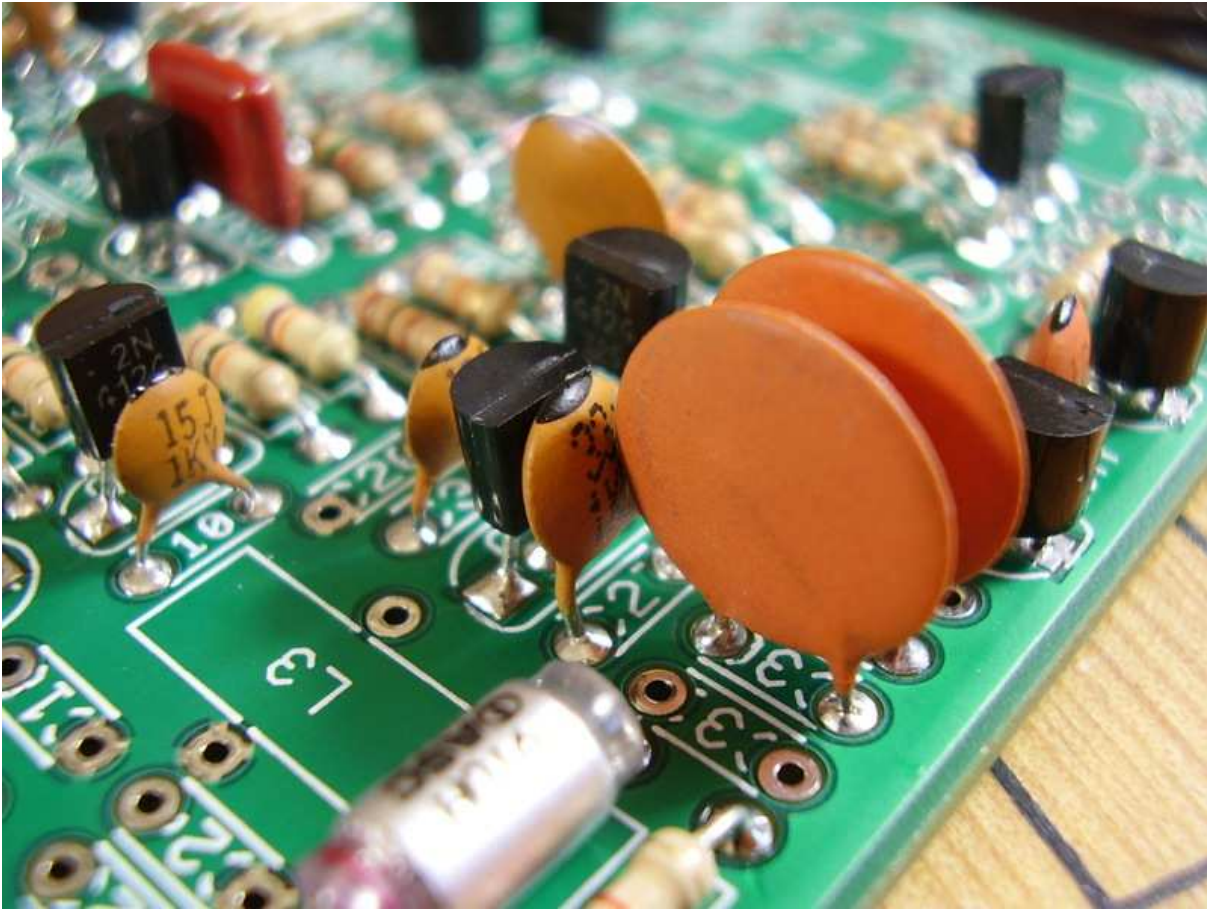

Figure 4.45: [2-42] C27 33pF.

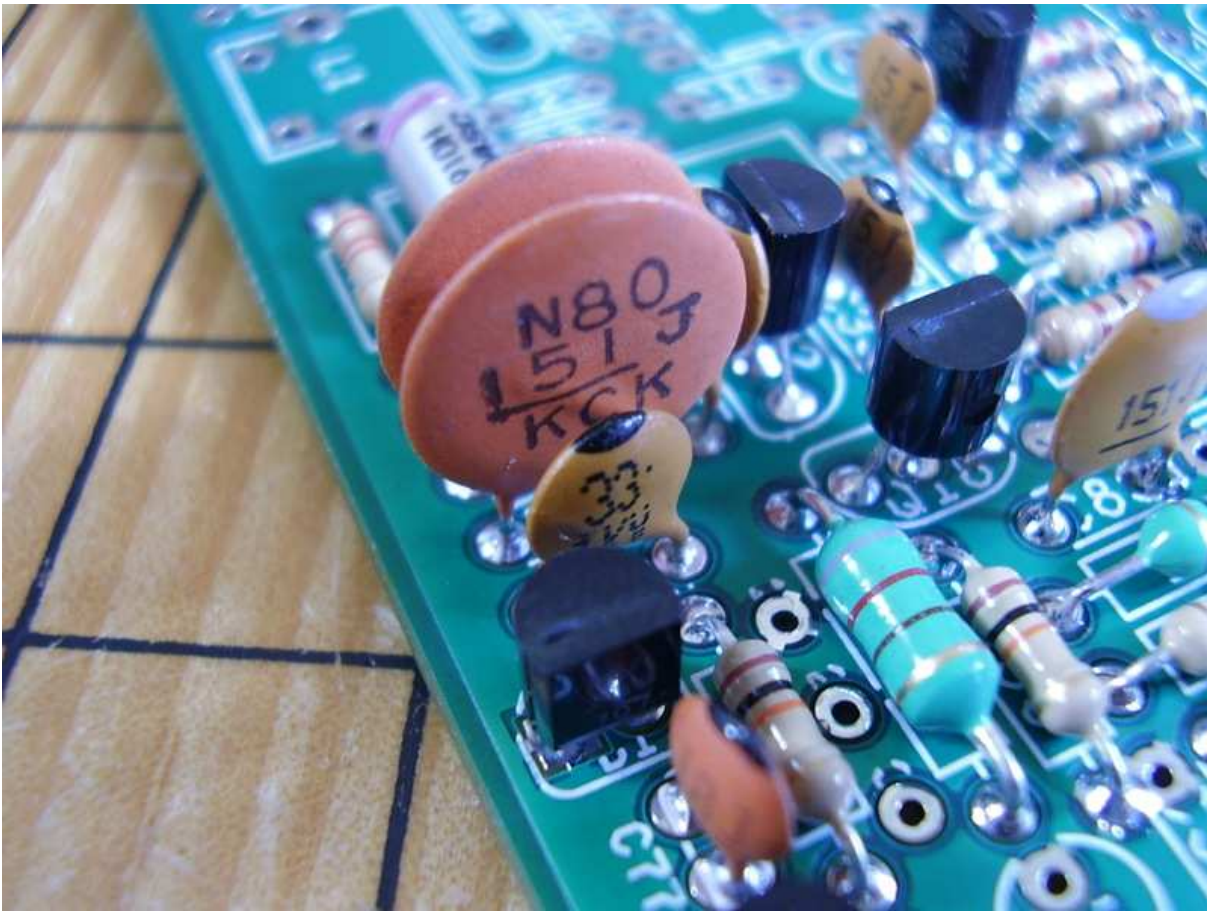

Figure 4.46: [2-43] C34 33pF.

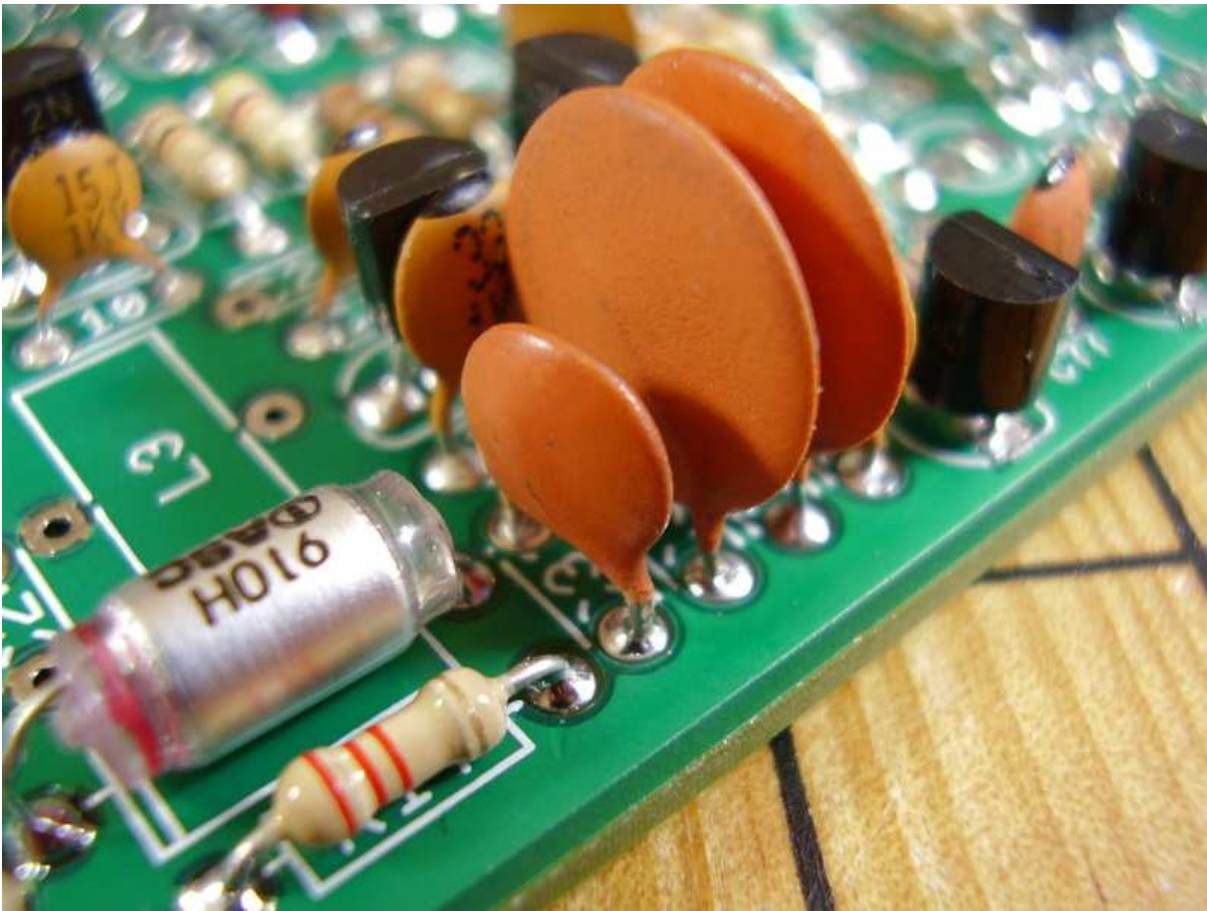

Figure 4.47: [2-44] C31 39pF.

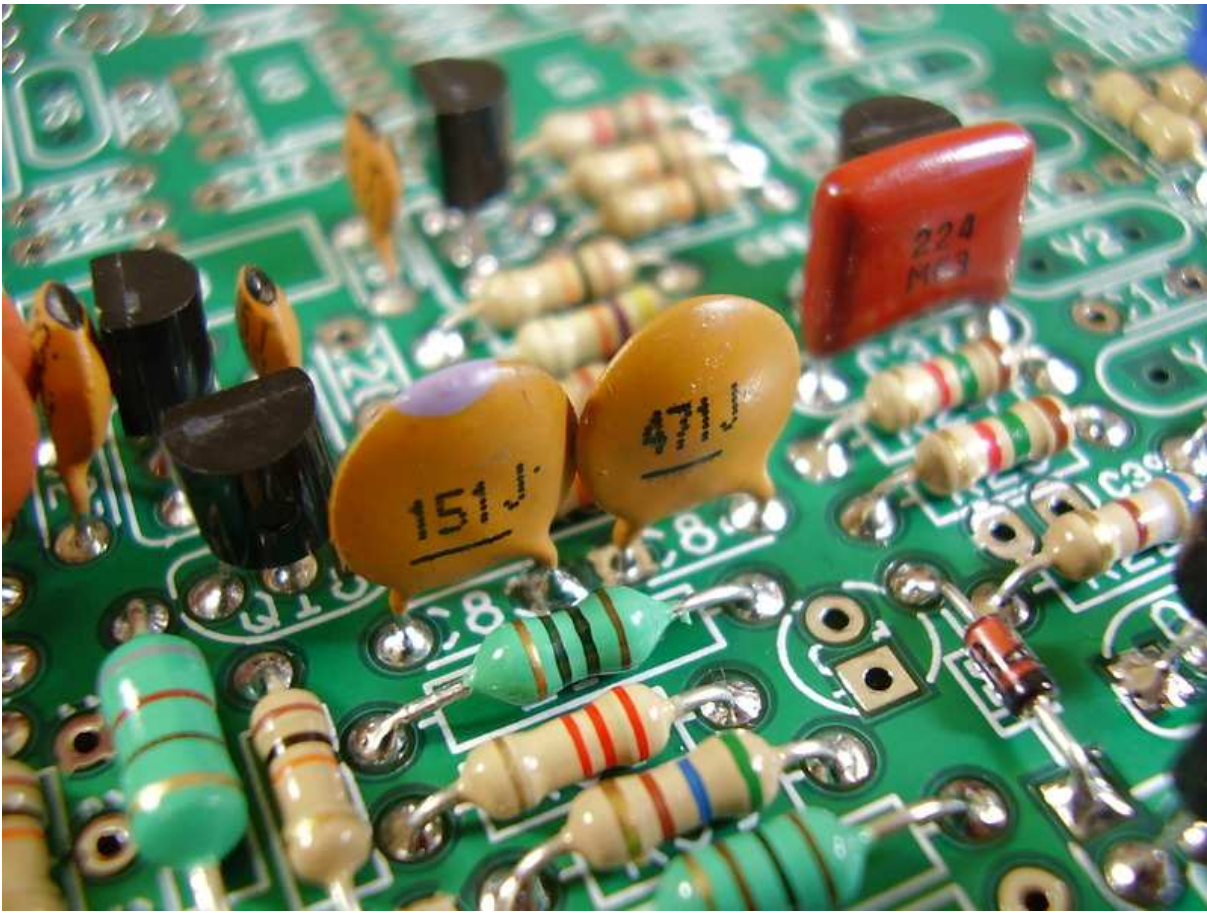

Figure 4.48: [2-45] C84 470pF.

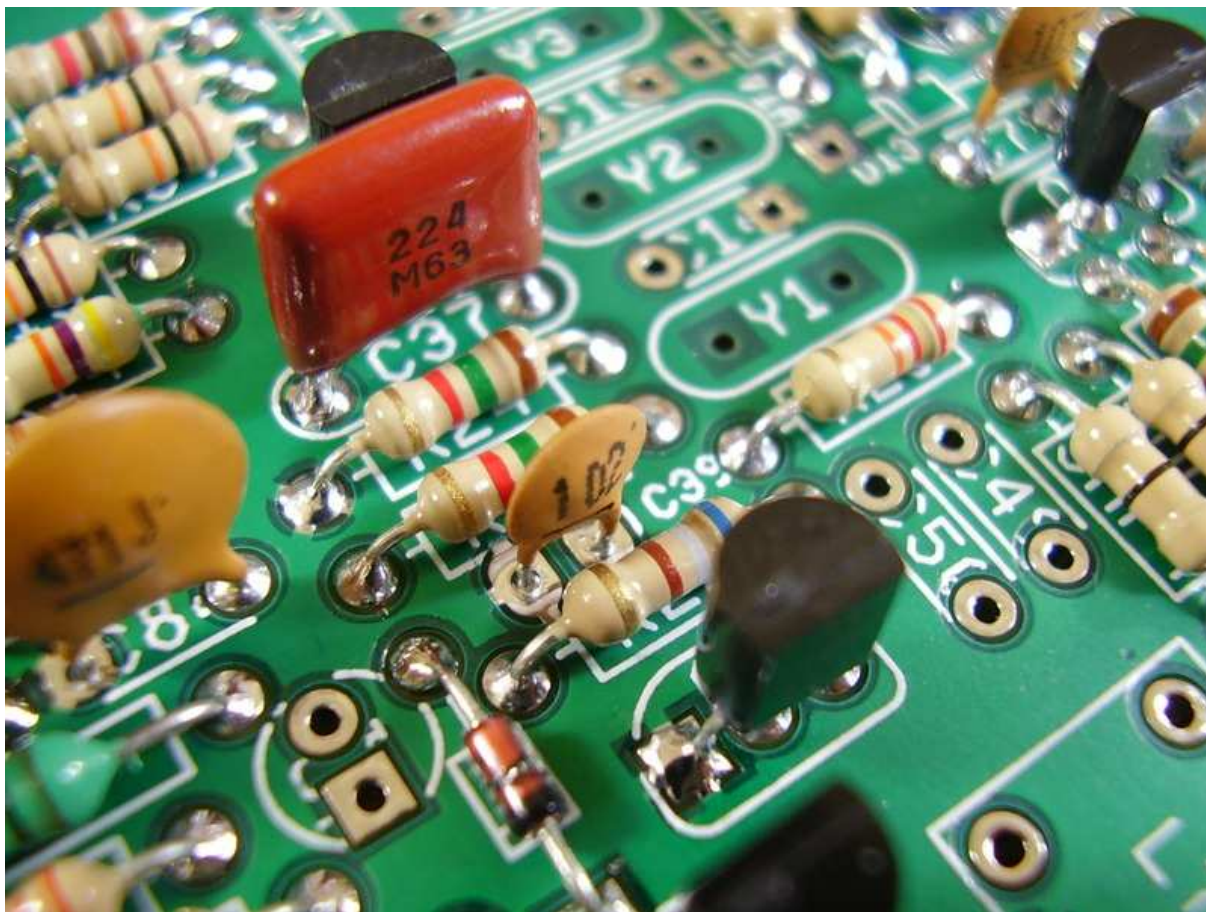

Figure 4.49: [2-46] C39 $.001\mu\text{F}$.

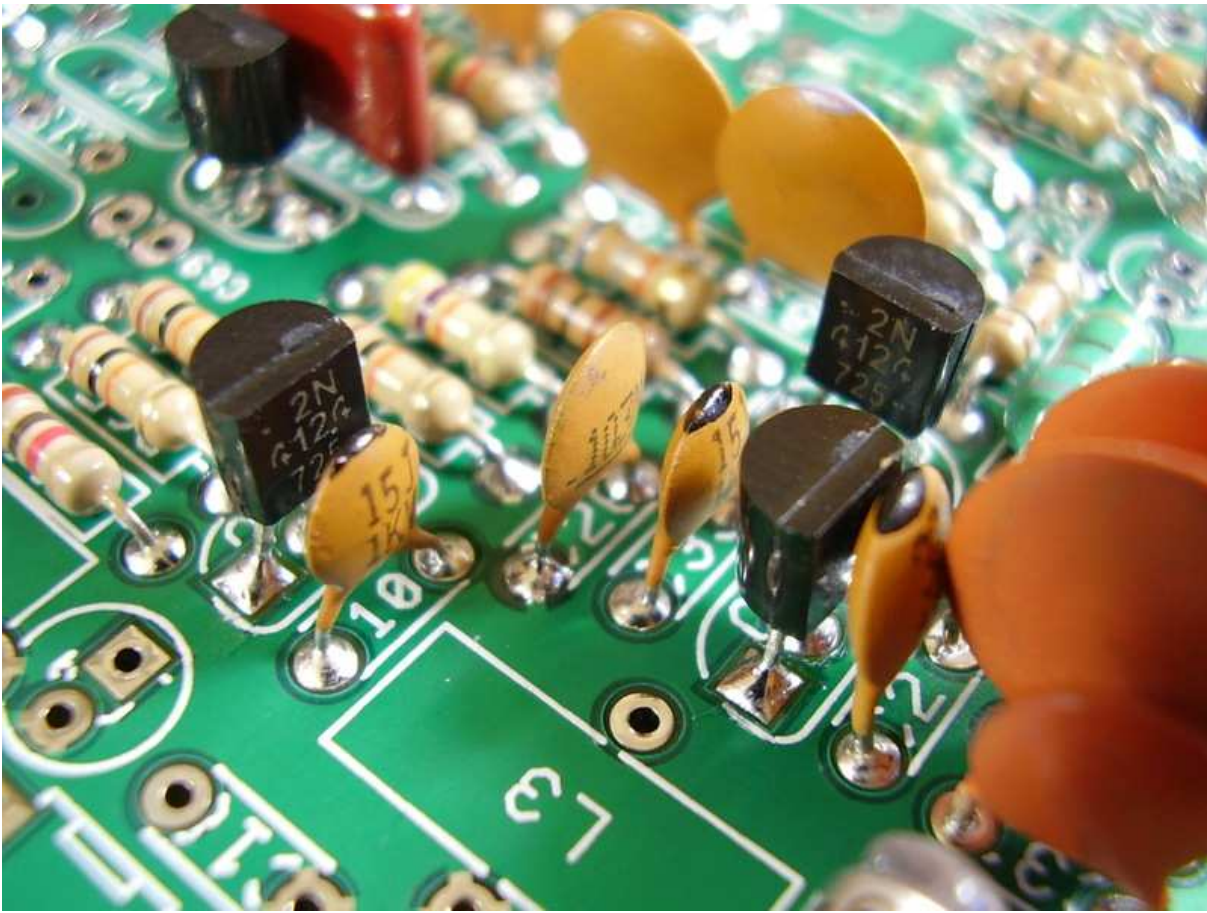

Figure 4.50: [2-47] C26 $.01\mu\text{F}$.

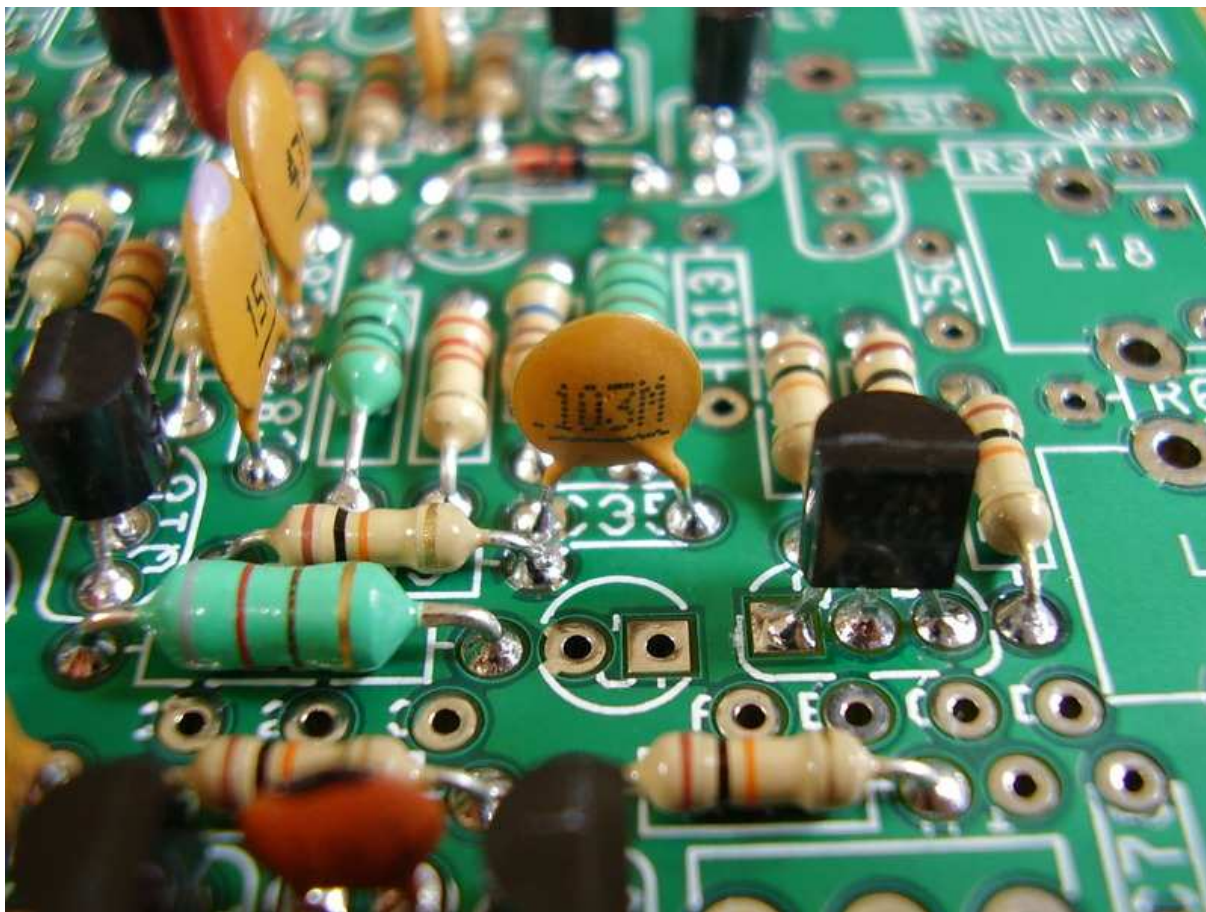

Figure 4.51: [2-48] C35 $.04\mu\text{F}$.

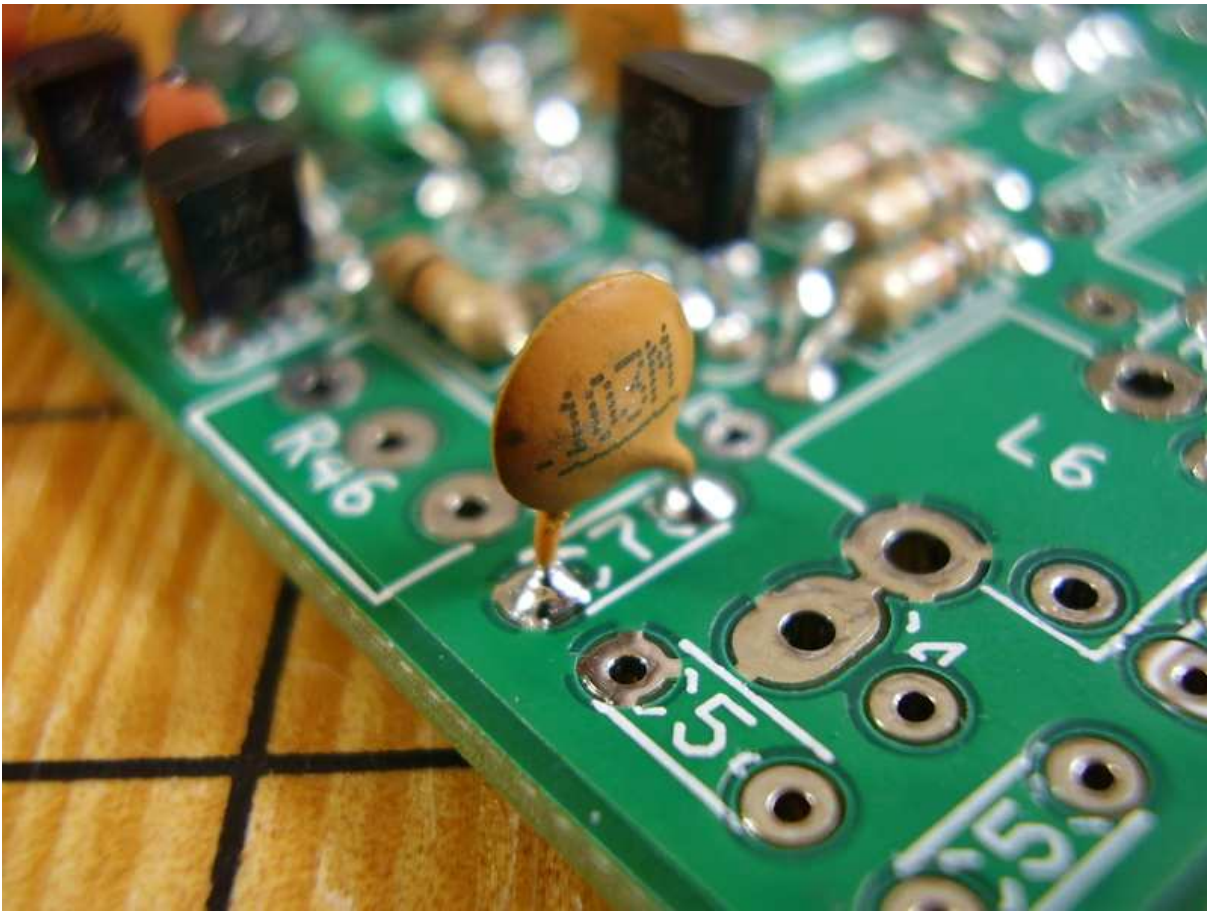

Figure 4.52: [2-49] C78 $.01\mu\text{F}$.

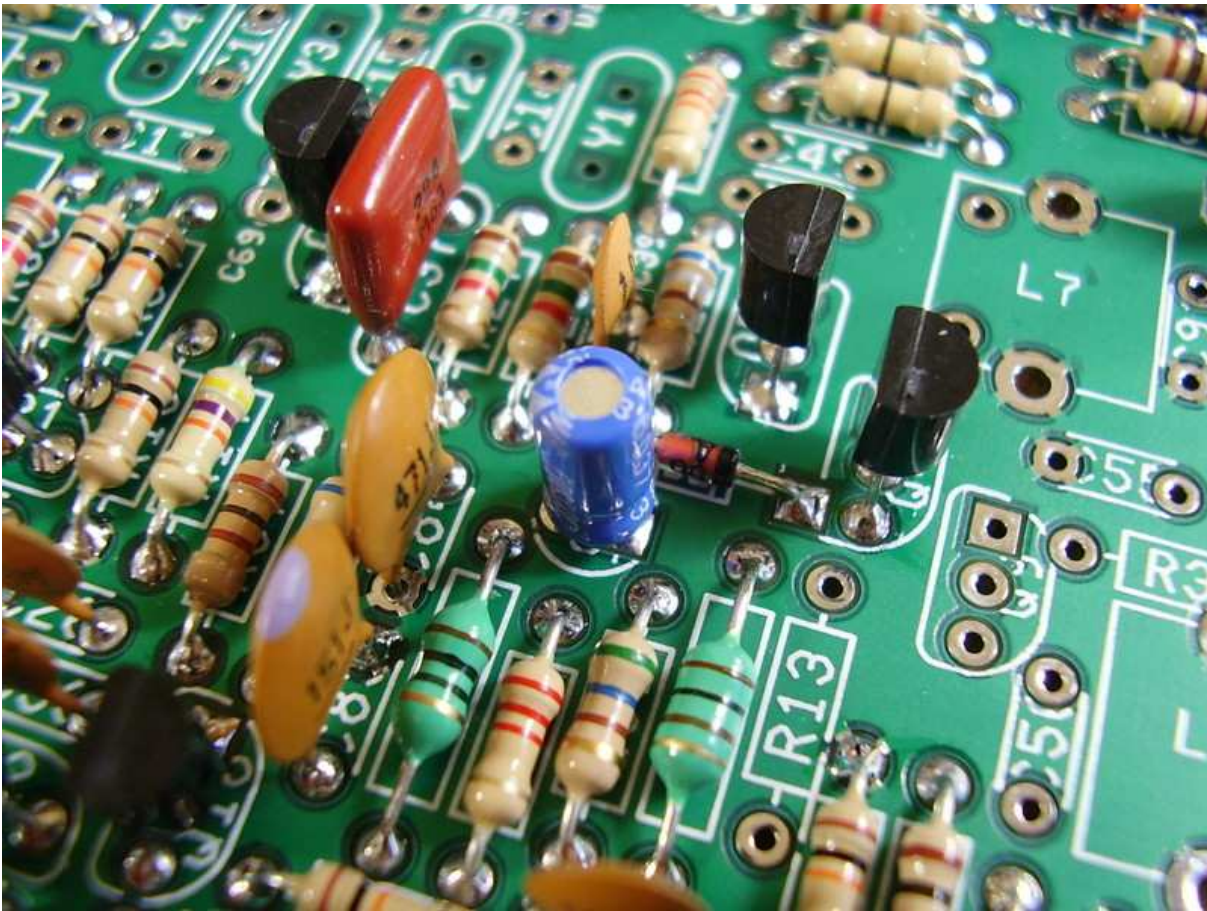

Figure 4.53: [2-50] C38 10 μ F.

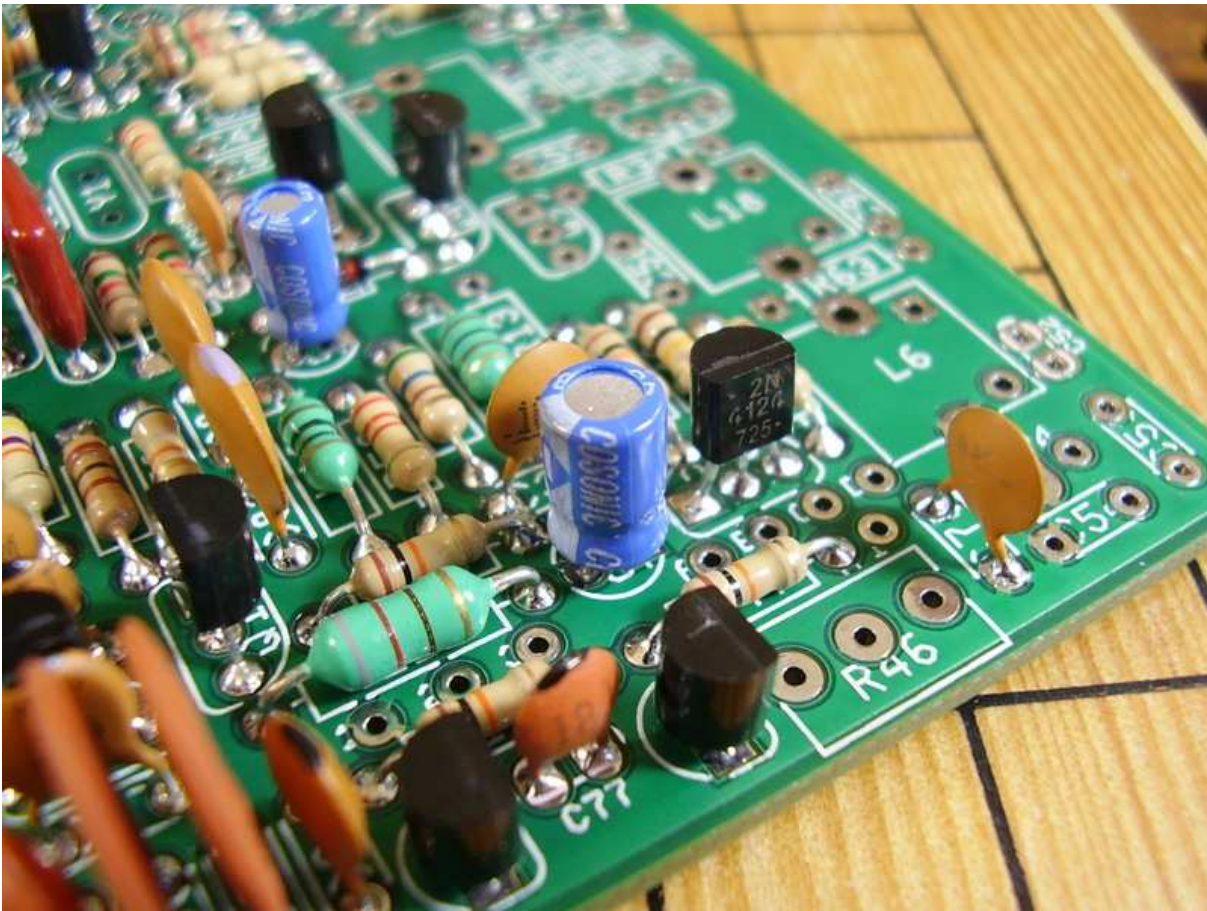

Figure 4.54: [2-51] C36 33 μ F.

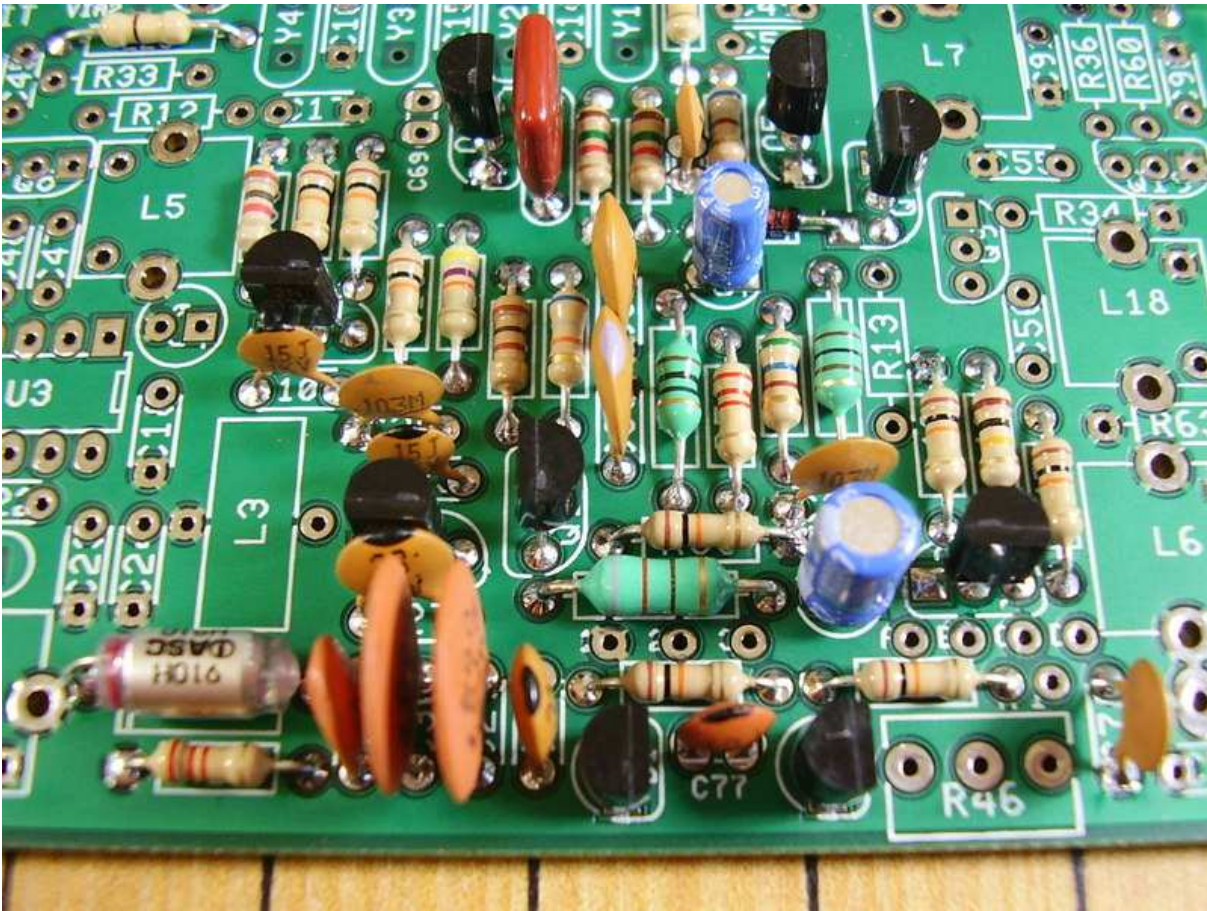

Figure 4.55: Overall View Photograph.



Figure 4.56: Overall View Photograph.

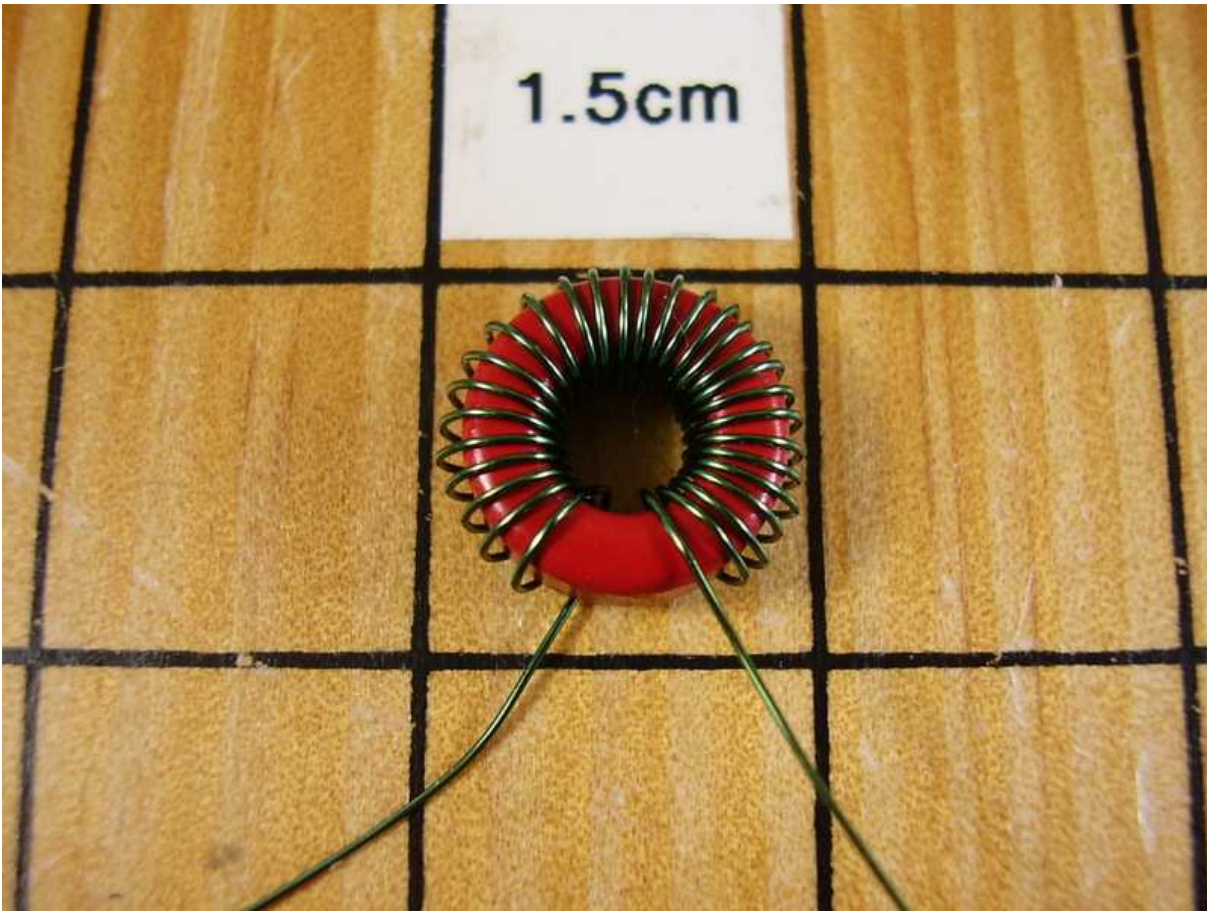

Figure 4.57: L3 Toroid Winding.

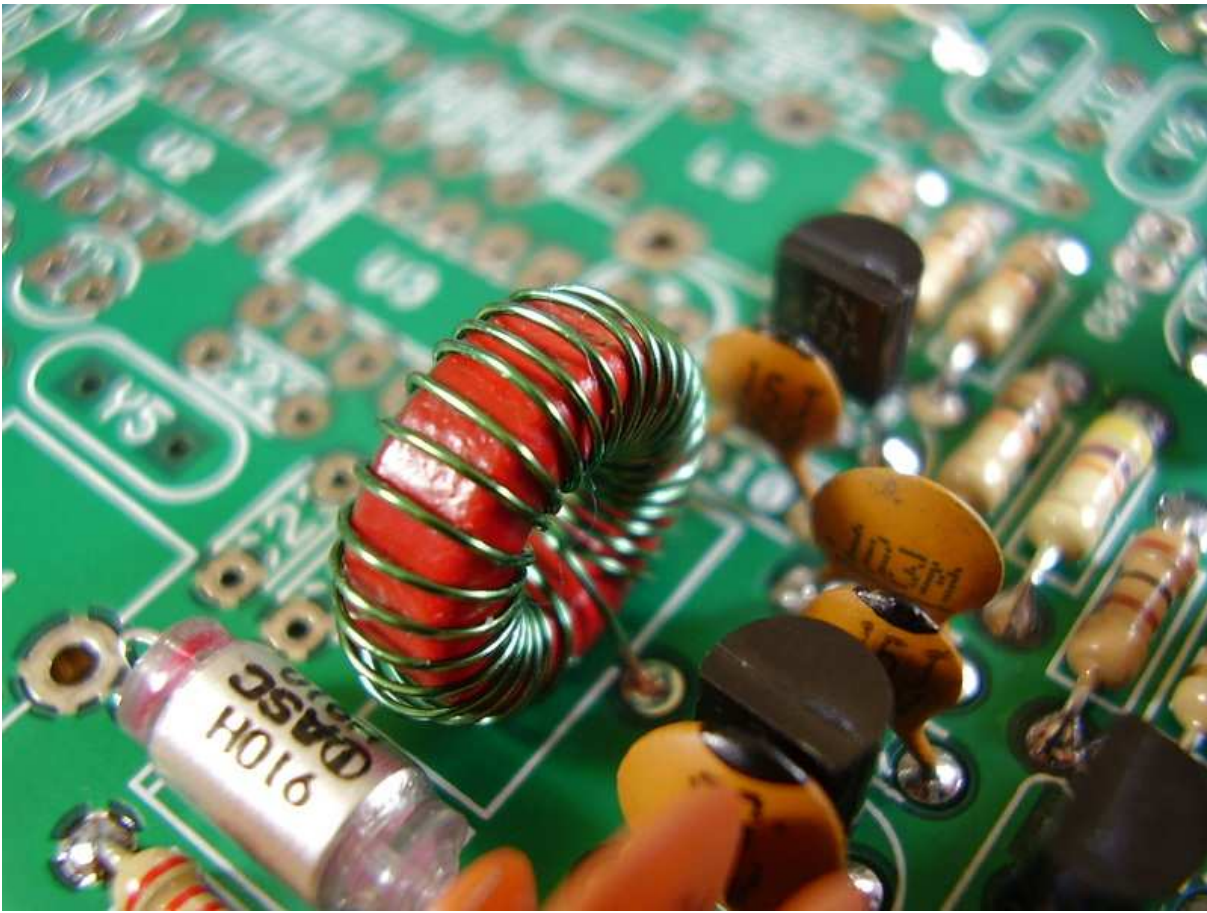

Figure 4.58: L3 in place after tests.

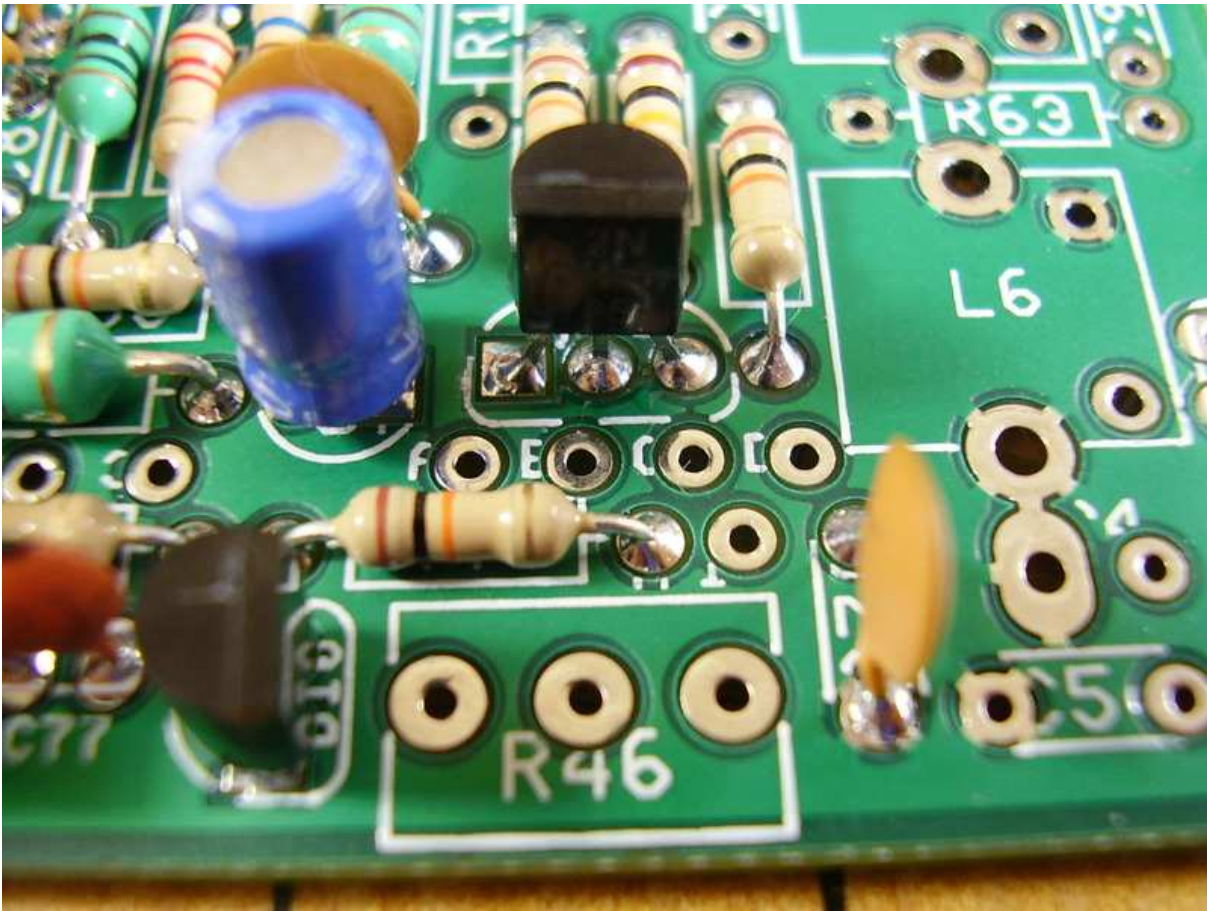

Figure 4.59: [2-57] [2-58] Wiring Jumpers.

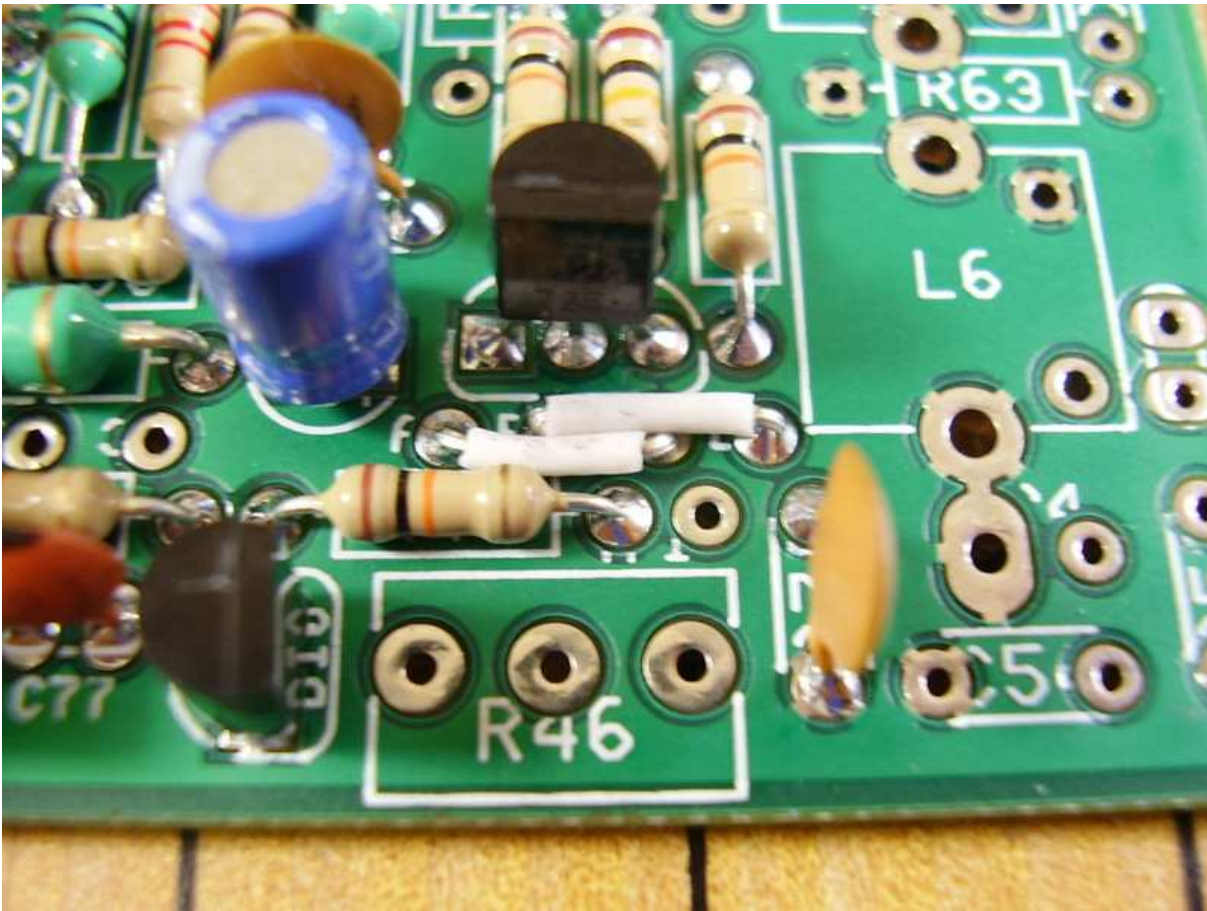

Figure 4.60: [2-57] [2-58] Wiring Jumpers.

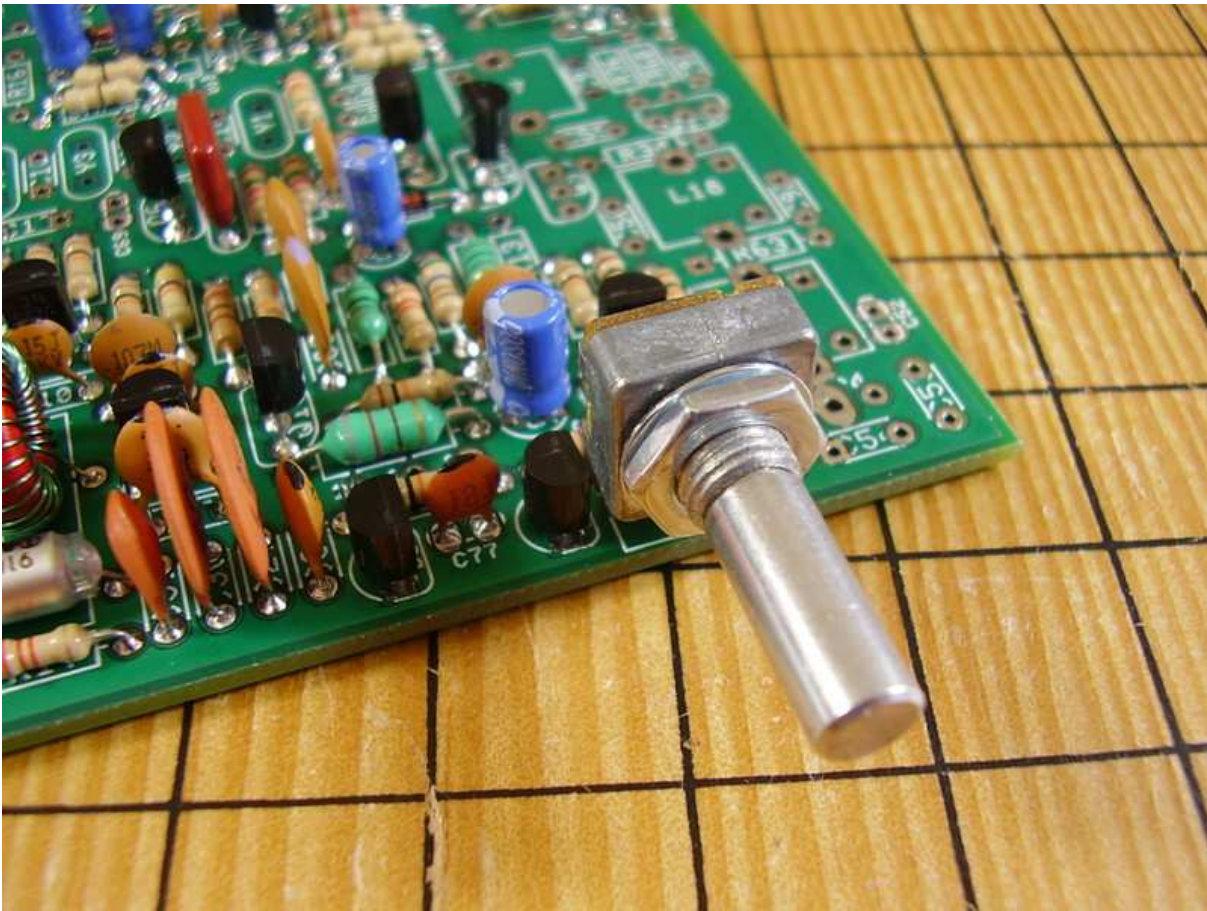

Figure 4.61: [2-60] R46 10K Potentiometer.

Chapter 5

Phase 3.0 - Transmit Mixer and 10.1MHz Filter Circuits

In phase 3.0 we will build the transmit mixer and the 10.1MHz filter. The transmit mixer takes the VFO frequency and the crystal frequency and generates a difference that yields the operating frequency that we will be transmitting on during communications with the rig.

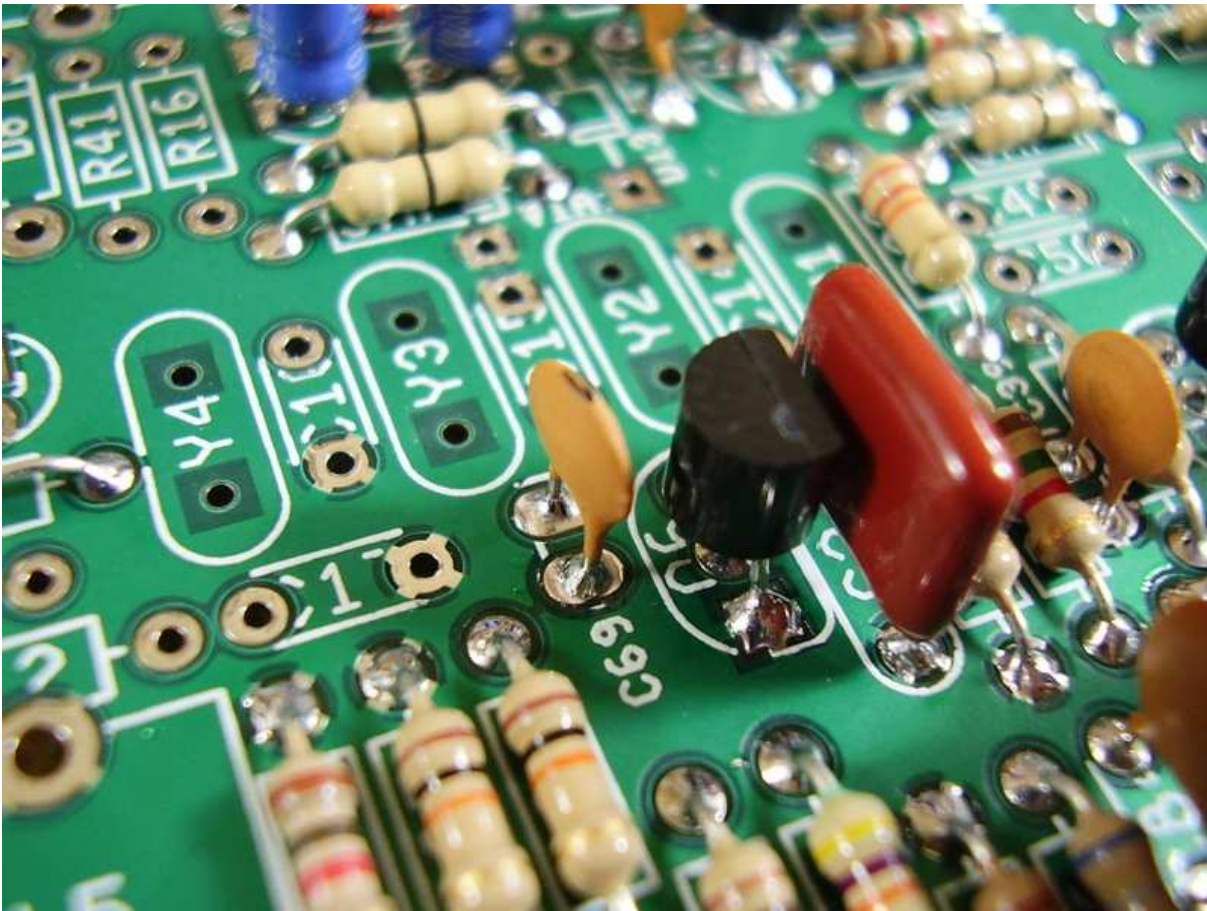

Figure 5.1: [3-2] C69 5pF.

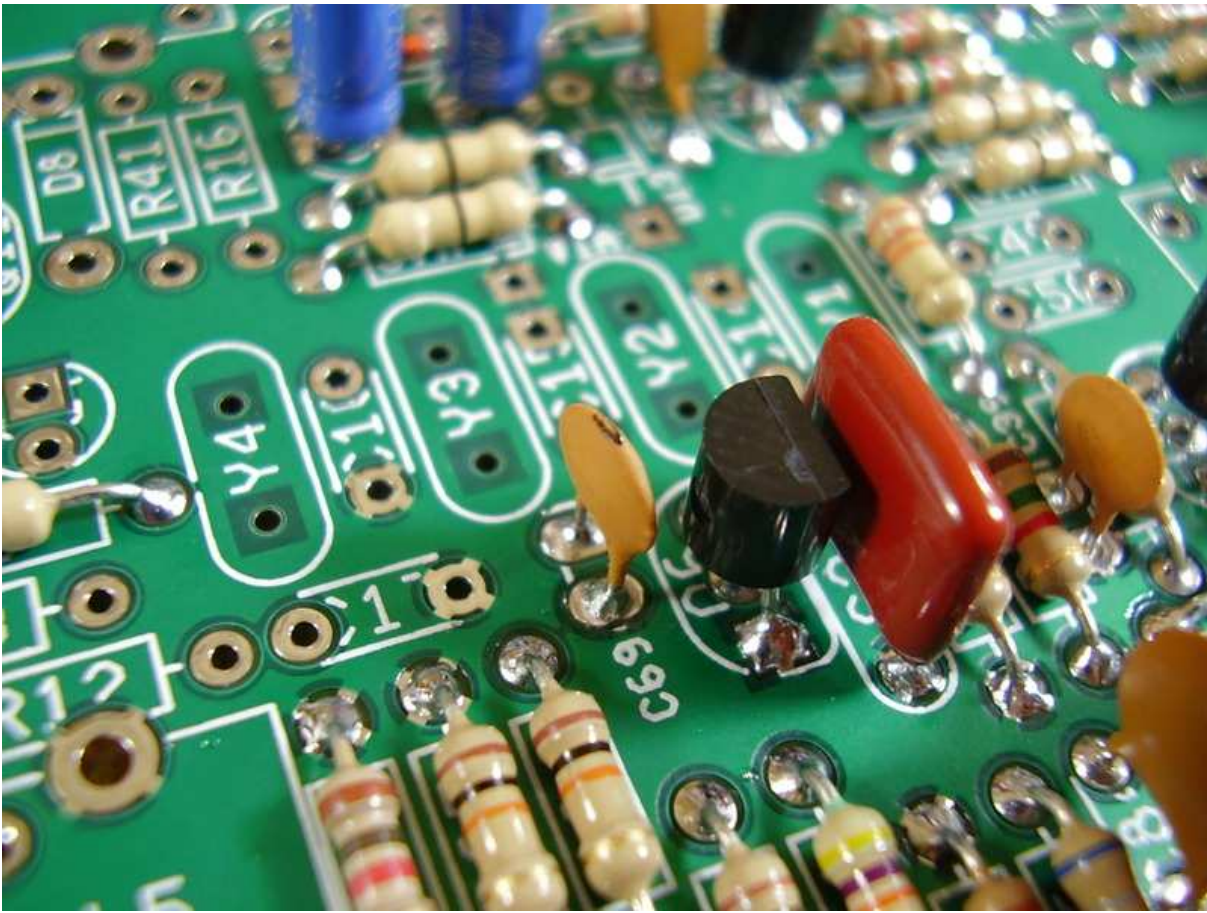

Figure 5.2: [3-2] C69 5pF.

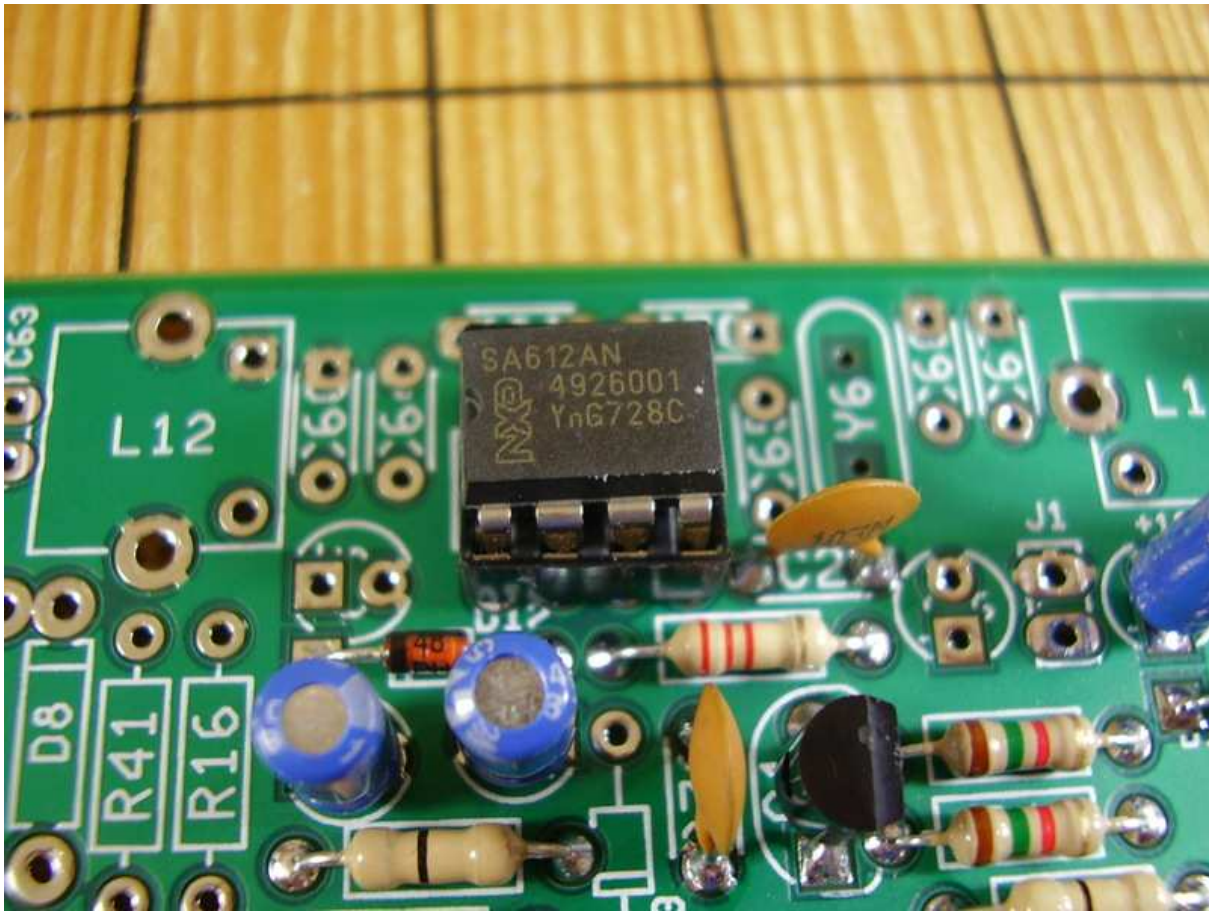

Figure 5.3: [3-1] U4 NE612 IC.

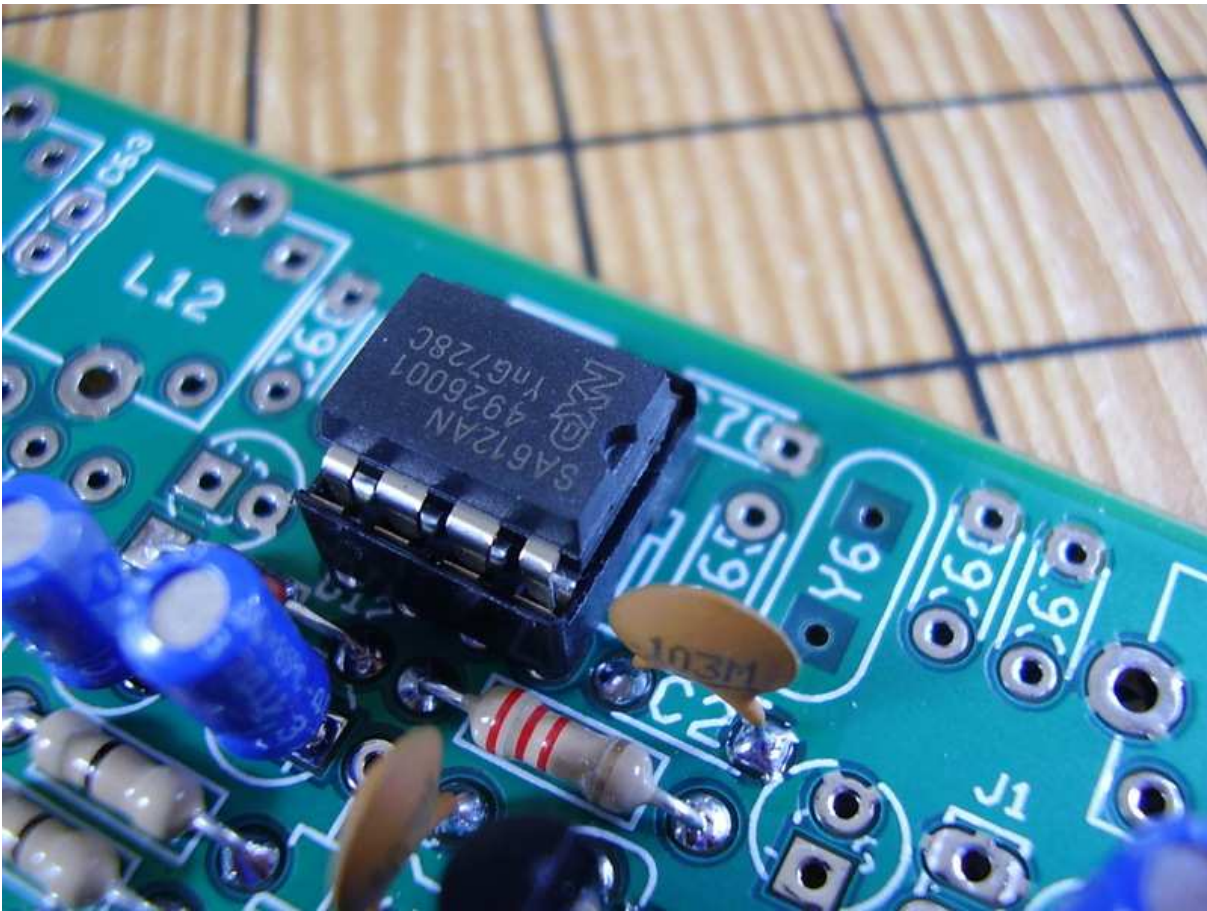

Figure 5.4: [3-1] U4 NE612 IC.

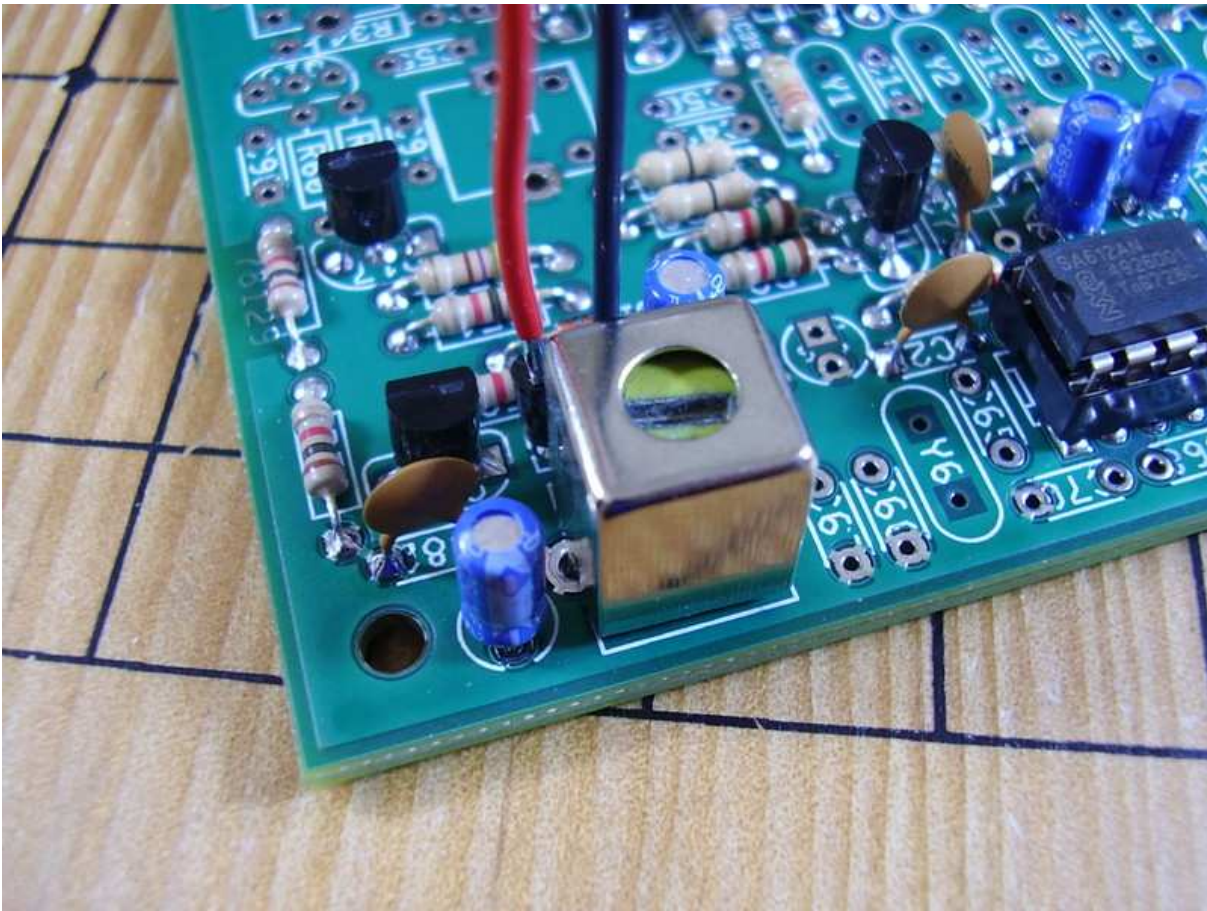

Figure 5.5: [3-3] L14 $1.3\mu\text{H}$ Shielded Coil.

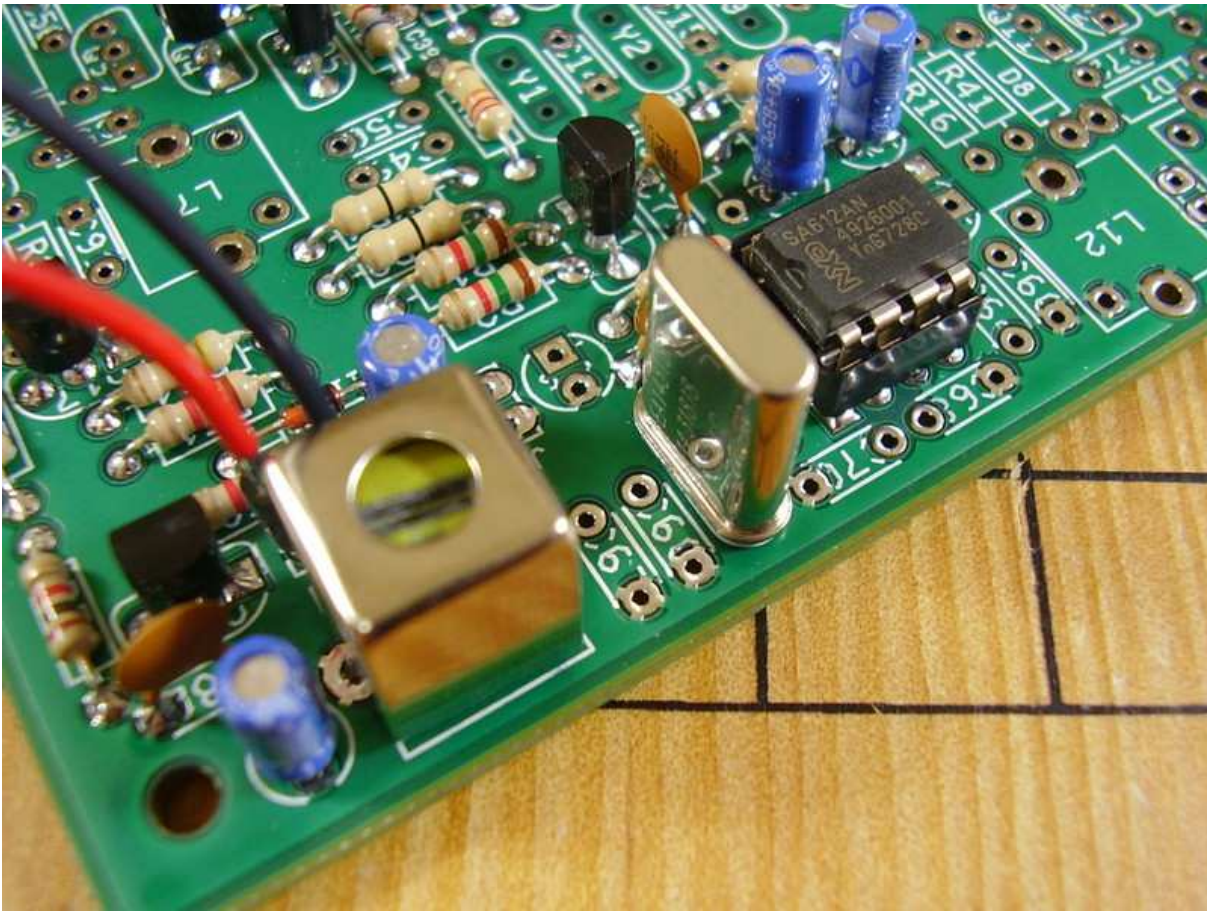

Figure 5.6: [3-4] Y6 14.31818MHz Crystal.

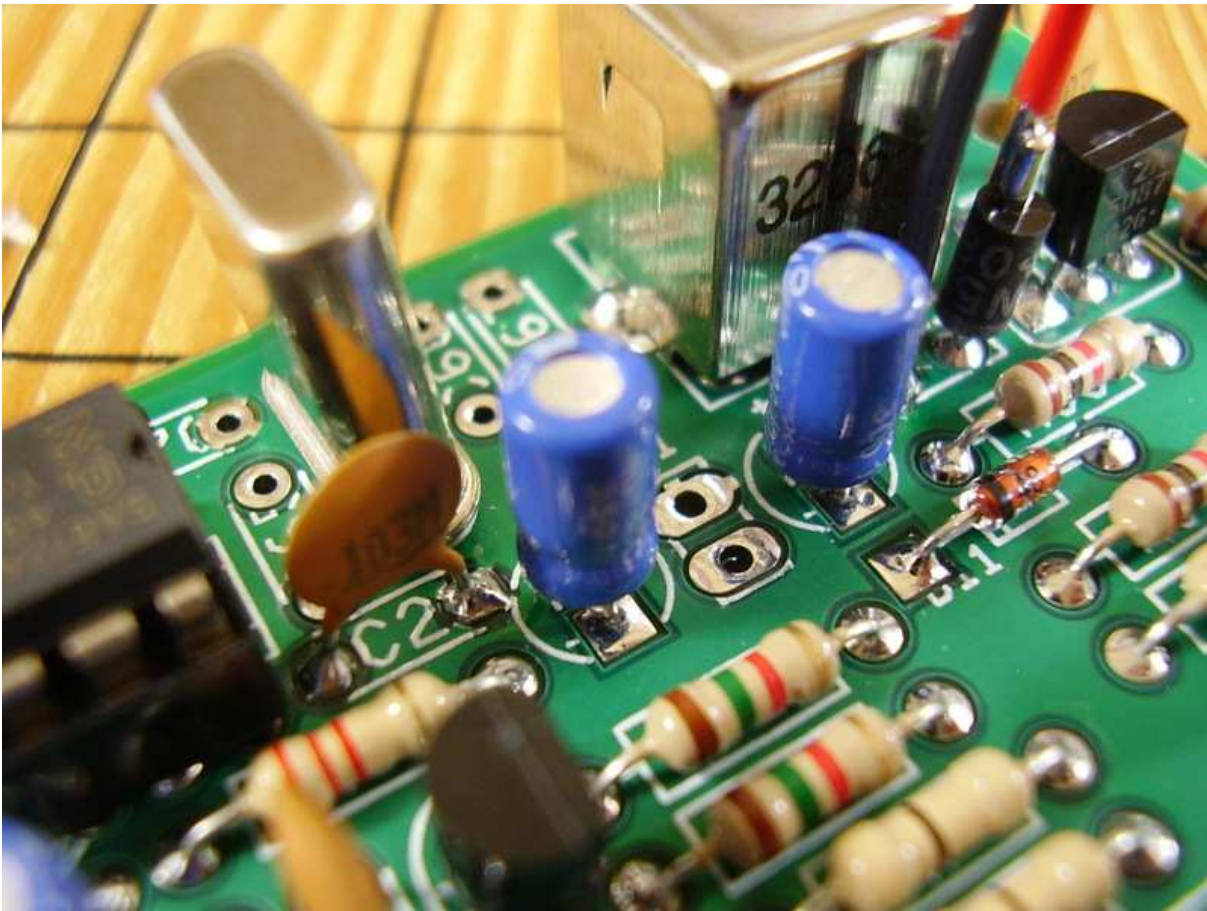

Figure 5.7: [3-5] C86 $1\mu\text{F}$ Electrolytic Cap.

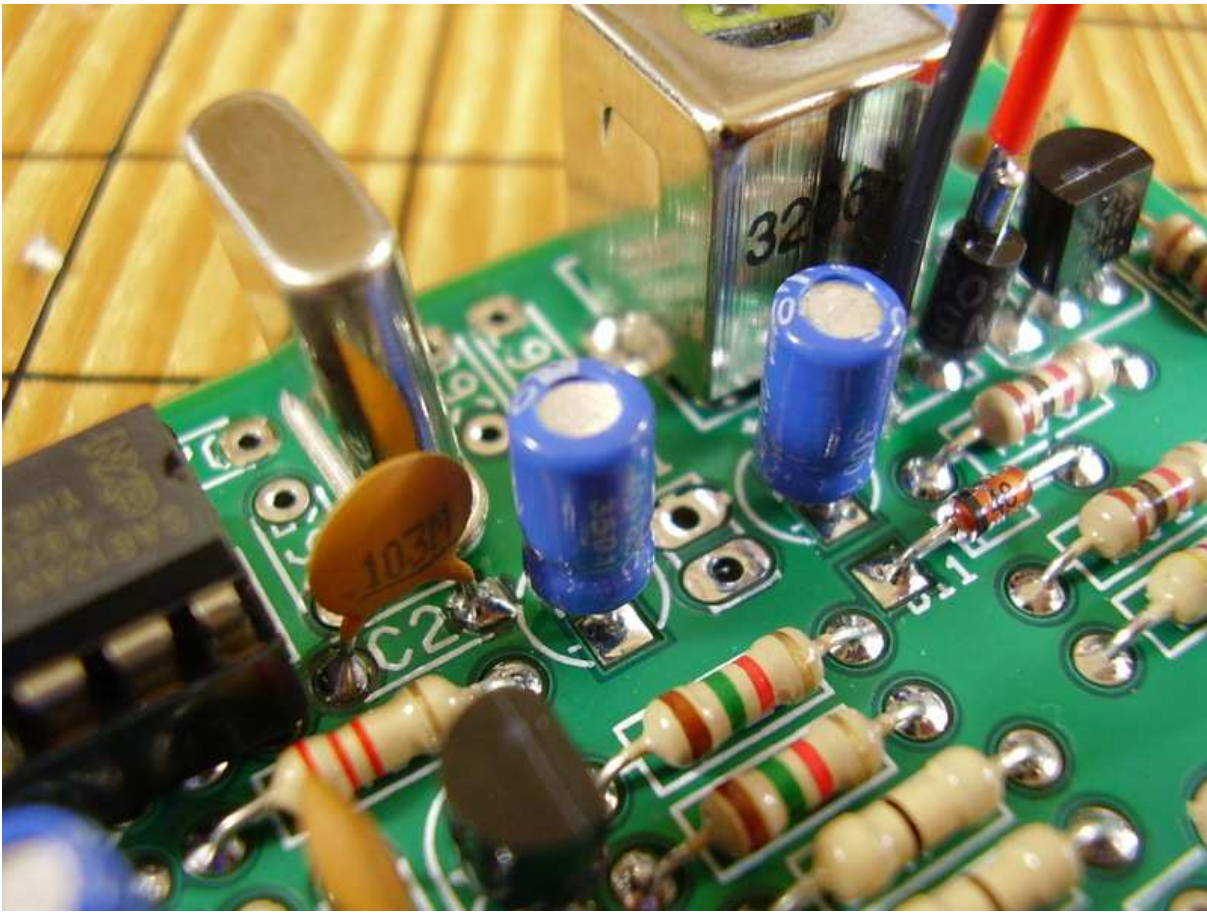

Figure 5.8: [3-5] C86 $1\mu\text{F}$ Electrolytic Cap.

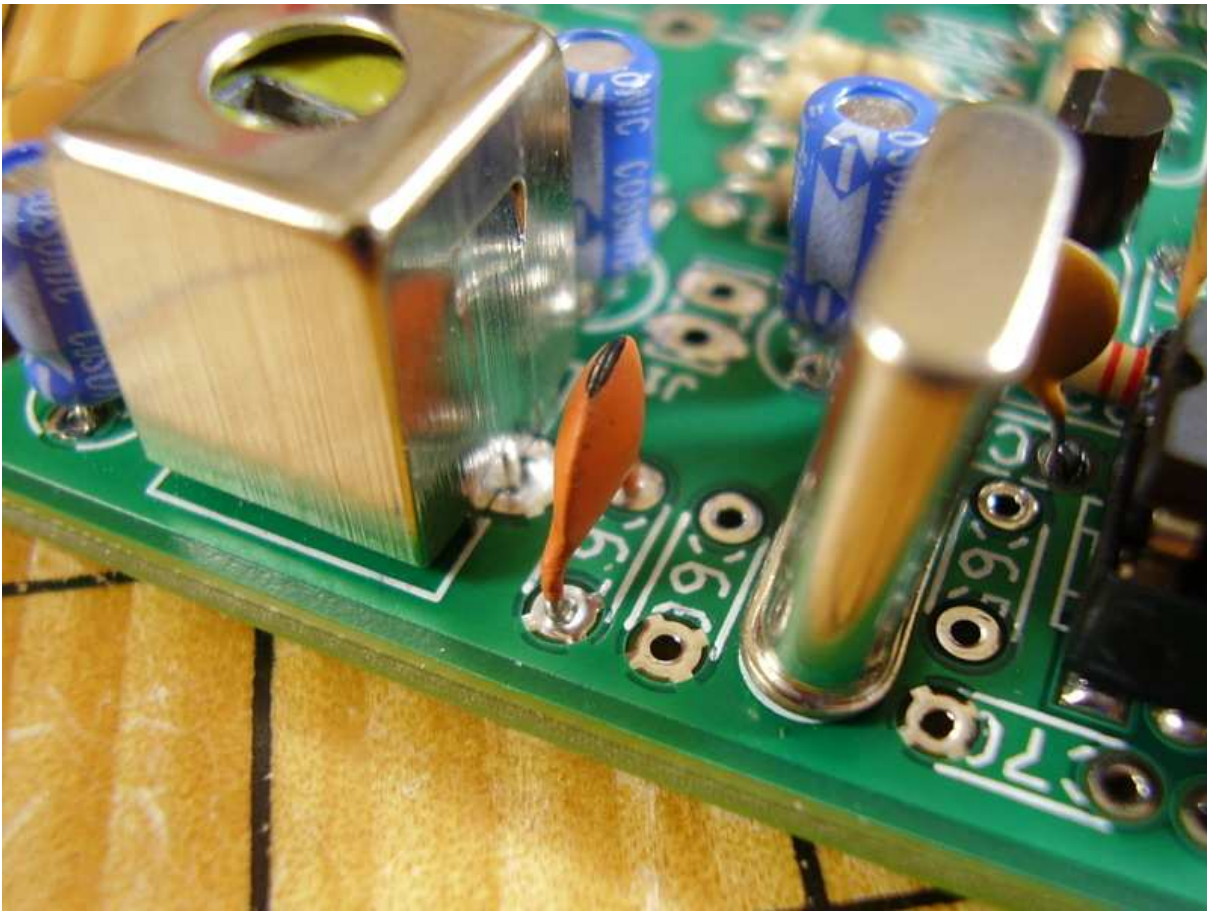

Figure 5.9: [3-6] C67 56pF.

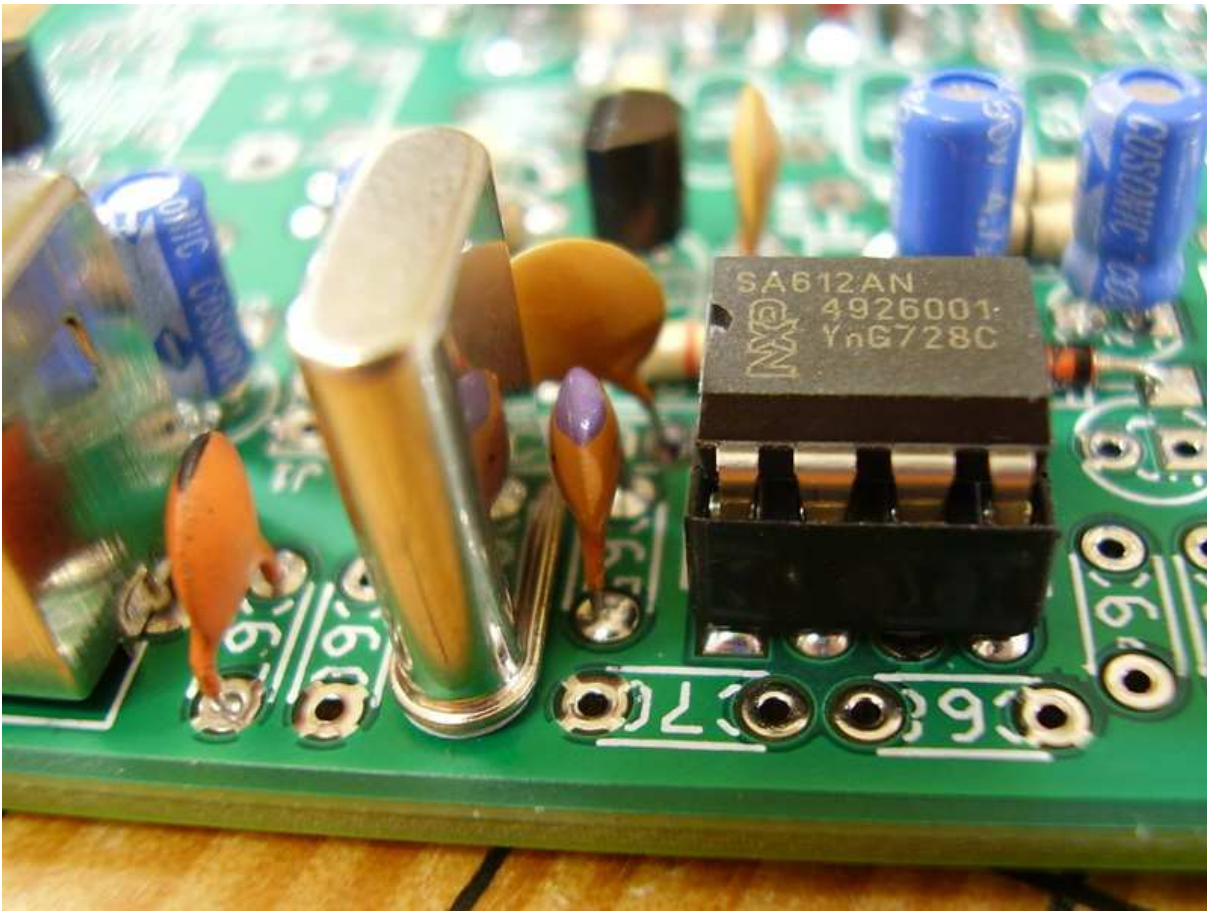

Figure 5.10: [3-7] C65 47pF.

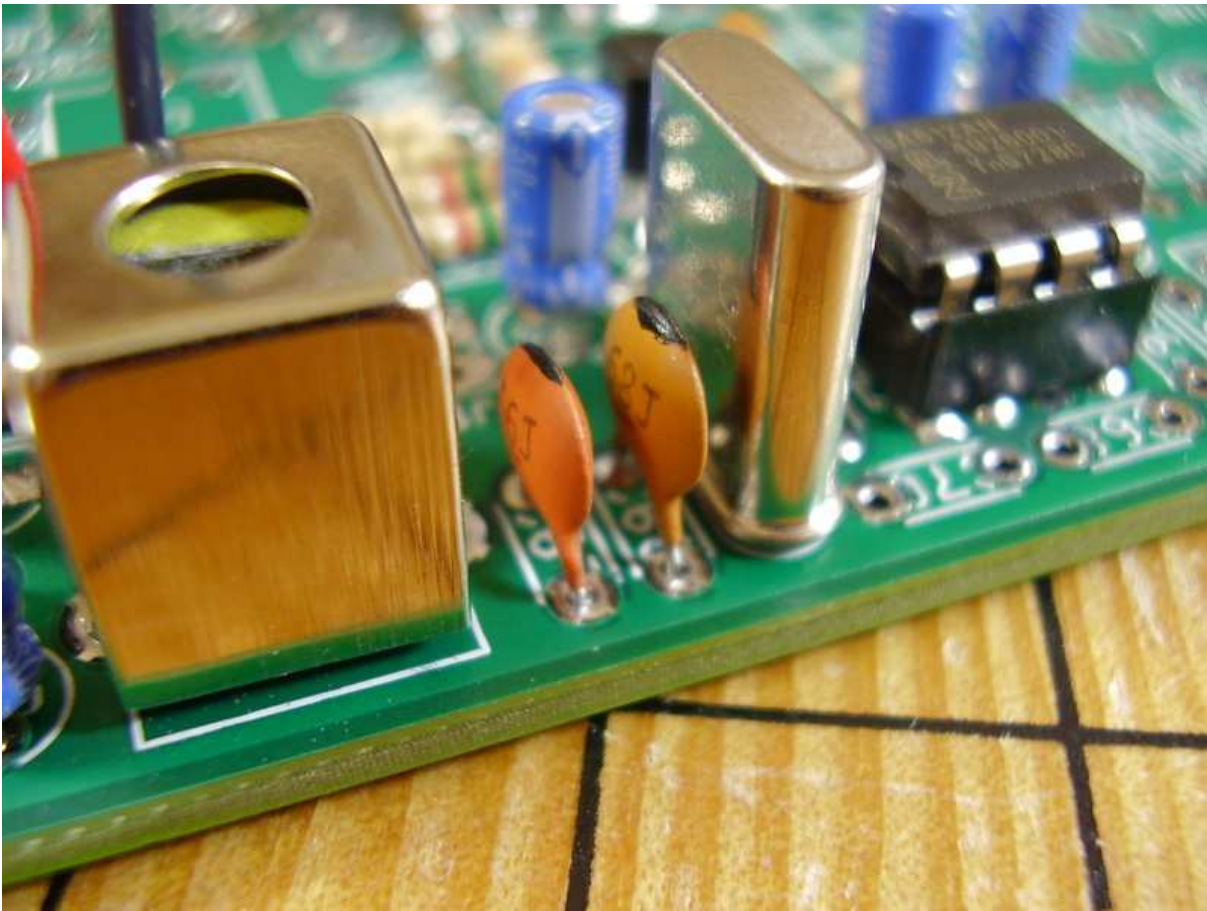

Figure 5.11: [3-8] C66 68pF.

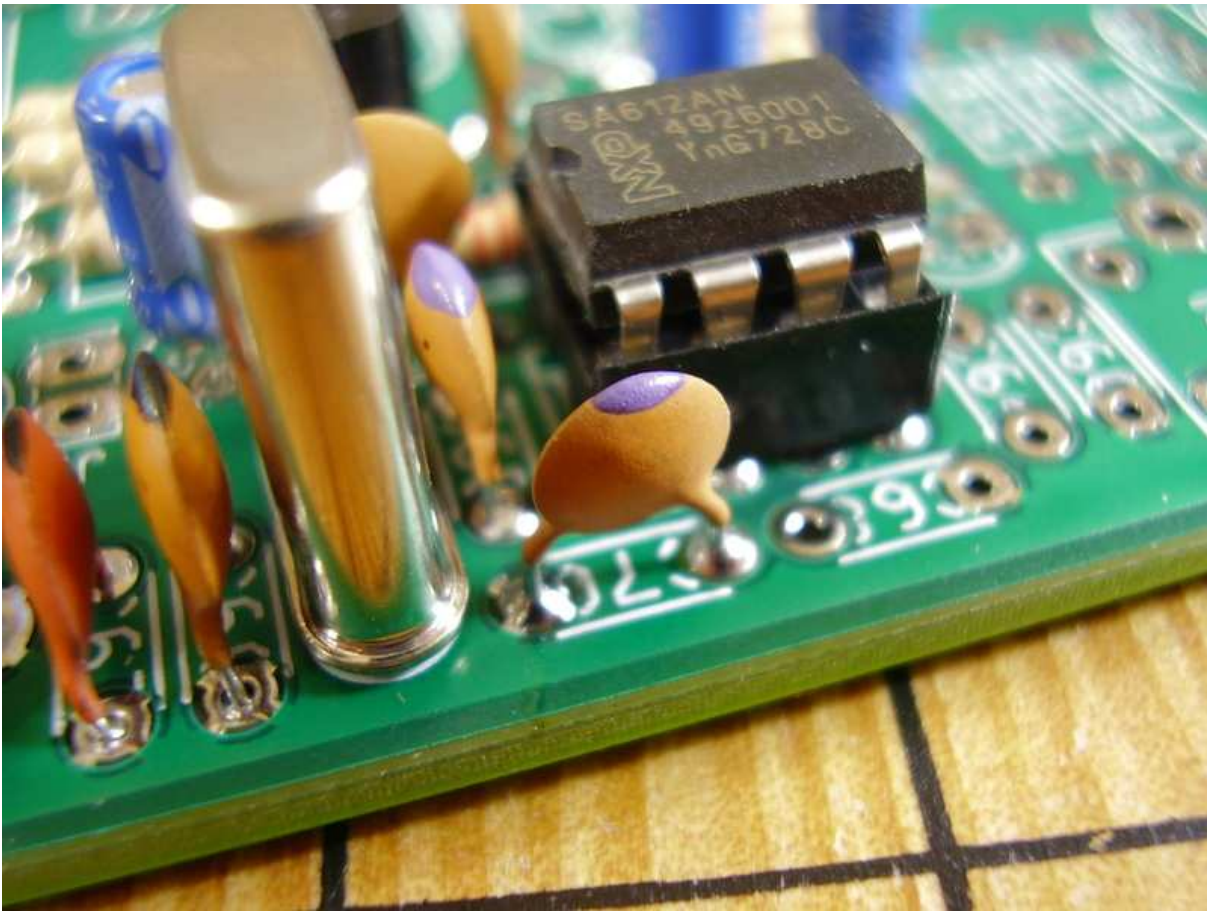

Figure 5.12: [3-9] C70 47pF.

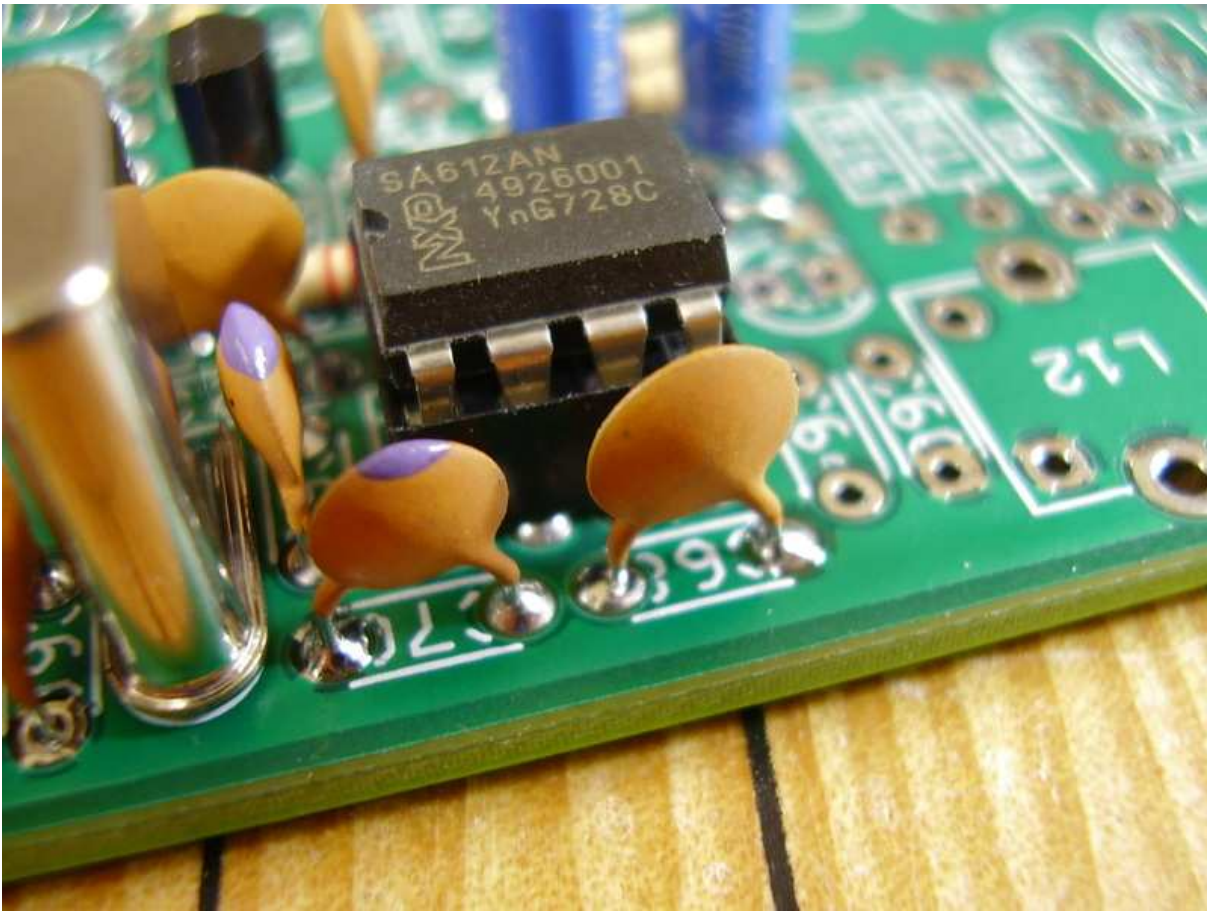

Figure 5.13: [3-10] C68 $.01\mu\text{F}$.

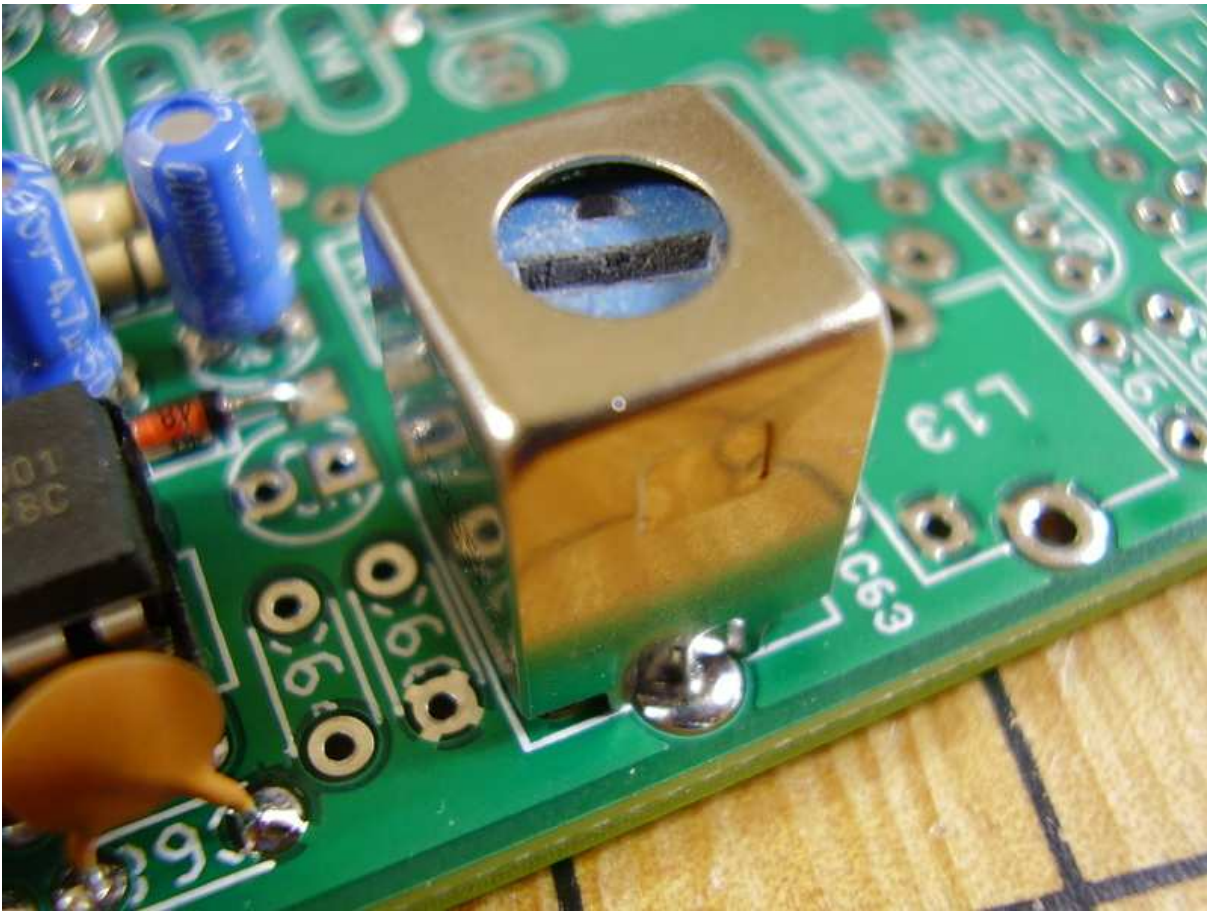

Figure 5.14: [3-11] L12 2.8 μ H (3205).

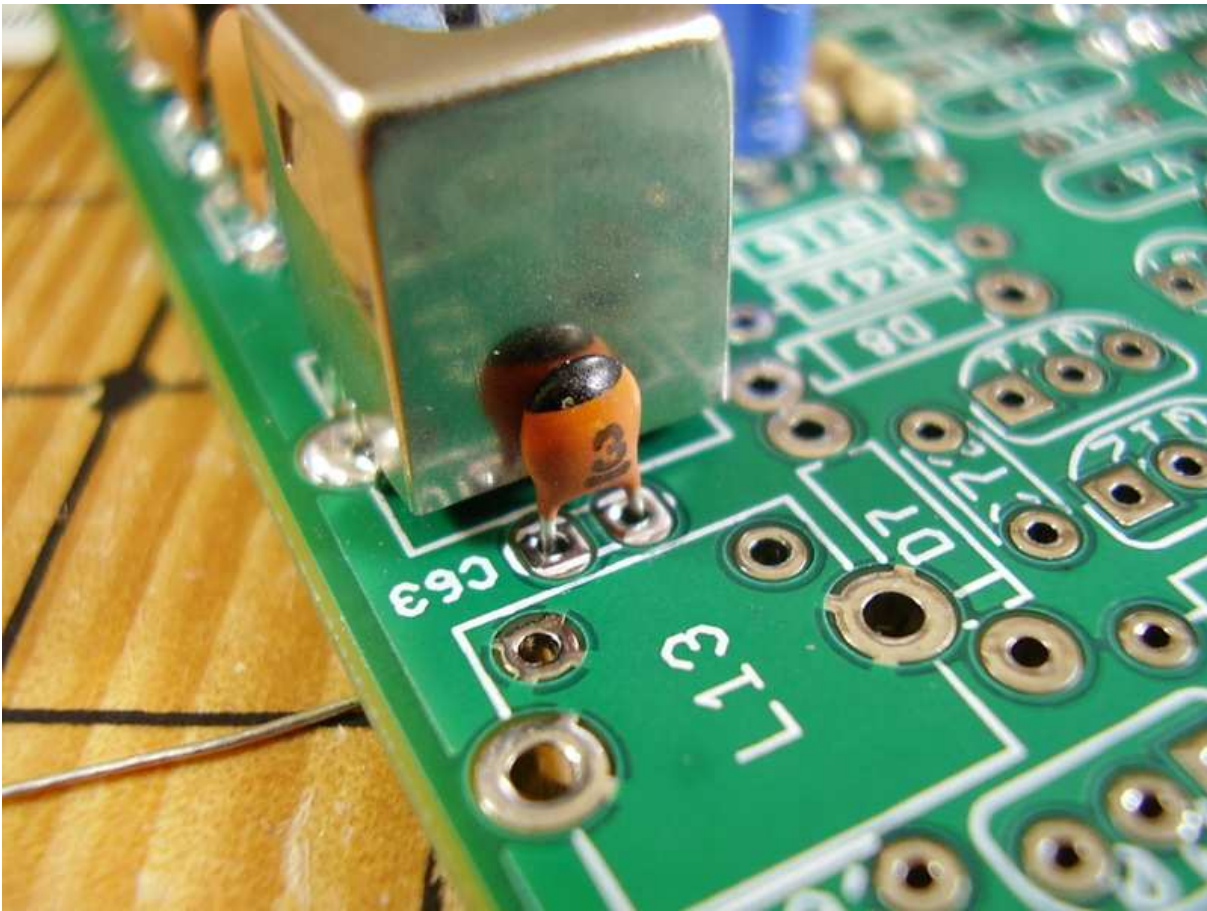

Figure 5.15: [3-12] C63 3pF.

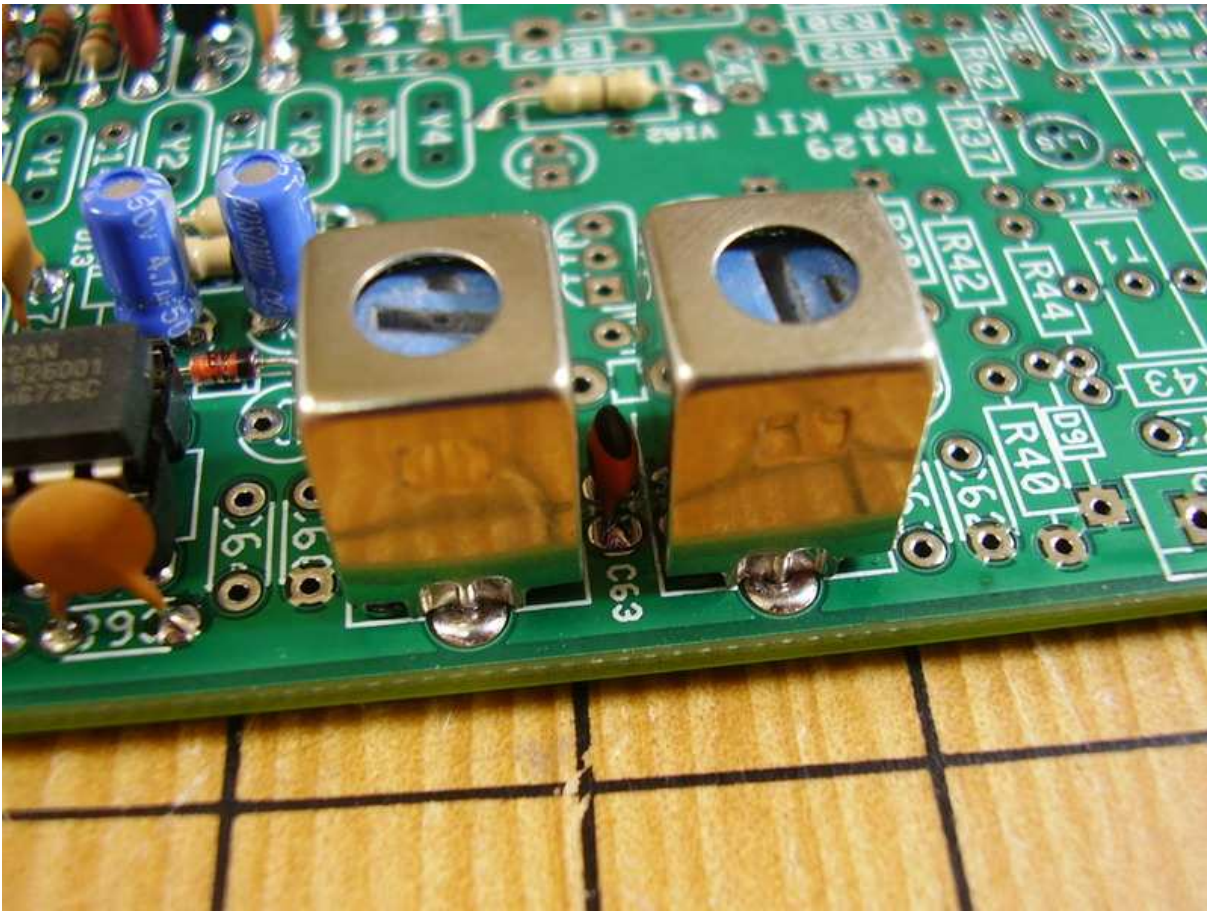

Figure 5.16: [3-13] L13 2.8 μ H (3205).

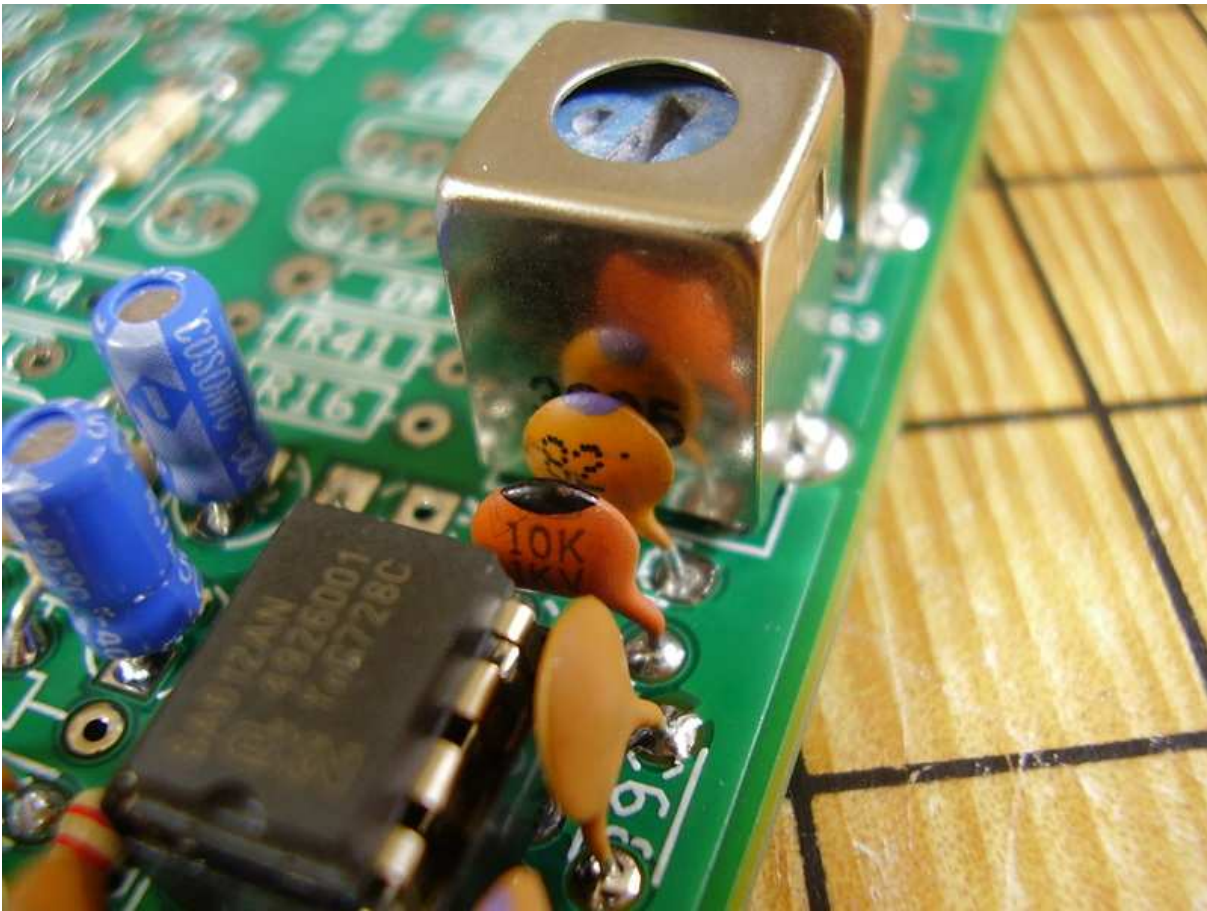

Figure 5.17: [3-14] C64 10pF.

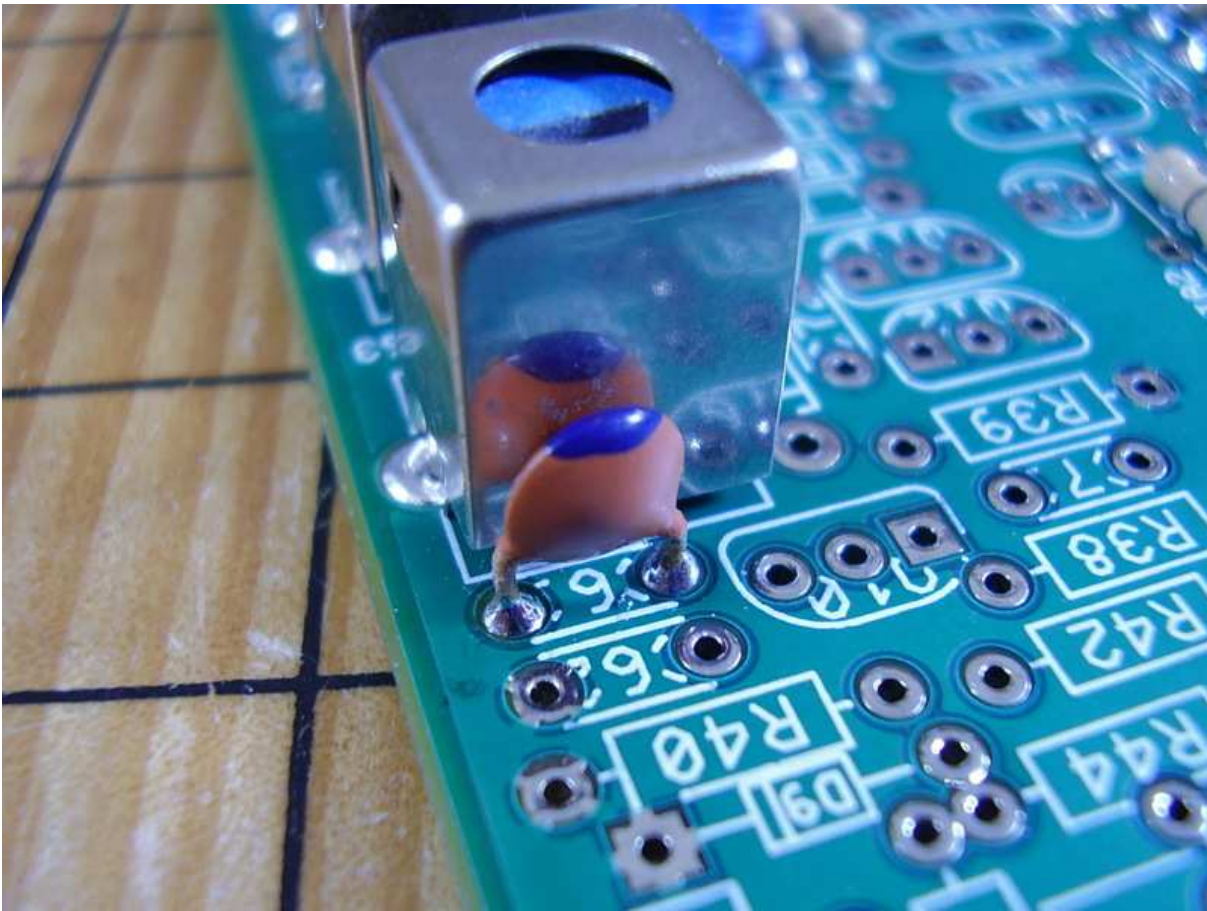

Figure 5.18: [3-15] C60 82pF.

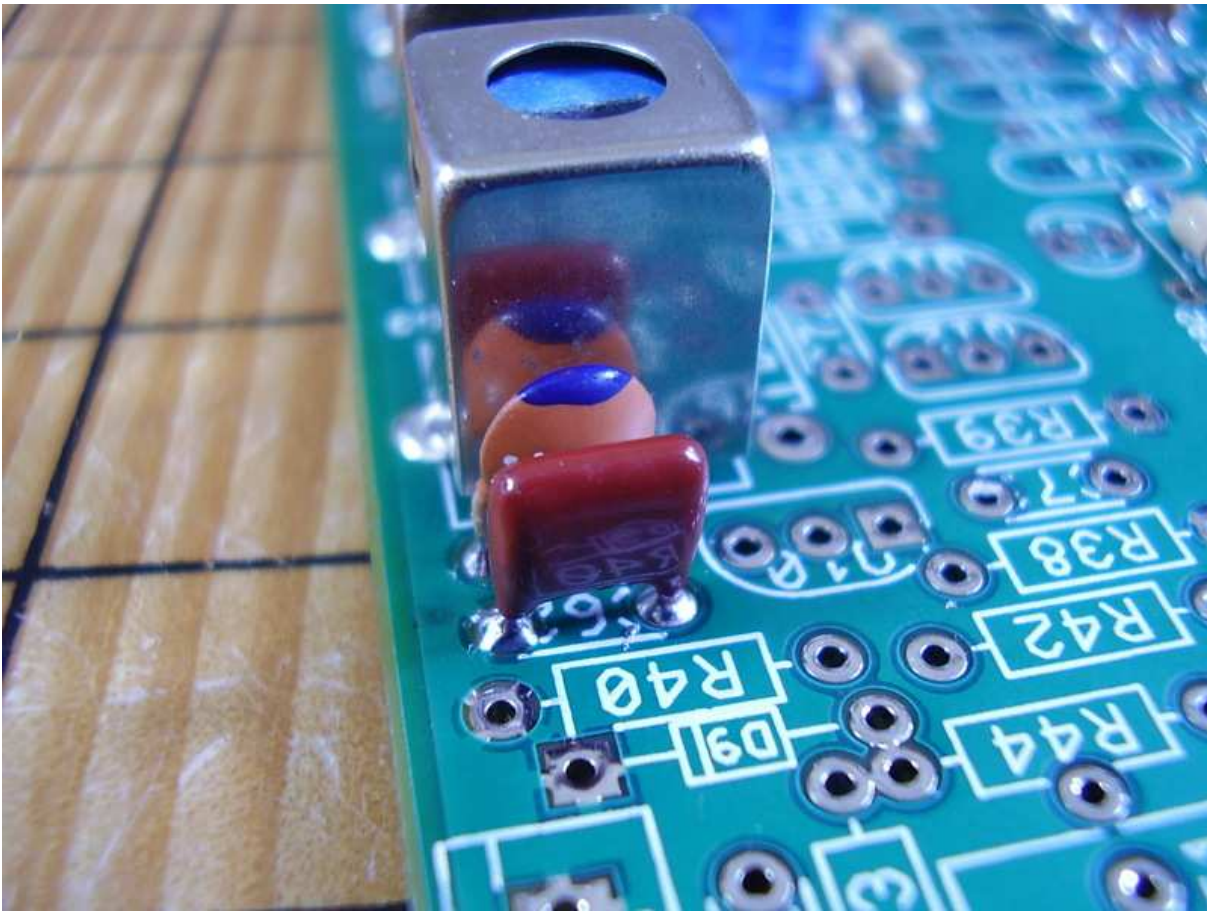

Figure 5.19: [3-17] C62 $.001\mu\text{F}$ mylar film cap.

Chapter 6

Phase 4.0 - 14.318MHz Receiver IF Stages

The receiver mixer stage is followed by a 4-pole crystal filter and then an IF amplifier and will be assembled in this section of the guide.

By now, since you have installed and checked several stage, you should be comfortable with selecting the parts to be installed and the soldering procedure. But there is no way for this segment of the assembly process to be checked, so take extra care with each step to avoid problems later that may be hard to find and correct.

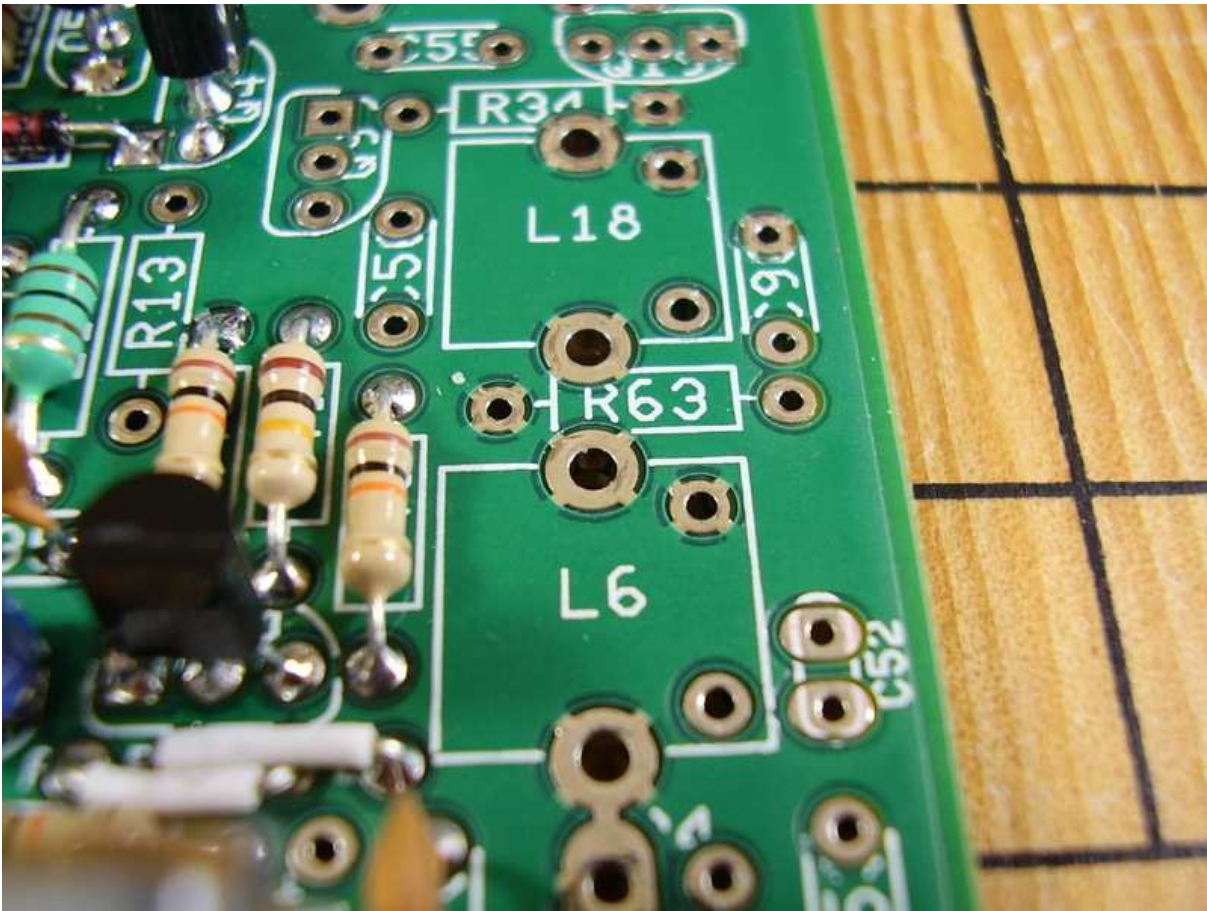

Figure 6.1: L6 location and R63.

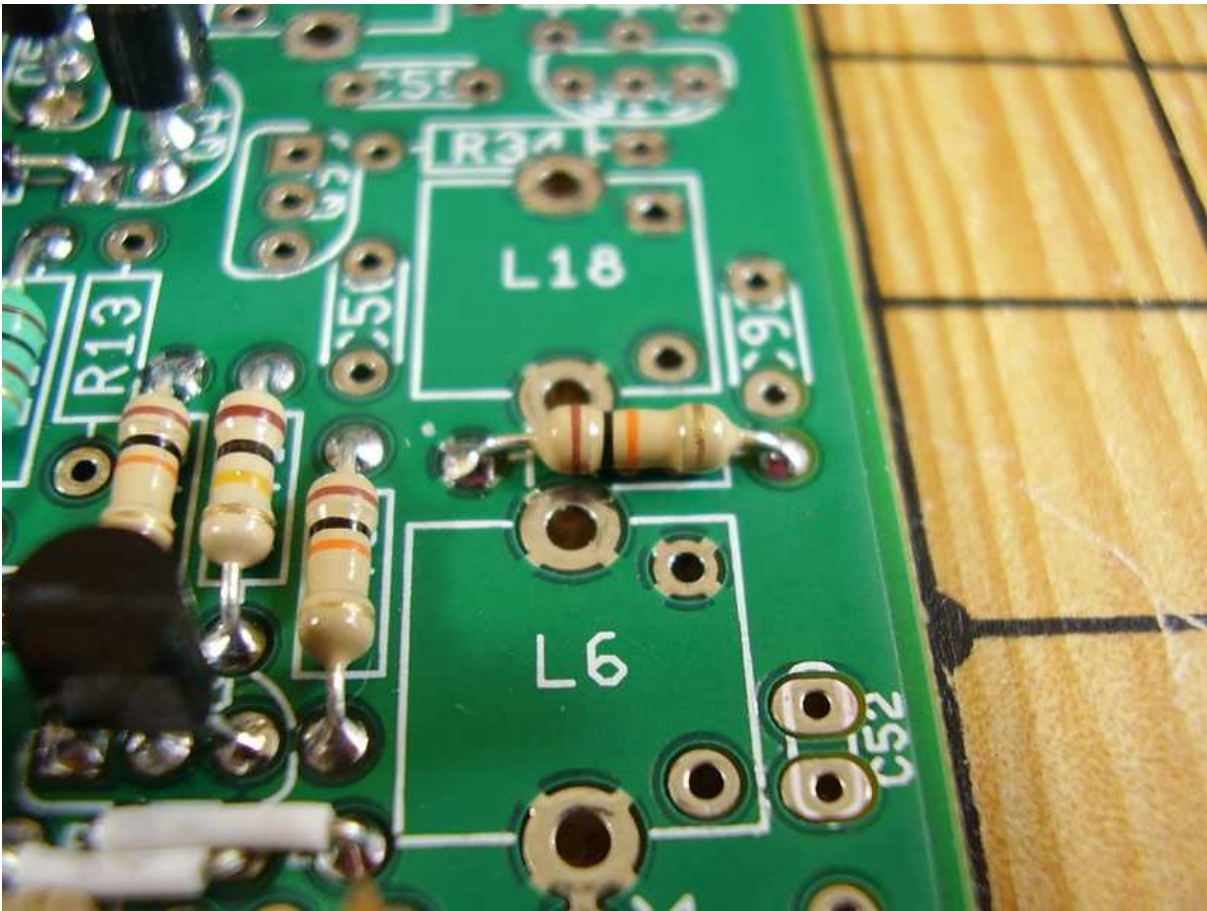

Figure 6.2: [4-10] R63 10K resistor.

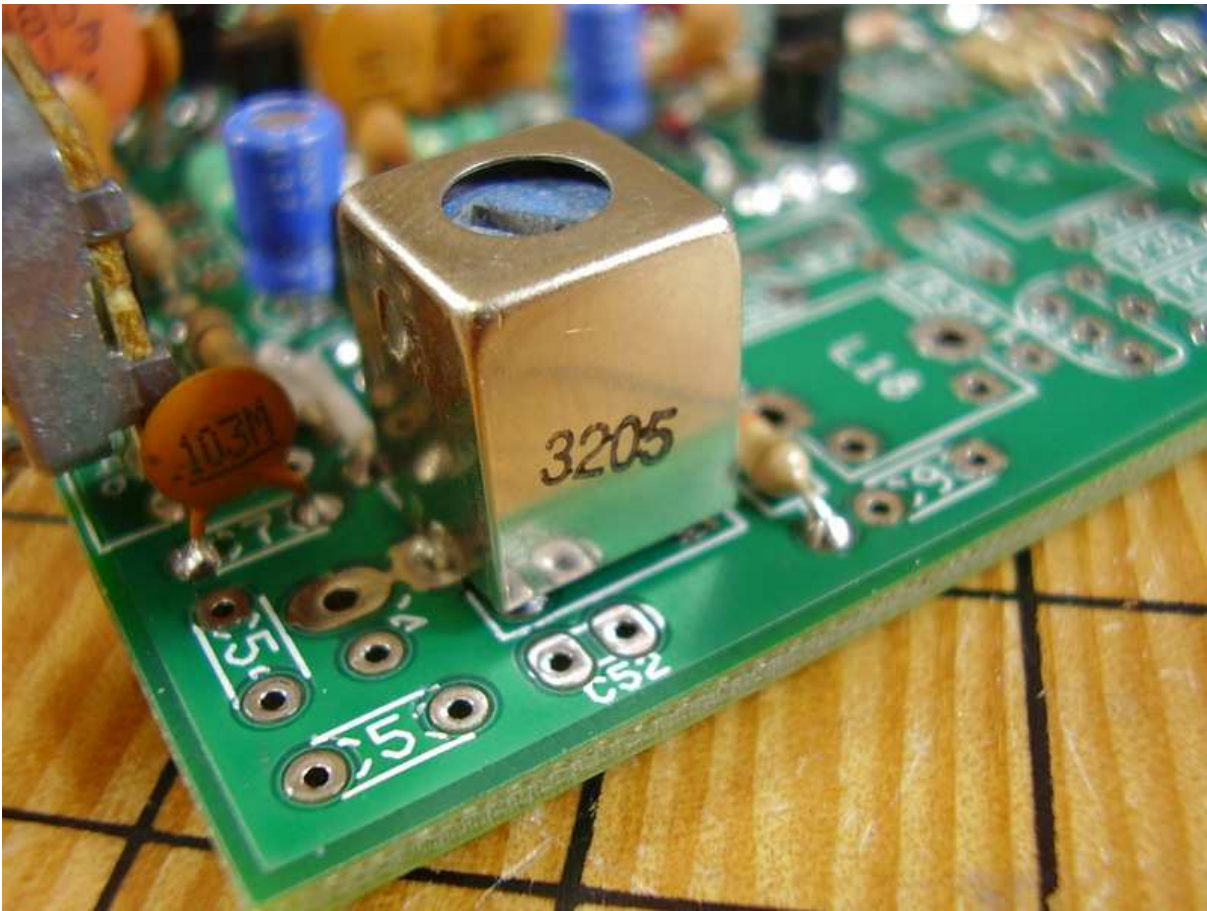

Figure 6.3: [4-1] L6 2.8 μ H (3205).

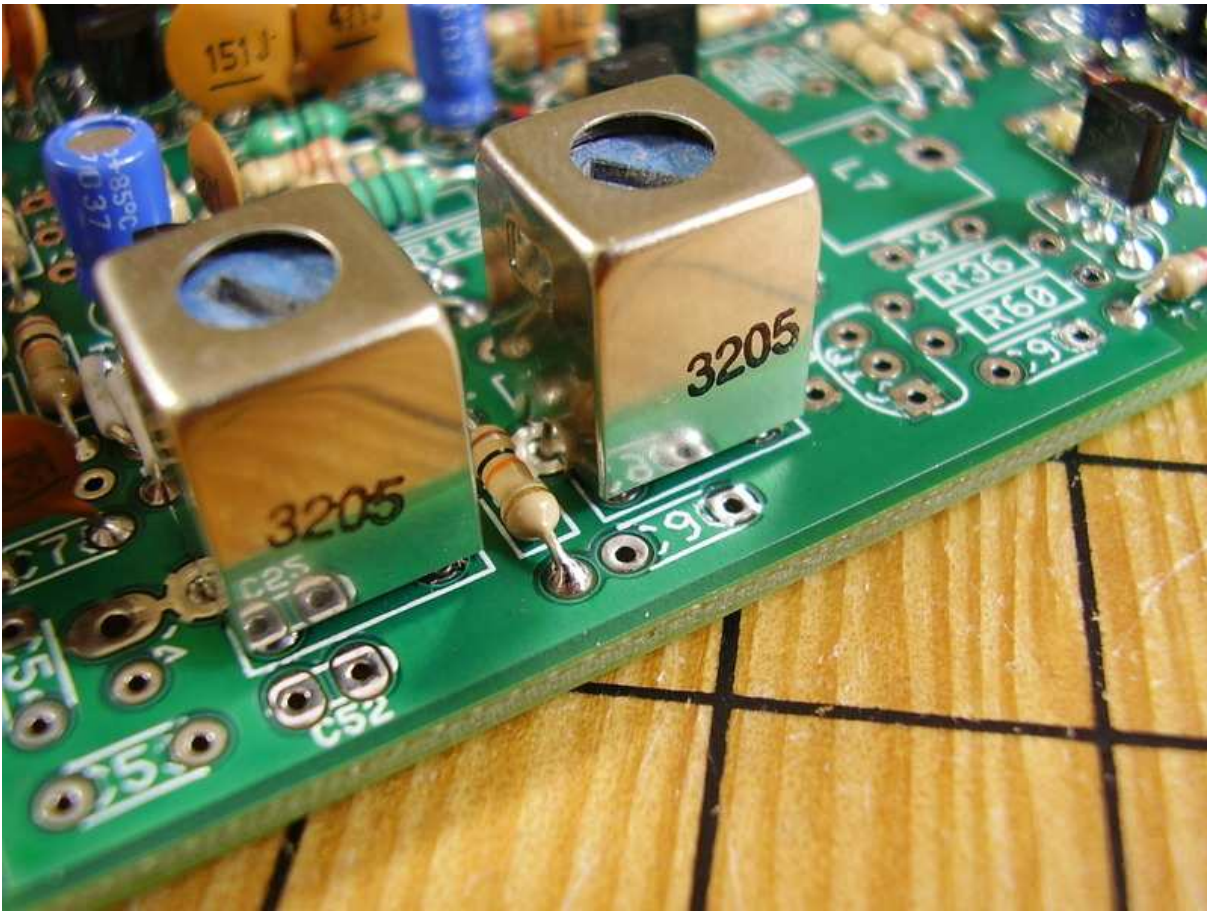

Figure 6.4: [4-2] L18 $2.8\mu\text{H}$ (3205).

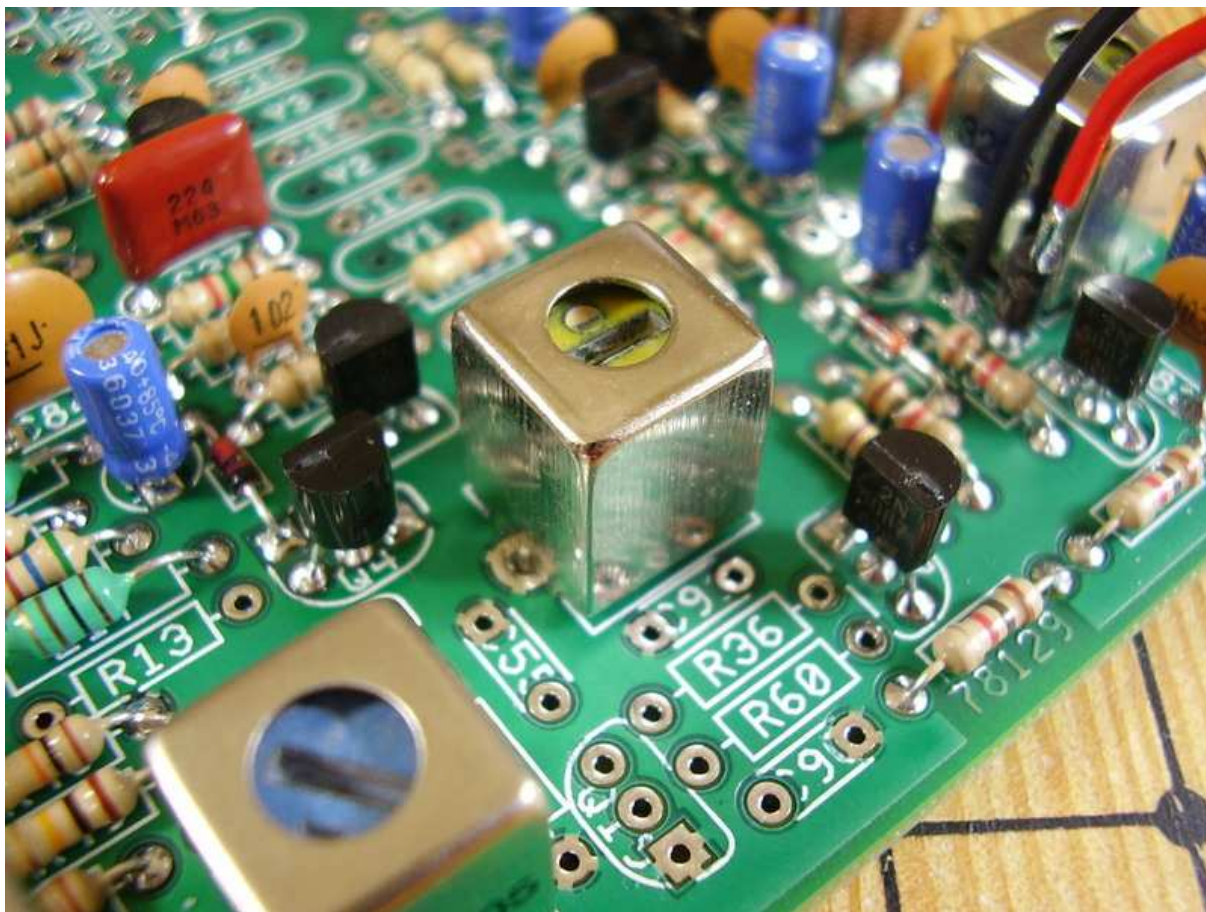

Figure 6.5: [4-3] L7 1.3 μ H (3206).

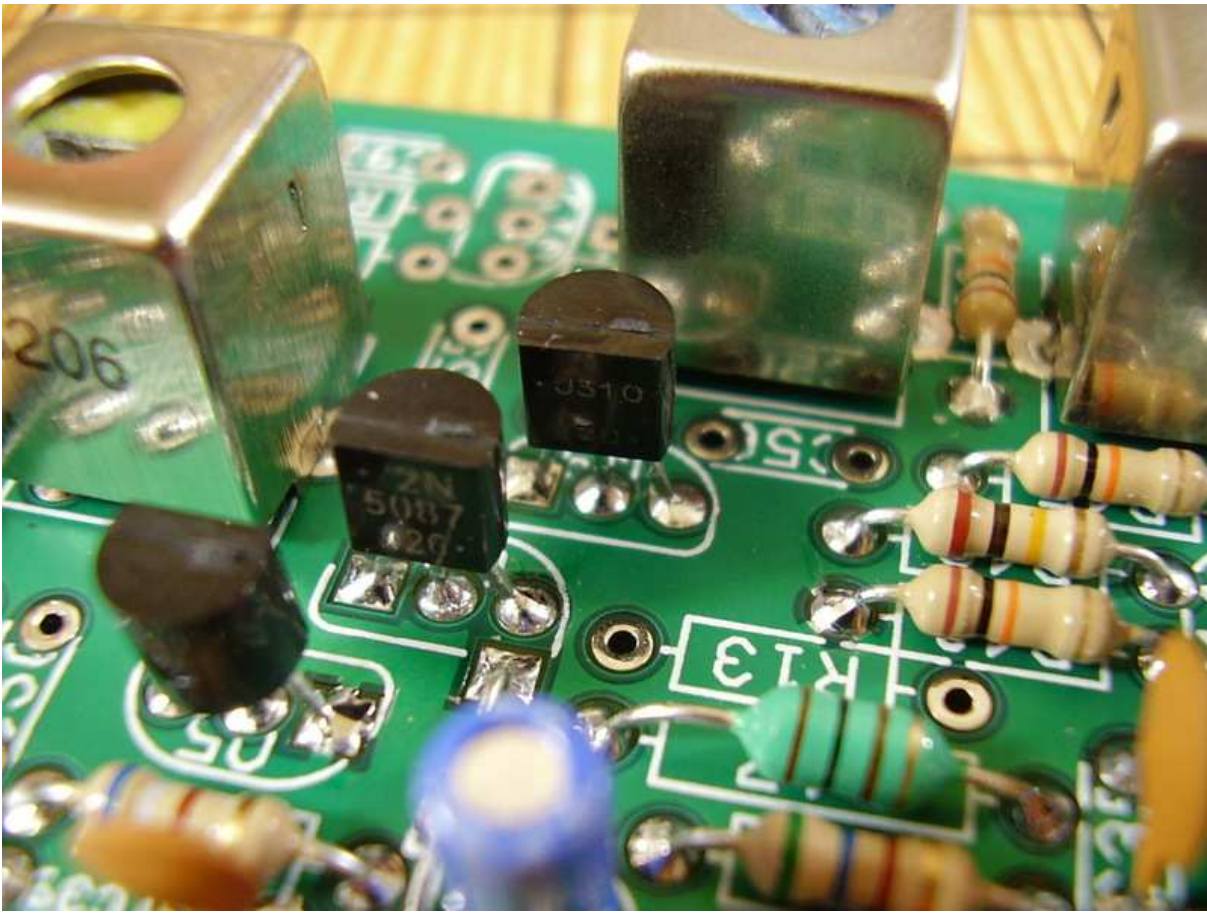

Figure 6.6: [4-4] Q9 J310 JFET.

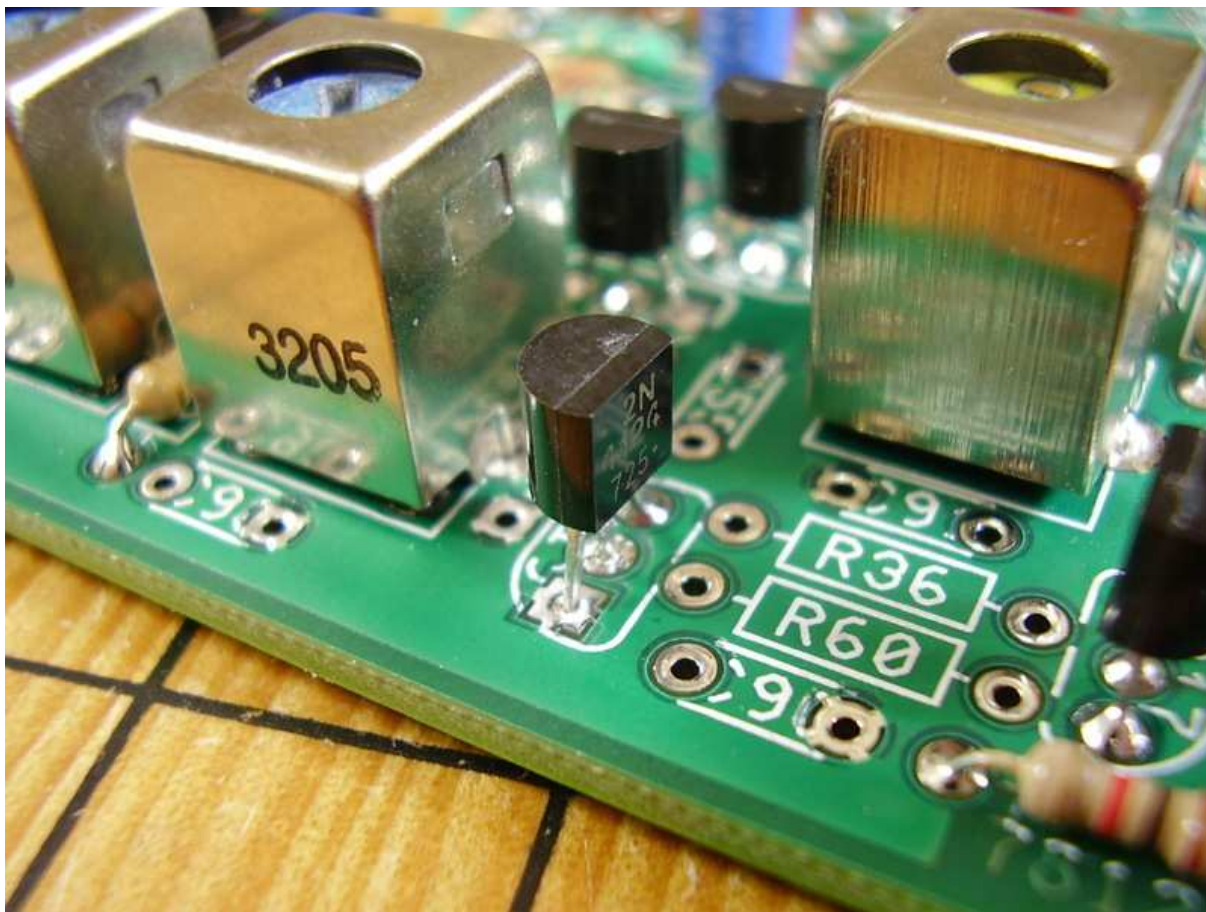

Figure 6.7: [4-5a] Q19 2N2124.

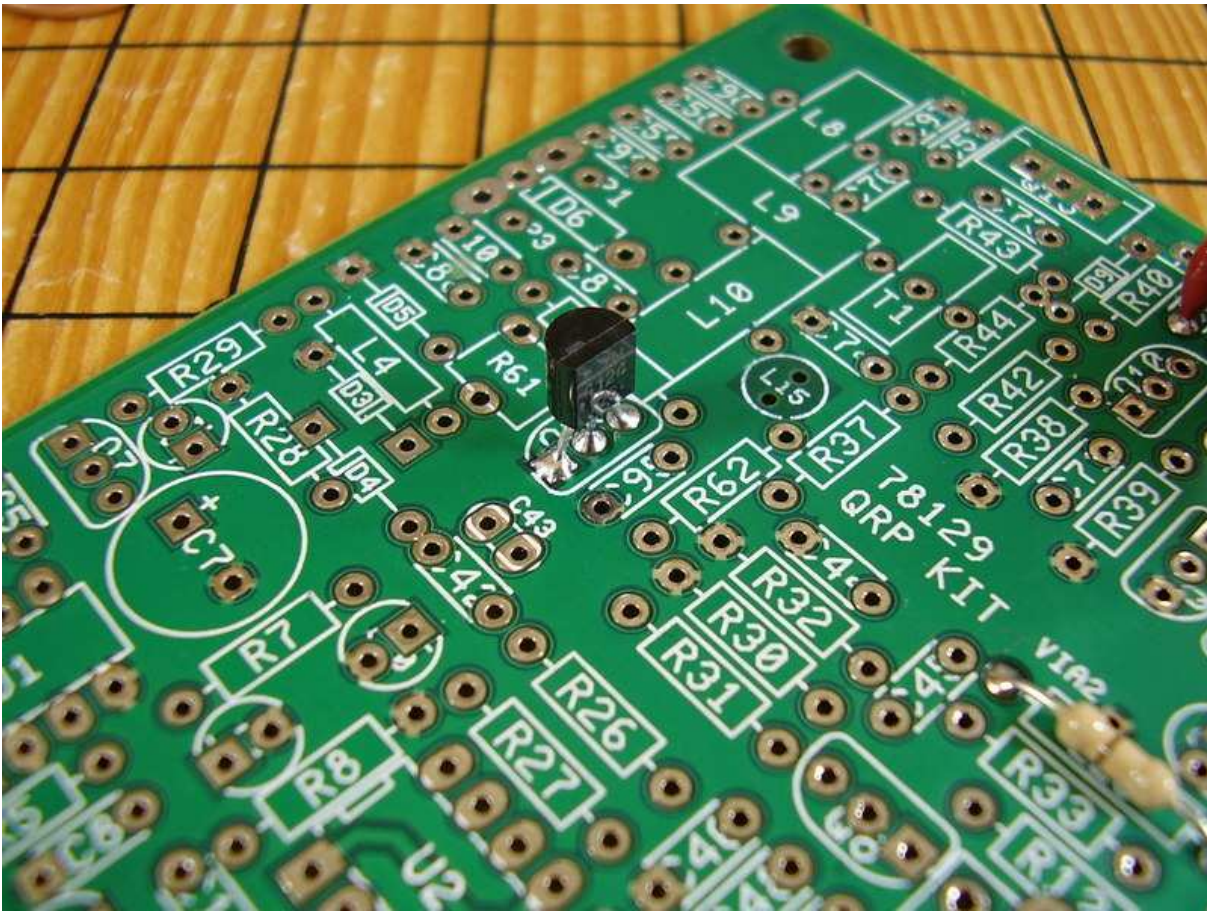

Figure 6.8: [4-5b] Q20 2N2124.

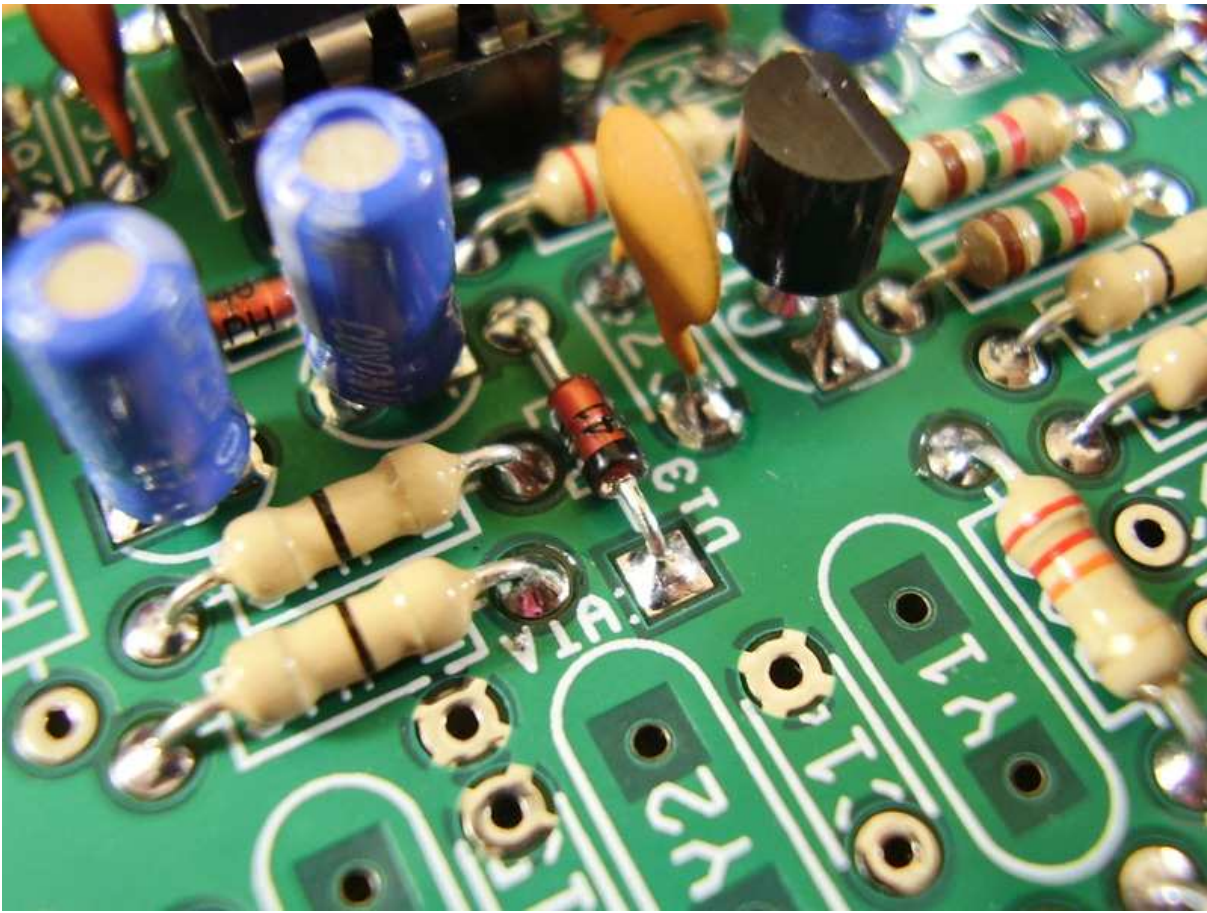

Figure 6.9: [4-6] D13 1N4148.

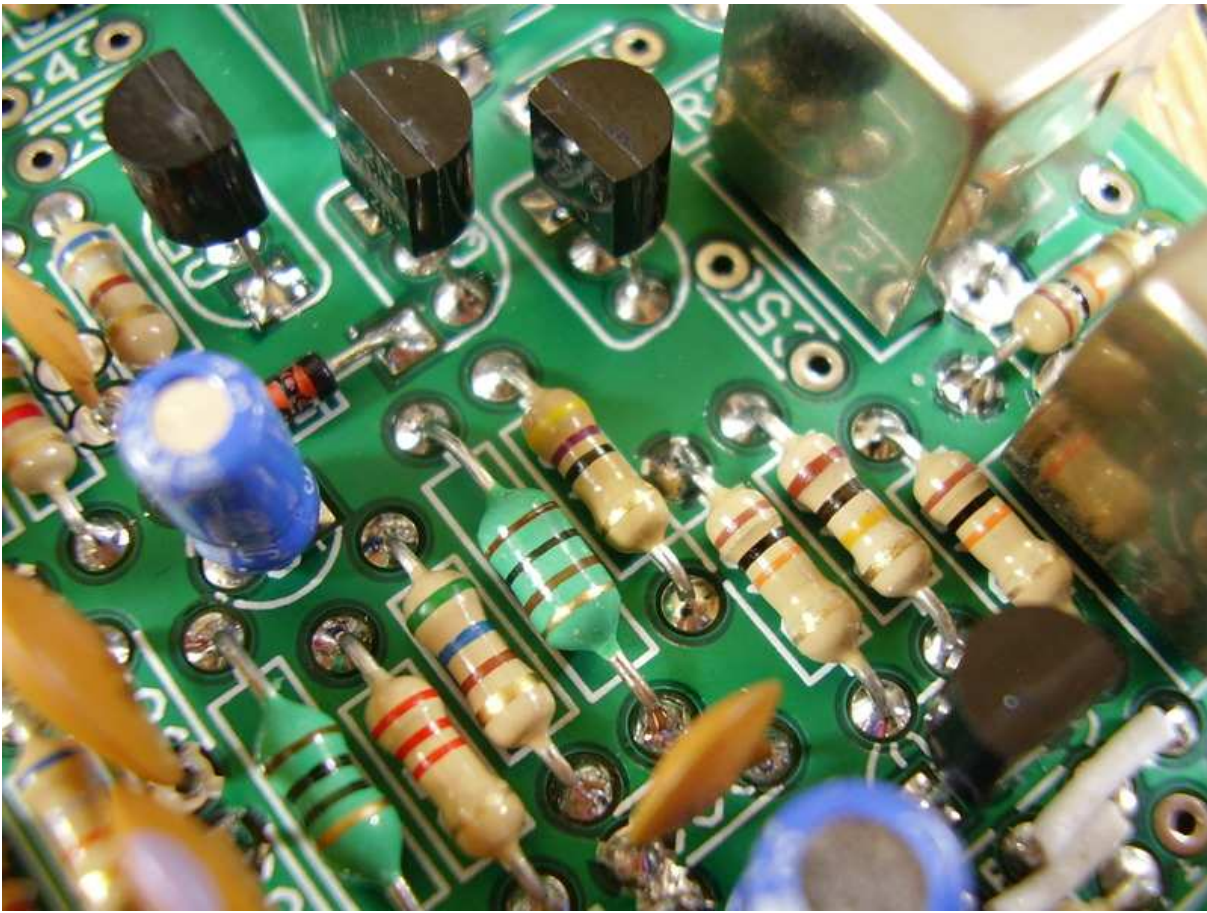

Figure 6.10: [4-7] R13 47 ohms.

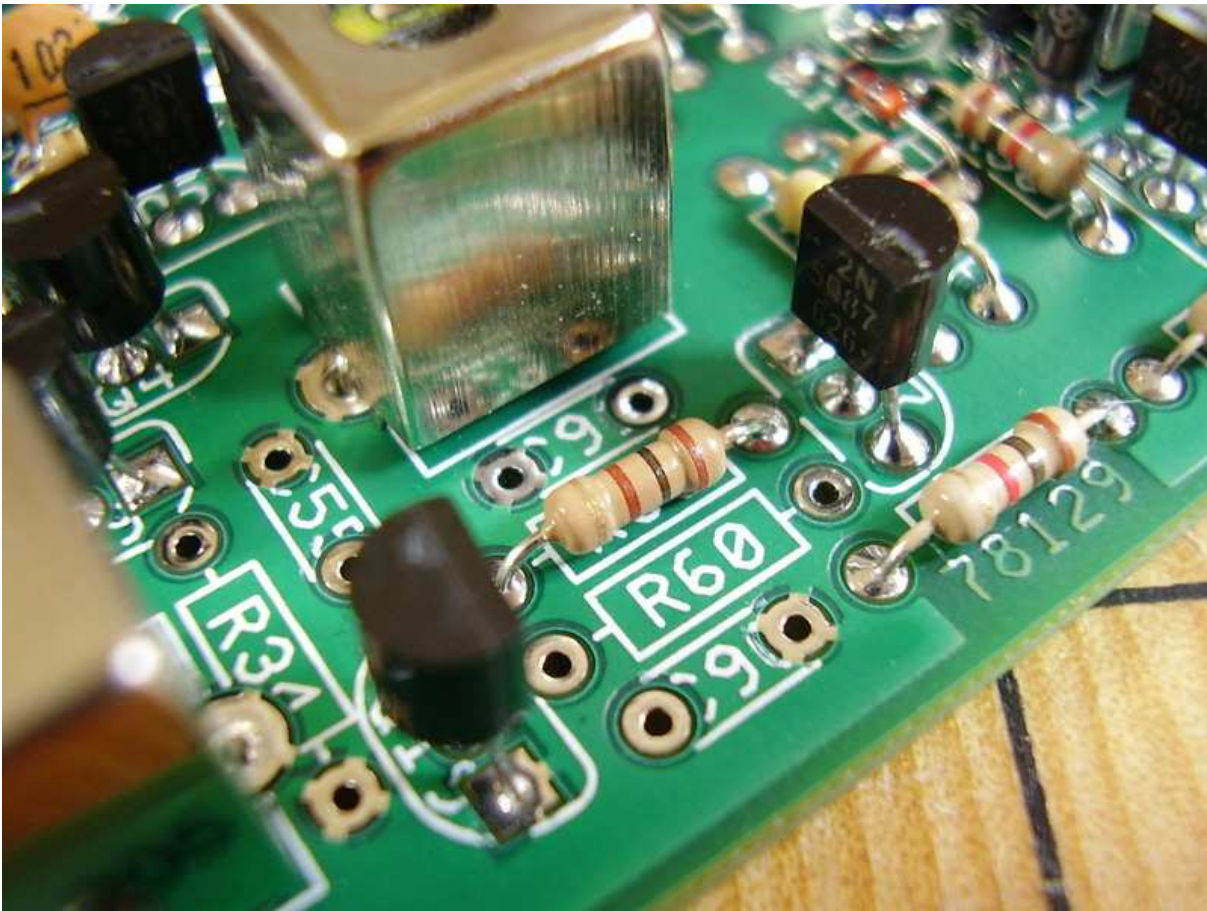

Figure 6.11: [4-8] R36 100 ohms.

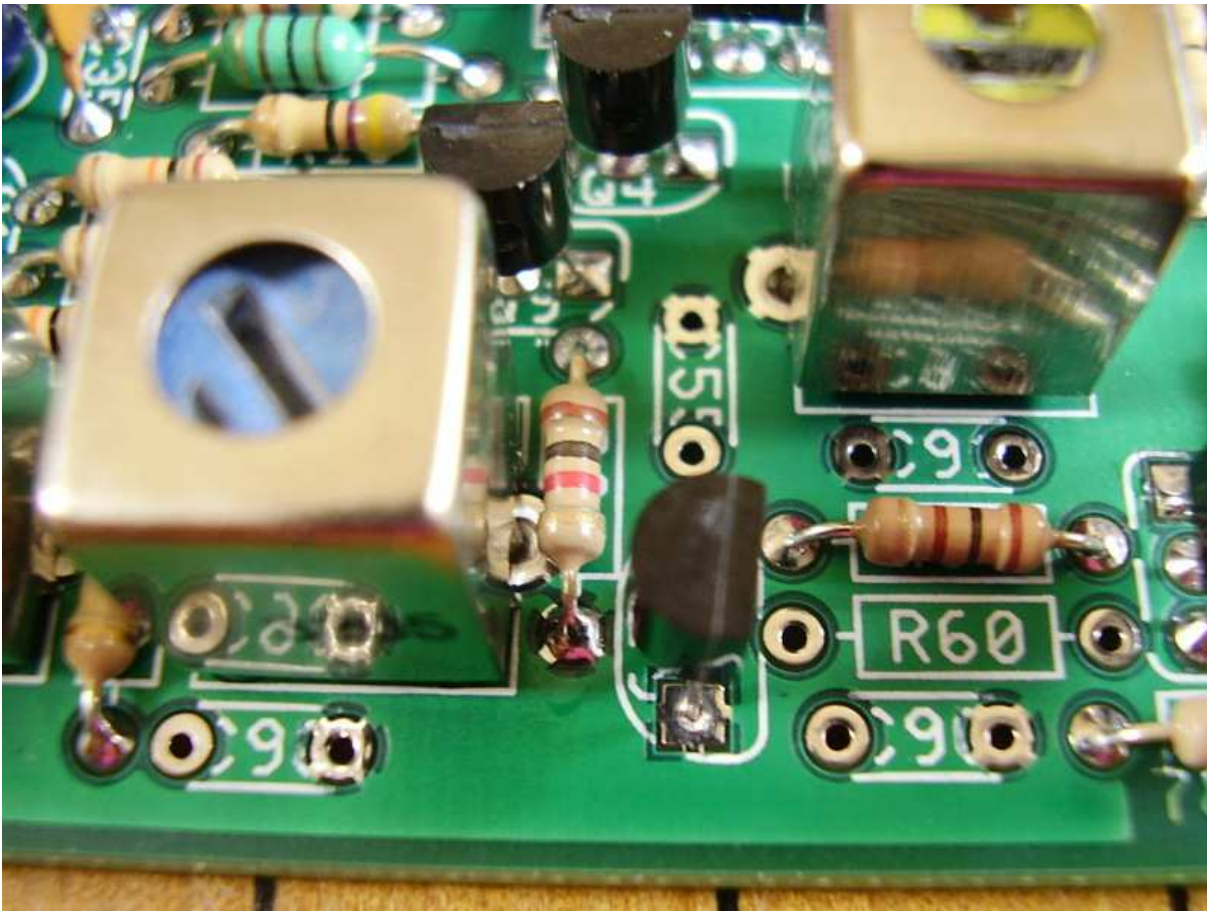

Figure 6.12: [4-9] R34 1K.

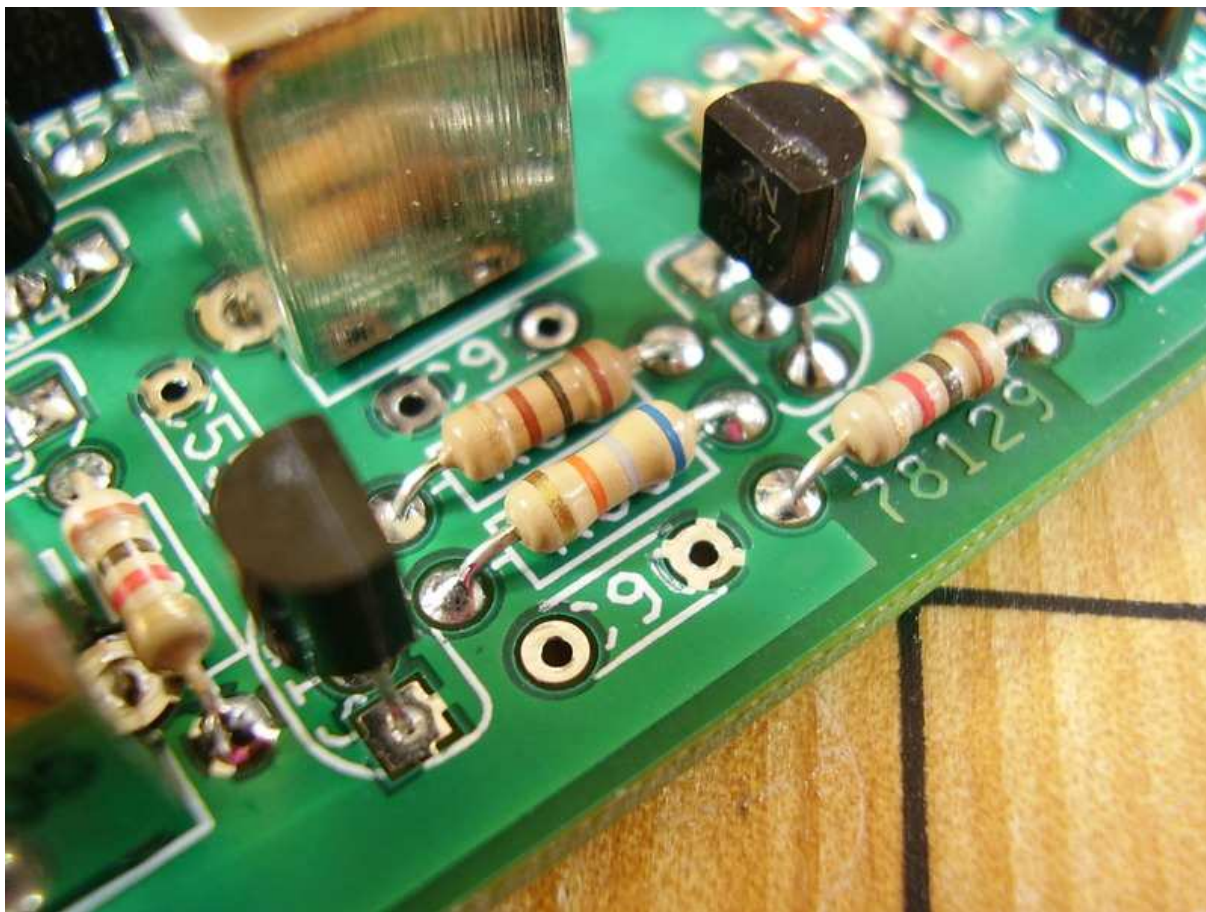

Figure 6.13: [4-11] R60 68K.

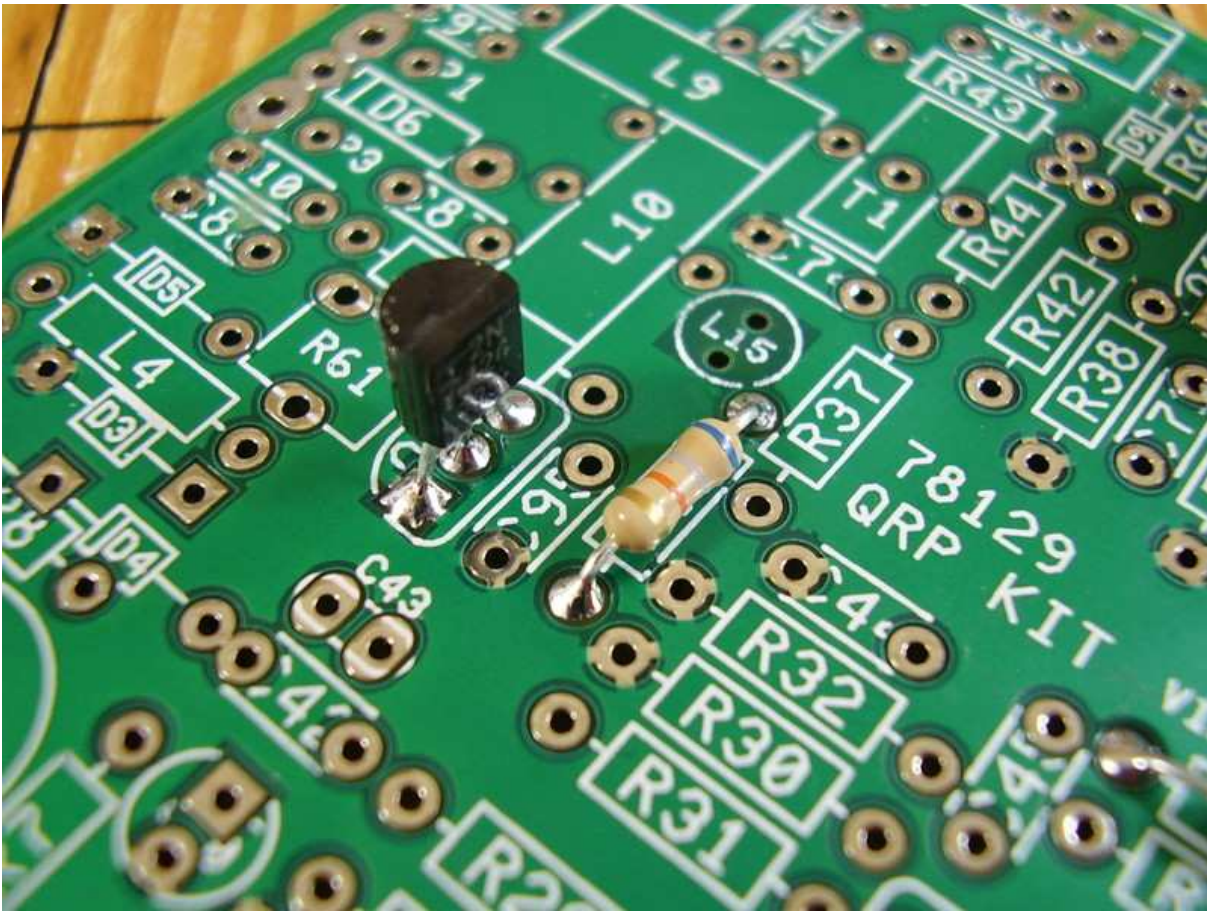

Figure 6.14: [4-12] R62 68K.

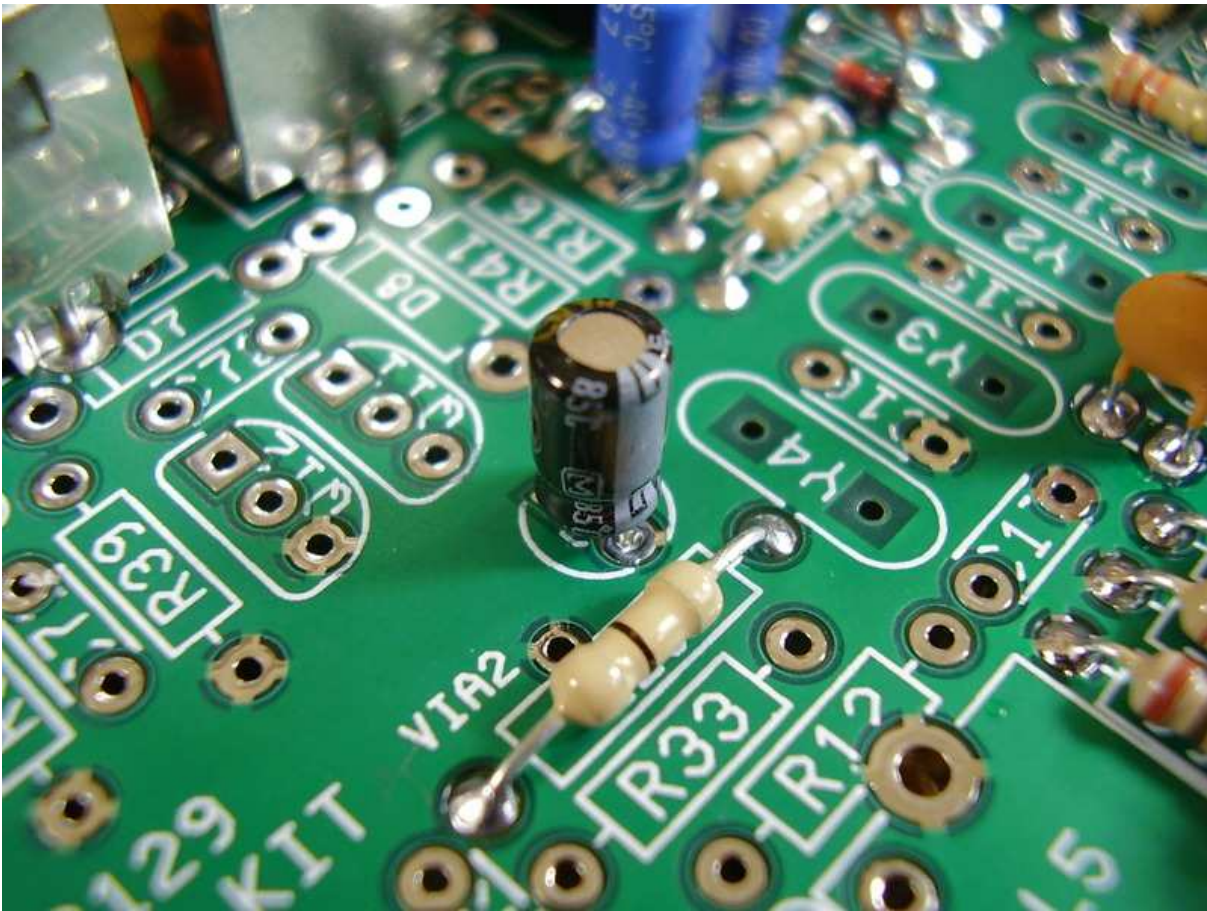

Figure 6.15: [4-13] C93 0.22 μ F electrolytic cap.

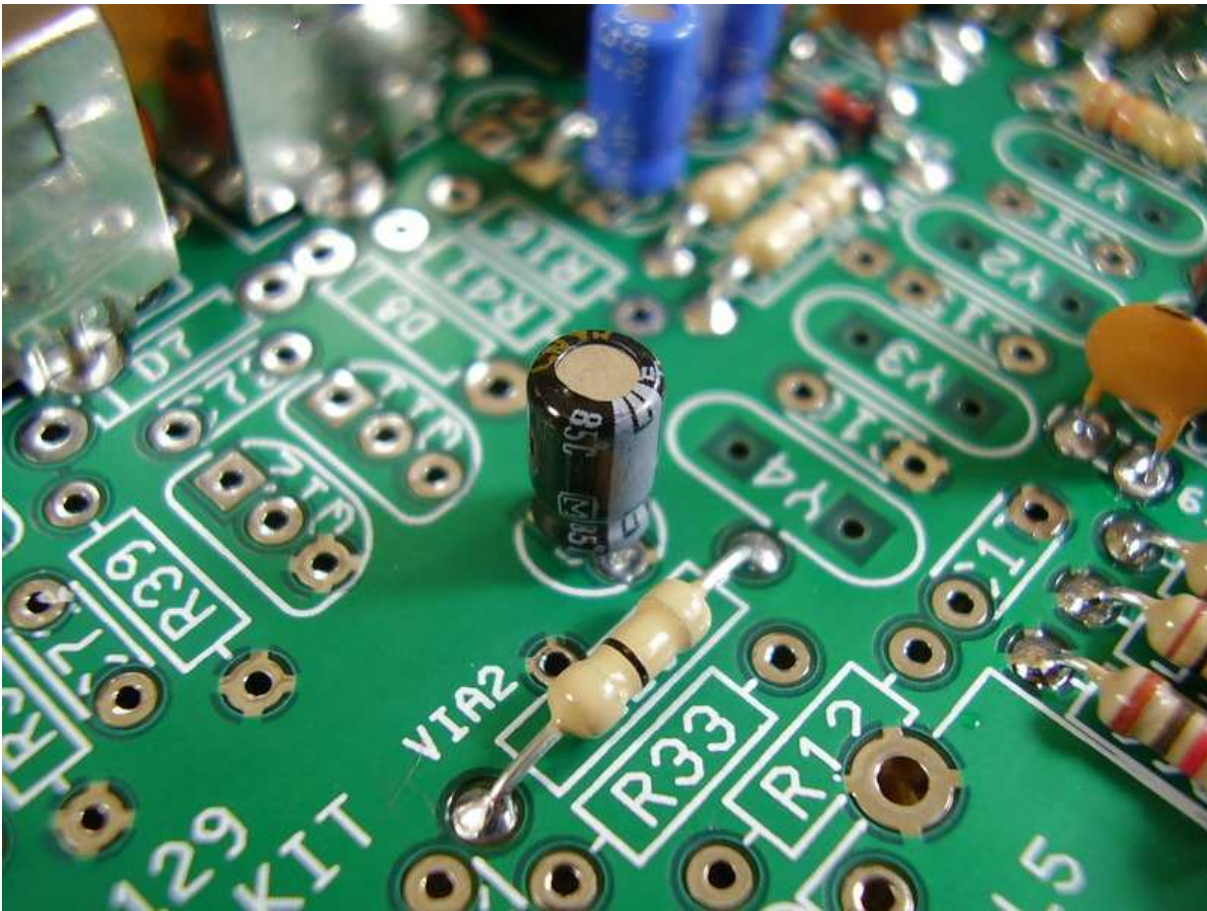

Figure 6.16: [4-13] C93 0.22 μ F electrolytic cap.

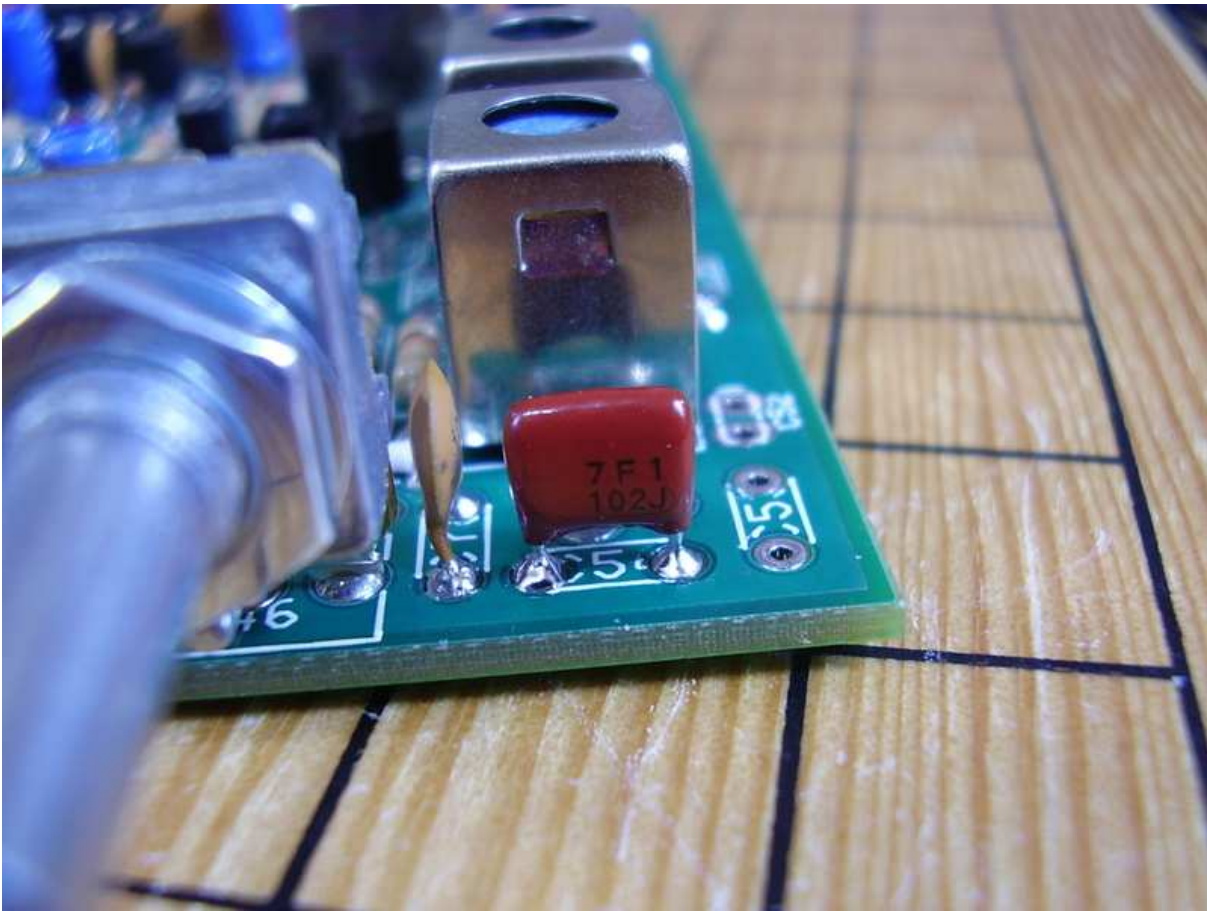

Figure 6.17: [4-14] C54 $.001\mu\text{F}$.

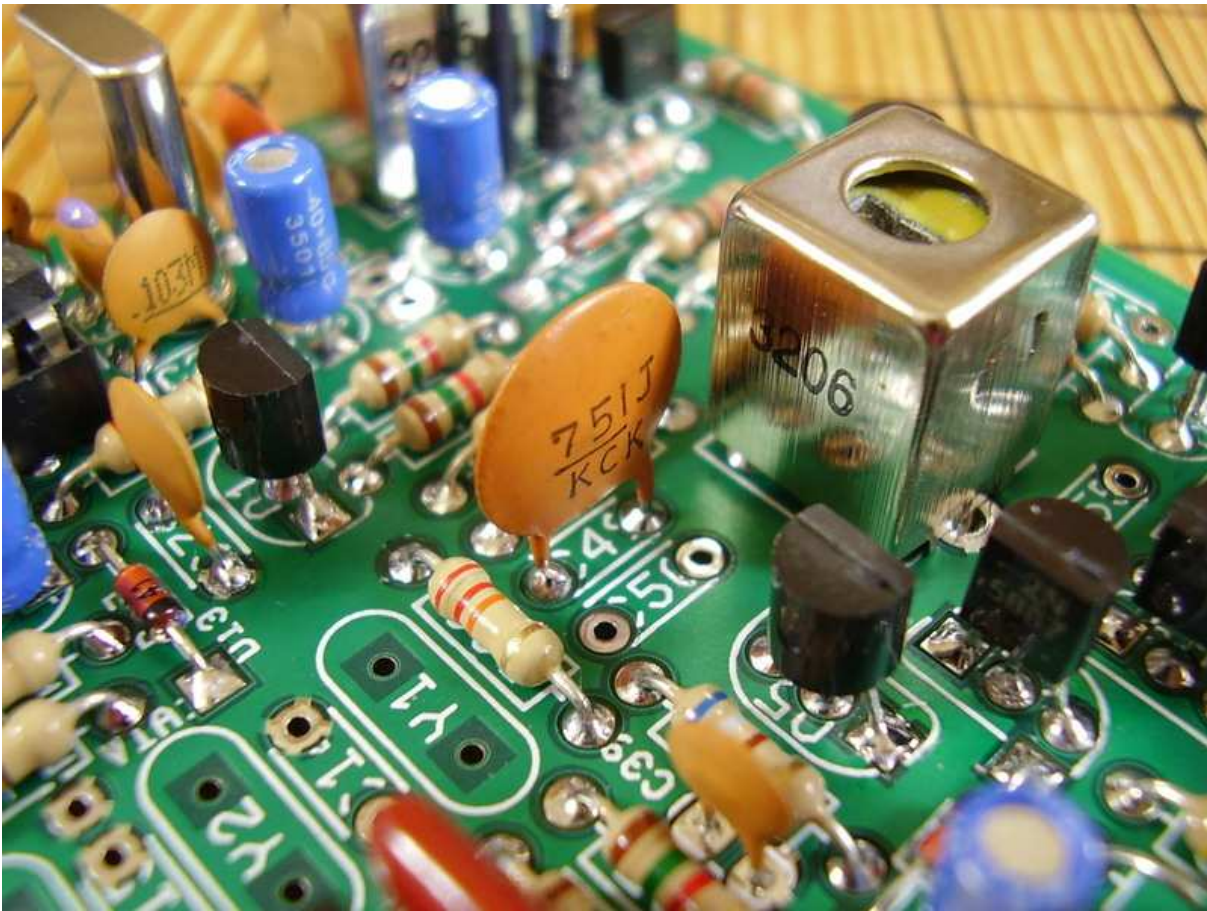

Figure 6.18: [4-15] 750pF.

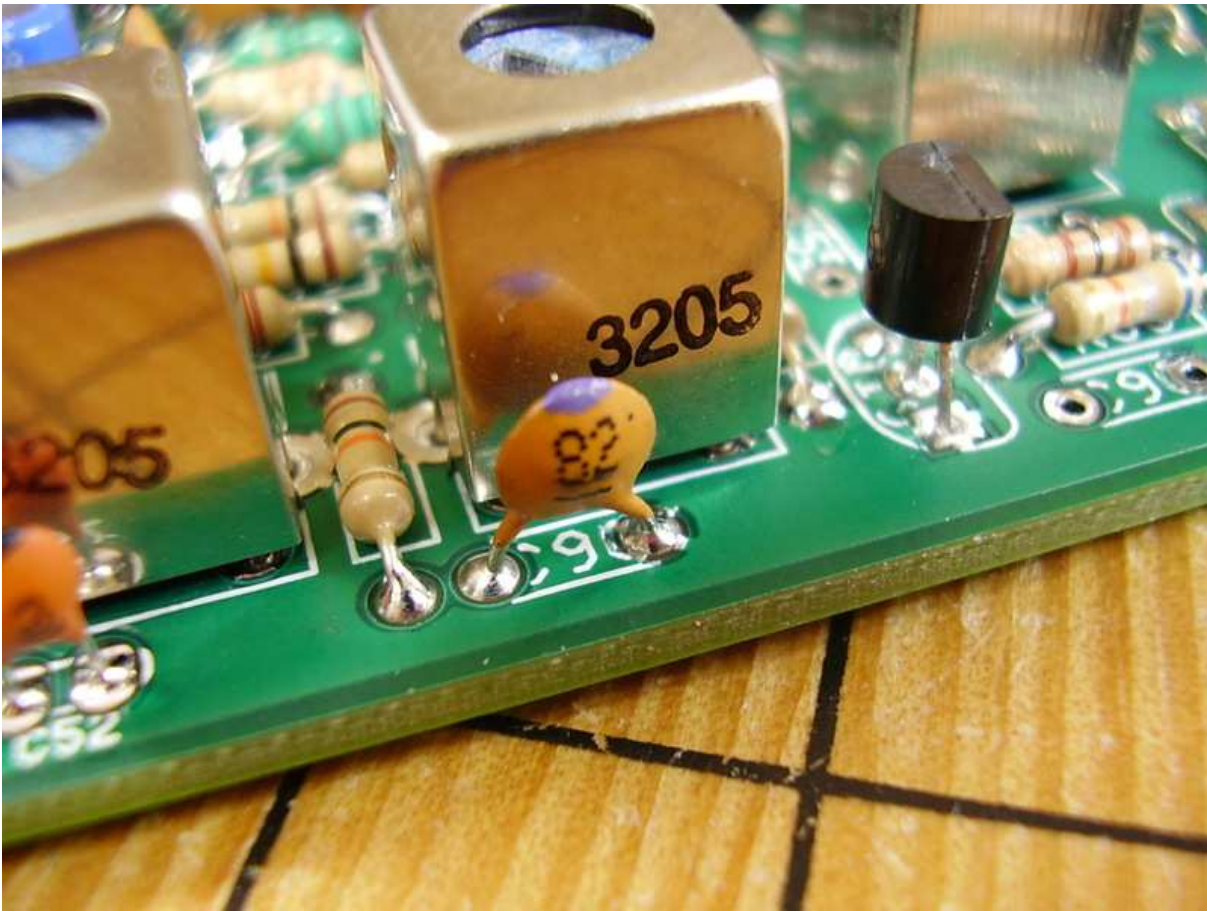

Figure 6.19: [4-17] C96 82pF.



Figure 6.20: [4-18] C50 120pF.

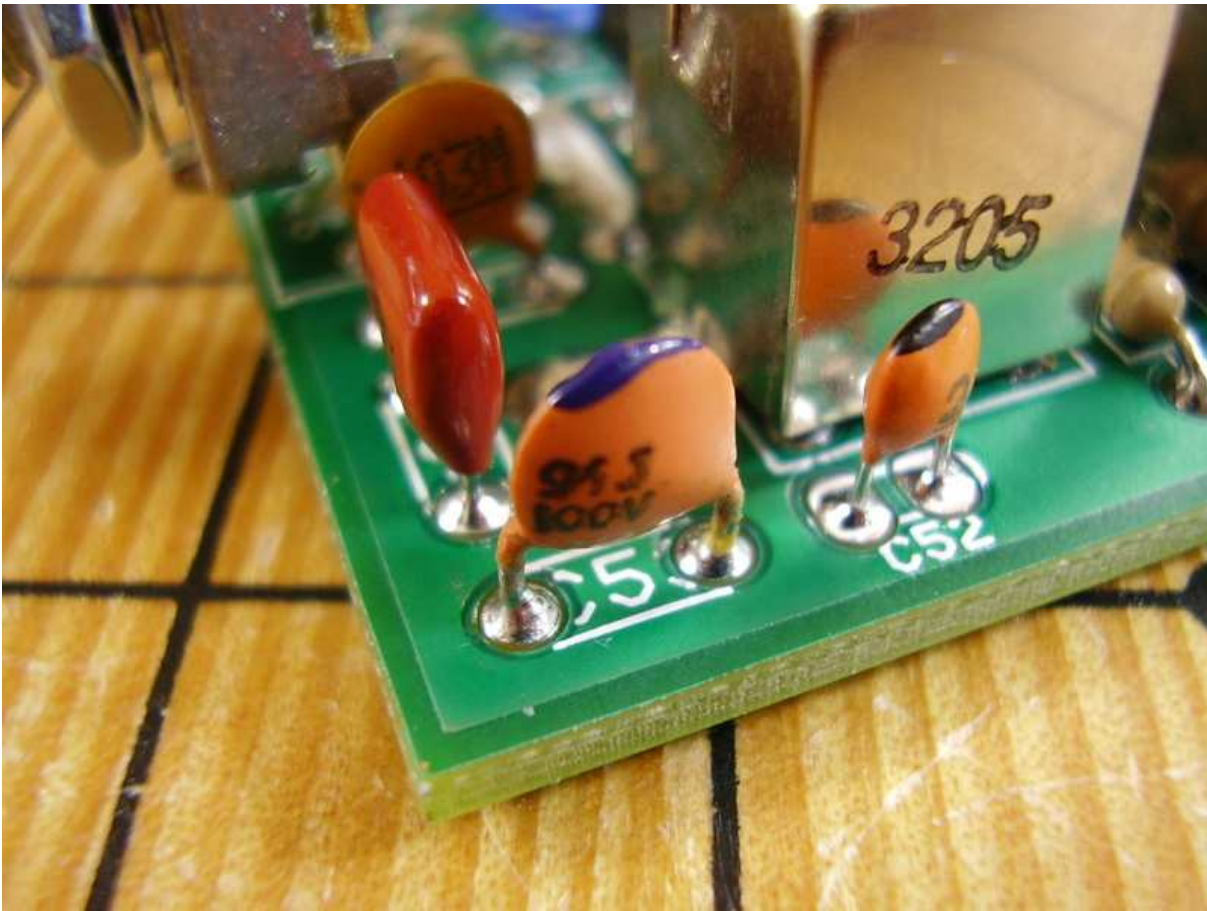

Figure 6.21: [4-19] C53 91pF.

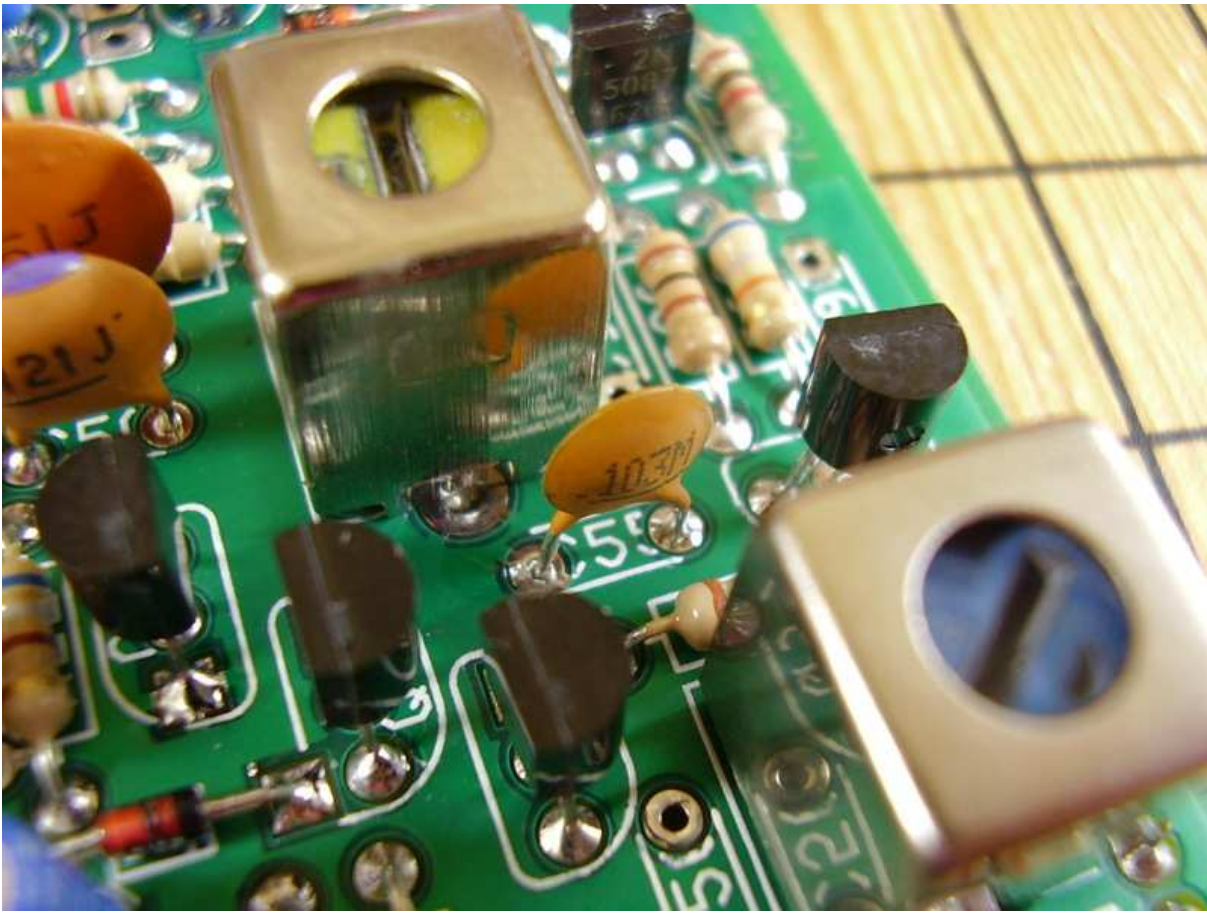

Figure 6.22: [4-20] C55 $.01\mu\text{F}$ (103).

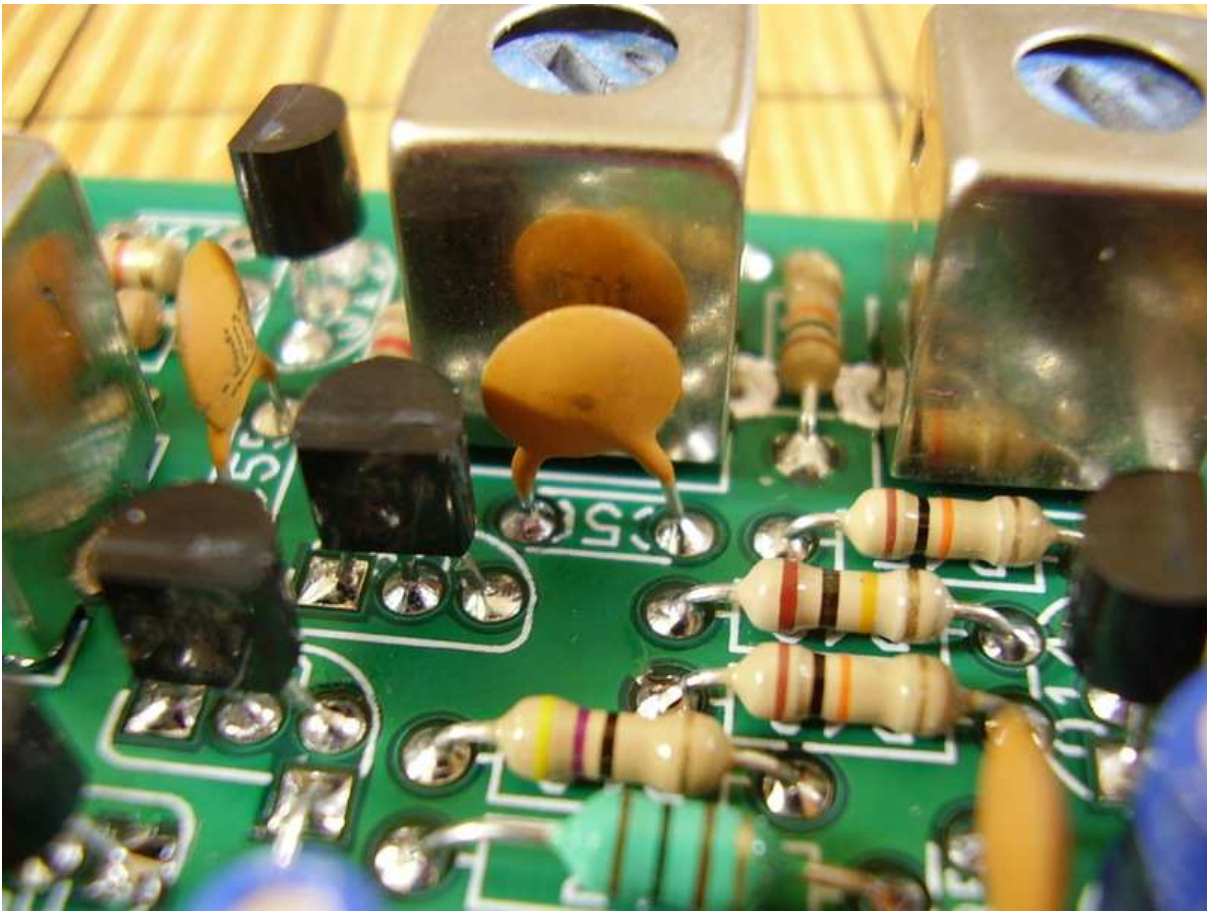

Figure 6.23: [4-21] C56 .01 μ F.

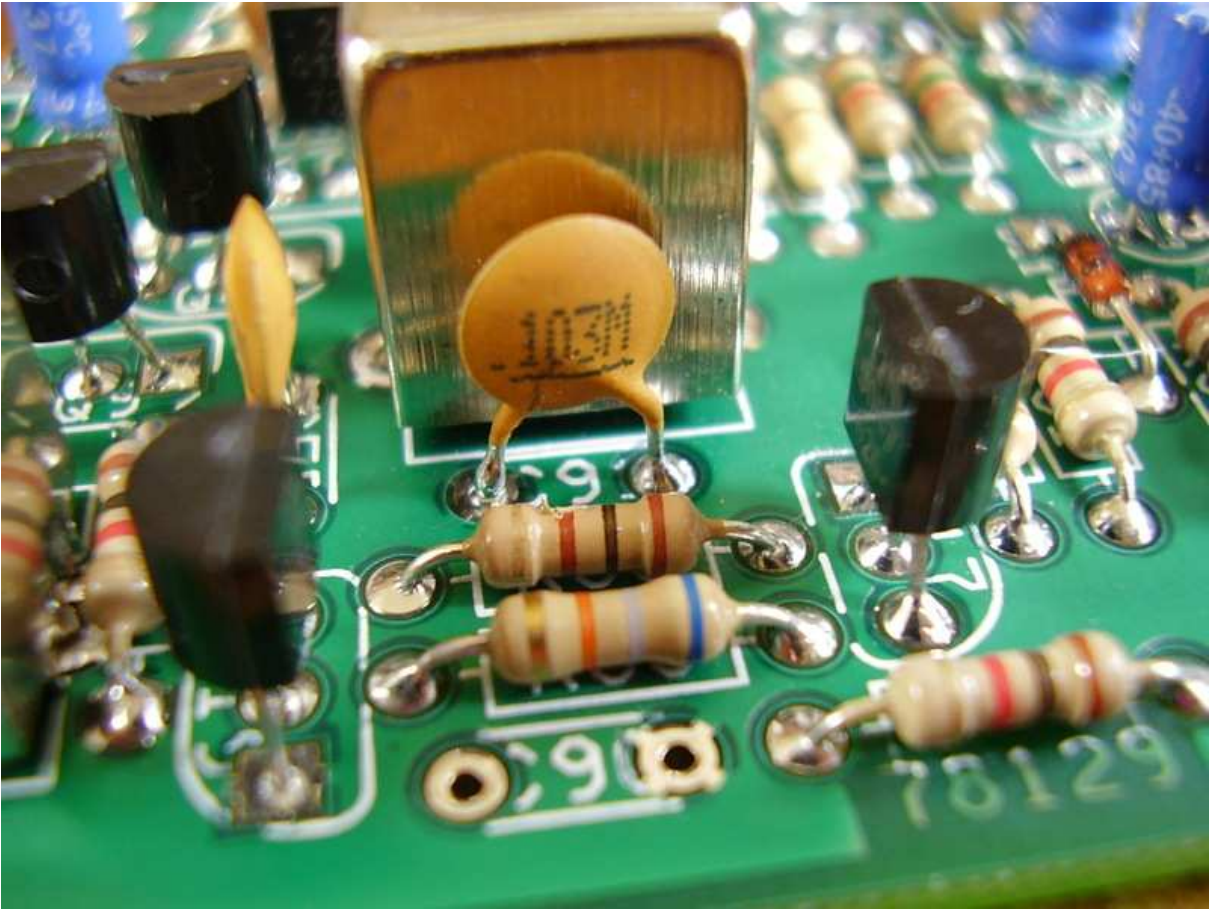

Figure 6.24: [4-22] C56 $.01\mu\text{F}$.

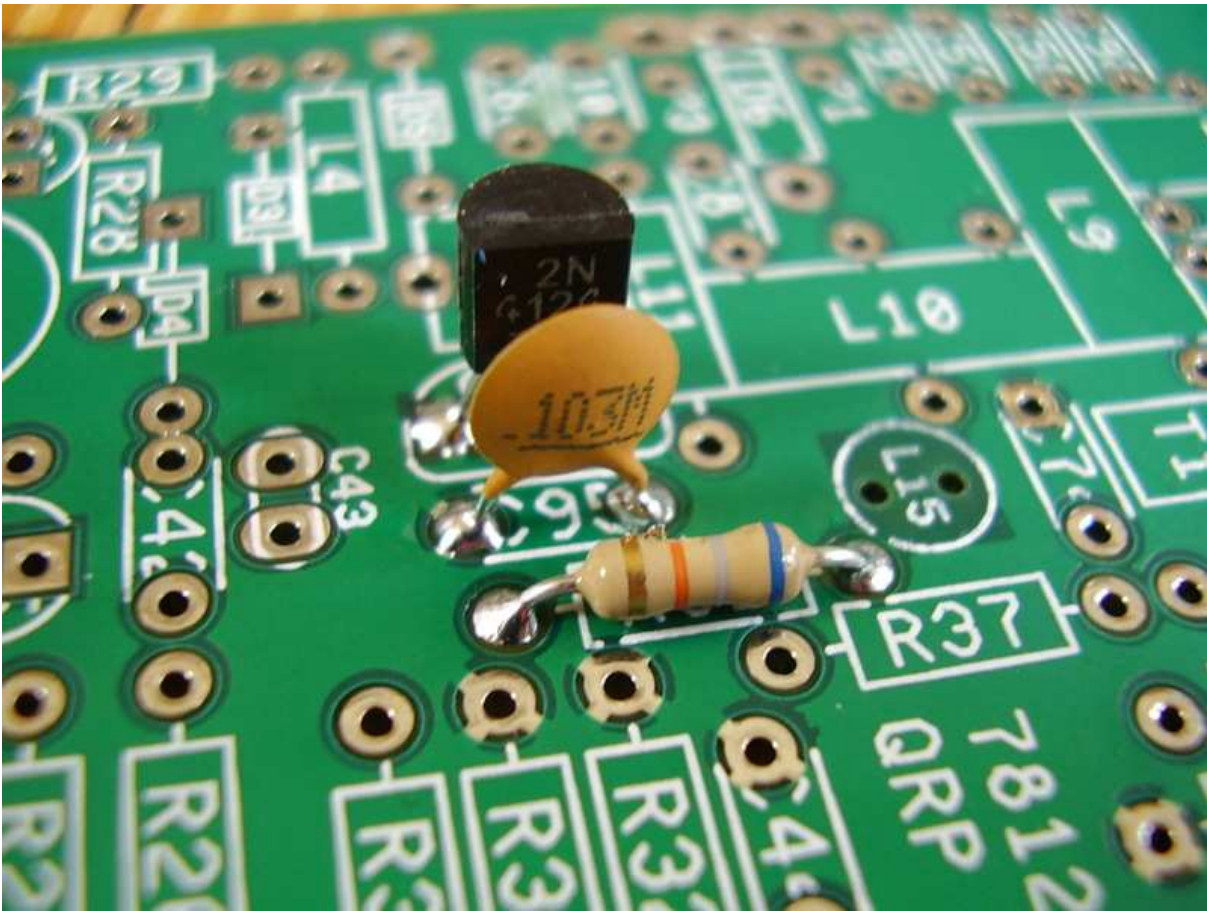

Figure 6.25: [4-23] C56 $.01\mu\text{F}$.

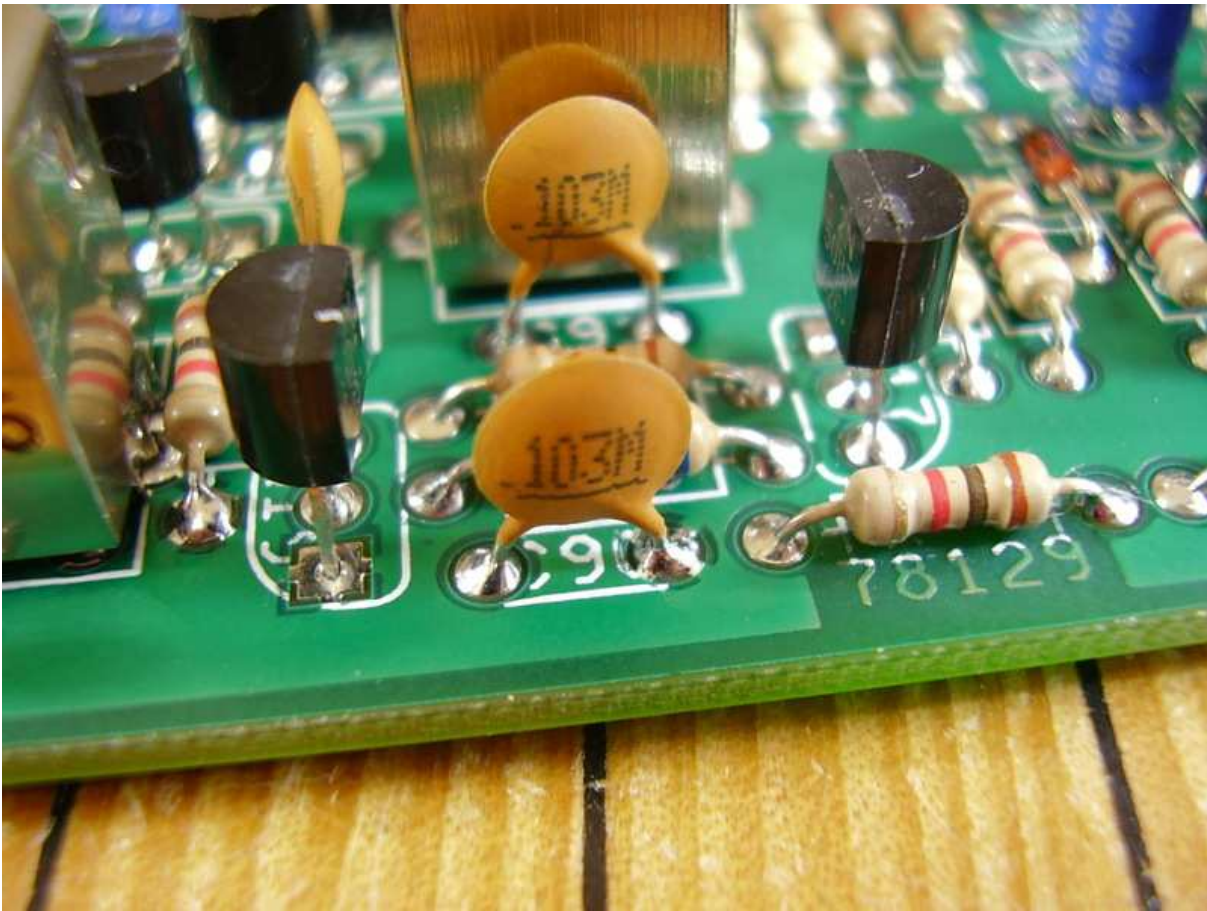

Figure 6.26: [4-24] C56 $.01\mu\text{F}$.

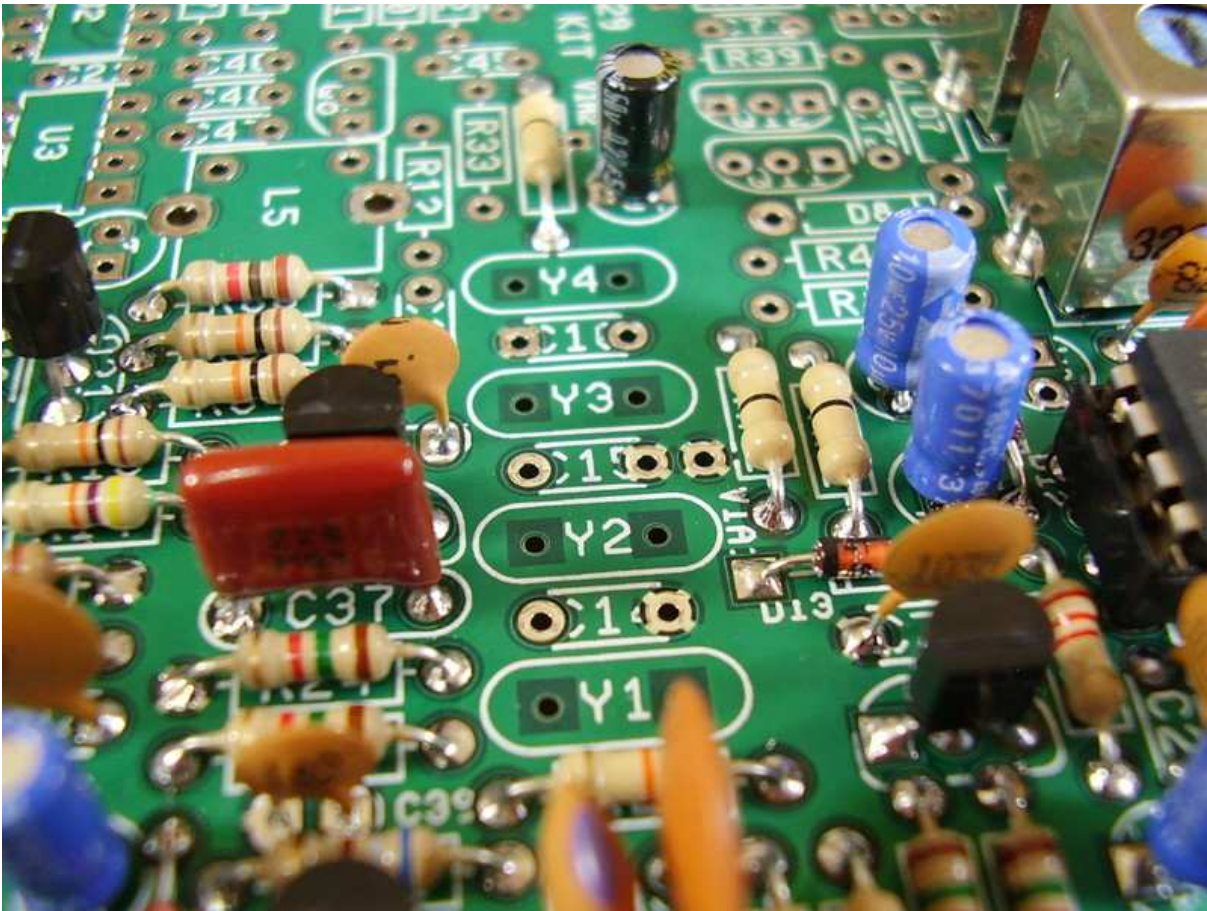

Figure 6.27: Crystal Filter Area of Board.

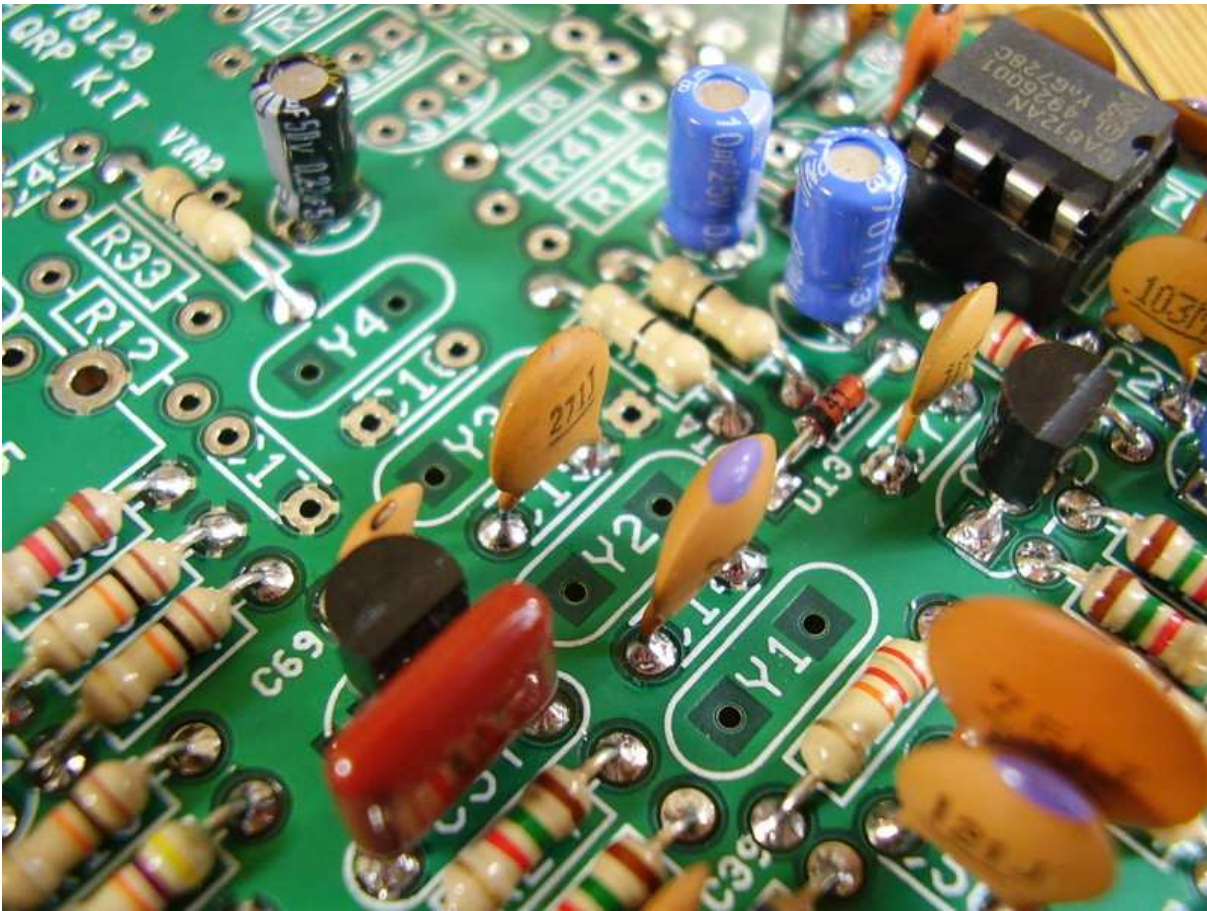

Figure 6.29: [4-31] C15 270pF (271).

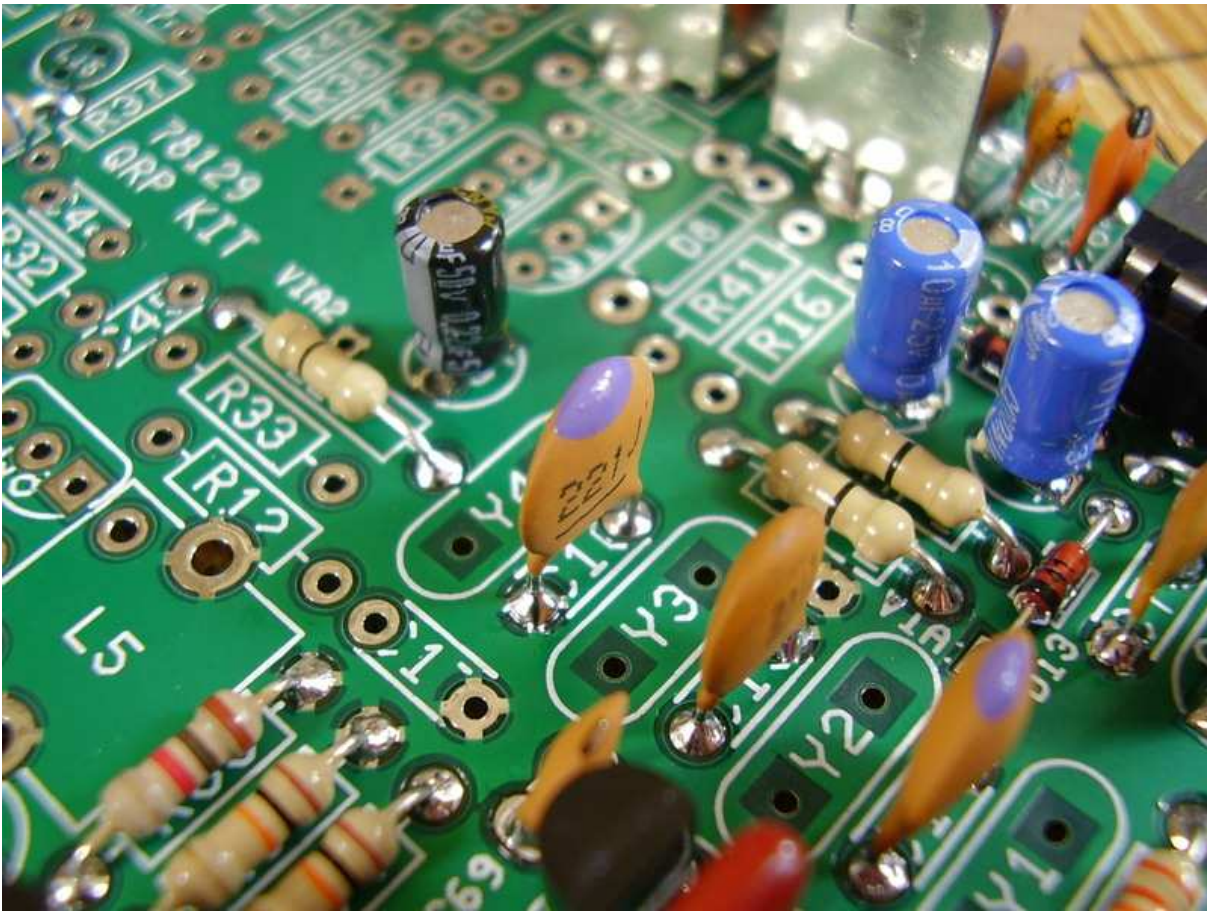

Figure 6.30: [4-32] C16 220pF (221).



Figure 6.31: [4-33] [4-26] C17 68pF and Y1 14.31818MHz Crystal.

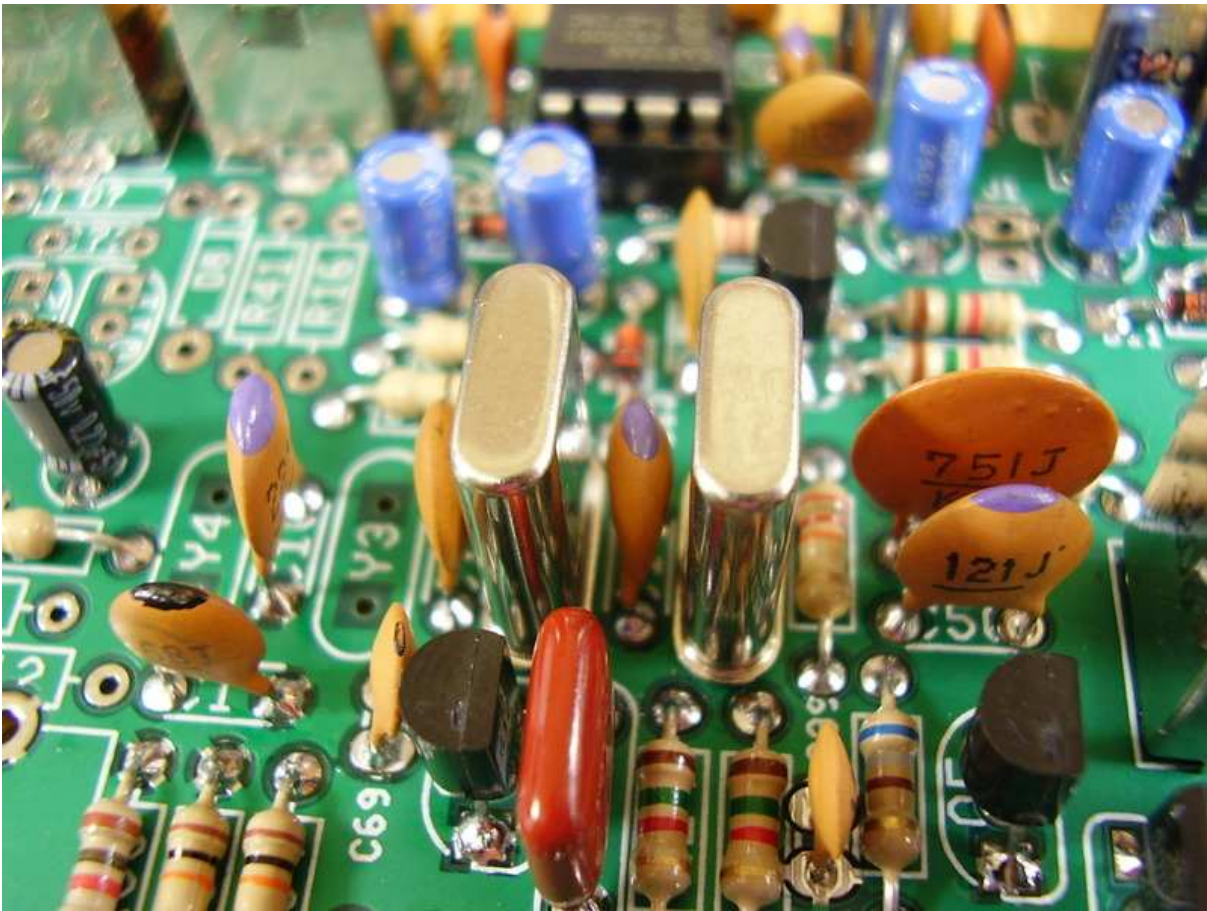

Figure 6.32: [4-27] Y2 14.31818MHz Crystal.

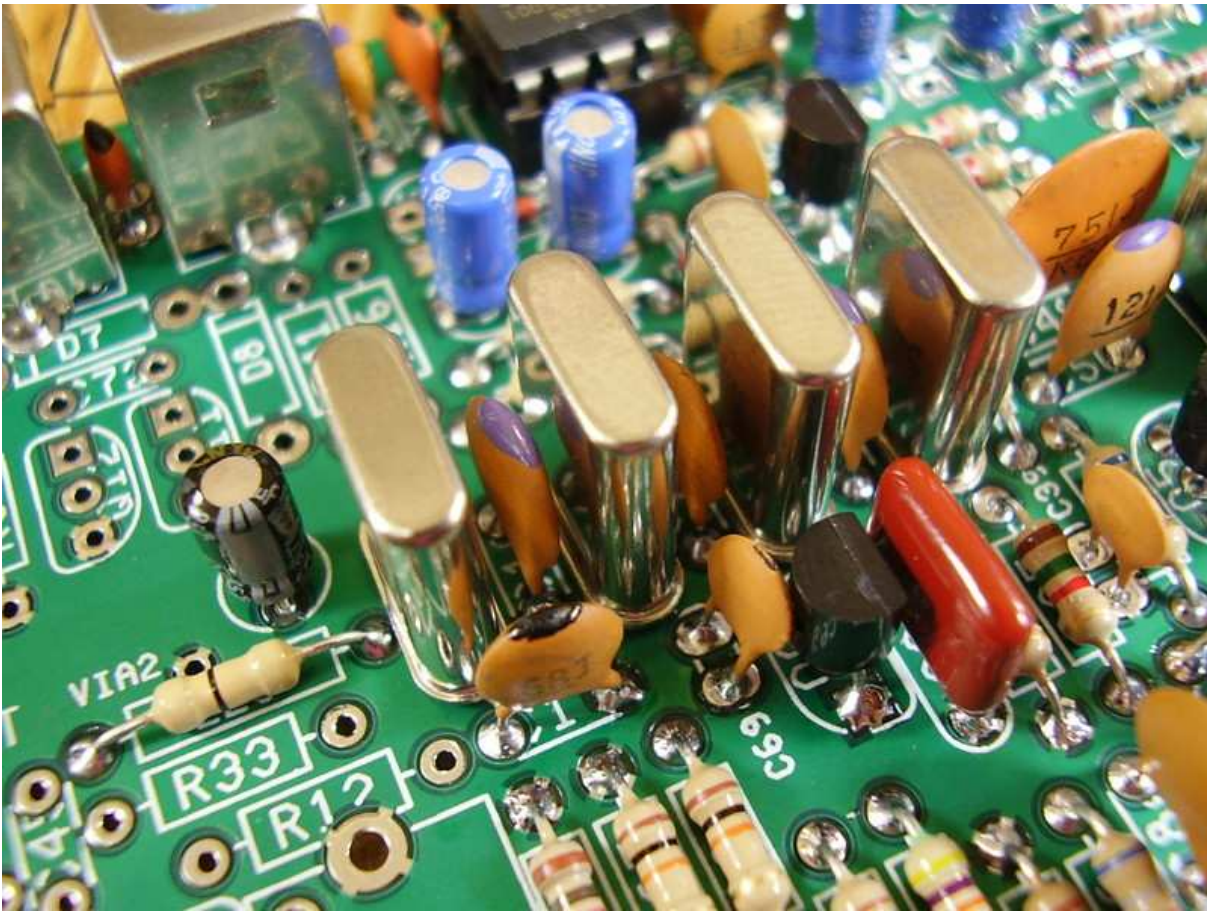

Figure 6.33: [4-28] [4-29] Y3 and Y4 14.318MHz Crystals.

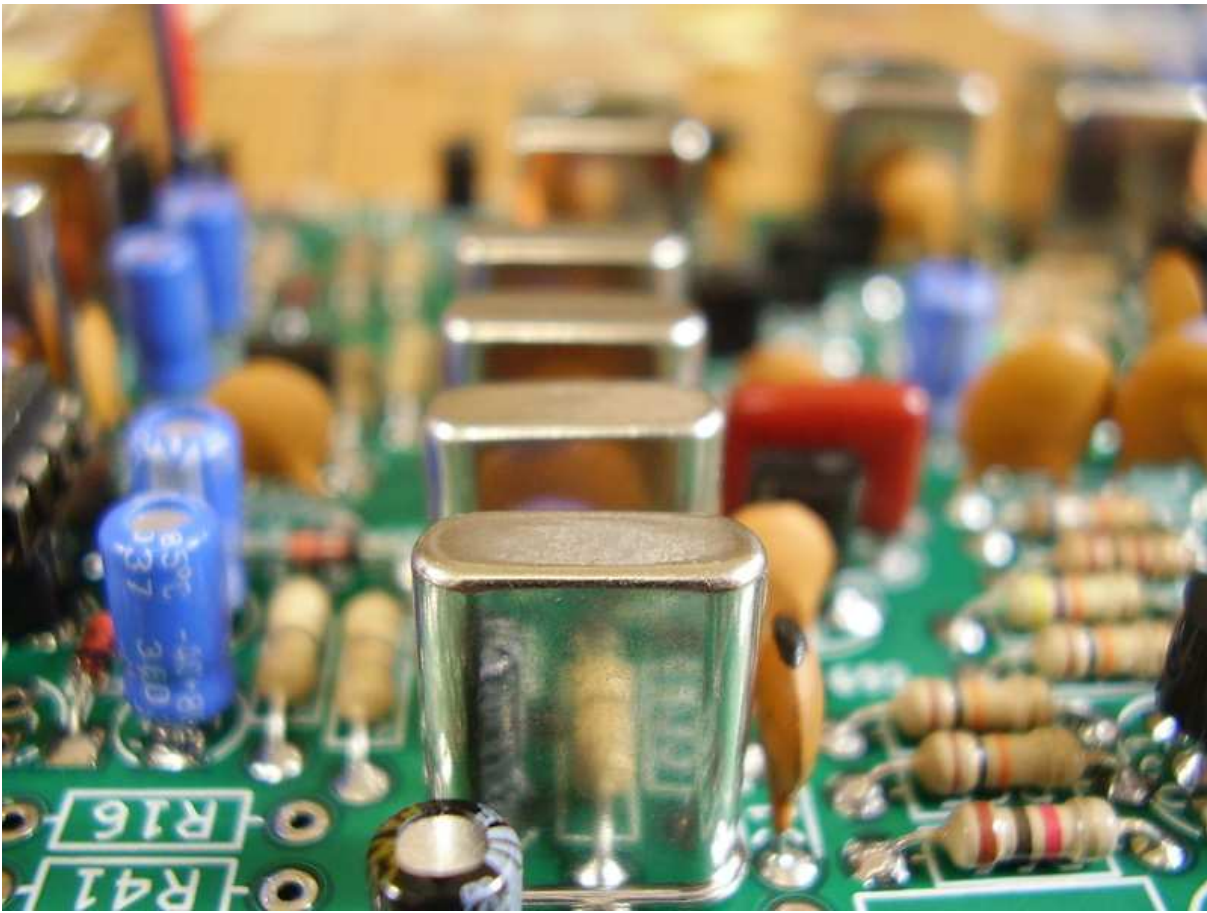

Figure 6.34: View of Crystal Filter.

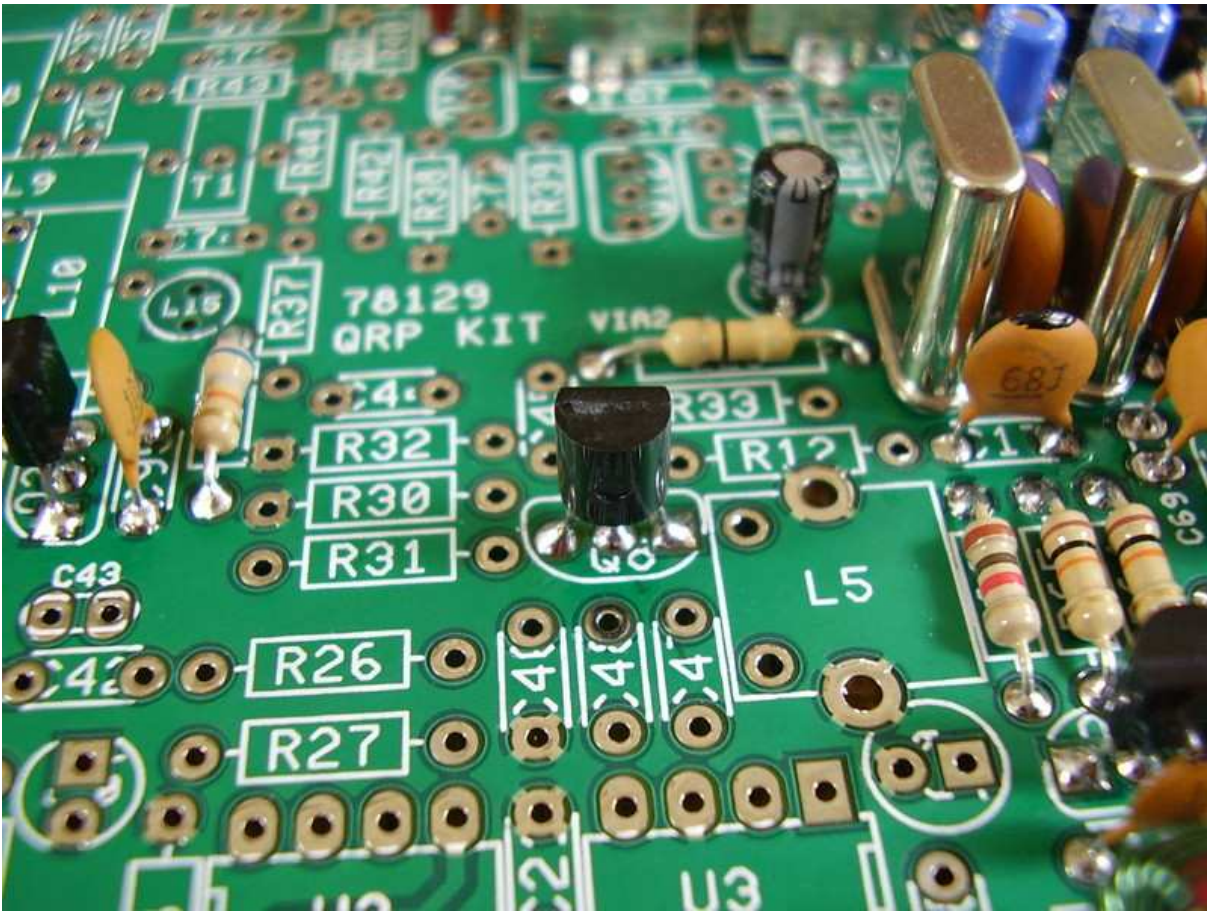

Figure 6.35: [4-34] Q8 2N4124.

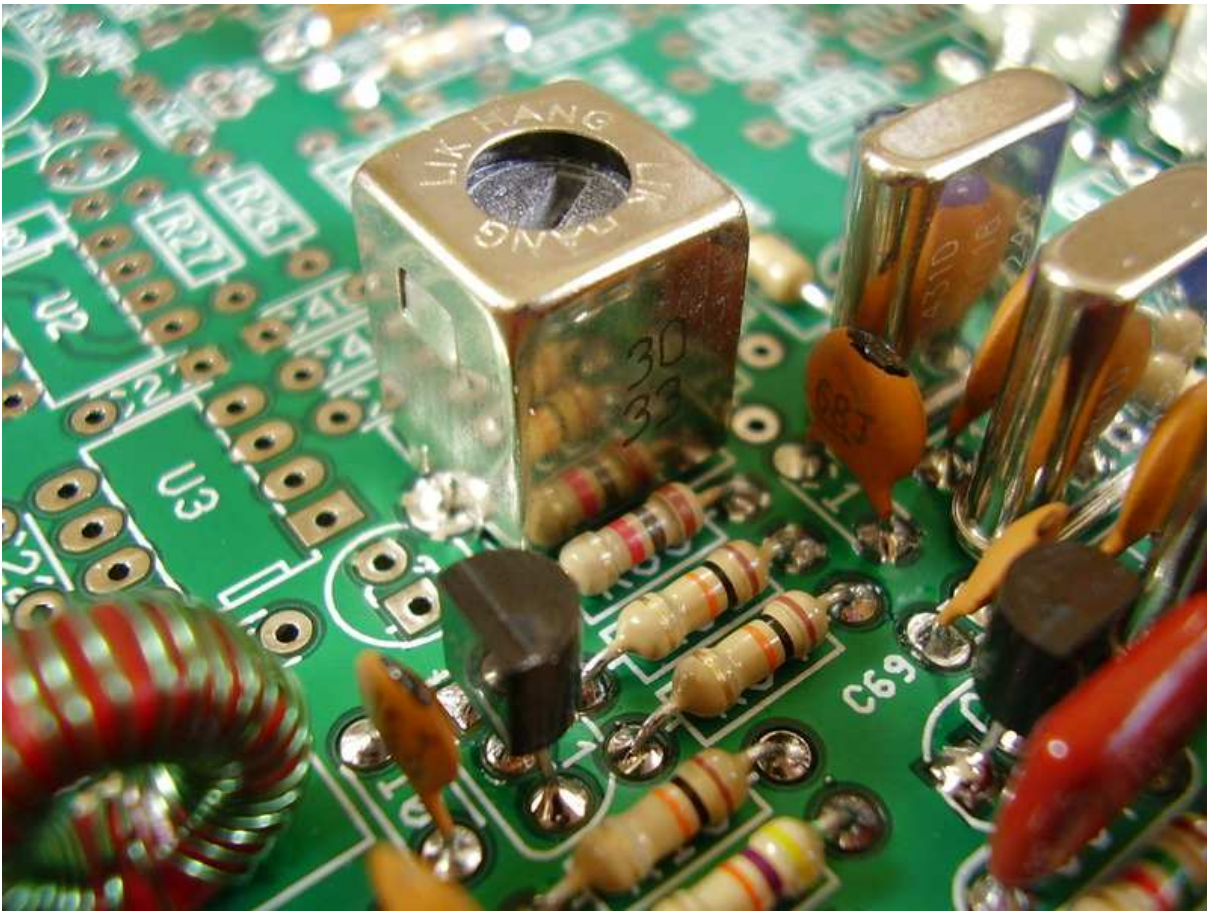

Figure 6.36: [4-35] L5 5.8 μ H (30-33).

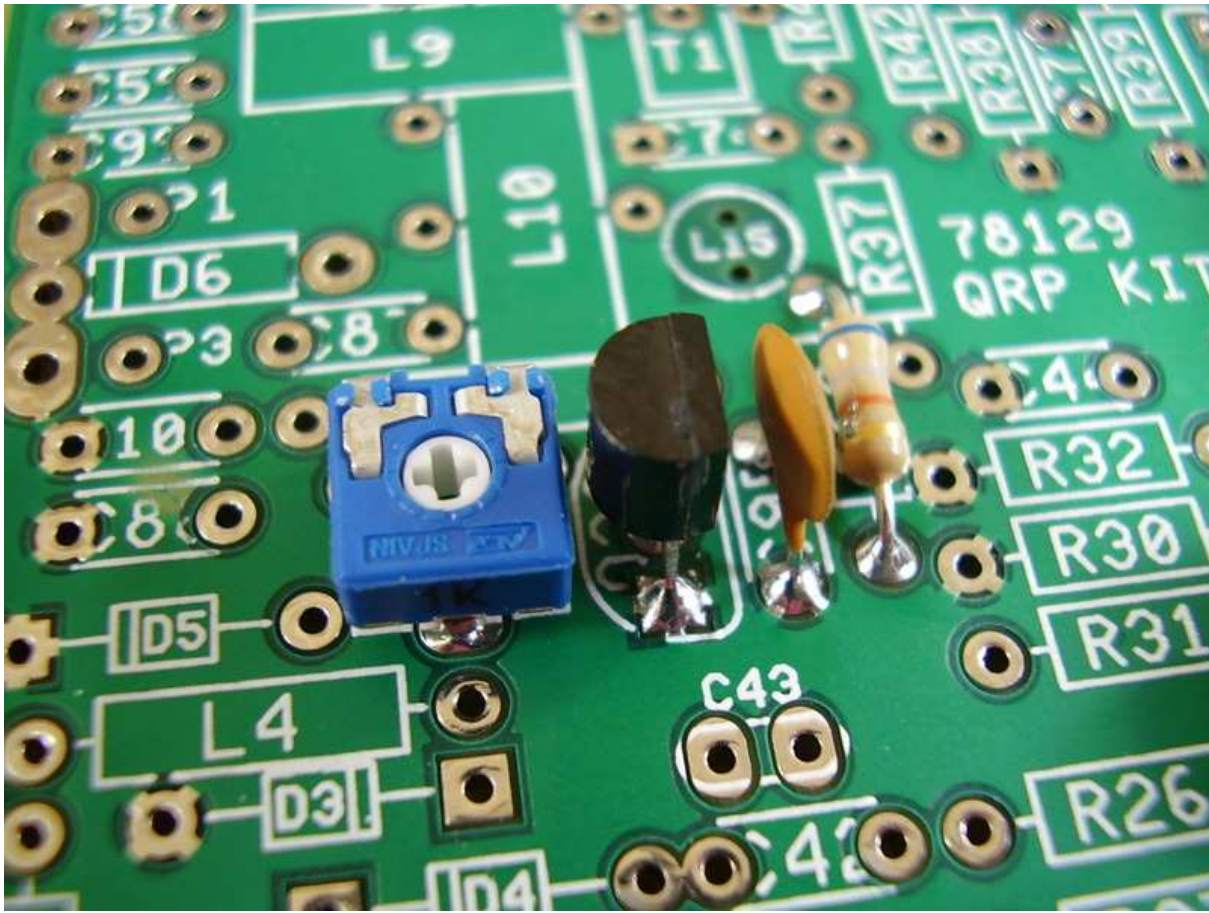

Figure 6.37: [4-36] R61 1K Trimmer.

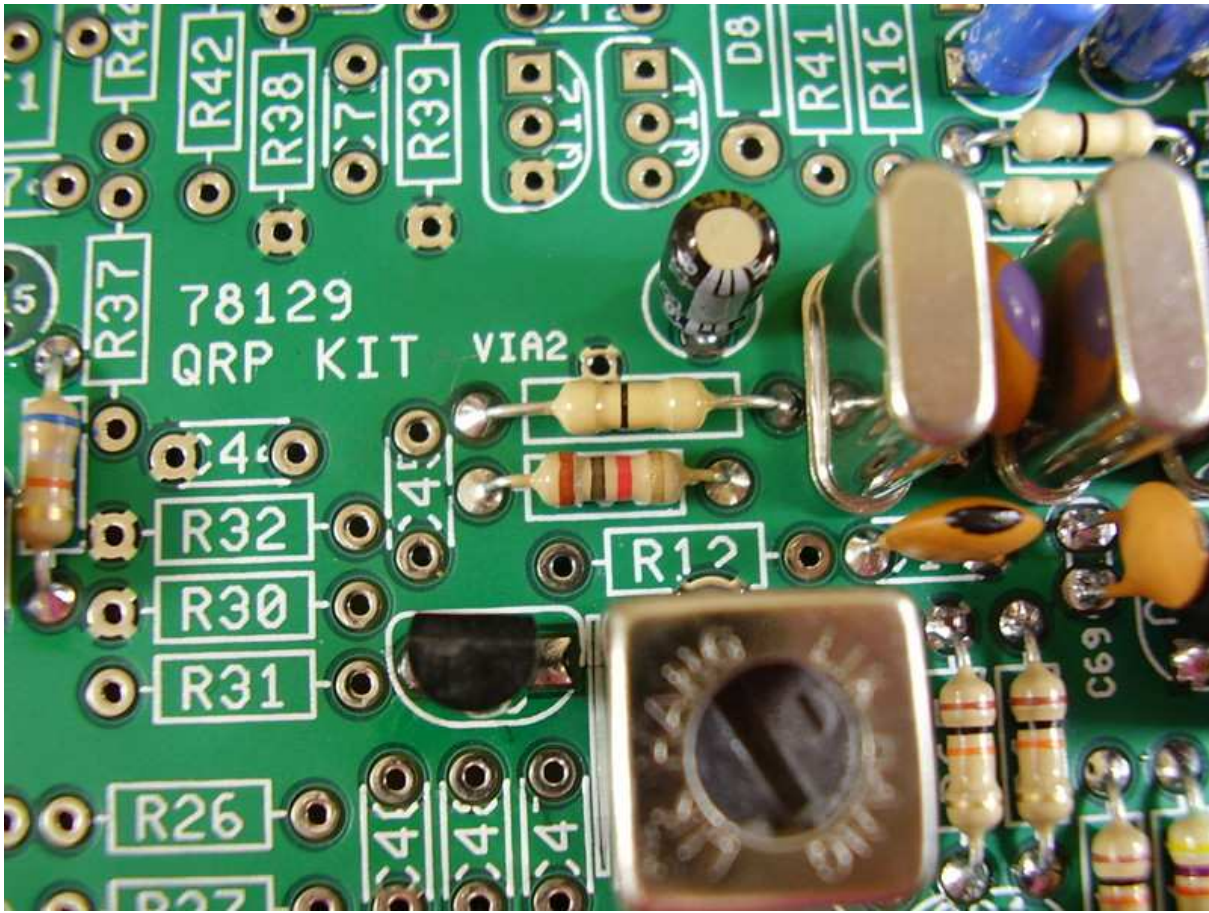

Figure 6.38: [4-37] R33 1K.

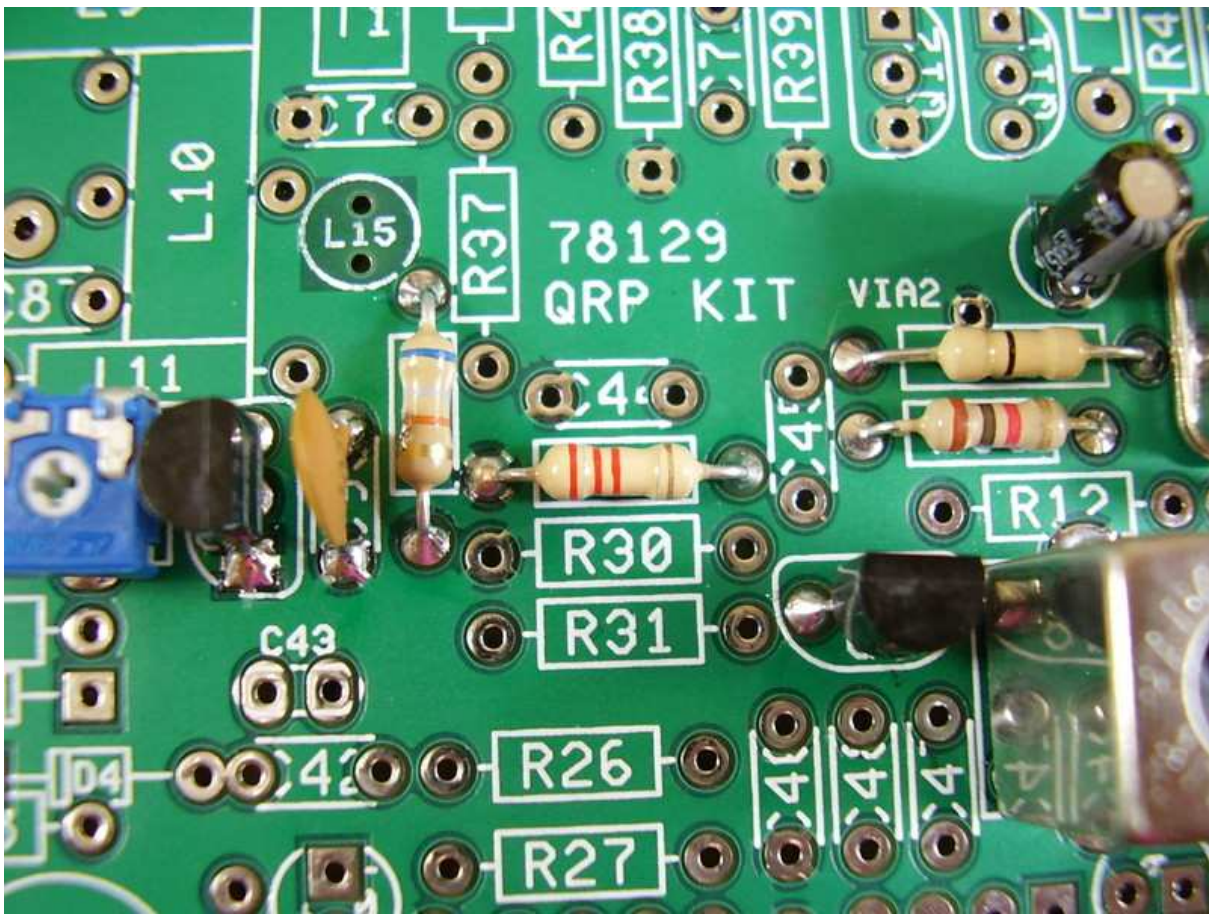

Figure 6.39: [4-38] R32 2.2K.

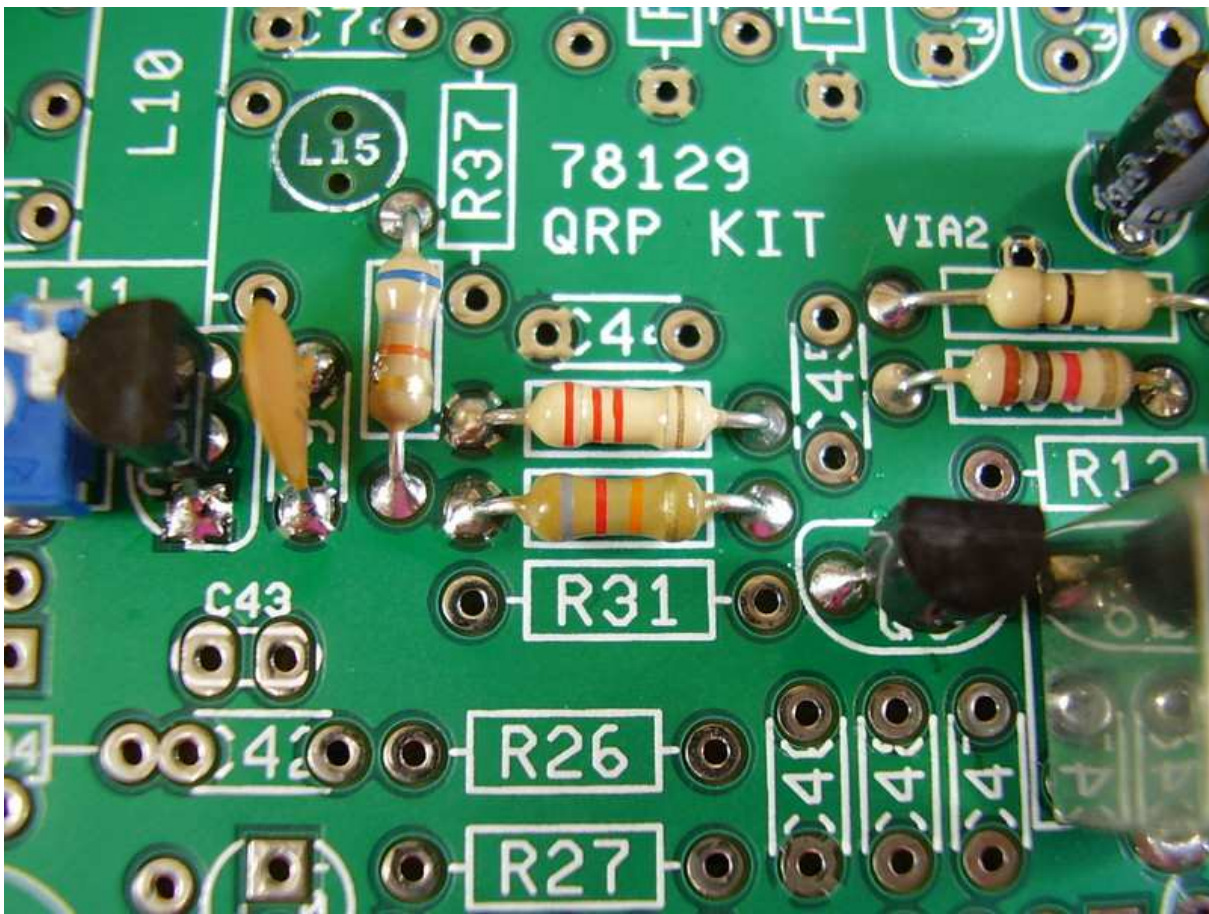

Figure 6.40: [4-39] R30 82K.

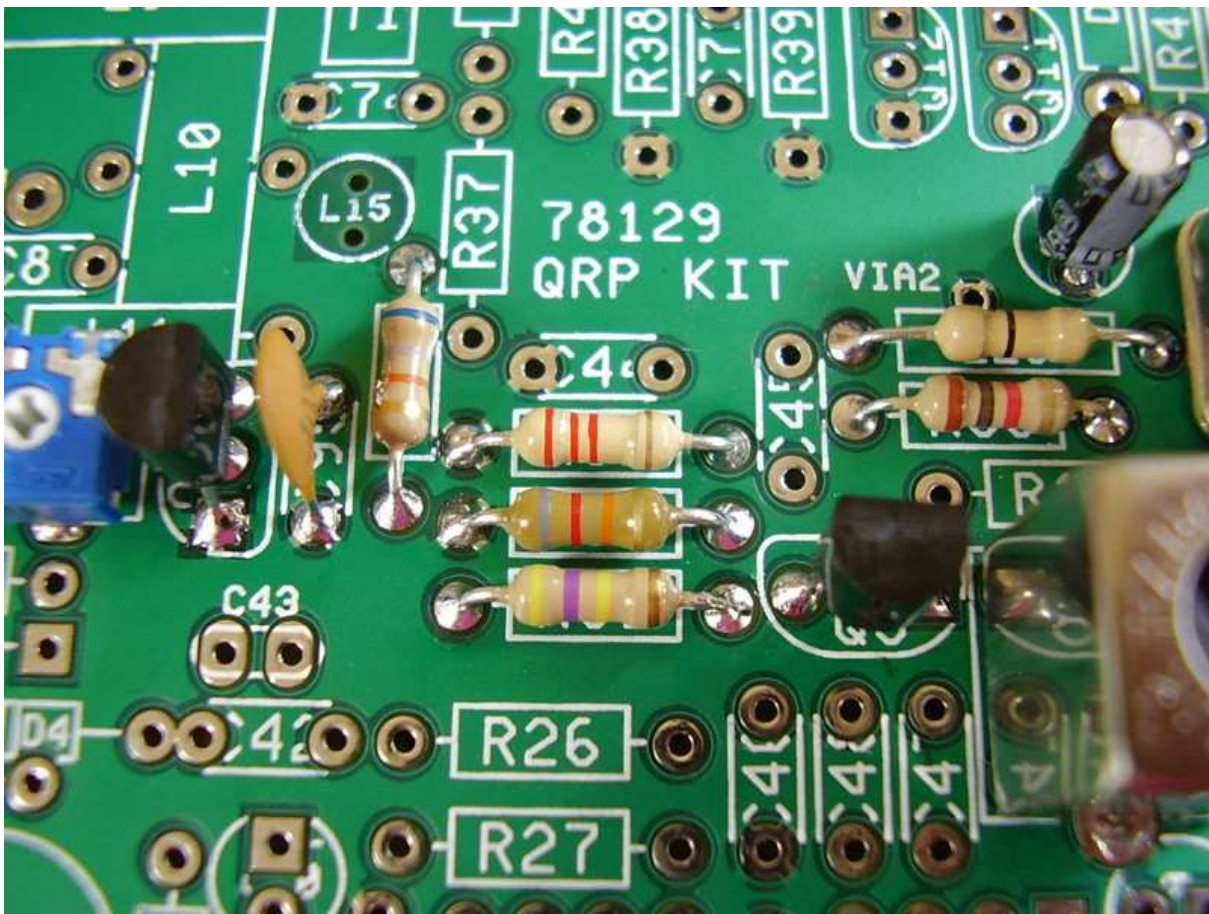

Figure 6.41: [4-40] R31 470K.

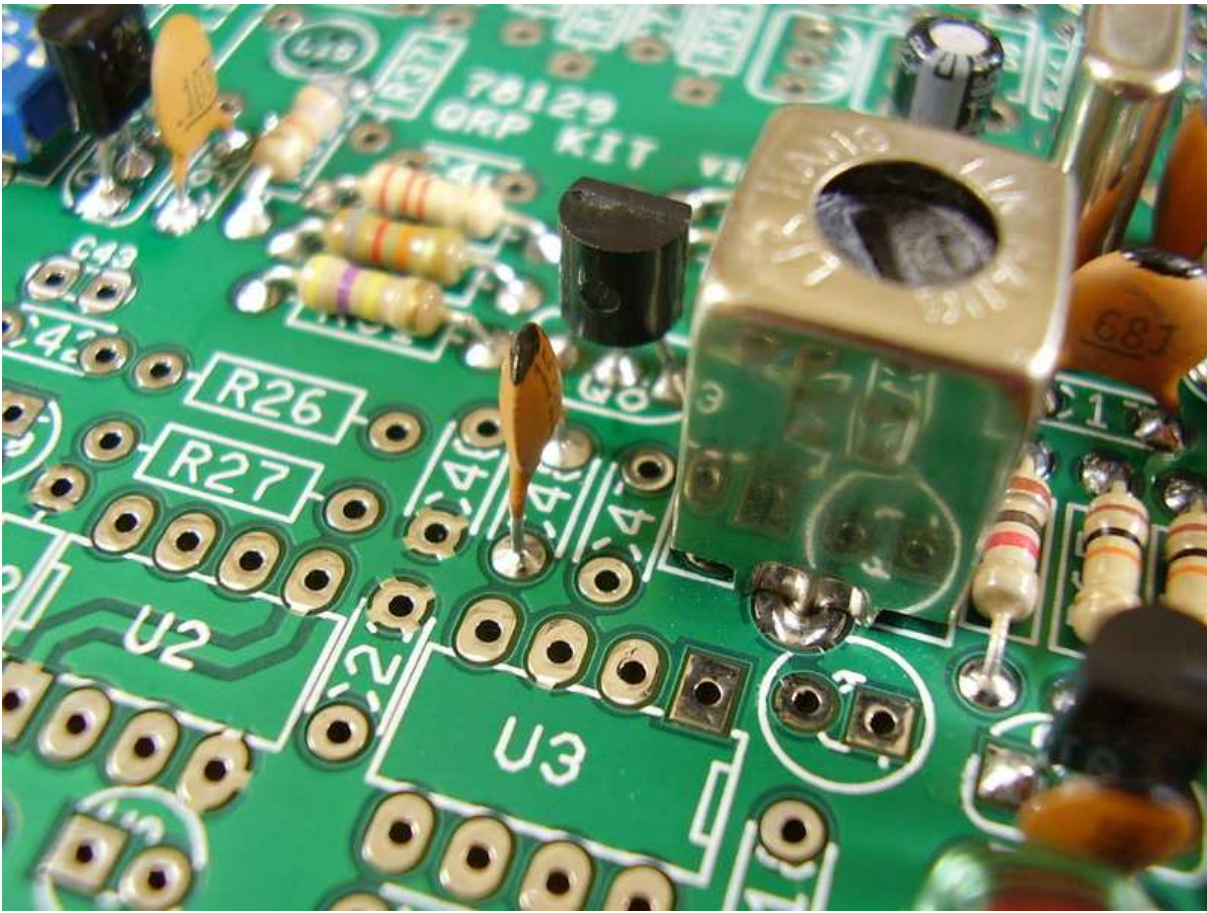

Figure 6.42: [4-41] C48 15pF.

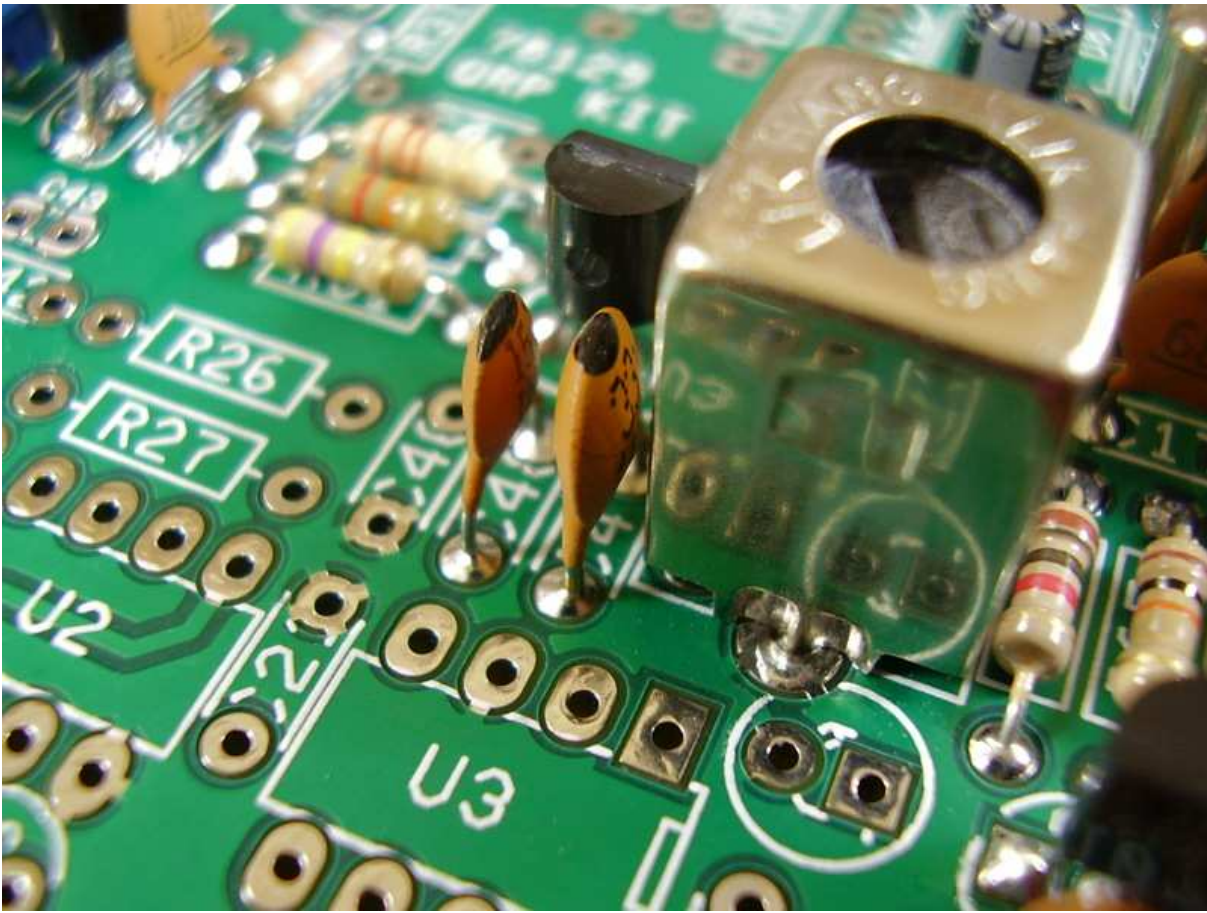

Figure 6.43: [4-42] C47 33pF.

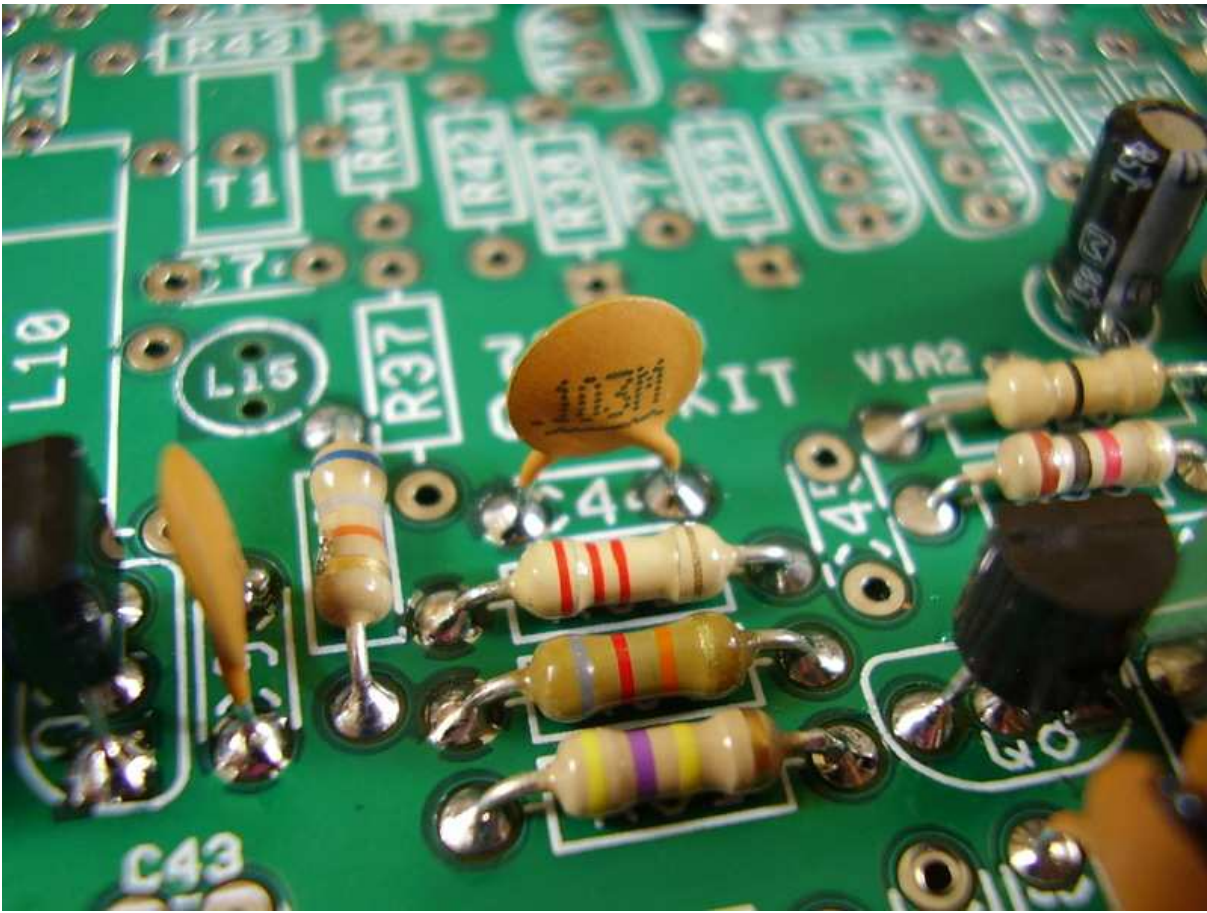

Figure 6.44: [4-43] C44 $.01\mu\text{F}$.

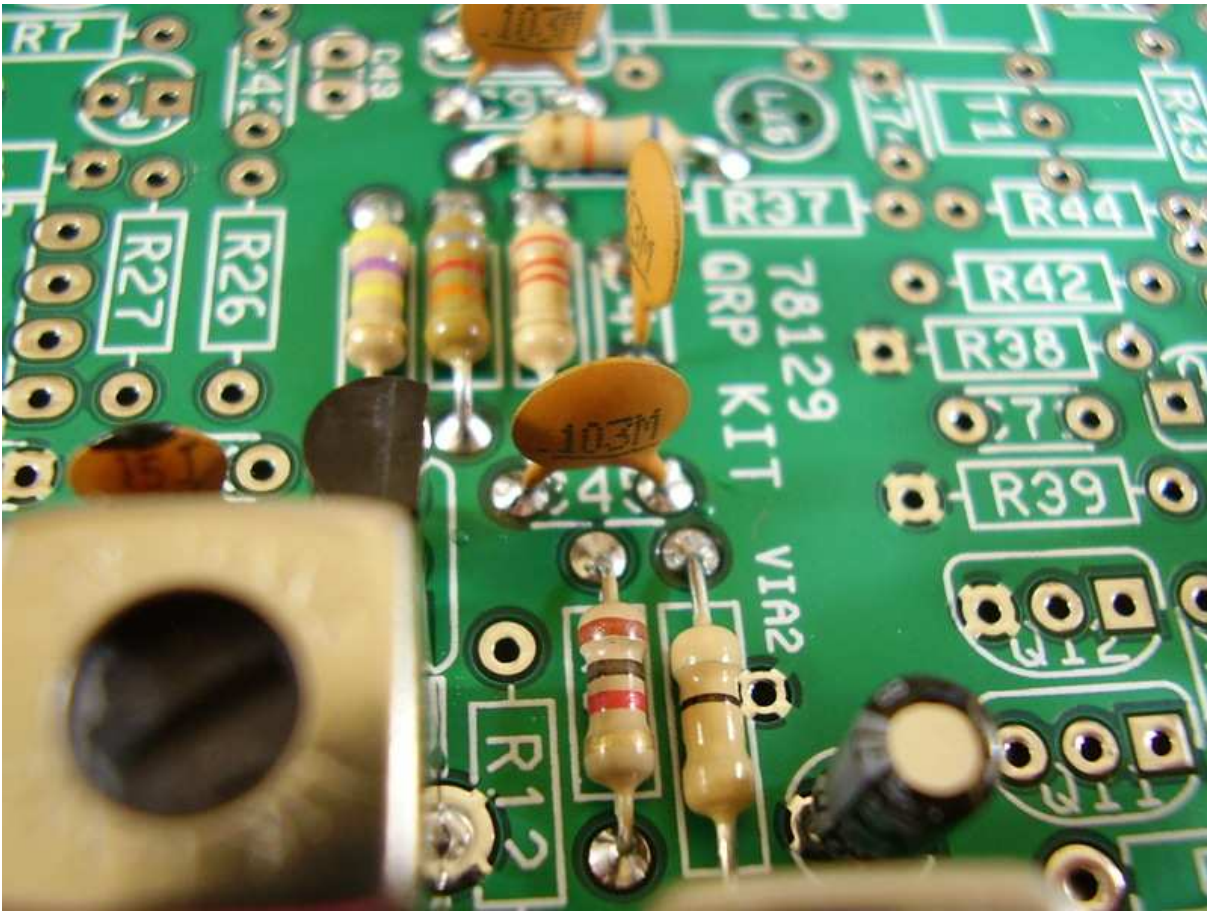

Figure 6.45: [4-44] C45 .01 μ F.

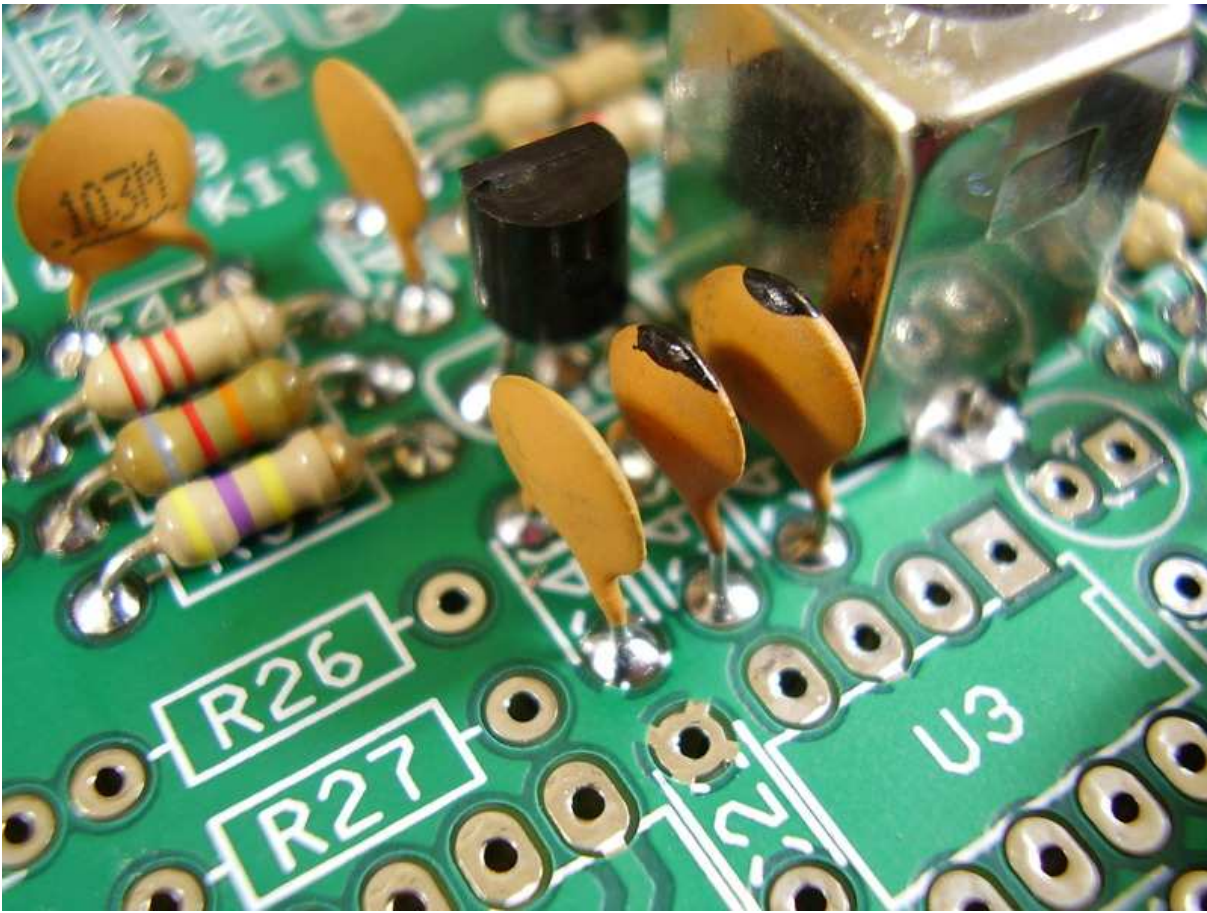

Figure 6.46: [4-45] C46 $.01\mu\text{F}$.

Chapter 7

Phase 5.0 - Receiver BFO and Audio Amp Stages

This phase involves the assembly of the receiver BFO and audio amplifier stages of the transceiver.



Figure 7.1: [5-2] R12 2.2K.

This is one of those times that I did not photograph the actual installation for some unknown reason.

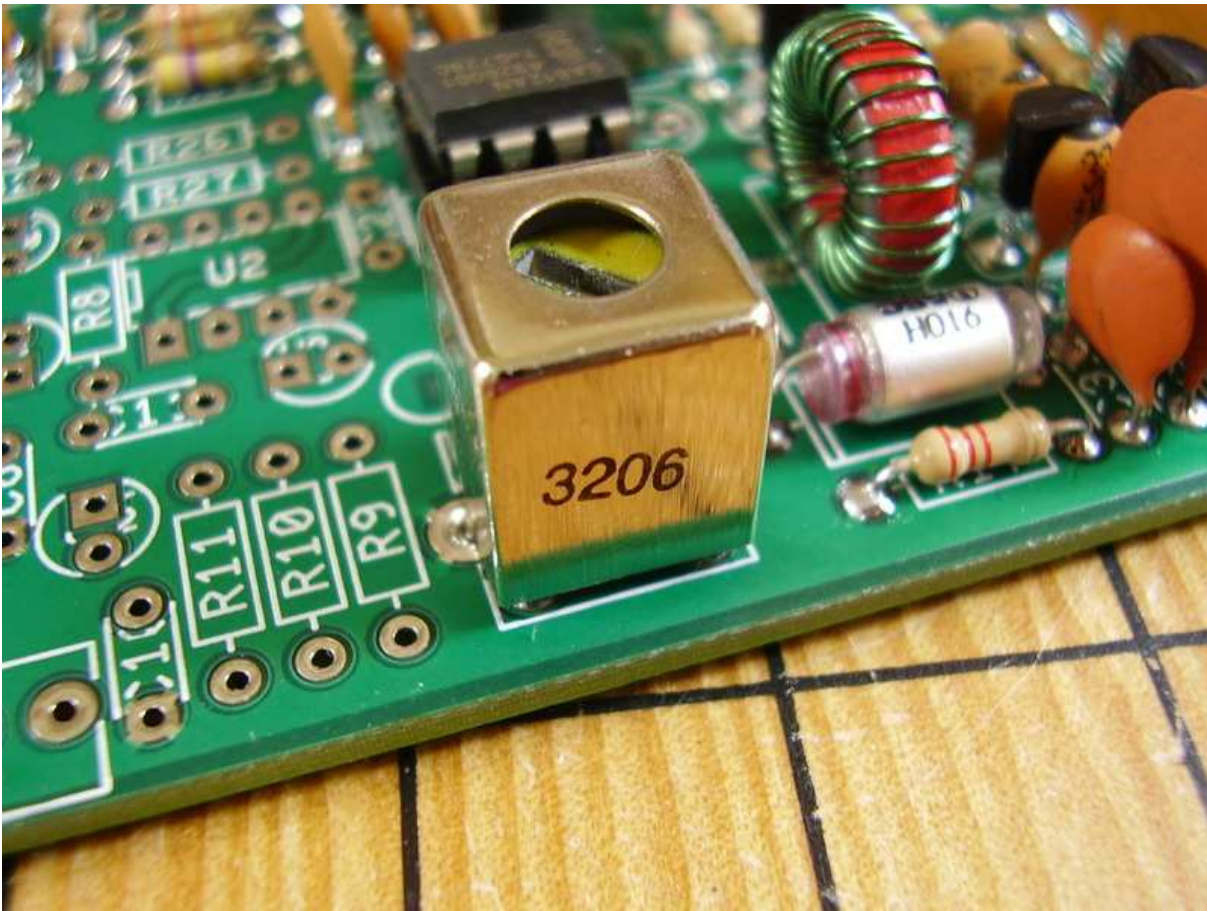

Figure 7.2: [5-3] L1 $1.3\mu\text{H}$ (3206).

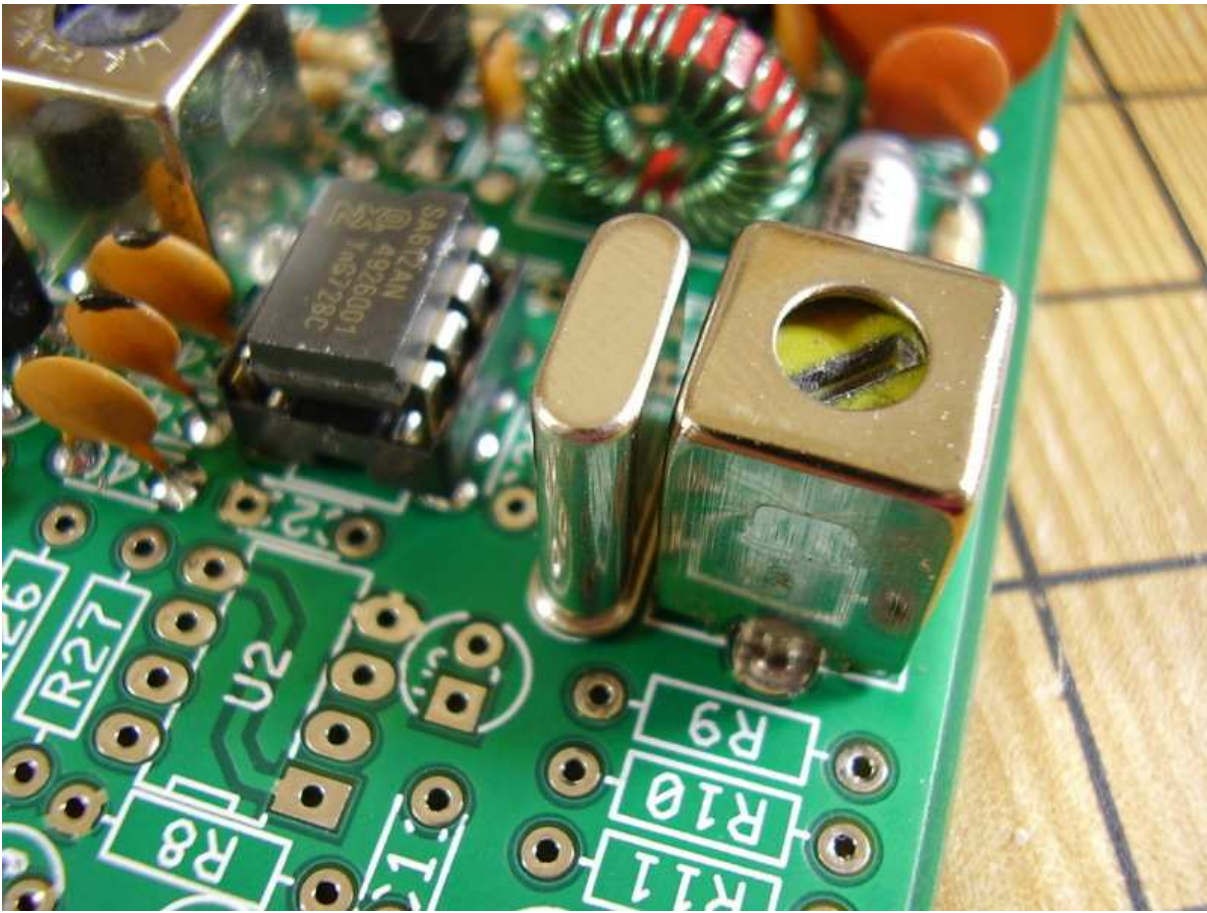

Figure 7.3: [5-4] Y5 14.31818MHz Crystal.

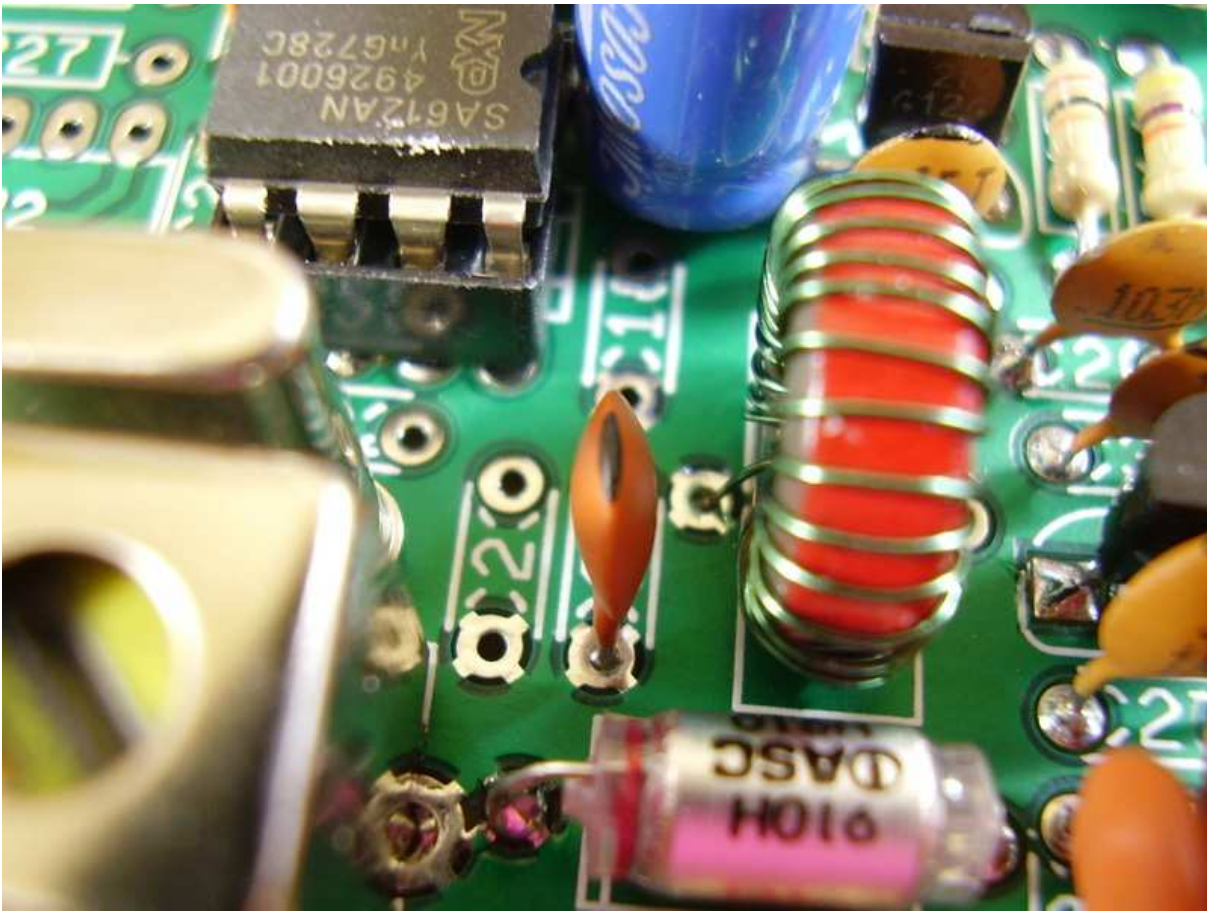

Figure 7.4: [5-5] C19 100 μ F.

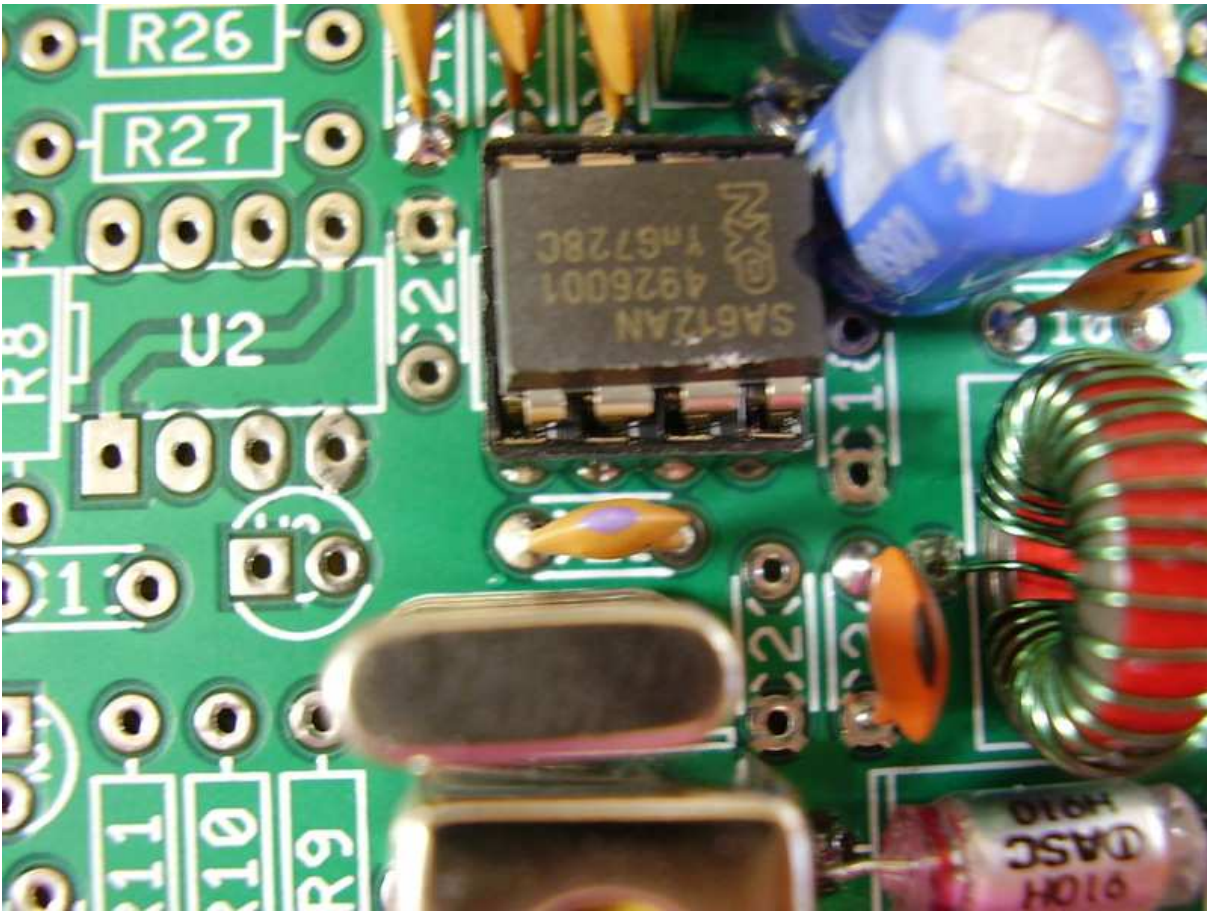

Figure 7.5: [5-6] C24 56pF.

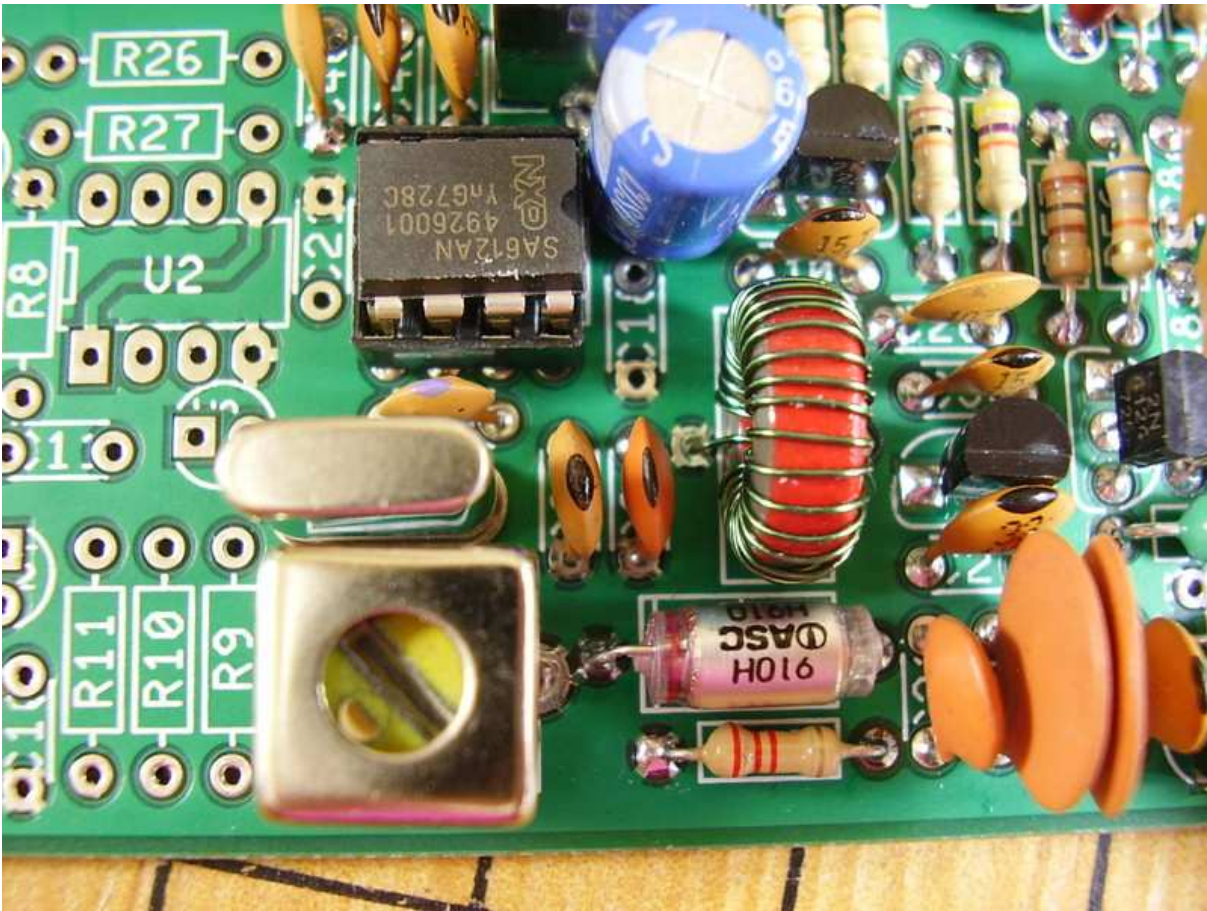

Figure 7.6: [5-7] C22 47pF.

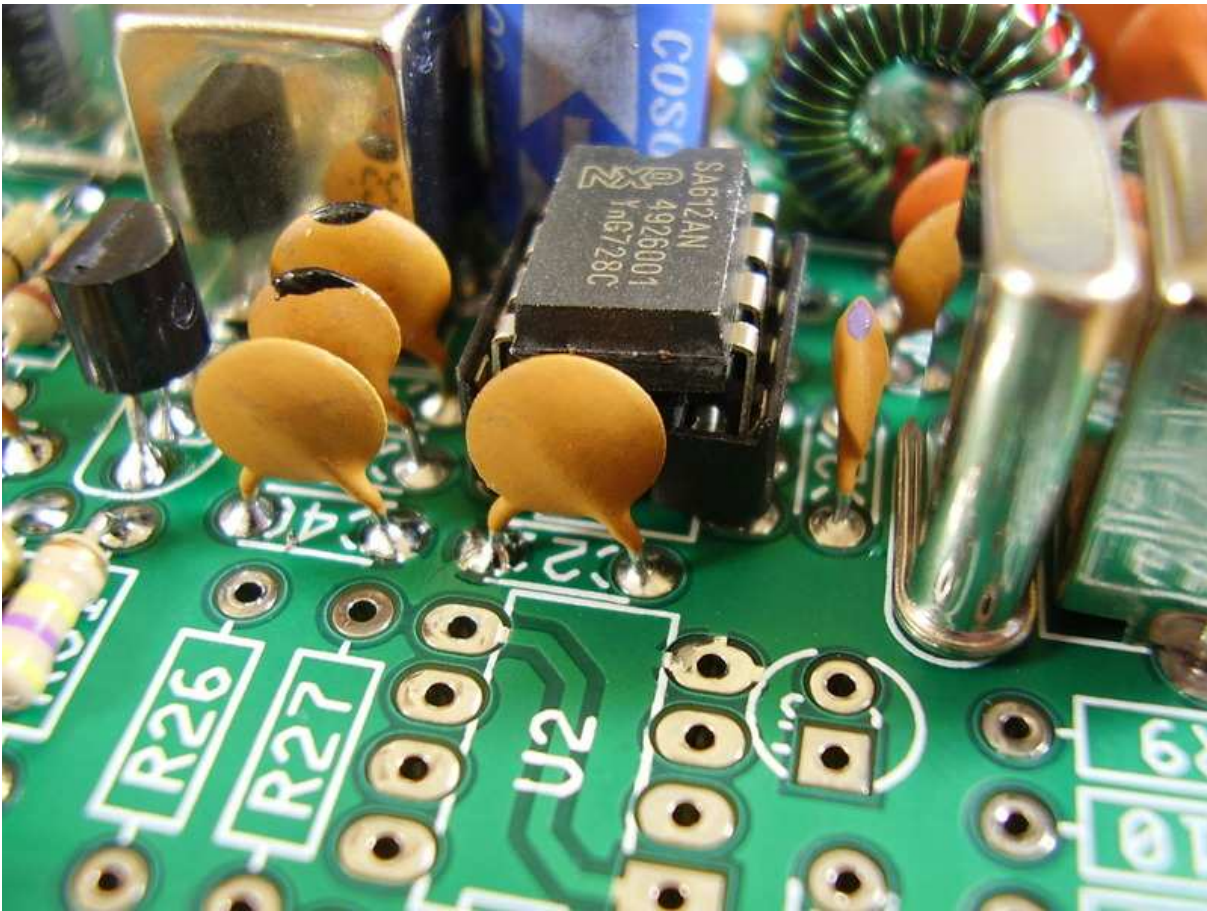

Figure 7.7: [5-8] C23 68pF.

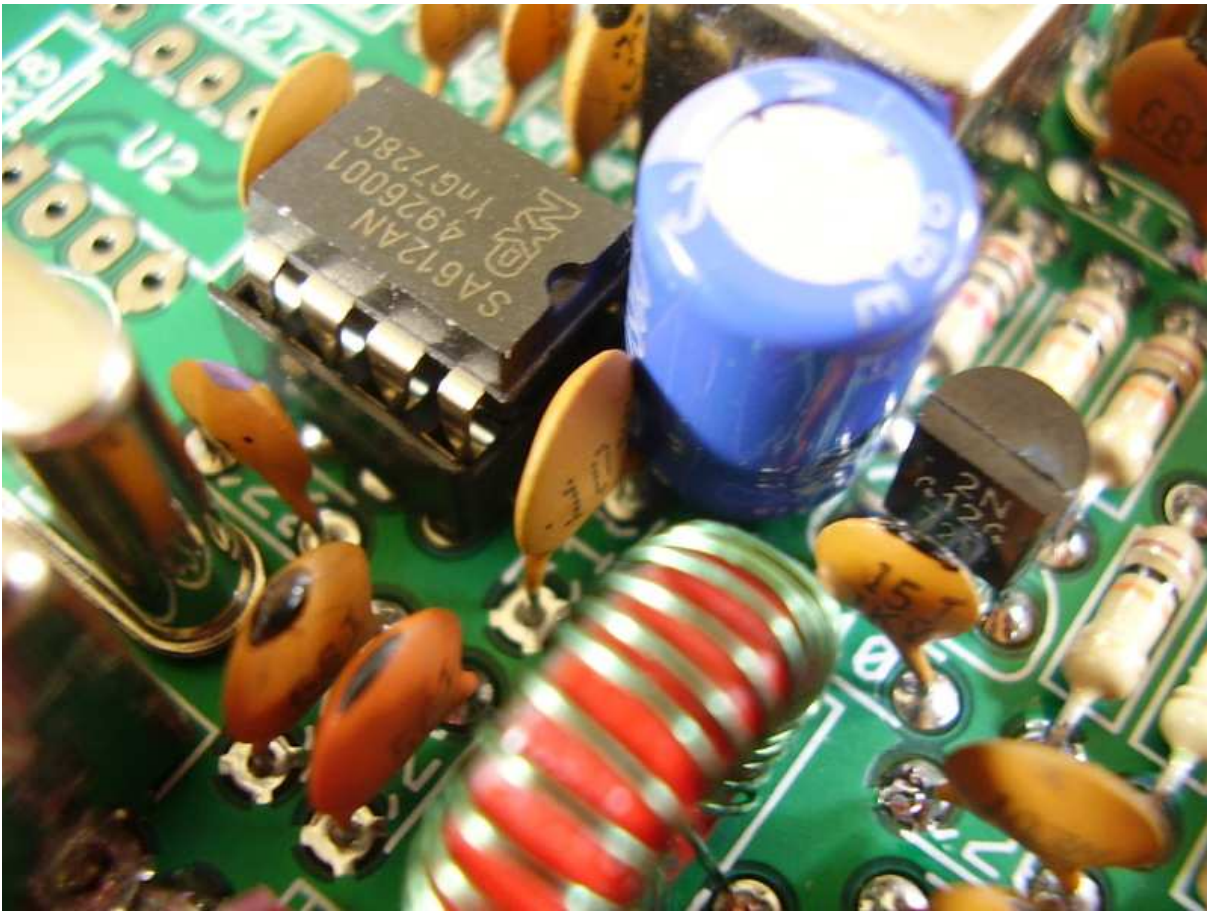

Figure 7.8: [5-10] C18 $.1\mu\text{F}$ (104).

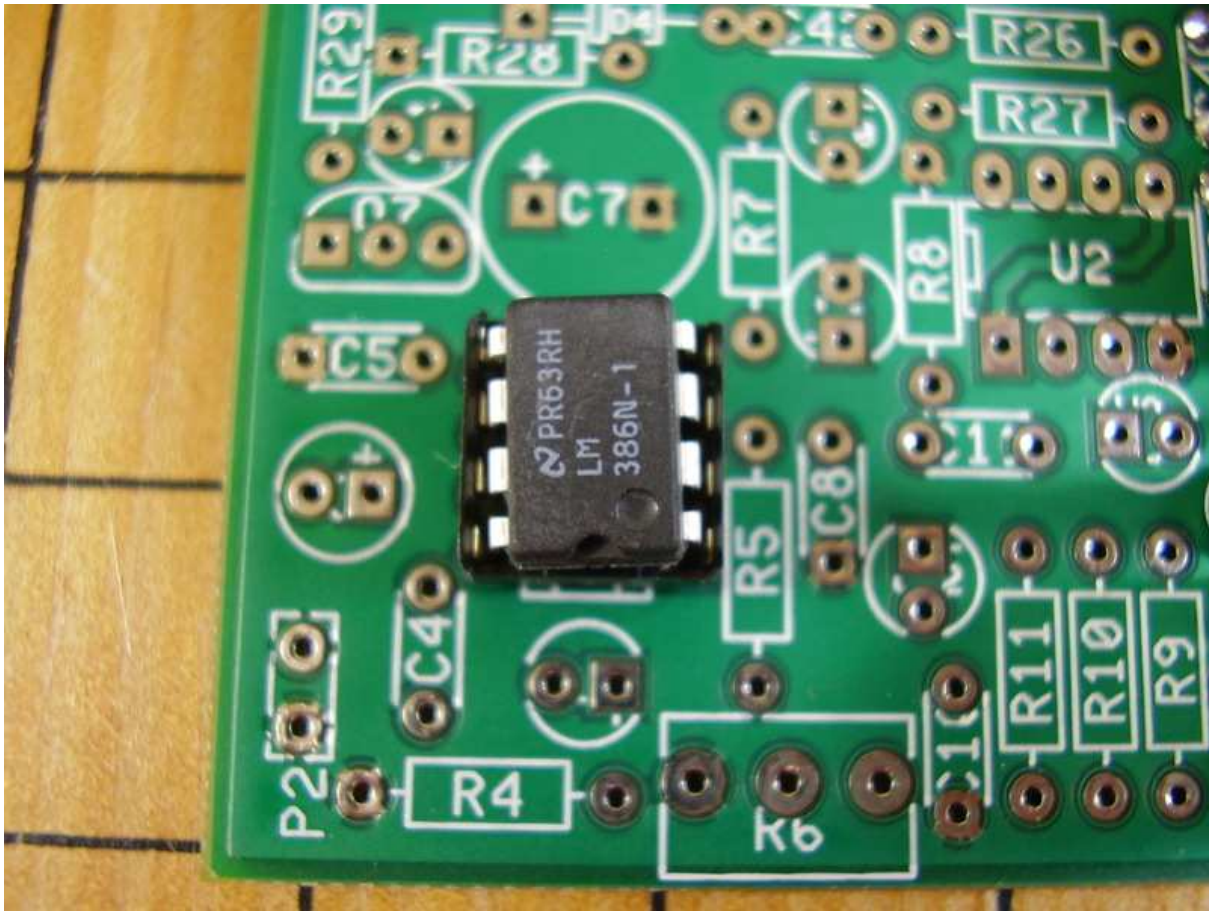

Figure 7.9: [5-11] U1 LM386.

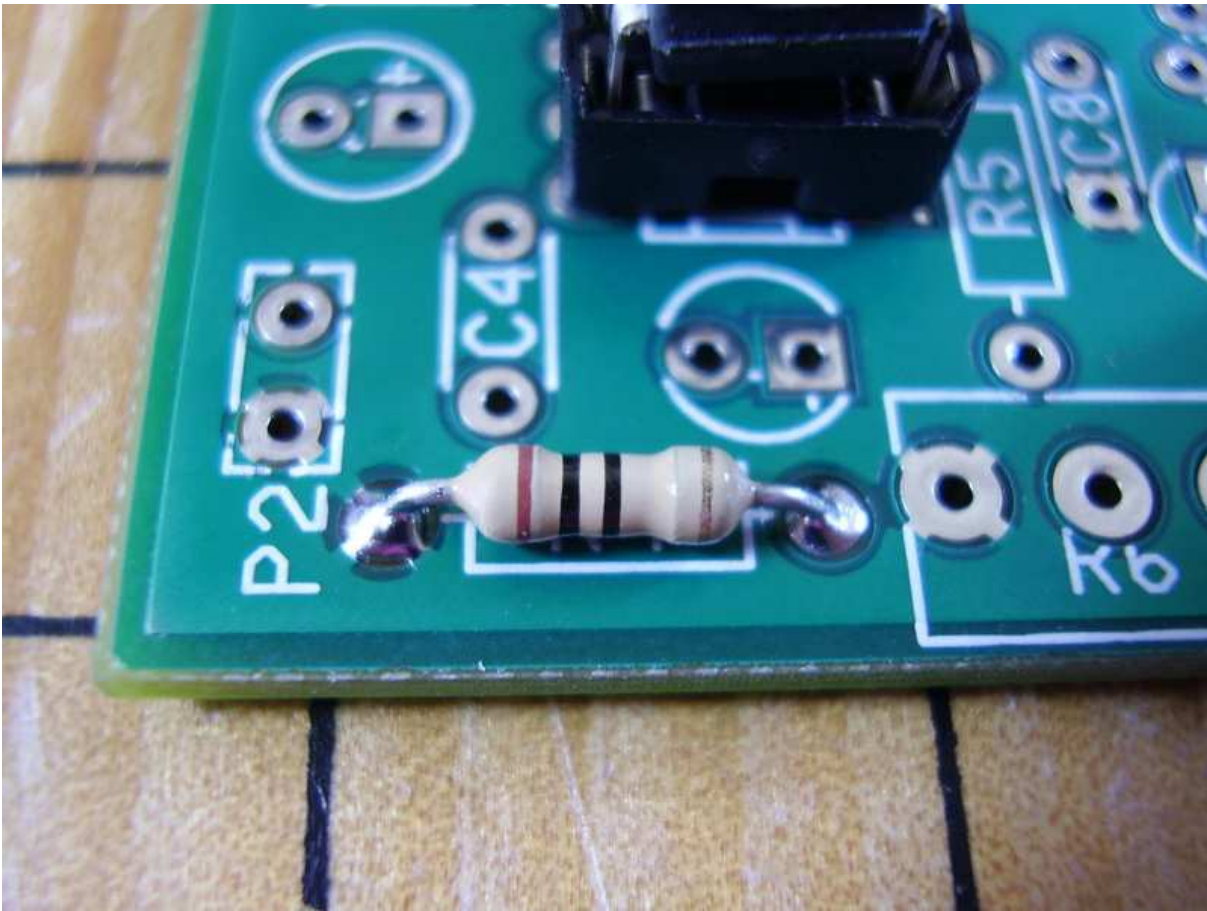

Figure 7.10: [5-12] R4 10 ohms.

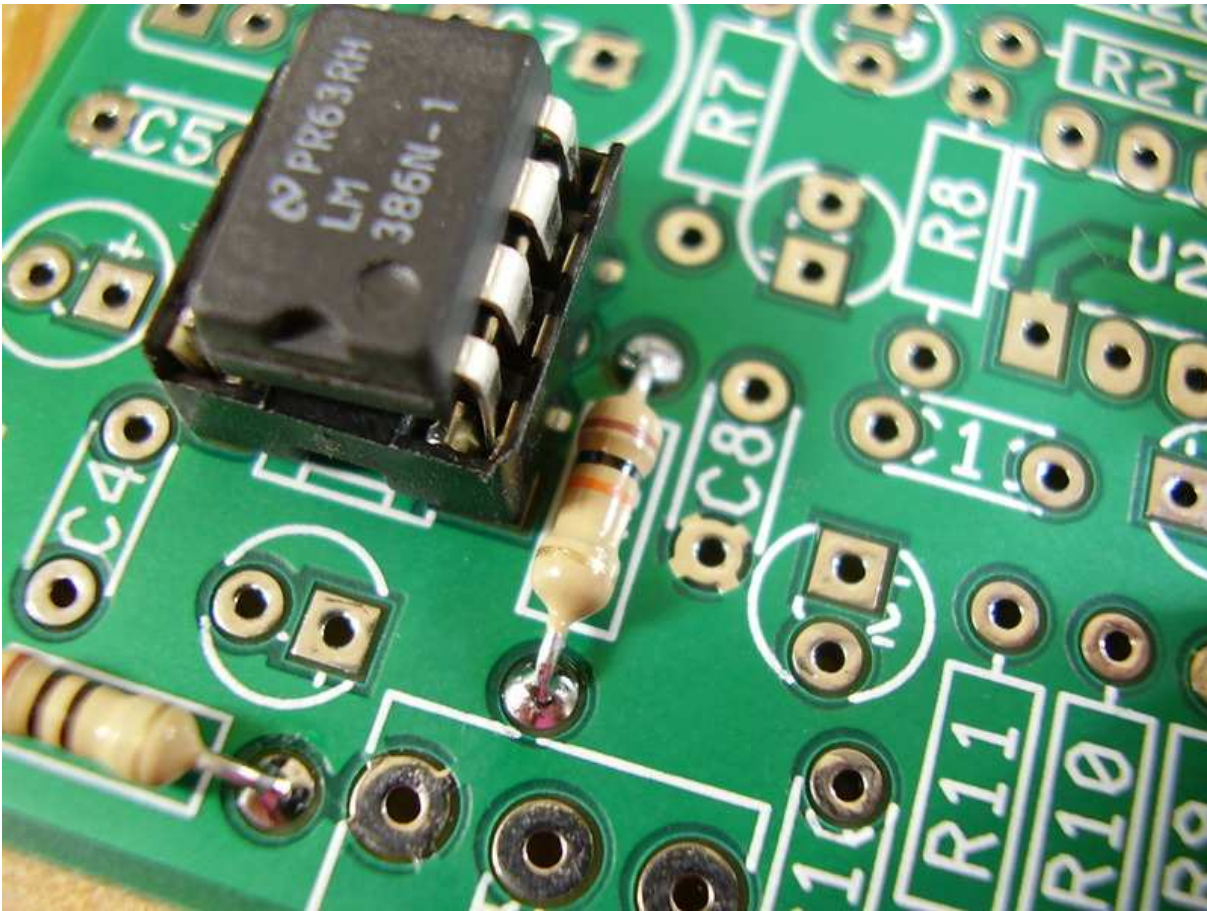

Figure 7.11: [5-13] R5 10K.

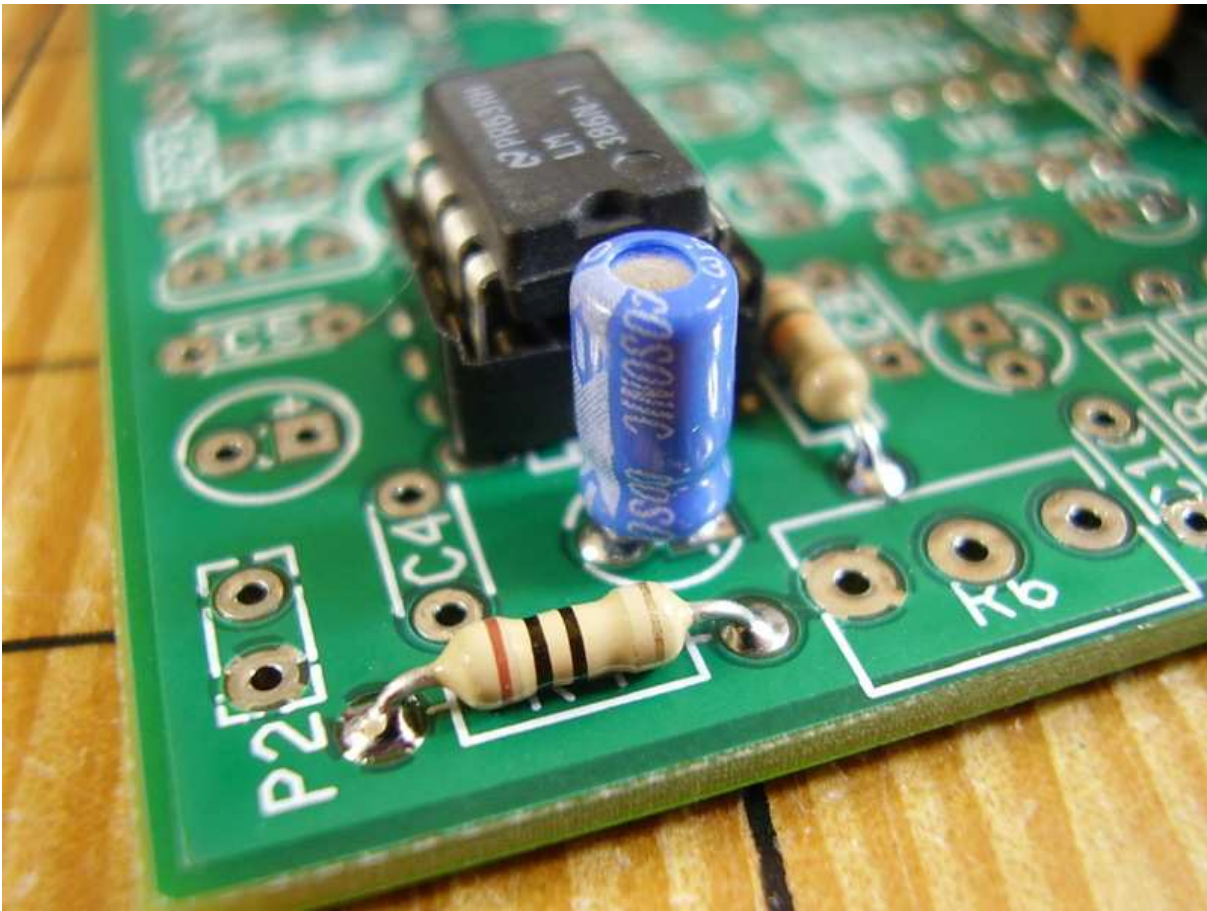

Figure 7.12: [5-14] C6 10 μ F.

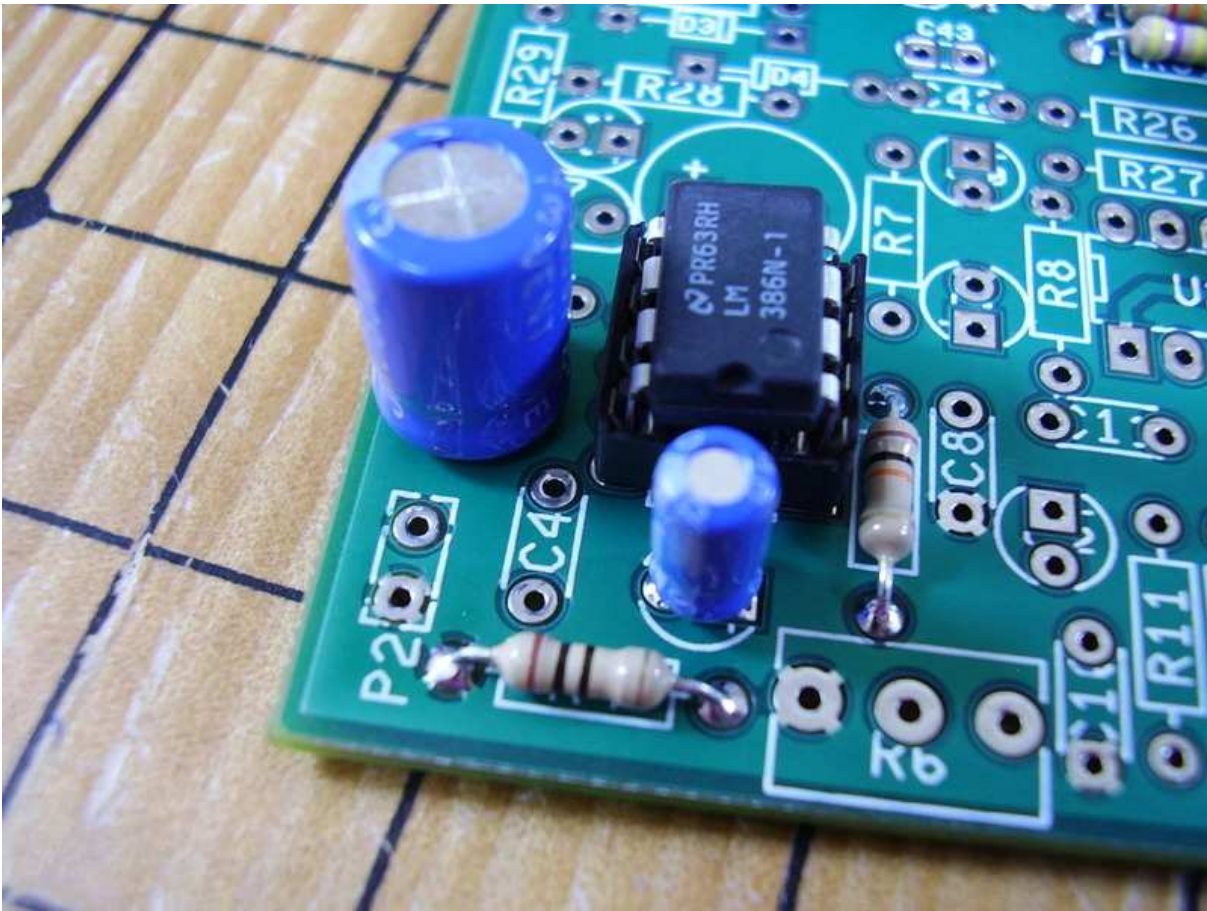

Figure 7.13: [5-15] C3 100 μ F.

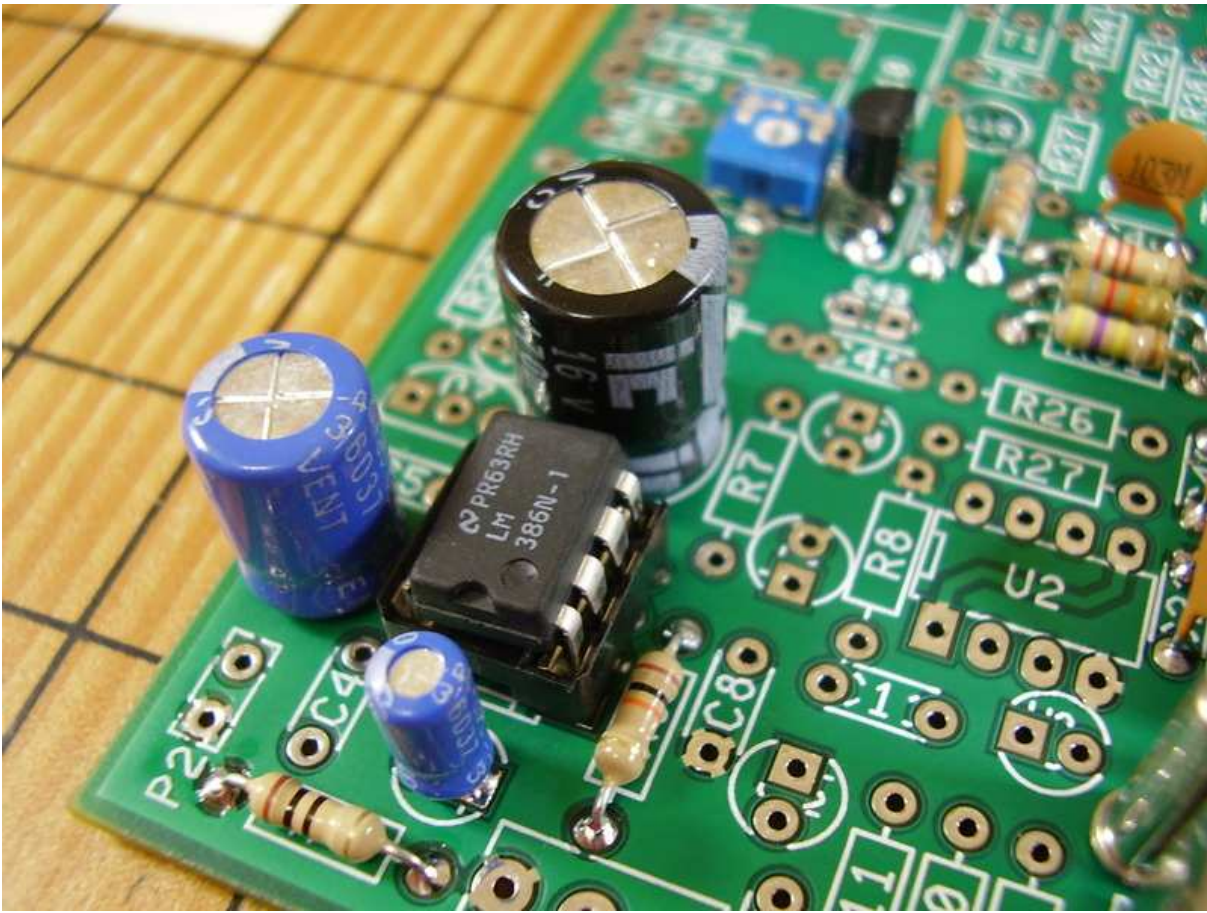

Figure 7.14: [5-16] C7 470 μ F.

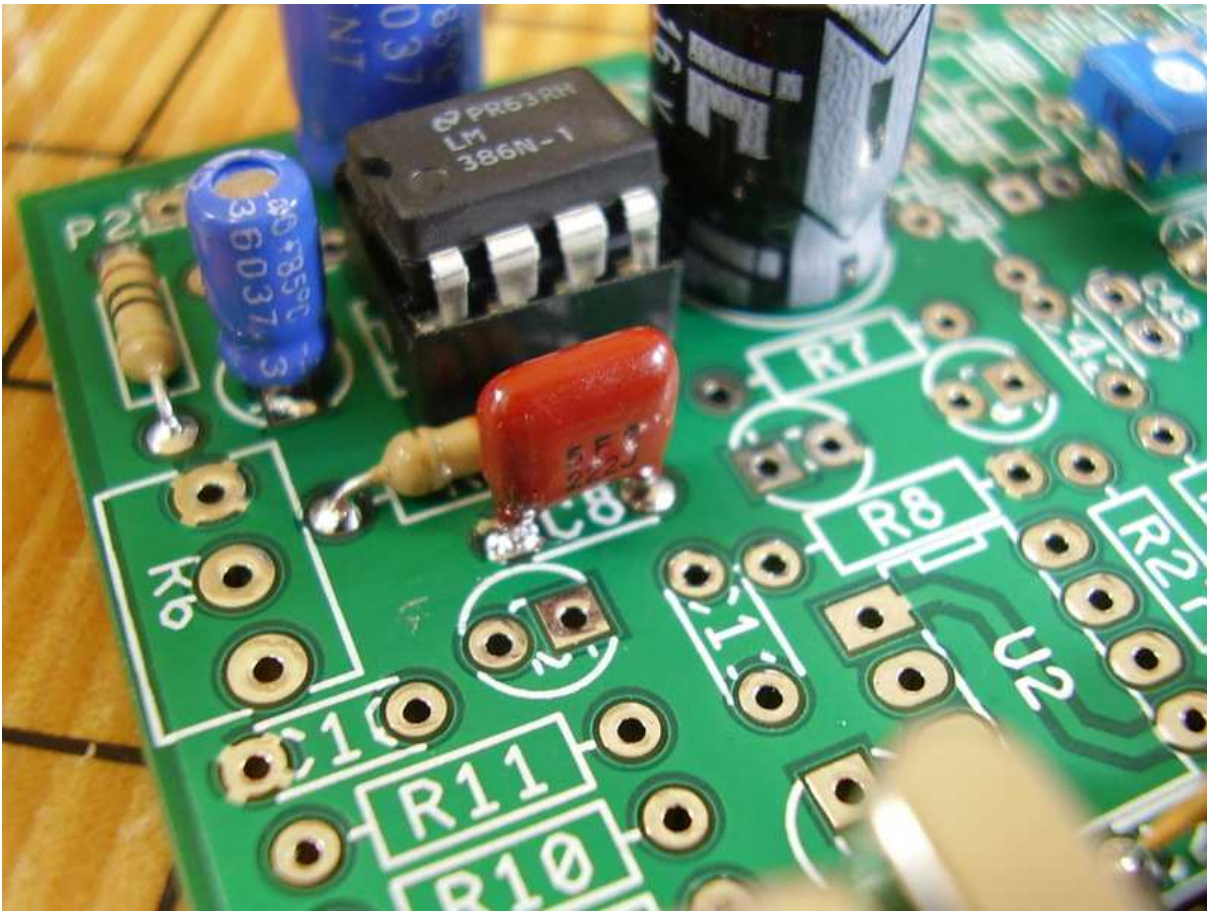

Figure 7.15: [5-17] C8 .0022 μ F (222).

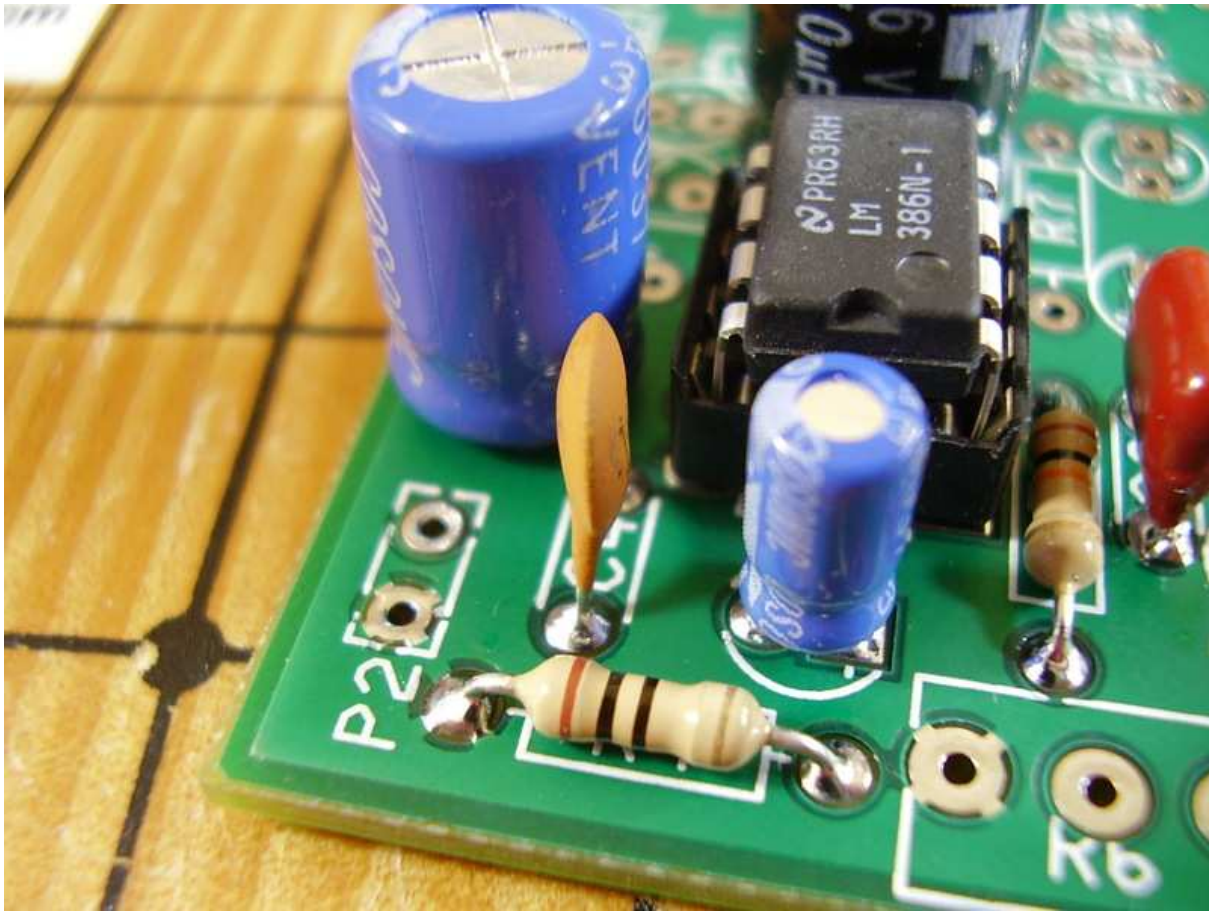

Figure 7.16: [5-18] C4 $.1\mu\text{F}$ (104).

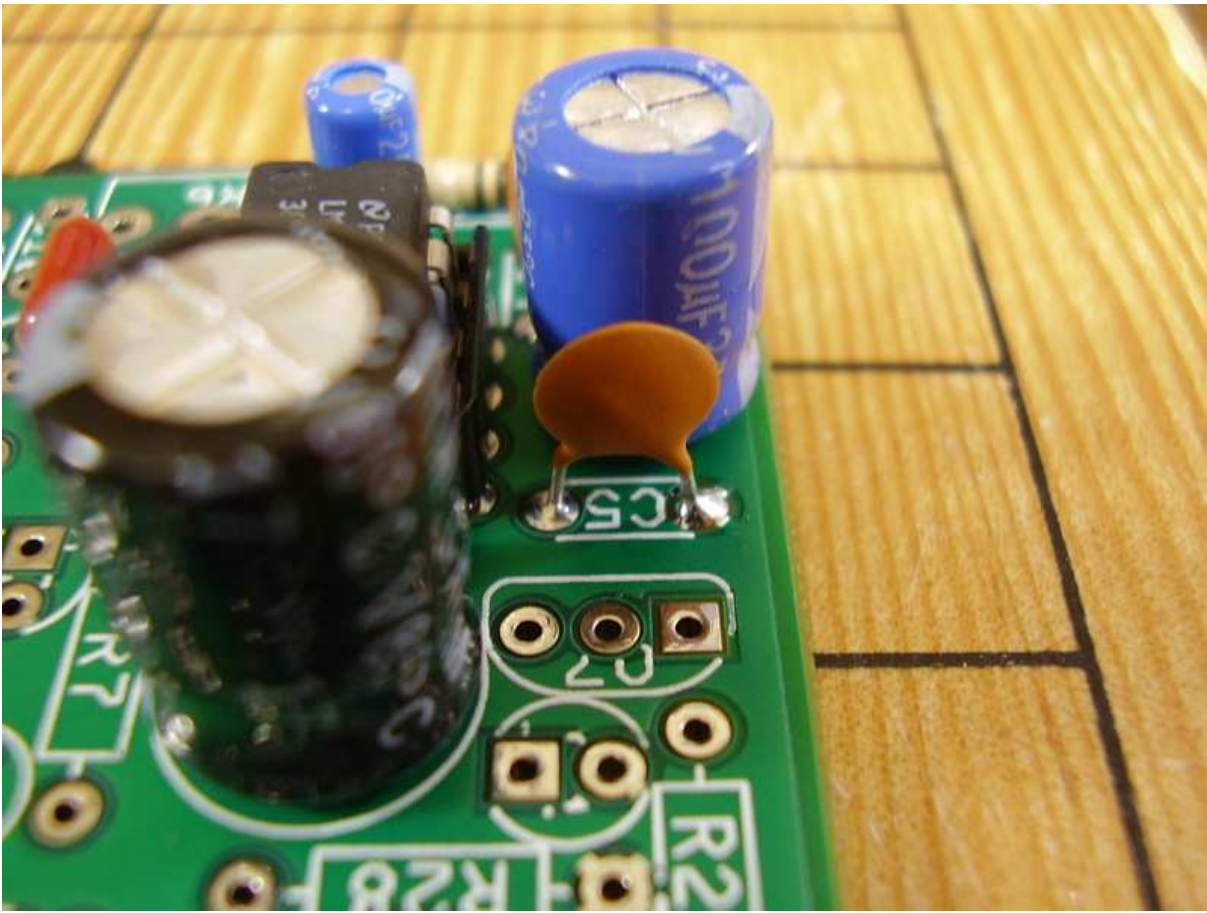

Figure 7.17: [5-19] C5 $.1\mu\text{F}$.

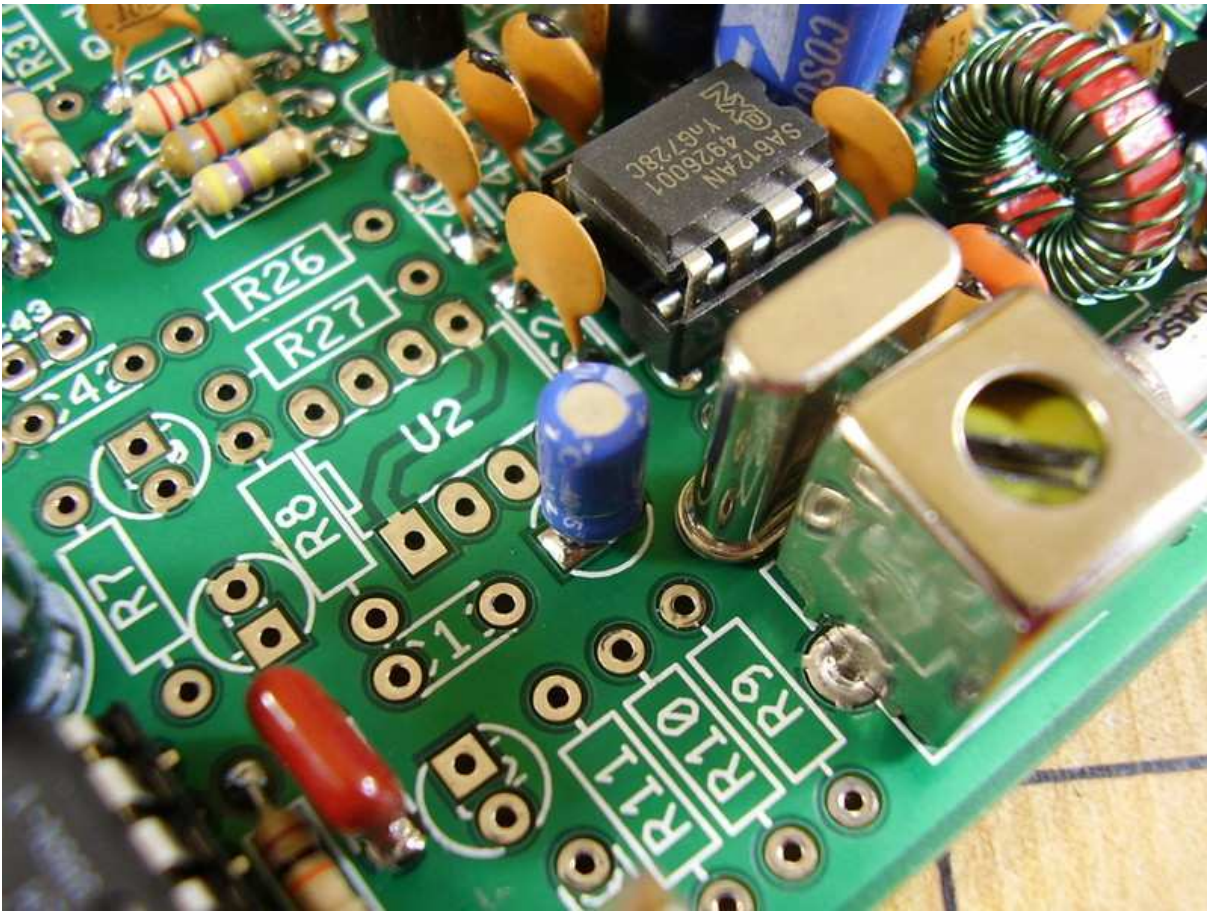

Figure 7.19: [5-40] C25 $1\mu\text{F}$.

Chapter 8

Phase 6.0 - Audio Preamp/Filter and AGC

Assembly of the audio preamp/filter and the automatic gain control (AGC) circuits.



Figure 8.1: [6-1] U2 LM358.

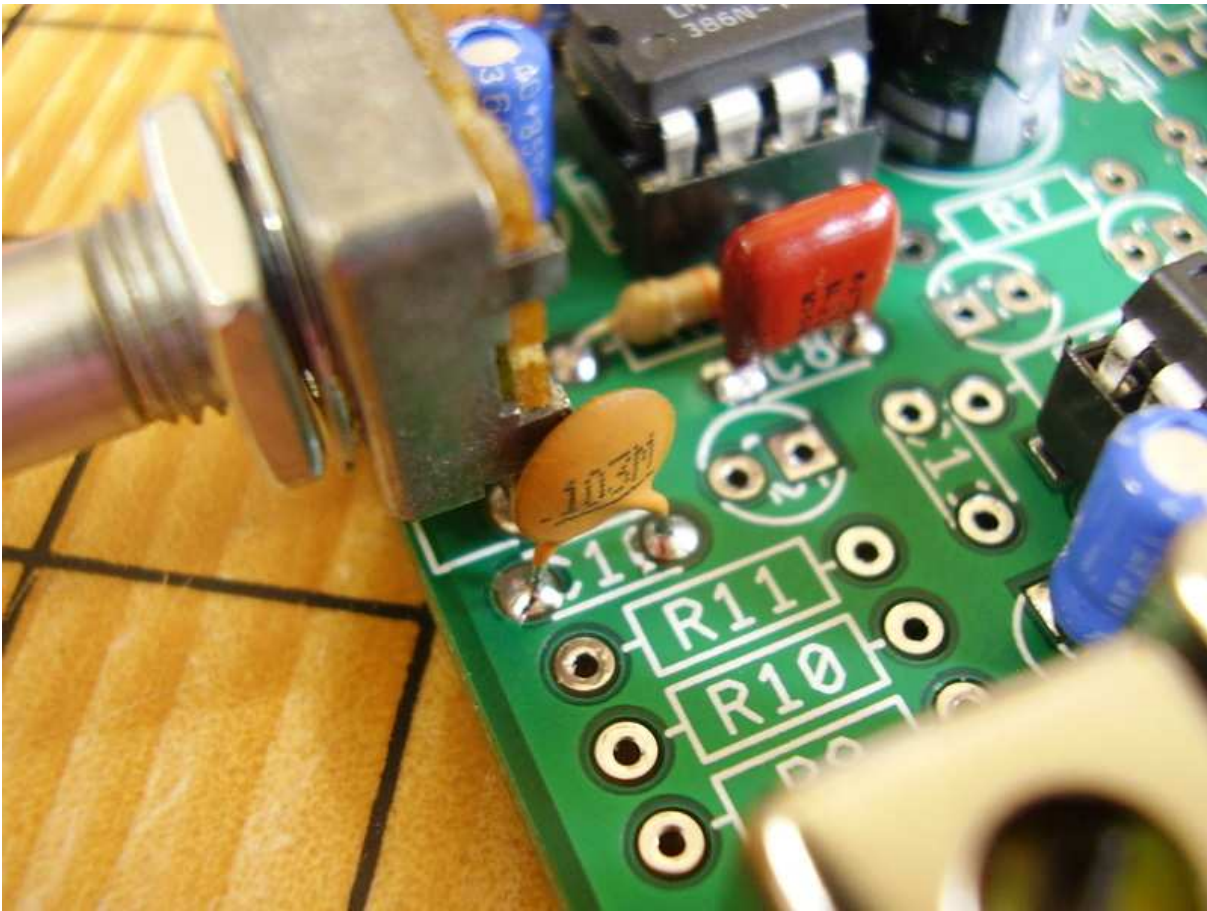

Figure 8.2: [6-2] C10 $.01\mu\text{F}$.

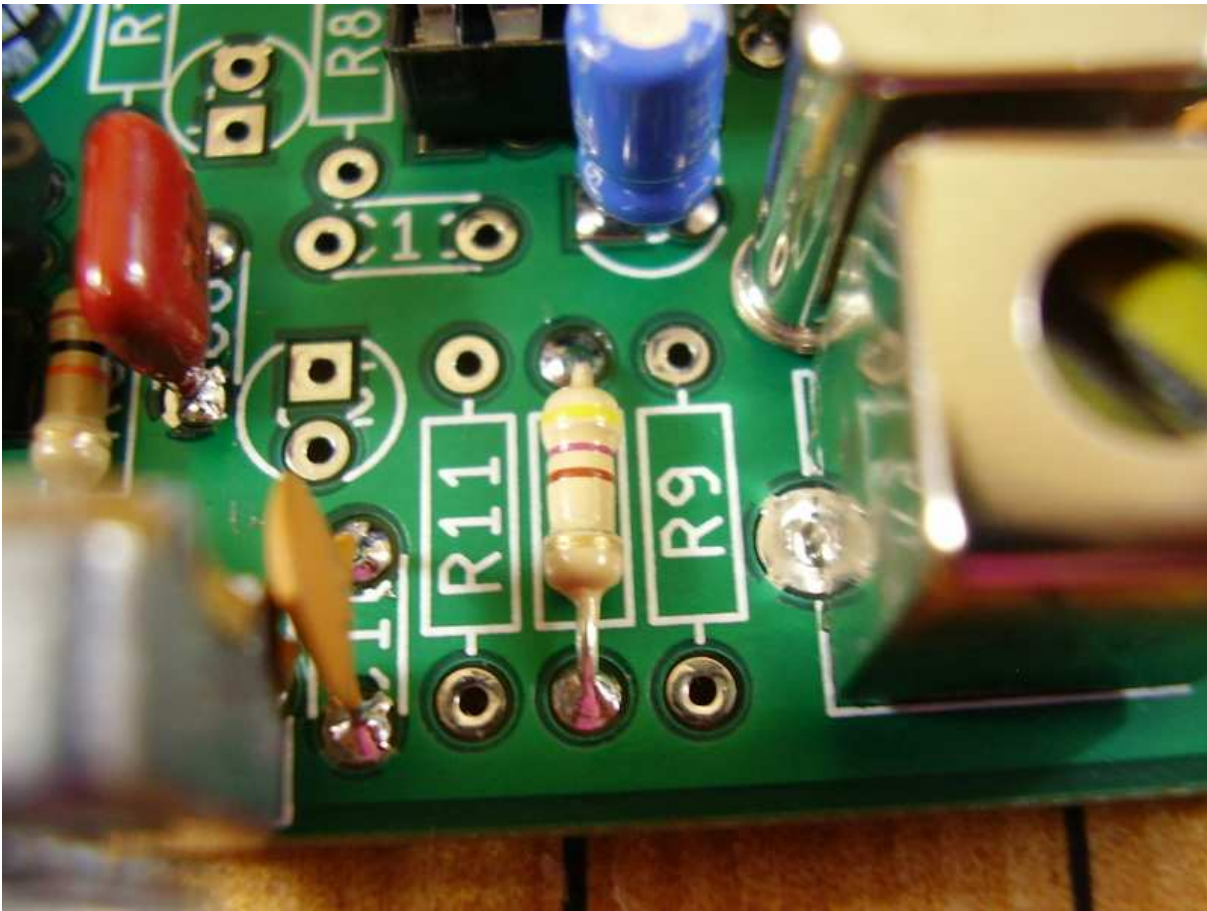

Figure 8.3: [6-3] R10 470 ohms .

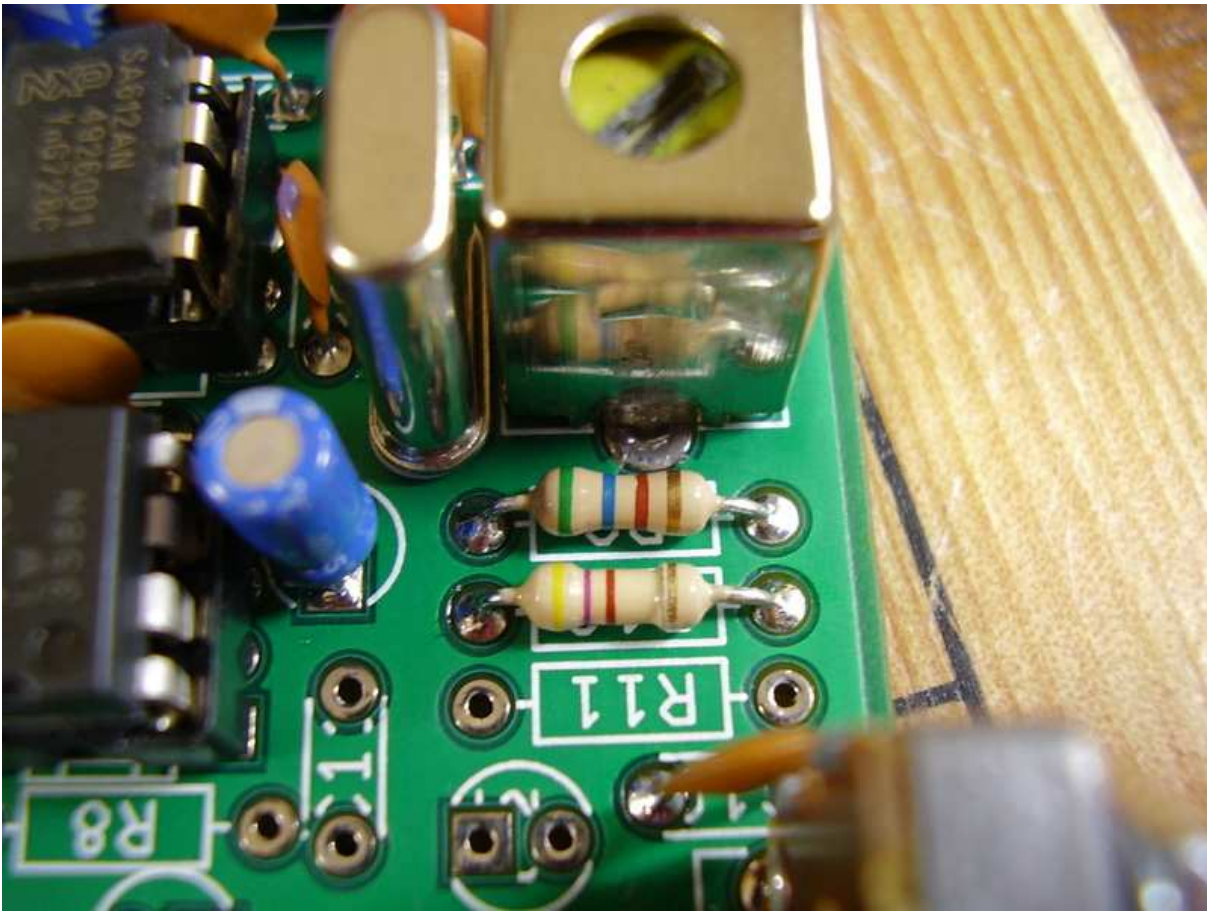

Figure 8.4: [6-4] R9 560 ohms.

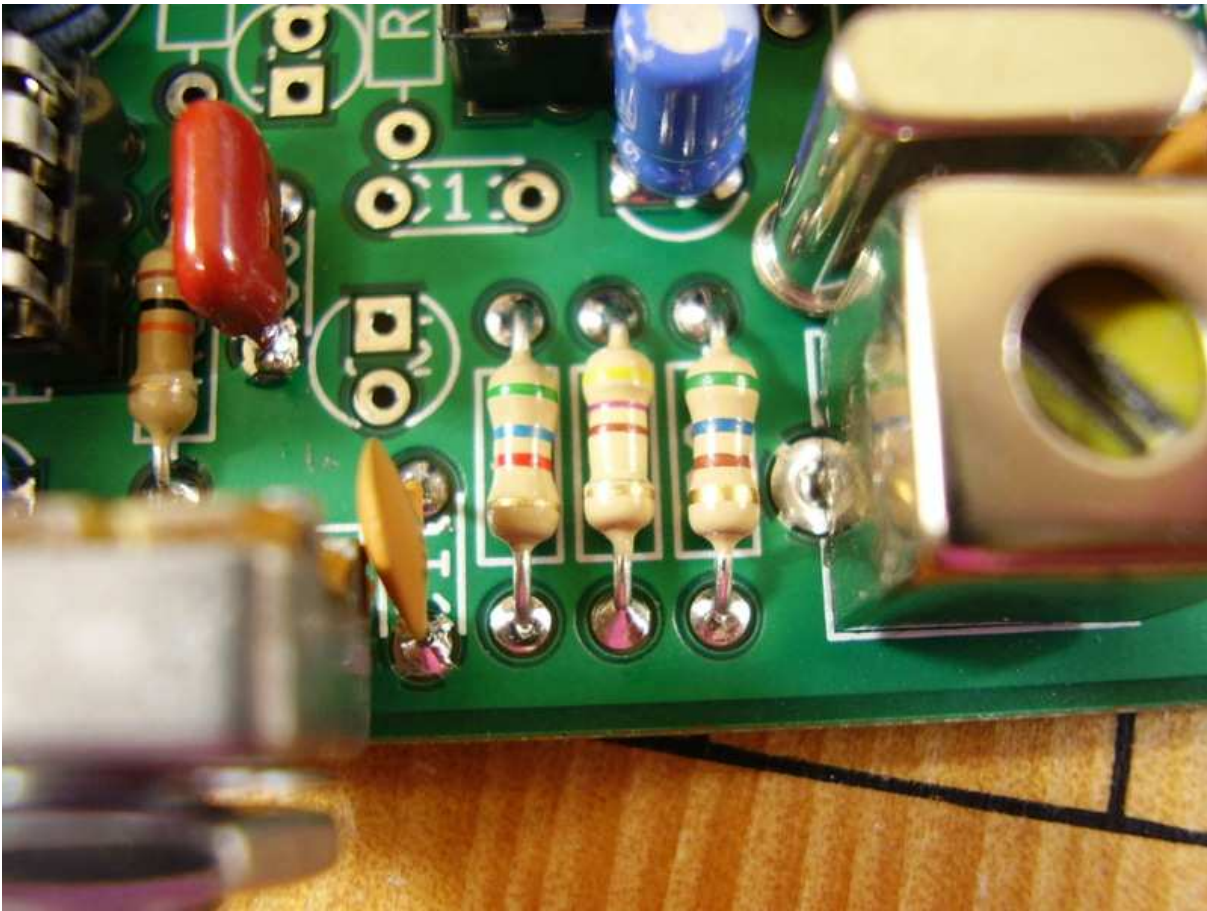

Figure 8.5: [6-5] R11 5.6K.

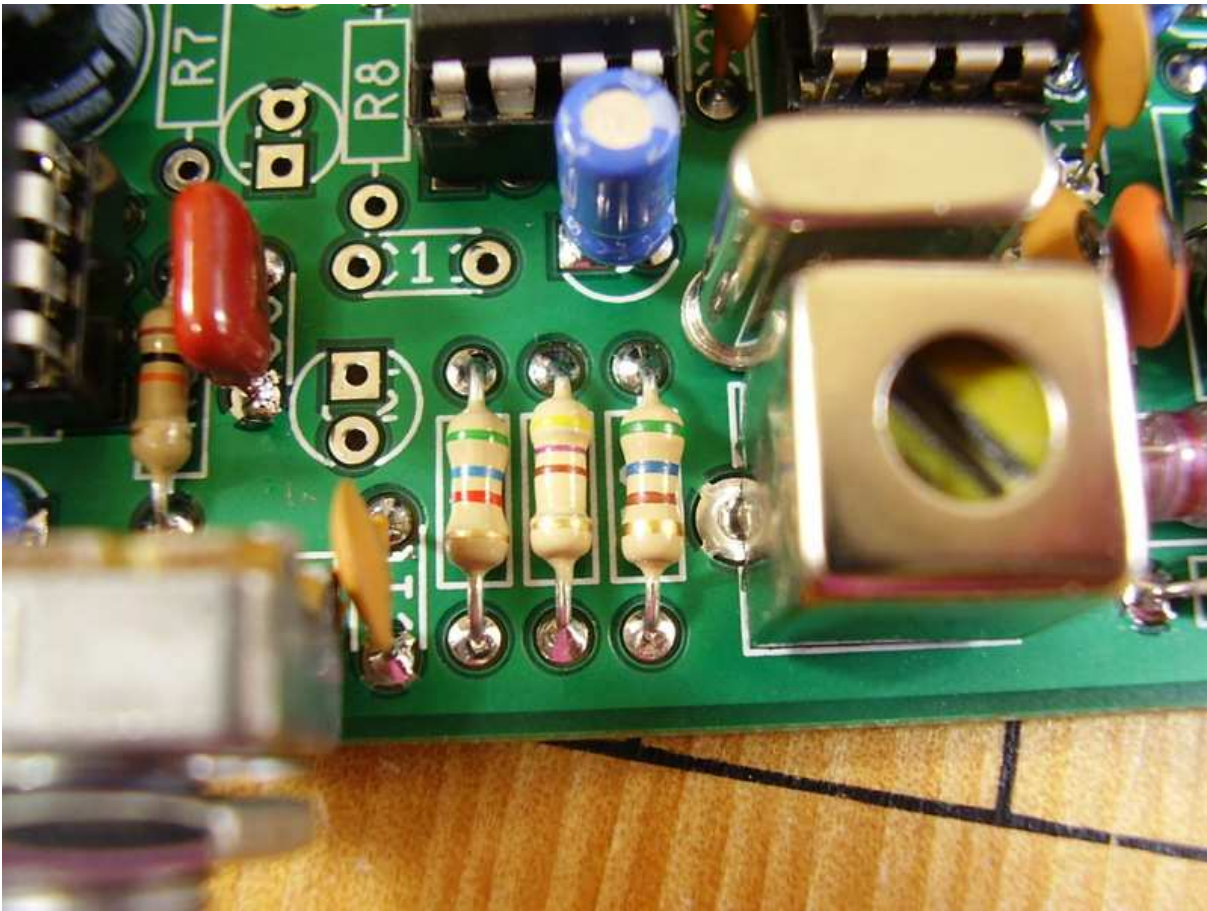

Figure 8.6: View of Area Just Completed.

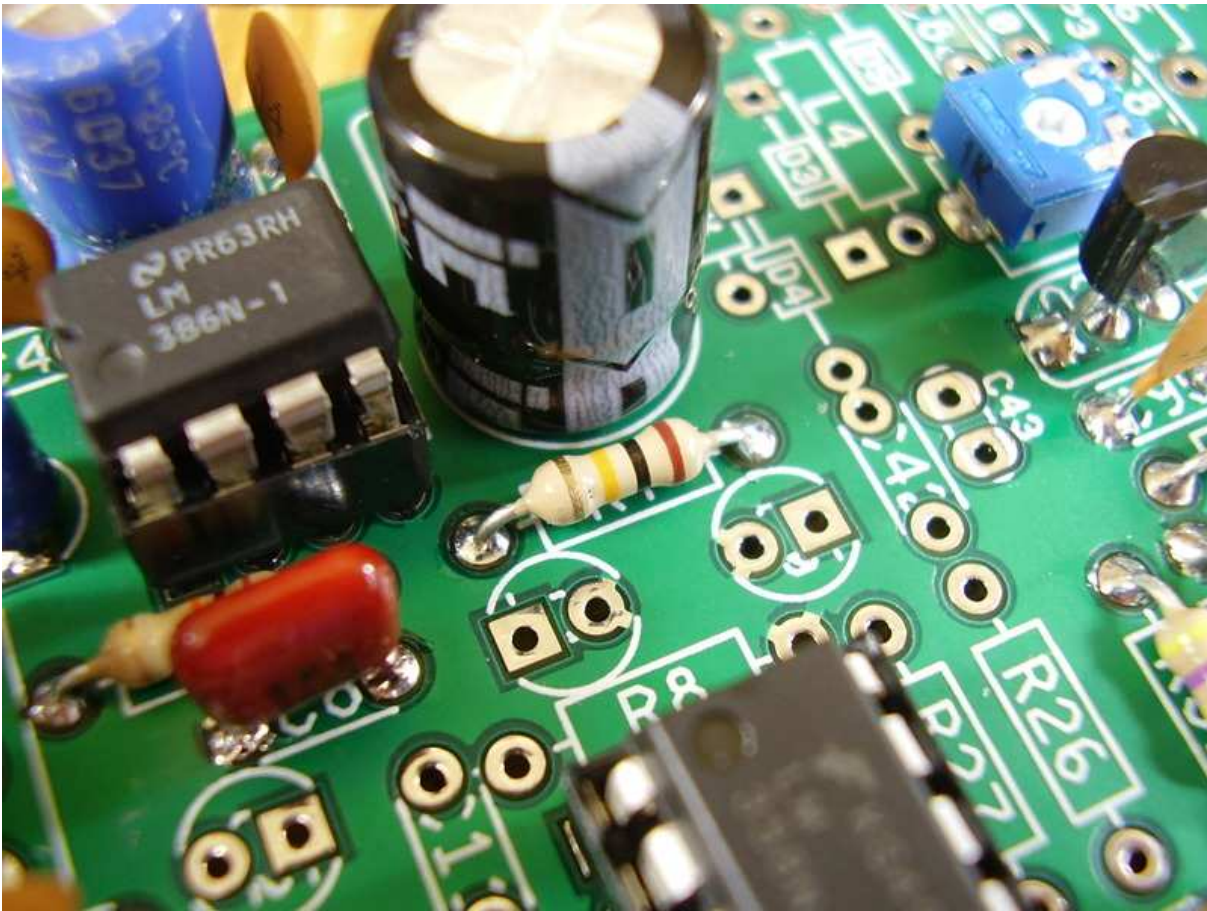

Figure 8.7: [6-6] R7 100K.

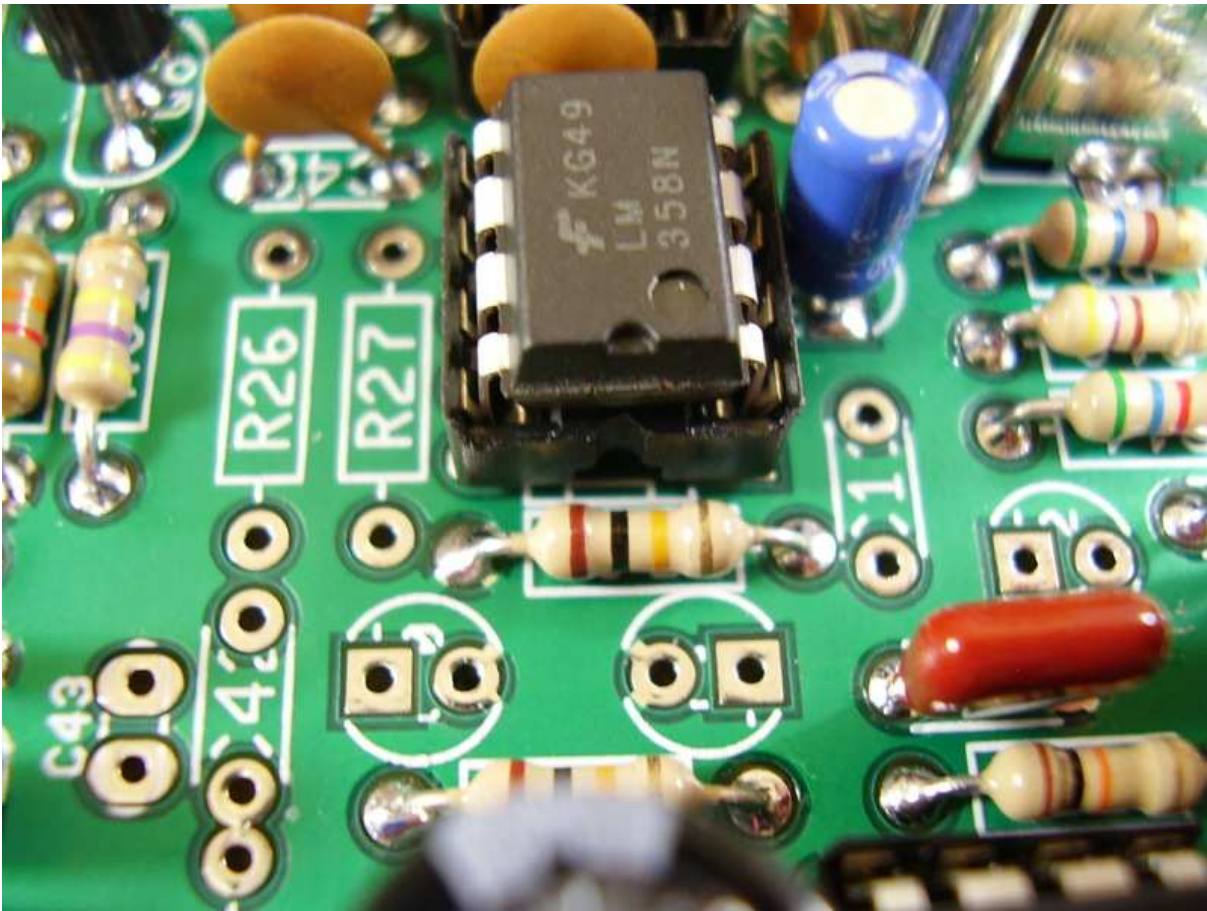

Figure 8.8: [6-7] R8 100K.

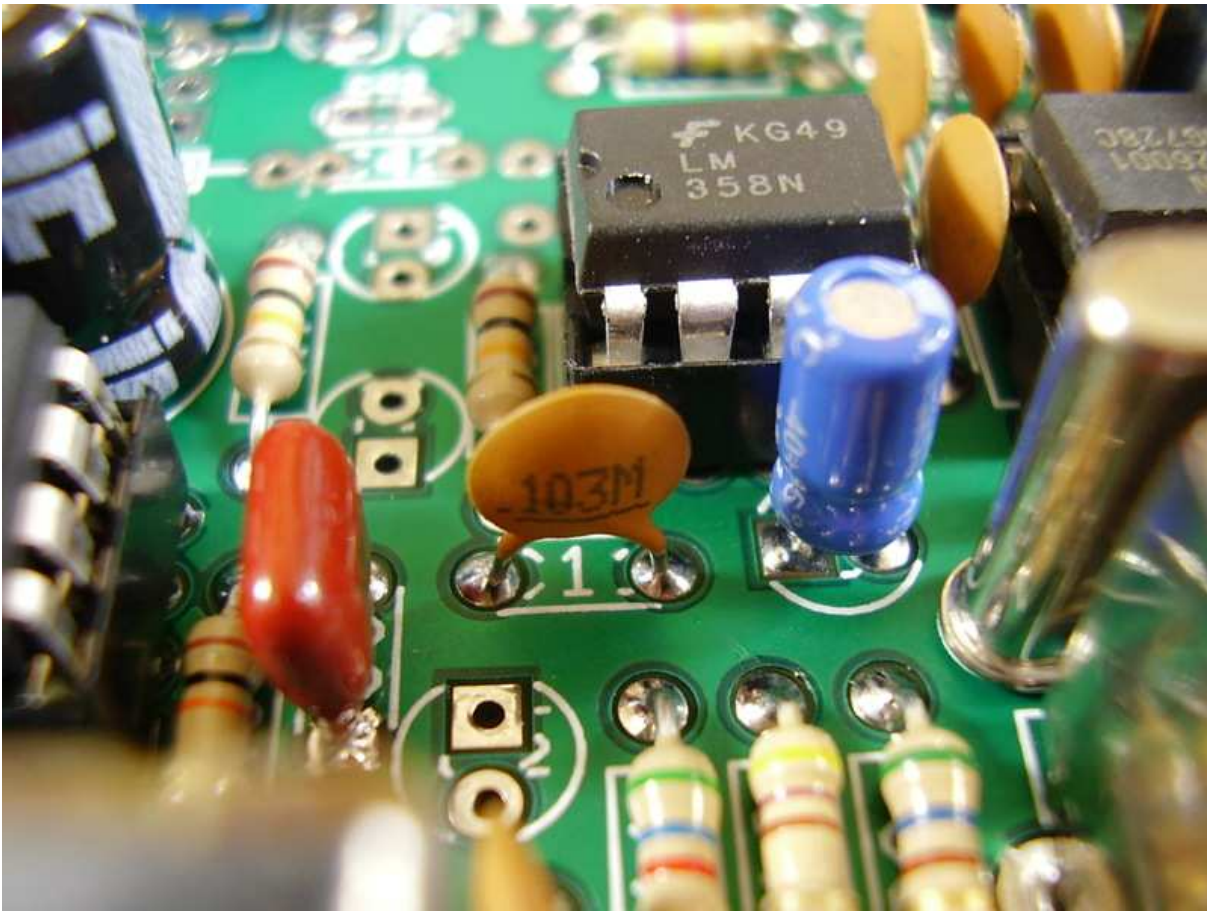

Figure 8.9: [6-8] C11 $.01\mu\text{F}$.

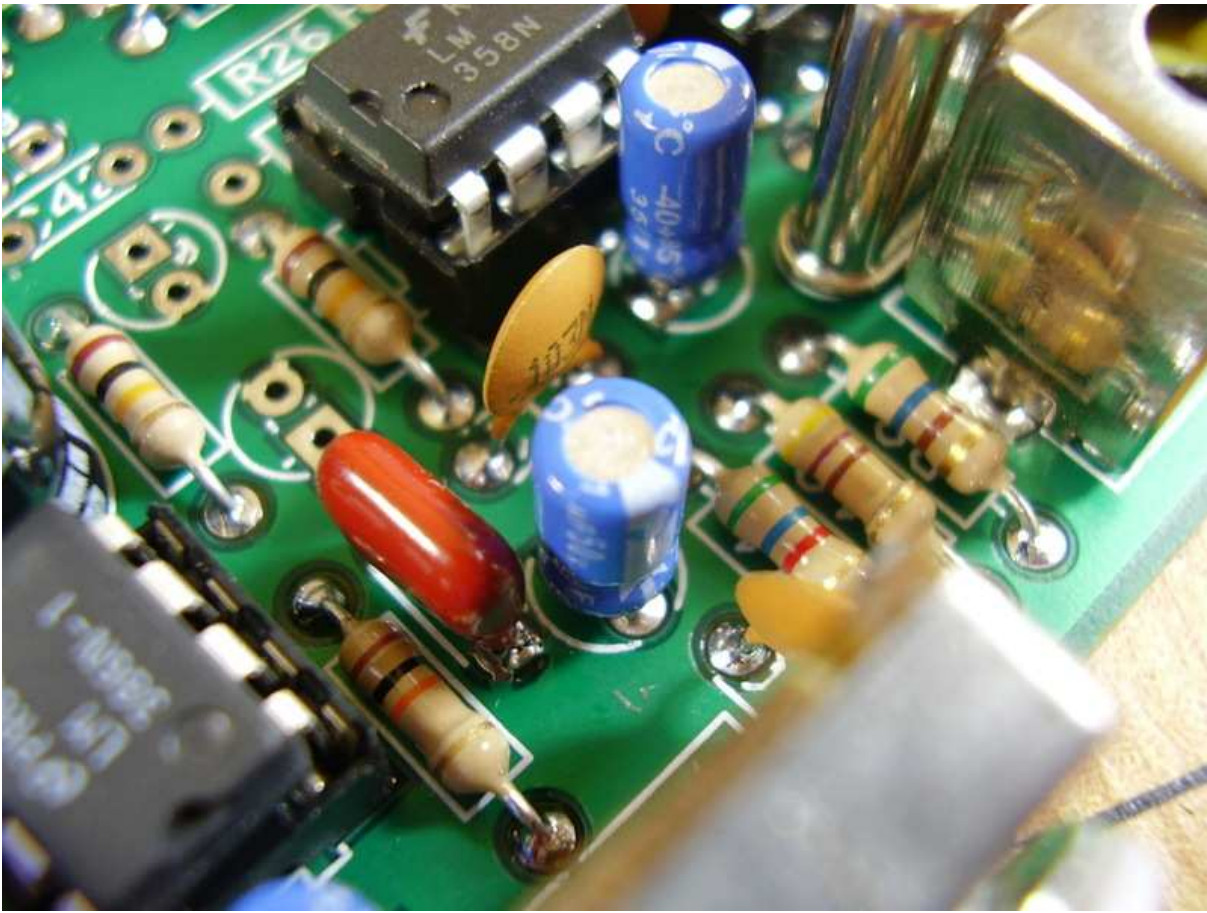

Figure 8.10: [6-9] C12 $1\mu\text{F}$.

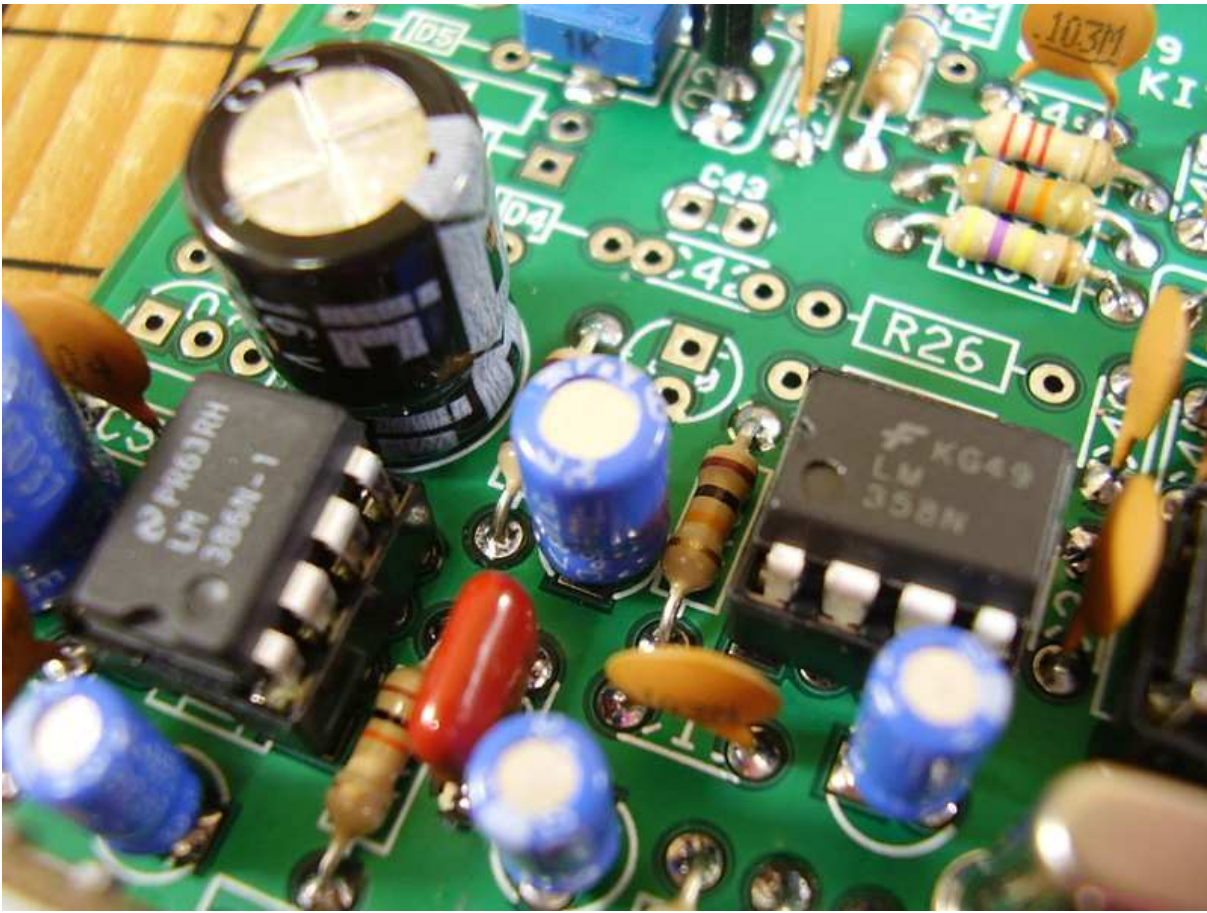

Figure 8.11: [6-10] C9 33 μ F.

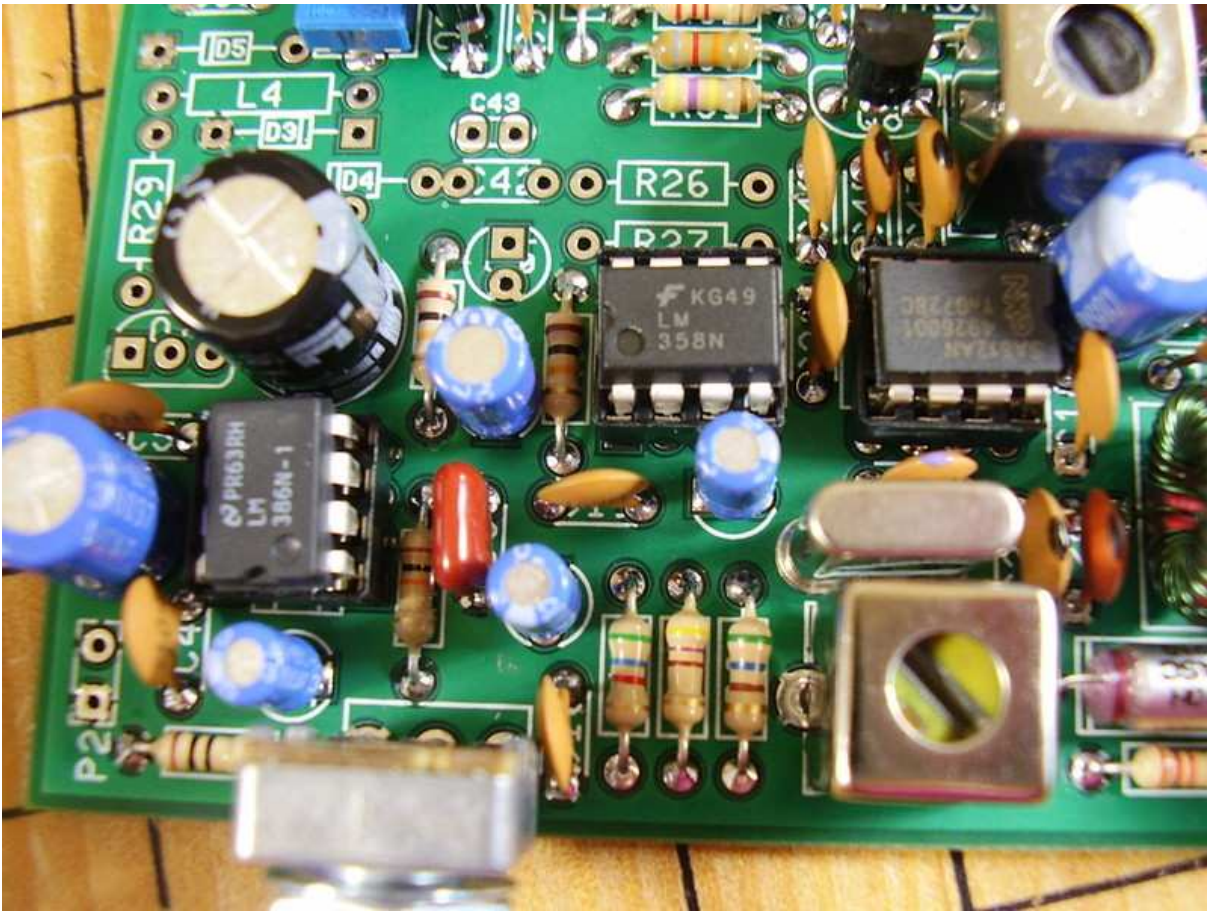

Figure 8.12: View of Area Just Completed.

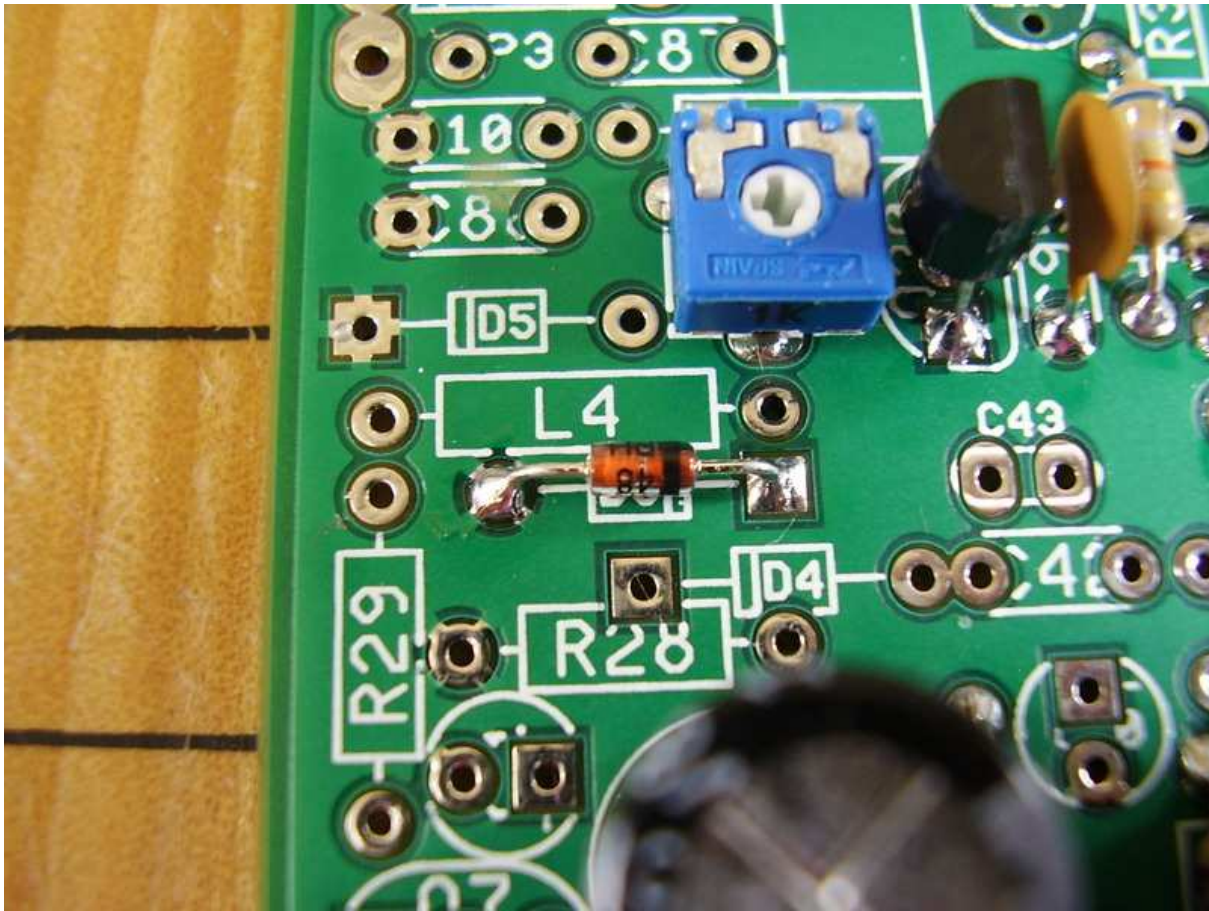

Figure 8.13: [6-11] D3 1N4148.

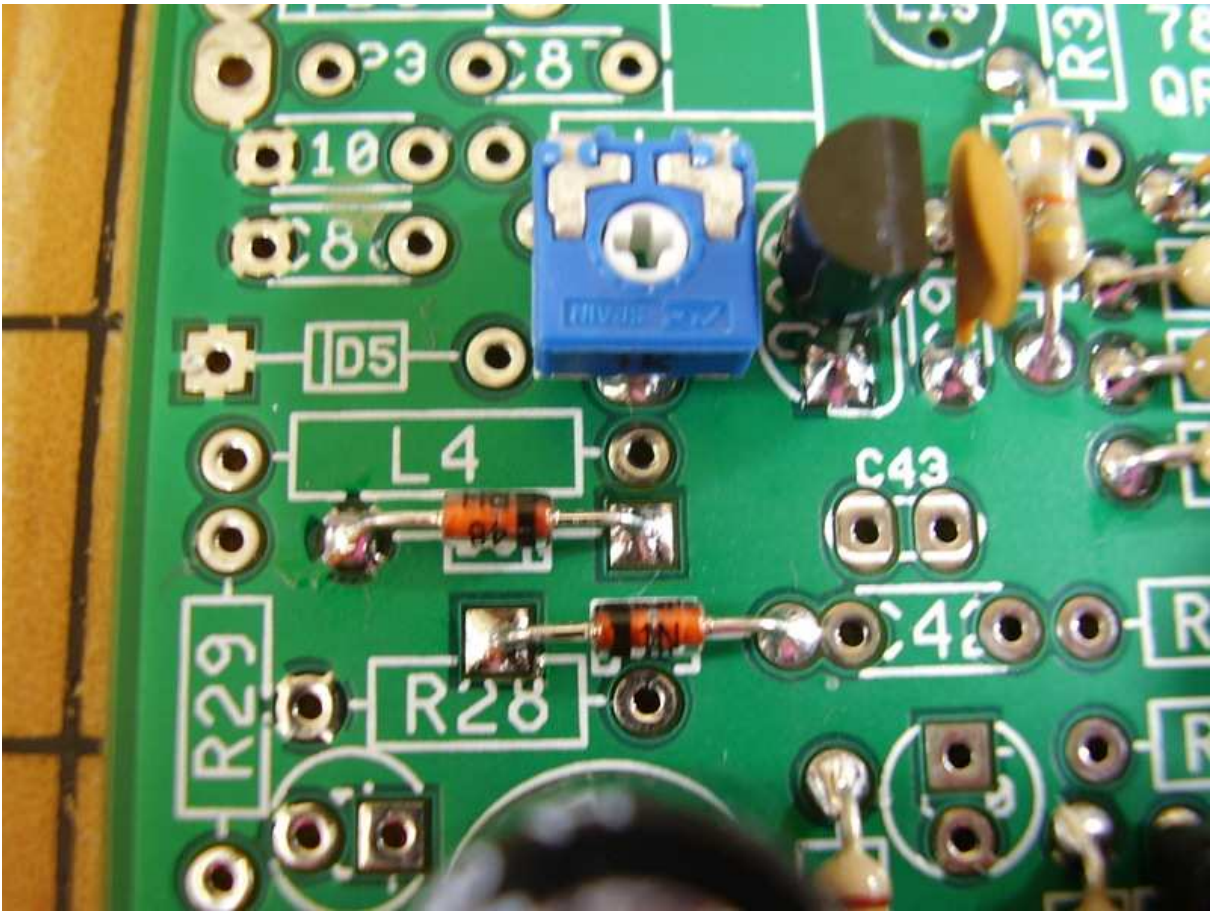

Figure 8.14: [6-12] D4 1N4148.

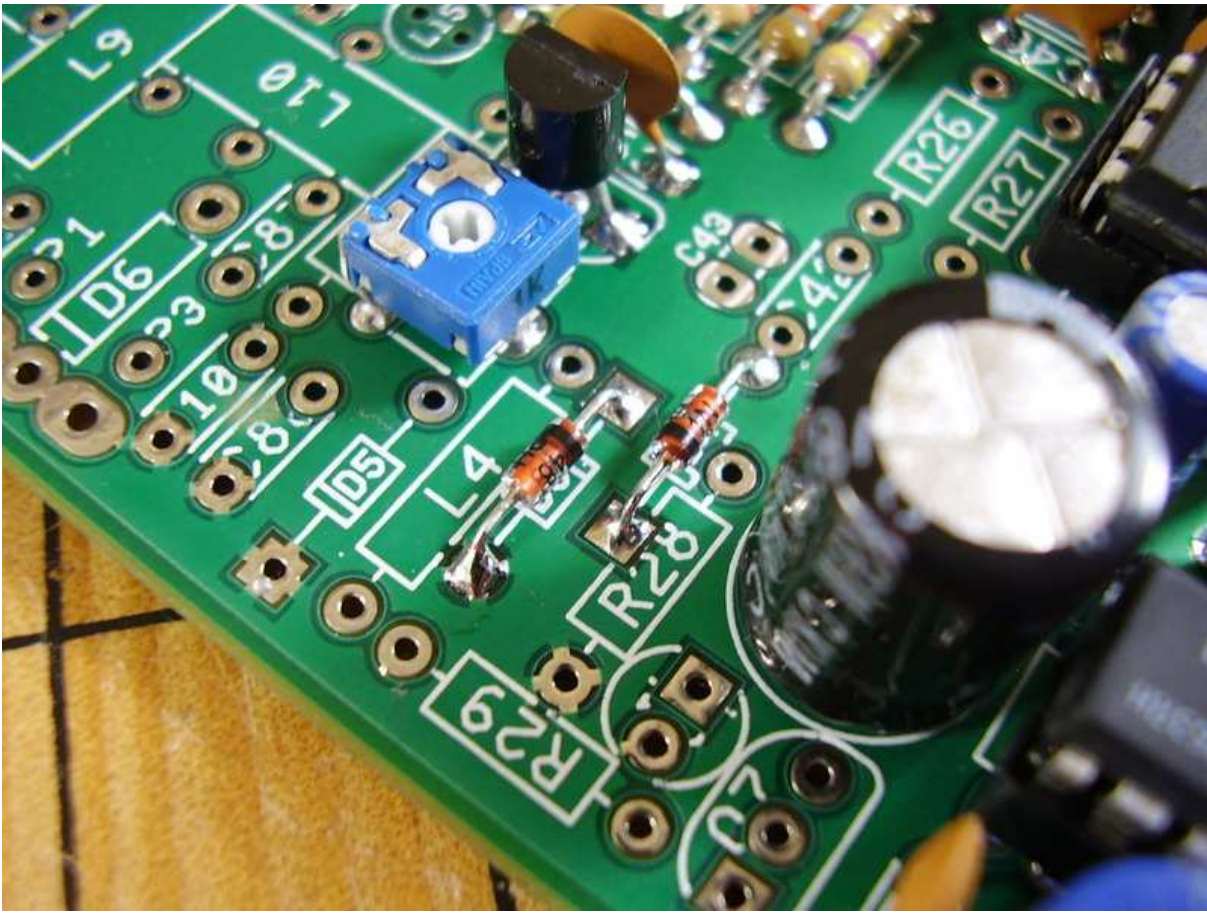

Figure 8.15: View of D3 and D4.

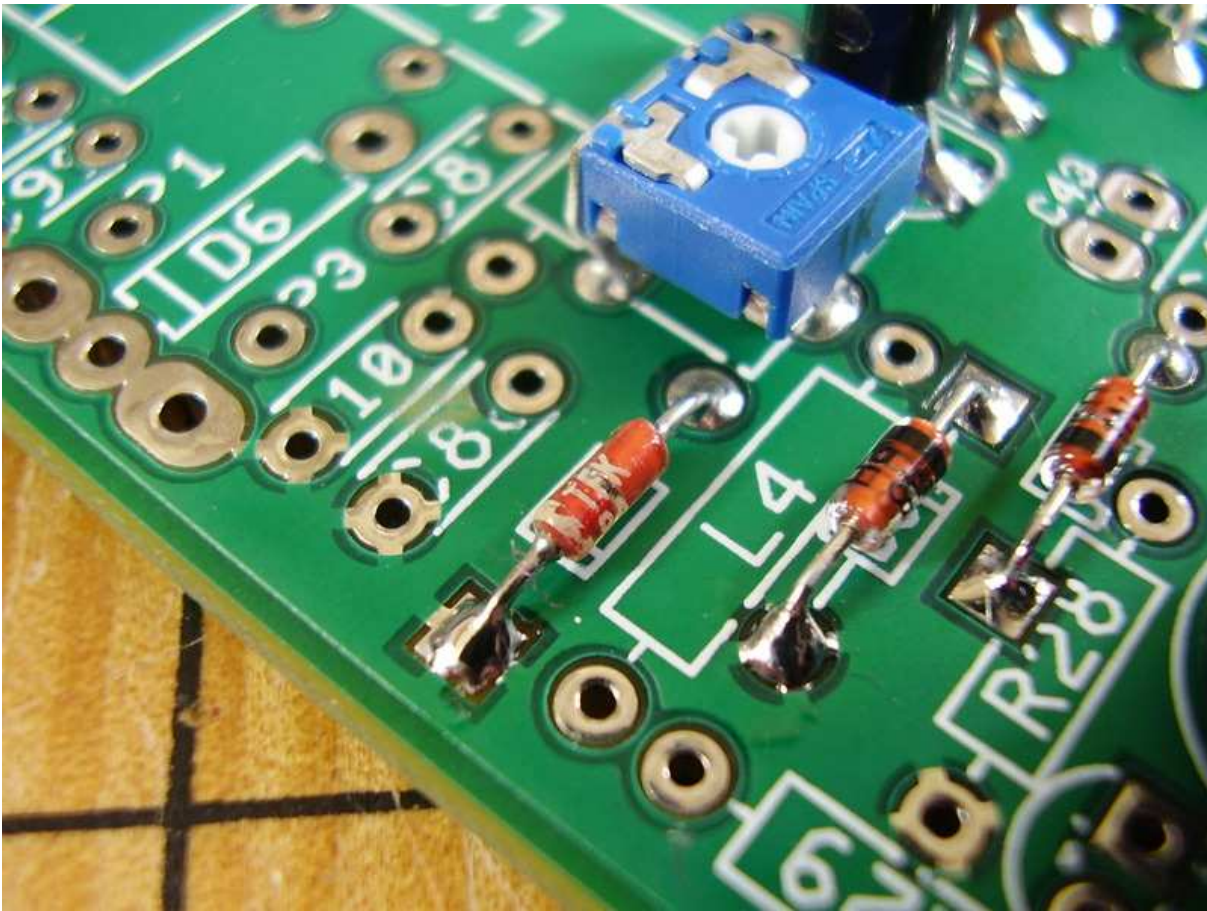

Figure 8.16: [6-13] D5 BA479.



Figure 8.17: [6-14] Q7 2N4124.

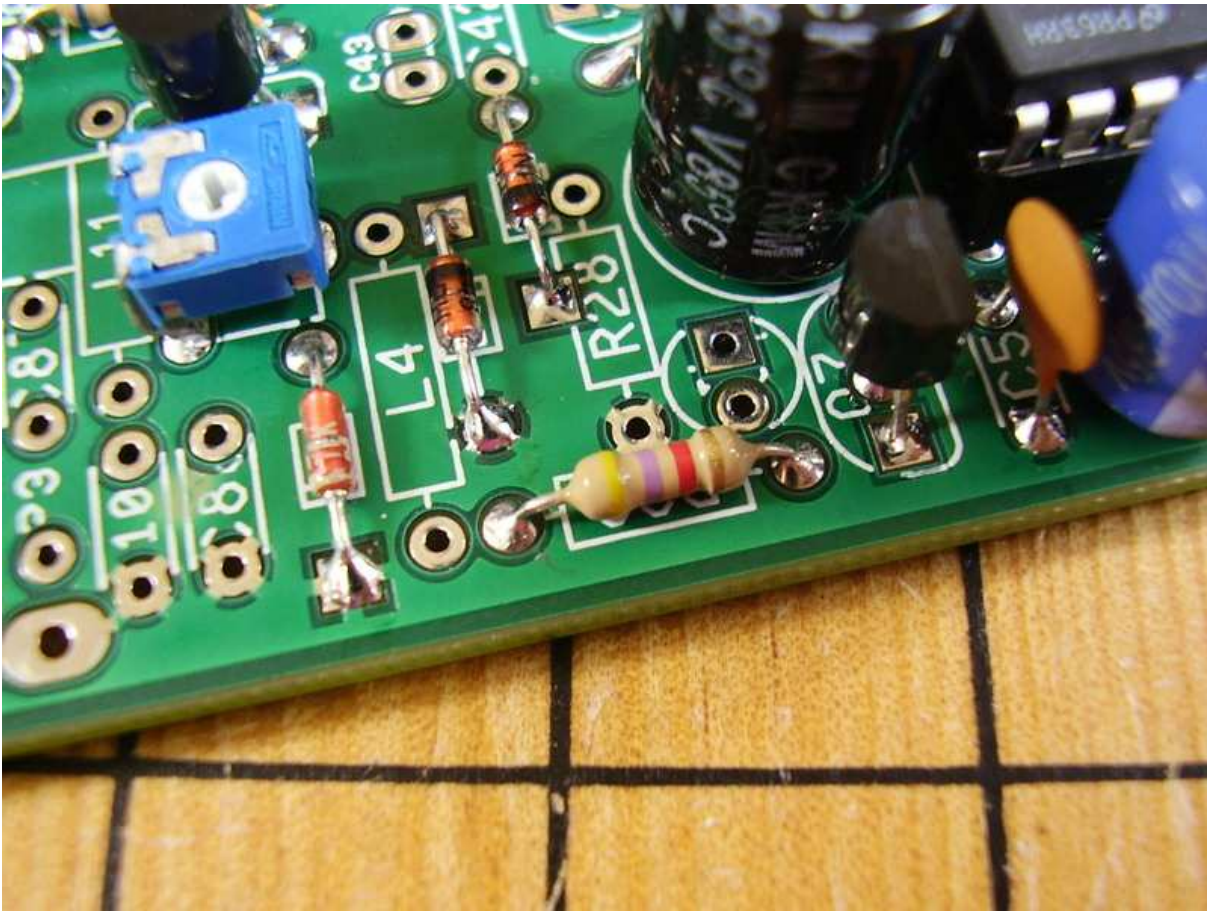

Figure 8.18: [6-15] R29 4.7K.

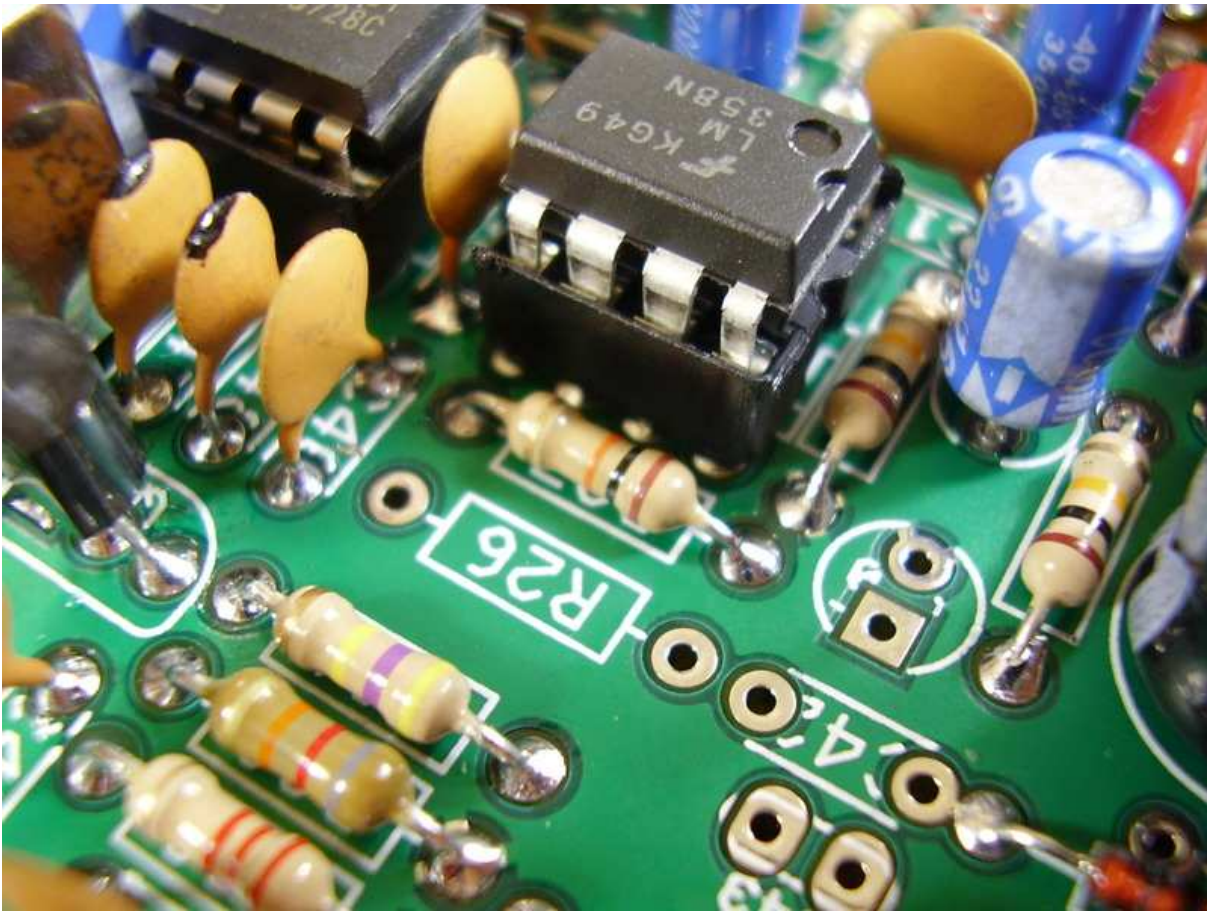

Figure 8.19: [6-16] R27 10K.

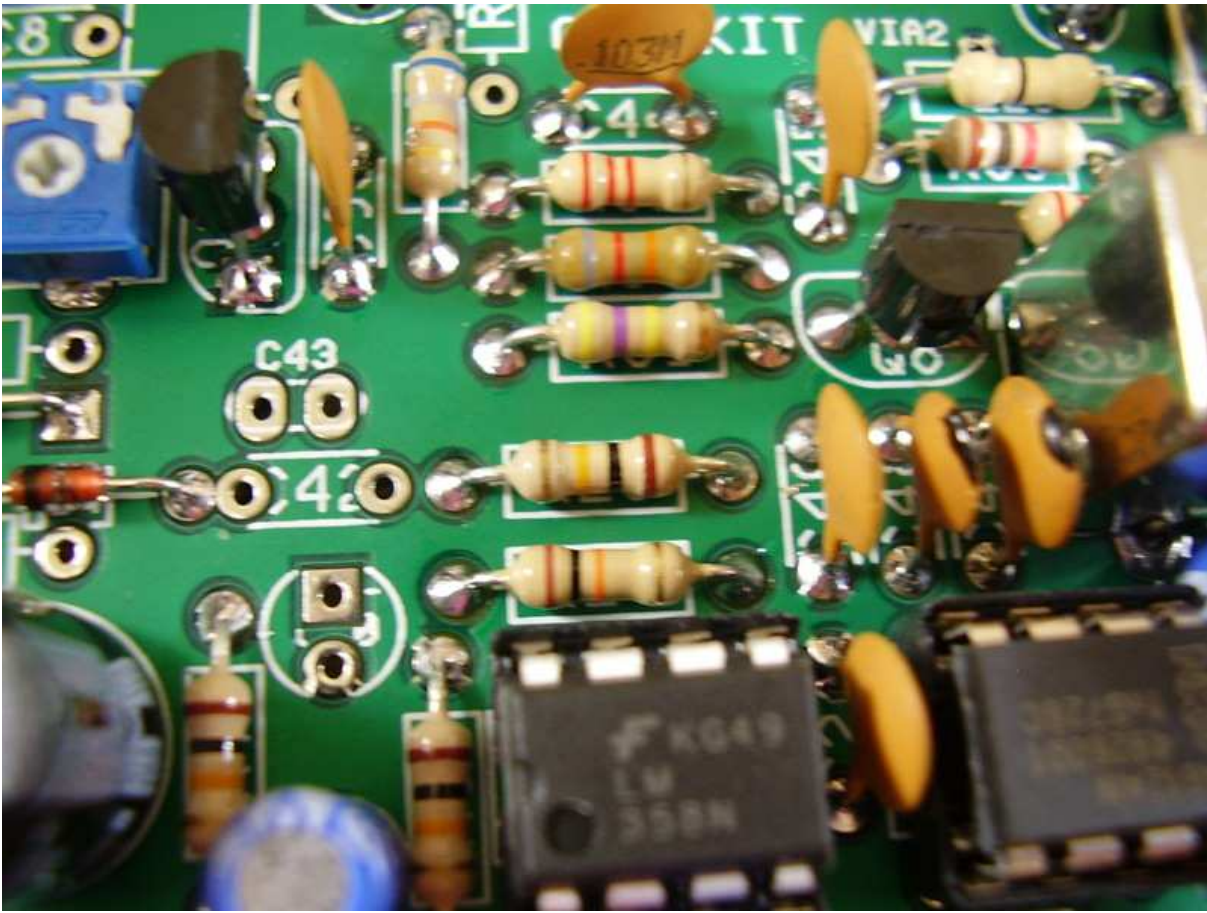

Figure 8.20: [6-17] R26 100K.

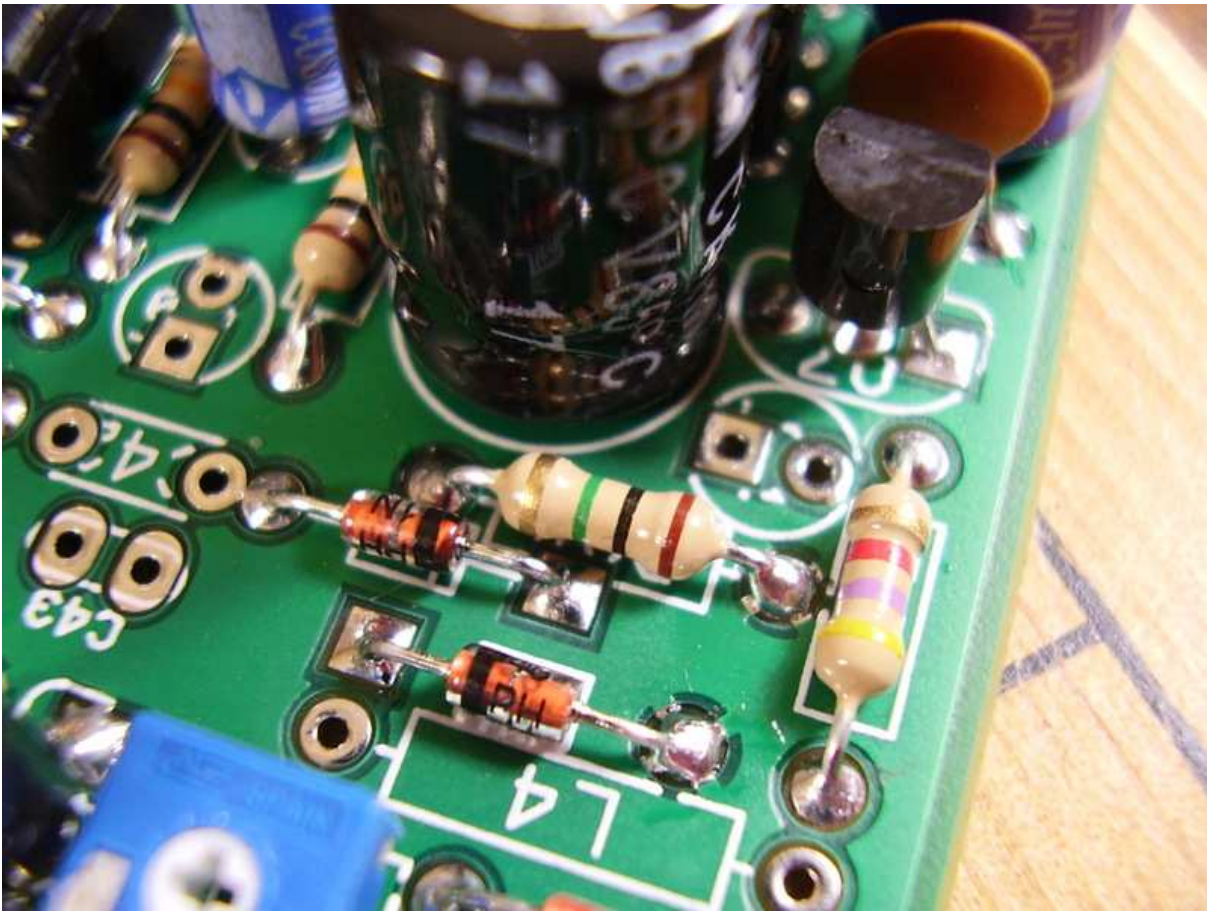

Figure 8.21: [6-18] R28 1M.

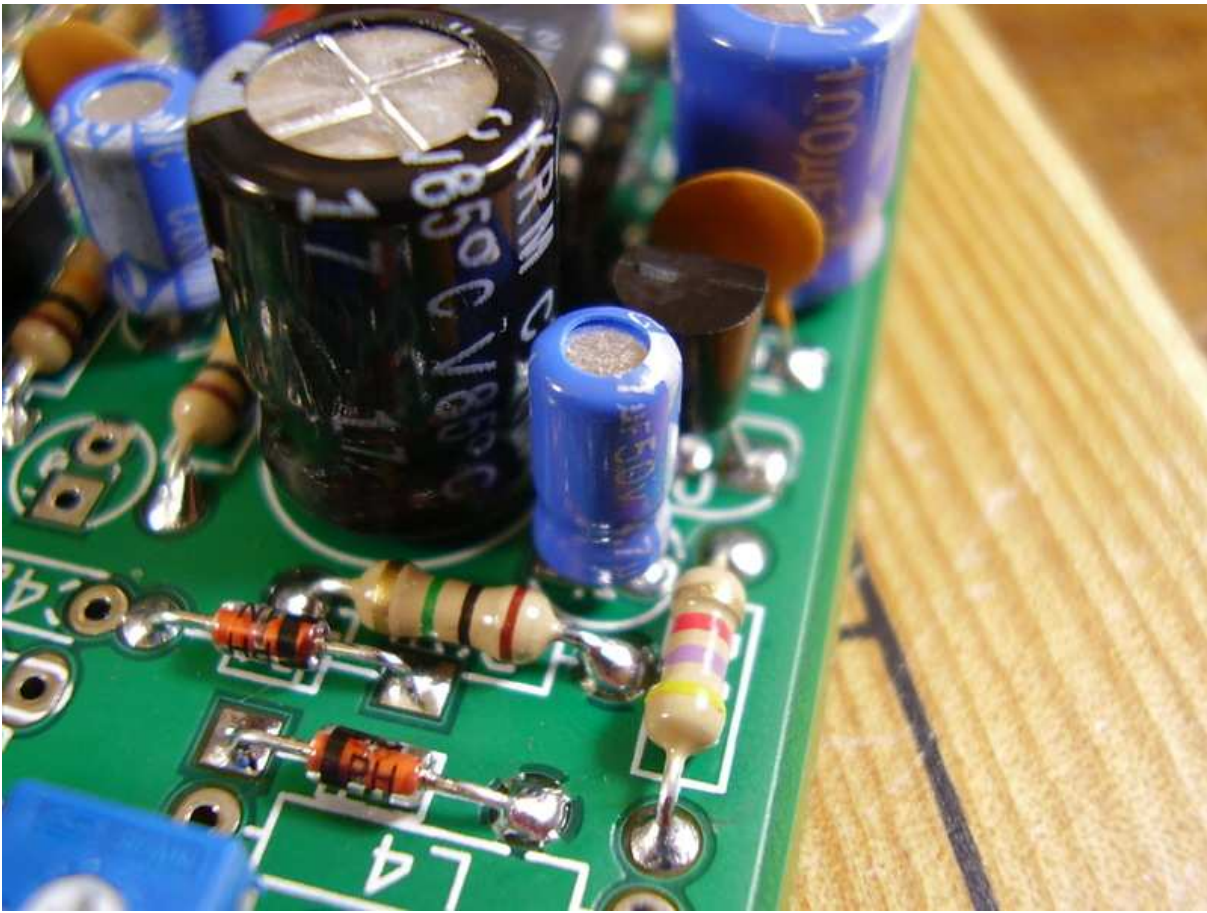

Figure 8.22: [6-19] C41 4.7 μ F.

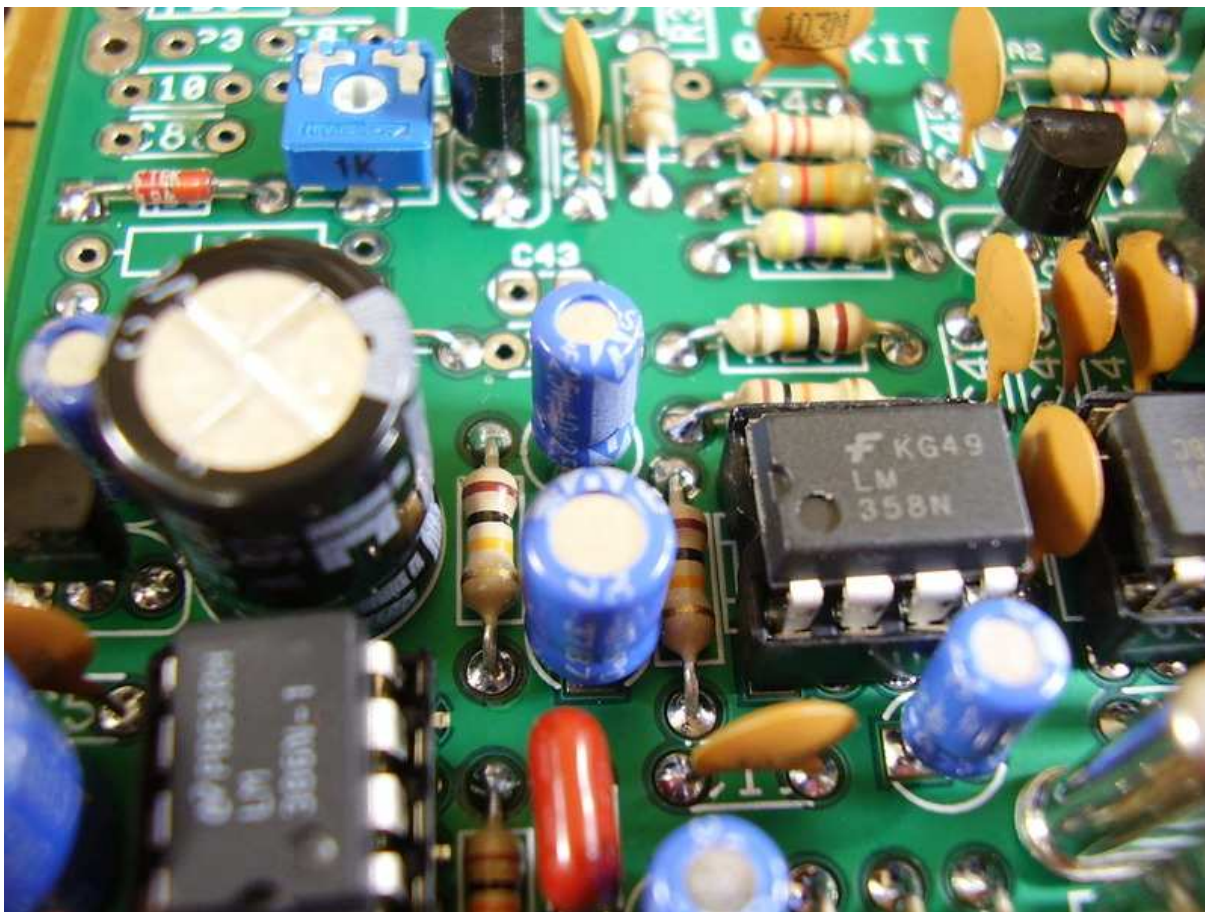

Figure 8.23: [6-20] C40 10 μ F.

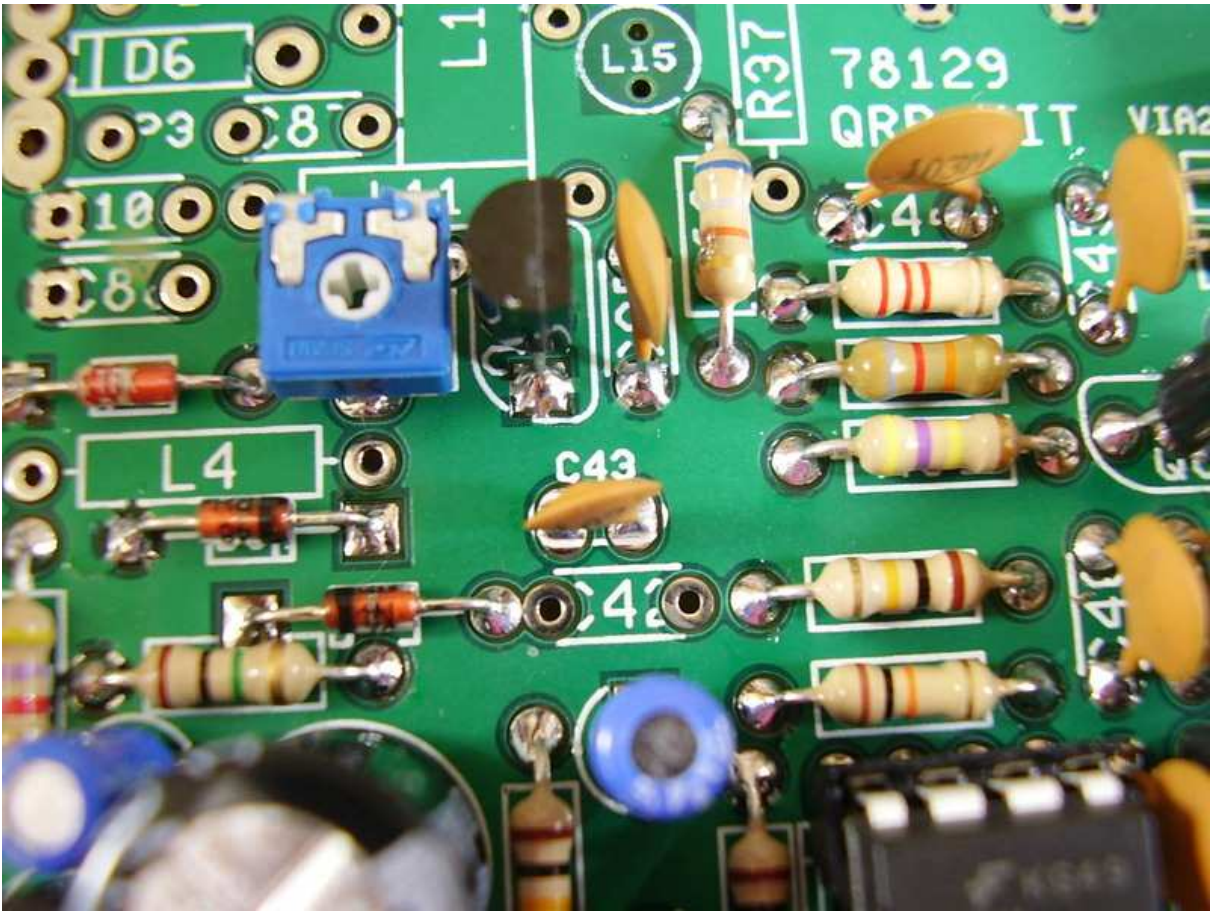

Figure 8.24: [6-21] C43 $.001\mu\text{F}$ (102).

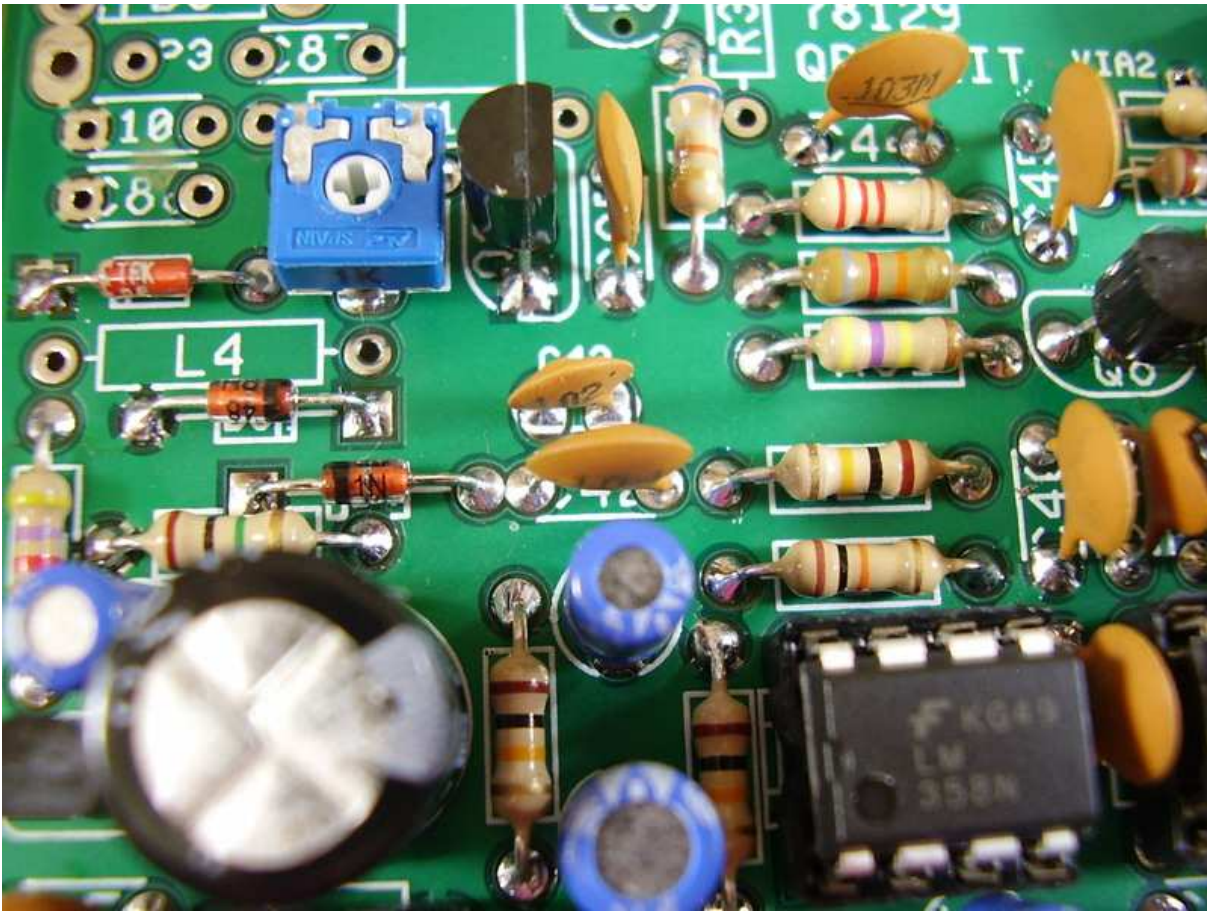

Figure 8.25: [6-22] C42 $.01\mu\text{F}$ (103).

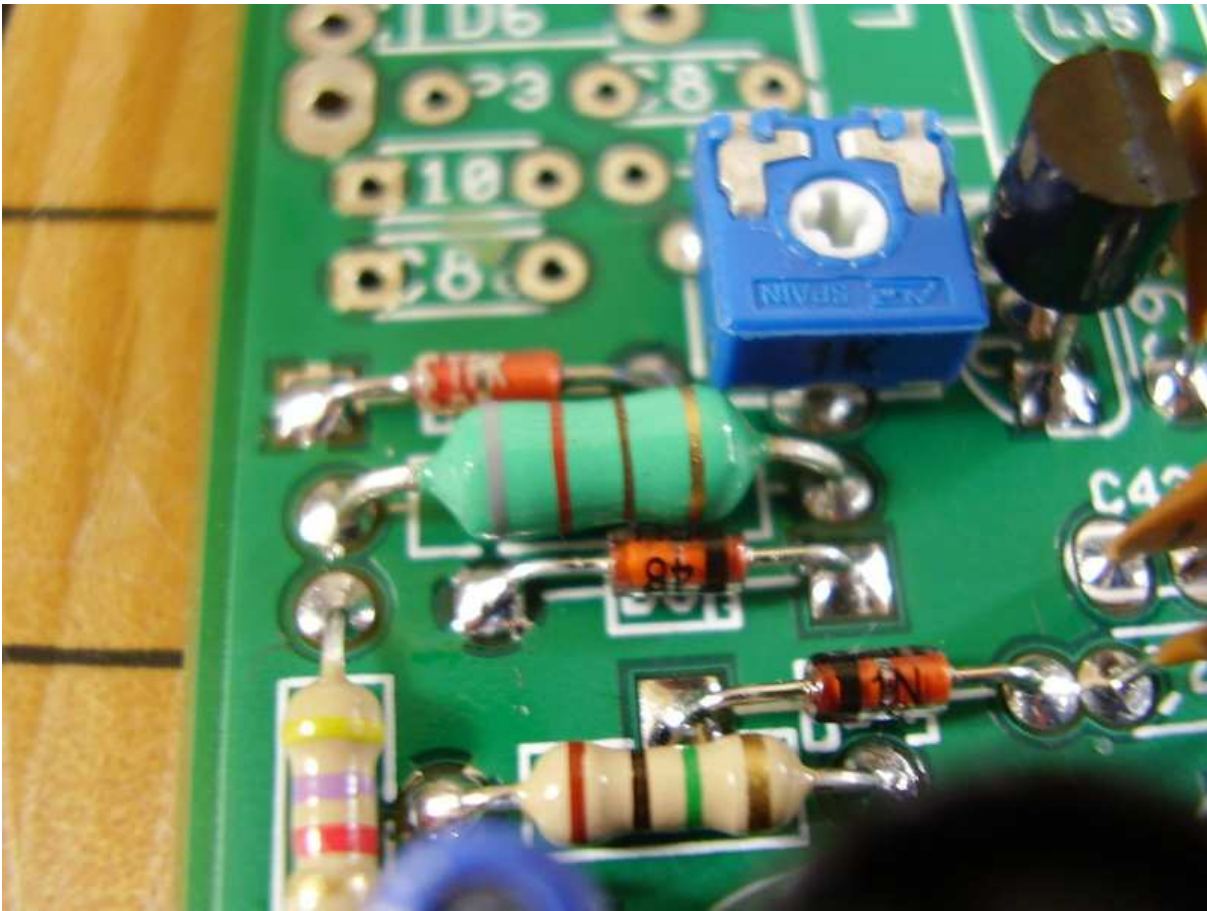

Figure 8.26: [6-23] L4 820 μ H Molded Inductor.



Figure 8.28: Lower Left-Hand Side.

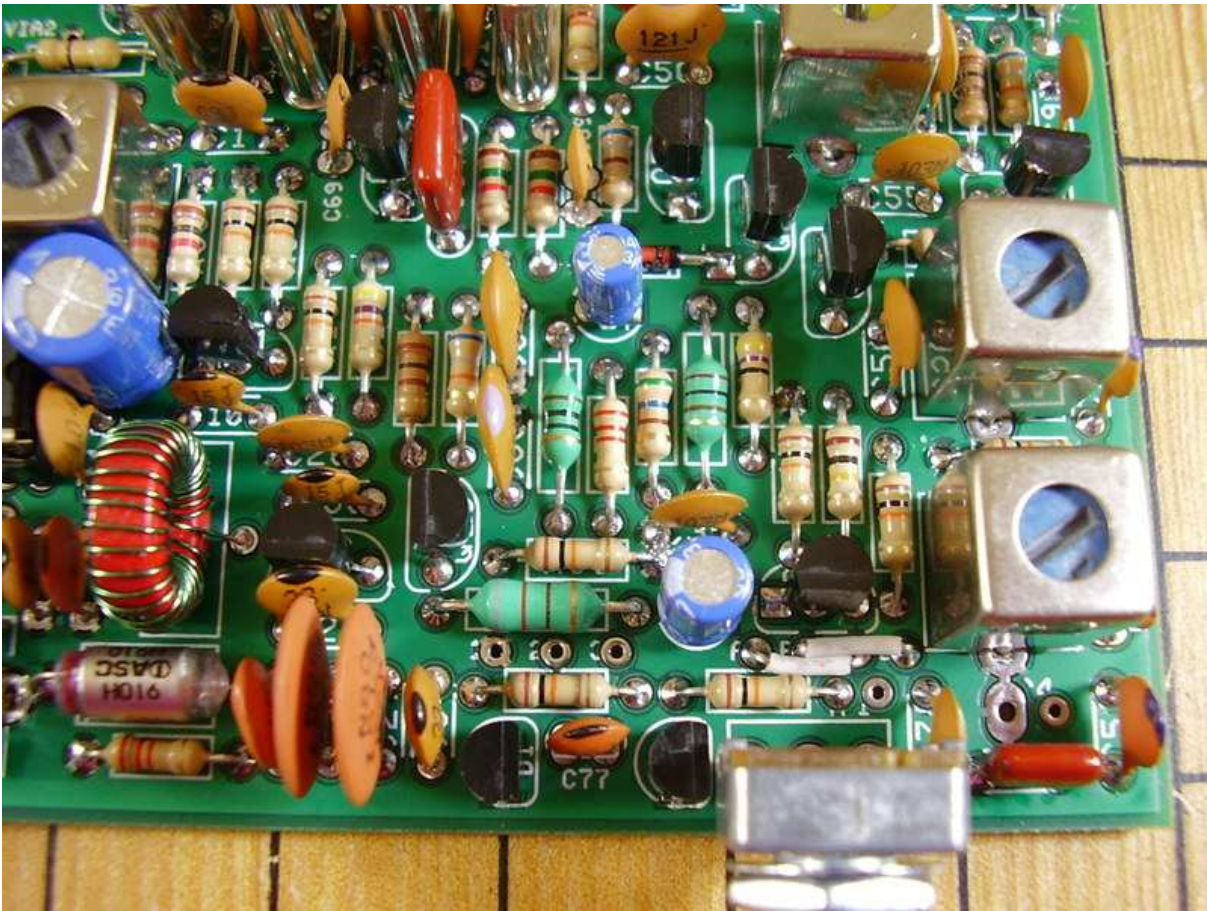

Figure 8.29: Lower Right-Hand Side.

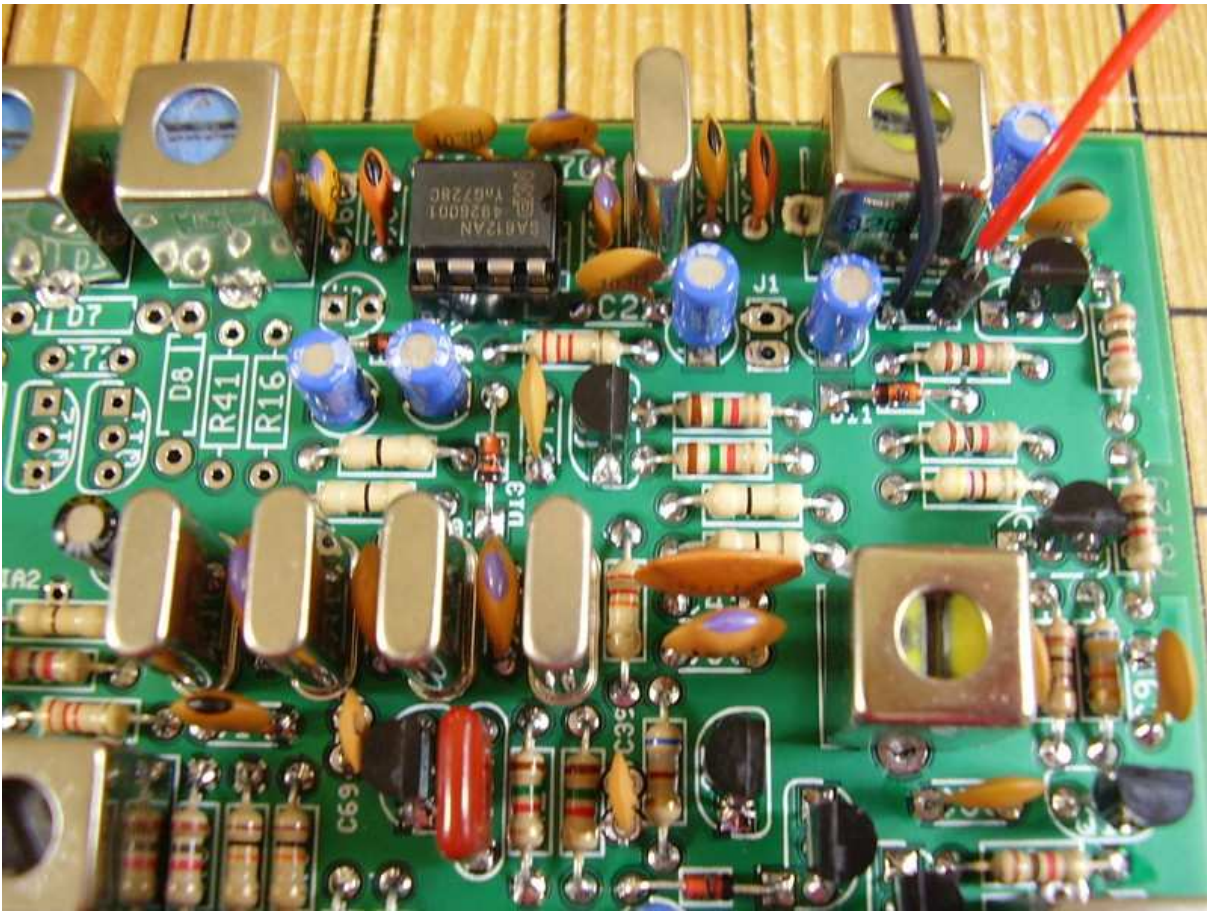

Figure 8.30: Upper Right-Hand Side.

Chapter 9

Phase 7.0 - Transmit Driver, RF Amp and Output Filter

Transmit driver, RF amplifier and RF output filter circuits will be assembled in the following steps. We are almost home free on the assembly of the transceiver.

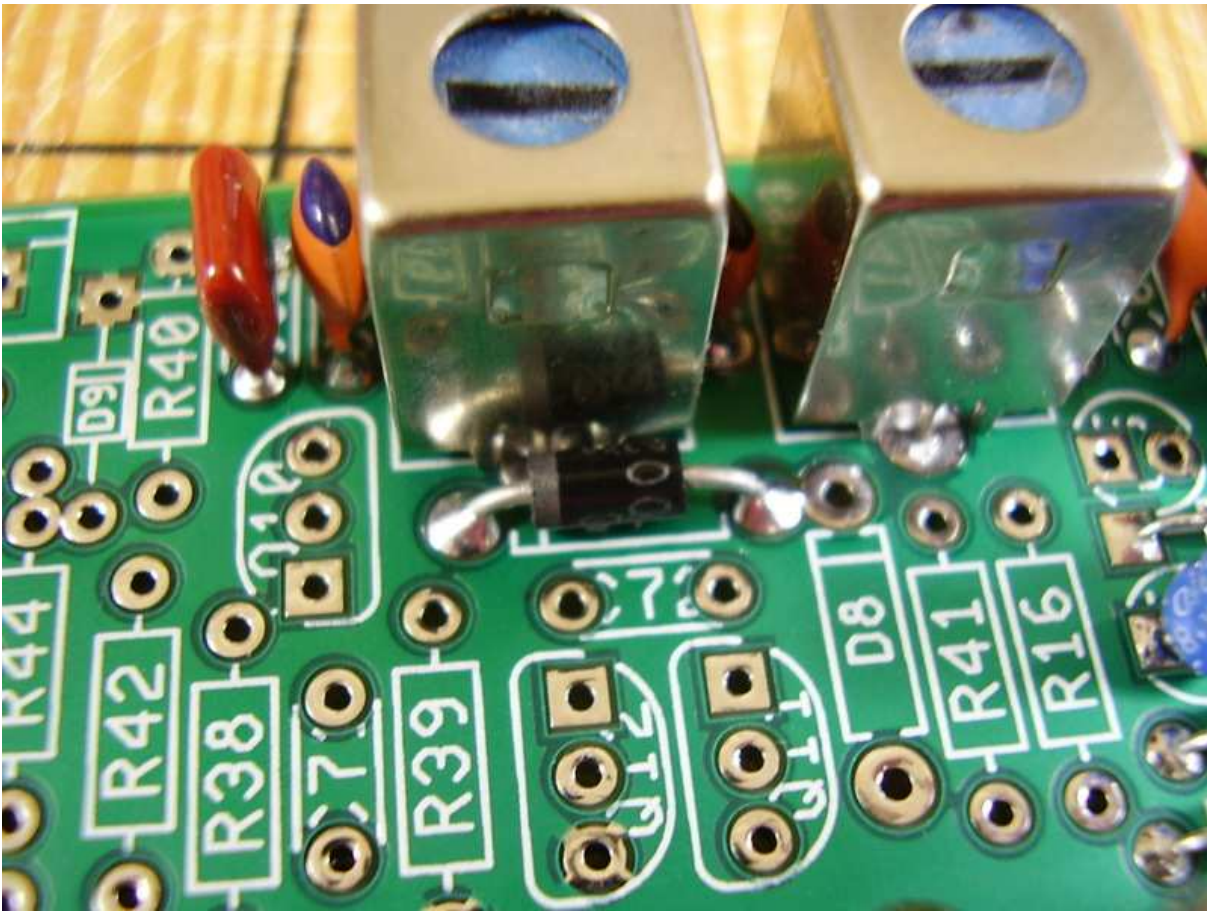

Figure 9.1: [7-1] D7 1N4002 Diode.

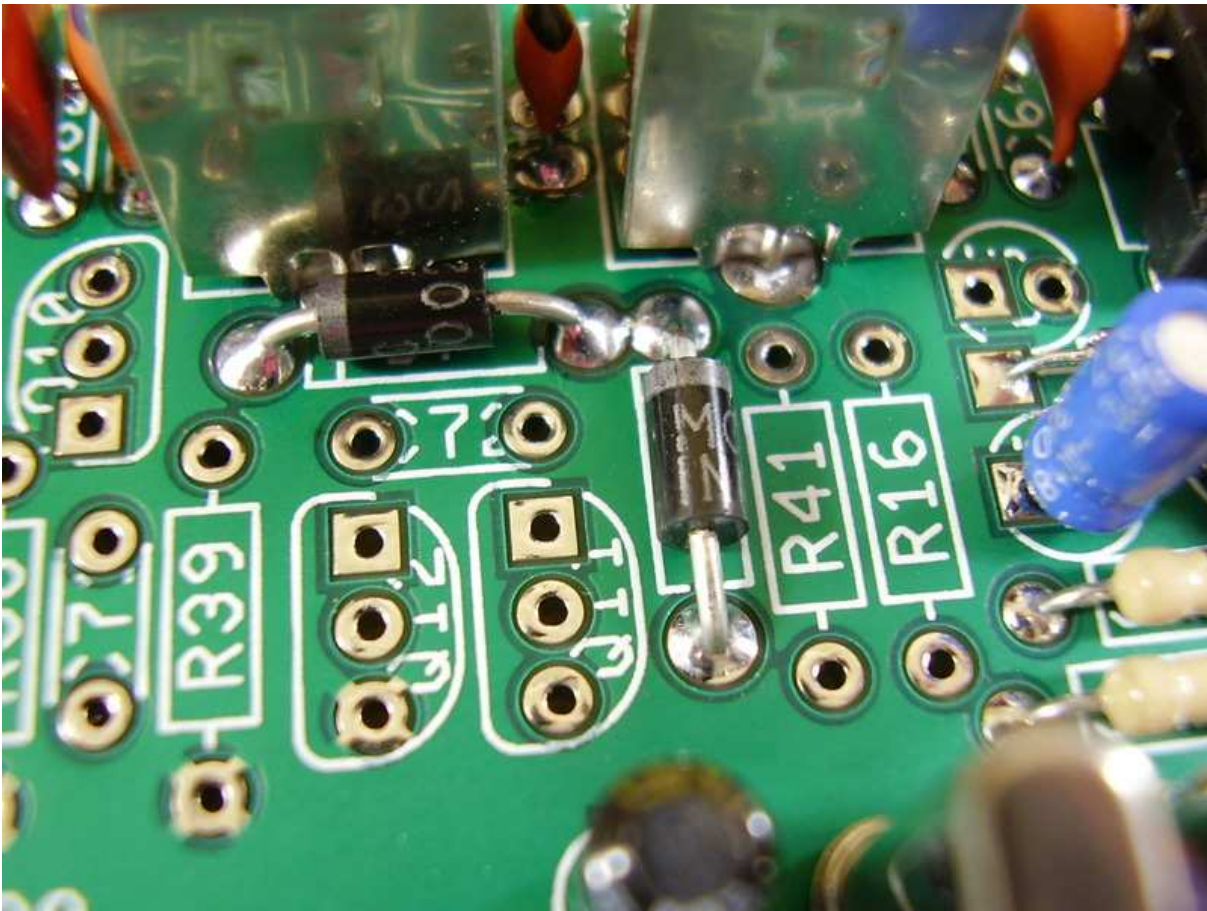

Figure 9.2: [7-2] D8 1N4002 Diode.

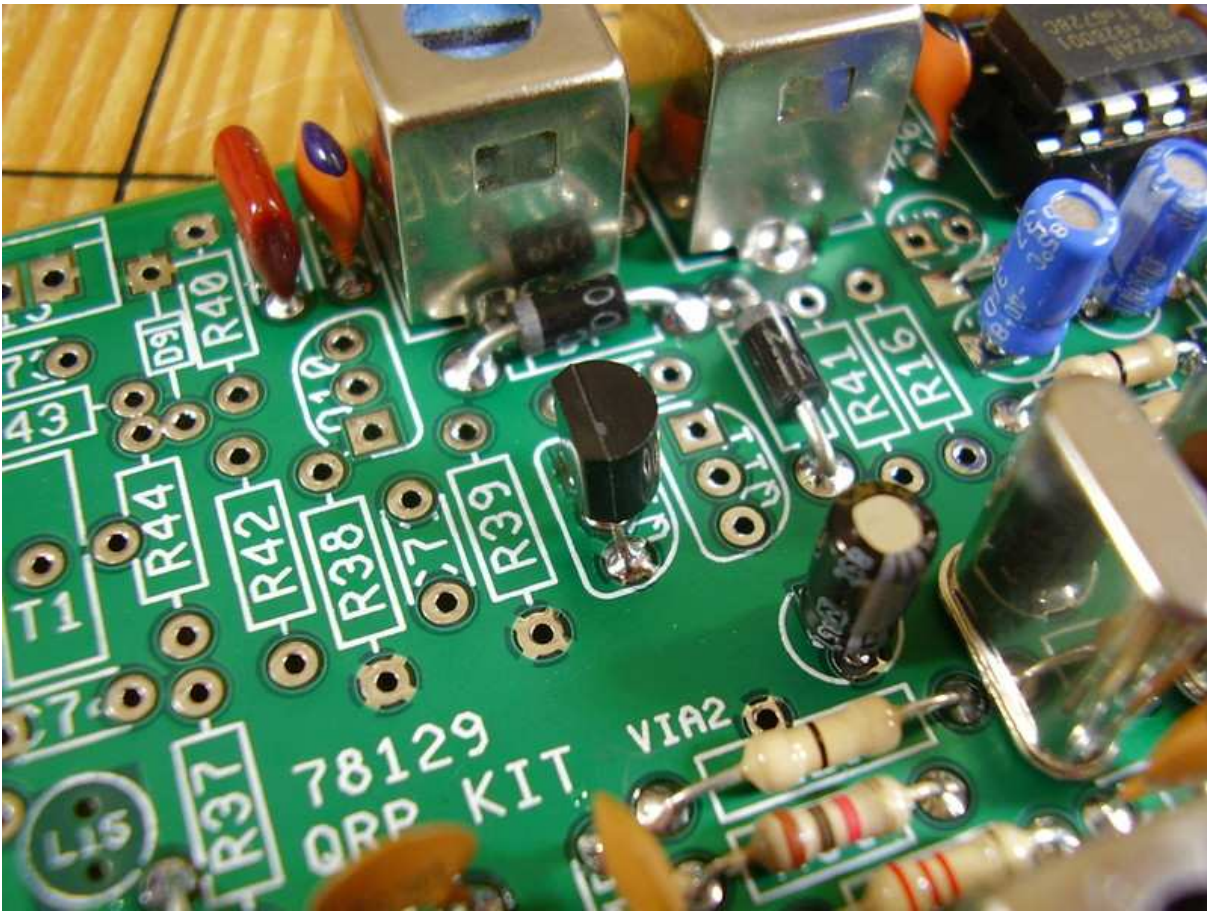

Figure 9.3: [7-3] Q12 2N4126.

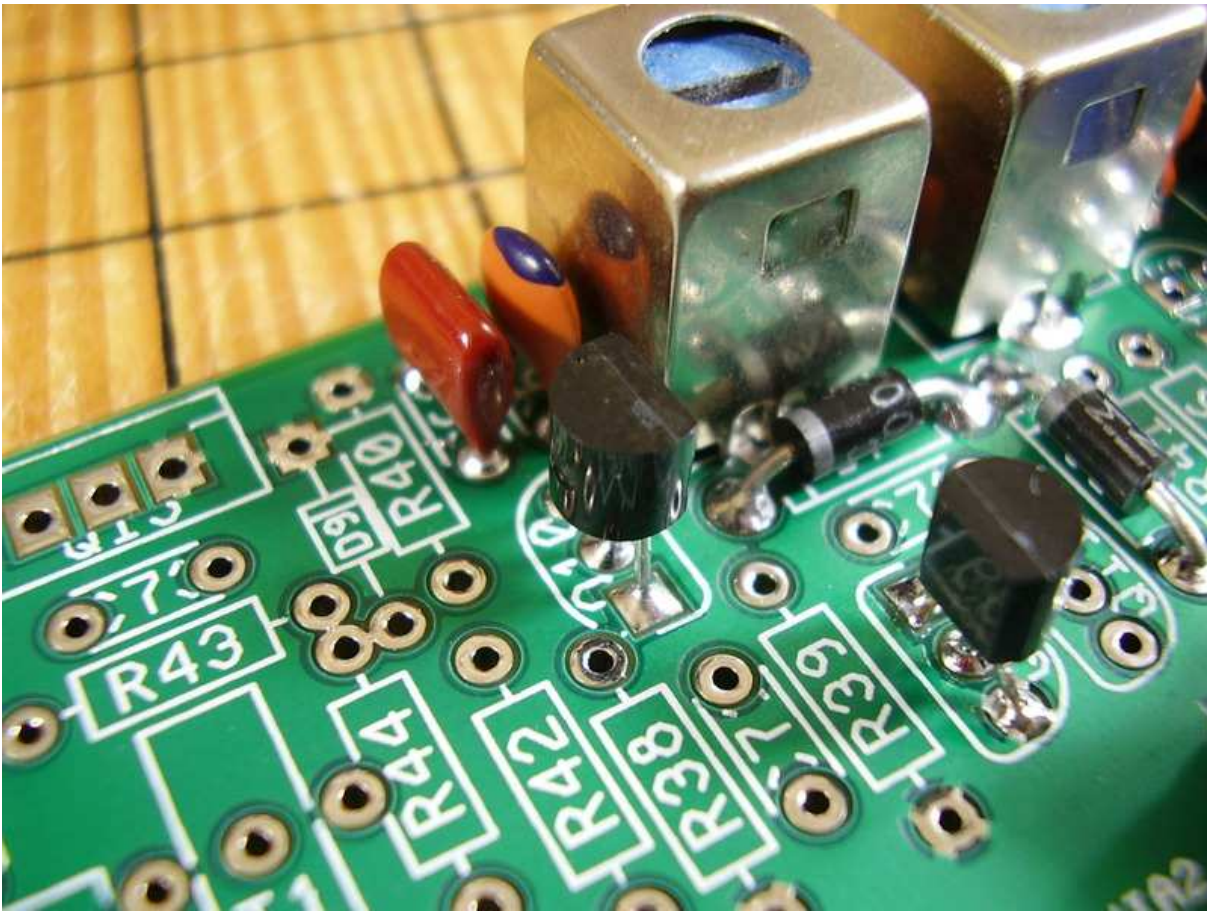

Figure 9.4: [7-4a] Q10 2N4124.

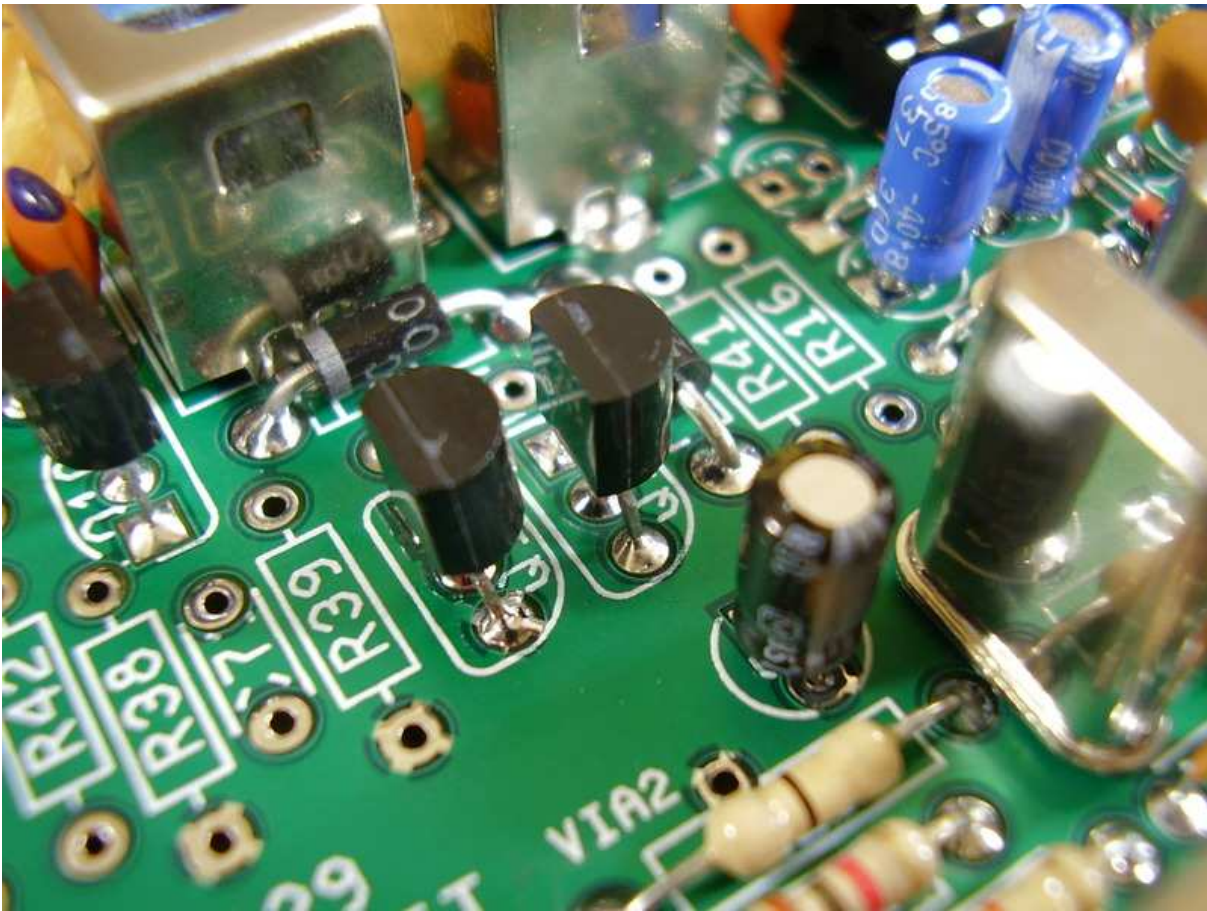

Figure 9.5: [7-4b] Q11 2N4124.

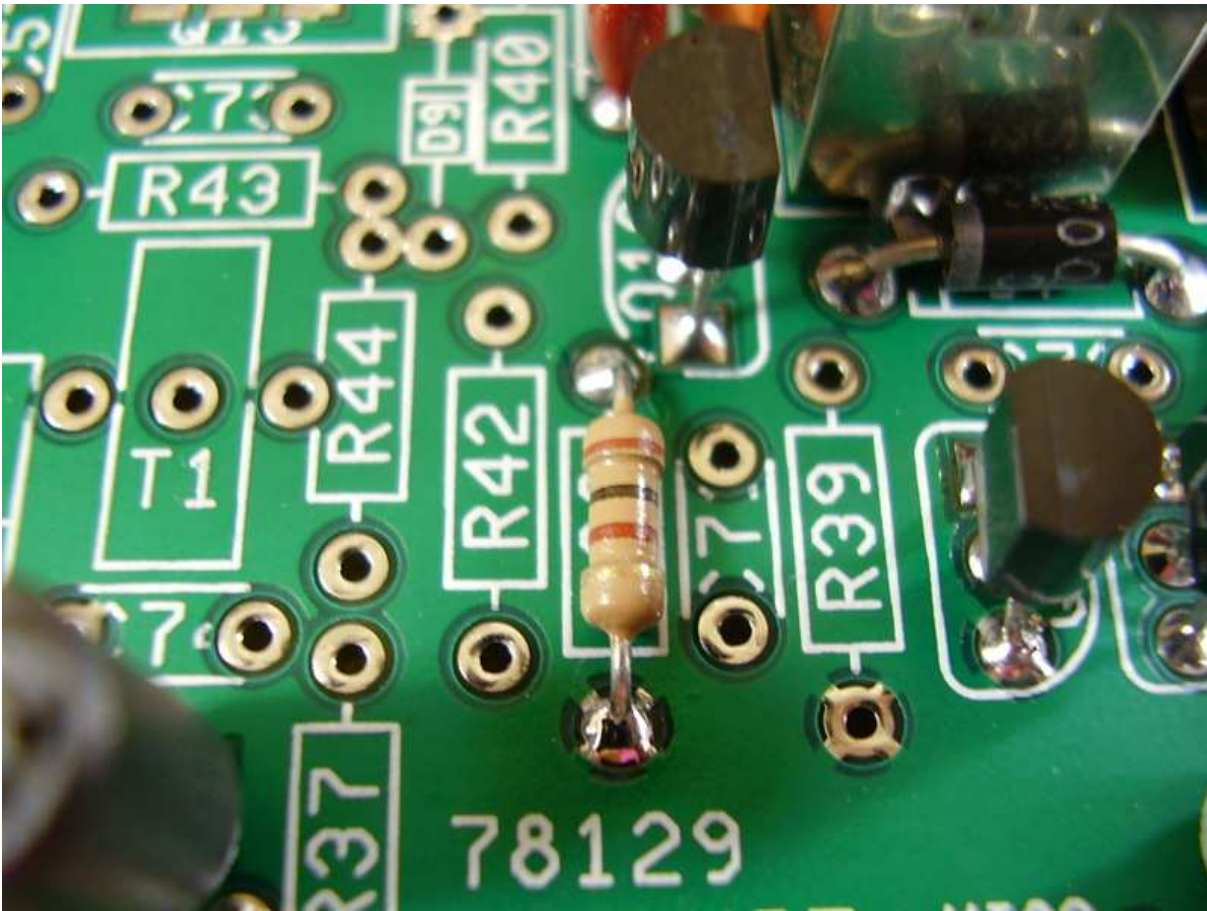

Figure 9.7: [7-7] R38 100 ohms.

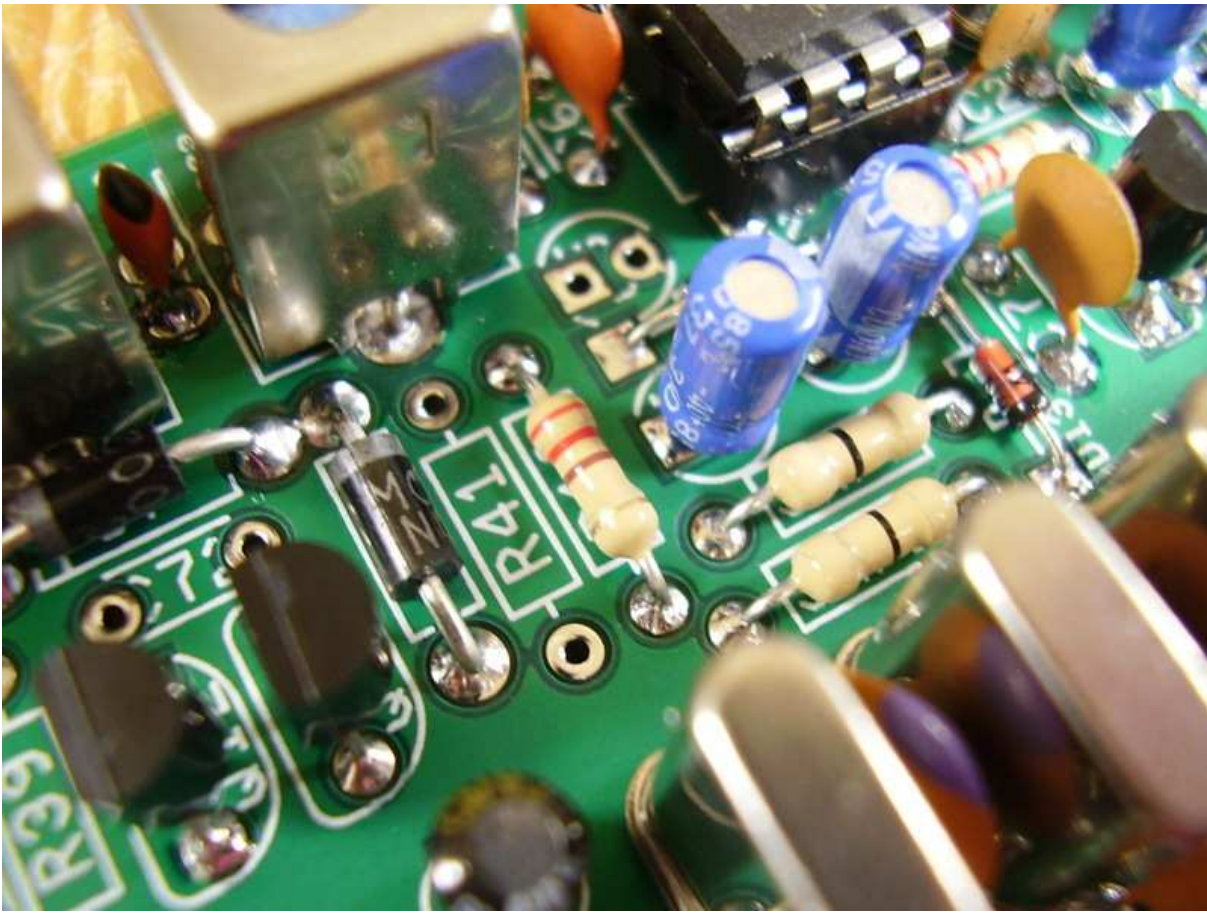

Figure 9.8: [7-8] R16 220 ohms .

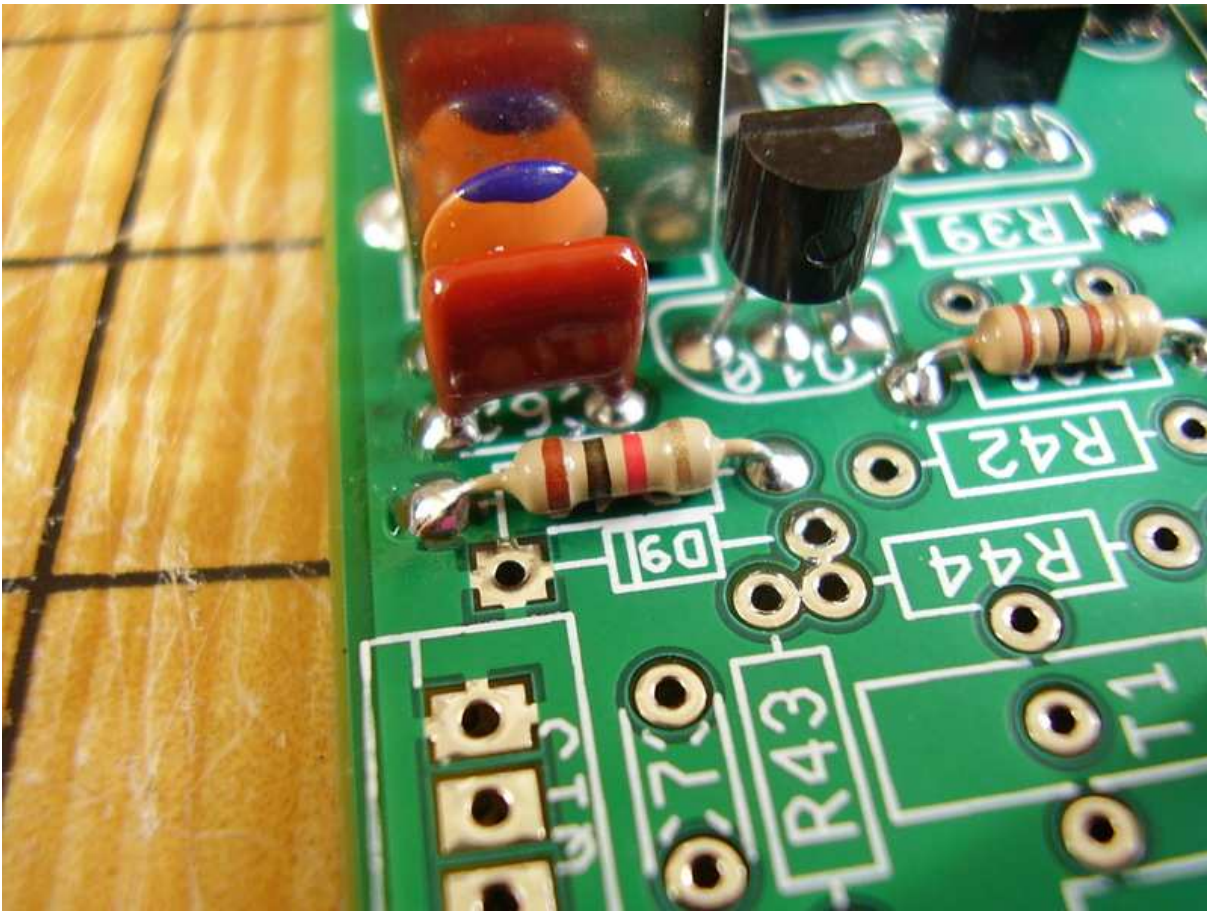

Figure 9.9: [7-9] R40 1K.

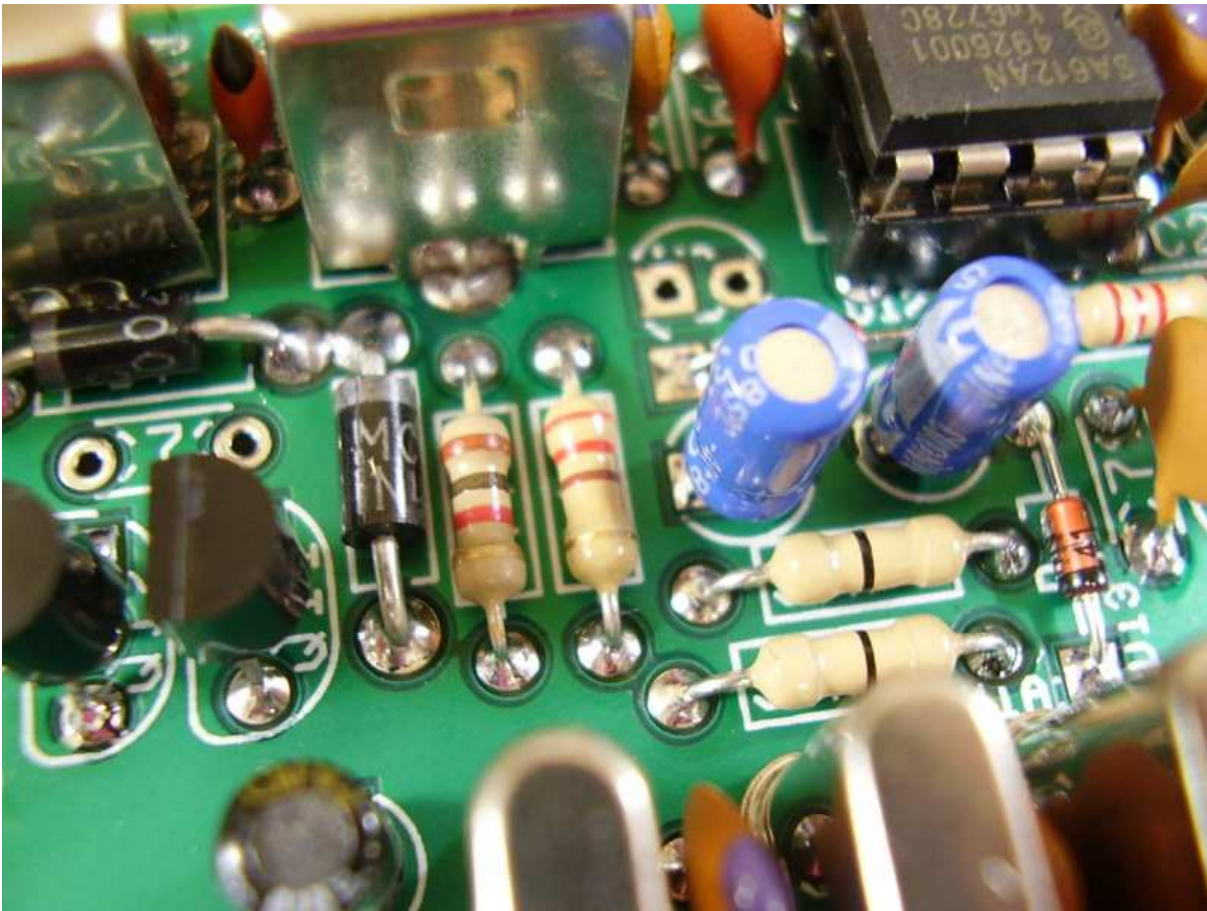

Figure 9.10: [7-10] R41 1K.

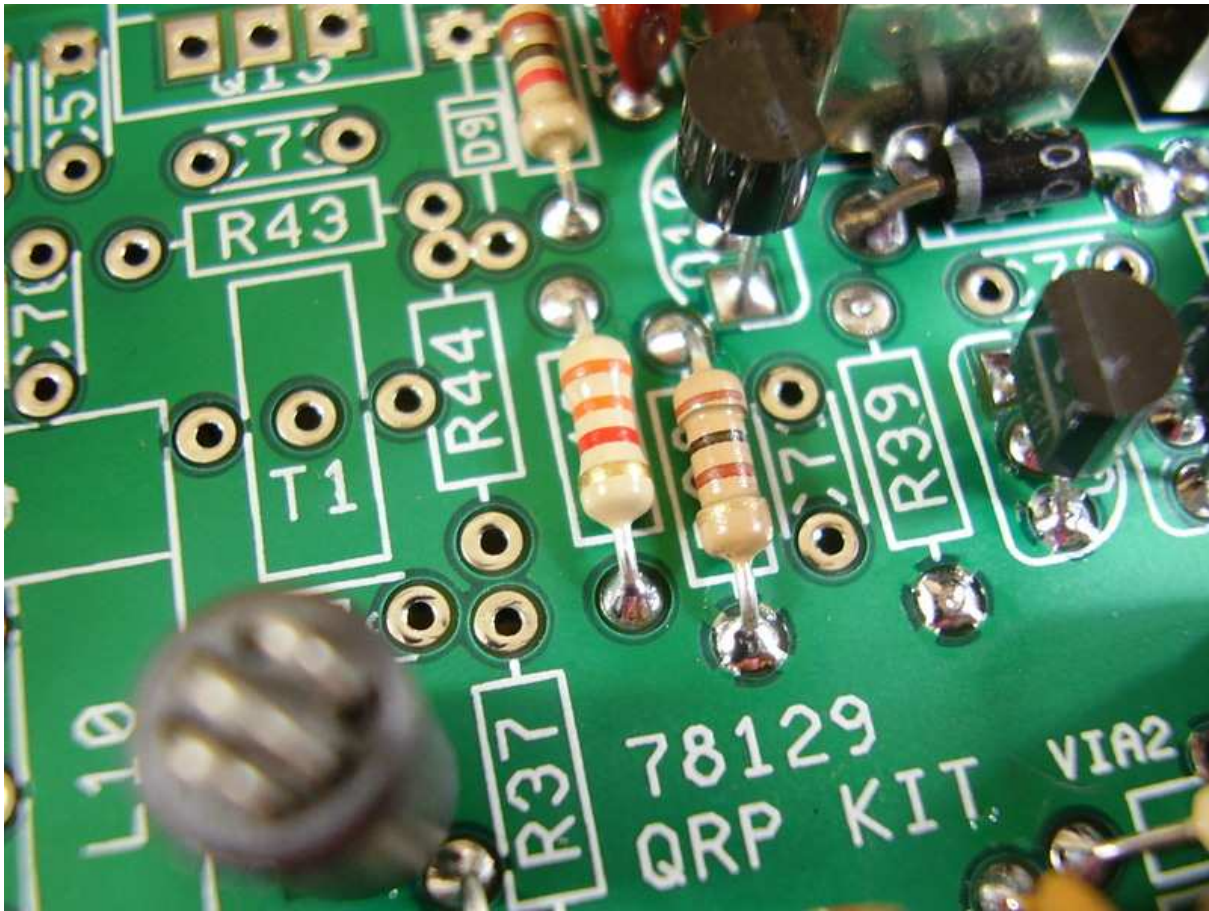

Figure 9.11: [7-11] R42 3.3K.

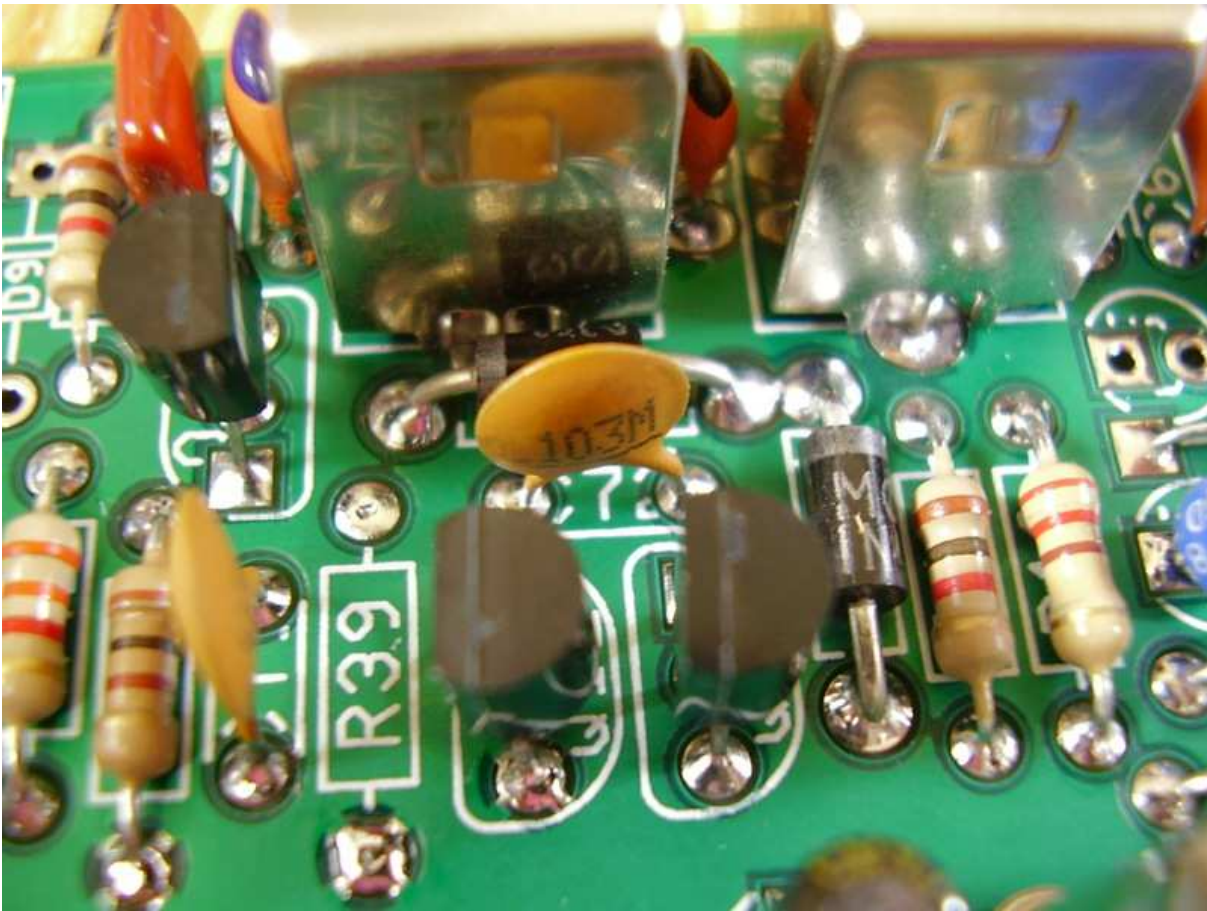

Figure 9.12: [7-12] C71 $.01\mu\text{F}$ (103).

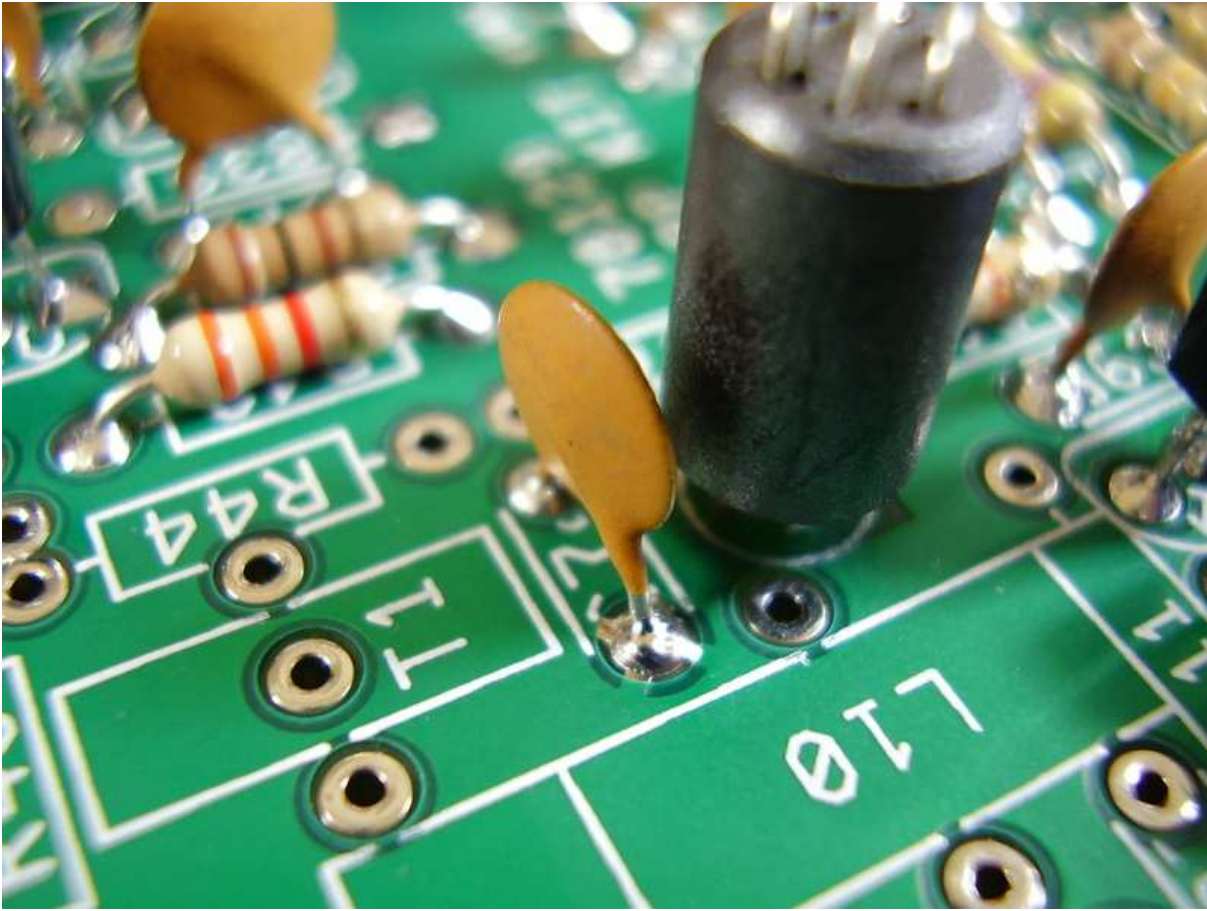

Figure 9.13: [7-13] C72 $.01\mu\text{F}$.

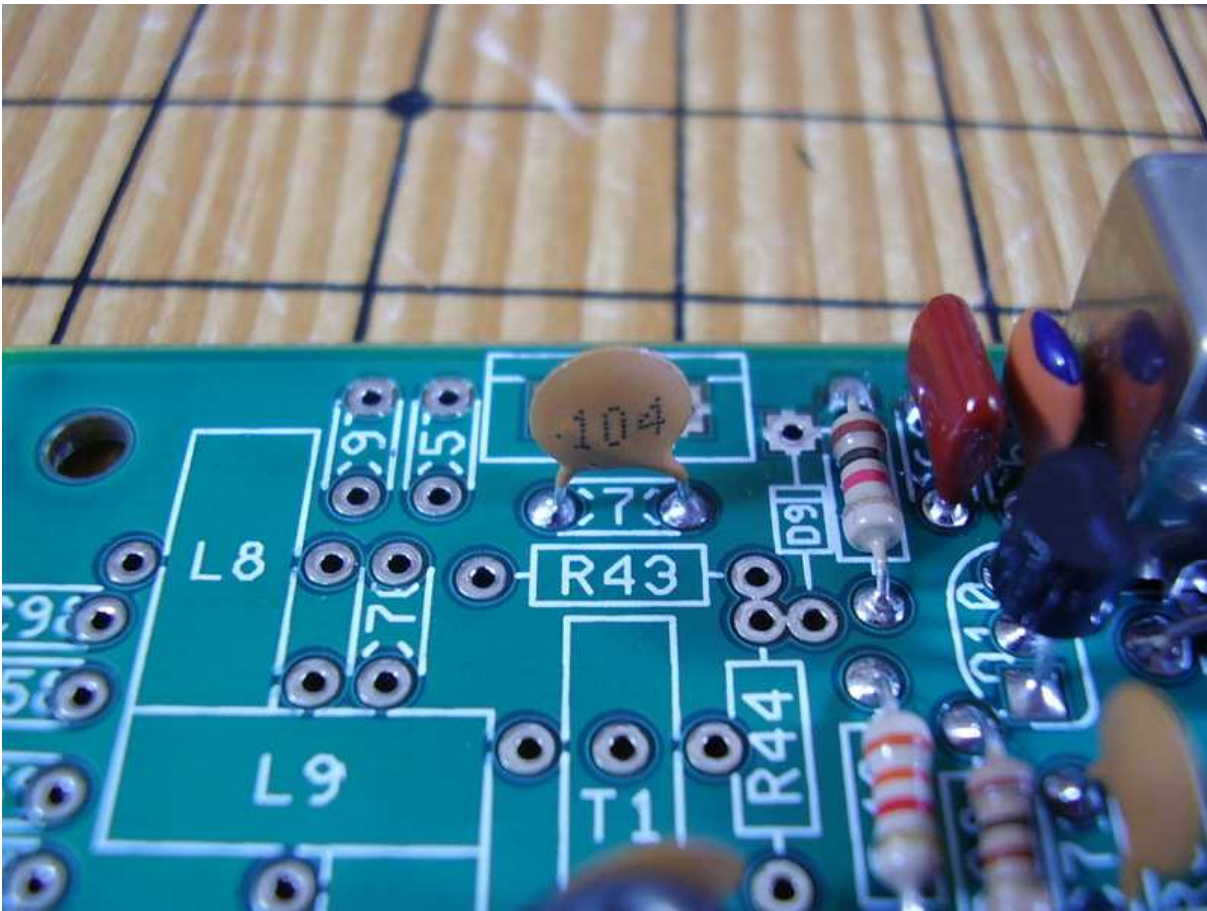

Figure 9.14: [7-15] C73 .1 μ F (104).

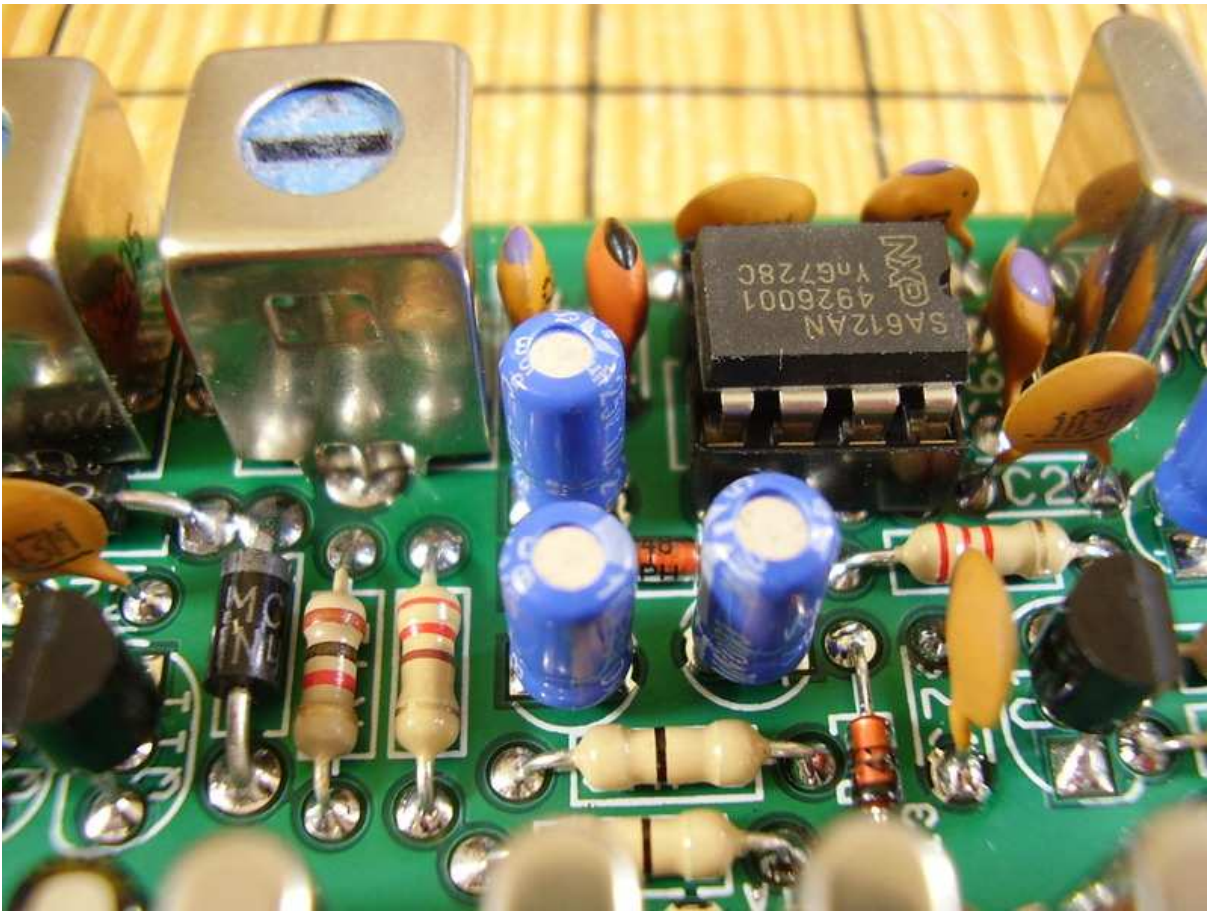

Figure 9.15: [7-16] C75 10 μ F.

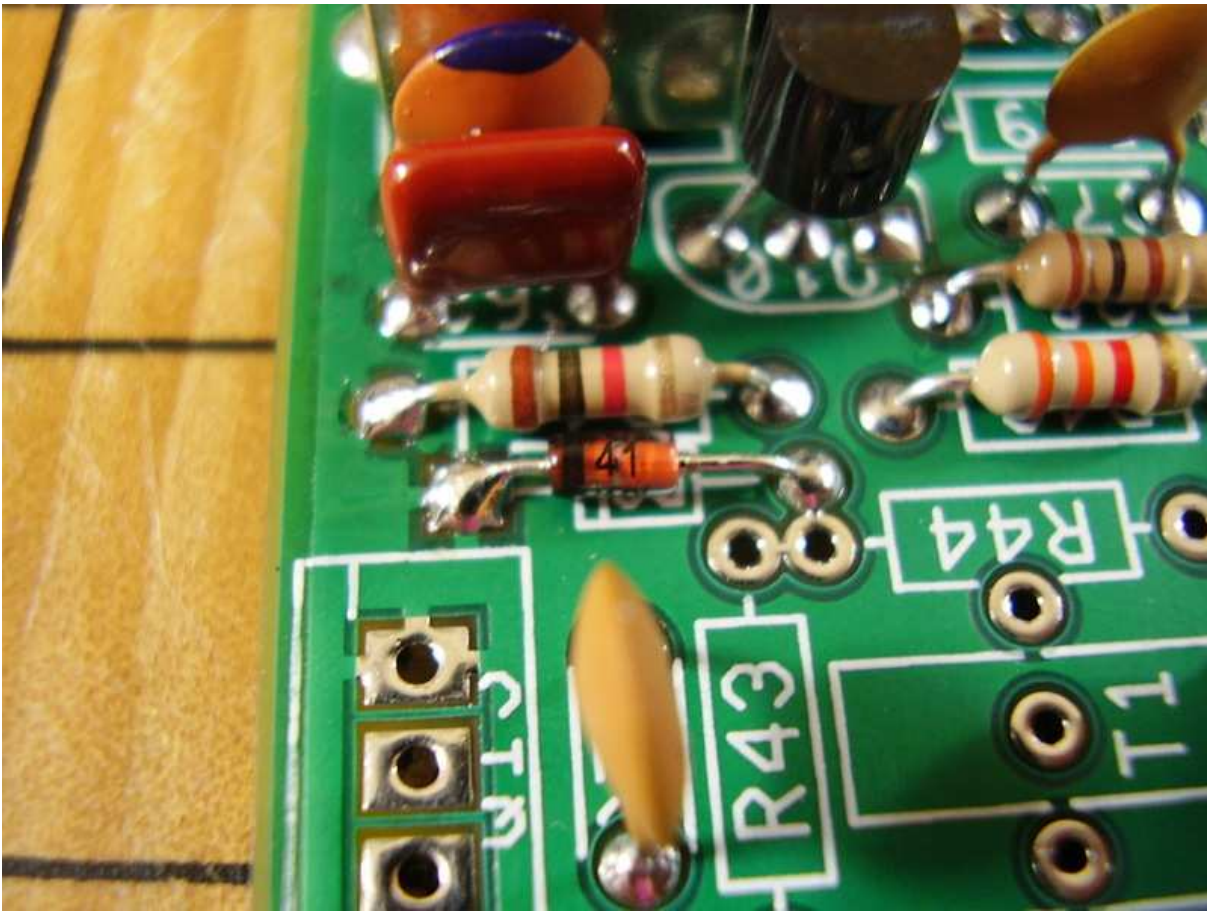

Figure 9.16: [7-17] D9 1N4148.

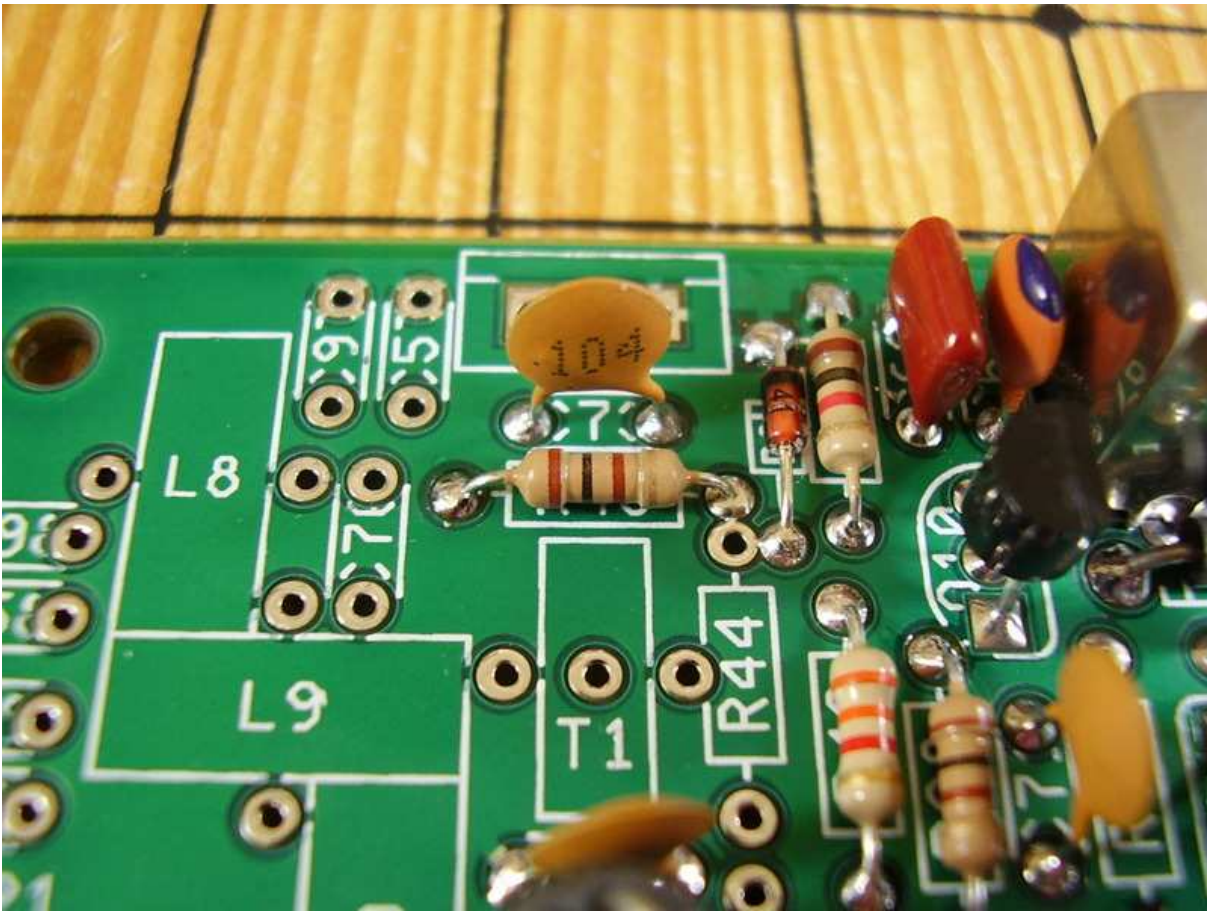

Figure 9.17: [7-18] R43 100 ohms.

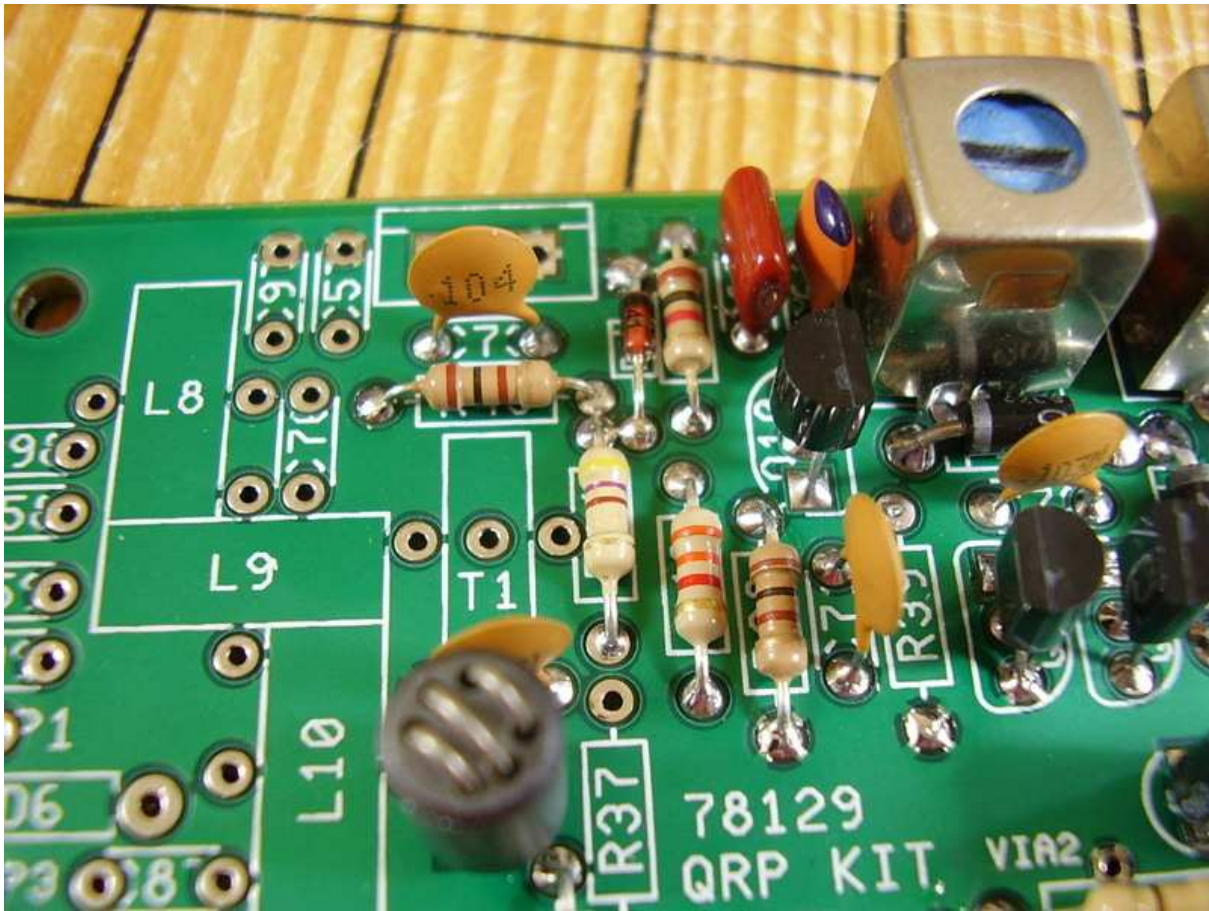

Figure 9.18: [7-19] R44 470 ohms.

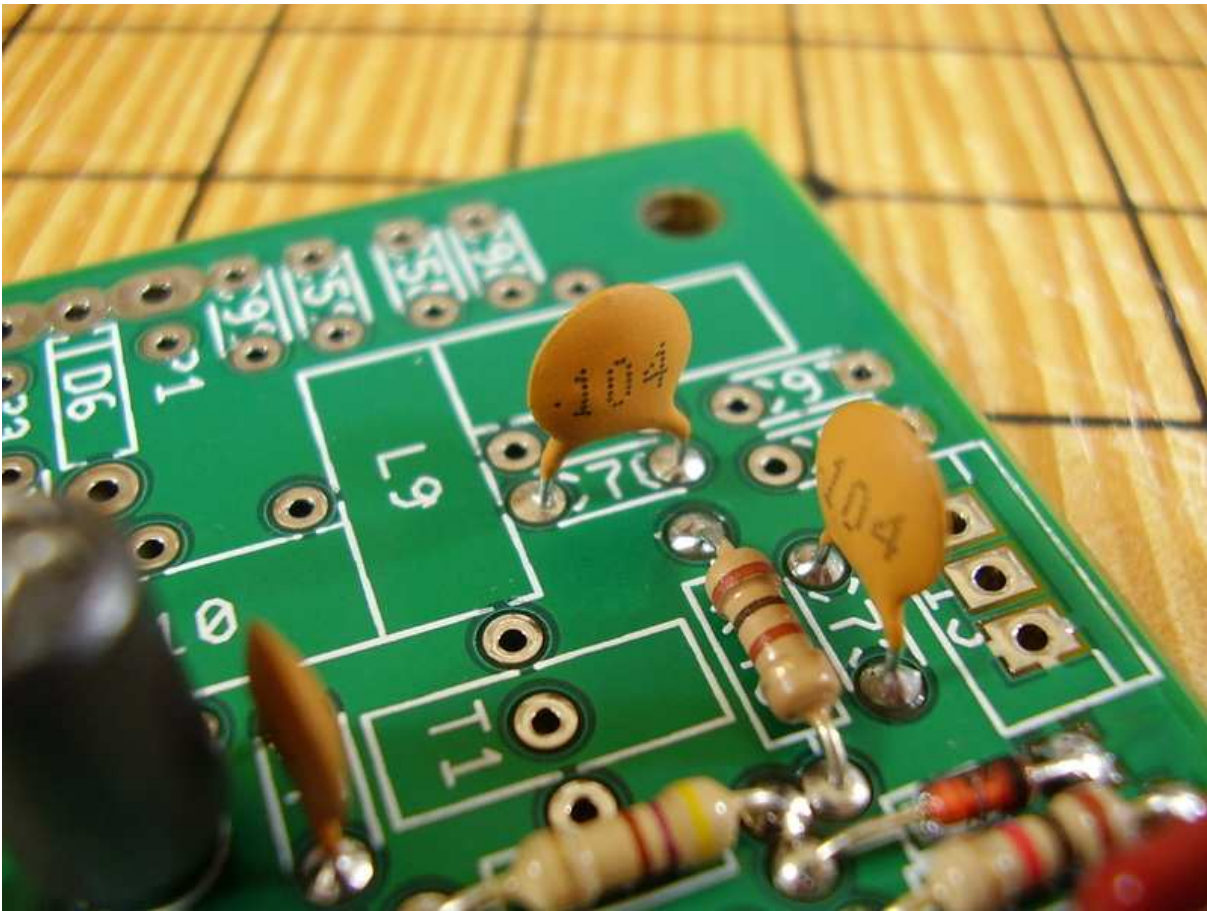

Figure 9.19: [7-20] C76 $.1\mu\text{F}$.

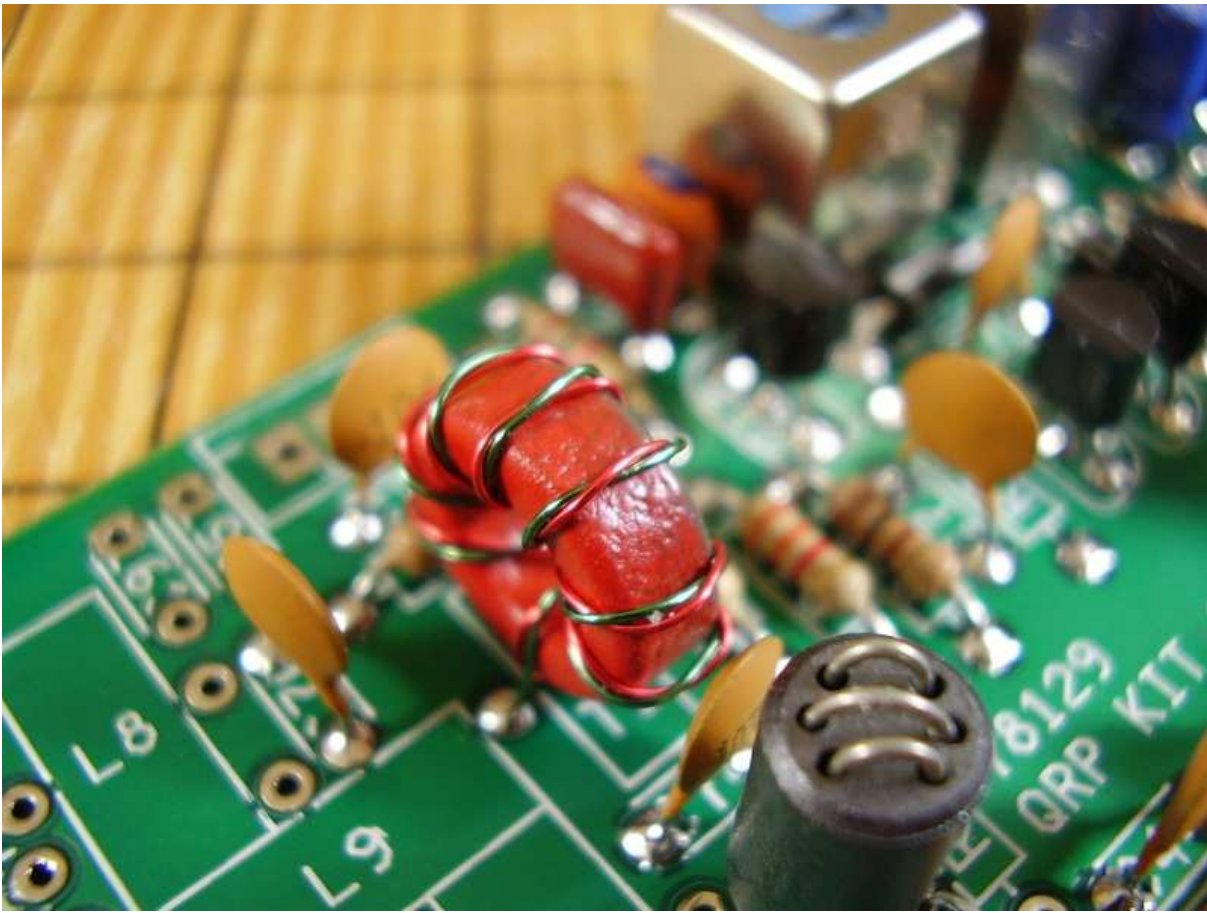

Figure 9.20: [7-21] T1 Toroid Transformer.

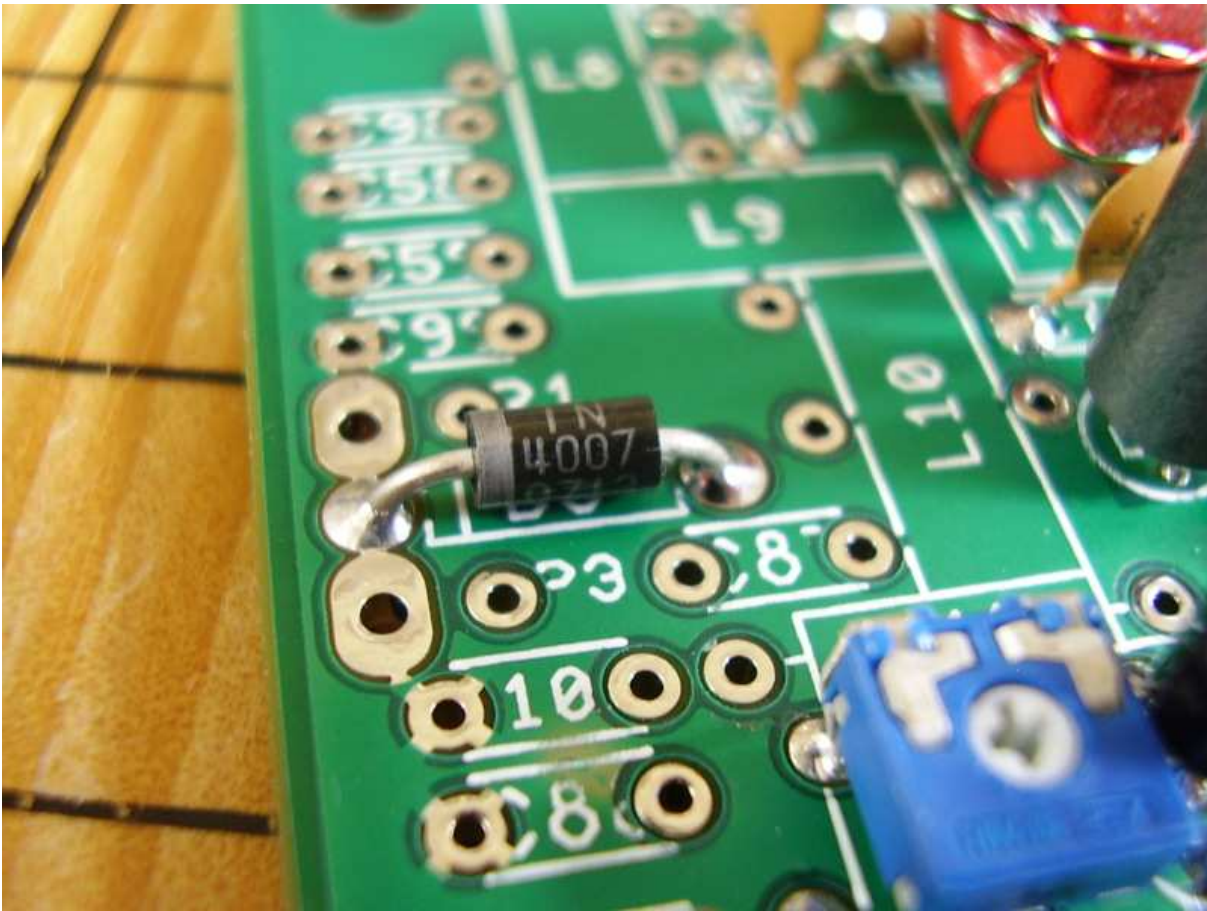

Figure 9.21: [7-23] D6 1N4007.

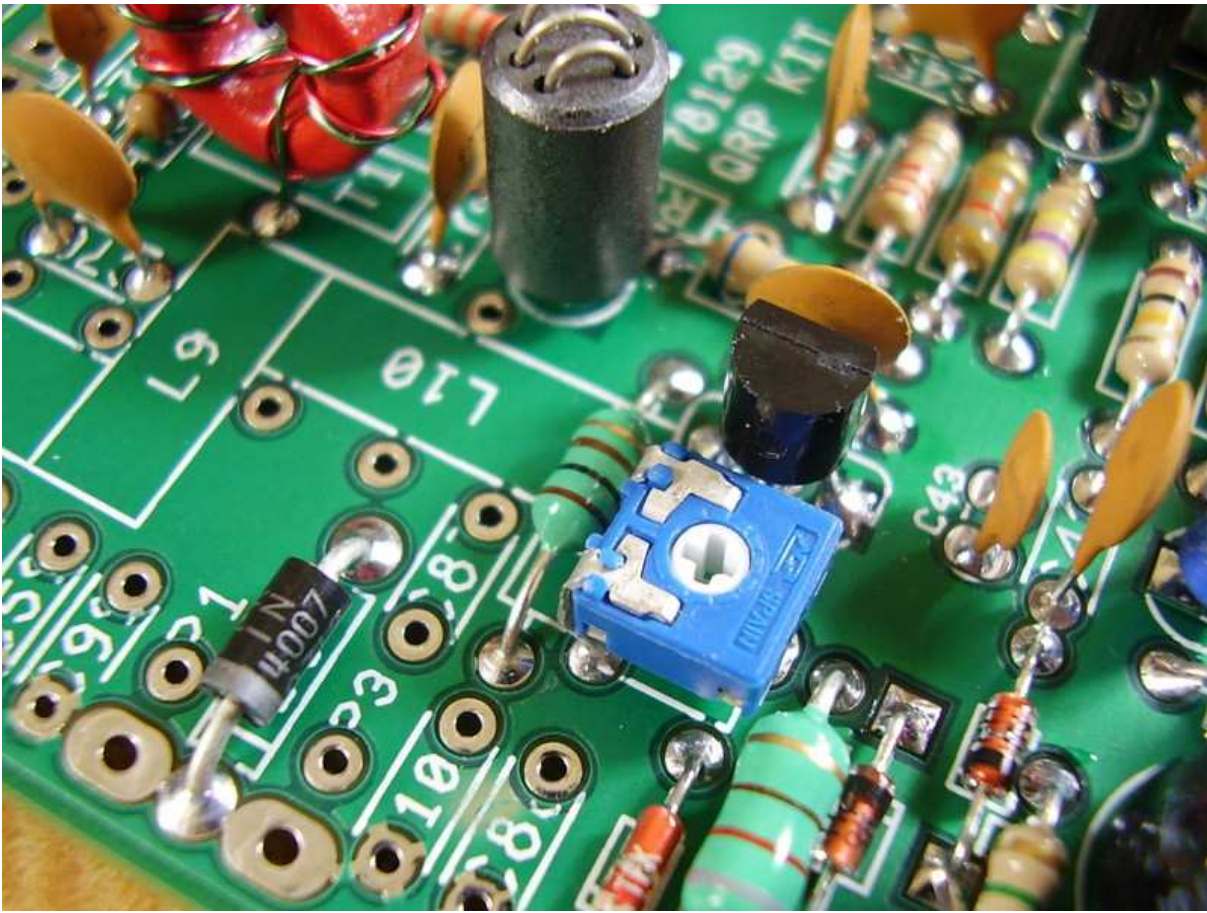

Figure 9.22: [7-24] L11 $100\mu\text{H}$.

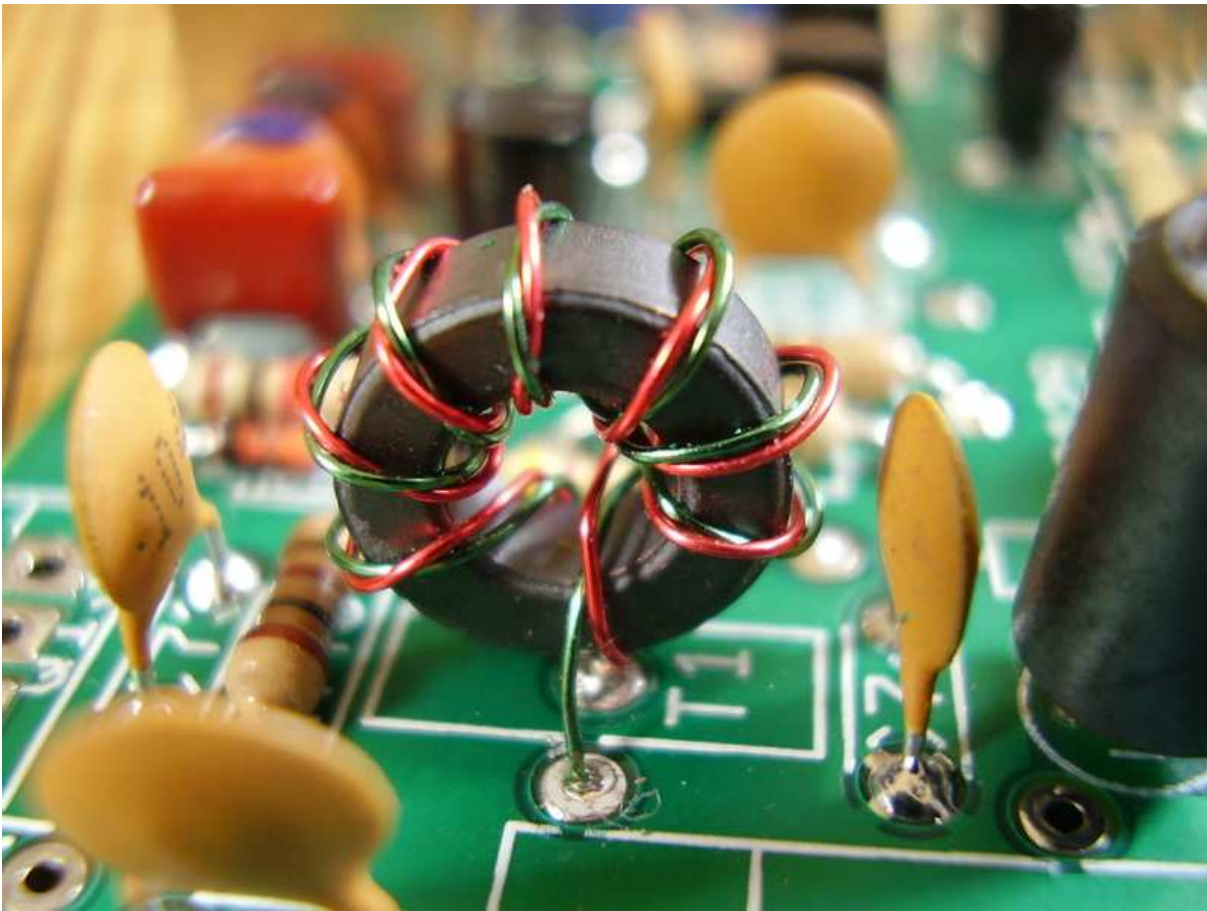

Figure 9.23: Closeup View of T1.

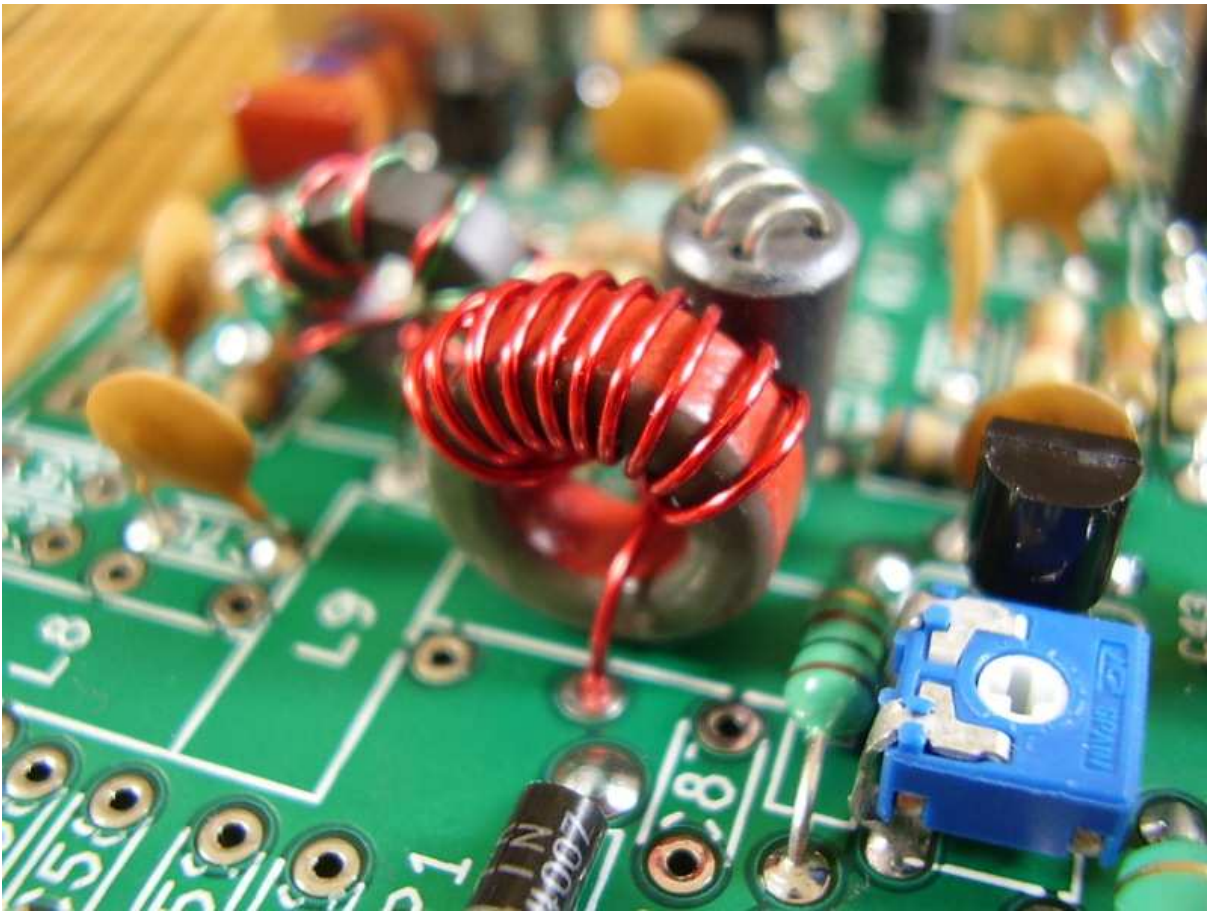

Figure 9.24: [7-27] L8 0.8 μ H Toroid 11T.

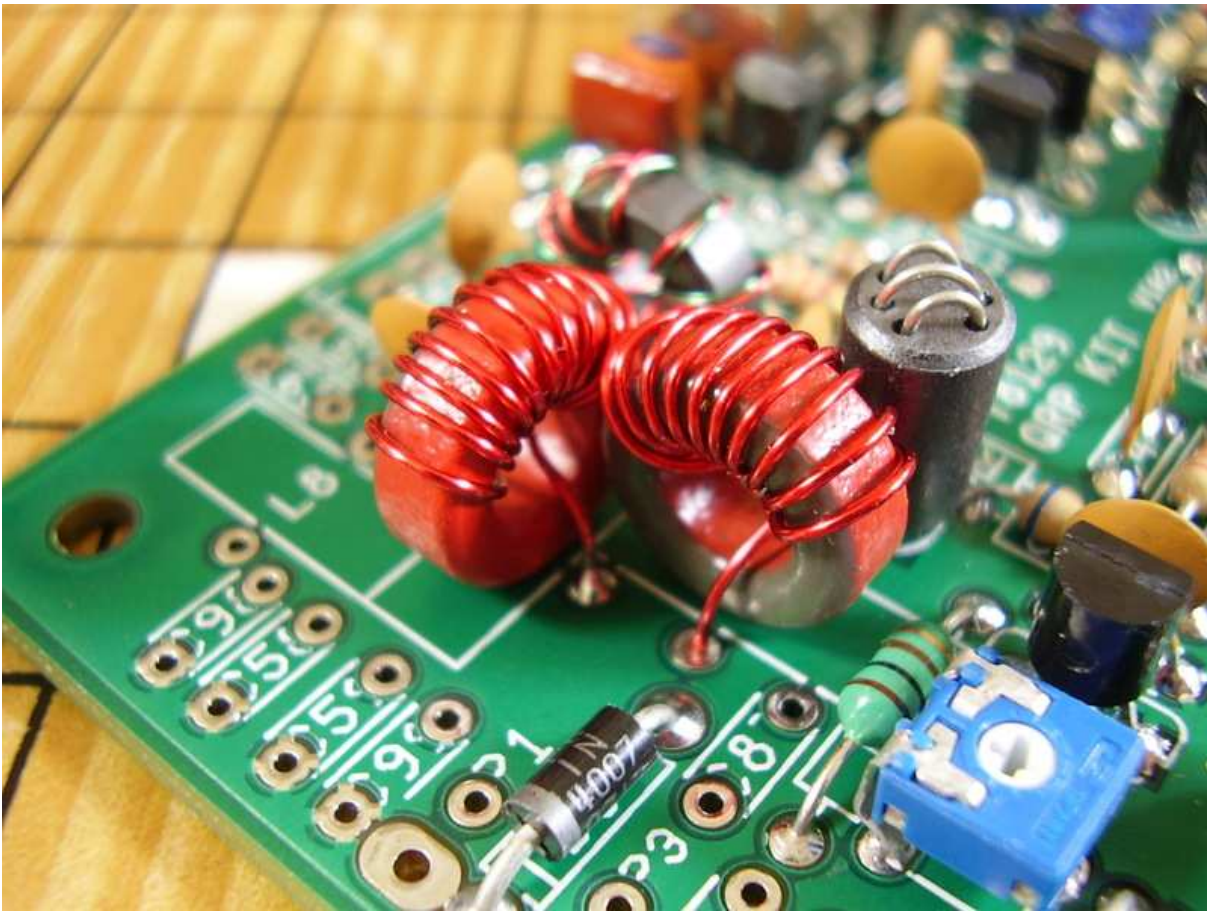

Figure 9.25: [7-28] L9 0.8 μ H Toroid.

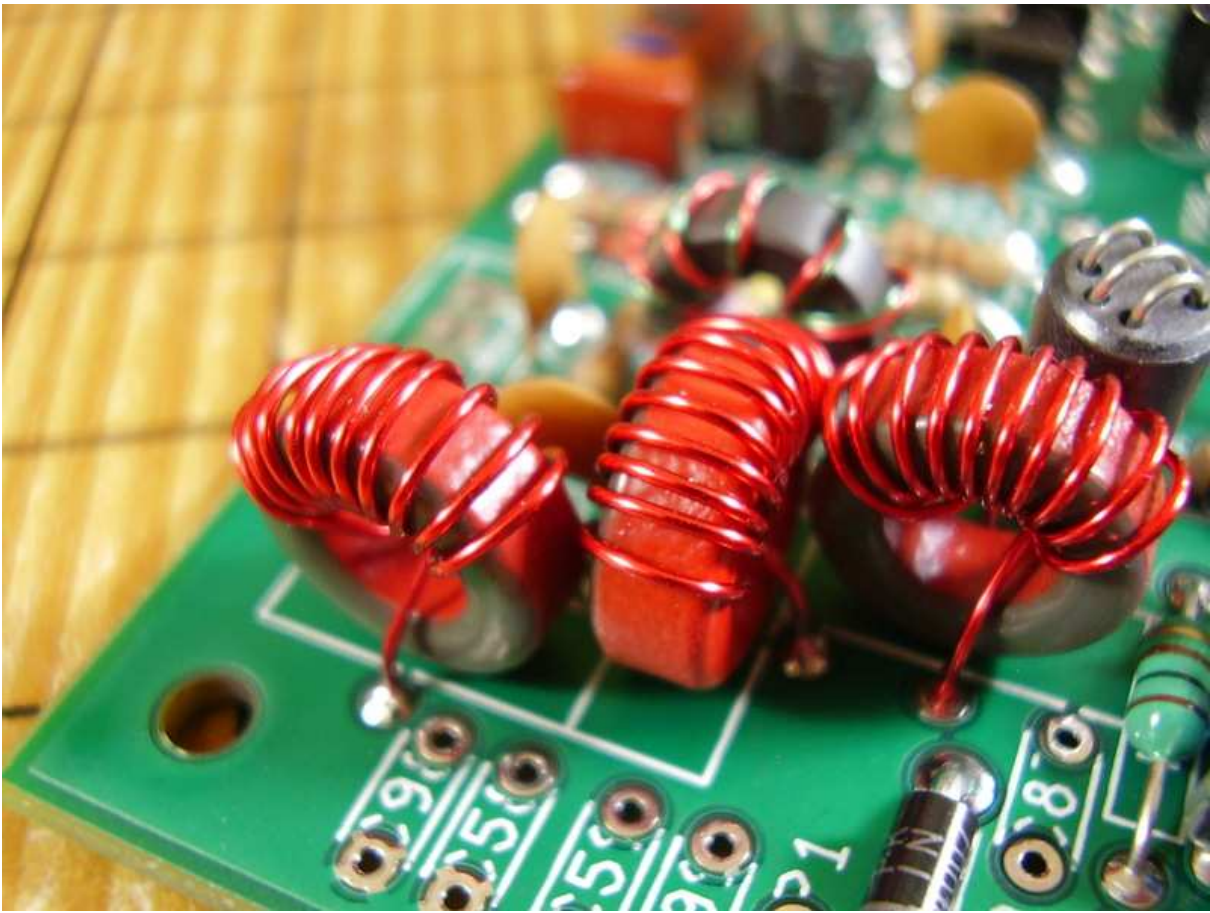

Figure 9.26: [7-29] L10 0.8 μ H Toroid.

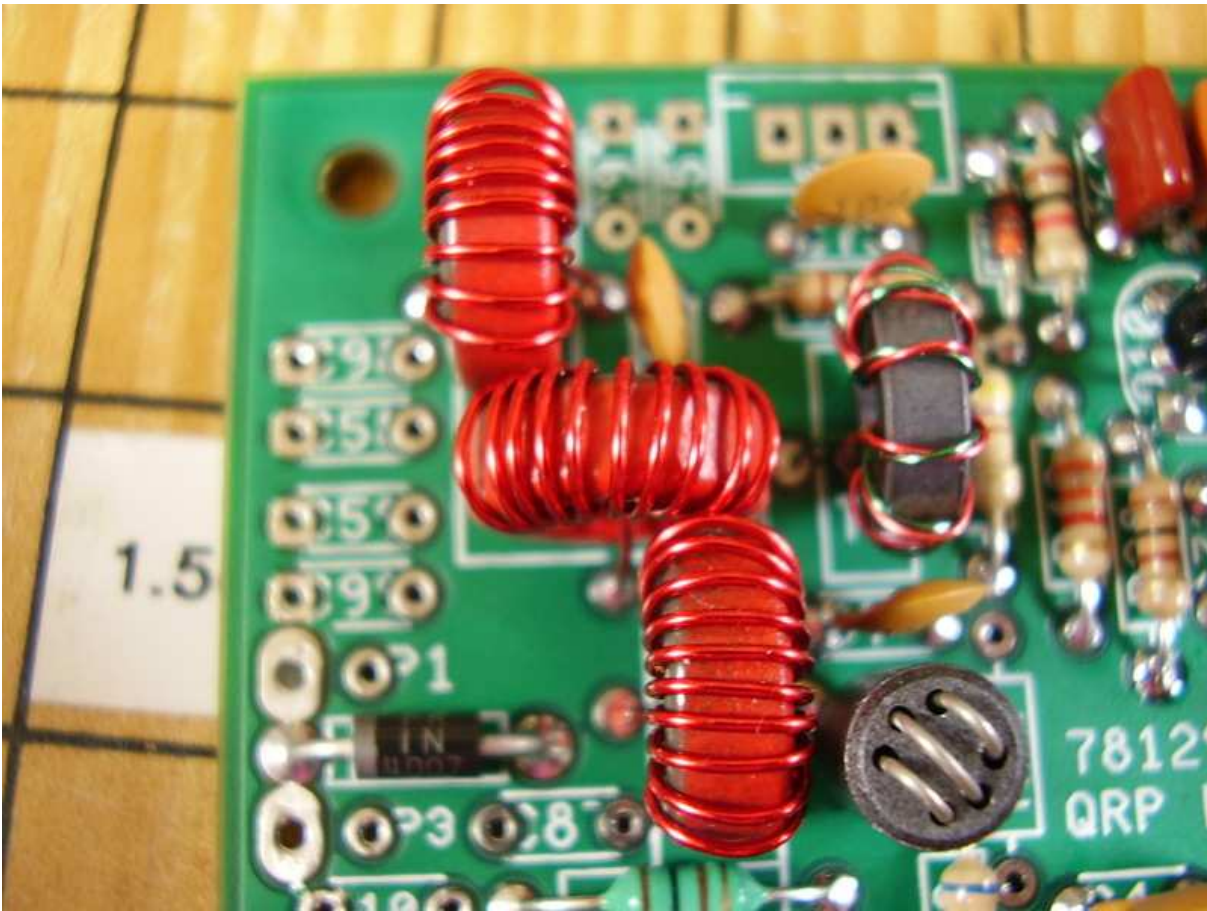

Figure 9.27: Top View of L8, L9 and L10.

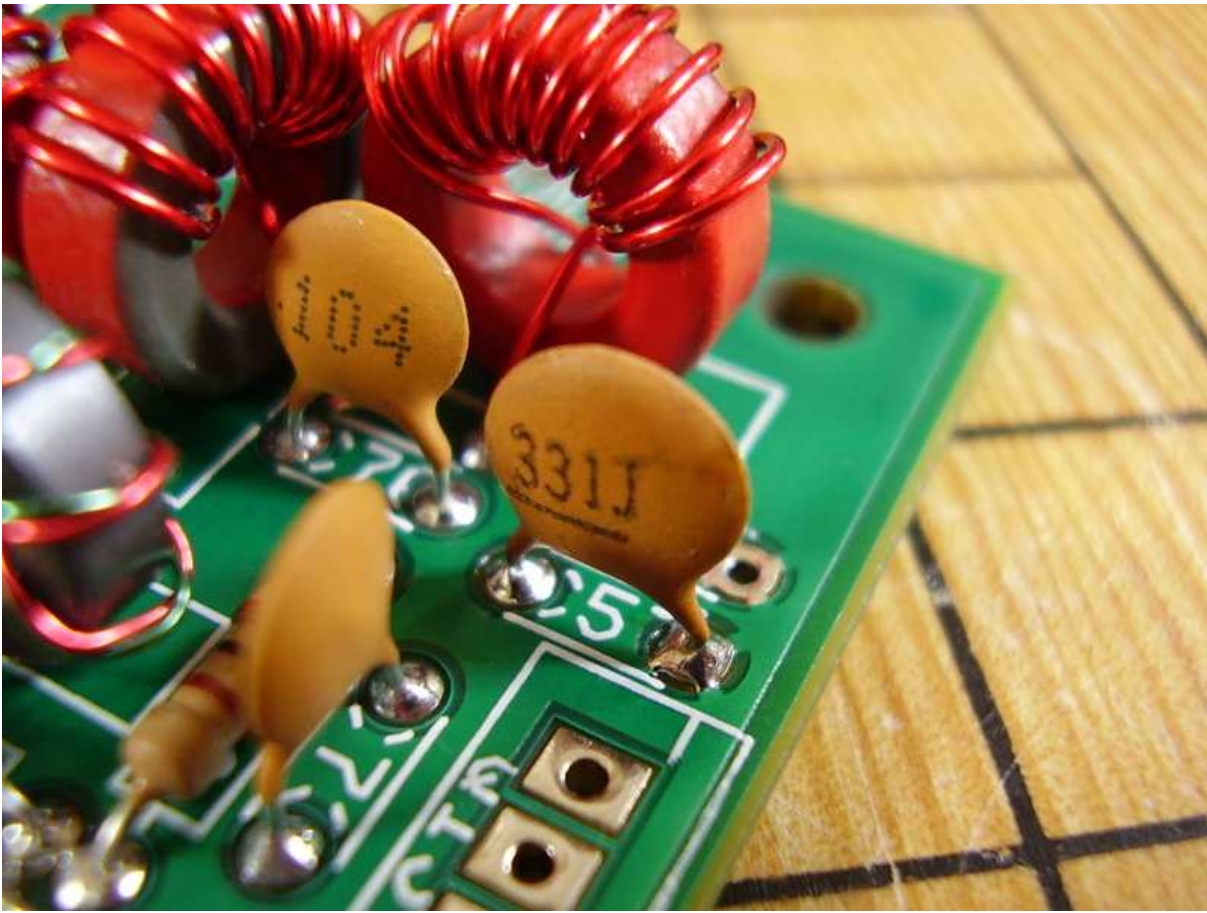

Figure 9.28: [7-30] C57 330pF (331).

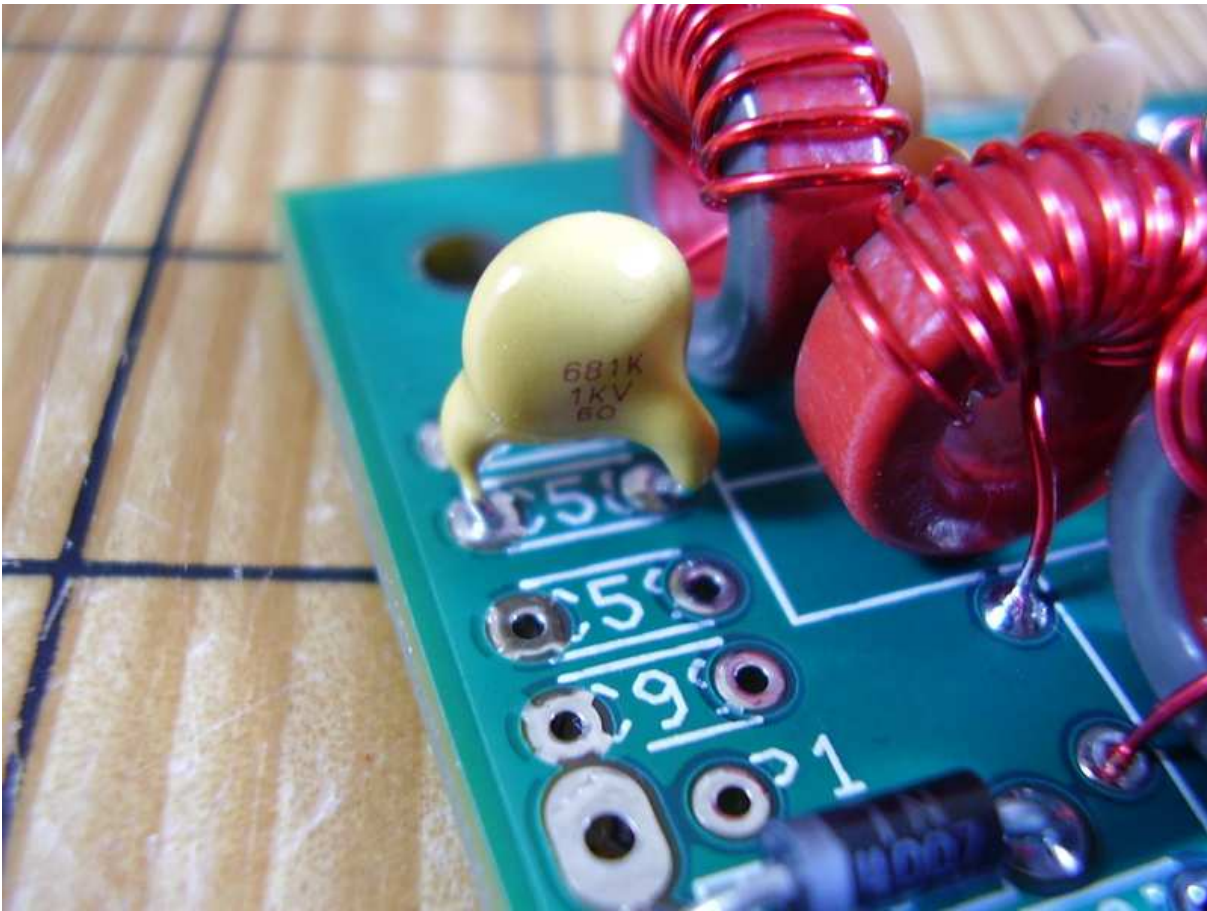

Figure 9.29: [7-31] C58 680pF (681).

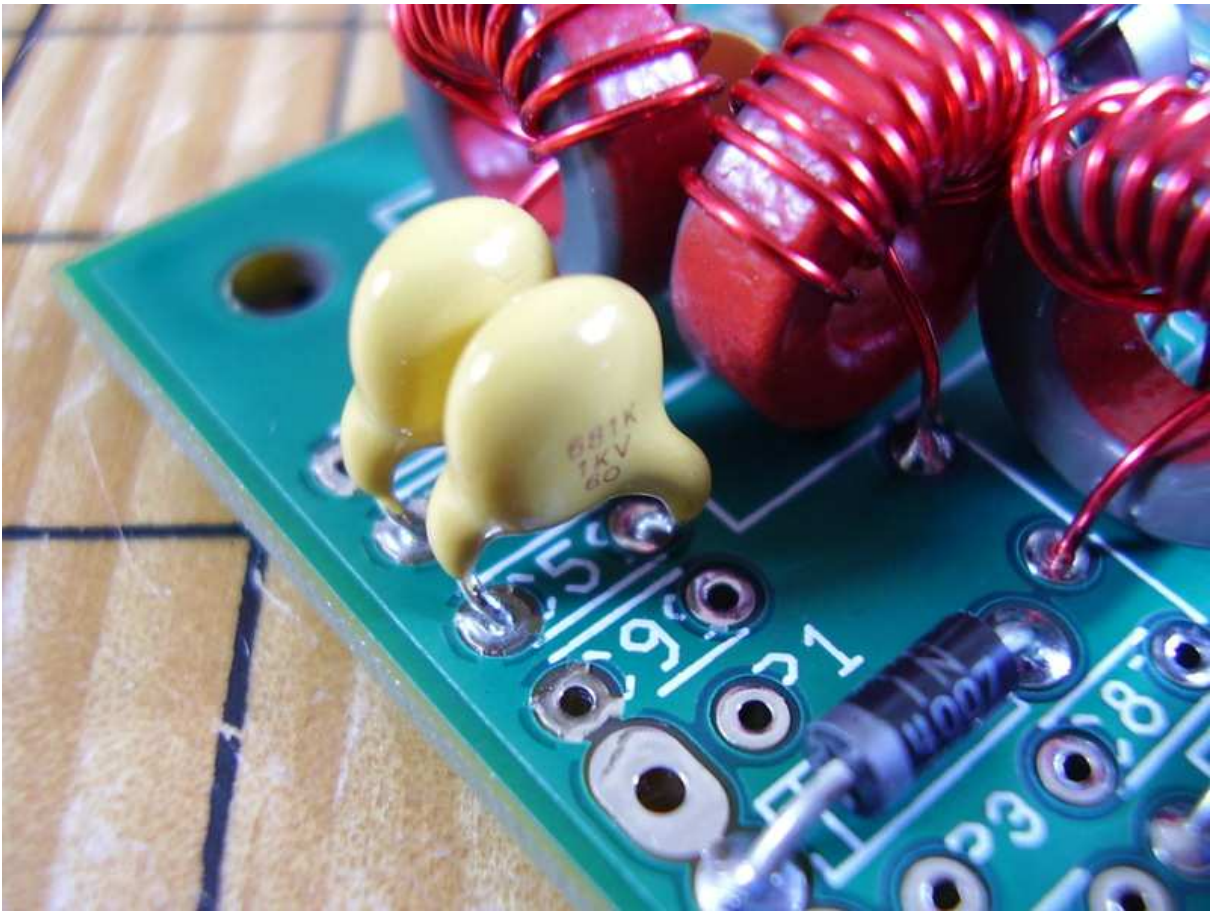

Figure 9.30: [7-32] C59 680pF (681).

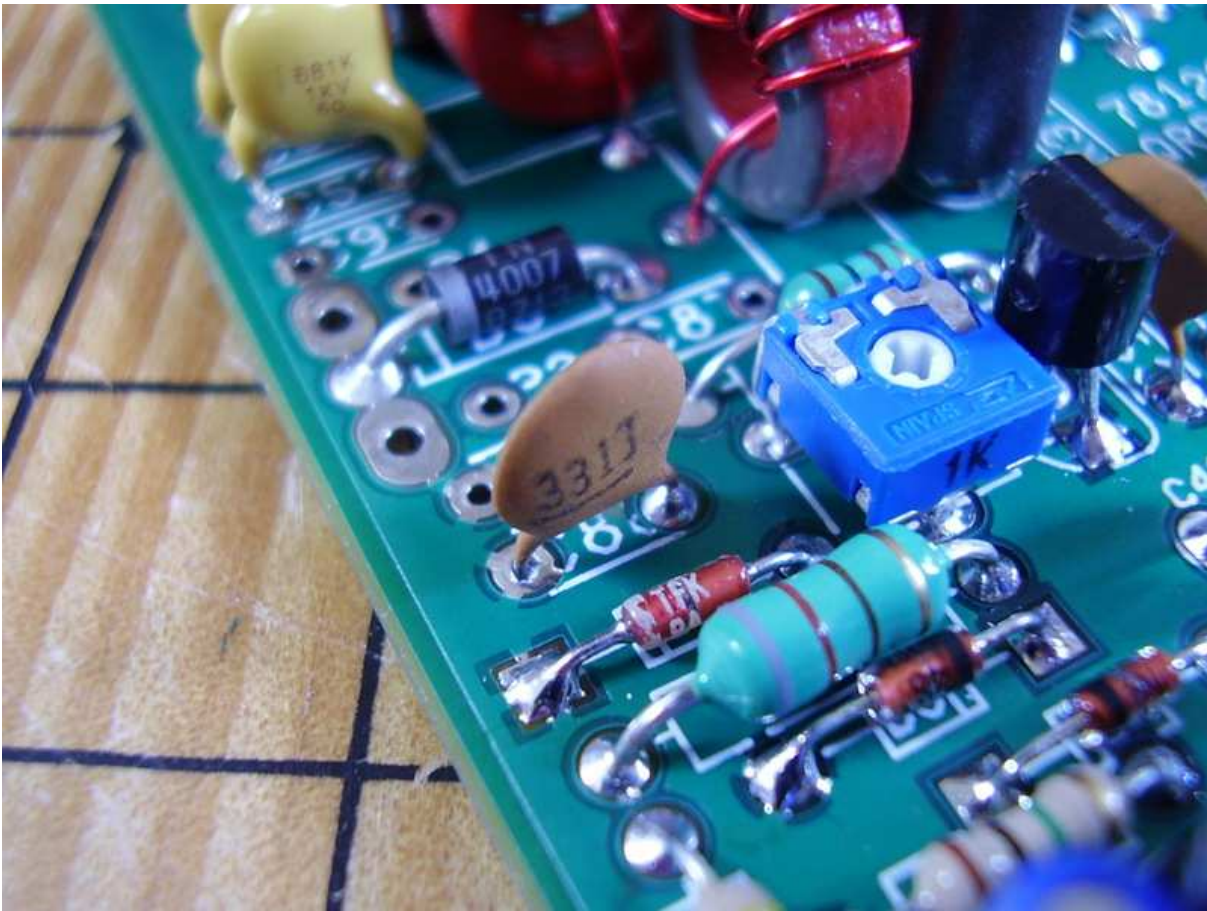

Figure 9.31: [7-33] C88 330pF (331).

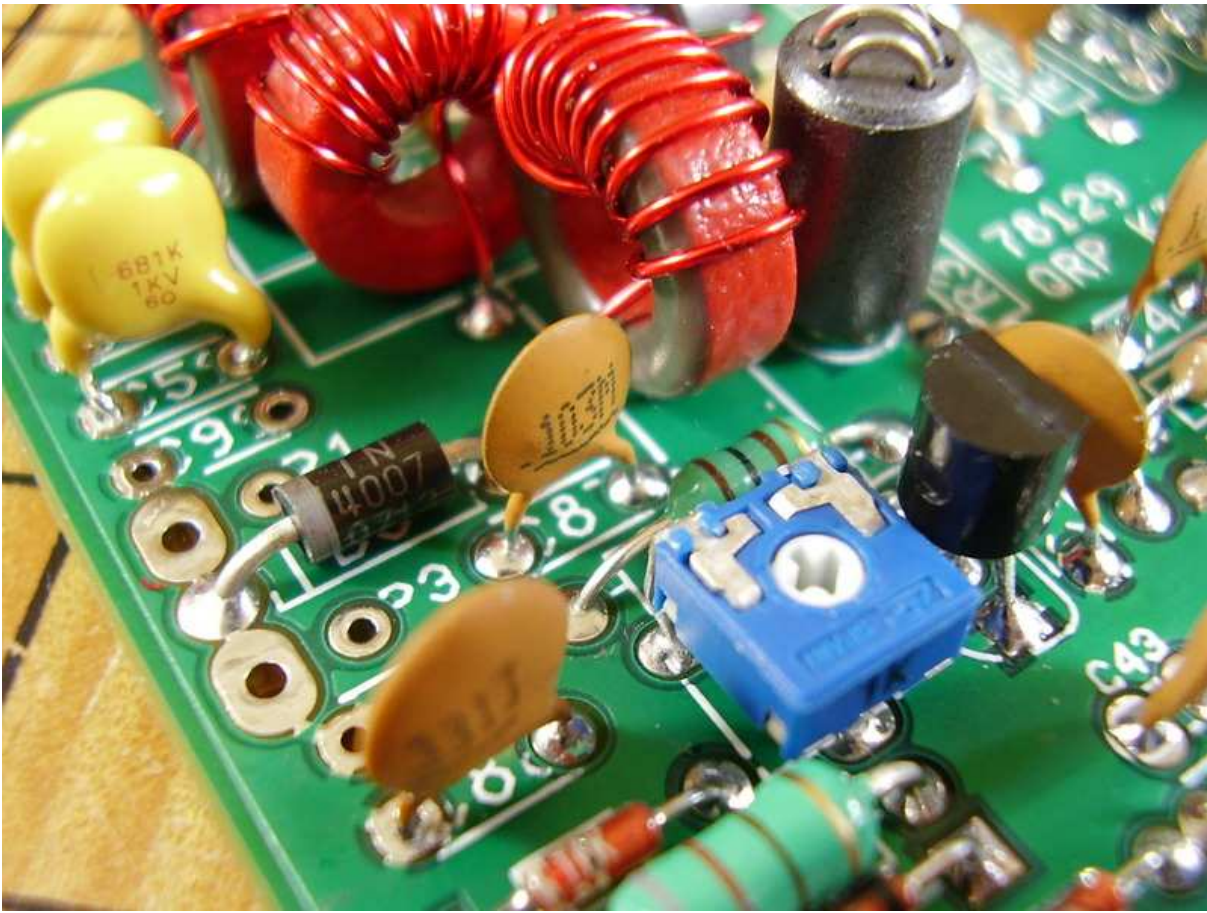

Figure 9.32: [7-36 C87 $.01\mu\text{F}$ (103).

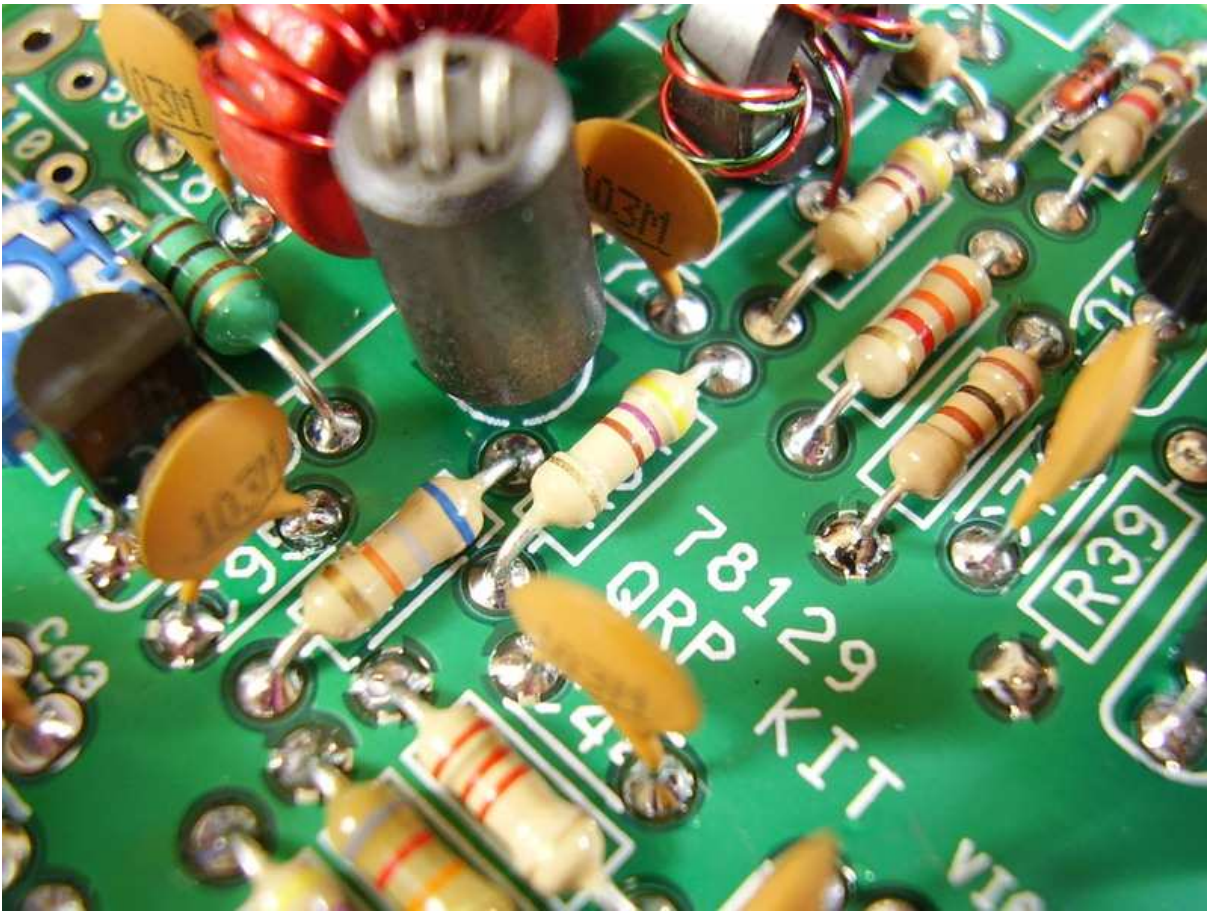

Figure 9.33: [7-37] R37 470 ohms.

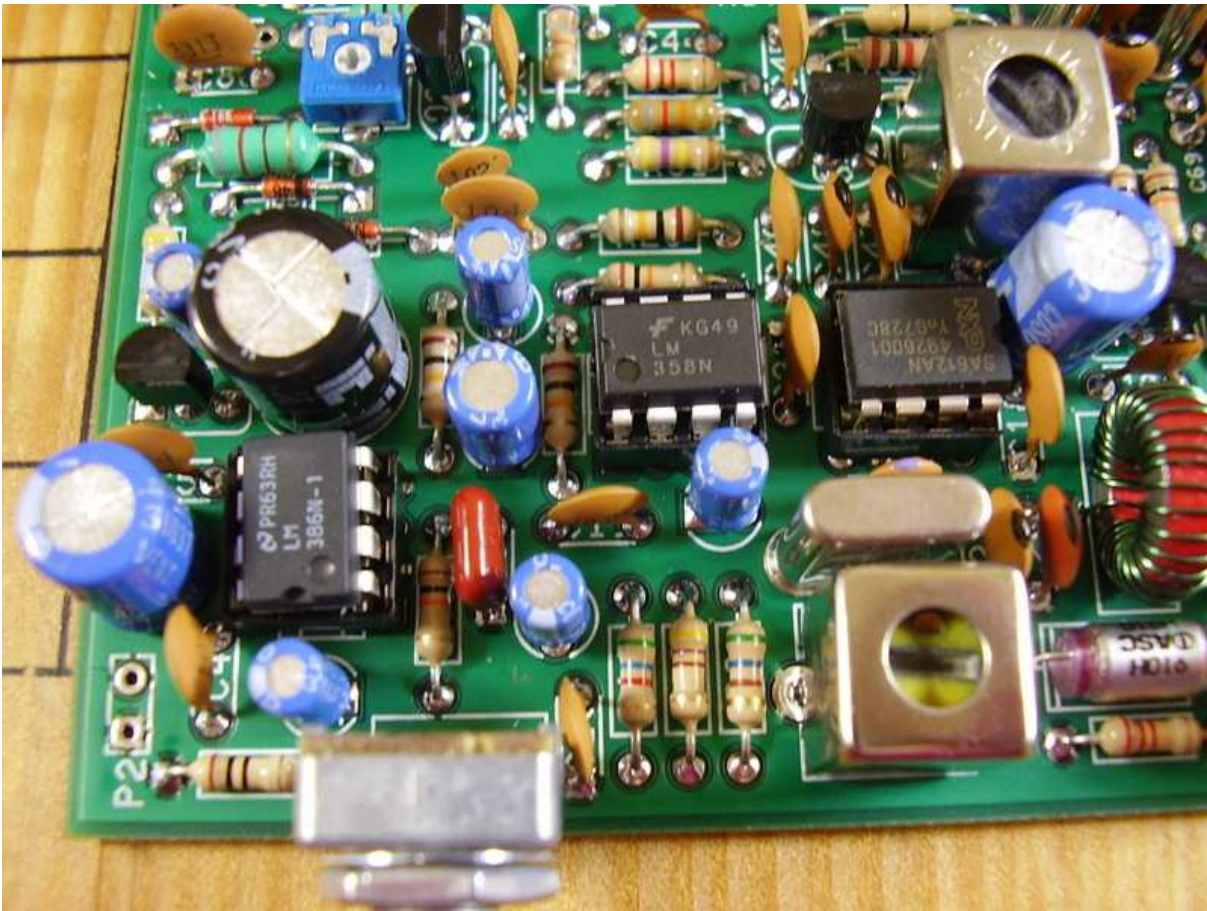

Figure 9.34: Lower Lefthand Quadrant of Board.

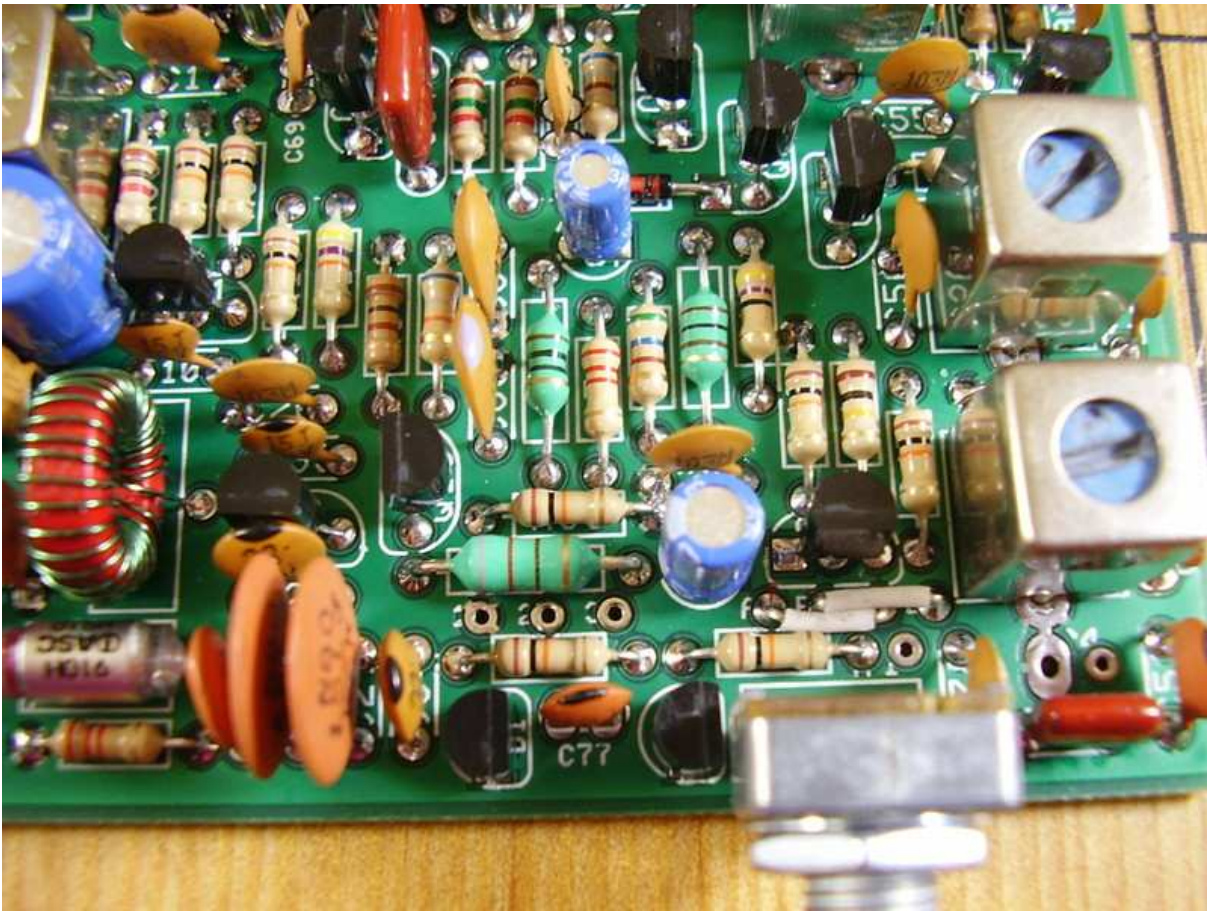

Figure 9.35: Lower Righthand Quadrant of Board.

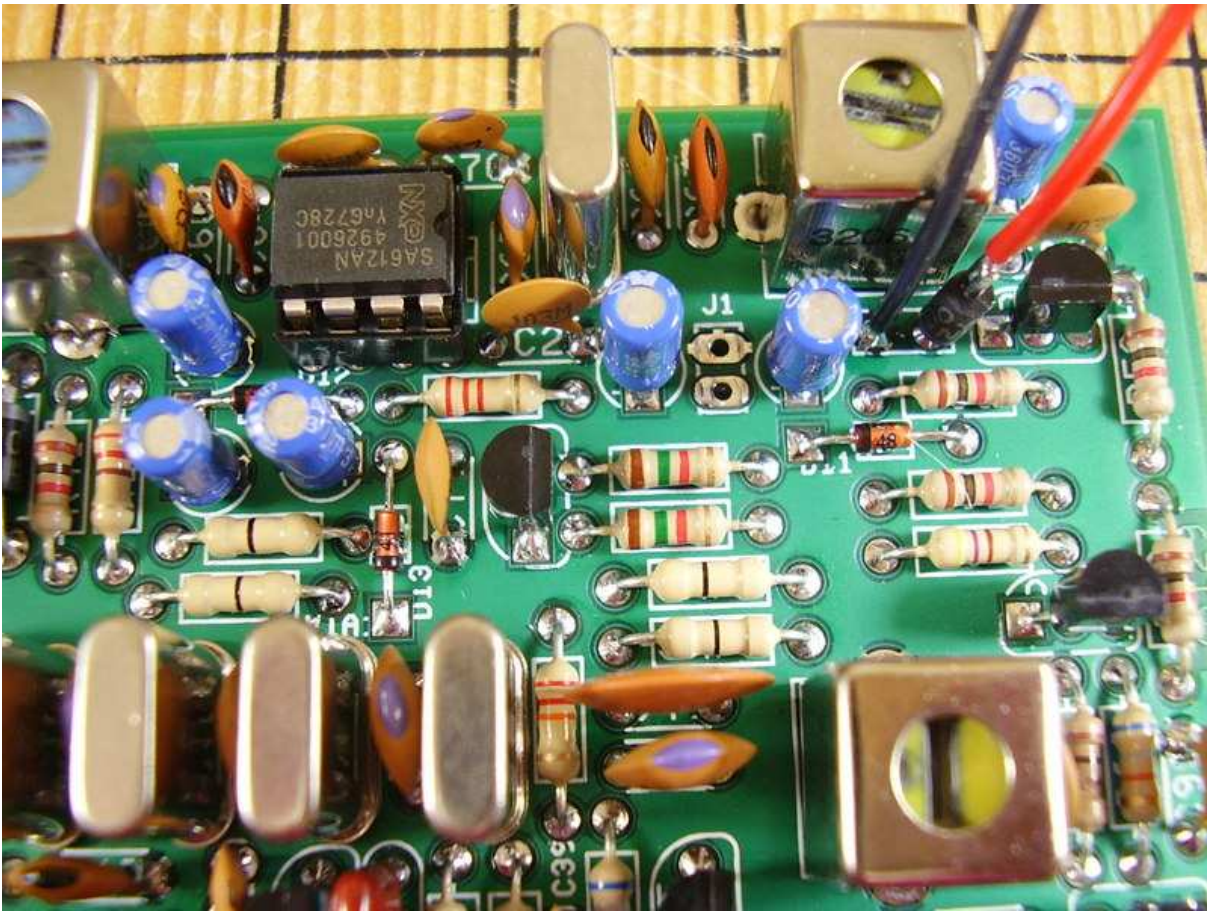

Figure 9.36: Upper Righthand Quadrant of Board.

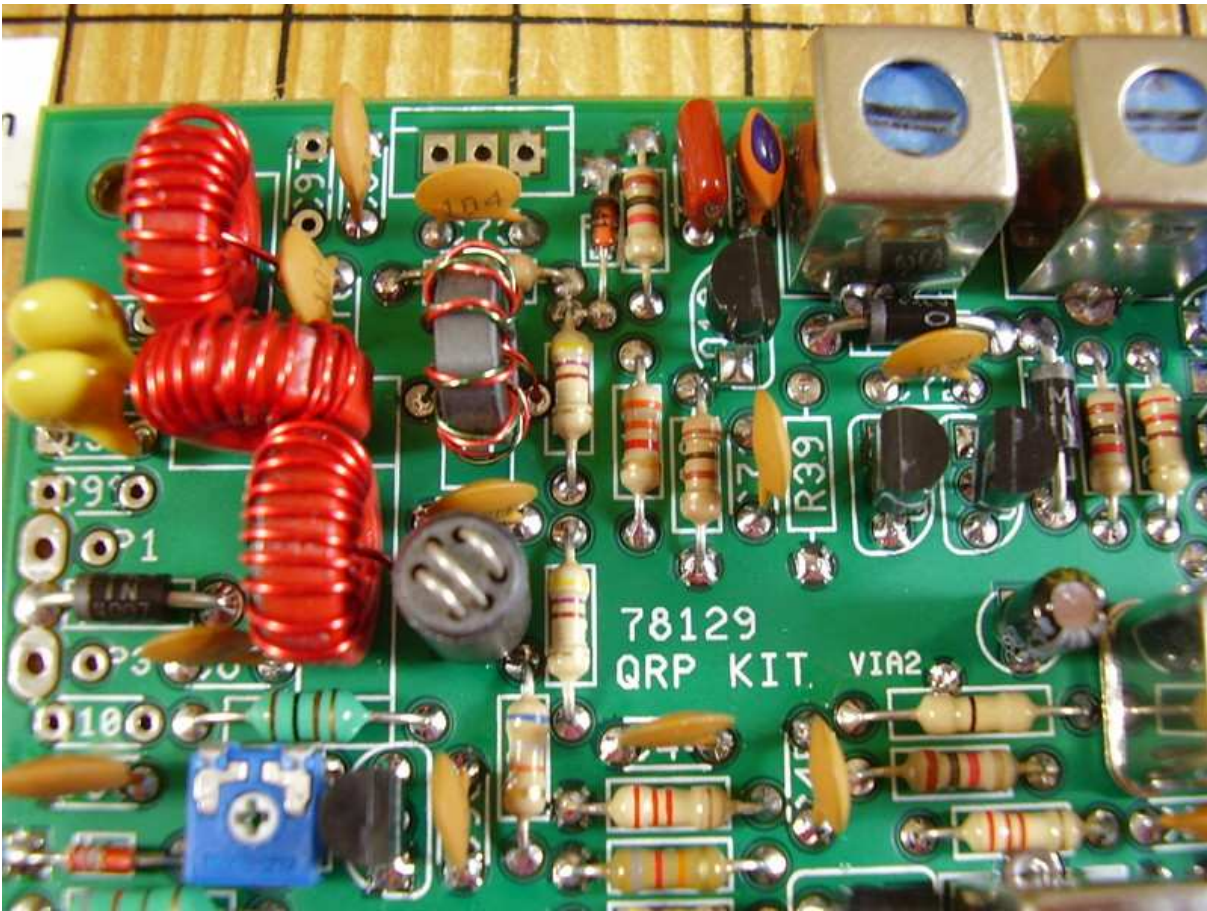

Figure 9.37: Upper Lefthand Quadrant of Board.

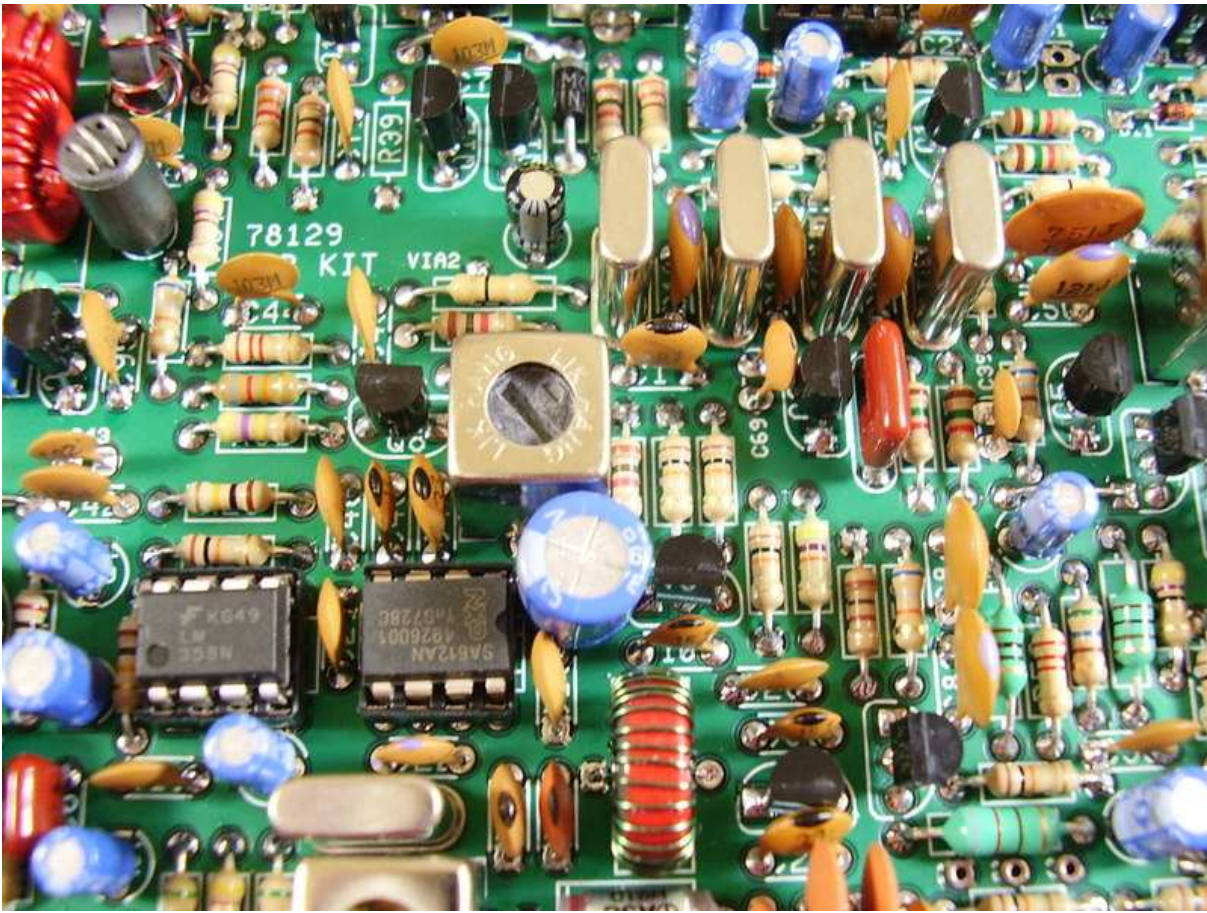

Figure 9.38: Central Section of Board.

Chapter 10

Final Assembly

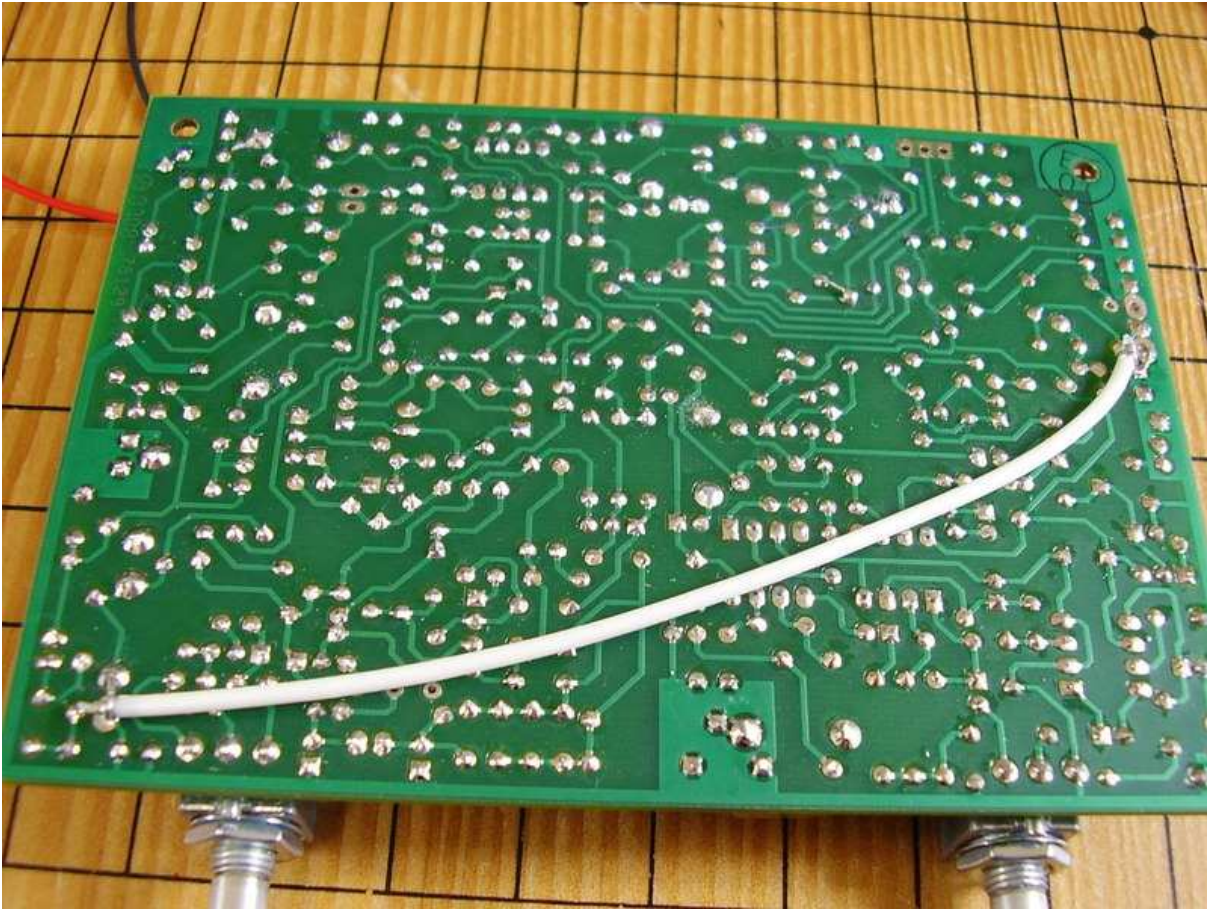

Figure 10.1: Coax Installed.

I used RG-316U, a teflon based replacement for the RG-174 coax supplied with the kit. Your coax will have black outer insulation. You may install the coax on the top side of the board, if it is much easier for you to do so.

Photographs at the end of this document will show you how to prepare the ends of the RG-174 for installation. This is where a wire stripper with variable settings will come in handy. Start with a number 20 setting and remove the outer insulation for about an inch on each end of the coax length.

Lightly solder next to the insulation for a few mm and then remove the remaining insulation being careful not to nick or damage the inner

insulation. Then remove the insulation at the end to expose the center conductor. Study the photographs.



Figure 10.2: Board Installed in Center Shell.

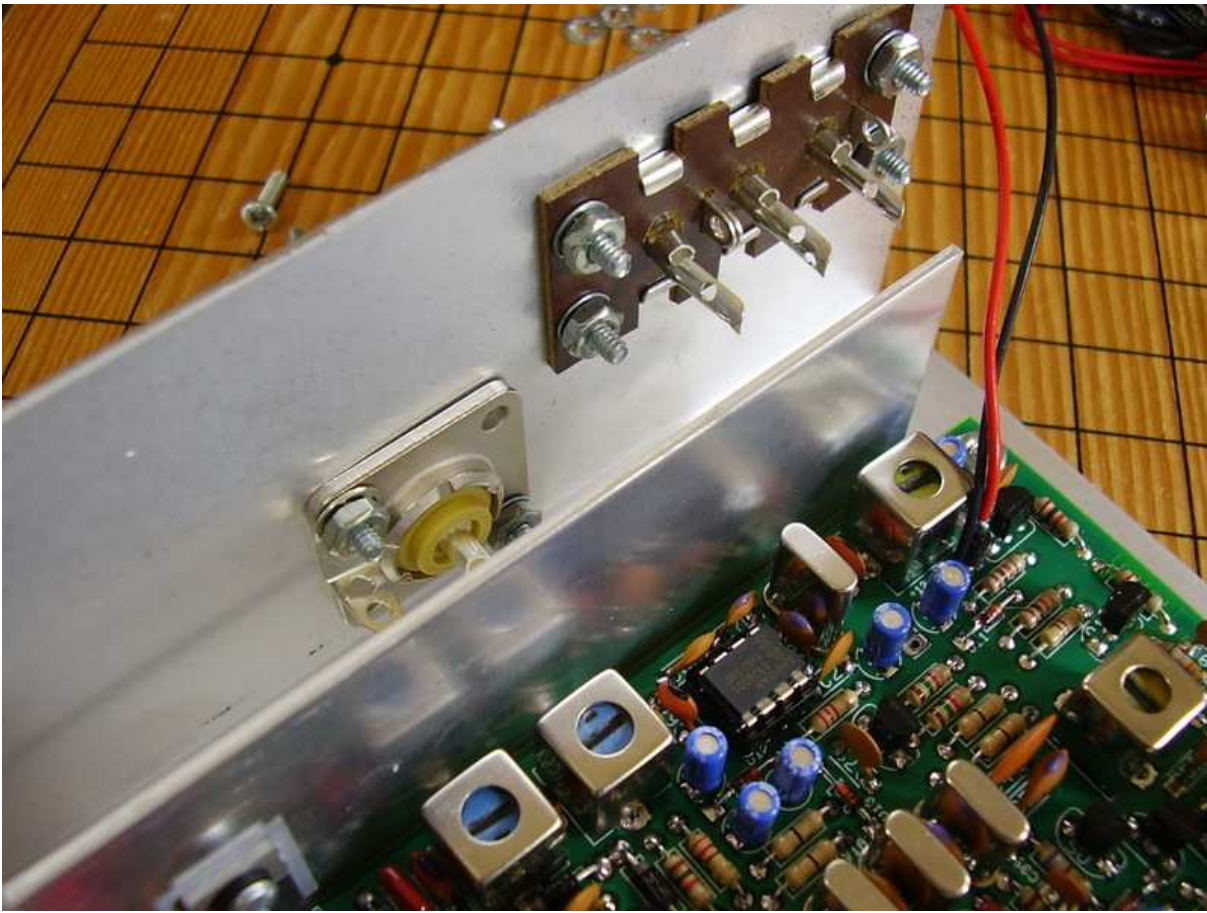

Figure 10.3: Back Side of Case.



Figure 10.4: 100 Ohm Resistors Installed.

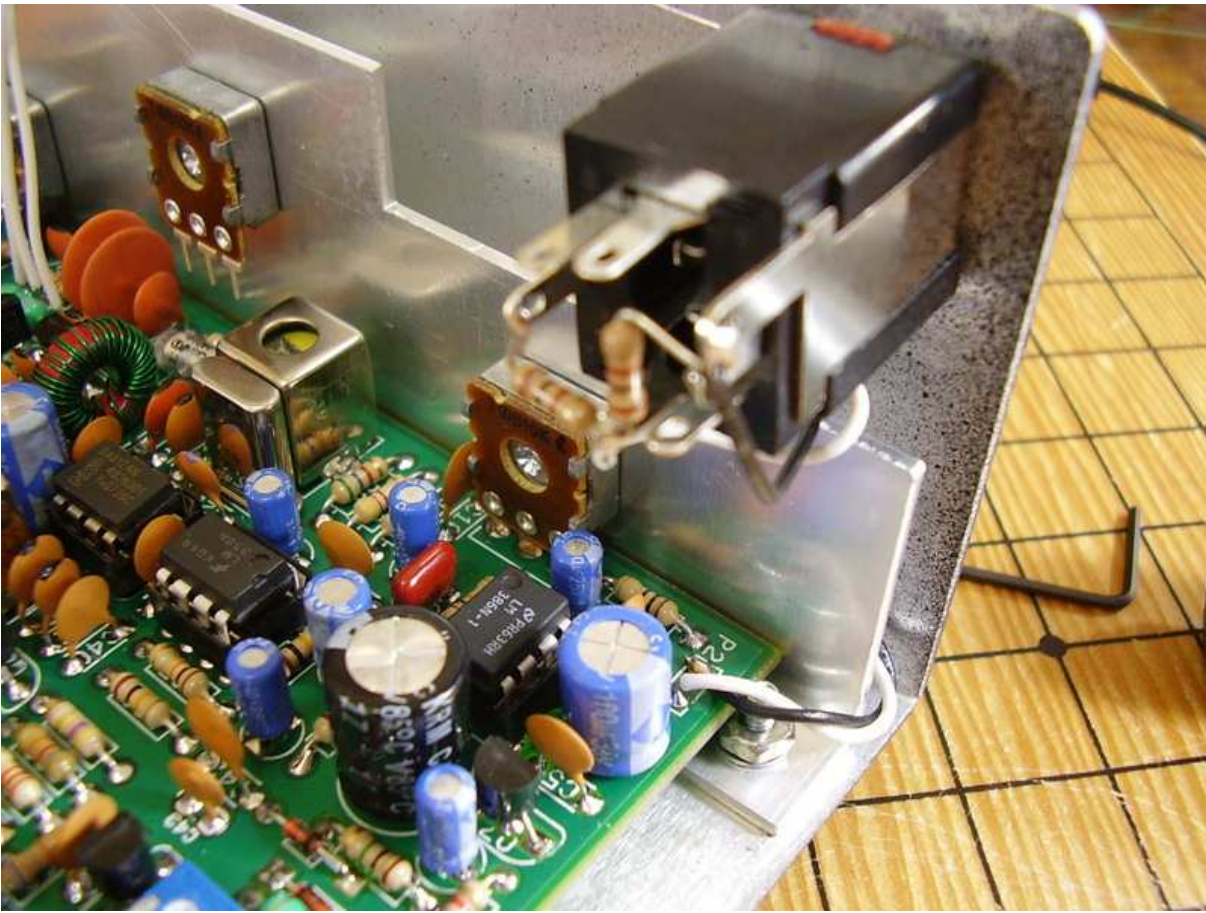

Figure 10.5: Headphone Jack in Place.



Figure 10.6: Coax to Antenna Connector.

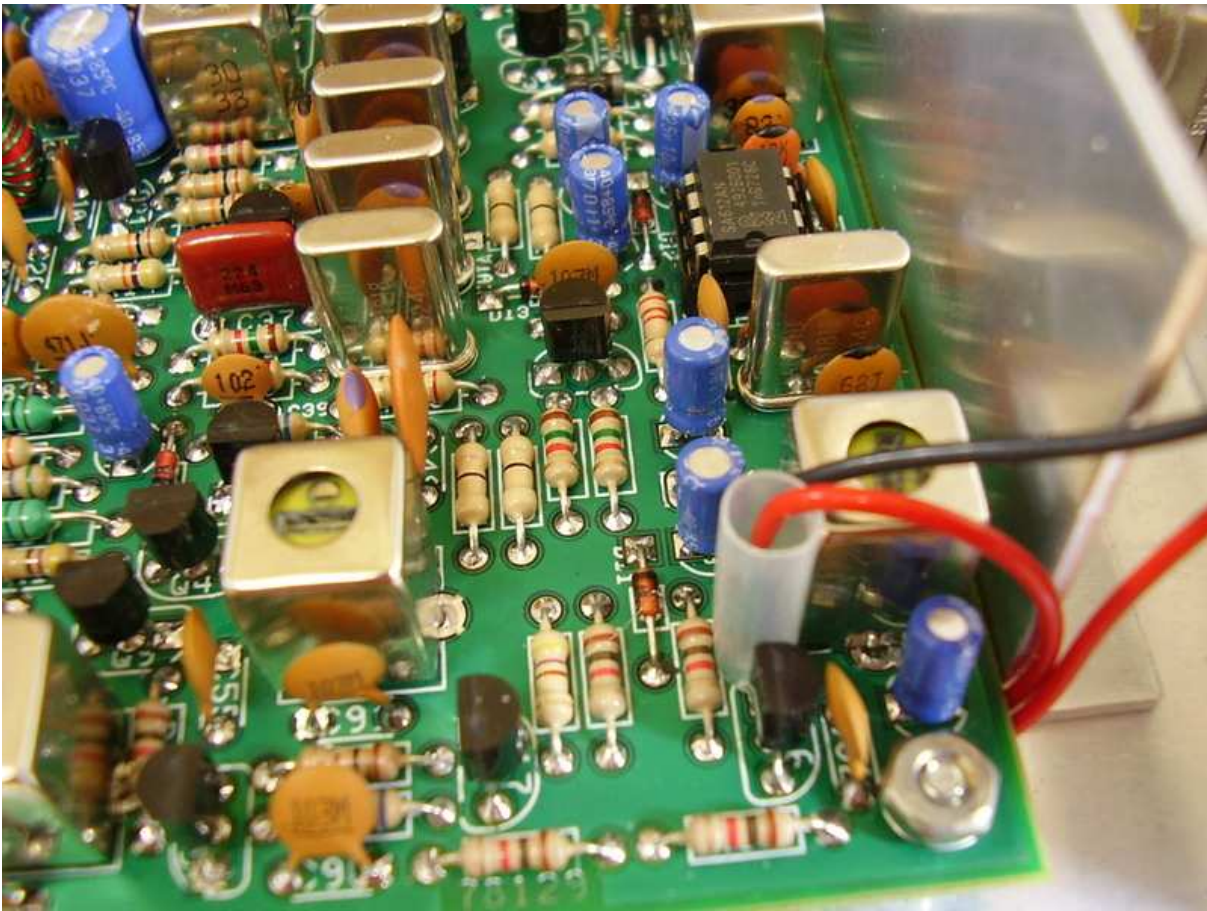

Figure 10.7: Power Connections.

A small piece of heat shrink has been placed over the diode to prevent shorts. I just haven't heated it yet to reduce the size. I'll photograph the final configuration as soon as I can.

Chapter 11

RG-174 Coax Preparation

The following photographs illustrate how I prepare small coax segments typically used in QRP transceivers. I use an adjustable wire stripper. Starting with the #20 position I remove the outer insulation to expose the outer conducting shield. I solder a 1-2mm section and then remove the remaining outer shield to expose the insulation between the outer shield and the inner conductor.

Using the next smaller position #22, I remove the insulation to expose the inner conductor, which is then tinned/soldered to have the end ready for soldering into the circuit where it will be used. The photographs should be self explanatory.

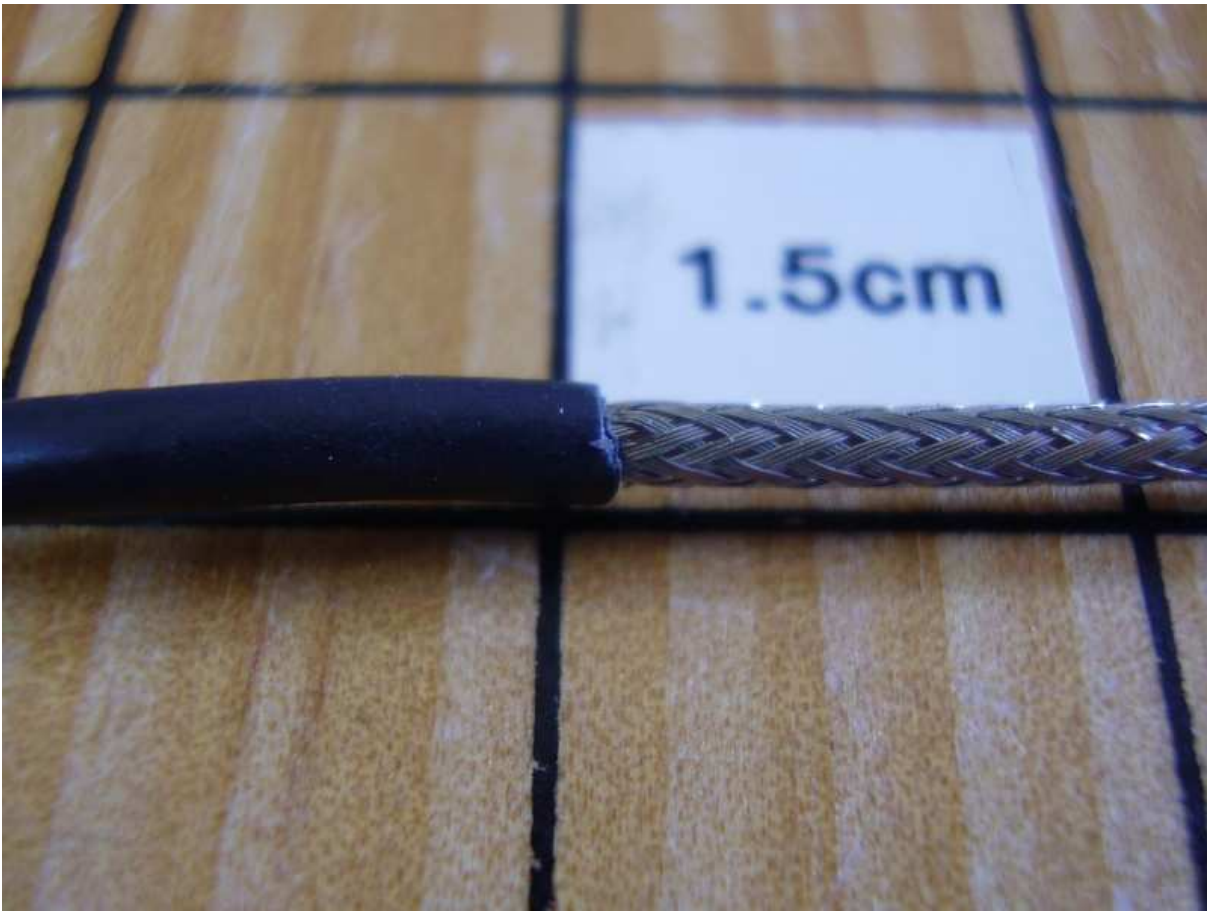

Figure 11.1: RG-174 Outer Insulation Removed.



Figure 11.2: 1mm Section Tinned.



Figure 11.3: Remaining Shield Removed.

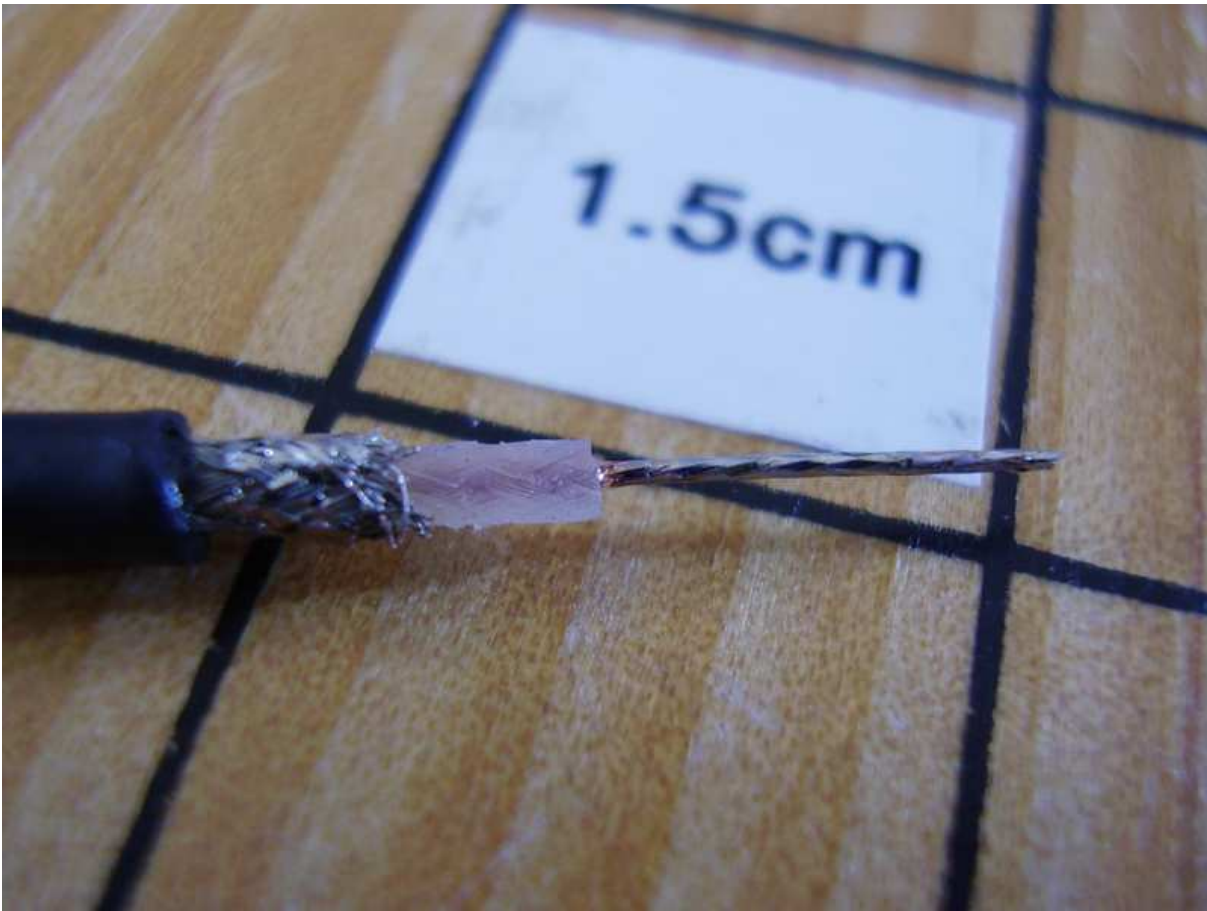

Figure 11.4: Section of Inner Conductor Soldered.

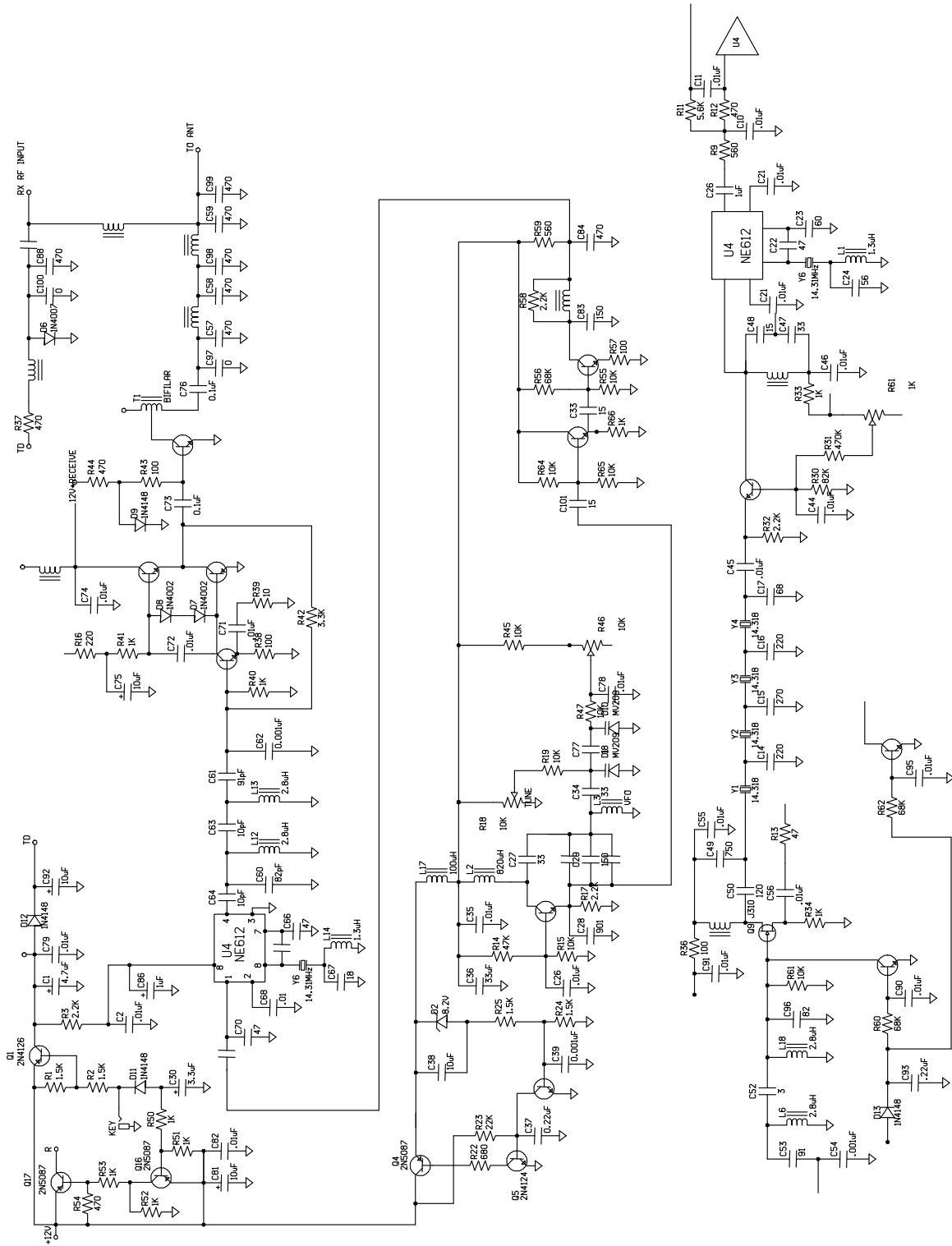

Figure 11.5: TT1340 Schematic.