

## Table of Contents

1. Your new Argonaut VI 539.....	3
1.1. Unpacking Argonaut VI Model 539.....	3
1.2. About this Manual.....	3
1.3. Accessory package.....	3
1.4. Connection to Antenna & Power Supply.....	4
1.5. A word about grounding.....	4
1.6. Philosophy of design.....	5
2. Easy Operation Guide.....	6
2.1. Front Panel Indicators.....	6
TX/ALC LED.....	6
S-Meter / SWR Meter.....	6
2.2. Front Panel Controls.....	7
2.3. General Operations.....	8
Power Switch (1).....	8
AF Gain Control (1).....	8
RF Gain Control (2).....	8
BW (3) Bandwidths.....	9
PBT (4) Pass Band Tuning.....	9
Band (7).....	9
Split (8).....	9
AGC (9).....	9
A/B (10).....	9
RIT (7).....	10
POWER (7).....	10
Mode (10).....	10
Headphones (20 on rear panel).....	10
Tuning Steps and VFO LOCK (8).....	10
PRE (8).....	10
Recalling A Stored Memory (9).....	11
Storing a Frequency to Memory (8).....	11
NR/NB (9) Noise Reduction/Noise Blanker.....	12
2.4. SSB Mode Operation.....	13
Monitor Level (3, 5, 7).....	13
Speech Processing (3, 5, 8).....	13
Auto Notch (9).....	13
MIC Connector.....	14
Mic Gain and Line Gain(10).....	15
2.5. CW Mode Operation.....	16
Internal Keyer CW Speed Setting.....	16
Internal Keyer Weighting / Dit Spacing & Curtis Mode A/B.....	16
CW Sidetone Frequency.....	16
CW Sidetone Level.....	16
QSK Delay.....	16
CW Keying and Wiring.....	17
2.6. AM Mode Operation.....	17
2.7. Digital Mode Operation.....	17
2.8. Interfacing to a computer for Firmware Update Mode and PC Control/Logging Purposes.....	18
2.9. Power Up Modes.....	19
Configuration Menu (PWR(7)).....	19
Master Reset (SPL(8)).....	19
Firmware Update Mode (A/B (10)).....	20
2.10. Optional Filter Installation.....	21
2.11. Extended Feature Access via USB/Serial.....	22
2.12. Retaining User Settings.....	22

3. Argonaut VI Rear Panel.....	23
ANT (11).....	23
AUX (12).....	23
FUSE (13).....	23
DC IN (14).....	23
GROUND TERMINAL (15).....	23
DC OUT (16).....	23
USB (17).....	23
KEY (19).....	23
EXTERNAL HEADPHONES (20) .....	23
ACC 1 (18).....	24
Keying a Linear Amplifier.....	25
4. Accessory Devices.....	25
4.1. List of Optional Accessories For The Argonaut VI.....	25
4.2. Using the 712 USB/Soundcard Interface .....	25
5. Specifications.....	26
5.1. Transceiver Specifications.....	26
5.2. Transceiver Block Diagram.....	29
6. In Case of Difficulty.....	31
7. Warranty & Return Policy.....	33

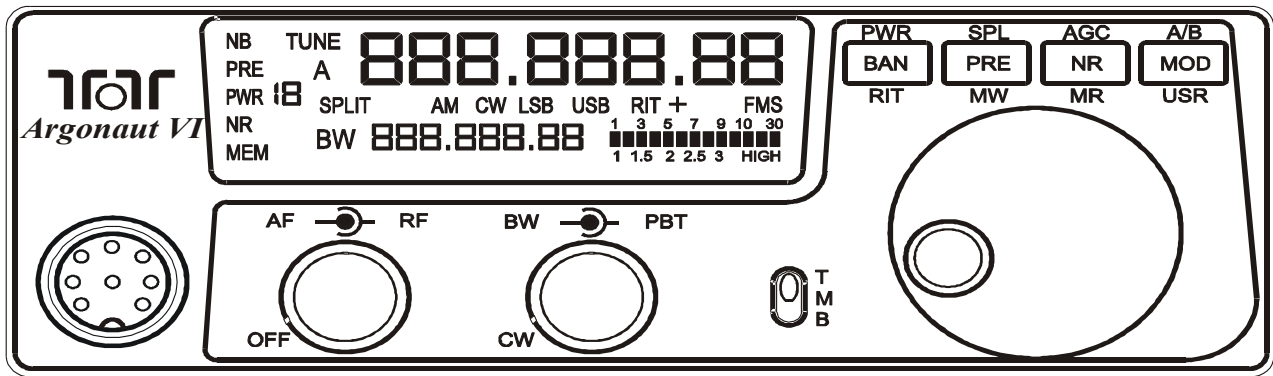

Figure 1-1 539 Front Panel

## 1. Your new Argonaut VI 539

### 1.1. Unpacking Argonaut VI Model 539

Examine the Argonaut VI transceiver for signs of shipping damage. Should any damage be apparent, please contact Ten-Tec Service (865) 428-0364 to handle the claim.

### 1.2. About this Manual

A complete description of the features and functions on the Argonaut VI Model 539 are included within the pages of this manual. The latest version of the Argonaut VI manual is also available to view in pdf format located under the download tab on the Argonaut VI Transceiver via [www.tentec.com](http://www.tentec.com). You may also find firmware updates plus a full set of schematic diagrams at this same web location.

### 1.3. Accessory package

The additional hardware and accessories listed in Table 1.3-1 come standard with your new Argonaut VI.

Look over the items listed and refer to the 5 digit Ten-Tec part number and description should you find the need to replace an accessory.

To purchase additional accessories and parts or to report an item missing from this list, please contact Ten-Tec Service.

Qty	Part #	Description
1	27091	Auto Style Fuse, 7.5 Amp 13.8 VDC
1	35241	8 PIN DIN Connector
1	35263	Plug – Stereo, 3.5MM (1/8)
1	38040	Allen Wrench, 0.050 Hex
1	86095	DC Cable Assembly 4 Ft
1	74020	Warranty card
1	74244	Standard Warranty Sheet
1	74479	Manual for 539 Argonaut VI
1	74450	How do I become a Ten-Tec Ambassador
1	74480	Argonaut VI Quick Start Guide

Table 1.3-1 Argonaut VI Packing List

## 1.4. Connection to Antenna & Power Supply

The Argonaut VI is designed for use with any antenna system providing a 50 Ohm resistive impedance at the desired operating frequency. Every effort should be made to ensure the impedance of the antenna system is as close as possible to the specified 50-Ohm value. Note: that the "G5RV" type antenna and some Windom's do not provide 50-Ohm impedance on all HF Amateur bands, and an external wide-range antenna coupler will be needed. Any antenna to be used with the Argonaut VI must, ultimately, be fed with 50 Ohm coaxial cable.

The Argonaut VI transceiver requires a source of well-filtered and regulated DC voltage. The supply voltage for the Argonaut VI is 13.8 Vdc nominal +/- 15% to allow for mobile and battery operation. The voltage source must be capable of supplying 5-7 amperes continuous duty. We recommend using the included DC power cable (P/N 86095).

Note: Always enable the power source first and then the transceiver. If a generator or battery connected to a charger is used to supply the DC source, always turn off the transceiver before starting or shutting off the DC source equipment. These recharging devices often generate large voltage spikes that can damage the transceiver.

## 1.5. A word about grounding

A good ground system is essential for optimum operation of any HF transmitter. The best solution is to connect all the station equipment to a single ground connection. Refer to Local and National Electrical Codes before making any connections with the Argonaut VI. Another source of information on grounding can be found in the ARRL Handbook.

A good ground system can contribute to the station efficiency in a number of ways including minimizing the possibility of electrical shock, and minimizing RF currents flowing on the shield of the coax cable causing interference to electrical equipment and transceiver accessories.

It is critical that the power supply, the Argonaut VI, and other equipment in the station be properly grounded to an Earth ground. Improper grounding can lead to various issues, including RFI, ground loops, or even death. Therefore it is extremely important to refer to the Local and National Electrical Codes and ARRL Handbook with regards to grounding.

## 1.6. Philosophy of design

With the Model 539 Argonaut VI, Ten-Tec has created a QRP transceiver combining simplified controls and ease of operation with the excellent performance of a low first IF ham-band architecture in a compact, mobile-friendly structure. The analog portion of the radio is double conversion with IF frequencies of 9.0018 MHz and 22.5 kHz. A third conversion to zero-frequency IF is accomplished in the DSP processor.

Refer to the Block Diagram in the “**Specifications**” section for the following discussion. Receive signals are routed to a T/R switch at the input of the BPF/Preselector board. This board also contains the bandpass filter selected for the band in use and a switchable 12dB receive preamplifier. On the TX/RX board, output from the preamplifier is mixed with the first Local Oscillator to 9.0018 MHz and routed to one of the three roofing filters. After selectivity roofing, IF amplification is provided by a variable gain amplifier which also develops the high-level AGC. Finally, the 9.0018 IF signal is mixed with the second LO to develop a 22.5 kHz low IF for the Signal Processing Unit (SPU). Based on a 36.096 MHz temperature-stable reference, the Oscillator board generates first and second LO's with a DDS circuit and fixed frequency division. The SPU samples the low IF at 96K samples per second and applies the resulting data to a digital signal processor. Numerical algorithms running in the digital processor accomplish additional selectivity filtering, low-level AGC, and demodulation. The resulting audio appears at the speaker and line outputs.

The PIC processor in the front panel CPU module executes firmware stored in EEPROM to perform housekeeping functions such as synthesizer programming/tuning,

signal switching, and front panel display and control input. Based on the control inputs from the front panel (or remotely via the USB interface), the CPU writes display information, tunes the LOs, adjusts selectivity, and chooses both receiver detection and transmit emission modes. Transmit operation is basically the reverse of receive. Audio or CW signals are generated at zero-frequency (baseband) in the DSP, frequency-shifted to the 22.5 kHz low IF, and output to mixers on the TX/RX board for conversion to the operating frequency. The signal then travels in the reverse direction through the selected Bandpass Filter to the low-level drivers and Power Amplifier, then finally through the Lowpass Filter to the antenna.

The Argonaut VI is designed to cover the following hambands:

- 160M - 1.795-2.005
- 80M - 3.495-4.005
- 40M - 6.995-7.305
- 30M - 10.095-10.155
- 20M - 13.995-14.355
- 17M - 18.063-18.173
- 15M - 20.995-21.455
- 10M - 27.995-29.705

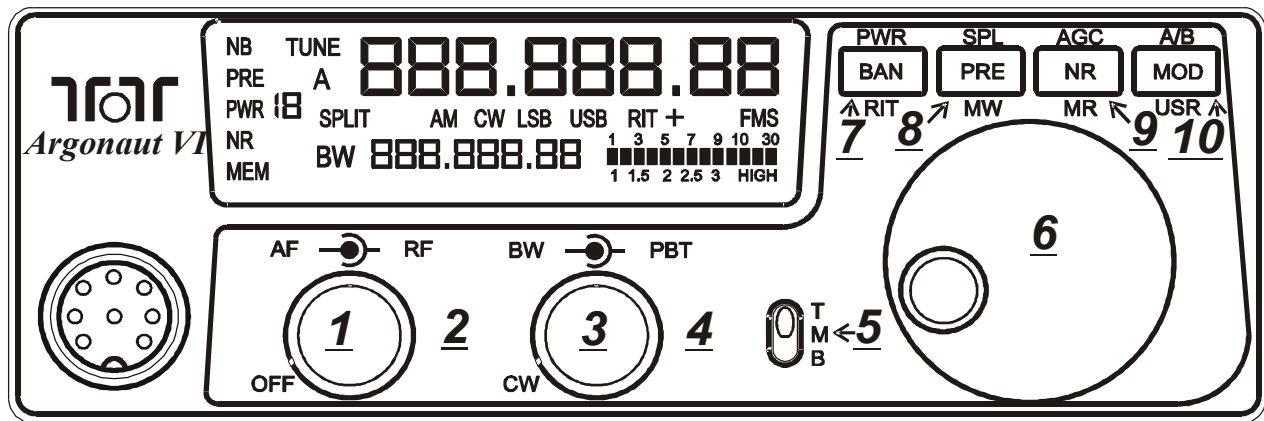

Figure 2-1 539 Front Panel- (with indexes)

## 2. Easy Operation Guide

### 2.1. Front Panel Indicators

#### TX/ALC LED

The “o” in the ToT Logo includes an LED. The primary purpose for this LED is to identify when the Argonaut VI is transmitting approximately 80% or more of the selected power setting. For CW mode, this should be active during the entire dit or dah transmit cycle. For Voice modes this will be when transmit voice is 80% or greater than the selected power level. This LED is also used in the firmware update mode.

When in transmit the bar graph meter will display your power output peaks. When you wish to view the SWR, ensure that the three position switch (5) labeled with TMB is in the middle (M) position, and press the MOD button while you transmit. The meter will now display your SWR while the MOD button is pressed. When the MOD button is released the SWR graph disappears and the power output will be displayed.

It is recommended that the rig be held in transmit continuously prior to pressing MOD to view the SWR. It is not advisable to try to view the SWR when sending a stream of CW.

#### S-Meter / SWR Meter

The meter on the Argonaut VI offers two functions:

1. S-Meter, in receive mode, the meter shows the signal strength.



Figure 2.1-1 Meter-Signal Strength

2. SWR-Meter, while transmitting and the MOD button is pressed, the meter shows the SWR as calculated on the bridge in the Argonaut VI.

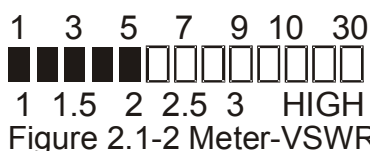

Figure 2.1-2 Meter-VSWR

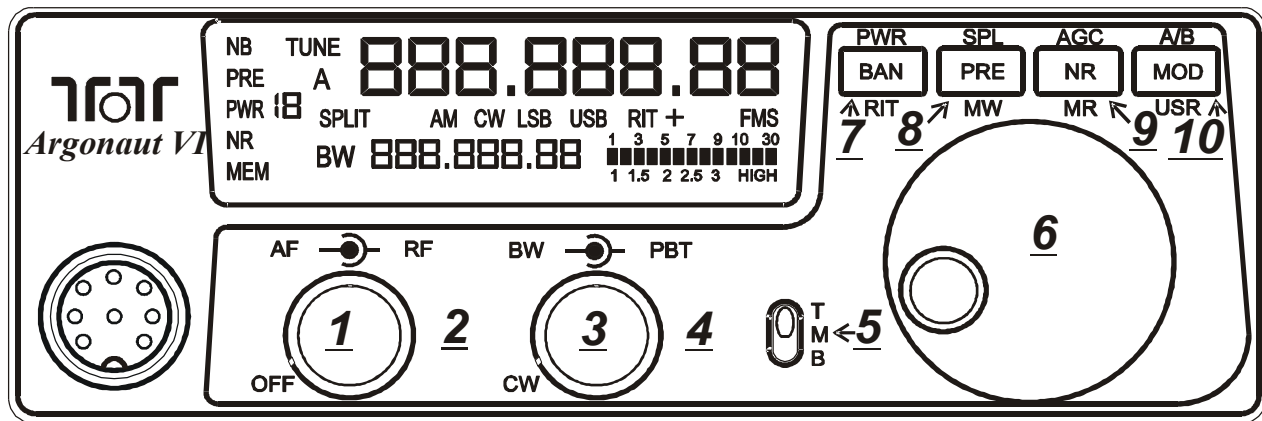

Figure 2-1 539 Front Panel- (with indexes)

## 2.2. Front Panel Controls

This section provides a very brief overview of the front panel of the Argonaut VI, more details on each control is given later in this manual.

### Two Dual Concentric POTS (1, 2, 3, 4)

The Argonaut VI front panel provides two dual concentric multi -function pots. One for AF/RF Controls, and the other for BW/PBT controls. Using the AF knob, rotating the knob fully counter clockwise removes power from the Argonaut VI. Rotating the AF knob clockwise will apply power to the Argonaut VI and increase AF Levels. Using the BW knob, rotating fully counter clockwise enables the adjustment of further mode dependent features. More on this later in the manual. Rotating the BW knob clockwise will increase or widen the selected DSP Bandwidth.

### Three Position Switch TMB (5)

There is a three position switch on the front panel with text T, M, and B next to it. These refer to the position of the switch T(op), M(iddle), and B(ottom), which identifies which function the four multi function buttons will perform.

### Main Encoder for various adjustments (6)

There is a single Main Encoder on the front panel that is used primarily for adjusting the tuned frequency. It also serves as the adjustment on various other features.

### Multi Function Buttons (7, 8, 9, 10)

There are four buttons on the front panel to change different operational features within the Argonaut VI. These buttons perform multiple functions. The Primary Function for the buttons on the Argonaut VI is screened directly on the button. Notice the four buttons have text printed above the button, on the button, and below the button. The location of the TMB switch identifies the function as stated by the T(op) row of text above the button, or the M(iddle) row of text printed on the button, or the B(ottom) row of text printed below the button. These buttons also take on a fourth meaning when the BW pot is adjusted fully counter clockwise and the switch clicks to the (CW) position. The functionality is described in the following sections.

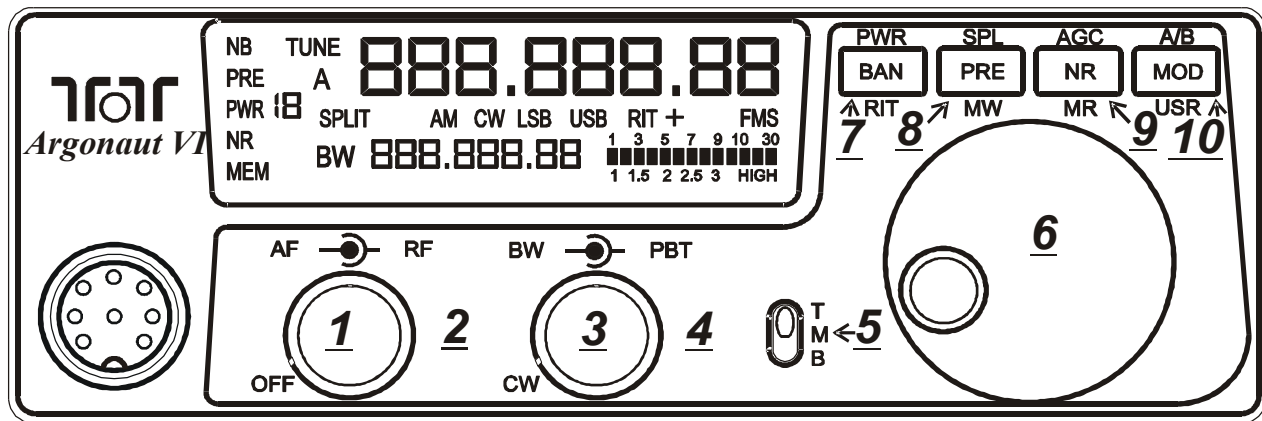

Figure 2-1 539 Front Panel- (with indexes)

## 2.3. General Operations

This section of your Argonaut VI Manual will discuss the button operation and adjustments common to all modes on the Argonaut VI. It is important to read this general operations section prior to operating the Argonaut VI because the BW Pot (3) and the state of the “TMB” three position switch (5) change the function of the four push buttons (7, 8, 9, 10).

### AF Gain Control And Power Switch (1)

The inner knob (1) of the AF/RF knob provides two functions: Power control for the rig and the AF Gain control.

### Power Switch (1)

To turn on the Argonaut VI, rotate the AF Gain control (1) clockwise. The LCD screen will display the current firmware version and unit serial number for three seconds. The LCD screen will then display the last band, frequency, and mode used. To turn off the Argonaut VI, rotate the AF Gain control (1) counter clockwise until power is removed and the LCD display turns off. To place the Argonaut VI in any of the special power up modes, see the section on “**Power Up Modes**“ for more information.

### AF Gain Control (1)

This control adjusts the volume of the internal speaker, and also for the headphones if one is plugged into the rear jack. Rotating the AF Gain control clockwise will increase the volume to a maximum of 100% at full clockwise rotation.

### RF Gain Control (2)

The outer ring (2) of the AF/RF knob provides the RF Gain feature. Adjusting the outer ring RF Gain control clockwise increases RF Gain action up to 100% at the full clockwise rotation. Adjusting the outer ring RF Gain control counter clockwise decreases RF Gain action down to 0% at the full counter clockwise rotation. Depending on signal strength you may find a more pleasing signal to noise ratio by turning the RF gain control down to a comfortable listening level.

### AF/RF Gain Control Usage Tips

One way to make a noisy band easier to listen to and pull out weaker signals is to decrease the RF Gain to the point where the audio is difficult to hear, then increase the AF Gain. Balancing these two controls in a TenTec transceiver helps one pull out signals, and helps decrease the band background noise to a level that is much more enjoyable and reduces contest fatigue.



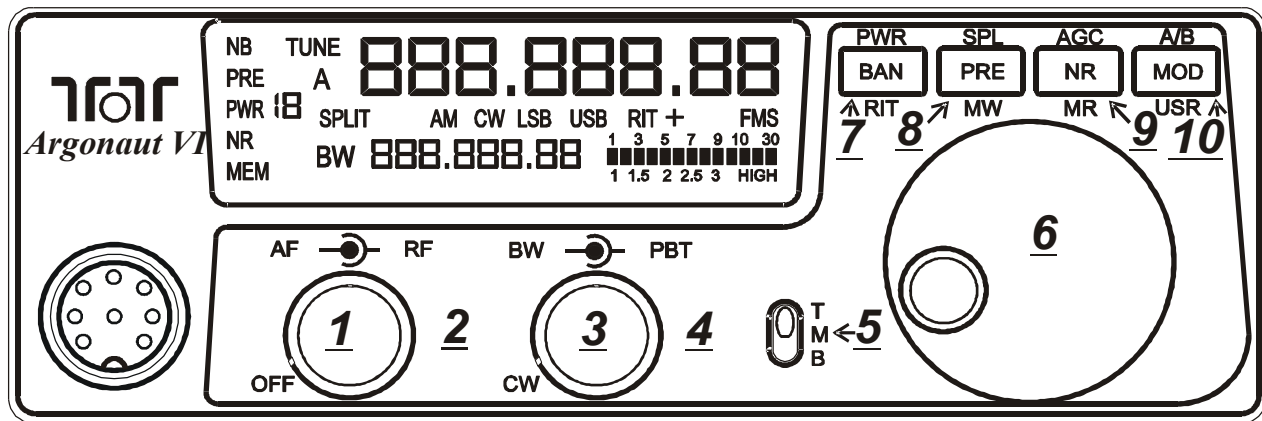

Figure 2-1 539 Front Panel- (with indexes)

### BW (3) Bandwidths

Adjusting the BW control will allow you to select the DSP filtering of your choice. This will increase the selectivity of receive and helps remove close in unwanted signals.

The range of the DSP filters is 100hz to 2500hz in 25hz increments. When the optional 6kHz filter is installed, this permits 4k, 5k, and 6k DSP bandwidth selections. When dealing with crowded band conditions and close in adjoining signals one will find this control very useful as you begin to narrow the filter to eliminate close in unwanted signals. This control will automatically select the correct roofing filter ahead of the DSP filtering provided a specific roofing filter is installed.

### PBT (4) Pass Band Tuning

Verify that the PBT control is at 12 O'clock to begin listening in all modes.

The PBT control will allow you to move the passband back and forth across the desired signal. It is beneficial in dropping QRM out of one side or the other of the passband or it can simply be used to improve the quality and intelligibility of the signal. An excellent experiment for digital communications is to work the PBT control along with the BW bandwidth control for the greatest selectivity and interfering signal rejection.

### Band (7)

Be sure TMB switch is in Middle position. To change bands or toggle through the Ham bands press the BAN button and the next Ham band will be recalled. BAN will only toggle through the Ham bands in one direction. When the band is changed, the A Frequency, the B Frequency and the Mode are recalled from the last time the band was used. Since the Mode is recalled, the Tuning Rate, and the AGC will also be recalled from the last time that Mode was used.

### Split (8)

To operate SPLIT mode be sure TMB switch is in the Top position. Press SPL (PRE) button. The word SPLIT will appear between VFO A and VFO B. VFO B will show the transmitted frequency in smaller font. To exit SPLIT mode, press the SPL (PRE) button one more time turning off the word SPLIT.

### AGC (9)

Be sure TMB switch is in the Top position. Press AGC (NR) button will toggle the AGC between fast, medium, and slow. The letter F, M, or S will appear below the last digit on VFO A

### A/B (10)

Be sure TMB switch is in the Top position. When you press and hold the A/B (MOD) button you will now be able to set B VFO to equal VFO A. A quick press of the A/B (MOD) button will reverse both A and B VFO.

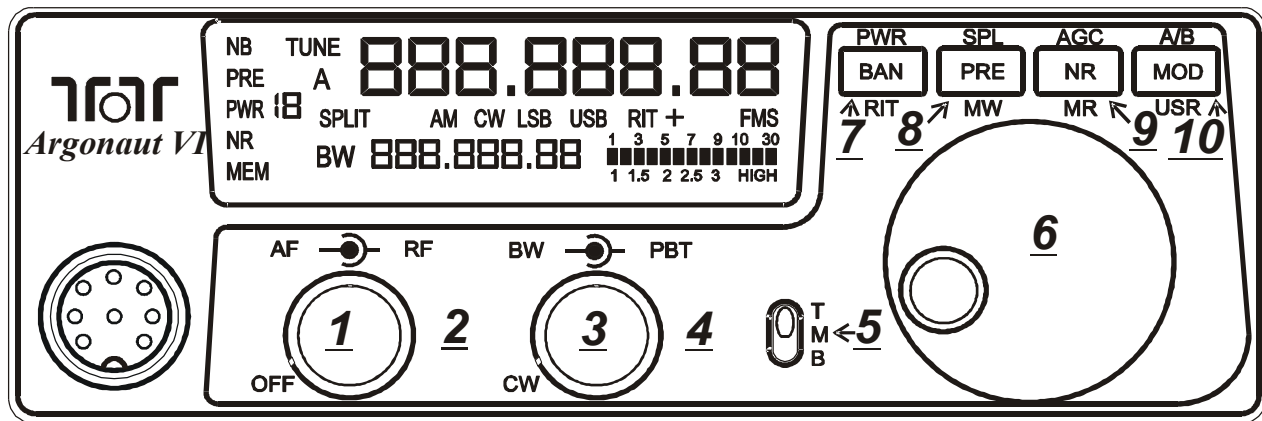

Figure 2-1 539 Front Panel- (with indexes)

## RIT (7)

Be sure TMB switch is on the Bottom position. The RIT can now be toggled on and off by pressing the RIT (7) button. RIT will now be displayed on the front of the screen. As you rotate the main VFO knob you will notice a + or – sign appearing to the right of the RIT. A numerical value at the bottom center of the screen indicates each 10 Hz above or below the main VFO frequency. If you toggle the RIT (7) button again after setting the RIT up or down it will automatically reset and turn off the RIT control returning it to zero.

## POWER (7)

Be sure TMB switch is in the Top position. The power can now be adjusted by pressing the PWR (7) button. As you toggle this button you will notice PWR will begin to flash on the left side of the screen. While PWR is flashing Rotate the main VFO knob up or down to display the output power desired. Pressing the PWR (7) button one more time will turn off the flashing PWR and lock in the desired output of the radio.

## Mode (10)

Be sure the TMB switch is in the Middle position. Pressing the MOD button will toggle the modes to your desired choice. The Argonaut VI will change modes each time the button is pushed. The desired mode is displayed in the middle of the Argonaut VI screen between VFO A & B. The Mode setting utilized in a given band will be recalled when that band is used again.

Remember, AM mode will not be displayed or active unless EaD has been selected within the configuration menu.

## Headphones (20 on rear panel)

Headphones using a ¼” mono or stereo connector can be plugged into the jack 20 located on the rear of the Argonaut VI. Headphone Impedance from 8-32 ohms will offer adequate audio levels. When plugged into the Argonaut VI the main speaker will be deactivated.

## Tuning Steps and VFO LOCK (8)

To select tuning steps of 10Hz, 100Hz, or 1kHz be sure TMB button is in the Middle. Press/hold the PRE button. The Argonaut VI will beep when the step size changes. One Beep means 10hz steps. Two beeps means 100hz steps. Three beeps means 1000hz steps. Four beeps means the main VFO encoder is now locked, and is indicated by a “L” in front of the VFO A display. To exit the “Locked” state, press/hold the PRE button until the desired step size is shown again.

## PRE (8)

The preamplifier in the Argonaut VI is designed to give you a 12dB increase in signal strength. Be sure the TMB switch is in the Middle position. Pressing the PRE button will toggle the receiver Preamp on or off. When the Preamp is on, PRE is shown on the left side of the display. The S Meter reading will not change when the Preamp is engaged.

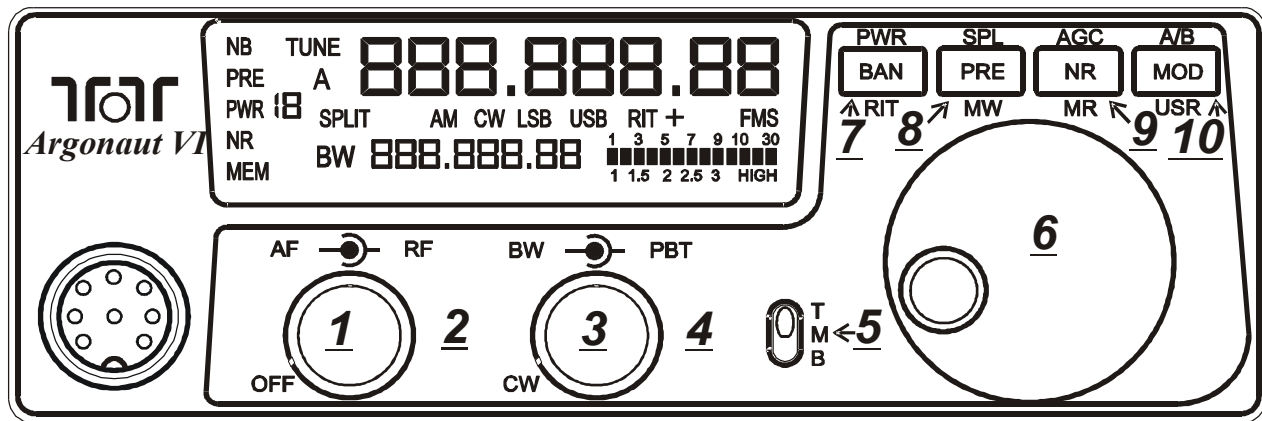

Figure 2-1 539 Front Panel- (with indexes)

### Recalling A Stored Memory (9)

Both mode and frequency can be stored in 1-100 memories within the Argonaut VI. To store a frequency in memory be sure the TMB switch is on the Bottom. Select your desired frequency and mode then press the MR (NR) button. One beep will sound. MEM will appear to the bottom left side of your front screen. A previously inserted memory frequency or --- --- -- will appear on the screen providing for the next vacant memory. A numeric channel number will appear below the mode. Rotate the main VFO knob to select your desired vacant memory location. Press and hold MR (NR) until you hear one beep, then quickly release the MR (NR) to lock in that memory location. Use the main VFO knob to scroll through 100 different memories available and view which memory locations are vacant. You may re-write to an existing memory location by scrolling to that memory number. To exit MEM mode without saving any changes quickly tap the MR (NR) button to exit back to your VFO frequency and mode.

### Storing a Frequency to Memory (8)

To store a memory channel be sure the TMB switch is on the Bottom. Press down the MW (PRE) to enter the memory mode. Rotate the main VFO knob to select the desired memory location. Next press and hold the MW (PRE) until you hear 1 quick beep. Your frequency and mode will now be stored. Upon release of this button the MEM will also disappear.

To cancel or empty a memory channel be sure the TMB switch is on the Bottom. Press down the MW (PRE) to enter the memory mode. Rotate the main VFO knob to select the desired memory location. Next press and hold the MW (PRE) for 2-3 seconds or until you hear four quick beeps. Any frequency which has been entered will now be removed. Upon release of this button the MEM will also disappear from the screen.

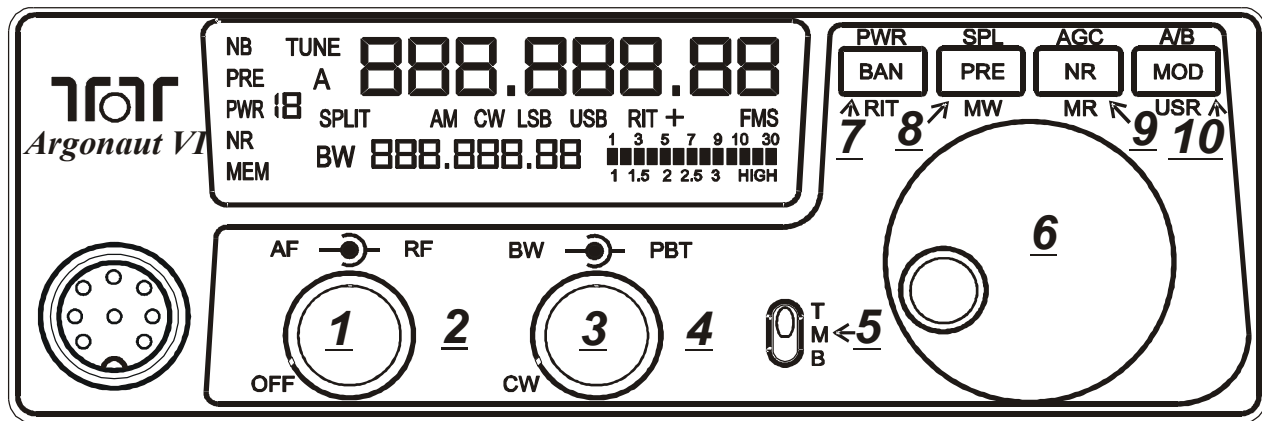

Figure 2-1 539 Front Panel- (with indexes)

## NR/NB (9) Noise Reduction/Noise Blanker

Be sure the TMB switch is in the Middle position. By pressing the NR button once you will toggle the noise blanker on. NB will be shown on the top left side of the screen. Pressing the NR button a second time will turn off the noise blanker and turn on the noise reduction. Pressing the NR button a third time will turn on both the noise blanker and the noise reduction. Both NR and NB will appear on the left side of the screen when toggled on or off.

Exit by toggling the NR button until the NR/NB or both disappear from the screen

To adjust the how aggressive of either the noise blanker or the noise reduction follow these steps: Begin by turning both NR & NB off so you can begin setting these features independently. Ensure that the TMB switch is in the Middle position. Ensure that the bandwidth control is pointing to 12 o'clock.

To adjust how aggressive the noise blanker operates, press the NR button (1 beep). Press and hold the NR button one more time (1 beep) You will now see (nb) displayed on the screen with a numerical value just left of the SWR/PWR meter. Use the main VFO knob to change to the required value. Press the NR button one more time to set the desired value to the Argonaut VI.

To set how aggressive the noise reduction feature works toggle the NR button until just the NR appears on the left side below PWR. Follow the directions above to set the desired value to the Argonaut VI.

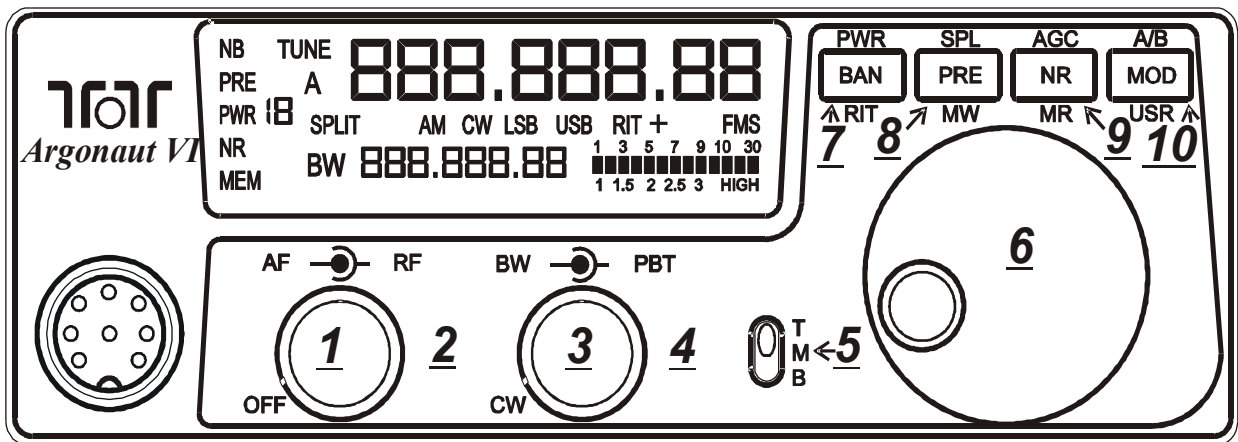

Figure 2-1 539 Front Panel- (with indexes)

## 2.4. SSB Mode Operation

Be sure the TMB switch is in the Middle position. To begin SSB operation toggle the MOD button to either the LSB or USB for the mode of you wish to operate. The Argonaut VI will display the last mode you have selected when toggling through the bands. Note: Remember to set the PBT (4) control to the center of rotation so the side band signal is centered in the desired filter. This results in a starting point for proper side band audio.

### Monitor Level (3, 5, 7)

To monitor your SSB, audio input levels, or Speech Processing level, a built in monitor can be heard best with a set of headphones connected to the Argonaut VI. To activate the monitor feature you must first set the Argonaut VI into either LSB or USB. Be sure the TMB button is in the Middle. Rotate the bandwidth control until switched to the CW position. Press the BAN button and you will see (**nnon LUL**) on the screen. The level can be adjusted from the main VFO knob and a level amount will be displayed on the bottom center of the screen. 0 means no Monitor output, and non-zero means that % will be added to the speaker and headphone outputs. The level is still active whenever a non-zero value is used and will be heard in voice transmit modes when transmitting regardless of whether the monitor is in the adjustment mode or not.

### Speech Processing (3, 5, 8)

Be sure the Argonaut VI is in the USB or LSB mode. To turn the Speech Processor on be sure the TMB switch is on the Bottom. Rotate the bandwidth control until switched to the CW position. Press the MW (PRE) button. The screen will display (**SP PrOC**). Adjust the desired amount of processing with the main VFO knob 0-9. When set at zero the processor will be turned off. Any setting from 1-9 will be active and remain on all the time when in side band modes. To exit simply press MW (PRE) and the main frequency display will be brought back on screen.

**Remember: When you are finished making adjustments to Monitor Level and Speech Processing values, turn the BW pot clockwise from the CW position to return the Argonaut VI to normal operational modes.**

### Auto Notch (9)

The Argonaut VI provides an Automatic Notch feature. AN will operate in CW and Voice modes. To turn it on and off requires that you select USB or LSB mode. Then rotate the bandwidth control until switched to the CW position. Press the NR(9) button. This toggles the AN setting. There is no indication on the front panel for Auto Notch. When you press the NR (9) button, 1 beeps means that Auto Notch is disengaged, and 2 beeps means that Auto Notch is engaged. Auto Notch state is not remembered during a power cycle, and it will default to Off upon power up.

## MIC Connector

Front panel jack used for connection of a microphone. The Argonaut VI features the common 8-pin microphone jack used in many amateur radio transceivers. Most dynamic or Electret Microphones can be used. When adapting a microphone, please refer to the wiring diagrams in Figures 2.4-1 and 2.4-2

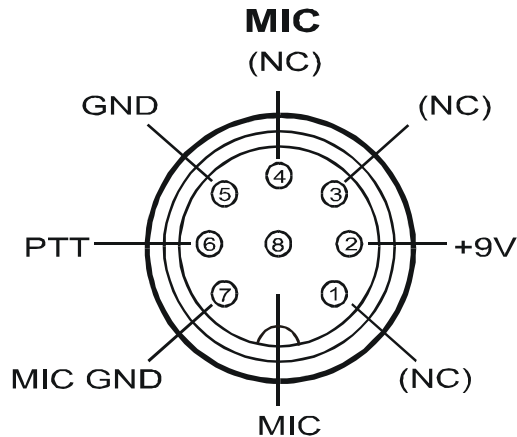

Figure 2.4-1 Transceiver Microphone Jack Front View

Pin 2 (+9 Vdc) need only be connected if the microphone element in use is an electret condenser requiring a polarizing voltage.

Chassis ground and mic signal ground are separated to reduce the possibility of introducing stray hum or RFI into transmit audio signal. We recommend that the case of the microphone also be tied to chassis ground on the transceiver via a shielded cable to pin 5. This is to help assure stray RF does not have a path to be coupled into transmit audio.

The cable carrying mic signal and mic signal ground should be shielded. This prevents the cable itself from acting as an antenna and coupling RF back into mic audio. NOTE: Some aftermarket microphones are not wired with separate microphone signal grounds and chassis ground. We recommend separate pins

for use for mic negative signal and chassis ground as shown in Figure 2.4-2

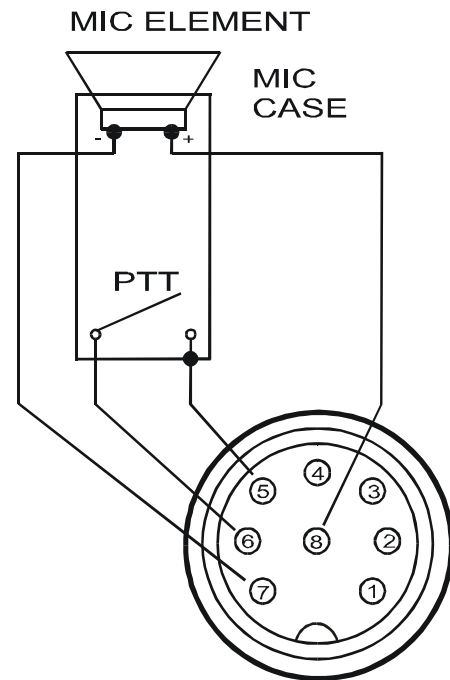

Figure 2.4-2 Transceiver Microphone Jack Recommended Cable Wiring

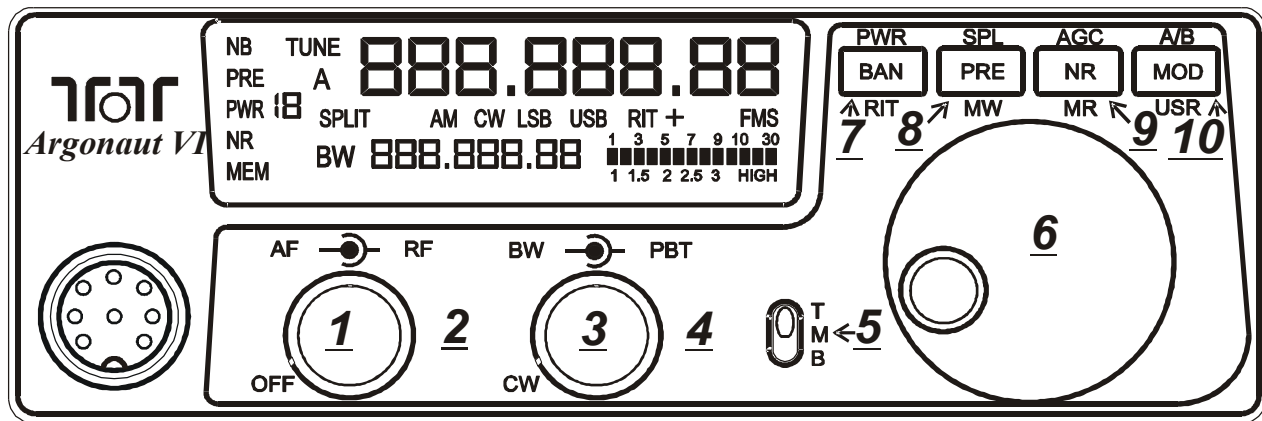

Figure 2-1 539 Front Panel- (with indexes)

### Mic Gain and Line Gain(10)

Be sure TMB switch is in the Bottom position and the Argonaut VI is in either LSB or USB mode. Press USR (MOD) button until you see **(mI CgAI n)** on the front display. Use the VFO knob to adjust the microphone gain until the ALC light flickers on voice peaks when speaking into the microphone. This is the LED light within the Ten-Tec logo. Once set just press the USR (MOD) button once more to exit. To set the LINE GAIN press and hold the USR (MOD) button down until the screen displays **(LinEgAI n)** and like before adjust the level with the main VFO knob. Once the line gain and microphone gain have been established both levels will remain unless a master reset is done. To toggle between microphone input and Auxilliary Line input simply press the USR (MOD) button once for microphone gain or hold down this button for Line Gain.

If other microphones are used with the Argonaut VI, which may need more gain, Ten-Tec has provided a hardware microphone gain control, See Figure 2.4-3. Setting the microphone gain around 35-50 and then adjusting the trim pot on the right side of the transceiver until proper ALC is accomplished will help make the Argonaut VI flexible with a multiple of different style microphones.

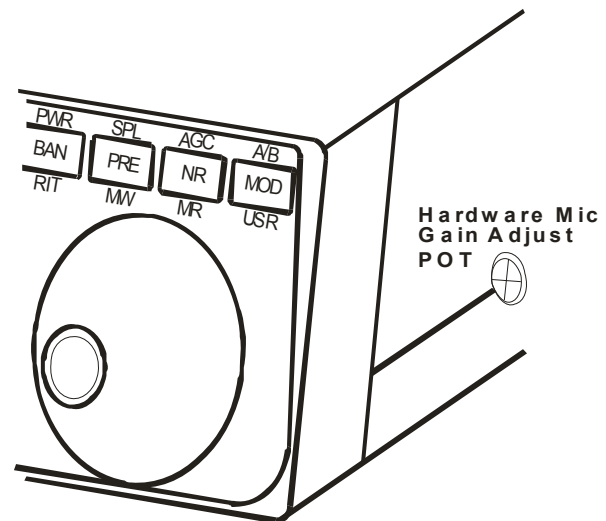

Figure 2.4-3 HW Mic Gain Control

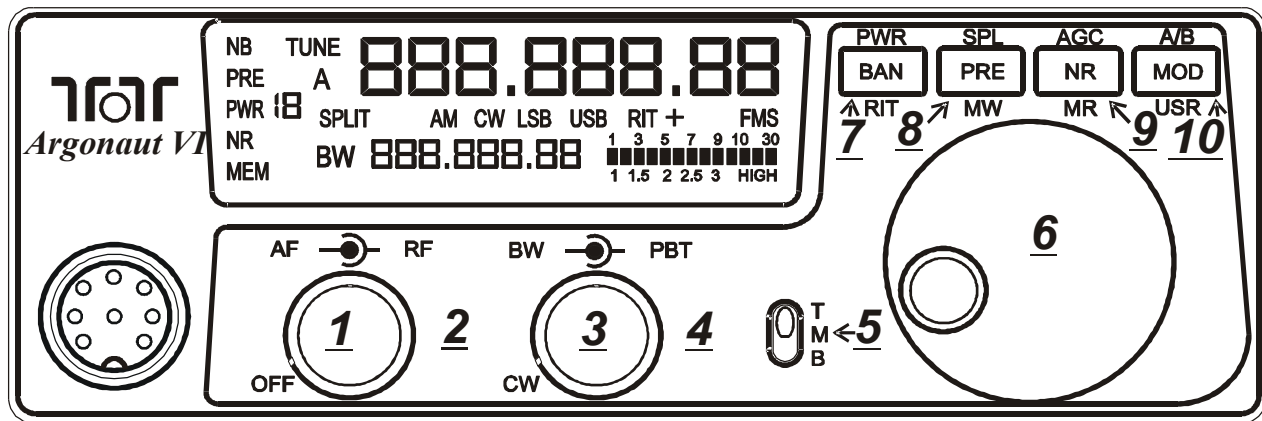

Figure 2-1 539 Front Panel- (with indexes)

## 2.5. CW Mode Operation

### Setting Up CW Parameters (3,5,7,8,9,10)

Ensure that the Argonaut VI is in CW Mode. When finished, rotate the Bandwidth back to the desired value.

### Internal Keyer CW Speed Setting

Ensure that the bandwidth control is pointing to 12 o'clock. Switch the TMB switch to the bottom and press the MR (NR) button until the screen displays (**SPEED**). Use the VFO knob to adjust the speed 5-50 words per minute. Press this button a second time to set your desired speed into the internal keyer.

### Internal Keyer Weighting / Dit Spacing & Curtis Mode A/B

Ensure that the bandwidth control is rotated fully counter clockwise in the CW/Clicked position. Switch the TMB switch to the bottom and press the MR (MOD) button until the screen displays (**dit sp**). You may now adjust the dit spacing with the main VFO knob. Note! Values will appear on the lower section of the screen.

Press the MR (MOD) button a second time and your display now shows (**nnOde**). You may now select either Curtis Mode A or B with the main VFO knob. The value selected is shown in the VFOB frequency area. A value of 0 means Curtis Mode A will be used when the internal keyer is used. A value of 1 means Curtis Mode B will be used when the internal keyer is used. Press the MR (MOD) button a third time will return to regular VFO mode and your settings are stored.

### CW Sidetone Frequency

Ensure that the bandwidth control is rotated fully counter clockwise in the CW/Clicked position. Switch the TMB switch to the bottom and press the MR (NR) button to set the side tone frequency (**st fr**). Adjust the side tone frequency with the main VFO knob and the frequency in hz is shown in the VFOB frequency area. Press this button a second time to store the side tone frequency.

### CW Sidetone Level

Ensure that the bandwidth control is rotated fully counter clockwise in the CW/Clicked position. Switch the TMB switch to the bottom and press the MW (PRE) button to adjust the side tone level (**st lvl**). Adjust the side tone level with the main VFO knob and the value in % is shown in the VFOB frequency area. Press this button a second time to store the side tone level.

### QSK Delay

Ensure that the bandwidth control is rotated fully counter clockwise in the CW/Clicked position. Switch the TMB switch to the bottom and press the RIT (BAN) button to adjust your amount of QSK Delay (**dELAY**). This is the time from when the transmit signal ends until when the receive audio returns. A setting of 0 means full QSK break in, and a setting of non zero means more delay. Press this button a second time to store your desired QSK Delay into memory.



## CW Keying and Wiring

The rear panel on the Argonaut VI has a 1/8" stereo jack for connection of a key paddle. See Figure 2.5-1 for proper wiring.

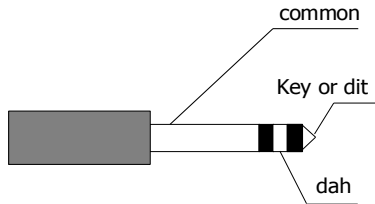

Figure 2.5-1 CW Key Wiring

A straight key, bug, or external keyer can be used with the Argonaut VI. Simply plug a 1/8" mono style connector wired to your device into the rear apron of the Argonaut VI, see Figure 2.5-2. When power is turned on the Argonaut VI will detect that mono device automatically. If you should forget and plug it in after power has been applied simply toggle the mode button once through all modes and back again to CW.

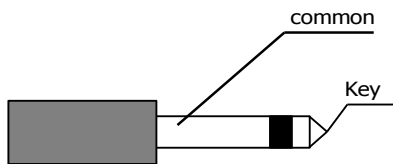

Figure 2.5-2 1/8" Mono Connector Wiring

## 2.6. AM Mode Operation

To operate the Argonaut VI in AM mode you must have the 6 KHz filter installed and you must select EA d in the configuration menu. The peak modulated carrier level will be set automatically for the power level you choose.

## 2.7. Digital Mode Operation

For most audio derived digital mode operation you will either be in USB or LSB. To set up the Argonaut VI for digital communications using the ACC-1 rear connector you must first turn on the ACC-1 line input.

To set the LINE GAIN be sure the TMB switch is in the bottom position and the radio is in LSB or USB. press and hold the USR (MOD) button down until the screen displays **(LinEgAln)** and adjust the level with the main VFO. To exit simply press the USR (MOD) button one more time. It is important to note that you will see different audio levels from different software programs so remember which favorite programs will need more gain levels than others. Windows audio controls will also need to be set within the specific programs you will be using. This is usually found under the SETTINGS on your digital mode programs. A proper audio level occurs just as the ALC light flashes slightly when in transmit. If the ALC light is on continuously you probably have too much audio into the Argonaut VI.

## **2.8. Interfacing to a computer for Firmware Update Mode and PC Control/Logging Purposes**

The software interface for the Argonaut VI utilizes standard Windows driver supplied with Windows versions XP through Windows 7. An installation program is available for download at the TenTec download webpage for the Argonaut VI. Start at [www.tentec.com](http://www.tentec.com), and follow the links until you get to the Argonaut VI's Download page. Look for the latest instructions entitled "USB to UART driver Installation...". Download and follow the instructions.

If at any time you need to see what "port" the Argonaut VI is connected to, go back into Device Manager, expand the "Ports (COM & LPT)" selection, and you should see "USB to UART (COMx)". Note the x in the COMx that is reported by Device Manager. You will use this number when running Logging or Control programs, the Flash Update Utility, etc.

If required, you can change the actual port number being used to a lower number if required. Sometimes the update program on some computers will require a port number lower than 10. To do so, double click the USB to UART (COMx) text, go to port settings, select advanced, and select a different COM Port Number from the pull down box. It may display a warning message, if it does, confirm/ok the change. Click OK/Confirm/etc. until all windows are closed. Disconnect the Argonaut VI, wait a few seconds, reconnect the Argonaut VI, and you should see the new port number in Device Manager.

NOTE: when you plug the USB cable into a different USB port on the PC, it will most likely get a new COMx port number defined. Be aware of this when reconnecting the USB cable to the computer so that you can set it properly in the computer program that you are using to communicate with the Argonaut VI.

## 2.9. Power Up Modes Configuration Menu (PWR(7))

When optional items are ordered with your Argonaut VI, then these optional items will already be installed and configured at the factory in the Configuration Menu. This includes additional roofing filters and whether or not AM mode is enabled.

If you as an owner need to configure the Argonaut VI, start with the Argonaut VI powered off, switch the TMB switch on the front panel to T (TOP), press the PWR(7) button, and continue to hold the PWR(7) button while powering up the Argonaut VI. Release the PWR(7) button. The front panel display will show “F1 nO” which indicates no filter has been installed. To select a different value for a given Configuration Menu item, press the PWR(7) button again and use the VFO knob to scroll through the choices. Once the correct choice has been made advance to the next Configuration Menu item by pressing the PWR(7) button. Once the settings in the Configuration Menu have been set to the desired values, press any key on the front panel except the PWR(7) button to exit the Configuration Menu.

The items contained in the Configuration Menu and their options are shown in the following table.

Item	Settings	Notes:
F1	nO / none “60”= 6KHz “29”=2.9KHz “07”= 700Hz	Refer to Section “ <b>Optional Filter Installation</b> ” for more information on physical installation of each filter Valid options are 6kHz or nO. Default is nO
F2	Same as F1	Same as F1 Valid options are 2.9kHz or nO. Default is 29 (for the 2.9KHz filter)
F3	Same as F2	Same as F1 Valid options are 700Hz or nO. Default is nO
EA d	Enable AM detection On / OFF	Requires 6.0 KHz Filter The 6.0KHz filter can only be inserted in slot F1 Default is OFF

Table 2.9-1 Configuration Menu Items

### Master Reset (SPL(8))

Master Reset is used when you want to bring the radio settings back to factory default. This includes user settings and user memories. To perform a master reset to the Argonaut VI, be sure that the TMB switch is in the T(op) position. Now simply press and hold down the SPL(8) button at the same time you turn on the power. Continue to hold down the SPL(8) button until the screen says “reset”.

You have now performed a reset to the Argonaut VI which will also clear all memories and settings you have placed in your transceiver. Performing a reset means you will need to enter the Configuration menu described in Advanced Settings to program your filter positions and AM enable.

## **Firmware Update Mode (A/B (10))**

To upgrade your transceiver, visit the TenTec web site ([www.tentec.com](http://www.tentec.com)) and download the installer for the latest firmware version. A link will be available on the 539 Downloads page. This link will be titled with the available version number of the firmware. Example: "Firmware Version 1.585". The Date of the file will also be shown.

Here is the sequence of steps to follow once the .exe file has been downloaded from the Downloads web page for the Argonaut VI/539.

- 1) Turn Transceiver OFF.
- 2) Turn Transceiver ON to verify that the Argonaut VI has appropriate power. E.g. the Argonaut VIs front panel display shows the normal indicators and frequencies.
- 3) Turn Transceiver back OFF.
- 4) Connect a PC to the transceiver using a standard USB cable. (Note: if already connected, disconnect for a second or two, then reconnect, helps computers that don't "disconnect" the USB driver unless it is physically disconnected)
- 5) Be sure the TMB button is on Top. Turn the Transceiver ON while holding down the "A/B" (MOD) button.

When the Argonaut VI starts up in flash update mode, you will see the TX/ALC LED flash on for a second, then back off, then back on for a second. IF the USB Cable is connected and the drivers are working properly in the PC, then the TX/ALC LED will turn back off. If the TX/ALC LED remains lit and does not shut back off, then check your USB cable and ensure that the drivers are installed before proceeding.

- 6) Start the Update program
- 7) Select the COM port to which the Transceiver is attached.
- 8) Choose UPDATE under the PROCESS menu.

- 9) Select the RUF file under the Process Menu.
- 10) The program will update the radio and report any errors encountered. During the update process the TX/ALC LED will flicker showing active communications. The update program will confirm that lines are getting sent/programmed.
- 11) When finished, the 539 Argonaut VI will restart and run the new firmware.
- 12) Sometimes Windows doesn't like the transition of the radio from firmware update mode to radio mode, so it is suggested that once the radio is back up and running showing the tuned frequency, turn the rig back off, wait a few seconds, then turn it back on. This helps Windows find the USB / COM port easier.

## 2.10. Optional Filter Installation

The Argonaut VI has three filter slots: Filter Slot 1 (F1), Filter Slot 2 (F2), Filter Slot 3 (F3). The Argonaut VI comes standard with a 2.9KHz filter installed in Filter Slot 2 (F2). Optional filters are available for the Argonaut VI as follows:

Filter	Part Number	Slot for Filter
6 KHz	2003	F1
2.9 KHz	Standard	F2
700 Hz	2006	F3

Table 2.10-1 Optional Filters

### Optional Filter Installation

Optional Filters can be installed in the 3 filter slots as described below.

To install new filters:

1. Remove the 4 cover screws, 2 on each side of the Argonaut VI.
2. Carefully raise the top cover.
3. If necessary, unplug speaker cable located on the left side of the main board.
4. Set the top cover aside
5. Remove the two screws that hold down the Filter cover over F2 and F3, and set it aside.
6. You now see the standard 2.9KHz Filter installed in Filter Slot 2 (F2), and two more filter slots.
7. The 6 kHz AM filter must be installed in slot F1 due to the height difference and speaker arrangement. The 700Hz filter should be installed in slot F3.
8. Locate the F1, F2, F3 slot to insert the specific filter. Refer to Figure 2.10-1. This is according to the filter slots on the circuit board text. The order is shown on the circuit board as F1, F2, F3 going from right to left toward the center of the radio. The ground pins are easily distinguished

by the way the pins and outer case connect together. The ground pins will be inserted into the left holes as you face the front of the radio. If your filter comes with the vibration barrier attached to the bottom just temporarily remove this cover to identify the ground location and re-install vibration barrier.

9. Reinstall the Filter Cover using the two screws.
10. If you disconnected the speaker in step 3, then reconnect it now.
11. Reinstall the top/bottom covers with the 4 screws from step 1. Take care not to pinch any wires between the top cover and the filter cover or any of the brackets.
12. Refer to the section on the “**Configuration Menu**“ on how program the Argonaut VI firmware to use this Filter Setup.

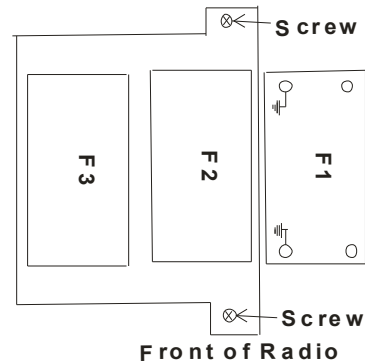

Figure 2.10-1 Filter Location Showing Ground Orientation

## **2.11. Extended Feature**

### **Access via USB/Serial**

There are more features available for the Argonaut VI that are not accessible via the front panel controls. For this purpose, the USR button, MR button, and MW button are able to be programmed with new functionality using a PC.

The USB interface also permits changing various settings that cannot be mapped to front panel control buttons.

This includes features such as VOX, AN, etc.

## **2.12. Retaining User Settings**

The Argonaut VI operates the same as most modern TenTec rigs do with regards to the ability to retain user settings through a power reset. For various reasons, user settings are not immediately written into the non-volatile memory every time that the user changes a setting. When a user setting is changed, this value will be stored 15 seconds after the user has made his last change to any user setting.

Example:

Change Main Frequency to 14.02 (This starts the 15 second user value store timer)

2 seconds later change Mode to CW (This resets the user value store timer back to 15)

5 seconds later change AGC to Slow (This resets the user value store timer back to 15)

Finally, do nothing for 15 seconds, and all of the above values will be stored.

If changes are made, and the unit is turned off before the 15-second timer has expired, then all of those changes made since the last store point will be lost.

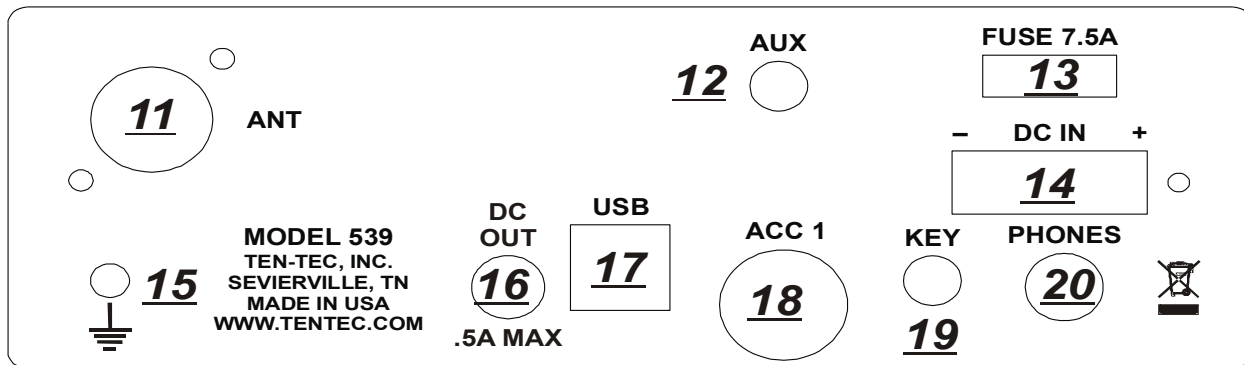

Fig 3-1 Argonaut VI Rear Panel

### 3. Argonaut VI Rear Panel

#### ANT (11)

The ANT connector is an SO-239 jack used for connection of a coaxial fed transceiver antenna, nominal impedance 50 ohms, for use on any band the Argonaut VI covers.

#### AUX (12)

The Argonaut VI provides internally a location where 9MHz IF can be brought out from the radio. This is the access hole for this 9MHz IF data stream for use with external panadapters. It is advisable to utilize an external panadapter with a buffer amplifier.

#### FUSE (13)

Auto Style 7.5A

#### DC IN (14)

Power line for the Argonaut VI. It is an AMP MATE-N-LOCK, 2 pin

#### GROUND TERMINAL (15)

The wing-nut equipped post is for connection of station ground or counterpoise. See Section “A Word About Grounding”. The ARRL also offers excellent information in the ARRL Handbook concerning station grounding.

#### DC OUT (16)

The Argonaut VI is equipped with one DC output connectors to power various accessories. The output power is limited to 0.5 Amp maximum.

#### USB (17)

The rear panel on the Argonaut VI has a Standard B type USB connector. This connector is used for connecting to a PC to perform updates of the firmware, or for logging or control via various available computer programs.

#### KEY (19)

The rear panel on the Argonaut VI has a 1/8” stereo jack for connection of a key paddle. See Figure 2.5-1 and 2.5-2 for proper wiring.

#### EXTERNAL HEADPHONES (20)

This jack is for connection of an external speaker or headphones. When connected using a standard 1/4” phone plug, the internal speaker in the Argonaut VI is disabled. Tip of the 1/4” phone plug is audio, sleeve is ground.

## ACC 1 (18)

The Argonaut VI is equipped with an 8 pin accessory connector. Refer to following figure for the pin definitions as viewed from the rear panel.

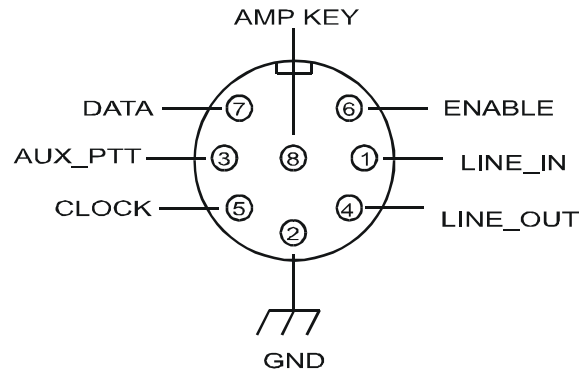

Figure 3-2 ACC1 Pin out

The pin out and function are listed in the following table:

Pin	Name / Direction	Usage
1	Line In / Input	Line level Audio input from an accessory device (like a TNC or sound card for digital mode operation.) Selected using the front panel MIC button.
2	Ground	Grounding
3	Aux PTT / Input	In Voice Modes, when grounded, this pin will key the radio and begin transmitting. In CW Mode, this pin can be used as a keying input for an external device such as an external keyer or a computer running a CW generator program.
4	Line Out / Output	Line Level Audio output.
5	Clock / Output	Future Use (Do NOT connect to this pin)
6	Enable / Output	Future Use (Do NOT connect to this pin)
7	Data / Output	Future Use (Do NOT connect to this pin)
8	Amp Key Line	Used to key an external device, such as an Amplifier. Occurs ~17ms before RF is generated.

Table 3-1 ACC1 Pin out

External devices can utilize the clock/data enable to identify band changes. The protocol is defined in the Programmers Reference Guide for the 539.



## Keying a Linear Amplifier

Pin 8 on ACC-1 will provide an open collector output for keying a linear amplifier. The Argonaut VI provides a 17 ms closure delay before RF is supplied to the linear amp. Refer to Figure 3-2 for wiring to this connector. Remember to use shielded cable for making this connection. The amp key line is NOT a relay similar to those found on many older transceivers. It is a transistor switch rated for a maximum of 24 volts and 250 mA from the key line of your amplifier. Many older amplifiers using an AC relay or relay voltages exceeding the limits of the Argonaut VI must use an amplifier interface relay such as the model 318 sold through the Ten-Tec company. When using the Ten-Tec model 418 solid state linear (sold separately) the proper interface cable is provided with the amplifier for both keying and band changing the 418.

## 4. Accessory Devices

### 4.1. List of Optional Accessories For The Argonaut VI

The Argonaut VI permits the usage of several optional accessories. At the time this manual was printed, the list includes the following items:

Item	Part/Model Number
6 KHz Filter	2003
700 Hz Filter	2006
USB/Soundcard adapter Interface	712
4 Ft DC Cable	86095

Table 4.1-1 Optional Accessories

### 4.2. Using the 712 USB/Soundcard Interface

To use the 712 soundcard interface for digital modes, connect the 712 device between the ACC-1 connector and the USB port on your Windows computer. Audio generated from your favorite digital programs can be used with the Argonaut VI. See the section “**Digital Mode Operation**” for directions on how to set up the the line input for digital mode operation.

The 712 USB Soundcard Interface should only be connected to the Argonaut VI when the setup is intended to be used for Digital modes via the PC. Remember, the USB Soundcard, when plugged in, becomes the sound card that all windows sounds and video sounds will go through. Meaning, when the 712 detects audio from the PC, e.g. a Windows DING, it will put the Argonaut VI into transmit.

## 5. Specifications

### 5.1. Transceiver Specifications

#### GENERAL

<b>Microphone Connector:</b>	8-pin on front panel
<b>Headphone Jack:</b>	1/4" stereo, accepts mono or stereo on rear panel
<b>External CW Key Jack:</b>	1/8" stereo, accepts mono or stereo on rear panel
<b>Aux DC Output Connector:</b>	RCA 0.5A max connected to DC Power
<b>Frequency Range TX:</b>	1.795-2.005 (160M), 3.495-4.005 (80M), 6.995-7.305 (40M), 10.095-10.155 (30M), 13.995-14.355 (20M), 18.063-18.173 (17M), 20.995-21.455 (15M), 27.995-29.705 (10M).
<b>Frequency Range RX:</b>	1.795-2.505 (160M), 3.495-5.005 (80M), 6.995-7.305 (40M), 9.995-10.155 (30M), 13.995-15.005 (20M), 18.063-18.173 (17M), 20.995-21.455 (15M), 27.995-29.705 (10M). Specifications apply within Amateur Radio bands Only.
<b>ACC Din Connector:</b>	8 PIN DIN Connector-Line in, Line out, Aux PTT, Ext Key, Clock, Data, Enable, Ground.
<b>DC Power Connector:</b>	AMP MATE-N-LOCK, 2 pin
<b>Fuse:</b>	Automotive Blade Style 7.5 A 32V
<b>Tuning Step Size:</b>	10, 100, 1000, speed sensitive, VFO Lock
<b>Frequency Stability:</b>	+/- 0.5 PPM over operating temperature
<b>Antenna Impedance:</b>	50 Ohm nominal.
<b>Antenna Connectors:</b>	1 x SO-239
<b>Modes:</b>	USB, LSB, CW, (AM optional)
<b>Memories:</b>	100
<b>Frequency Accuracy:</b>	±5Hz @25°C, 10 Hz tuning resolution
<b>Supply Voltage:</b>	9.5 – 14 Volts DC
<b>Operating Temp. Range:</b>	0-50 degrees Celsius
<b>Dimensions (HxWxD):</b>	2.25" x 6.5" x 7.6" (excluding knobs and connectors)
<b>Weight:</b>	3.6 lbs
<b>Construction:</b>	Molded plastic front panel, aluminum chassis and Textured painted steel covers
<b>PC Control Port:</b>	USB (using CCS USB to UART Driver)
<b>Display:</b>	Custom FSTN monochrome LCD
<b>Display Backlight:</b>	Variable Red, Blue, Green (internal settings)

All measurements are typical. Specifications are subject to change.

## **RECEIVER**

<b>SSB Sensitivity:</b>	Better than 0.7uV (0.5 Typ), 2.4KHz, 10 db SINAD, preamp off
<b>AM Sensitivity:</b>	Better than 4 uV, (2.0uV Typ) 30% Mod, 6Kh BW, 10 dB SINAD, preamp off
<b>Selectivity IF1:</b>	2.9kHz standard, 9.0018 MHz, 2 optional filter positions
<b>Selectivity IF2:</b>	30 KHz Lowpass filter
<b>Selectivity, DSP IF:</b>	100 built-in DSP filters from 100-6000Hz BW.
<b>Third Order Intercept Point (IP3):</b>	20dBm@20Khz tone separation/2.9 kHz roofing filter, 20dBm@ 2kHz separation/700Hz Roofing filter, S5 method, preamp off
<b>IMD3 Dynamic Range:</b>	Typical 98dB/20kHz, 98dB/2kHz,500 Hz BW,calculated 2/3(IP3-Noise Floor), preamp off
<b>Blocking Dynamic Range:</b>	138dB/20kHz, 140dB/2kHz, 600 Hz BW, RF Gain @ 12 o'clock, preamp off
<b>LO Phase Noise:</b>	124 dBc/Hz @ 20 kHz, 114dBc/Hz @ 2 kHz
<b>Noise Floor:</b>	Typical -138dBm/500Hz BW/Preamp on, -128dBm /500Hz BW preamp off
<b>IF Frequencies:</b>	1st:9.0018 MHz, 2nd:22.2 kHz, 3rd:0Hz (DSP)
<b>IF Rejection:</b>	Typical 74 dB
<b>1st IF Image Rejection:</b>	Typical 59 dB
<b>2nd IF Image Rejection:</b>	Typical 69 dB
<b>Other Spurious Response:</b>	Rejection: >80dB
<b>Birdies:</b>	Typically less than -100dBm equivalent (no more than 5 birdies greater than -100dBm equivalent)
<b>Pass Band Tuning:</b>	+/- 2.1kHz, 5Hz steps. Small dead zone for centering
<b>PreAmp:</b>	Nominal 12 db
<b>Audio Output:</b>	1.3 Watts into 8 ohm, <3% THD
<b>RIT range:</b>	+/- 8.2 kHz
<b>RIT Step size:</b>	10Hz
<b>S-Meter Reference:</b>	S9 = 50 uV RMS
<b>TX&gt;RX Recovery Time:</b>	< 20 ms
<b>RX Headphone Output:</b>	Designed for 16-32 ohms impedance headphones. Usable at 8 ohms
<b>AUX Audio Output:</b>	500 mv
<b>Auto Notch:</b>	IF DSP, multi-tone
<b>RX Noise Reduction:</b>	IF DSP, adjustable
<b>Noise Blanker:</b>	IF DSP, adjustable
<b>RX Current Drain:</b>	550 milliamps

All measurements are typical. Results will vary based on different Test Environment, Tools, and Test Methods. Specifications are subject to change.

## **TRANSMITTER**

<b>RF Power Output:</b>	Adjustable, 1-10 W, +/- 1 dB
<b>CW, SSB, AM, AFSK, PSK Duty Cycle:</b>	100% for up to 10 minutes @ 10 watts
<b>CW/SSB TX Bandwidth:</b>	2.9kHz Filter
<b>AM TX Bandwidth:</b>	6kHz Optional Filter
<b>Microphone Input Impedance:</b>	>10 k-ohms at 1 kHz
<b>Microphone Sensitivity:</b>	1 mV RMS for full power output, internal gain adjustment, 9v dc power for electret elements
<b>AUX Level Input:</b>	variable, 200mV nominal
<b>SSB Carrier Supression:</b>	> 60 dB
<b>Unwanted Sideband Suppression:</b>	> 60 dB at 1 kHz
<b>T/R Switching:</b>	PTT or VOX on SSB, AM. QSK on CW
<b>CW Keyer Type:</b>	Internal Curtis Mode A or B Selectable
<b>CW Rise and Fall Times:</b>	5ms
<b>CW Offset:</b>	adjustable
<b>CW Keyer Speed:</b>	5-50 WPM, adjustable weighting
<b>Current Drain:</b>	3 amps at 10 watts
<b>Third Order Intermod:</b>	Better than 30dB below peak
<b>SSB Generation:</b>	DSP Generated
<b># of DSP generated TX bandwidths:</b>	2 built-in DSP filters – automatically selected base on mode - 2.9 kHz for CW and SSB, (6 kHz for AM option) Note: the optional 6KHz filter is required for AM transmit.

## **OPTIONS**

**4 Pole Roofing Filters:** 700Hz, 6kHz.

All measurements are typical. Specifications are subject to change.

## 5.2. Transceiver Block Diagram

MODEL 539

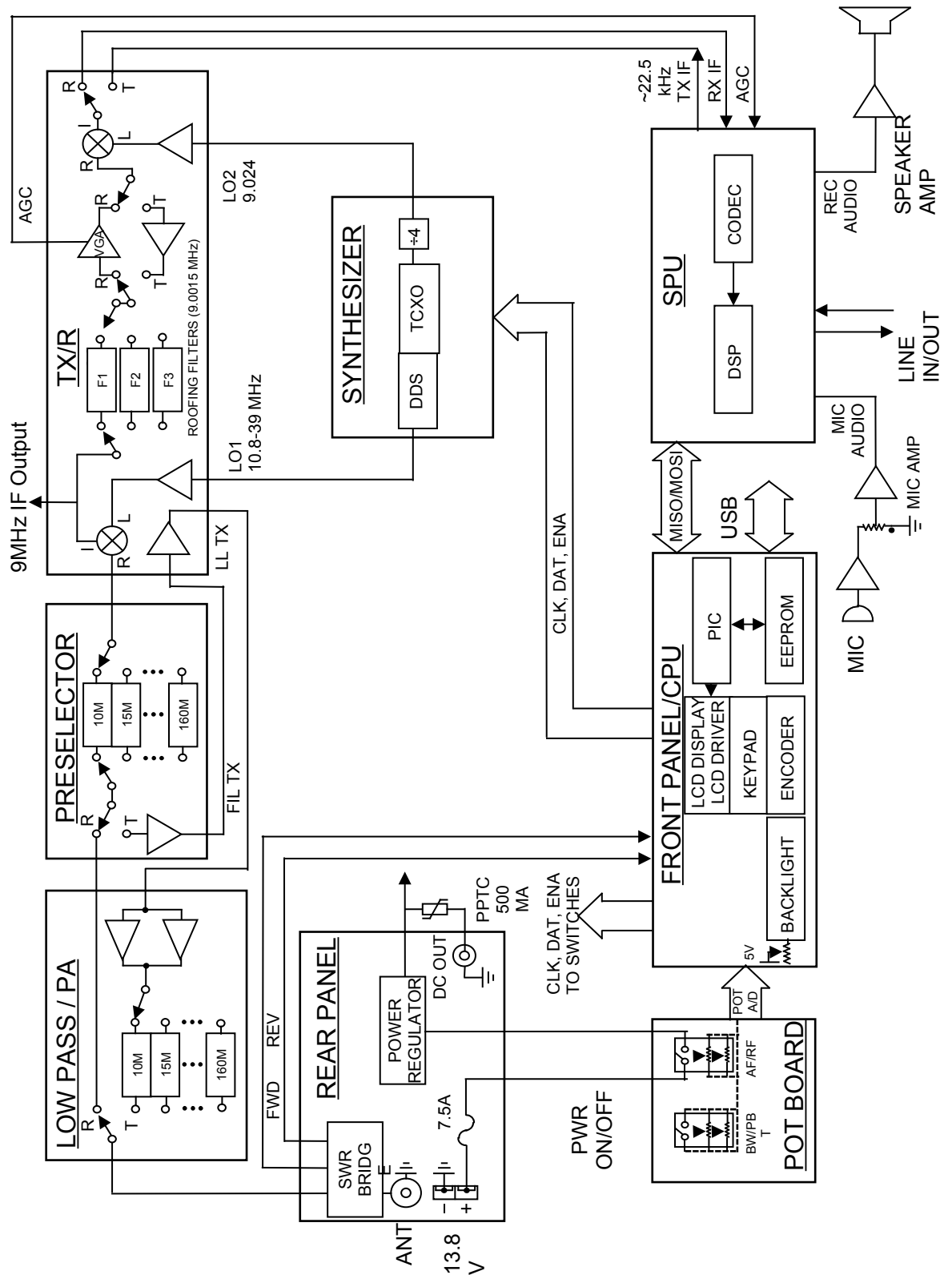

## FCC Compliance

Note: This equipment has been tested and found to comply with the limits for a Class B digital device, pursuant to part 15 of the FCC Rules. These limits are designed to provide reasonable protection against harmful interference in a residential installation. This equipment generates, uses and can radiate radio frequency energy and, if not installed and used in accordance with the instructions, may cause harmful interference to radio communications. However, there is no guarantee that interference will not occur in a particular installation. If this equipment does cause harmful interference to radio or television reception, which can be determined by turning the equipment off and on, the user is encouraged to try to correct the interference by one or more of the following measures:

- Reorient or relocate the receiving antenna.
- Increase the separation between the equipment and receiver.
- Connect the equipment into an outlet on a circuit different from that to which the receiver is connected.
- Consult Ten-Tec service for technical assistance (865) 428-0364

NOTE: THE GRANTEE IS NOT RESPONSIBLE FOR ANY CHANGES OR MODIFICATIONS NOT EXPRESSLY APPROVED BY THE PARTY RESPONSIBLE FOR COMPLIANCE. SUCH MODIFICATIONS COULD VOID THE USER'S AUTHORITY TO OPERATE THE EQUIPMENT.

## 6. In Case of Difficulty

While we cannot cover every possible problem, here are some hints for dealing with some potential difficulties. Check the obvious. Is your dc power source okay? Check power supply, cable and connector(s). Is the 25 ampere fuse loose or missing? Antenna problems? Try a dummy load. Is a proper antenna connected? Is any external antenna switch connected and properly set? Have you double-checked the Argonaut VI's many control settings, including those in the Configuration menu, for your intended mode of operation? Have you checked how the optional Filter's are installed and confirmed their installation order within the Configuration Menu?

One problem that results in no audio or poor audio is the fact that sometimes you make an adjustment to a setting and subsequently nothing seems to work properly anymore. The method that resolves setting issues that you just can't find, is to perform a Master Reset. This was discussed in the "**General Operations**" section of this manual.

### **Problem: No Receive Audio**

Is the AUDIO (AF) turned up?

Is RF GAIN turned down? Is squelch activated? SQL will appear in block letters on the screen. Press FNC then FAST/SQL and check SQUELCH level.

Is the speaker wire internal to the rig broken or disconnected? (Have you pulled the covers off recently?) Try headphones to see if audio returns.

Is NR off? Under some circumstances, noise reduction can cover band noise completely, leading the user to think no audio is coming from the speaker.

### **Problem: Distorted SSB transmit – or – Perceived RFI in the shack.**

Be certain the mic gain is set properly. The ALC LED should flash on voice peaks, but not remain continuously lit in SSB modes.

Check the setting of the speech processor. An excessively high setting can reduce audio quality.

A frequent cause of a distorted SSB signal is inadequate RF grounding resulting in RF feedback. Common RF grounding problems are no ground connection, or too long a lead to a good ground. Many problems relate to the lack of an RF station ground, as contrasted with a safety ground connection. We recommend bonding all equipment chassis together with short heavy metal braid or strap. Make these connections from chassis ground lug to chassis ground lug and connect the last piece in the chain feeding the antenna to a good earth ground. This lead needs to be as short as possible. Lengths near  $\frac{1}{4}$  wavelength on any band used can be particularly troublesome when the far end is connected to earth. It is very important that the external power supply and the transceiver and all equipment with grounding lugs are properly grounded.

Another potential cause of distorted SSB arises when the station is in the near field of the antenna. This is a problem many apartment dwellers face.

Distorted SSB transmit can result from chassis ground and signal ground from the microphone being tied together to a common connection. This is a common problem with third-party microphones. Assure the chassis ground and signal ground from the microphone is separated.

RF can also be induced into the transceiver on any unshielded wires.

**Problem: Transceiver power shuts off while transmitting**

The Argonaut VI is equipped with a silicon-controlled rectifier that opens if the PA current draw exceeds an instantaneous power of approximately 30 amps. This will shut off power to the transceiver. Excessive current draw can indicate a problem with excessive SWR due to antenna or feedline problems. Power to the radio can be restored by cycling the power switch and off or the 13.8 Vdc source on and off.

**Problem: No transmit, receive OK.**

Are you trying to transmit outside of the Ham Band?

Is the gain setting correct for the microphone input or ACC 1 jack as appropriate?

Is the POWER control turned all the way down? Press PWR and check.

If no transmit in digital modes, are you sure a PTT signal is being sent from your TNC or computer to the appropriate jack on the Argonaut VI?

Are the internal fans running at maximum? If so, then this could indicate the Argonaut VI has a final amplifier temperature of 70 degrees C or higher. In this condition, the radio will stop transmitting until the final amplifier temperature is back down to a reasonable level.

**Problem: Get a “PORT in use” when trying to run logging or computer control program or when trying to update the firmware.**

Have you confirmed the proper port number in Device Manager? Remember that when connecting the USB cable to the USB port on the computer, every time you connect the USB cable into a different USB port on the computer, it will have a different COM port number. You can verify this in Device

Manager. It is possible that the USB port was used previously and for some reason Windows has not released it for use. In this instance, disconnect the USB cable at either the computer end or the Argonaut VI end, exit the program you are trying to use, wait a few seconds, then reinstall the cable and then restart the program you were trying to use.

If the above do not solve your problem, please consult with our service department (865) 428-0364 or [service@tentec.com](mailto:service@tentec.com)



## 7. Warranty & Return Policy

Warranty policy for Ten-Tec products is covered in the gold color page located on the last page of this manual.

**FOR EQUIPMENT MANUFACTURED BY TEN-TEC:** Ten-Tec factory built radio equipment is sold under a 30-day risk-free trial period. Any piece of equipment manufactured by Ten-Tec may be returned, undamaged, within 30 days of purchase for a full purchase price refund, less shipping charges (customer pays shipping both ways).

If you want to return a piece of equipment purchased from Ten-Tec, please call the sales department at (865) 453-7172 from 8 a.m. to 5 p.m. Eastern time, Mon-Fri and obtain a return merchandise authorization number. Calling in advance for an RMA number allows us to quickly process your return and refund once your item arrives. Ship return items with letter enclosed inside the box noting the RMA number and your name, address, and telephone number. Return items are shipped to Ten-Tec., 1185 Dolly Parton Pkwy, Sevierville, TN 37862 USA.