

## TABLE OF CONTENTS

TABLE OF CONTENTS	1
<b>Section 1 – YOUR NEW OMNI-VII</b>	
UNPACKING OMNI-VII	4
ABOUT THIS MANUAL	4
CONNECTING A POWER SUPPLY	4
A WORD ABOUT GROUNDING	5
PHILOSOPHY OF DESIGN	5
RADIO STATE VS. REMOTE STATE	6
<b>Section 2 – OMNI-VII FRONT PANEL CONTROLS</b>	
(1) POWER	7
(2) PHONES	7
(3) KEY	7
(4) MULTI ENCODER	8
(5) PBT/BW ENCODER	8
(6) AF/RF ENCODER	8
(7) MIC	8
(8) TUNE	10
(9) PWR	10
(10) (11) V>M and M>V	10
(12) MODE	10
(13) STEP	11
(14) ANT	11
(15) SWP	11
(16) AGC	12
(17) BAND CHANGE AND DIRECT FREQUENCY ENTRY KEYPAD	12
(18) A=B, A>B, SPL, REV	12
(19) MAIN TUNING KNOB	12
(20) MNU	13
(21) TX, ALC, RX	13
(22) RIT, XIT, RIT/XIT ENCODER	13
(23) ALT	13
(24) NR/AN	14
(25) MIC/MON	14
(26) ATTN/PRE	14
(27) NCH/NB	14
(28) SPO/S-T	15
(29) SP/VOX	15
<b>Section 3 – OMNI-VII REAR PANEL</b>	
(30) SPKR	16
(31) ACC 1	16
(32) ACC 2	17
(33) REM POD	17
(34) SERIAL	17
(35) AMP KEY	17
(36) (37) TX EN / TX OUT	17
(38) (39) SPARE	18
(40) DC IN	18
(41) DC OUT	18
(42) FUSE 25A	18
(43) GROUND TERMINAL	18
(44) ETHERNET	18

(45) ANT 1	18
(46) ANT 2	18
(47) AUX RX	18

#### **Section 4 – USING THE MENU**

AUTO TUNER	20
TX METER	20
TRANSMITTER	20
SSB TX BW	20
TX ROLL OFF	20
KEYING LOOP	20
AUDIO SOURCE	20
LINE GAIN	21
EXT T/R DELY	21
FM TX CTCSS	21
RX EQUALIZER	21
TX EQUALIZER	21
RECALL SUB	21
SIDETONE FRQ	22
SIDETONE VOL	22
SPOT VOLUME	22
CW QSK DELAY	22
CW WEIGHTING	22
CW KEYER	22
CW RISE/FALL	23
AUTO SWEEP	23
SWEEP RANGE	23
VOX TRIP	23
ANTI-VOX	23
VOX HANG	23
FSK TX DATA	24
REMOTE F1, REMOTE F2, REMOTE F3	24
REMOTE ENC	24
POD ENC RATE	24
VFO ENC RATE	25
RIT ENC RATE	25
VFO SPDSHIFT	25
DISPLAY	25
SPEECH PROC	25
I-F FILTER	25
ENABLE 300 HZ, ENABLE 500 HZ	26

#### **Section 5 – OPERATION NOTES AND ACCESSORY CONNECTION EXAMPLES**

OPERATING THE AUTOMATIC ANTENNA TUNER	27
CONNECTING AN EXTERNAL LINEAR AMPLIFIER	27
TUNING UP AN EXTERNAL LINEAR AMPLIFIER	28
INSTALLATION OF OPTIONAL COLLINS™ MECHANICAL FILTERS	28
I-F FILTER AND DSP BANDWIDTH FILTER THEORY AND USE	29
FACTORS THAT AFFECT THE SOUND OF	
SSB TRANSMIT AUDIO AND THEIR ADJUSTMENT	30
FSK OPERATION	32
ON-SCREEN STATUS MESSAGING	32
ON-SCREEN S-METER	32
OPERATING SPLIT FREQUENCY	32
EXTERNAL CW INPUT PLUS CW KEYER OPERATION FROM PADDLES	33
DRAG ADJUSTMENT FOR THE MAIN TUNING KNOB	33

MASTER RESET	33
UPDATING OMNI-VII FIRMWARE	33
DIAGNOSTIC AND IP DATA ENTRY SCREEN	34
# SIGN ON THE SCREEN	34
TROUBLESHOOTING	35
<b>Section 6 – SPECIFICATIONS AND TECHNICAL DATA</b>	
GENERAL	37
RECEIVER	37
TRANSMITTER	38
BLOCK DIAGRAM	39
CE DECLARATION OF CONFORMITY	40

## Section 1 – YOUR NEW OMNI-VII

Our aim in designing and producing OMNI-VII was to meet the demands of increasingly intense competition in DXing and contesting, while adding many non-performance related features that the active ham can also appreciate. OMNI-VII offers superb reception and transmission of CW, SSB, digital modes, FM, and AM on all 10 HF amateur bands and 50 MHz.

### UNPACKING OMNI-VII

Examine OMNI-VII for signs of shipping damage. Should any damage be apparent, notify the delivering carrier immediately, stating the full extent of the damage.

Retain all damaged cartons. Liability for shipping damage rests with the carrier. We recommend that you keep the carton and fillers in the event that storage, moving, or shipment becomes necessary.

The hardware and accessories listed in Figure 1-1 come standard with your OMNI-VII. Make sure that you have not overlooked anything.

### ABOUT THIS MANUAL

The OMNI-VII is a firmware updateable transceiver. Features and functions on the transceiver can change as time passes when new firmware revisions are issued via Ten-Tec's [www.rfsquared.com](http://www.rfsquared.com) firmware download website. The latest version of the OMNI-VII manual is posted in .pdf format on the OMNI-VII section of the Ten-Tec website at [www.tentec.com](http://www.tentec.com). Schematic diagrams are not included in this manual but are available for download from the [www.rfsquared.com](http://www.rfsquared.com) firmware website.

This manual was written by  
Scott E. Robbins, W4PA.

Qty	Part #	Description
1	#27074	Mini-ATC Blade Fuse, 25 Amp.
1	#35003	Phono Plug
1	#35363	8-pin Microphone Connector
1	#35165	2-pin Power Connector Shell
2	#41020	Female Power Pins
1	#35017	Phone Plug, 3-circuit
1	#38040	.050 Hex Wrench
1	#38088	.062 Hex Wrench
1	#38313	T10 Torx Wrench
1	#46172	Serial Cable
1	#46176	Accessory Cable. 5-pin DIN to phono female
1	#74020	Warranty Card
1	#74409	User's Manual
1	#86095	DC Power Cord

Figure 1-1 OMNI-VII Packing Kit

### CONNECTING A POWER SUPPLY

The OMNI-VII transceiver requires a source of well-filtered and regulated DC voltage. The supply voltage can range from +12.8 to +15.0 Vdc but +13.8 Vdc is the optimum value. The voltage source must be capable of supplying minimum 23 amperes continuous duty.

We recommend using the included DC power cable (P/N 86095). We have also included spare connector pins (P/N 41020) and a spare 2 pin power connector shell (P/N 35165) for building your own cable. The power supply plug will attach in only one direction to the polarized two-pin DC connector on the OMNI-VII rear panel. Use no less than #14 gauge (#12 recommended) stranded wires for three-foot long connections to accommodate the required current demand during transmit. Use heavier gauge wire for longer power supply leads.

NOTE: always enable the power source first and then the transceiver. If a generator or alternator supplies the dc source, always

turn off the transceiver before starting or shutting off the dc source equipment. These recharging devices often generate large voltage spikes that can damage the transceiver.

## A WORD ABOUT GROUNDING

A good ground system is essential for optimum operation of any HF transmitter. The best solution is to connect all the station equipment chassis together using a heavy gauge of flat ground braid. Use a short length of braid to connect to a ground rod. If you are not using a linear amplifier, a less ideal ground may suffice. A ground connection to a copper cold water pipe was often suitable, but that is now a violation of the National Electrical Code. Be aware that many modern water connections use plastic pipe, and are not suitable ground connections.

Antenna type and its proximity to the station are also factors in choosing ground methods. With good resonant antennas located away from the station, the AC ground in your house wiring might be adequate.

## PHILOSOPHY OF DESIGN

Ten-Tec's goal with the OMNI-VII transceiver was to provide an HF transceiver that meets several disparate criteria. 1) Be easy for the average amateur to operate. 2) Have a feature set that experienced amateurs expect a top of the line piece of equipment to include. 3) Offer Amateur Radio's first completely Ethernet controllable HF rig, with an eye to remote operation becoming more and more popular as time passes. 4) Include general coverage HF receive capability plus 50 MHz.

The filtering system in the OMNI-VII uses what we refer to as "distributed" roofing filters. The definition of roofing filters varies; in Amateur Radio terms the term has come to mean a crystal or mechanical filter that allows for the preservation of available receiver performance for realistic on-the-air situations, as opposed to lab conditions when only two signals at a given spacing are present for test purposes.

General coverage HF transceivers today are of an upconverting, VHF level first I-F, followed by two or three more conversion stages. This VHF I-F first stage is somewhat problematic due to physics to create an adequate mode-appropriate roofing filter. At the same time, some amateurs are reluctant to use a ham bands-only HF transceiver that may have a low frequency first I-F and be generally more suited to high performance applications than a general coverage HF rig.

The question was how to combine a general coverage receiver with a mode-appropriate system of filtering appropriate for high-end Amateur Radio receiver performance.

We refer to the roofing filters in the OMNI-VII as "distributed" because filters are spread across both the first and second I-F stages.

The conversion stages in the OMNI-VII are 70 MHz first I-F, 455 kHz second I-F, 14 kHz (DSP) third I-F. A monolithic filter at 20 kHz bandwidth is present at the first I-F stage between the first and second mixers. Selectable second I-F filters at bandwidths of 20, 6, 2.5 kHz, 500 Hz (optional) and 300 Hz (optional) can be cascaded with the first I-F monolithic filter at 20 kHz bandwidth. Bandwidth filtering is done in DSP at the third I-F and is controlled by the BW encoder on the transceiver front panel.

The net effect of using 455 kHz second I-F filters is to increase blocking dynamic range over what the receiver would be capable of without the second I-F filters installed. Third order intercept point essentially remains constant. The front-end AGC in the transceiver is after the 455 kHz I-F filters; having them installed prevents the radio from attempting AGC action on a signal that is outside the bandwidth of the 455 kHz I-F filter.

SSB operators will not require additional filters; additional filters can be installed optionally by CW or digital mode operators.

50 MHz transceive operation at 100 watts output power is included in the OMNI-VII. Additional receive capability to 48 MHz has been provided for monitoring of VHF European TV coverage and other signals of

interest that may indicate to the serious 6 meter operator when a band opening is underway. Repeater operation via the SPLIT capability is provided for, as are CTCSS tones and retaining both of these in the transceiver memories.

The remote control capability of the OMNI-VII is unprecedented in Amateur Radio. While remote operation of HF equipment has been done via the Internet or data links for several years prior, OMNI-VII is the first transceiver that allows direct connection to a high-speed router via Ethernet without a computer for remote operation.

Additionally, we have made available a graphical user interface for controlling the radio remotely, the source code for the GUI, and programming instructions for the transceiver available on our firmware update site [www.rfsquared.com](http://www.rfsquared.com)

## **RADIO STATE VS. REMOTE STATE**

OMNI-VII operationally at first glance is not much different from other HF transceivers. However, within this product lies the ability to remotely operate it from virtually any high-speed Internet access point.

RADIO STATE is what we describe as the “traditional” operation of the OMNI-VII. Turning knobs, pushing buttons just as with any other Amateur Radio transceiver. How the screen looks and the radio operates in RADIO STATE is described in detail in sections 2 through 5 of this manual.

RADIO STATE is also used for “local” control of the OMNI-VII with a PC. Local control is connecting the radio directly to a computer via the serial (RS-232) port on the rear panel. The transceiver then can be controlled by the user from the local PC, from the front panel controls, or both.

REMOTE STATE is when the transceiver is placed into service as a remote device. REMOTE STATE disables transceiver functions from local control and disables some (like VOX operation and the internal CW keyer) altogether. REMOTE STATE also alters the layout of the radio screen to

give you a much more utilitarian user interface.

The One Plug GUI software to control the radio in REMOTE STATE is available for free download from our firmware update website [www.rfsquared.com](http://www.rfsquared.com). Instructions for the firmware and controlling the radio in REMOTE STATE are also provided there.

The default is RADIO STATE. To toggle to REMOTE STATE, turn the transceiver off. Press and hold the 2 button on the band change keypad. Turn power on, continuing to hold the 2 button down. After a few seconds, the REMOTE STATE version of the screen will appear and you can release the button. For the curious: go ahead and have a look. You don't have to have the radio connected to anything or plan to use it in remote mode to put the radio into REMOTE STATE.

To return to RADIO STATE, turn power off, press and hold the 1 button on the band change keypad. Turn power on, continuing to hold the 1 button down. After a few seconds, the RADIO STATE version of the screen will appear and you can release the button.

When powered off in either RADIO STATE or REMOTE STATE, the radio will retain the same STATE setting until changed from the front panel by the user. In case of power failure in REMOTE STATE remote operation, the transceiver will always come back up in REMOTE STATE when power is restored.

MODEL 588 FRONT PANEL

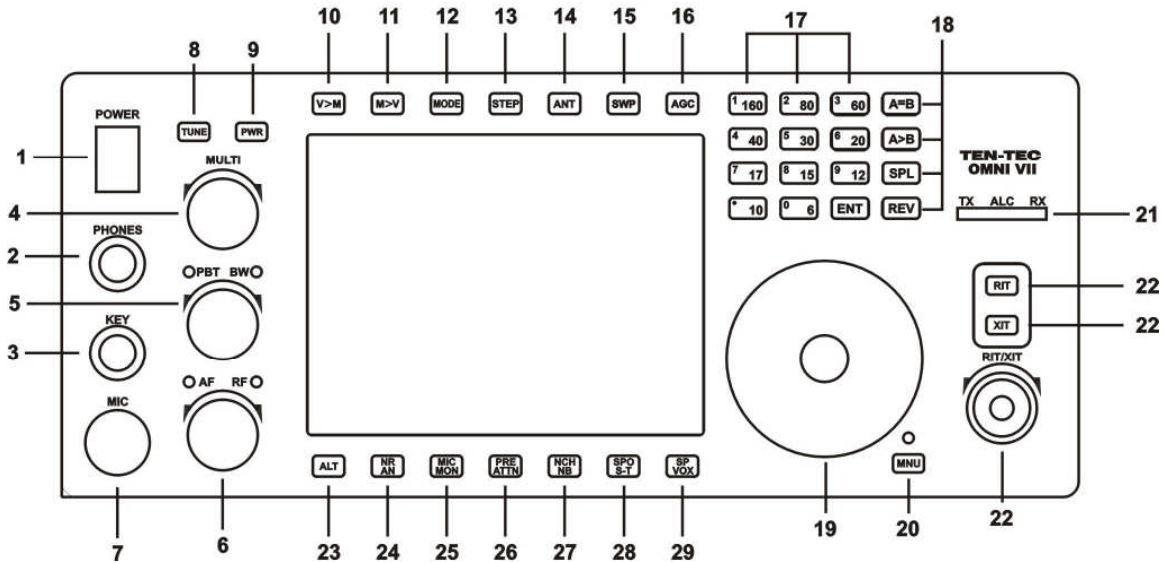

**Section 2 – OMNI-VII FRONT PANEL CONTROLS**

Section 2 of the OMNI-VII manual covers the various controls and connectors on the front and rear panels, with an explanation of each control and how it is used for operation of the radio.

**(1) POWER**

This switch turns the transceiver power on and off.

**(2) PHONES**

This jack uses a ¼" receptacle for plugging headphones into OMNI-VII. Either stereo or mono headphones may be used, nominal impedance 16 ohms, though 'phones using an impedance of 8 to 16 ohms load will be useable with the transceiver. Headphones above 16 ohms (like 32) can be used without damage to the transceiver but audio output to the headphones may be reduced.

When headphones are plugged in, a small headphone icon will appear near the top left of the radio screen.

**(3) KEY**

The front panel provides a ¼" stereo jack for connection of a key, external keyer, or paddles. See Figure 2-1 for proper wiring. OMNI-VII on initial power-up has the internal keyer disabled. To use the internal keyer in a CW mode, press the SP button ('SPeed') and then rotate the MULTI knob for an appropriate CW speed (Note: In SSB modes, SP is used for speech processing and displays a different value).

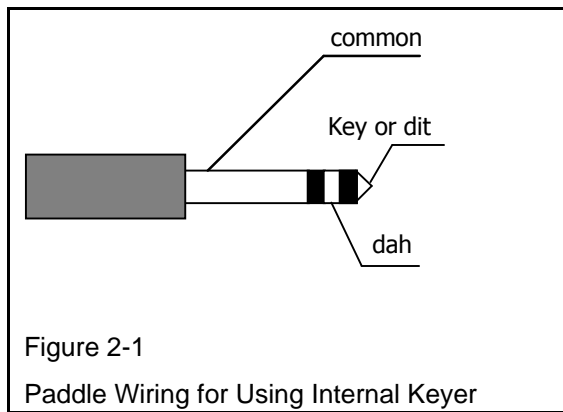

Figure 2-1  
Paddle Wiring for Using Internal Keyer

Pin 3 on the ACC 1 connector on the rear panel also allows you to connect an independent keyer or computer to share CW keying.

This would be useful if using the output of a computer program for transmitting CW (like contest logging software) while also desiring a paddle to be connected to the radio for using the internal keyer. Connect the CW keying output of the computer logging program to PTT pin (3) on the ACC 1 jack, and then connect your paddle to the front panel KEY jack. See the description of **(31) ACC 1** in Section 3 of this manual.

#### **(4) MULTI ENCODER**

The front panel MULTI knob is used for adjusting a variety of transceiver functions.

Pushing various buttons on the circumference of the screen enables functions that are then value-adjusted by the MULTI knob. Display letters in green on the transceiver screen indicate the item being adjusted. Example: pressing the PWR button to adjust power changes the green display to read POWER 20W – turning the MULTI knob adjusts power level up or down. Example 2: pressing the NR button changes the green display to read SET NR. The NR value is shown just above the NR button.

Several items that are found inside the transceiver menu are adjusted using the MULTI knob. These items can be accessed by pressing the MULTI encoder towards the front panel of the transceiver. The OMNI-VII will cycle through various menu items allowing them to be adjusted without accessing the menu itself. Note not all menu items are accessible via this method, and that the all-mode squelch control is ONLY available via this control method.

#### **(5) PBT/BW ENCODER**

Receiver bandwidth (BW) and passband tuning (PBT) are adjustable using this encoder.

To adjust BW or PBT value: A green LED indicator is next to the BW and PBT legends on the front of the radio above the encoder. Press the encoder to switch between BW and PBT.

The BW control is used to set the value of the DSP bandwidth filters. A value for each filter is shown on the screen next to the encoder itself. BW 2800 indicates a DSP bandwidth value of 2800 Hz. There are 38 selectable DSP filters from a minimum of 200 Hz to 12 kHz maximum. Filtering is selectable independent of mode.

The BW control can also be used to automatically engage or disengage the 455 kHz I-F filters. See **I-F FILTER** in Section 4 of the manual.

If manual selection of I-F filters is done, please note that the DSP BW filters are locked out at bandwidths above that of the manually selected I-F filter. Example: If the 2.5 kHz I-F filter has been selected manually in the menu system, the DSP BW maximum value will be 2500 Hz. All filters from 2500 Hz and down will be available. See **I-F FILTER** in Section 4 of the manual.

PBT is adjustable + or – 2.5 kHz from center. PBT can easily be cleared to zero. When the PBT LED is lit next to the encoder, press the encoder in and hold for two seconds. The PBT value will revert to zero.

#### **(6) AF/RF ENCODER**

AF GAIN (AUDIO) and RF GAIN are adjustable using this encoder.

Press the encoder to toggle between the two items. Turn the knob clockwise to increase, counter-clockwise to decrease.

Values for AUDIO and RF GAIN are shown in blue on the screen next to the encoder. Limiting receiver sensitivity with the RF GAIN control is also reflected on the s-meter.

For true manual control of receiver gain, turn AGC to OFF and use the RF GAIN control to limit receiver response.

#### **(7) MIC**

Front panel jack used for connection of a microphone. The OMNI-VII features the common 8 pin microphone jack used by many amateur radio transceivers. Most dynamic or electret microphones can be used. When adapting a microphone, please refer to the wiring diagrams in Figures 2-2 and 2-3.



We include a spare 8-pin microphone connector (P/N 35363) with the packing kit to allow rewiring of your current mic for use with OMNI-VII. The pinout for the 8 pin mic connector on the front of the OMNI-VII is shown in Figure 2-2. Recommended wiring is shown in Figure 2-3.

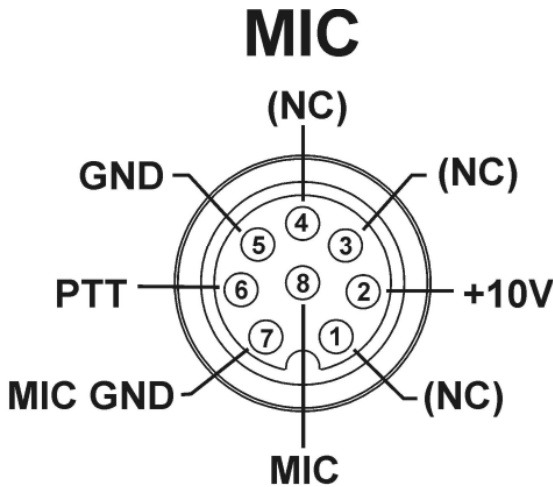
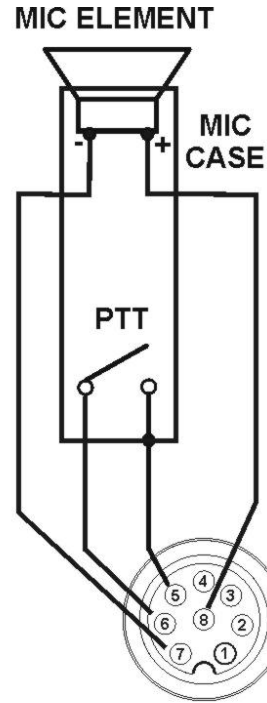

Figure 2-2. Front view, mic connector, on front panel of OMNI-VII



TRANSCEIVER MICROPHONE JACK  
FRONT VIEW

Figure 2-3. Recommended mic cable wiring.

Pin 2 (+9 Vdc) need only be connected if the microphone element in use is an electret condenser requiring a polarizing voltage.

Chassis ground and mic signal ground are separated to reduce the possibility of introducing stray hum or RFI into the transmit audio signal.

We recommend that the case of the microphone also be tied to chassis ground on the transceiver via a shielded cable to pin 5. This is to help assure stray RF does not have a path to be coupled into transmit audio. Cable carrying mic signal and mic signal ground should be shielded. This prevents the cable itself from acting as an antenna and coupling RF back into mic audio.

Some aftermarket microphones are not wired with separate microphone signal grounds and chassis ground. We recommend separate pins for use for mic

negative signal and chassis ground as shown in Figure 2-3.

## (8) TUNE

The TUNE button, when pressed, will transmit a CW carrier at approximately 20 watts output power to allow either the internal automatic antenna tuner to tune (if installed) or for user adjustment of an external antenna tuner or linear amplifier.

It may be desirable to have keydown CW carrier output at the power output level set by using the PWR control (button **9**). To do so, press the PWR button immediately after pushing the TUNE button. Power output will move from the low power setting to whatever level the PWR control has been set at with the MULTI knob. Repeat operation will require pushing TUNE then PWR again for the higher output value.

## (9) PWR

This button is used for setting RF power output on OMNI-VII. Press the PWR button and turn the MULTI knob to adjust value from 5 to 100.

The PWR button also interacts with the TUNE button (**8**) for key down power output for tuning an antenna tuner or linear amplifier. See the description of **TUNE** immediately preceding this section.

## (10) V>M and (11) M>V

The V>M and M>V buttons are used to store and retrieve frequencies into and out of the memory system.

To store a frequency from VFO A to a memory location, press V>M. At the top of the screen SAVE TO MEMORY and a memory number will appear. Turn the MULTI knob to scroll through the available memory locations. There are 100 available memories. When your desired memory number has been selected, press V>M again to save.

Memories will save both VFO frequencies, mode, DSP BW setting, whether split is turned on, whether preamp is on or off, and FM CTCSS tone in use.

If you want to exit the memory save function above WITHOUT saving the memory to a location, instead of pressing V>M the second time to save the memory, press M>V while the screen still reads SAVE TO MEMORY at the top to exit.

To recall memories, press M>V. After pressing M>V, RECALL MEMORY and a memory location number will appear at the top of the screen. Turn the MULTI knob to scroll through the memories. To select a memory to be imported to the VFO, press M>V again.

If you want to exit the memory recall function above WITHOUT recalling a memory location to VFO A, instead of pressing M>V the second time to recall the memory, press V>M while the screen still reads SAVE TO MEMORY at the top to exit.

Note that the M>V function for memory information recall is also dependent on what the function RECALL SUB in the menu is set to. Pushing M>V by default only recalls the VFO A frequency, mode, preamp, and DSP BW filter in use. To recall all information stored (both VFO's, mode, DSP BW filter, split, FM CTCSS tone), RECALL SUB must be set to ON. See **RECALL SUB** in Section 4.

## (12) MODE

Mode selection for VFO A on the transceiver is done by pushing MODE. At the top of the screen below the row of 7 buttons the available modes will appear: USB, LSB, UCW, LCW, AM, FM, FSK. Use the top row of buttons above the main screen to select the desired mode. After making selection, the selected mode for VFO A is shown on the screen directly below the MODE button.

If the MODE button is pushed and you do not want to change modes, wait 5 seconds. The mode indicators at the top of the screen will disappear and the OMNI-VII will return to usual operation.

VFO B can be on a separate mode from VFO A. Modes can be transferred from VFO A to VFO B by using the A=B or A/B buttons to exchange VFO information. See **(18) A=B, A>B, SPL, REV.**

## (13) STEP

The tuning step size is adjustable in seven different steps, 1, 10, 100 Hz and 1, 5, 10, and 100 kHz.

At the top of the screen below the row of 7 buttons the available step sizes will appear: 1, 10, 100, 1k, 5k, 10k, 100k. Use the top row of buttons above the main screen to select the desired step size.

If the STEP button is pushed and you do not want to change step size, wait 5 seconds. The step indicators at the top of the screen will disappear and the OMNI-VII will return to usual operation.

You can quickly jump back and forth between the next highest step size by pressing and holding the STEP button down for two seconds. "x10" will appear on the screen just below the step size. Example: with 10 Hz step size selected, press and hold the STEP button. "x10" appears on the screen, and the radio now tunes in 100 Hz steps (the next available step size) . To revert to 10 Hz steps, press and hold the STEP button again and "x10" will disappear.

When the rig is powered off, the "x10" setting will not be retained.

## (14) ANT

OMNI-VII is equipped with three SO-239 antenna connectors on the rear panel. Two are for transceiver operation (labeled ANT 1 and ANT 2), the third (labeled AUX RX) is for connection of a receive-only antenna.

Pressing ANT toggles between ANT 1 and ANT 2. To access the receiver-only antenna, press and hold the ANT button for 2 seconds. The legend RXAUX will appear on the screen below and to the right of the button. When selected, transceiver operation is receiving via the AUX RX antenna and transmitting via ANT 1 or ANT 2 depending on which is selected.

When AUX RX is in use on receive, switching back and forth between ANT 1 and ANT 2 for transmit requires the AUX RX antenna be turned off, then the transmit

antenna selected, then the AUX RX antenna re-selected.

Antenna selections, including the use of the AUX RX antenna, are retained and recalled when changing bands.

The optional internal automatic antenna tuner, if installed, is operable on either of the ANT 1 and ANT 2 connectors.

## (15) SWP

This button enables the momentary SWEEP feature included on OMNI-VII.

Press the SWP button. The transceiver will momentarily sweep a given range of frequencies determined by the value set on the SWEEP RANGE line item in the menu. See SWEEP RANGE in Section 4 of the manual.

The center frequency of the sweep is whatever frequency the transceiver is set to on VFO A when the SWP button is pushed. A red cursor will appear on the center of the display. Turn the main tuning knob to tune to signals seen on the scope.

A series of green vertical lines will be present with an indication of the frequency range between them. Example: When SWEEP RANGE is set to 150 kHz, each division is + or - 15 kHz, for a total of 75 kHz of swept spectrum on each side of the starting frequency. If the starting frequency is 28.500 MHz with a sweep range of 150 kHz, each of the first green markers will be at 28.485 MHz and 28.515 MHz. The total sweep from end to end is 28.425 MHz to 28.575 MHz, a total of 150 kHz.

The divisions will also be noted by -15k and +15k above each of the first green vertical lines in this example.

The horizontal red line across the middle of the sweep display indicates a signal of approximately S9 signal strength.

Press SWP again to clear the sweep display.

## (16) AGC

Automatic gain control (AGC) is used to provide a uniform output at the audio level of varying signal strengths that appear at the input of the receiver I-F chain.

Generally, SLOW and MED are used for voice modes, and MED or FAST for CW mode. Advanced users may want to disable AGC altogether by selecting OFF and control the receiver gain manually using the RF GAIN control – see **(6) AF/RF ENCODER** as described elsewhere in this manual.

To select AGC setting, press the AGC button to cycle through the available choices. OMNI-VII has four selectable AGC settings: OFF, SLOW, MED, and FAST.

## (17) BAND CHANGE AND DIRECT FREQUENCY ENTRY KEYPAD

The 11 available amateur radio bands useable by OMNI-VII are delineated in white print on the band change keypad buttons. To select one of the 10 HF amateur bands or the 50 MHz band, press the appropriate band button.

The last mode and setting of DSP BW are recalled for that band when moving from band to band. The last bandstacking register in use on that band will also be in use.

OMNI-VII is equipped with four bandstacking registers. Bandstacking registers allow various combinations of mode and filter bandwidth on the same amateur band to be “stored”. To access the registers, press the appropriate band change button for a *band already in use*. When using 28 MHz, for example, press the 28 MHz button again. The four bandstacking registers are labeled on the screen as A B C D just to the lower left of the band change keypad.

Direct frequency entry is possible for the main VFO using the keypad. To direct enter a frequency, press ENT. The main display will change to a series of green dashed lines. Enter the frequency using the numbers and decimal point. If entering a

frequency followed by a series of zeros, the zeros can be automatically entered by pressing ENT again to finish the entry. Example: To move to 14.200.000, press ENT, 1, 4, 2, ENT and the frequency display will fill out to 14.200.000 automatically.

## (18) A=B, A>B, SPL, REV

These four buttons control VFO A and B functions on the transceiver.

The large main frequency display on the screen is always VFO A – the smaller frequency display below it is VFO B.

A=B takes the frequency and mode information from VFO A and transfers it to VFO B. The mode display for VFO B is shown immediately to the right of the smaller frequency display.

A/B flips the frequencies and modes between the two VFO's.

SPL is used for split frequency operation. Press SPL and the VFO B frequency display turns to red and the Tx indicator on the screen moves next to it. In SPLIT mode, receiving is always on VFO A and transmitting is always VFO B.

When in split mode, the REV button allows monitoring and/or tuning of VFO B while the button is held down. Press and hold to monitor VFO B. The main tuning knob can also be turned while holding down the REV button to adjust frequency.

Notes: The REV function can be used even when OMNI-VII is not in split mode if momentarily monitoring the VFO B frequency is desired. When REV is in use, the A=B and A/B buttons are disabled.

## (19) MAIN TUNING KNOB

The large tuning knob is for adjusting frequency when the transceiver is in normal use.

When the transceiver menu system is enabled, the main tuning knob is used to scroll up and down through the various line items. See also **(20) MNU**.

The main tuning knob is also equipped with a variable rate function. Unlike tuning STEP as set via the STEP button, the rate control is used to determine how many steps per revolution the main tuning knob makes.

The FAST rate is slightly less than 2x the SLOW rate. See **VFO ENC RATE** in Section 4.

The main tuning knob has an adjustable drag feature. See **DRAG ADJUSTMENT FOR THE MAIN TUNING KNOB** in Section 5 of this manual.

## (20) MNU

The MNU button is used for two functions. A momentary push of the MNU button enters or exits the transceiver menu system. The function of all menu items can be found in Section 4 of this manual.

The MNU button can also be used to lock the main frequency tuning knob. Press and hold for 2 seconds. The red LED above the MNU button will light, indicating the tuning knob lock is in use. To disable, press and hold MNU for 2 seconds. The LED will go dark and the main tuning knob will be again in use.

While the lock function is in use, the menus can still be accessed by momentarily pushing the MNU button.

To exit the menu, press MNU.

Tip: the menu system can also be exited by pressing the MULTI encoder or any other transceiver button.

## (21) TX, ALC, RX

These are indicator LED's.

In receive mode, the green RX LED will be lit. When transmitting, the TX and/or ALC LED's will light. In AM and FM modes, the TX and ALC lights will be lit constantly while transmitting.

In CW modes, the TX and ALC LED's will blink on and off with each character transmitted.

In LSB and USB modes, the TX LED will be lit as long as the radio is in transmit. The ALC light is used to adjust proper mic gain. See **(25) MIC/MON**.

## (22) RIT, XIT, RIT/XIT ENCODER

The knob located directly below the RIT and XIT buttons at far right is used for adjustment of RIT or XIT value.

To turn RIT and/or XIT on, press the appropriate button. When RIT is pressed, RIT+0000 will appear on the screen. When XIT is added by pressing XIT, the display will change to read RIT/XIT+0000.

When turned on, RIT can quickly be cleared to zero by pressing the RIT button. Same applies to the XIT button. If both are in use simultaneously, pushing either button will clear to zero.

RIT and/or XIT value will be retained and brought back up if other than zero when they are turned off.

To exit RIT and/or XIT, press and hold the appropriate button for two seconds.

## (23) ALT

Buttons 24 through 29 are dual function buttons. The functions indicated in white lettering are primary functions (meaning when the button is pushed, that function is active). The functions indicated in yellow lettering are alternate functions and are accessed by first pressing the ALT button.

Press ALT. The horizontal lines that separate the transceiver functions shown at the bottom of the screen will move downward and turn yellow and ALT will appear on the screen at lower left.

There is a window of 5 seconds for a button to be pushed, selecting an ALT function after the ALT button is pushed. If no function is selected, ALT disappears from the screen and the radio returns to regular operation.

## (24) NR/AN

The primary function of this button is NR (noise reduction). Press NR. SET NR will appear in green letters on the screen next to the MULTI knob. Use the MULTI knob to adjust value. The NR value is shown on the screen just above the button.

There are 9 different settings, and each of the 9 are used to determine how aggressively (quickly) the NR adapts and identifies what is signal and what is noise.

Once the noise reduction value has been set for a given signal, no further adjustment of the noise reduction control is needed. Turning the NR to a higher value adjusts only how fast it adapts to a given signal vs. noise situation.

The alternate function is AN (automatic notch). Press ALT then AN. SET AN will appear in green letters on the screen next to the MULTI knob. Use the MULTI knob to adjust value. The AN value is shown on the screen just above the button.

The automatic notch filter is used for notching out carriers in USB and LSB modes. Multiple carriers will be notched by the automatic filter. Higher values indicate more aggressive action by the autonotch for suppressing undesired carriers

The AN function is locked out and not selectable in CW modes.

## (25) MIC/MON

The primary function of this button is MIC (microphone gain). Press MIC. MIC GN and the set percentage value will appear in green letters on the screen next to the MULTI knob. Turn the MULTI knob to adjust the value.

In LSB, USB, and AM modes, mic gain on the OMNI-VII is set properly by turning the MULTI knob while speaking into the microphone. The red ALC LED will flash. When the light is flashing consistently on voice peaks the proper mic gain level has been set. There is some variability here

depending on the microphone used and how loud you are speaking into the microphone.

The ALC light used to adjust mic gain in SSB modes is lit constantly while transmitting FM.

The alternate function of this button is MON, allowing monitoring of transmitted audio.

Press ALT then MON. Adjust the MULTI knob to set value of monitor audio.

OMNI-VII is also equipped with a hardware mic gain control, accessible under the bottom panel. It is described in **FACTORS THAT AFFECT THE SOUND OF SSB TRANSMIT AUDIO AND THEIR ADJUSTMENT** in Section 5. We recommend you read and understand this section before experimenting with the hardware mic gain control.

## (26) ATTN/PRE

OMNI-VII is equipped with both a step attenuator and on/off preamp.

The primary function of this button is to engage the step attenuator on receive. Press ATTN. The attenuator cycles among 6 dB, 12 dB and 18 dB of receive attenuation and then reverts to OFF.

The alternate function is a 12 dB boost on/off preamp. Both noise and signal levels are brought up 12 dB when the preamp is activated. Press ALT then PRE. When on, the preamp designator PRE will be reverse highlighted in green. Preamp settings are retained in transceiver memories and will also be recalled per band when changing bands.

## (27) NCH/NB

The primary function of this button is to activate a manual notch filter. The notch filter is in the receiver chain post-AGC and post-DSP filtering.

After pushing NCH, NCH FRQ plus the notch frequency in Hz will be shown in green lettering next to the MULTI knob on the

screen. Notch freq is adjustable in 40 Hz steps from 20 – 4000 Hz.

Notch width is adjustable – while NCH FRQ is shown on the display, press the MULTI encoder or the NCH button again. The display will read NCH WID and the current width value. The width is adjustable 10 – 300 Hz in 10 Hz steps.

As notch is post-AGC, signal strength of notched signals will still be shown on the S-meter.

The alternate function of this button is NB – noise blanker. OMNI-VII is equipped with a DSP noise blanker with seven selectable stages of aggressiveness. Press ALT then NB and turn the MULTI knob to set level.

## (28) SPO/S-T

OMNI-VII is equipped with adjustable CW sidetone and autotracking CW offset.

Pressing and holding the SPOT button will produce a tone at the value set by the operator (default is 700 Hz). This tone can be matched to the received tone of an on-air CW signal to achieve zero beat. Press and hold the SPOT button while tuning in a CW signal. When the tone of the received signal and SPOT match, you are on the proper frequency.

To adjust the SPOT frequency, press SPOT and then turn the MULTI knob. S-T FRQ and the value or SPOTVOL and its value will appear on the screen. Turn the MULTI knob to adjust. This can be done while holding the SPOT button down to hear the tone or the spot volume as it tracks.

The alternate function of this button is sidetone volume (S-T). Press ALT then S-T. Turn the MULTI knob to adjust sidetone volume. Sidetone volume is adjusted independent of the spot volume described above.

This feature is also adjustable via the menu system.

## (29) SP/VOX

The primary function of this button (SP) is determined by which mode is selected on the transceiver.

In CW modes, the SP button is used to turn the CW keyer on and off. Press SP. The display above the SP button will change from OFF to either A or B depending on whether the keyer has been configured for Curtis mode A or B via the menu system. See CW KEYER in Section 4. Curtis mode A and B cannot be toggled without going into the menu – SP will only turn the keyer on in the selected mode or off.

After pressing SP, the green description line on the screen next to the MULTI knob will change to read KEY SPD WPM with the keyer speed value. Turn the MULTI knob to adjust the keyer speed.

The alternate function of the button is to enable VOX (voice activated transmit) in all other modes. Press ALT then VOX. The VOX annunciator on the screen will highlight. Speak into the microphone to transmit. Note: there are menu settings which affect the ability or inability for VOX to operate with desired action. VOX trip, Anti-VOX, and VOX hang are all adjustable via the menu system. See **VOX TRIP, ANTI-VOX, and VOX HANG** in Section 4.

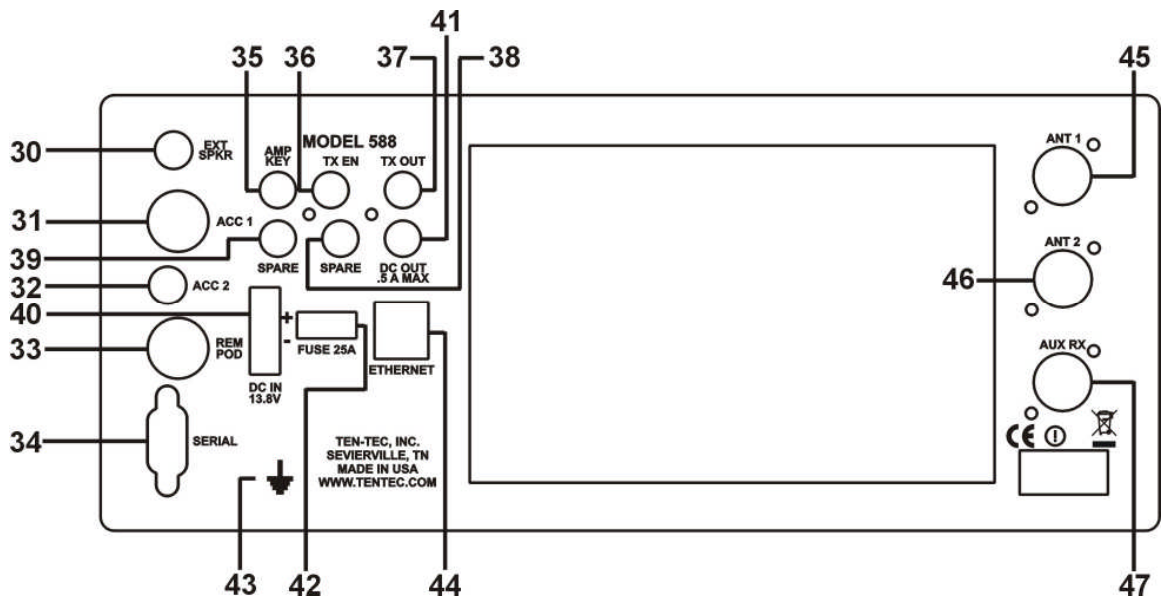

### Section 3 – OMNI-VII REAR PANEL

#### (31) ACC 1

#### (30) SPKR

This jack is for connection of an external speaker. When connected using a standard 1/4" phone plug, the internal speaker in OMNI-VII is disabled. Tip of the 1/4" phone plug is audio, sleeve is ground. Requirements for an external speaker connected to OMNI-VII is minimum 4 watts power handling, 4 ohms minimum impedance.

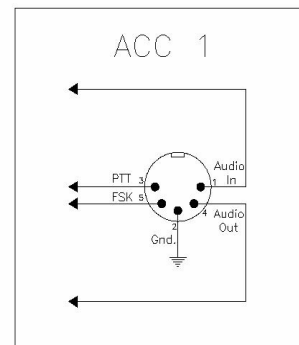

Figure 3-1 ACC 1 jack pin-out diagram

The ACC 1 jack is an 5-pin DIN receptacle used for interfacing accessory device requiring audio in/out connections, FSK connections and/or an auxiliary PTT input.

A 5-pin DIN accessory cable, (p/n 46176) has been provided as part of the OMNI-VII packing kit for easier connection of the ACC



1 jack to accessory equipment. The cable is color-coded as follows: WHITE = pin 1, line level audio input. YELLOW = pin 4, line level audio output. RED = pin 5, FSK. BLACK = pin 3, push to talk. Ground from the 46176 cable is connected to pin 2.

Pin 1 is used for a line level audio input from an accessory device (like a TNC or sound card for digital mode operation).

Pin 2 is ground.

Pin 3 is a PTT connection. In SSB and AM modes, when grounded, the radio begins transmitting. This would be the place to connect a PTT footswitch for voice modes. In CW mode, this pin can also be used as a keying input for an external device like an external keyer or output of CW sent from a computer (like with a computer logging program for radio contesting).

Pin 4 is line level audio output.

Pin 5 is the FSK mark/space input. 5 volts = 1 = mark, 0 volts = 0 = space. See **FSK OPERATION** section in Chapter 4.

### **(32) ACC 2**

No connection. For future use.

### **(33) REM POD**

The REM POD jack is used for connection of the model 302R accessory remote encoder/keypad, allowing armchair tuning and control of transceiver functions. See **REMOTE F1**, **REMOTE F2**, and **REMOTE F3** in Section 4 for information on control functions.

### **(34) SERIAL**

The serial data connector is used for both loading Flash-ROM updates into the transceiver and for local computer control of radio. One of the great features about OMNI-VII is that the latest version of the radio is always available from our firmware update website.

Complete computer control of the OMNI-VII is possible via the SERIAL connector.

A programmers reference guide and the latest version of the radio firmware are located on Ten-Tec's firmware update site at [www.rfsquared.com](http://www.rfsquared.com)

Brief instructions on firmware updating your transceiver are provided in **UPDATING OMNI-VII FIRMWARE** in Section 5.

### **(35) AMP KEY**

OMNI-VII is equipped with an open-collector transistor amplifier keying output, accessible via the AMP KEY jack.

AMP KEY is typically used as a non-QSK keying connection for a linear amplifier. However, it is acceptable to connect QSK linear amplifiers that do not employ a full break-in keying loop to this jack as well.

RF appears at an antenna connector approximately 15 mS after AMP KEY closes.

Amplifier keying is independent of antenna selection, meaning that an amplifier interfaced to AMP KEY can be routed via either the ANT 1 or ANT 2 jack.

An adjustable delay (titled EXT T/R DELY in the menu) gives the operator the ability to keep the amplifier keyed longer, preventing drop outs between words of SSB VOX or CW operation. See **EXT T/R DELY** in section 5.

Your external amplifier key line should not employ an AC relay for transmit switching, nor apply more than +100 Vdc (output inactive) nor should it draw more than 250 mA (output active). Many older linear amplifiers like those manufactured by Collins, Drake, and Heathkit have high voltage on the keying line. Such amplifiers require a relay or transistor switch between the OMNI-VII's AMP KEY jack and the amplifier keying line. If you are unsure if your amplifier is suitable, please consult the operator's manual for your amplifier or contact the Ten-Tec service department.

See **CONNECTING AN EXTERNAL LINEAR AMPLIFIER** in Section 5 for a complete description on interfacing a linear to the OMNI-VII.

### **(36 & 37) TX EN / TX OUT**

Many QSK linear amplifiers are equipped with a full break-in keying loop to assure proper sequencing of amplifier keying when operating full break-in CW. TX EN and TX OUT are used for a full break-in linear amplifier keying loop. Do not connect more

than 15 Vdc and 100 mA to the TX EN or TX OUT jacks.

TX EN and TX OUT should be connected to the corresponding QSK loop IN and OUT jacks on your amp. On a Ten-Tec QSK amp, TX EN is connected to KEY OUT and TX OUT is connected to KEY IN via shielded cables (consult the operator's manual of your non-Ten-Tec QSK amp for the proper loop information).

To use the full break-in keying loop, it must be enabled from the menu. Note: If the loop is turned on, and no connections are made it will prevent the OMNI-VII from transmitting.

See **CONNECTING AN EXTERNAL LINEAR AMPLIFIER** in Section 5 for a complete description on interfacing a linear to the OMNI-VII.

Tip: TX EN can also act as a transmit inhibit input if it is desirable to prevent OMNI-VII from transmitting until other station accessories have been switched. When the loop is on, no RF will be transmitted until a closure to ground is present at the TX EN jack, whether from a keying loop or from some other external source.

### **(38 & 39) SPARE**

No connection.

### **(40) DC IN**

This is the dc input connector. OMNI-VII requires 23 amps at +13.8 Vdc nominal for 100 watts output power. The supply voltage can range from +12.8 to +15.0 Vdc but +13.8 Vdc is the optimum value. We recommend using the included dc power cable (P/N 86095). We have also included spare connector pins (P/N 41020) and a spare two-pin power connector shell (P/N 35165) for building your own cable. The power supply plug will attach in only one direction to the polarized two-pin dc connector on the rear panel. Use no less than #14 gauge (#12 recommended) stranded wires for three-foot long connections to accommodate the high current demand during transmit. Use heavier gauge wire for longer power supply leads.

### **(41) DC OUT**

This jack provides +13.8 Vdc output for connection of accessory equipment. A maximum of 500 mA current draw is possible. The jack has voltage present only when transceiver power is turned on.

### **(42) FUSE 25 A**

OMNI-VII is equipped with a 25-ampere blade-type automotive fuse. A replacement has also been provided in the transceiver packing kit.

### **(43) (GROUND TERMINAL)**

The wingnut-equipped post is for connection of station ground or counterpoise. See **A WORD ABOUT GROUNDING** in Section 1.

### **(44) ETHERNET**

The rear panel Ethernet jack is used for remote control of the transceiver with the One Plug graphical user interface software, available for free download from our website.

The radio must be placed into REMOTE STATE to use the Ethernet interface. See the description of **RADIO STATE VS. REMOTE STATE** in Section 1 of this manual.

### **(45) ANT 1**

The ANT 1 connector is an SO-239 jack used for connection of a coaxial fed transceiver antenna, nominal impedance 50 ohms, for use on any band the OMNI-VII covers. Antennas are selected using the ANT front panel button. See the description of **(14) ANT** in Section 2 of this manual.

### **(46) ANT 2**

The ANT 2 connector is an SO-239 jack used for connection of a coaxial fed transceiver antenna, nominal impedance 50 ohms, for use on any band the OMNI-VII covers. Antennas are selected using the ANT front panel button. See the description of **(14) ANT** in Section 2 of this manual.

### **(47) AUX RX**

The AUX RX connector is an SO-239 jack used for connection of a coaxial fed receive-only antenna, nominal impedance 50 ohms. This antenna can be used in transceiver

mode with either ANT 1 or ANT 2 being used as the transmit antenna. Antennas are selected using the ANT front panel button. See the description of **(14) ANT** in Section 2 of this manual. The automatic antenna tuner (optional, if installed) is not available for use on an antenna connected to this jack.

## Section 4 – USING THE MENU

The OMNI-VII is equipped with a single menu, accessible by pressing the MNU button. It is our philosophy that most frequently used controls on an HF transceiver should be accessible via buttons and knobs on the front panel while leaving less often used items in a menu system.

Each line item in the menu will be described in this section in the order they appear on the menu screen, as of the initial release of the transceiver firmware.

Press MNU to access the menu. Scroll down through the menu items by using the large main tuning knob. To change the value on an individual line item, turn the MULTI knob.

### AUTO TUNER

Available settings: ON, OFF.

This menu item is used to turn on or disable the optional internal automatic antenna tuner (if installed). When set to ON, the tuner can be activated by pressing the TUNE button. When set to OFF, the tuner is disabled until set to ON in the menu – it cannot be reactivated from the front panel.

See **OPERATING THE AUTOMATIC ANTENNA TUNER (IF INSTALLED)** in Section 5 for complete autotuner instructions.

### TX METER

Available settings: PWR, SWR.

OMNI-VII has a power and SWR bargraph meter on the screen. This bargraph meter is used to display received S-units in receive mode. In transmit mode, the meter can be configured to show either power output or SWR by toggling this menu option.

### TRANSMITTER

Available settings: ON, OFF

OMNI-VII's transmitter can be disabled by changing this line item to OFF.

### SSB TX BW

Available settings: 1000-4000 Hz in 200 Hz steps.

The SSB TX BW control determines the bandwidth of a transmitted SSB signal. It is selectable in 200 Hz steps from 1000-4000 Hz. The upper and lower ends of the transmitted bandwidth are determined by this value and the TX ROLL OFF menu item. Example: If SSB TX BW is set to 2400 Hz and TX ROLL OFF is set at 200 Hz, the SSB transmit response is 200-2600 Hz.

We recommend you read and understand **FACTORS THAT AFFECT THE SOUND OF SSB TRANSMIT AUDIO AND THEIR ADJUSTMENT** as described in section 5 before experimenting with this control.

### TX ROLL OFF

Available settings: 70-300 Hz in 10 Hz steps.

TX ROLL OFF determines where the low end frequency response of an SSB transmit signal begins to attenuate. It is selectable in 10 Hz steps from 70-300 Hz. Example: If SSB TX BW is set to 2400 Hz and TX ROLL OFF is set at 200 Hz, the SSB transmit response is 200-2600 Hz.

We recommend you read and understand **FACTORS THAT AFFECT THE SOUND OF SSB TRANSMIT AUDIO AND THEIR ADJUSTMENT** as described in section 5 before experimenting with this control.

### KEYING LOOP

Available settings: ON, OFF.

The KEYING LOOP menu item is used to enable the TX EN / TX OUT QSK keying loop as described in Section 3 under **(36 & 37) TX EN / TX OUT**. The interface instructions for using these jacks are provided there and in Section 5 under **CONNECTING A LINEAR AMPLIFIER**. Note: If the loop is turned ON and no connections are made it will prevent the OMNI-VII from transmitting.

### AUDIO SOURCE

Available settings: MIC, LINE, BOTH.

The AUDIO SOURCE menu item is used to determine which audio input is used for

transmitting. Set to MIC, the OMNI-VII uses into audio fed into the front panel microphone jack for transmitting. Set to LINE, audio input is only accepted via the rear panel ACC 1 jack line level input. Set to BOTH, the OMNI-VII will accept either line level audio input via ACC 1 or via the mic jack.

Note: If AUDIO SOURCE is set to BOTH and a microphone is connected, when PTT is activated, audio will be coupled through the microphone channel even if the PTT is activated via the rear panel (in digital modes, for example)!

## LINE GAIN

Available settings: 0-100%

This control is the gain setting for a line level input fed to the transceiver via the AUDIO IN connection on pin 1 of the ACC 1 jack. AUDIO SOURCE in the menu must be set to LINE or BOTH before this input will function.

## EXT T/R DELY

Available settings: 0 to 100%

EXT T/R DELY (delay) provides “hang time” for a non-QSK linear amplifier that has been connected to the AMP KEY jack on the rear of the OMNI-VII. This will prevent the amplifier from dropping out between words of a CW or SSB transmission. See the description of **(35) AMP KEY** in Section 3 and **CONNECTING AN EXTERNAL LINEAR AMPLIFIER** in Section 5.

A setting of 100% is an approximate delay of 1 second. A setting of 0% is approximately 15 mS.

## FM TX CTCSS

Available settings: OFF, or any of the 40 standard CTCSS access tones.

CTCSS (Continuous Tone Controlled Squelch System) transmits a sub audible tone in the range of 67 to 254 Hz encoded with voice audio. FM repeaters on the 28 and 50 MHz bands frequently will employ the use of a CTCSS tone for access. To select a tone, turn the MULTI knob. The tone frequencies, in HZ, will be displayed.

FM TX CTCSS is active in FM mode only. If a value is selected and the radio is in any other mode, this line item is ignored by the

transceiver and the tone will not be transmitted. There is no CTCSS “tone squelch” decode function on receive; CTCSS is encode (transmit) only.

## RX EQUALIZER

Available settings: -20 to 20 dB

OMNI-VII provides independently adjustable audio equalization for the receiver and transmitter. They enable tailoring audio frequency response for greater effectiveness and to accommodate your preferences.

The RX EQUALIZER establishes a specific audio profile for receiver audio. The RX EQUALIZER is selectable in 1-dB steps from high pitched at -20 to essentially flat response at 0 dB to very bassy at +20 dB.

## TX EQUALIZER

Available settings: -20 to 20 dB

OMNI-VII provides independently adjustable audio equalization for the receiver and transmitter. They enable tailoring audio frequency response for greater effectiveness and to accommodate your preferences.

The TX EQUALIZER establishes a specific audio profile for your transmitted audio from either the MIC or line input sources (see description of AUDIO SOURCE and LINE GAIN in the menu). The TX EQUALIZER is selectable in 1-dB steps from high pitched at -20 to essentially flat response at 0 dB to very bassy at +20 dB.

## RECALL SUB

Available settings: ON, OFF.

RECALL SUB is related to the memory storage system in the transceiver that uses the V>M and M>V buttons. See also **(10) V>M** and **(11) M>V** in Section 2.

When set to ON, a memory recalled using the M>V button will not only recall the VFO A frequency, mode, and DSP BW filter, it will also recall VFO B frequency, if the split frequency was turned on (using the **SPL** button), and the FM CTCSS tone in use. This function is primarily for saving 6 and 10 meter FM repeater splits and tones into the memories.

Set to OFF, the memory system will recall VFO A frequency, DSP BW, and mode only.

RECALL SUB does not need to be set to ON to save the VFO B frequency, FM CTCSS tone, and split into memory. The memory system will do this automatically. They will not be recalled until RECALL SUB is set to ON.

## SIDETONE FRQ

Available settings: 0-1270 Hz in 10 Hz steps.

The SIDETONE FRQ menu line item is used to set CW sidetone and the autotracking CW offset frequency.

Pressing and holding the SPOT button will produce a tone at the SIDETONE FRQ value set by the operator. This tone can be matched to the received tone of an on-air CW signal to achieve zero beat. Press and hold the SPOT button while tuning in a CW signal. When the tones match, you are on the proper frequency.

This menu line item is also adjustable from the front panel without entering the menu by pressing ALT then S-T. See **(28) SPO/S-T** in Section 3.

## SIDETONE VOL

Available settings: 0 to 100%.

SIDETONE VOL duplicates the S-T adjustment that is selectable by pushing the SPO/S-T button on the front panel. See **(28) SPO/S-T**.

## SPOT VOLUME

Available settings: 0 to 100%.

SPOT VOLUME duplicates the SPOTVOL adjustment that is selectable by pushing the SPO/S-T button on the front panel. See **(28) SPO/S-T**.

## CW QSK DELAY

Available settings: 0 to 100%

CW QSK DELAY allows slowing down or partially defeating the full break-in CW capability of the OMNI-VII.

A higher value represents more transmit/receive delay between individual transmitted CW characters. A setting of 0% is full break-in CW. A delay of 100% is approximately a 1 second recovery time before receive audio is restored.

Please note that this control is not used for “hanging” the transmitter for keying an external linear amplifier. That function is done with **EXT T/R DELY**, described elsewhere in this section.

## CW WEIGHTING

Available settings: 0 to 24%

CW WEIGHTING refers to the length of a space between two transmitted dits in CW versus the dit itself. At a setting of 0%, the transmitted dit and the space after it are of equal length. Adjusting this value upward subtracts length from the available space and adds it to the dit, to make the dit length longer and the space between characters shorter. The upper value of 24% refers to 24% of the space time being added to the transmitted dit. Higher values past 24% (if they had been made available) would continue to shorten the space until all that was transmitted is a continuous carrier at 100%.

## CW KEYER

Available settings: OFF, MODE A, MODE B

The OMNI-VII's internal keyer can be configured for either Curtis mode A or mode B keying. Turn the MULTI knob to select or to turn the keyer off.

The difference between mode A and B is what the keyer does when both paddles are released after being squeezed at the same time. Mode A completes the element being sent when the paddles are released. Mode B sends an additional element opposite to the one being sent when the paddles are released.

The basic difference between the modes can be described by sending the letter C in Morse Code. In mode A, squeeze both paddles (dah before dit) and let go of both

after hearing the last dit. With mode B, you start the same, then let go of both paddles after hearing the second dah. The C will self-complete in mode B; in mode A the last character sent will be the second dah.

The CW keyer can also be turned off from the front panel using the SP button but mode A or mode B can only be selected via the menu. See **(29) SP/VOX** in Section 3.

## **CW RISE/FALL**

Available settings: 3 to 10 ms.

CW RISE/FALL allows the operator to adjust the rise and fall time of the transmitted CW envelope. The adjustable values are 3 ms to 10 ms, depending on whether the internal keyer or external keying is used, and the speed at which the internal keyer is set. The default value is 5 ms. Lower values like 3 ms will result in a "harder" keying sound with a quicker slope from keying initiation to full envelope and back. Higher values result in more gentler slopes for the CW transmit envelope on the "make" and "break" and result in a softer transmitted CW note.

Use of ALC to control the output power will corrupt the attack time of the CW character. For instance, a CW wave is generated to produce a character with 1 volt peak and a 6 ms rise time. If there is 6 dB too much gain in the transmit loop, ALC will be reached when the CW wave reaches .5 volt. At that point the rise time is 3 ms, not 6 ms. That change in the rise time will happen on the first character, and the ALC time constant will determine what the change in rise time will be over the transmission. This may be improved by changing the transmitter gain, the level of the CW wave or both.

The OMNI-VII uses the voltage derived from the bridge circuit as a reference for 100 watts output. Each band is calibrated in production. This sets the required DSP output. The CW waveform is generated in DSP and uses a raised cosine for the attack and decay. The level of the DSP waveform for the power selected can be calculated from the level given for 100 watts before the key is pressed. The keyed signal is adjusted slightly to compensate for variations in load impedance. The attack

time is calculated as the time required for 180 degrees of the cosine.

## **AUTO SWEEP**

Available settings: ON, OFF.

The momentary sweep scope on OMNI-VII can automatically re-sweep without pushing the SWP button.

When turned to ON, once the red cursor present on the sweep display is moved to either edge of the shown swept range, the sweep function will re-enable without pushing the SWP button again.

## **SWEEP RANGE**

Available settings: 3, 30, 300 kHz.

The SWEEP RANGE setting determines what range of frequencies are swept when the SWP button is pushed.

See **(15) SWP** in section 3 of the manual for complete information on how the momentary spectrum sweep operates on OMNI-VII.

## **VOX TRIP**

Available settings: 0-100%

This control determines how easily signal input into the microphone will open (trip) the VOX circuitry and put the radio in transmit in SSB, AM, and FM modes. The higher the value, the easier the radio goes into transmit when talking into the microphone.

## **ANTI-VOX**

Available settings: 0-100%

ANTI-VOX is used to inhibit receiver audio from tripping the VOX circuitry. Higher values require more noise to activate VOX, lower value require less noise to activate VOX.

## **VOX HANG**

Available settings: 0-100%

VOX HANG is used to determine how long the transmitter remains keyed after VOX activity before the radio switches back to receive. This is to prevent the radio from cutting back and forth between transmit and receive with each syllable and/or word. Higher values keep the transmitter keyed for longer periods of time.

## FSK TX DATA

Available settings: MARK HIGH, MARK LOW.

FSK TX DATA is used to determine whether the MARK tone in FSK operation is on the high tone (2295 Hz) or low tone (2125 Hz). The standard is for FSK to use the low tone for MARK. FSK direct to the radio from a computer sound card (no TNC) should have this set to 'high' so tones will not be inverted. See the description for **FSK OPERATION** in Section 5.

## REMOTE F1, REMOTE F2, REMOTE F3

Available settings: STEP, MODE, REV, A/B, A=B, SWEEP, SPLIT, RIT

**REMOTE F1, REMOTE F2, and REMOTE F3** refer to the control of radio functions available via the F1, F2, and F3 buttons on the accessory model 302R remote encoder/keypad available for OMNI-VII. If you do not have the 302R connected, they will have no function.

To scroll through the available choices for each of **REMOTE F1, REMOTE F2, and REMOTE F3**, turn the MULTI knob.

STEP duplicates the function of the STEP button on the front panel. See **(13) STEP** in Section 2. Unlike the front panel STEP button, the step sizes available are selected via repeat pushing of the F1, F2, or F3 button depending on which is being used. The radio will cycle through the seven available step sizes.

MODE duplicates the function of the MODE button on the front panel. Unlike the front panel MODE button, the modes available are selected via repeat pushing of the F1, F2, or F3 button depending on which is being used. The radio will cycle through the seven available modes. See also **(12) MODE** in Section 2.

REV duplicates the function of the front panel REV button. See **(18) A=B, A>B, SPL, REV** in Section 2.

A/B duplicates the function of the front panel A/B button. See **(18) A=B, A>B, SPL, REV** in Section 2.

A=B duplicates the function of the front panel A=B button. See **(18) A=B, A>B, SPL, REV** in Section 2.

SWEEP duplicates the function of the front panel SWP button. See **(15) SWP** in Section 2.

SPLIT duplicates the function of the front panel SPL button. See **(18) A=B, A>B, SPL, REV** in Section 2.

RIT allows the RIT to be turned on and off. Unlike the front-panel RIT button, there is no "press to clear" function; assigning RIT on/off to a function button on the keypad only allows it to be turned on or off. This function can be active whether the RIT is assigned to the remote encoder/keypad or not.

## REMOTE ENC

Available settings: VFO-A, VFO-B, RIT/XIT, PBT/BW

REMOTE ENC is used for the accessory 302R remote encoder/keypad. The 302R's main tuning knob can be used to tune either VFO-A or VFO-B by selecting the appropriate VFO on this menu line item.

The 302R main tuning knob can also be used for RIT/XIT or PBT/BW operation by selecting RIT/XIT or PBT/BW on this menu line item.

PBT/BW operation will depend on which of PBT or BW is selected by pressing the PBT/BW encoder on the front panel of the transceiver.

## POD ENC RATE

Available settings: FAST, SLOW.

Unlike tuning STEP as set via the STEP button, the **POD ENC RATE** control is used to determine how many steps per revolution the optional 302R remote encoder/keypad tuning knob makes.

The FAST rate is slightly less than 2x the SLOW rate.

Set to SLOW and 10 Hz steps (the most commonly selected step size), one knob revolution tunes approximately 1.2 kHz.

Set to FAST and 10 Hz steps, one knob revolution tunes approximately 2 kHz.



## VFO ENC RATE

Available settings: FAST, SLOW.

Unlike tuning STEP as set via the STEP button, the **VFO ENC RATE** control is used to determine how many steps per revolution the main tuning knob makes.

The FAST rate is slightly less than 2x the SLOW rate.

Set to SLOW and 10 Hz steps (the most commonly selected step size), one knob revolution tunes approximately 1.2 kHz.

Set to FAST and 10 Hz steps, one knob revolution tunes approximately 2 kHz.

## RIT ENC RATE

RIT and XIT tuning steps are fixed at 10 Hz.

The RIT ENC RATE control is used to determine how many steps per revolution the RIT/XIT tuning knob makes.

The FAST rate is 4x the SLOW rate.

Set to SLOW, one knob revolution tunes RIT/XIT approximately 90 Hz.

Set to FAST, one knob revolution tunes RIT/XIT approximately 360 Hz.

## VFO SPDSHIFT

Available settings: ON, OFF.

The main tuning knob on the OMNI-VII is equipped with a feature called VFO SPEED SHIFT. When set to ON, turning the VFO knob very fast will result in larger movement up or down the band than would have been possible with the step size and VFO ENC RATE set at given values.

Example: With step size set at 10 Hz and VFO ENC RATE to SLOW, one complete knob revolution at a normal tuning speed for listening to the band will cover approximately 1.2 kHz. If VFO SPEED SHIFT is ON, turning the knob very fast will tune approximately 4 kHz per revolution. This is to allow the operator to quickly move from one part of a band to another without changing step size or VFO rate.

## DISPLAY

Available settings: 0 to 100%

DISPLAY controls the intensity of the backlighting on the display screen. Lower

values are darker lighting, higher values are brighter lighting. At 0%, the screen lettering is almost unreadable on a dark background. At 100%, the screen is "washed out" in light.

The default value is 50%.

## SPEECH PROC

Available settings: 0 to 100%

SPEECH PROC duplicates the front panel-accessible SP function in the menus. See **(29) SP/VOX** in Section 2.

## I-F FILTER

Available settings: 20 kHz, 6 kHz, 2.5 kHz, 500 Hz, 300 Hz, AUTO.

OMNI-VII is equipped with a 20 kHz wide filter at the 70 MHz 1<sup>st</sup> I-F, and up to five filters at the 455 kHz I-F. Bandwidths of 20, 6, and 2.5 kHz at the 455 kHz I-F are standard equipment; Collins™ mechanical filters at 500 Hz (model 2031) and 300 Hz (model 2032) filters are optional. The stock 2.5 kHz filter is also a Collins™ mechanical filter.

See **I-F FILTER AND DSP BANDWIDTH FILTER THEORY AND USE** in Section 5 for a complete explanation of the use of these filters in conjunction with the DSP bandwidth filtering.

Each I-F FILTER can be selected independently or AUTO can be employed to automatically select a filter when that filter's bandwidth threshold is crossed.

Example: Set I-F FILTER to AUTO and exit the menu. Turn the BW knob to adjust BW to 2000 Hz. The filter selected will be shown as IF 2.5 kHz on the screen. Turn BW knob clockwise to increase value. As you pass 2500 Hz to the next DSP BW filter, the OMNI-VII automatically selects the next highest available I-F filter value (in this case, 6 kHz). Turn the BW knob counterclockwise to decrease the DSP BW value and the filters available will automatically decrease as the threshold of each is passed.

When set to AUTO, the I-F filter bandwidth value shown on the screen is in green lettering. When an individual I-F filter is manually selected, the bandwidth value is shown in white.

When a filter has been selected manually, the DSP BW value cannot be adjusted above that manual filter selection. Example: If the 2.5 kHz filter is manually selected, the highest available DSP BW is then 2500 Hz.

Note: Optional 500 Hz and 300 Hz filters must be enabled in the menu before use. See **ENABLE 300 Hz, ENABLE 500 Hz** in the next sub-section.

## **ENABLE 300Hz, ENABLE 500 Hz**

Available settings: YES, NO

Optional Collins™ mechanical 455 kHz I-F filters at 500 Hz (model 2031) and 300 Hz (model 2032) are available as options. These filters must be enabled in the menu to be used after installing.

After installation, turn the MULTI knob to select YES for any filter installed.

Selecting YES for a filter that is not installed will result in the receiver muting when that filter is either manually selected or engaged with the AUTO function under I-F FILTER.

An installed optional 500 Hz or 300 Hz filter can be disengaged by selecting NO. For example, if the optional 500 Hz filter is installed, ENABLE 500 Hz is set to NO, and I-F FILTER is set to AUTO, when turning the BW control lower than 500 Hz the 500 Hz I-F filter will not engage and will remain at 2.5 kHz.

How to install optional I-F filters is covered under **INSTALLATION OF OPTIONAL COLLINS™ MECHANICAL FILTERS** in Section 5.

## **SQUELCH**

Available settings: 0-100%

OMNI-VII is equipped with an all-mode squelch that is accessible only from repeat pressing of the MULTI knob; it is not shown as a line item in the menu system. See the description of (4) MULTI ENCODER earlier in the manual.

The squelch control mutes receiver noise until a signal of sufficient strength is received, opening the squelch. This can be useful for monitoring a calling frequency like 50.125 MHz on SSB or 10m FM repeaters without having to listen to the constant background noise of the band in use.

When the receiver is squelched, the legend SQL will appear as a green rectangle on the upper left of the screen, just above the PBT value indicator.

## Section 5 – OPERATION NOTES AND ACCESSORY CONNECTION EXAMPLES

### OPERATING THE AUTOMATIC ANTENNA TUNER (IF INSTALLED)

First, enter the menu system by pressing MNU and assure that line item AUTO TUNER is set to ON.

The matching range of the tuner is approximately 6 to 800 ohms or a 10:1 maximum SWR up to 30 MHz. The automatic antenna tuner will not operate on the 50 MHz (6 meter) band.

While the tuner will tune many HF antenna installations, some multi-band wire antennas are capable of exhibiting a feedpoint impedance of several thousand ohms and are unsuitable to be tuned with the autotuner. An example would be an 80 meter 1/2 wave dipole fed on 40 meters which would exhibit a feedpoint impedance of several thousand ohms. The ARRL Antenna Book and antenna design websites like W4RNL's [www.cebik.com](http://www.cebik.com) can also provide a wealth of useful information about effective antennas for use with OMNI-VII.

To use the internal tuner, press TUNE. A carrier at approximately 20 watts output power will be transmitted and the tuner will actuate. It takes 1 to 3 seconds to tune depending on frequency and load impedance.

Once tuned, the legend TUNED will appear at the upper left corner of the screen. To bypass the tuner, press TUNE again and the legend will change to BYPASS.

The tuner will usually stop at a value of 1.5:1 SWR or lower. Occasionally it may present a slightly higher SWR after tuning. This is normal, and the transceiver will still transmit at full output power with no foldback.

The tuner has 100 tune memories. The user must hit TUNE each time he returns to a previously used frequency to recall the tuner settings. Instead of taking 1 to 3 seconds to tune, a previous frequency in the tuner memory will tune in a shorter amount of time. If user changes bands and does not hit tune before transmitting, the tuner is in

bypass mode and SWR is that of the antenna connected.

The automatic antenna tuner will operate on either ANT 1 or ANT 2 depending on which has been selected with the front panel ANT button. The tuner will NOT memorize settings per antenna, only per frequency for the last antenna used.

If an attempt is made to use the autotuner on the 50 MHz band, the status message NO AUTO 6M will appear at upper right on the screen. To remedy, go into the menu and turn the autotuner off. The TUNE and/or PWR buttons can then be used to generate a carrier on the 50 MHz band.

In some circumstances, it may be possible to present a load outside the 6 to 800 ohm matching range to the autotuner. The tuner will be unable to match an impedance outside 6 to 800 ohms, and the screen message TUNE FAILED will appear on the screen at top right. The tuner will automatically switch to BYPASS if the TUNE FAILED message appears.

### CONNECTING AN EXTERNAL LINEAR AMPLIFIER

There are three possible types of connections for a linear amplifier depending on whether your amplifier is a QSK linear amplifier and whether, if so, it employs the use of a full break-in keying loop.

Non-QSK linear amplifiers or QSK linears that do not employ the use of a keying loop are keyed from the AMP KEY jack. Connect the PTT keying line of your linear amplifier to the AMP KEY jack using a shielded cable with RCA-style male phono connectors at each end. The AMP KEY keying output is an open collector transistor output. See the warnings about attaching older linear amplifiers that may have high voltage present on the PTT line before using your amplifier.

Some QSK linear amplifiers incorporate the use of a full break-in keying loop. Ten-Tec transceivers and linear amplifiers use a full break-in keying loop to assure proper sequencing of the keying between the radio and the amplifier.

To use the OMNI-VII with a full break-in linear amplifier incorporating a keying loop,

use the TX EN and TX OUT jacks. TX EN on the transceiver is connected to KEY OUT on the amplifier, TX OUT on the transceiver is connected to KEY IN on the amplifier.

Place the amp in QSK mode. The amplifier will be used in all modes in the QSK position. The keying loop voltage and current limits are 15 Vdc and 100 mA.

The keying loop in the OMNI-VII must be enabled through the menu. For menu line item KEYING LOOP, select ON. Please note that if KEYING LOOP is turned ON and no ability to complete the loop is present (i.e. no connection, or a connection that is not closing properly) the radio will not transmit.

OMNI-VII is equipped with a T/R delay feature (EXT T/R DELY) accessible via the menu that operates on both the AMP KEY connection and the TX EN / TX OUT keying loop. This gives the operator the ability to have the amplifier keyed longer by the radio, preventing drop outs between words of SSB or CW operation.

Linear amplifiers can be used on either of the ANT 1 or ANT 2 antenna jacks on the rear panel.

**IMPORTANT NOTE:** The AMP KEY line should not have applied to them more than +100V (output inactive) nor should it draw more than 250 mA (output active). Many older linear amplifiers like those manufactured by Collins, Drake, and Heathkit have a higher voltage on the keyline. Such amplifiers **require** a relay or transistor switch between the OMNI-VII AMP KEY jack and the amplifier PTT input. A sample plug-and-play device that can be used between OMNI-VII and your amplifier is the Ameritron ARB-704 interface box. If you are unsure if your amplifier is suitable for use as-is with the OMNI-VII, please consult the operator's manual for your amplifier or contact the Ten-Tec service department at (865) 428-0364 or [service@tentec.com](mailto:service@tentec.com)

## TUNING UP AN EXTERNAL LINEAR AMPLIFIER

The TUNE button on the front panel can be used for initial linear amplifier tune-up. If an automatic antenna tuner is installed in your OMNI-VII, go into the menu and disable it with the AUTO TUNER line item. Pressing

the TUNE button will provide approximately 20 watts of keydown CW carrier output to be used for an initial tune-up of your linear.

It may be desirable to increase the keydown power output when tuning your amplifier. To do so, press the PWR button after pushing the TUNE button. Power output will move from the low power setting to whatever level the PWR control has been set at with the MULTI knob. Repeat operation will require pushing TUNE then PWR again for the higher output value.

## INSTALLATION OF OPTIONAL COLLINS™ MECHANICAL FILTERS

Collins™ mechanical I-F filters for the 455 kHz I-F at 500 and 300 Hz bandwidth are available as optional equipment.

To install optional filters: Turn transceiver power off and remove DC power cable. Remove the four side case screws. Remove the 5 Torx screws from the rear perimeter of the top cover. A Torx wrench to remove them is supplied in the transceiver packing kit.

Place the radio on the table with the front facing you.

Slide the top cover of the radio just back enough to get the metal lip out from under the plastic face of the transceiver. Remove the top cover by lifting SLOWLY to your right – the cable running to the transceiver internal speaker is attached to the underside of the top cover. Pulling hard on the cover or pulling to the left can break the speaker wire. Set the top cover against the right side of the open radio.

The filter slots are on the RF board – this board is the center and left front of the rig. The filter slots are 6 inches back from the front of the radio near the left side and are covered with a small metal shield attached to two posts with screws. Using a Phillips screwdriver, remove the screws and the shield. The open slots on the board are marked '500 Hz' and '300 Hz'. The filters have three pins oriented in a slight V pattern. Insert the filter pins into the sockets on the board. Replace the metal filter shield. Replace top cover and top cover screws.

Optional 500 and 300 Hz filters must be turned on in the menu before they will activate. See **ENABLE 500 Hz**, **ENABLE 300Hz** in Section 4.

## I-F FILTER AND DSP BANDWIDTH FILTER THEORY AND USE

OMNI-VII is equipped with a series of “distributed roofing filters” at the 70 MHz first I-F and 455 kHz second I-F.

There are stock filters at 20 kHz bandwidth at the 70 MHz first I-F and 20, 6, and 2.5 kHz bandwidth at the 455 kHz second I-F. Optional filters at 500 Hz and 300 Hz bandwidths can be also installed in the 455 kHz second I-F.

Some basic discussion on what is and what is not important for optimum receiver performance.

An HF receiver must have adequate sensitivity to hear signals. The receiver also must have reasonable dynamic range to hear weak signals in the presence of loud signals (the definition of dynamic range being the ratio between the strongest signal that can be handled without front-end distortion and the weakest detectable signal). Design considerations should keep internally generated local oscillator phase noise to a minimum.

It's no difficult feat to achieve these requirements – most any HF receiver used for ham radio purposes today, on face value has adequate (or even too much) sensitivity and enough dynamic range that a single loud signal that appears on an HF frequency doesn't immediately overload the receiver.

The problems start, potentially, when there are multiple loud signals within a small distance of a desired frequency. You may be listening to 14.200 MHz, but that S9+40 signal on 14.210 that you're not hearing? It still has the potential to compromise overall receiver performance, even when it's not on the frequency you're listening to. You might not even realize it – a loud signal 10 kHz up the band limits dynamic range, making a weak signal you want to hear at 14.200...just not be there. You'd never know – the receiver may sound “fine”, but no signal will be on the frequency you're listening to. Worse perhaps would be not only is no desired signal present, but that

loud signal and other ones near it might even be throwing spurious distortion products onto the frequency of interest.

What to do? Loud signals are a fact of life in ham radio.

The answer is: find a way to protect the overall receive chain, within the limits of the design of the radio, to maintain adequate sensitivity, dynamic range and third order intercept point.

What does third order intercept point sound like? It doesn't sound like anything – you can't hear it, because it's calculated from a formula that uses both the minimum discernable signal and dynamic range to predict a “point” at which the radio will go non-linear and break into distortion.

The most optimal receiver protection scheme is one that does not affect receiver sensitivity, and maintains dynamic range even in the presence of nearby undesired loud signals.

Second I-F roofing filters can help limit undesired signals from having an impact on overall receiver performance. OMNI-VII uses a 20 kHz wide monolithic filter at the first I-F of 70 MHz. This filter is of little practical value for maintaining receiver performance – it is generally for allowing AM and FM operation only.

Filters at the 455 kHz I-F are 2.5 kHz (standard), 500 Hz and 300 Hz (both optional). These filters are cascaded together with the 20 kHz wide 70 MHz first I-F filter when one of them is in use.

The net effect of using 455 kHz second I-F filters over only the 20 kHz monolithic at the first I-F is to increase blocking dynamic range over what the receiver would be capable of without the second I-F filters installed. Third order intercept point remains fairly constant with only a small degradation. The front-end AGC in the transceiver is after the 455 kHz I-F filters; having these filters installed also prevents the radio from attempting AGC action on a signal that is outside the bandwidth of the 455 kHz I-F filter.

These filters are not to be confused with bandwidth filtering, which is done in DSP and is adjusted from the front panel BW

control. 20 kHz first I-F filter + 455 kHz I-F filter + DSP BW filter at the third I-F should be adequate under most circumstances to keep the receiver linear and maintain the ability to hear weak signals in the presence of multiple loud ones.

## **FACTORS THAT AFFECT THE SOUND OF SSB TRANSMIT AUDIO AND THEIR ADJUSTMENT**

One of the features of the OMNI-VII is flexibility afforded the operator for the desired sound of SSB transmit audio.

Many possible settings are available so that operators with different styles (or philosophies) can adjust the radio the way they want it to sound. Obviously, the operator who favors rich, full-sounding transmit audio is not going to have the same needs as the DXer who wants maximum "oomph" to try and break a SSB pileup. There are several controls that interact on OMNI-VII for SSB transmit audio. Every operator is different; we use different microphones, the timbre of voices are different, distance from the microphone will vary. What we intend below is to describe what is used to tailor transmit SSB audio, and then encourage the operator to experiment with the settings to find the sound they want.

A monitor function has been provided for the operator to listen to the sound of actual transmitted SSB audio. We recommend using headphones while using the monitor circuit to prevent microphone/speaker feedback. See the description of **(25) MIC/MON**.

There are five radio controls used for SSB transmit audio. 1) Transmit bandwidth, which is adjusted using the SSB TX BW control in the menu. 2) Low frequency rolloff, adjusted with the TX ROLL OFF control in the menu. 3) TX EQUALIZER, adjusted via the menu. 4) Mic gain, adjusted via the front panel MIC/MON button. 5) Speech processing, adjusted via the front panel SP/VOX button. Additionally, there is a hardware mic gain

control that is accessible under the front of the bottom panel.

Transmit bandwidth is both the frequency response of the transmitted signal and the amount of spectrum occupied by that signal. Typical communications-grade audio for SSB is in the 2.4 to 2.7 kHz range. Some "hi-fi" SSB enthusiasts have been experimenting with larger transmit bandwidths in an effort to improve the quality of audio transmitted. OMNI-VII has been provided with the ability to transmit on SSB with a maximum bandwidth of 4000 Hz. Please see the note toward the end of this section about wide SSB transmit bandwidths and their potential ramifications.

Set SSB TX BW in the menu to an appropriate value based on your operating preferences. For communications-grade audio, we recommend starting the transmit bandwidth at 2400 Hz. For more well-rounded transmit audio, start the transmit bandwidth at 3.0 kHz (3000 Hz). The default value is 2700 Hz.

The next control to adjust is TX ROLL OFF, also found in the menu. TX ROLL OFF refers to "low frequency rolloff". This control interacts with SSB TX BW determine your frequency response.

For example, if SSB TX BW set to 3000 Hz, and TX ROLL OFF is set to 200 Hz, the response envelope for your transmitted SSB signal is approximately a low of 200 Hz and a high of 3200 Hz for a total bandwidth of 3000 Hz. Using the same 3000 Hz SSB TX BW setting, if the TX ROLL OFF is changed to 100 Hz, the response envelope is now a low of 100 Hz to a high of 3100 Hz, for a total bandwidth of 3000 Hz. You can think of the TX ROLL OFF control as where the "bass response" from your voice and the transmit bandwidth is attenuated.

OMNI-VII is equipped with a transmit equalizer, labeled TX EQUALIZER in the menu. The TX EQUALIZER establishes a specific audio profile for your transmitted audio from either the MIC or line input sources (see description of AUDIO SOURCE and LINE GAIN in the menu). The TX EQUALIZER is a 6 dB/octave filter selectable in 1-dB steps from high pitched at -20 to essentially flat response at 0 dB to very bassy at +20 dB.

The two most-used SSB transmit controls will be mic gain (accessible from the MIC/MON button on the front panel) and the speech processor (accessible from the SP/VOX button on the front panel).

Mic gain is set by pressing the MIC button and talking into the microphone. When you have reached proper ALC, the red ALC LED located next to the S-meter on the front of the radio will flash on voice peaks. Adjust the mic gain upward until the ALC light is flashing on and off while you are transmitting. Different microphones will require more or less gain.

To account for differences in microphones used with OMNI-VII, a hardware mic gain control is also provided. This control is accessible via an access hole at the front bottom of the transceiver, near the mic jack at the junction of the molded front panel and metal bottom cover. This hardware mic gain control is before the microphone input amplifier. A simplistic description of the signal path input would be: microphone > hardware mic gain potentiometer > microphone amp > A/D converter > DSP. The software mic gain control adjusted with the MULTI knob is at the DSP level.

The hardware mic gain control is set to maximum as supplied from the factory to accommodate proper level for Ten-Tec microphones. Should your non-Ten-Tec microphone of choice be subject to easy overdriving, the hardware mic gain can be reduced. Please note that the hardware mic gain pot at full CLOCKWISE is at minimum, and full COUNTER-CLOCKWISE is maximum. This is as seen with the transceiver upside down and a tool inserted, not as if the transceiver is right side up and facing you.

Speech processing (SP) is provided to give the operator more "punch" to the transmitted signal. Speech processing increases the average amplitude relative to the peaks for an increase in average power transmitted. Press the SP button (if desired) and use the MULTI knob to adjust the speech processing level. Speech processing is generally not used for higher-fidelity SSB audio; its use is primarily for added intelligibility for communications-grade SSB audio. It is also possible with high levels of speech processing and combinations of microphone

and other settings available to send the transmitter into distorted SSB output. Use the monitor function to listen to what you are transmitting and avoid this.

The speech processor used in the OMNI-VII is a DSP generated RF compressor. Human voices have peak-to-average ratios as high as 15 dB. At 100 watts PEP output, the average output power might be as little as 3 watts! RF compression raises the average output power and tends to improve intelligibility by bringing out subtle parts of speech. With a digitally generated RF speech processor, we have the advantage of calculating the RF envelope before modulation is performed.

Note on wide SSB transmit bandwidths: Audio fidelity generally improves with the use of wider SSB transmit filtering. Using a 3.0 kHz or higher bandwidth will have a more "well-rounded" audio response than a narrower bandwidth. As transmit bandwidth widens, so does the potential for interference with stations using adjacent frequencies.

Part 97 of the FCC regulations governing amateur radio operation does not specify a maximum transmit bandwidth usable by amateurs for SSB communication. However, FCC regulation 97.307(a) requires amateur stations not to occupy more bandwidth than is necessary for the emission type being transmitted in accordance with good amateur practice. Regulation 97.307(b) requires that emissions outside the necessary bandwidth must not cause splatter interference to operations on adjacent frequencies.

While these are broad regulations subject to interpretation, the responsibility for complying with the regulations rests with the operator. Using an SSB transmit bandwidth wider than necessary for communications and causing interference to adjacent stations while doing so is specifically what these regulations are addressing. In summary, what may be an acceptable bandwidth on a given band at a given time may not be on another band at another time.

## FSK OPERATION

Selection of the FSK mode will allow the OMNI-VII to operate true FSK RTTY. The FSK circuitry is controlled through the ACC 1 jack on the rear panel of the transceiver.

Pin 5 on the ACC 1 rear panel jack is the MARK/SPACE or FSK input. This input is typically connected to the FSK output on a modem or terminal unit. The OMNI-VII receives FSK using lower sideband. The center of the filter passband is preset so any bandwidth filter used will be centered on the standard FSK MARK/SPACE 2125/2295 Hz tones.

The OMNI-VII display indicates the transmit MARK frequency. There is also user control called FSK TX DATA in the menu for selecting whether the MARK is the low tone or high tone (the standard is low tone). This allows the transceiver to be used with either TTL or open-collector keying schemes.

The monitor function is available in FSK mode and may be used to monitor the transmitted tones. See (25) MIC/MON is Section 2.

## ON- SCREEN STATUS MESSAGING

There are several status messages that can appear at the upper right of the radio screen under certain circumstances to warn the operator of a potential problem or to inform that an operation the transceiver cannot process is being attempted.

**NO AUTO 6M** – This message appears on the screen if an attempt is made to use the TUNE button to actuate the optional automatic antenna tuner on the 50 MHz band. To remedy, go into the menu, turn the autotuner to OFF and then the TUNE and/or PWR buttons can be used to generate a carrier on 50 MHz.

**HIGH CURRENT** - The OMNI-VII is equipped with a current limiting circuit. At 23 amps current draw HIGH CURRENT will appear on the upper right of the screen. At 25 amps, an internal silicon controlled rectifier will open and power to the radio will be shut off. Radio power can be restored by cycling the power switch or your 13.8 Vdc power source.

**OVER TEMP** – OMNI-VII uses an internal temperature gauge on the final amplifier. If the temperature exceeds 70 degrees C, this message will appear on the screen and the transmitter will be disabled for a minimum of one minute. After one minute, the firmware will perform a temperature status check on the final amplifier. If the temperature has reached 65 degrees C, the transmitter will be re-enabled and the OVER TEMP message will disappear from the screen. If the radio is still over 65 degrees C after one minute, the OVER TEMP message will remain on the screen and the transmitter will continue to be disabled until the temperature drops to that point.

**TUNE FAILED** – shown momentarily if the radio attempts to tune with the automatic antenna tuner and the tuner cannot tune, or if the radio is set up to use the autotuner and the tuner does not “answer” when queried by the radio. When TUNE FAILED occurs, the radio will automatically switch the automatic tuner to BYPASS.

## ON-SCREEN BARGRAPH METER

OMNI-VII employs a digital bargraph meter on the transceiver screen.

When in use on receive, the bargraph S-meter indicates received signal strength. The S-meter is calibrated to read S9 with a 50 uv signal at the antenna connector. Previous transceivers were calibrated to register S9 with a 50 uv signal without pre-amp or any attenuation engaged. OMNI-VII has been programmed to register an accurate strength of the signal regardless of internal amplifiers or attenuation.

On transmit, the bargraph meter can be used to monitor either transmit output power or SWR. See the description of **TX METER** elsewhere in this manual.

## OPERATING SPLIT FREQUENCY

Operating split frequency is commonly used in DX operation on the HF amateur radio bands. Stations will often transmit on a clear frequency while listening for callers on another nearby frequency.

Let's say a DX station is calling on 14.195 MHz and is telling callers “listening up 5 to 10”. You in turn should call on 14.200 to 14.205 MHz and listen for a reply on 14.195.



With the transceiver VFO A on 14.195.000, press A=B. Now both VFO's are on 14.195.000. Press and hold the REV button while turning the main tuning knob. When the display reads 14.200.000, release the REV button. Now press SPL to engage split frequency operation. The icon that reads "Tx" next to the VFO A display will drop down next to the displayed VFO B frequency and the VFO B frequency will change to red digits. You are now ready to transmit on 14.200 MHz and listen on 14.195 MHz.

When a DX station in this example is "listening up 5 to 10", it may be useful to listen to your TRANSMIT frequency in between DX station transmissions to ascertain where the DX station is listening. By pressing the REV button, you can listen to your transmit frequency. As above, you can also move the main tuning knob to tune around while holding the REV button. Release REV, and you are ready to transmit.

## EXTERNAL CW INPUT PLUS CW KEYS OPERATION FROM PADDLES

Some contest logging programs use computer generated CW for transmission of contest data (CQ's, reports, etc.) but do not employ the ability to send CW through any device other than input from the computer keyboard.

It is useful in this situation to be able to have both an external keyer (in this case, the computer) and the internal keyer in the OMNI-VII both simultaneously available. The "external keyer" is used for contest CQ's and information, while a paddle connected to the internal keyer can be used by the operator for quickly repeating necessary information.

Pin 3 on the ACC 1 connector on the OMNI-VIII rear panel is a PTT connection. In CW modes, this can allow the radio to be keyed by an external device in CW mode.

## DRAG ADJUSTMENT FOR THE MAIN TUNING KNOB

The main tuning knob is equipped with a *drag* control. To adjust the drag on the main tuning knob, hold the silver skirt still while rotating the knob about a quarter turn.

There will be a gentle "click" feel as the knob is loosened or tightened. Counter-clockwise twisting will loosen them and clockwise twisting will increase the drag. Loosen them up or increase the drag to your preference.

## MASTER RESET

On rare occasions, it may be possible to confuse the microprocessor in the transceiver to the point where a master reset may be necessary to restore operating state. A master reset often needs to be done after an upgrade for the transceiver is sent via the serial port interface (see **UPDATING OMNI-VII FIRMWARE** elsewhere in this section).

To perform a master reset, turn transceiver power off. Press and hold the MNU button down. Turn transceiver power on, and continue to hold the MNU button until the message "MASTER RESET" appears towards the upper left of the radio screen. This should take about 5 seconds after turning radio power on.

## UPDATING OMNI-VII FIRMWARE

Like other Ten-Tec transceivers, the firmware in OMNI-VII is Flash-ROM upgradeable. The latest version of the transceiver is always available from our firmware update site.

To upgrade your transceiver, visit the **www.rfsquared.com** web site and click on "Get The Latest For Your OMNI-VII". A link will be available with the latest firmware version. This link will be titled with the date and the available version number of the firmware. Example: "02/02/07 OMNI-VII Firmware Version x.xxx Available For Download".

Connect the DB-9 serial port connector on the back of OMNI-VII to an open serial port on your computer with a standard serial port cable. From **www.rfsquared.com**, download the file. Note to which folder on your hard drive the file is being downloaded.

This file is an .exe executable. The executable file will have a set of step-by-step instructions (reproduced below). Go to the folder where you have downloaded the .exe file, and double click it to execute.

Here is the sequence of steps to follow once the .exe file has been downloaded from rfsquared.com:

- 1) Turn transceiver OFF.
- 2) Connect a PC to the transceiver using the appropriate cable.
- 3) Turn the transceiver ON while holding down the 0 button on the bandchange keypad. Wait for the display to indicate "Key Is Pressed"
- 4) Start the Update program
- 5) Select the COM port to which the transceiver is attached.
- 6) Choose UPDATE under the PROCESS menu.
- 7) Select the RUF file under the Process Menu.
- 8) The program will update the radio and report any errors encountered. During the update process the screen will indicate progress.

## **DIAGNOSTIC AND IP DATA ENTRY SCREEN**

Note that we recommend you use and familiarize yourself with transceiver operation before getting involved with parameter changes in this section.

In the initial screen on powering on the transceiver, you will see a rainbow test pattern screen and a WELCOME message.

There is a diagnostic screen that can be accessed for checking encoder functions, setting gateway and radio IP addresses for remote operation, UDP port, a password to prevent unauthorized users from gaining access to your radio remotely, and a MAC address.

To access the diagnostic screen – turn transceiver power off. Press and hold the RIT button. Turn power on, continuing to hold the RIT button down until KEY IS PRESSED appears on the screen with the

rainbow test pattern. Release the RIT button and KEY WAS PRESSED will appear, along with hexadecimal information on the right side of the screen.

Encoder function can be tested by turning the encoders. Each encoder (5 of them including the main tuning knob) are labeled A through E. Turn the main tuning knob ("E"). ENCODER E R or E L will appear depending on whether you have turned the encoder to the right or left. Hexidecimal information for each encoder will be shown to indicate the encoder is pulsing properly.

Press MNU while in the diagnostic screen. A WELCOME message will appear with a cursor, and five other lines for remote operation functions will appear: GATEWAY IP, RADIO IP, UDP PORT, PASS CODE, MAC ADDR.

The WELCOME message is a 10 position alphanumeric tag that can be used to display your callsign or other information. The blue cursor is moved by turning the main tuning knob. To adjust each character position, turn the MULTI knob.

GATEWAY IP, RADIO IP, UDP PORT, PASS CODE, and MAC ADR are explained in detail in the operation manual for the One Plug GUI remote control software.

To save any changes made, press the MNU button. To abandon any changes made, press any other button. Note "abandon" refers only to a highlighted item being adjusted and does not return all settings to the state they may have been in prior to entering the diagnostic screen.

After saving changes with MNU, to exit the diagnostic screen turn transceiver power off and then back on again.

After changes have been saved by pressing MNU, if you decide you want to make more changes before powering off the rig, press MNU again.

## **# SIGN ON THE SCREEN**

To the left of the A B C D bandstacking register indicators you will see a pound (#) sign occasionally turn on and off. This

indicates that your current settings have been stored in flash memory. This is to ensure when the transceiver is powered off that settings have been saved and will be retained when the transceiver is next turned on.

## TROUBLESHOOTING

While we cannot cover every possible problem, here are some hints for dealing with some potential difficulties. Check the obvious. Is your dc power source okay? Check power supply, cable and connector(s). Is the 25 ampere fuse loose or missing? Antenna problems? Try a dummy load. Is a proper antenna connected? Is any external antenna switch connected and properly set? Have you checked OMNI-VII's control settings? Have you double-checked OMNI-VII's many control settings, including those in the menu, for your intended mode of operation?

### **Problem: No audio from receiver**

Is the AUDIO (AF) turned up?

Is RF GAIN turned down (receiver will mute, and S-meter will read a higher value than band noise).

Is squelch activated? SQL will appear in block letters on the screen. Press the MULTI encoder to cycle through available choices and check SQUELCH level.

Is the speaker wire internal to the rig broken or disconnected? (have you pulled the covers off recently?) Try headphones to see if audio returns.

Is NR off? Under some circumstances, noise reduction can cover band noise completely, leading the user to think no audio is coming from the speaker.

### **Problem: Distorted SSB transmit**

Be certain the mic gain is set properly. The ALC LED should flash on voice peaks, but not remain continuously lit in SSB modes.

Check the setting of the speech processor. An excessively high setting can reduce audio quality.

A frequent cause of a distorted SSB signal is inadequate RF grounding resulting in RF feedback. Common RF grounding problems are no ground connection, or too long a lead to a good ground. Many problems relate to the lack of an RF station ground, as contrasted with a safety ground connection. We recommend bonding all equipment chassis together with short heavy metal braid or strap. Make these connections from chassis ground lug to chassis ground lug and connect the last piece in the chain feeding the antenna to a good earth ground. This lead needs to be as short as possible. Lengths near  $\frac{1}{4}$  wavelength on any band used can be particularly troublesome when the far end is connected to earth.

Another potential cause of distorted SSB arises when the station is in the near field of the antenna. This is a problem many apartment dwellers face.

Distorted SSB transmit can result from chassis ground and signal ground from the microphone being tied together to a common connection. This is a common problem with third-party microphones. Assure the chassis ground and signal ground from the microphone are separated.

### **Problem: Transceiver power shuts off while transmitting**

OMNI-VII is equipped with a silicon controlled rectifier that opens if current draw from the 13.8 Vdc power supply exceeds 25 amps. This SCR will shut off power to the transceiver. Excessive current draw can indicate a problem with excessive SWR due to antenna or feedline problems. Power to the radio can be restored by cycling the power switch and off or the 13.8 Vdc source on and off.

### **Problem: No transmit, receive OK.**

Check in the menu to assure TRANSMITTER is set to ON.

If KEYING LOOP is set to ON in the menu and the keying loop is either not in use or is making a faulty connection through

accessory equipment, the radio will not transmit.

Is the gain setting correct for the microphone input or ACC 1 jack as appropriate?

Is the POWER control turned all the way down? Press PWR and check.

If no transmit in digital modes, are you sure a PTT signal is being sent from your TNC or computer to the appropriate jack on the OMNI-VII?

Is OVER TEMP displayed on the radio screen? At a final amplifier temperature of 70 degrees C or higher, the radio will stop transmitting for a minimum of one minute. See **ON-SCREEN STATUS MESSAGING** elsewhere in this manual.

### **Problem: No operation in VOX**

Is "VOX" highlighted at the bottom of the screen? If not, VOX is turned off.

Check the OMNI-VII menu to see if the items for VOX are active and set properly. If any of the three settings is at zero, VOX will not operate.

The mic element in other (non-Ten-Tec) microphones must be active (open) when used in VOX mode with OMNI-VII. This generally means locking the PTT on the microphone after putting the radio into VOX mode – but every mic is different. Consult the operation manual of your microphone.

If the above do not solve your problem, please consult with our service department (865) 428-0364 or [service@tentec.com](mailto:service@tentec.com)

## Section 6 – SPECIFICATIONS AND TECHNICAL DATA

### SPECIFICATIONS

#### GENERAL

<b>Frequency Range RX:</b>	100 kHz – 30 MHz and 48 – 54 MHz. Specifications should apply within Amateur Radio bands only.
<b>Frequency Range TX:</b>	1.797-2.010, 3.495-4.005, 5.275-5.407, 6.995-7.305, 10.095-10.155, 13.995-14.352, 18.063-18.170, 20.995-21.452, 24.885-24.995, 27.995-29.702, 49.995-54.0 MHz.
<b>Tuning Step Sizes:</b>	1, 10, 100, 1k, 5k, 10k, and 100 kHz.
<b>Frequency Stability:</b>	Maximum +/- 0.5 PPM over operating temperature. TCXO standard.
<b>Rated RF Load:</b>	50 ohms nominal.
<b>Antenna Jacks:</b>	2 x SO-239 transceive, 1 x SO-239 receive only.
<b>Modes:</b>	USB, LSB, AM, FM, CWUSB, CWLSB, FSK.
<b>I-Fs:</b>	1 <sup>st</sup> : 70 MHz, 2 <sup>nd</sup> : 455 kHz, 3 <sup>rd</sup> : 14 kHz.
<b>NTIA Compliance:</b>	Meets requirements for frequency stability, not in compliance for occupied bandwidth.
<b>Display:</b>	STN transmissive color LCD display with CFL backlight, 320 x 240 pixels.
<b>PC control ports:</b>	Serial, EIA-232 standard, DB-9F. Integrated 10 mb/s Ethernet, CAT5 or CAT6, RJ-45.
<b>Supply Voltage:</b>	13.8 Vdc nominal. Reverse-polarity and over-voltage protection standard.
<b>Operating Temperature Range:</b>	0-50 degrees Celsius.
<b>Dimensions (HxWxD):</b>	5.0" x 12.0" x 14.75". Depth measurement includes rear panel heat sink.
<b>Weight:</b>	15.4 lbs. (7 kg).
<b>Construction:</b>	Aluminum chassis, steel cabinet, glass-epoxy printed-circuit boards.

#### RECEIVER

<b>SSB Sensitivity:</b>	<0.18 uV typical for 10 dB SINAD at 2.4 kHz BW, pre-amp on. <0.5 uV typical for 10 dB SINAD at 2.4 kHz BW, pre-amp off.
<b>AM Sensitivity:</b>	<2.5 uV for 10 dB SINAD at 6 kHz BW, 30% modulation, 1 kHz, pre-amp off.
<b>FM Sensitivity:</b>	<2.5 uV for 12 dB SINAD at 20 kHz BW, 3 kHz deviation, 1 kHz, pre-amp off.
<b>Selectivity, IF1:</b>	at 70 MHz, 20 kHz
<b>Selectivity, IF2:</b>	at 455 kHz, 20, 6, 2.5 kHz standard, 500 Hz, 300 Hz, optional.
<b>Selectivity, DSP IF:</b>	38 built-in DSP filters from 200-12000 Hz BW.

<b>IP3 (Third Order Intercept Point):</b>	+13 dBm at 20 kHz spacing, +8.5 dBm at 2 kHz spacing, optional 500 Hz I-F filter installed, 500 Hz DSP BW.
<b>IMD3 Dynamic Range:</b>	90 dB @ 20 kHz spacing, 2.5 kHz I-F filter. 78 dB @ 2 kHz spacing, optional 500 Hz I-F filter installed, 500 Hz DSP BW.
<b>Blocking Dynamic Range:</b>	135 dB at 20 kHz spacing, 2.5 kHz I-F filter. 130 dB at 2 kHz spacing with optional 500 Hz filter installed, 500 Hz DSP BW.
<b>LO Phase Noise:</b>	-125 dBc/Hz @ 10 kHz, -121 dBc/Hz @ 2 kHz
<b>Image Rejection:</b>	> 70 dB.
<b>IF Rejection:</b>	> 70 dB.
<b>Other Spurious Response Rejection:</b>	> 90 dB, F>1 MHz.
<b>RIT/XIT Range:</b>	+/- 8.2 kHz
<b>S-meter Reference:</b>	S9 = 50 uV RMS
<b>TX &gt; RX Recovery Time:</b>	< 20 ms.
<b>RX Audio Equalizer:</b>	Bass/treble boost/cut up to 6 dB/octave.
<b>RX Audio Output:</b>	2W into 4 ohms, <3% THD
<b>RX Headphone Output:</b>	Designed for 16-32 ohms impedance headphones. Usable at 8 ohms.
<b>AUX Audio Output:</b>	500 mv
<b>RX Notch Filter:</b>	IF DSP, > 50 dB depth, adjustable width.
<b>Auto Notch:</b>	IF DSP, multi-tone, adjustable.
<b>RX Noise Reduction:</b>	IF DSP, adjustable.
<b>Noise Blanker:</b>	IF DSP, adjustable

## **TRANSMITTER**

<b>Power Output:</b>	Adjustable, 5-100 W, +/- 1 dB.
<b>CW &amp; SSB Duty Cycle:</b>	continuous service @ 100W
<b>AM, FM, AFSK, FSK, PSK Duty Cycle:</b>	continuous with cooling fan accessory
<b>Microphone Input Impedance:</b>	>10 k-ohms at 1 kHz.
<b>Microphone Sensitivity:</b>	1 mV RMS for full power output, internal gain adjustment, dc power for electret elements.
<b>AUX Level Input:</b>	200 mv RMS nominal for 100 W, set to 50% independent of mic gain.
<b>Speech Processor:</b>	RF compression, 0-9 adjustment.
<b>TX Bandwidth:</b>	1000-4000 Hz in 200 Hz steps plus 2500 Hz – 17 total steps.
<b>TX Frequency Response:</b>	70-4000 Hz maximum @ 6 dB points, adjustable.
<b>TX Speech Monitor:</b>	Modulated IF after filtering, processing.
<b>SSB Carrier Suppression:</b>	> 50 dB.
<b>Unwanted Sideband Suppression:</b>	> 60 dB at 1 kHz.
<b>Harmonic &amp; Spurious Outputs:</b>	> 50 dB below 100 W; > 43 dB below 5 W.
<b>T/R Switching:</b>	PTT or VOX on SSB, AM, FM, FSK. Adjustable QSK on CW.

**CW Keyer Speed Range:** 5-63 WPM, adjustable weighting.

**CW Rise & Fall Times:** Adjustable 3-10 ms.

**CW Offset:** Programmable 100-1270 Hz in 10 Hz steps. Sidetone pitch automatically matches selected CW offset.

**FM Deviation:** +/- 5 kHz peak nominal.

**Current Drain:** 25 A max. @ 100 W output.

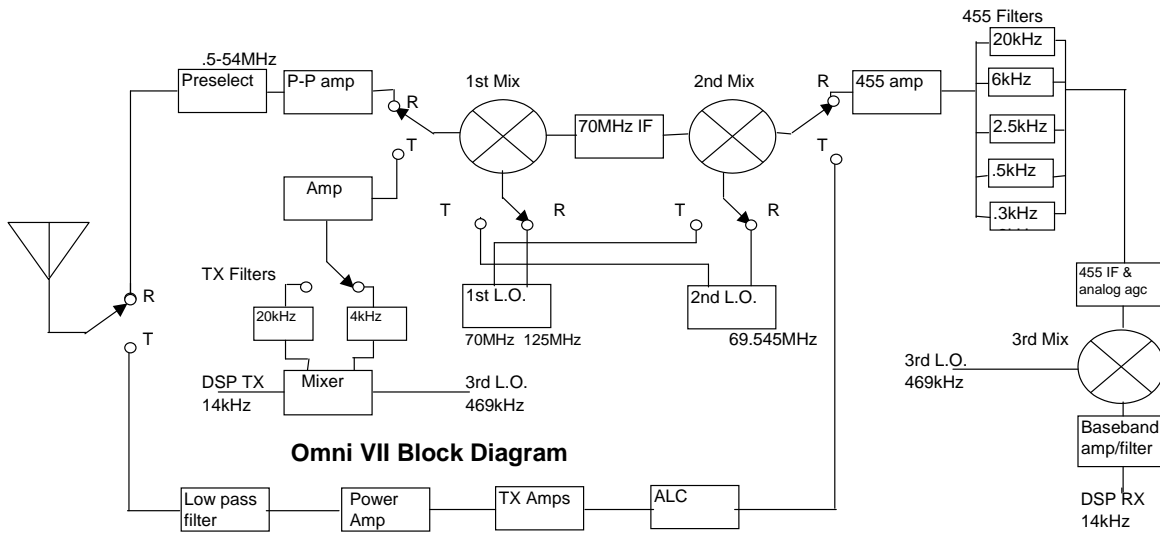

Figure 6-1 OMNI-VII Block Diagram