

INSTRUCTION MANUAL FV-102DM

*This Manual Provided
Courtesy of Greg White, VA3VFO
va3vfo@rac.ca*

YAESU MUSEN CO., LTD.
C.P.O. BOX 1500
TOKYO, JAPAN

TABLE CONTENTS

	(Page)
GENERAL	1
FRONT PANEL CONTROLS AND SWITCHES	2
REAR PANEL CONNECTIONS	4
INSTALLATION	5
OPERATION	6
SPECIFICATIONS	13
SEMICONDUCTOR COMPLEMENT	13
PARTS LIST	14

*This Manual Provided
Courtesy of Greg White, VA3VFO
va3vfo@rac.ca*

FV-102DM DIGITAL MEMORY VFO FOR FT-102



GENERAL DESCRIPTION

The FV-102DM is specifically designed for use with the FT-102 transceiver, providing the wide assortment of frequency control features made possible by modern digital frequency synthesis techniques and a CPU developed especially for FV-102DM. The VFO dial incorporates an accurate photo-interrupter rotary encoder system using an extremely simple mechanism to provide outstanding reliability even under punishing conditions. The dial tunes the PLL synthesizer in smooth 10 Hz steps at four possible tuning rates selected both manually and automatically by the speed at which the dial is rotated. Once the band for operation had been selected by the FT-102, the FV-102DM allows tuning by dial, scanner, keyboard or memory to 100 kHz beyond the band edges for transmit, receive, transceive or clarifier operation.

A dual function seventeen-button keyboard on the front panel of the FV-102DM allows pushbutton frequency entry, as well as plus or minus 5 kHz or 20 kHz stepping, four-speed frequency scanning, electronic frequency lock, last digit blanking and clarifier operation. Six additional keys are provided for convenient receive and transmit frequency source selection of the FT-102 VFO, the FV-102DM dial, or one of the FV-102DM memories; and six LED indicators show the selected operating frequency scheme at a glance.

Twelve memory channels are available for storing frequencies entered from the keyboard, or tuned on either the FT-102 VFO or FV-102DM dial, with just the touch of a button, so all manner of split operation is a breeze; while the contester, DXer and net operator can be present on twelve different frequencies almost at once. The FV-101DM includes an internal battery holder for retaining stored memories when the equipment is turned off or the power source disconnected.

The five-digit fluorescent display indicates kilohertz with resolution to 10 Hz, or to 100 Hz if the last digit is blanked. Scanning can be controlled either from the front panel of the FV-102DM or from the microphone connected to the FT-102 (when a scanning microphone is used). All connections for the FV-102DM are made through two interconnecting cables to the FT-102, and parallel jacks are provided on the rear of the FV-102DM for easy system expansion.

Users are encouraged to study this manual carefully in order to become familiar with the many exciting functions of the FV-102DM, and to be able to fully utilize the vast operating flexibility that the FV-102DM offers to the FT-102 station.

*This Manual Provided
Courtesy of Greg White. VA3VFO
va3vfo@rac.ca*

FRONT PANEL CONTROLS AND SWITCHES

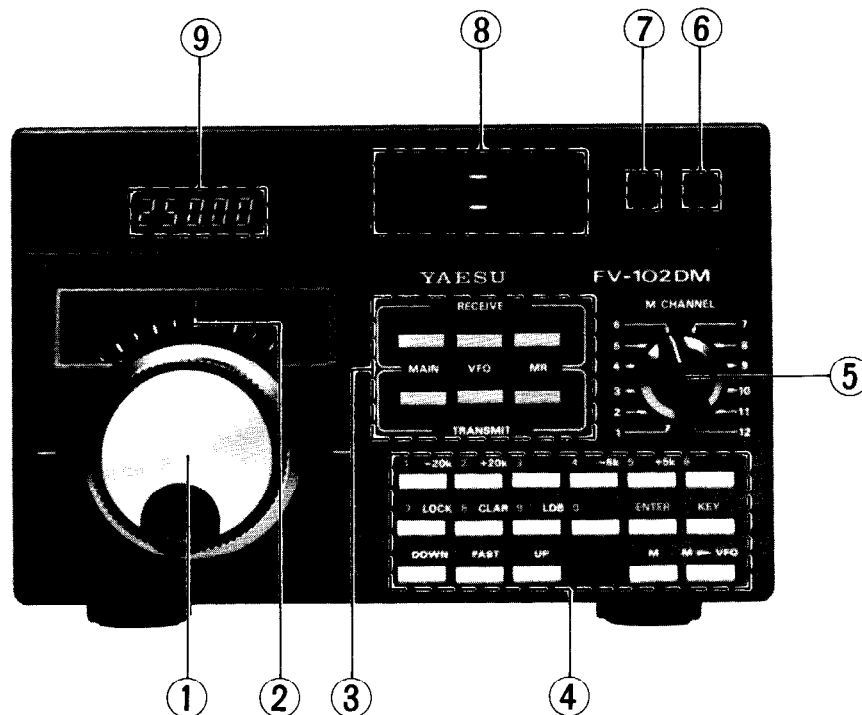

(1) TUNING KNOB

This knob allows conventional tuning of the FV-102DM dial frequency at four possible tuning rates. The finest rate is 4 kHz/turn, in which case each division on the analog scale represents 100 Hz. The VFO tunes at this rate for the first two seconds of continuous rotation of the knob, after which the tuning rate automatically doubles to 8 kHz/turn for as long as the knob is rotated in one direction without interruption.

For much faster tuning with this knob, the FAST key may be depressed at the same time as the knob is rotated. This will multiply the normal tuning rate by a factor of 10, resulting in 40 kHz/turn for the first two seconds, and 80 kHz/turn thereafter, as described above. If the tuning knob is rotated beyond the upper or lower edge of the normal 500 kHz range of the FT-102, the FV-102DM will continue to tune for 100 additional kHz and then loop around to the opposite band edge in one jump. For example, on the 14 MHz band, the tuning knob will tune up to 14.6000 MHz and then the frequency will jump to 13.9000 MHz.

(2) ANALOG DIAL

This lighted scale is directly coupled to the tuning knob. One of the 40 divisions may be aligned with 100 kHz digit simply by setting the dial so that one division is aligned with the orange pointer, and then programming a frequency from the keyboard that is a multiple of 100 kHz. Manual calibration is not necessary.

(3) RECEIVE/TRANSMIT Switches

These six two-position push button switches are used to select the source of the receive and transmit frequencies. The two (upper and lower) MAIN buttons select the FT-102 VFO, the two VFO buttons select the FV-102DM VFO dial register and the two MR buttons select the FV-102DM memory (determined by the M CHANNEL Selector). The upper three buttons select the receive frequency and the lower three select the transmit frequency source.

*This Manual Provided
Courtesy of Greg White, VA3VFO
va3vfo@rac.ca*

(4) KEYBOARD

Most of these seventeen momentary-contact switch keys have dual functions, with one function indicated with yellow labelling above the key, and the other indicated with white labelling. The FV-102DM contains a tone beeper, which will sound to acknowledge a command input from the keyboard (except for scanning commands from the DOWN, FAST, and UP keys).

(A) YELLOW FUNCTIONS

The yellow labelling of the upper two rows of keys includes the numbers 1 through 9 and 0, ENTER and KEY. These last two control the keyboard shift function: press KEY to activate the yellow key functions (for numerical frequency programming), and press ENTER to transfer the new (displayed) frequency into the VFO or selected memory, and/or to return control to the white functions. Whenever a VFO digit is blinking the yellow functions are active and the white functions are disabled.

(B) WHITE FUNCTIONS

The -20k, +20k, -5k and +5k keys are used to step the displayed frequency up or down 5 or 20 kHz. The LOCK key electronically disables the tuning knob and the DOWN, FAST, and UP scanning control buttons. The CLAR key activates the clarifier function (for receive only), which can then be adjusted by the tuning knob or scanning control buttons, while all other keys are disabled (except M and M ► VFO as described later). The LDB key blanks the last (10 Hz) digit on the VFO display. This does not cause a shift in frequency or synthesizer step, but can cause up to 100 Hz variance between the FT-102 display and the FV-102DM display. The M key transfers the operating frequency into the selected memory channel, and the M ► VFO key transfers the selected memory into the VFO dial register.

The DOWN, FAST and UP scanning control keys allow scanning at four different rates: when just the DOWN or UP key is pressed the frequency will change at 1 kHz/sec for the first two seconds, and then at

about 1.5 kHz/sec for as long as the key is held in. If the FAST key is pressed at the same time, the scanning rate will be 10 kHz/sec and then about 15 kHz/sec after two seconds.

(5) M CHANNEL

This twelve position rotary switch selects the memory channel. All memory channels are linked to the band selected by the FT-102 in such a way that, if the band is changed from one in the 0 to 500 kHz range to one in the 500 kHz to +1 MHz range, 500 kHz will be automatically added to all memory frequencies (as well as the dial register).

(6) LOCK LED

This indicator is lit whenever the LOCK function is active, indicating that the tuning knob and scanning controls are disabled.

(7) CLAR LED

This indicator is lit whenever the CLAR function is active, indicating that only the tuning knob and scanning controls are not disabled.

(8) RECEIVE/TRANSMIT LEDs

These six LEDs indicate the operating frequency sources selected for each function by the RECEIVE/TRANSMIT buttons.

(9) DIGITAL DISPLAY

This five-digit fluorescent display indicates operating frequency of the FV-102DM when it is used as a frequency source, or the selected memory frequency when the FT-102 internal VFO is used as the frequency source. Digits include 10 Hz (or 100 Hz if last digit blanked) through 100 kHz, with the decimal indicating kHz.

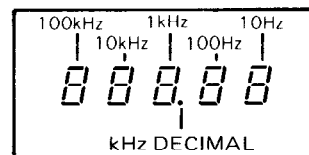

*This Manual Provided
Courtesy of Greg White, VA3VFO
va3vfo@rac.ca*

REAR PANEL CONNECTIONS

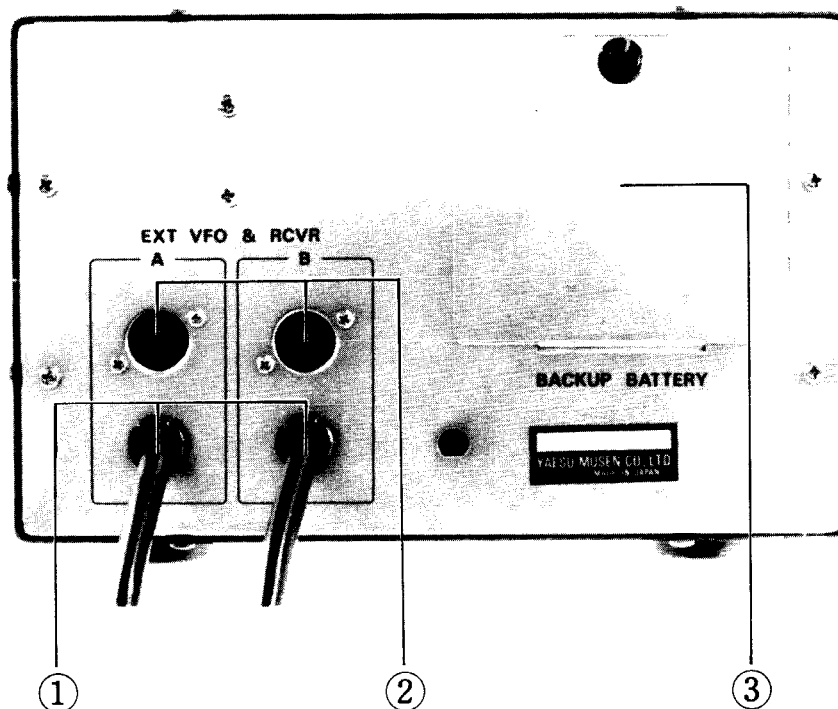

(1) Cables with DIN Plugs

These two cables are for connecting the FV-102DM to the FT-102. The 8-pin "A" plug connects to the EXT VFO & RCVR "A" jack on the FT-102, and the 7-pin "B" plug connects to the corresponding "B" jack.

(2) DIN Jacks A and B

These jacks provide parallel connections to those signal lines delivered to the FV-102DM from the FT-102, and can be used for connecting additional equipment.

(3) BACKUP BATTERY (Panel)

By releasing the plastic Nyloc pin, this panel can be removed to access the backup battery compartment. Install two AA size batteries in the direction indicated on the battery holder, if memory retention is desired. Without the batteries installed, the FV-102DM will retain the memory information for about 30 seconds once power is switched off or disconnected, after which the memories will all reset to 000.00 or 500.00 according to the band selected by the FT-102.

FV-102DM MEMORY BACKUP

The memories stored in the FV-102DM may be retained when the transceiver is switched off or the line voltage supply is interrupted simply by installing two AA size batteries. Remove the small access panel on the rear of the FV-102DM by disengaging the latch pin, and install the batteries as illustrated on the battery holder, paying particular attention to polarity. Although the memory backup current is only 10 μ A, we recommend that the batteries be replaced every six months to avoid leakage and possible damage.

Note: In certain circumstances, after installation of the backup batteries, the memory functions of the FV-102DM may fail to operate correctly. This can be easily remedied by the following steps:

1. Switch the power to the FT-102 off, and disconnect the cable from EXT VFO/RCVR jack A (8-pins).
2. Remove the backup batteries from the compartment of the FV-102DM.
3. Wait about 30 seconds.
4. Replace the backup batteries into the compartment, reconnect the cable to jack A, and switch the FT-102 back on.

INSTALLATION

Because of the outstanding frequency control flexibility offered by the FV-102DM, we recommend that it be used for all VFO operation when connected to the FT-102. We suggest that the FV-102DM be located to the right of the FT-102 for right-handed operators, and to the left for left-handed operators. The FV-102DM should never be placed directly on top of the FT-102 or any other heat-generating device.

Before connecting the cables from the FV-102DM to the FT-102, turn the POWER switch on the FT-102 OFF. Connect the 8-pin plug to jack "A", and the 7-pin plug to jack "B" on the FT-102.

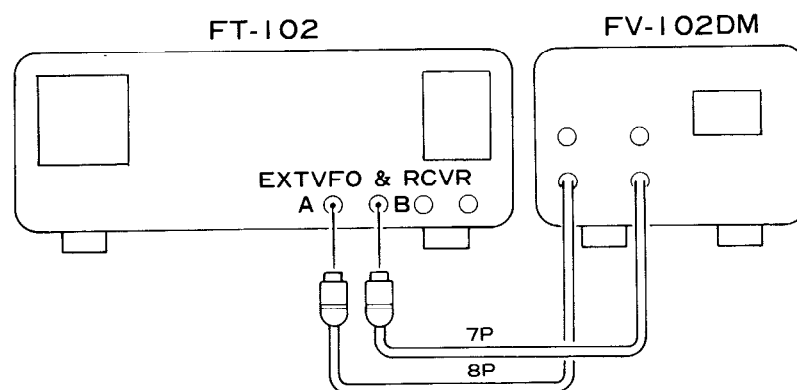

*This Manual Provided
Courtesy of Greg White, VA3VFO
va3vfo@rac.ca*

OPERATION

While the basic operation of the FV-102DM in conjunction with the FT-102 is fairly simple, there are some advanced operating techniques that will also prove useful. However, we recommend that the operator become thoroughly familiar with the basic operation first, and then study the advanced techniques, rather than attempt random experimentation, as misuse of some of functions can cause transmissions to occur on unexpected or illegal frequencies.

The FV-101DM contains thirteen registers of RAM (random-access memory), twelve for the memory channels and one VFO dial register (accessed by the VFO select switches). A fourteenth temporary register is used for keyboard frequency entry and clarifier operation, but this register is not available for transmission, nor is it preserved by the backup batteries (as are the other thirteen). Each register holds five digits of frequency data whether or not the last digit is blanked on the display. The 100 kHz digit is automatically shifted up or down 500 kHz according the band selected by the FT-102 and 0.7 kHz is automatically added when the FT-102 is switched to the CW or TUNE modes. When one of the register frequencies is displayed on the FT-102 display, the 10 Hz digit is rounded up or down to the nearest 100 Hz, even if the last digit is blanked on the FV-102DM.

BASIC OPERATION

The accompanying charts should help to familiarize the reader with the basic operation of the receive/transmit select switches and the interaction of the registers and displays. For these examples the FT-102 has its BAND selector set to 21 MHz and its internal VFO tuned to 21.102.0 in an SSB mode. Switch the FT-102 POWER switch ON, and depress the upper and lower MAIN buttons on the FV-102DM. Notice that the FV-102DM display shows 000.00, while the FT-102 indicates normally (Case A). The FV-102DM is displaying the frequency of the MEMORY channel to which the M CHANNEL selector is set, and if no frequency has been previously stored, or if backup batteries are not installed, it will read zero (or 500.00 on bands with 0.5 MHz offset and plus 0.7 kHz in the CW and TUNE modes). Remember though; whenever both MAIN buttons are depressed frequency control is entirely by the FT-102 internal VFO, and the FV-102DM will display the memory channel selected by the M CHANNEL selector.





		A	B	C
RX/TX PUSH BUTTONS (and LEDs) depressed (LED ON)		RECEIVE MAIN VFO MR TRANSMIT	RECEIVE MAIN VFO MR TRANSMIT	RECEIVE MAIN VFO MR TRANSMIT
RECEIVE	FT-102 DISPLAY	21.102.0 FT-102 (VFO)	21.123.4 FV-102DM (VFO)	21.000.0 FV-102DM (MEMORY)
	FV-102DM DISPLAY	000.00 FV-102DM (MEMORY)	123.45 FV-102DM (VFO)	000.00 FV-102DM (MEMORY)
TRANSMIT	FT-102 DISPLAY	21.102.0 FT-102 (VFO)	21.123.4 FV-102DM (VFO)	21.000.0 FV-102DM (MEMORY)
	FV-102DM DISPLAY	000.00 FV-102DM (MEMORY)	123.45 FV-102DM (VFO)	000.00 FV-102DM (MEMORY)

Now press the upper and lower VFO buttons and rotate the tuning knob on the FV-102DM until its display indicates 123.45 (Case B). Press the FAST key while rotating the tuning knob for quick tuning. Notice that the FT-102 display shows the same frequency plus the MHz figures but less the 10 Hz digit. Rock the FV-102DM tuning dial back and forth slightly and notice that the 10 Hz digit is rounded either up or down on the FT-102 display. The FT-102 and FV-102DM displays will always coincide in this manner when the VFO button is pressed for the operating function (receive or transmit) in use.

Next press the upper and lower MR buttons on the FV-102DM. Now both displays show the memory frequency (Case C). Set the M CHANNEL selector to position 1, and press the +20k key five times. This frequency (100.00 kHz) is now programmed into memory channel 1. Again, the FT-102 display matches the FV-102DM display, as above.

Basic split-frequency operation can be performed in six different ways, each of which is illustrated in Cases D through I on the chart. Notice that Cases D through G involve use of both the FT-102 internal VFO and the FV-102DM, while Cases H and I show split operation with frequency control solely via the FV-102DM. Each case has certain advantages in a particular operating situation, and some of these will be detailed later in operating examples. The operator is encouraged to try each case in his own operations to determine which are the most convenient for his particular needs.

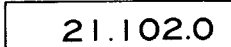
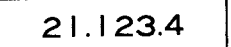
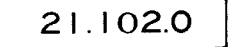
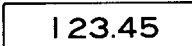
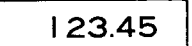
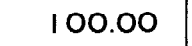
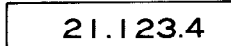
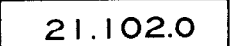
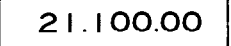
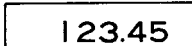
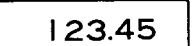
*This Manual Provided
Courtesy of Greg White, VA3VFO
va3vfo@rac.ca*

	D	E	F
	RECEIVE  TRANSMIT	RECEIVE  TRANSMIT	RECEIVE  TRANSMIT
RX	 FT-102 (VFO)	 FV-102DM (VFO)	 FT-102 (VFO)
	 FV-102DM (VFO)	 FV-102DM (VFO)	 FV-102DM (MEMORY)
TX	 FV-102DM (VFO)	 FT-102 (VFO)	 FV-102DM (MEMORY)
	 FV-102DM (VFO)	 FV-102DM (VFO)	 FV-102DM (MEMORY)

FREQUENCY PROGRAMMING FROM THE KEYBOARD

If you encounter difficulties with the keyboard functions while gaining experience with the operation of the FV-102DM, such as the inability to enter certain commands, check to make sure that the CLAR and LOCK LEDs are both OFF, as each function disables certain other functions on the keyboard. Also, since some keys serve dual functions, please review the white and yellow function descriptions in part (4) of the Front Panel Controls and Switches Section of this manual if this becomes unclear.

The yellow lettered functions of the keyboard are used for direct frequency programming into any of the thirteen registers. When programming from the keyboard, it is not necessary to reprogram every digit of the new frequency, but only those digits that are to be changed.

Depress either the RECEIVE VFO or MR button on the FV-102DM, depending on which (VFO dial or a memory) register you wish to program. The display will now show the contents of the selected register. Press KEY, and the 100 kHz digit will begin to blink, signifying that it is now ready to be changed. Now press the key just below the yellow number that you wish to program in the 100 kHz position, unless you do not intend to change this digit, in which case just press KEY again. Notice that the 10 kHz digit will now begin to blink. Again program the new number for the 10 kHz position, or again press KEY, and the 1 kHz digit will begin to blink. This process may be repeated for each digit down to 10 Hz, or you may stop whenever the displayed frequency matches that which you wish to program (regardless of which digit is blinking). Whenever one of the digits is blinking, the displayed frequency is being held in the temporary fourteenth register and thus it is not available for operation. To pass the contents of the fourteenth register into the VFO dial register (when the RECEIVE VFO button is depressed), or into the memory channel selected by the M CHANNEL selector (when the RECEIVE MR button is depressed), simply press the ENTER key.

*This Manual Provided
Courtesy of Greg White, VA3VFO
va3vfo@rac.ca*

		G	H	I
		RECEIVE 	RECEIVE 	RECEIVE
RX	FT-102 DISPLAY	21.100.0 FV-102DM (MEMORY)	21.123.4 FV-102DM (VFO)	21.100.0 FV-102DM (MEMORY)
	FV-102DM DISPLAY	100.00 FV-102DM (MEMORY)	123.45 FV-102DM (VFO)	100.00 FV-102DM (MEMORY)
TX	FT-102 DISPLAY	21.102.0 FT-102 (VFO)	21.100.0 FV-102DM (MEMORY)	21.123.4 FV-102DM (VFO)
	FV-102DM DISPLAY	100.00 FV-102DM (MEMORY)	100.00 FV-102DM (MEMORY)	123.45 FV-102DM (VFO)

ILLEGAL FREQUENCY ENTRY

The memory and VFO dial registers are protected from frequencies that are outside of the operating capability of the FT-102, but the fourteenth register is not. So, for example, if you are on the 21 MHz band and you attempt to program 899.99 kHz into the FV-102DM, pressing the ENTER key will cause the displayed frequency to return to its original contents (before the illegal attempt), and the 100 kHz digit will blink, signifying that the illegal contents of the fourteenth register has been dumped. Note that all tuning functions on the FV-102DM are disabled as long as a display digit is blinking. A new frequency should now be programmed (from the keyboard), or the ENTER key pressed again to return to the original frequency. Do not operate the transceiver until the ENTER key is pressed and all digits cease to blink.

FT-102 BAND	FV-102DM TUNING RANGE
★ 1.8 MHz	1.4 – 2.1 MHz
★ 3.5 MHz	3.4 – 4.1 MHz
○ 7 MHz	6.9 – 7.6 MHz
○ 10 MHz	9.9 – 10.6 MHz
○ 14 MHz	13.9 – 14.6 MHz
○ 18 MHz	17.9 – 18.6 MHz
○ 21 MHz	20.9 – 21.6 MHz
★ 24.5 MHz	24.4 – 25.1 MHz
○ 28.0 MHz	27.9 – 28.6 MHz
★ 28.5 MHz	28.4 – 29.1 MHz
○ 29.0 MHz	28.9 – 29.6 MHz
★ 29.5 MHz	29.4 – 30.1 MHz

★ 500 kHz added to all FV-102DM registers

*This Manual Provided
Courtesy of Greg White, VA3VFO
va3vfo@rac.ca*

MEMORY PROGRAMMING FROM THE VFO AND FT-102

Perhaps the most common situation that occurs during most types of operation where the memory facility is especially useful is when you are tuning across the band and suddenly need to store in memory the frequency to which you have tuned. When using the FT-102 internal VFO or the FV-102DM VFO dial register (RECEIVE VFO button depressed), you can store the receive frequency in the memory channel selected by M CHANNEL simply by pressing the M key on the FV-102DM.

MEMORY RECALL

From case A at the beginning of the Operation Section, you will recall that, when the FT-102 internal VFO is being used to control the operating frequency, the FV-102DM will display the contents of the memory selected by the M CHANNEL selector. This feature allows checking of the contents of each memory channel while operating on another frequency without interruption. To recall one of the memory frequencies for operation, simply press the MR button for the mode (transmit or receive) for which the memory is to be used. Notice that when receiving on the FT-102 and transmitting on the memory channel, the FT-102 will display the receive frequency only during reception, while the FV-102DM will display the transmit frequency at all times.

When using the VFO dial register for frequency control from the FV-102DM, the selected memory frequency can be recalled onto the dial by pressing the M▶VFO key. However, this will erase the previous frequency from the dial register. To retain the dial register frequency the operator should first set the M CHANNEL selector to an available channel and press the M key. Then switch to the channel to be recalled and press M▶VFO. To check the contents of the memory channels when operating on the VFO dial it is necessary to depress either the RECEIVE MR or MAIN button. Then rotate the M CHANNEL selector to the desired memory, and then press the RECEIVE (or TRANSMIT) VFO button to return to your original frequency. Another technique for checking memory contents will be covered in the Advanced Operating Techniques Section.

SCANNING AND STEPPING

When using the FV-102DM VFO dial register for receive frequency control, scanning can be accomplished using the DOWN, FAST, and up keys on the FV-102DM, or by the scanning buttons on the microphone, if so equipped. Frequency stepping via the 20k and 5k keys can be accomplished when either the dial register or a memory register is being used for receiving control. The stepping keys can also change the operating frequency during transmission, but we recommend that no attempt be made to change transmitting frequency in this fashion, since it is likely to cause interference to other stations and perhaps transmission outside of the authorized frequency range, not to mention possible overloading and destruction of the transmitter circuitry. You can, however, use the stepping keys to change VFO dial frequency or the selected memory frequency when control of the receive frequency is by the FT-102 internal VFO (RECEIVE MAIN button depressed), and you are in the receive mode, as shown in Cases D and F.

CLARIFIER

Press the CLAR key to activate the clarifier when receiving using the FV-102DM VFO dial register or a memory register. Only the tuning knob and scanning controls can be used to change the clarifier frequency, and it is not possible to store a frequency tuned during clarifier operation. However, the clarifier function is very useful when you need to return to the original frequency quickly, as any clarifier offset is cancelled when the CLAR key is pressed a second time (extinguishing the CLAR LED). Do not use the clarifier function for transmitting, except as described in the Advanced Operating Techniques. Use the TX clarifier on the FT-102.

*This Manual Provided
Courtesy of Greg White, VA3VFO
va3vfo@rac.ca*

PRACTICAL OPERATING EXAMPLES

1. You are operating on 40 meter SSB, listening for DX between 7050 and 7100 kHz, while transmitting above 7150 kHz (operators outside the USA should reverse the preceding). Station DX1DX is heard on 7095 kHz, listening at 7205 kHz.

Proceed as follows:

If you are tuning on the FT-102 internal VFO, press the TRANSMIT VFO button on the FV-102DM. Also on the FV-102DM, press KEY and then 2, 0, 5, 0 and 0. Now press ENTER and you are ready to transmit.

If you were tuning initially on the FV-102DM VFO, store DX1DX's frequency in a memory by pushing the M key. Now press KEY, and then 2, 0, and ENTER. You need not enter the other digits, since they will not be changed. Finally press RECEIVE MR and TRANSMIT VFO. To listen to the pile-up calling DX1DX on 7205 kHz, just press the RECEIVE VFO button. Should DX1DX drift in frequency, press the CLAR button and tune the dial to follow his signal.

2. You are net control station for a net meeting on 14315 kHz. Stations call into the net, then are moved off frequency to pass traffic. Prior to the start of the net, store typical QSY frequencies (14280, 14285, 14290, 14295, etc.) in the FV-102DM memories. The net control station may then quickly determine whether or not a particular frequency is clear by pressing the RECEIVE MR button and rotating the M CHANNEL selector through the various QSY frequencies.
3. You are operating in a DX contest (tuning with the FT-102 VFO), where a number of desired stations are on the band at the same time. If some of them do not respond immediately to your call, or if they are not acknowledging your call area, store them in the FV-102DM memory by simply pressing M with the M CHANNEL selector in the desired position. To return to these stations later just press the RECEIVE MR button. Your total exposure on the band is thus increased. Note that, even though a

band change is made in the meantime the memorized frequencies remain valid upon return to the band on which they were stored.

ADVANCED OPERATING TECHNIQUES

Once the basic operation of the FV-102DM is clearly understood, the operator is encouraged to study the following techniques to enhance his operating convenience and enjoyment still further. At the end of this section, several operating examples will be used to help the operator gain some practical experience with these techniques. However, it is not practical for this manual to attempt to cover all possible applications of these techniques, and thus the operator may wish to review this section several times in order to determine how to best use them in his operation.

ALTERNATE REGISTER CHECK

When the receiver is being tuned by the VFO dial register it is possible to check the contents of each of the memory registers via the keyboard. Simply press the CLAR key, and then press and release the M key (for a momentary check), or press and hold the M▶VFO key while rotating the M CHANNEL selector.

Conversely, when receiving on a memory channel it is possible to check the contents of the VFO dial register via the keyboard. Again, press the CLAR key, only this time press and release the M▶VFO key (for a momentary check), or press and hold the M key.

When receiving on the MAIN (FT-102 internal) VFO and transmitting on the same (or any of the FV-102DM registers) this technique can also be used to check the alternate register, but should only be done while receiving. These techniques can only be used when the clarifier function is activated but clarifier offset will not be cancelled.

MEMORY JUMPING

The fourteenth (temporary) register may be used in several ways to program frequencies other than the operating frequency without interrupting operation on that frequency, even during split frequency operation. For instance, if transmitting and receiving on the MAIN and/or VFO dial register

(or operating split with both of them), it is possible to program a third frequency into a memory channel. Press KEY and program the new frequency using the numerical keys. Now, do not press ENTER, but rather press the M key. The FV-102DM display will cease blinking and revert to the original operating frequency, while the programmed frequency will now be held in the selected memory channel.

Another way that this type of programming can be accomplished is when operation is being controlled partially or wholly by a memory channel, and the operator wishes to program a new frequency into the VFO dial register without disturbing operation. Again press KEY and program the new frequency using the numerical keys. In this case, instead of pressing the ENTER or M keys, press the M▶VFO key. Again the FV-102DM display will revert to the original operating frequency, while the new frequency will be found in the VFO dial register.

A similar technique can be used to transfer the contents of one memory into another, but not when the VFO dial register is being used for operation. Set the M CHANNEL selector to the channel whose frequency is to be transferred, and press KEY. Now rotate the M CHANNEL selector to the new channel position, and press M. The VFO dial register will not be affected.

CLARIFIER SPLIT-FREQUENCY OPERATION

Because the offset range of the clarifier function includes the entire tuning range of the VFO, this function can be very convenient for split operation. Either a memory channel or the VFO dial register may be used to tune the transmit frequency. Just press the CLAR button and tune to the desired receive frequency using the tuning knob or scanning controls (the stepping functions are disabled).

*This Manual Provided
Courtesy of Greg White, VA3VFO
va3vfo@rac.ca*

ADVANCED OPERATING EXAMPLES

The following examples are intended to serve as a small sample of the many possible applications of the Advanced Operating Techniques. Once the operator is thoroughly familiar with the FV-102DM, he will undoubtedly discover additional applications to fit his own operating preferences.

1. You are chasing DX and hear DX1DX on 7095 kHz, listening at 7205 kHz as in the earlier operating example. You are tuning on the FV-102DM VFO dial register.

Proceed as follows:

With the M CHANNEL set to position 1, press M to store his transmit frequency. Now press the +5k key twice and the +20k key five times, and then press the RECEIVE MR button (and the TRANSMIT VFO button, if not already depressed). You are now ready to transmit.

Press the CLAR key, and then press and hold the M key to check activity on 7205 kHz. While holding the M key you can tune the knob around 7205 to listen around your transmit frequency, but your frequency during transmission will remain 7205 kHz regardless of where you tune.

Let us assume that you hear your old friend W6QRM having an interesting conversation on 7210 kHz while another station is working DX1DX, and then back on 7095 you hear DX1DX say he is going to QRX for 30 minutes. To save the frequency data for DX1DX while talking to your friend, rotate the M CHANNEL selector to position 2, press the RECEIVE VFO button, then press the M key (the CLAR key must be pressed first to turn off the clarifier). Now tune in W6QRM on 7210 and give him a call. If W6QRM says he is waiting for DX2DX, who will call him on 7080 kHz, you can simply activate the clarifier and tune down to 7080. Your transmit frequency will remain 7210 kHz.

To make a momentary check for DX1DX without interrupting your QSO, just set the M CHANNEL selector back to position 1, activate the clarifier function, and press

M ► VFO. This allows you to check 7095 kHz for as long as you hold the M ► VFO key in. To return to DX1DX, key the clarifier off, set M CHANNEL to position 2, press M ► VFO, set M CHANNEL back to position 1, and press RECEIVE MR.

2. You are net control for the 14315 kHz net, and wish to program the QSY frequencies as in the earlier, similar example. With both the RECEIVE and TRANSMIT VFO buttons depressed, press KEY and key in 315.00 kHz, and then ENTER. Set the M CHANNEL selector to position 1, and then press KEY again. Now change those digits required for the QSY frequency, and press M without pressing ENTER. Next rotate M CHANNEL to position 2, press KEY, change the appropriate digits, and again press M without pressing ENTER. In each case, the frequency entered from the keyboard will be stored in the selected memory channel without affecting the VFO dial register.

To check the QSY frequencies during the net, simply activate the clarifier and then press M ► VFO. You may transmit on the QSY frequency while holding the M ► VFO key. It is a good idea to activate the LOCK as well, to protect your net frequency from inadvertent change.

3. You and a friend have decided to make the top score in a contest in the single transmitter multi-op category, using the FT-102 and the FV-102DM. Your friend is at the microphone and logging, and you are stationed at the FV-102DM. You give him control via the FT-102 VFO by pressing the RECEIVE and TRANSMIT MAIN buttons, and then store those frequencies where he does not make contact by rotating the M CHANNEL selector and pressing the M key. When ready to check the memories, press the RECEIVE MR button, and TRANSMIT MR button if you decide to call on the memory frequency. If your friend becomes too busy logging or tired to do the tuning, push the RECEIVE and TRANSMIT VFO buttons to take over tuning duties while he logs or rests.

*This Manual Provided
Courtesy of Greg White, VA3VFO
va3vfo@rac.ca*

SPECIFICATIONS

Output Frequency Range:

5.6 – 4.9 MHz, in 10 Hz steps

Output Level:

150 mVrms at 50 ohms

Output Impedance:

50 ohms

Frequency Stability:

$\pm 2 \times 10^{-5}$ (± 120 Hz) from 0° — 50°C

Power Requirements:

0.7A at 13.8V DC (supplied from FT-102)

Backup Current:

10 μ A

Dimensions (WHD):

200 x 129 x 309 mm

Weight:

2.5 kg

Specifications subject to change without notice or obligation.

*This Manual Provided Courtesy
of Greg White, VA3VFO
va3vfo@rac.ca*

SEMICONDUCTORS

ICs:

MC14011B	3 pcs	MC14013B	1 pc
MC14016B	2 pcs	MC14093B	1 pc
MC14077B	1 pc	MC14194B	1 pc
MC14518B	2 pcs	MC14519B	2 pcs
MC14584B	3 pcs	TC5032P	1 pc
TC5066BP	1 pc	TC5081P	2 pcs
TC5082P	1 pc	TC9122P	2 pcs
74LA90N	1 pc	74LS123	1 pc
SN76514N	2 pcs	HD10551P	2 pcs
MSM4011	1 pc	MSL915RS	1 pc
μ PD1510C-13	1 pc	μ PD1510C-036	1 pc
μ PD5101LC	1 pc	78L08	1 pc
78L05	1 pc		

FETs:

3SK73GR 2 pcs

Transistors:

2SA733AP	6 pcs	2SC535B	6 pcs
2SC1815Y	8 pcs	MPSA13	1 pc

Diodes:

1S1554 (Si Diode)	25 pcs	10D1 (Si Diode)	4 pcs
1N60 (Ge Diode)	2 pcs	MV104 (Varactor Diode)	2 pcs
WZ050 (Zener Diode)	1 pc	RD9.1EB-2 (Zener Diode)	1 pc

FCD:

FIP5A8B 1 pc

LED:

TLY208 8 pcs

Photo Interrupter:

EE-SH3-x-1 2 pcs

MAIN CHASSIS						PUSH KNOB
Symbol No.	Part No.	Name & Description			R3077910B	Push knob G
		IC			R3078720	Knob spacer
Q1	G1090299	μPC7805H				
					R3072900	Push knob B
		DIODE			R3054370	FOOT
D1	G2090042	Zener	RD8.2EB3		R7054630A	PAD
		RESISTOR				
R1	J01245820	Carbon film	1/4W TJ 82Ω	MAIN UNIT		
				Symbol No.	Part No.	Name & Description
				PB-2401	F0002401	Printed Circuit Board
		CAPACITOR			C0024010	PCB with Component
C1-5, 7-9	K13170103	Ceramic disc	50WV 0.01μF (DB201YF103Z5L5)			
C8	K13170473	" "	" " 0.047μF (DB207YF473Z5L5)			IC
				Q1012, 1023	G1090296	HD10551P
				Q1030, 1031 1054	G1090068	MC14011B
		RECEPTACLE		Q1029	G1090067	MC14013B
J1	P1090034	D7-701B-00		Q1034, 1038	G1090124	MC14016B
J2	P1090246	D8-701B-00		Q1027	G1090357	MC14077B
				Q1039	G1090290	MC14093B
P1 (with cable)	T9204405	7P DIN PLUG		Q1053	G1090332	MC14194B
P2 (")	T9204406	8P DIN PLUG		Q1055, 1056	G1090108	MC14518B
				Q1045, 1046	G1090050	MC14519B
				Q1028, 1032 1033	G1090224	MC14584B
		LAMP		Q1036	G1090412	MSL915RS
PL1, 2	Q1000049	032-00008	12V 100 mA	Q1050	G1090135	MSM4011
				Q1013, 1015	G1090062	SN76514N
				Q1051	G1090100	SN74LS123N
				Q1058	G1090034	SN74LS90N
		BATTERY HOLDER		Q1052	G1090098	TC5032P
	P2000013	C3	Holder	Q1040	G1090387	TC5066BP
	P2000022	S1	Snap with wire	Q1057	G1090239	TC5082P
				Q1008, 1018	G1090048	TC5081P
				Q1006, 1017	G1090247	TC9122P
				Q1037	G1090358	μPD1510C-036
		TERMINAL		Q1047	G1090331	μPD1510C-13
	Q6000017	1L6PS (3-0-3)		Q1048	G1090227	μPD5101LC
				Q1026	G1090080	μPC78L08
	T9204410					
	T9204411					
	T9204412					
	T9204413					
	T9204414			Q1004, 1049	G4800730G	FET 3SK73GR
	T9204415A					
	T9204416					
	T9204417					
	T9204418A					
	T9204439					TRANSISTOR
				Q1041-1044	G3107331P	2SA733AP
				Q1002, 1005 1010, 1014 1016, 1020	G3305350B	2SC535B
		KNOB		Q1001, 1003 1011, 1021	G3318150Y	2SC1815Y
	R3077830A	FT-22VK				

		CAPACITOR			
C1077, 1080	K02179003	Ceramic disc 50WV CH 2 pF (DD104CK20C50V02)	C1094, 1096	K00175471	Ceramic disc 50WV SL 470 pF (DD109SL471J50V02)
C1034	K02179004	" " " " 3 pF (DD104CH030C50V02)	C1095	K13170102	" " " 0.001μF (DB201YF102Z5L5)
C1039	K00172030	" " " SL 3 pF (DD104SL030J50V02)	C1005-1008 1010, 1011 1033, 1035 1036, 1038 1045-1058 1062-1065 1075, 1078 1079, 1081 1082, 1083 1092, 1093 1097, 1104- 1106, 1110 1140, 1145- 1147, 1149 1154, 1157 1160, 1161 1163, 1164 1166, 1167	K13170103	" " " 0.01μF (DB201YF103Z5L5)
C1028	K02172040	" " " CH 4 pF (DD104CH040C50V02)	C1013, 1016 1021, 1023 1128, 1130 1165	K13170473	" " " 0.047μF (DB207YF473Z5L5)
C1041, 1098	K00172040	" " " SL 4 pF (DD104SL040C50V02)	C1131-1138 1141-1144	K19149017	Semiconductor ceramic 50WV 0.022μF (UAT06X223K)
C1009	K02173060	" " " CH 6 pF (DD104CH060D50V02)	C1014, 1015 1020, 1022	K19149021	" " 0.047μF (UAT08X473K-45AE)
C1029, 1032	K06173060	" " " UJ 6 pF (DD104UJ060J50V02)	C1107, 1125 1151, 1152	K50177102	Mylar 50WV 0.001μF (50F2U102M)
C1001	K02173100	" " " CH 10 pF (DD104CH100D50V02)	C1150	K50177222	" " 0.0022μF (50F2U222M)
C1072	K06173100	" " " UJ 10 pF (DD104UJ100J50V02)	C1111	K50177472	" " 0.0047μF
C1043	K00173100	" " " SL 10 pF (DD104SL100D50V02)	C1112, 1121 1124	K50177103	" " 0.01μF (50F2U103M)
C1004	K02175120	" " " CH 12 pF (DD104CH120J50V02)	C1120	K50177153	" " 0.015μF (50F2U153M)
C1030	K06175120	" " " UJ 12 pF (DD104UJ120D50V02)	C1027, 1069 1070, 1123	K50177223	" " 0.022μF (50F2U223M)
C1059, 1061	K00175120	" " " SL 12 pF (DD104SL120J50V02)	C1108, 1109	K50177333	" " 0.033μF (50F2U333M)
C1012, 1087	K00175150	" " " " 15 pF (DD104SL150J50V02)	C1113, 1114	K50177473	" " 0.047μF (50F2U473M)
C1060	K00175220	" " " " 22 pF (DD104SL120J50V02)	C1116, 1117	K50177104	" " 0.1μF (50F2U104M)
C1031	K06175270	" " " UJ 27 pF (DD104UJ060J50V02)	C1115	K50177154	" " 0.15μF (50F2U154M)
C1126, 1127	K00175270	" " " SL 27 pF (DD104SL270J50V02)	C1066, 1067	K40179010	Electrolytic " 0.47μF (50RE-R47)
C1002, 1003 1158	K02179013	" " " CH 33 pF (DD105CH330J50V02)	C1025, 1026 1118, 1119	K40179009	" " 2.2μF (50RE2R2)
C1085, 1148	K00175330	" " " SL 33 pF (DD104SL330J50V02)	C1037, 1076 1084, 1099 1101, 1129 1168	K40129004	" 16WV 10μF (16RE10)
C1074	K06175330	" " " UJ 33 pF (DD104UJ330J50V02)			
C1044, 1089	K00175470	" " " SL 47 pF (DD104SL470J50V02)			
C1159	K02175470	" " " CH 47 pF (DD106CH470J50V02)			
C1040, 1090 1091	K00175560	" " " SL 56 pF (DD104SL560J50V02)			
C1071	K06175680	" " " UJ 68 pF (DD105-257UJ680J50V02)			
C1042, 1086	K00175820	" " " SL 82 pF (DD104SL820J50V02)			
C1088	K00175101	" " " " 100 pF (DD105SL101J50V02)			
C1017, 1019	K00175121	" " " " 120 pF (DD105SL121J50V02)			
C1156	K00175181	" " " " 180 pF (DD104SL181J50V02)			
C1018	K00175221	" " " " 220 pF (DD107SL221J50V02)			

C1100, 1102	K40129008	Electrolytic 16WV (16RE33)	33 μ F	J1001, 1010	P0090219	5045-03A
				J1004	P0090220	5045-04A
C1103, 1139 1162	K40109011	" 10WV (10RE33)	33 μ F	J1008	P0090221	5045-05A
				J1005	P0090229	5045-13A
C1122	K40129007	" 16WV (16RE100)	100 μ F			
						TP TERMINAL
					Q5000026	TP-F
		TRIMMER CAPACITOR				
TC1001	K91000075	T203R200	20 pF			
TC1002	K91000081	T203R300	30 pF			
				DISPLAY UNIT		
		INDUCTOR		Symbol No.	Part No.	Name & Description
L1016, 1017	L1190007	FL4H1R8M	1.8 μ F	PB-2405	F0002405	Printed Circuit Board
L1008, 1009	L1190070	FL4H8R2M	8.2 μ F		C0024050	P.C.B. with Components
L1014	L1190014	FL4H100K	10 μ F			
L1007, 1013	L1190015	FL5H120J	12 μ F			
L1006	L1190019	FL5H150K	15 μ F			
L1001, 1002	L1190016	FL5H101K	100 μ F			TRANSISTOR
L1005, 1010 1012, 1015 1018	L1190020	FL5H151K	150 μ F	Q2001, 2002	G3107331F	2SA733AP
L1004	L0021248					
L1011	L0021250					DIODE
				D2001-2008	G2090151	LED TLY208
				D2009, 2010 2013	G2090001	Si 10D1
		TRANSFORMER		D2011, 2012	G2090029	Ge 1N60
T1001	L0021249					
T1002, 1003	L0020805					
T1004	L3030077	E-142				
						RESISTOR
				R2005, 2006	J01245331	Carbon film 1/4W TJ 330 Ω
				R2003, 2004	J01245821	" " " " 820 Ω
		BUZZER		R2001, 2002 2007, 2008	J01245103	" " " " 10 k Ω
BZ1001	M4290001	EFB-RE25D02				
		RELAY				SWITCH
RL1001	M1190006	FBR221D012M			N4090062	SUH32V
		SWITCH				JUMPER
S1001	N6090008	SSS-012			Q9000042	
		SOCKET				
	P3090063	C844202	42 P			
				DIAL BOARD		
				Symbol No.	Part No.	Name & Description
				PB-2393	F0002393	Printed Circuit Board
		CONNECTOR			C0023930	P.C.B. with Components
J1002, 1003 1007, 1009	P0090218	5045-02A				

This Manual Provided
 Courtesy of Greg White, VA3VFO
 va3vfo@rac.ca

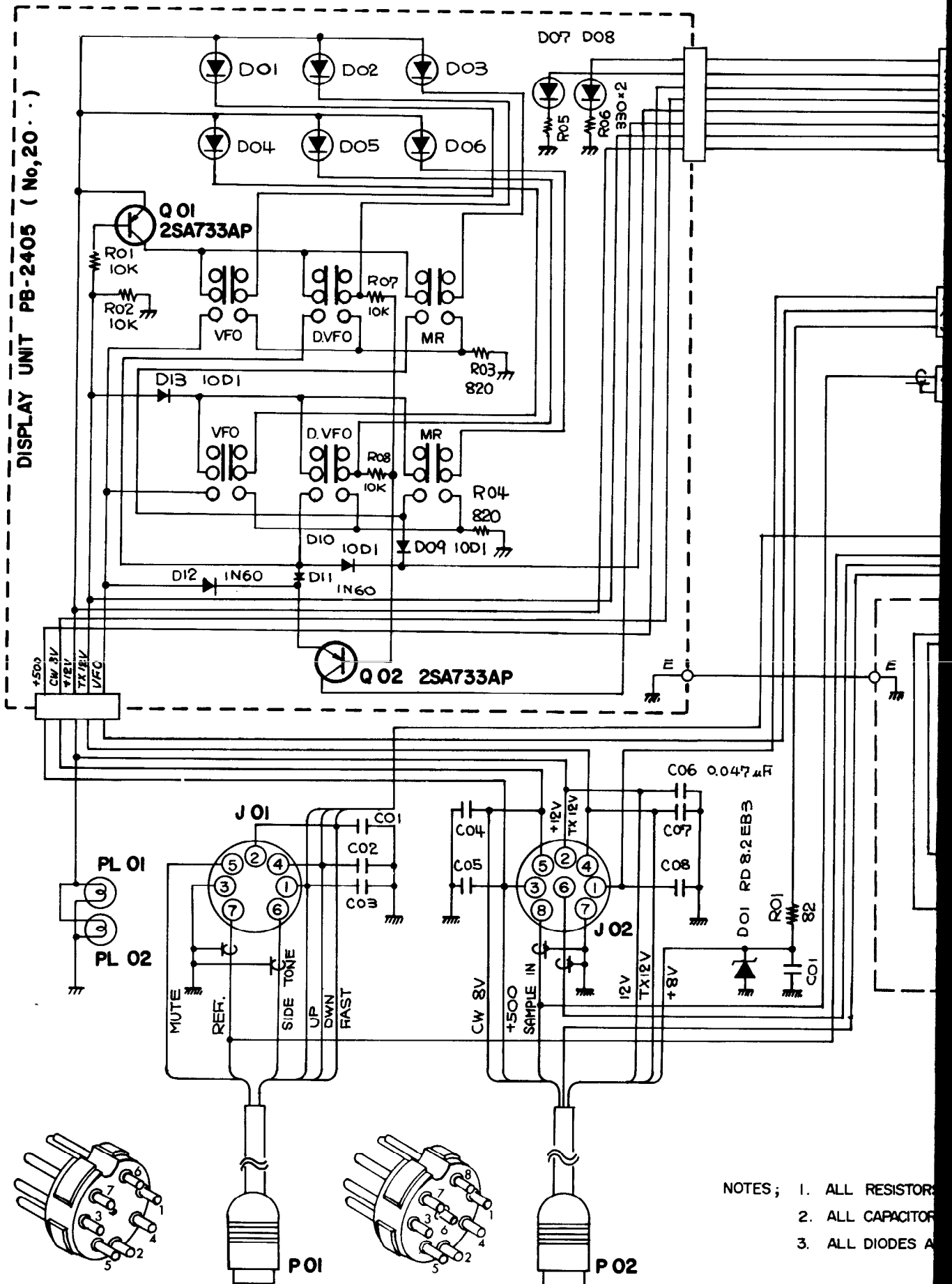

DISPLAY UNIT PB-2405 (No, 20 . .)

- NOTES ;
1. ALL RESISTOR
 2. ALL CAPACITOR
 3. ALL DIODES A

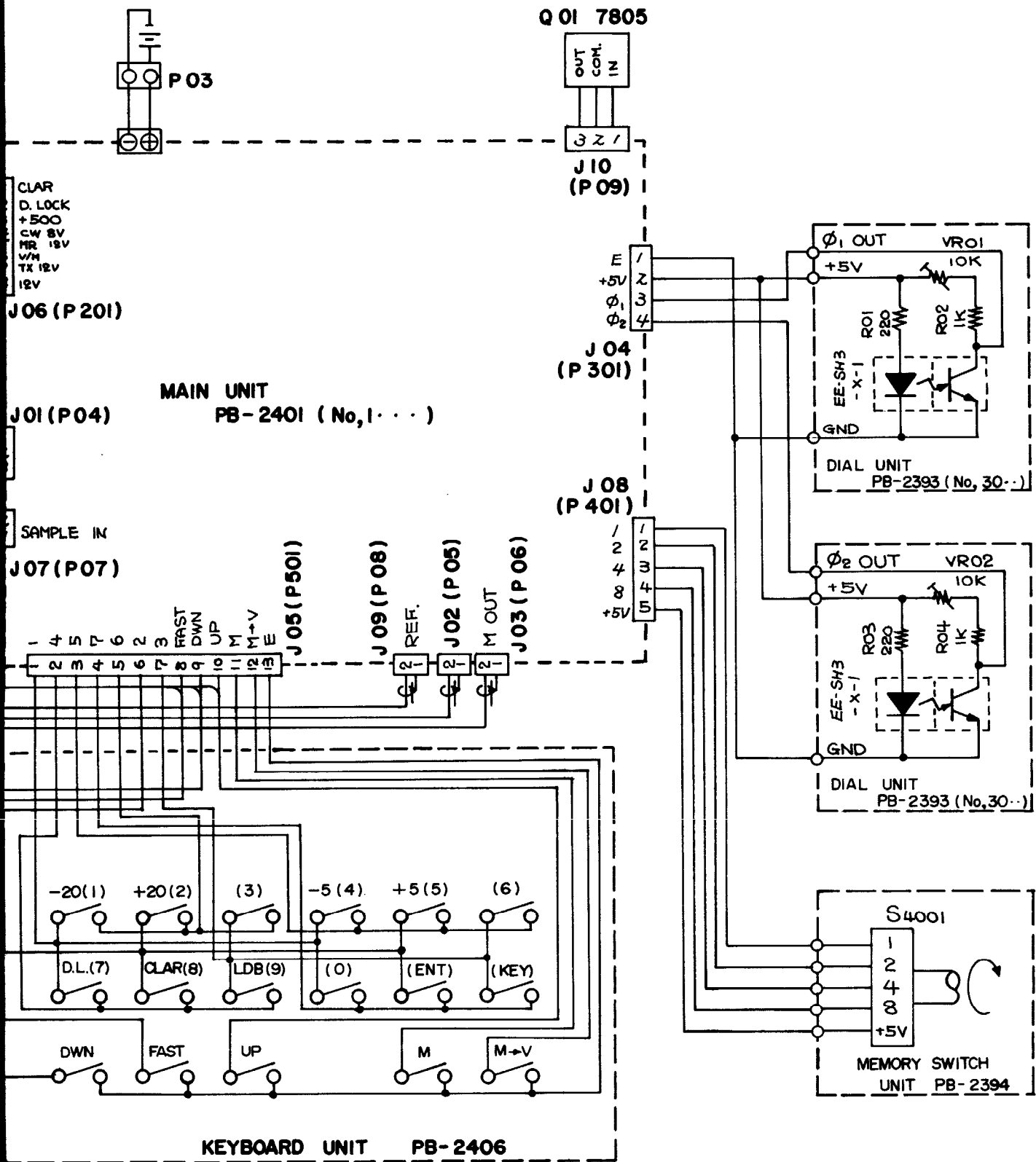

This Manual Provided
 Courtesy of Greg White, VA3VFO
 va3vfo@rac.ca

FV-102DM
CIRCUIT DIAGRAM

IN Ω, 1/4W, 10% UNLESS OTHERWISE NOTED.
 S ARE 0.01 μF 50 WV UNLESS OTHERWISE NOTED.
 RE TYL-208 UNLESS OTHERWISE NOTED.

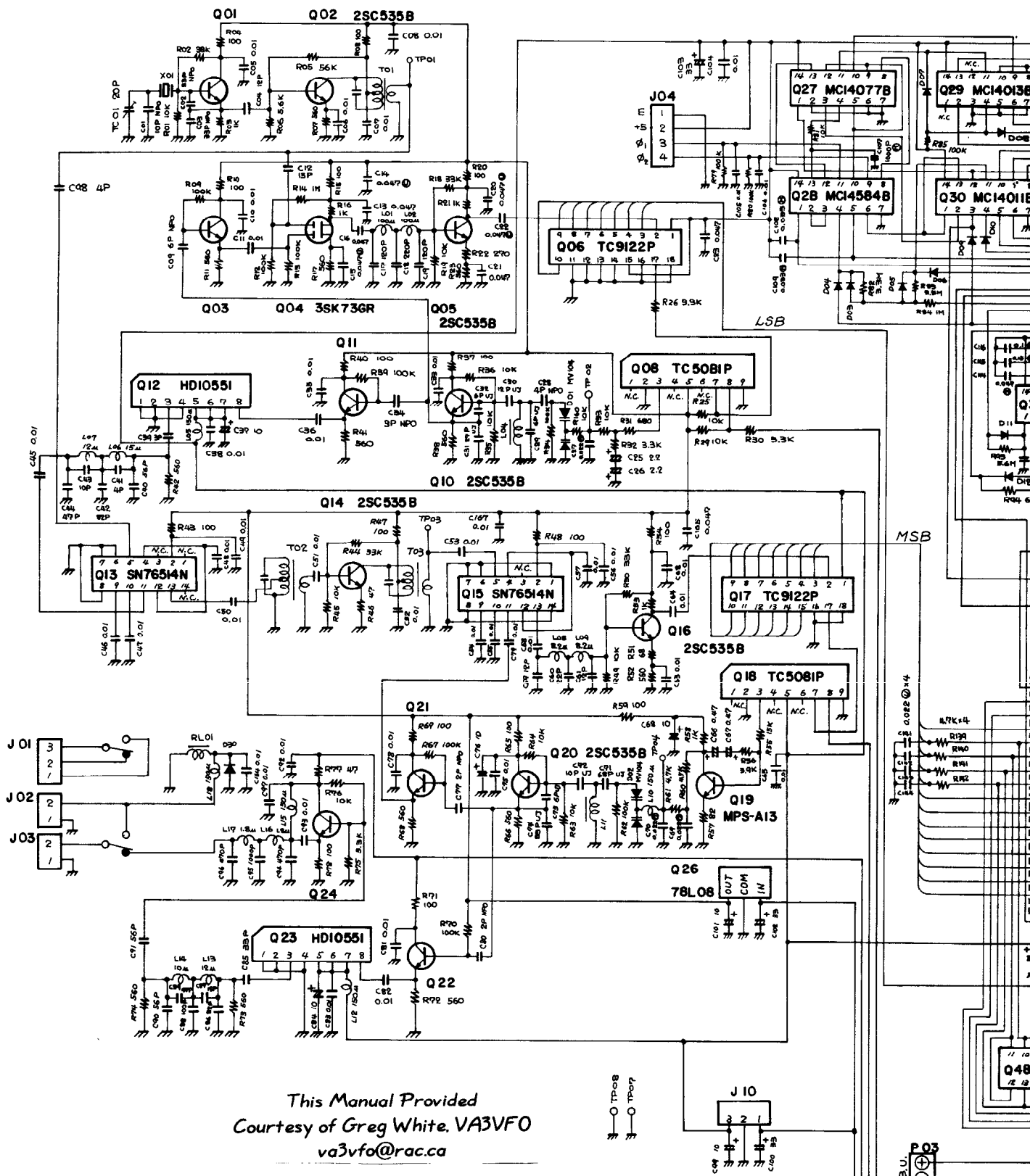

This Manual Provided
 Courtesy of Greg White, VA3VFO
 va3vfo@rac.ca

- NOTE
1. ALL RESISTORS IN Ω , 1/4W 10% UNLESS OTHERWISE NOTED
 2. ALL CAPACITORS IN μ F UNLESS OTHERWISE NOTED.
 3. ALL TRANSISTORS ARE 2SC1815Y UNLESS OTHERWISE NOTED.
 4. ALL DIODES ARE 1S1554 UNLESS OTHERWISE NOTED.
 5. (M) MARK: Mylar Capacitor, (C) MARK: Semiconductor Ceramic Capacitor.

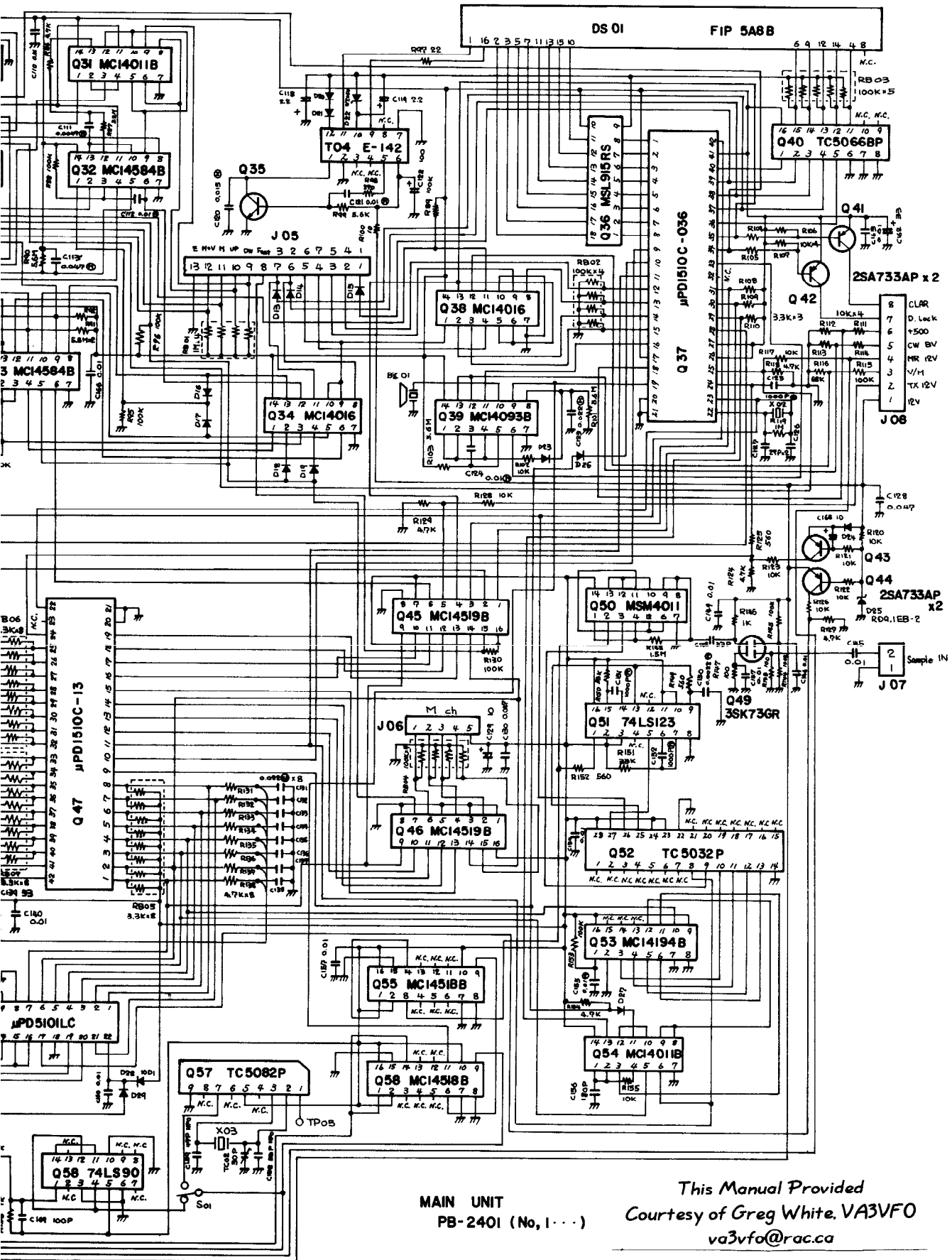

MAIN UNIT
PB-240I (No. 1...)

This Manual Provided
Courtesy of Greg White, VA3VFO
va3vfo@rac.ca



*This Manual Provided
Courtesy of Greg White, VA3VFO
va3vfo@rac.ca*

K4XL's **BAMA**

This manual is provided FREE OF CHARGE from the “BoatAnchor Manual Archive” as a service to the Boatanchor community.

It was uploaded by someone who wanted to help you repair and maintain your equipment.

If you paid anyone other than BAMA for this manual, you paid someone who is making a profit from the free labor of others without asking their permission.

You may pass on copies of this manual to anyone who needs it. But do it without charge.

Thousands of files are available without charge from BAMA. Visit us at <http://bama.sbc.edu>