

# YO-101 MONITORSCOPE

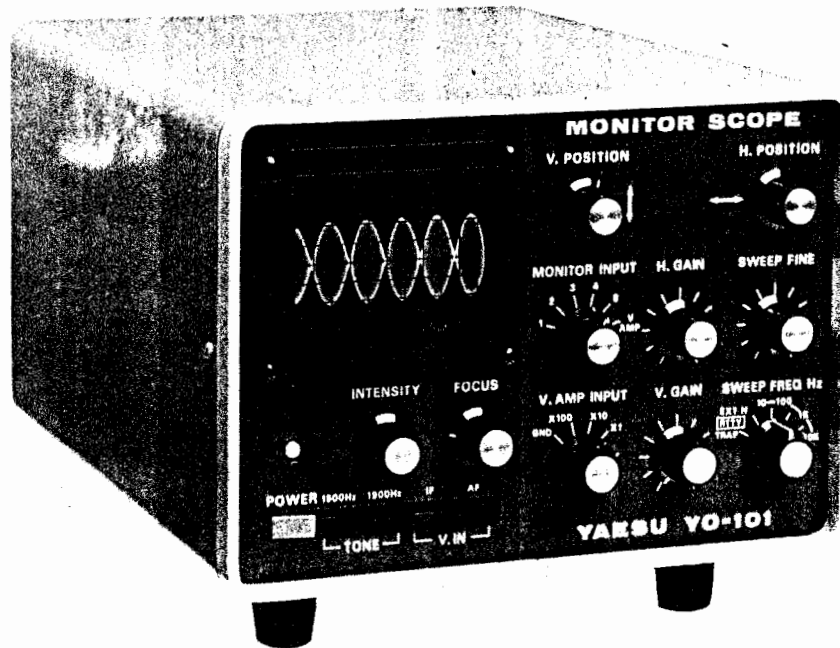

The model YO-101 Monitorscope is a measuring instrument designed for use with the Yaesu FT-101 series of amateur SSB equipment. The YO-101 is also compatible with the FT-301, FT-221, and FR-101 series, as well as other types of equipment. The Monitorscope allows monitoring of the transmitted signal, and also functions as an all-purpose oscilloscope. A two-tone generator is built in, to facilitate testing of your SSB transmitter. With an optional receiver adapter, the YO-101 can also be used to observe the received signal waveform. Styling and size of the YO-101 match the FT-101 series.

# SPECIFICATIONS

## VERTICAL AMPLIFIER

**Input Impedance:**  
1M ohm 80 pF

**Input Attenuator:**  
X1, X10, X100 and Ground

**Sensitivity:**  
20 mV/Div (P-P)

**Frequency Response:**  
2 Hz to 4 MHz  $\pm$  3dB  
9 MHz to 10.7 MHz

**Maximum Input Voltage:**  
600V DC + AC Peak

## HORIZONTAL AMPLIFIER

**Input Impedance:**  
100K ohm 100 pF

**Sensitivity:**  
300 mV/Div (P-P)

**Sensitivity Adjustment:**  
Variable

**Frequency Response:**  
10 Hz to 250 kHz  $\pm$  3 dB

**Sweep Frequency:**  
10 Hz to 10 kHz variable

**Maximum Input Voltage:**  
30V DC + AC Peak

## TONE GENERATOR

**Frequency:**  
1500 Hz and 1900 Hz app.

**Output Voltage:**  
20 mV (P-P) nominal  
115 mV (P-P) maximum

## TRANSMITTER MONITOR

**Frequency Coverage:**  
1.8 MHz to 54 MHz

**Input Impedance:**  
50 to 75 ohms

**Signal Power Limit:**  
10 watts to 500 watts

**Input Attenuator:**  
5 steps

**Insertion Loss:**  
Less than 0.5 dB

**Display:**  
Envelope, Trapezoid and Cross Pattern

## GENERAL

**Picture Tube:**  
C312P1

**Picture Tube Anode Voltage:**  
1.3 KV

**Power Requirement:**  
100/110/117/200/220 or 234 Volts  
AC at 50/60 Hz, 15 VA

**Size:**  
210 (W) x 150 (H) x 285 (D) mm

**Weight:**  
6 kg approx.

**SEMICONDUCTORS**

**FET:**

2SK30A	5	2SA733P	2
--------	---	---------	---

**SILICON TRANSISTORS:**

2SC3720	8	2SC1514	4
2SC373	1		

**DIODE:**

1N60	3	1DZ61	2
1S1588	3	SIR150	4
1S1830	1		

**ZENER DIODE:**

RD6AM	2	RD15FA	1
RD8.2FA	1		

**ACCESSORIES**

**Coax Cable (1):**

5D2V, both ends with UHF plugs . . . . . 1

**Coax Cable (2):**

RG-58A/U, with one end UHF plug and the other end RCA plug . . . . . 2

**Shielded Wire (1):**

RCA plug and clips . . . . . 1

**Shielded Wire (2):**

RCA plug and 4P mike plug . . . . . 1

**RCA Plug:** . . . . . 2

**Fuse 0.5A:** . . . . . 3

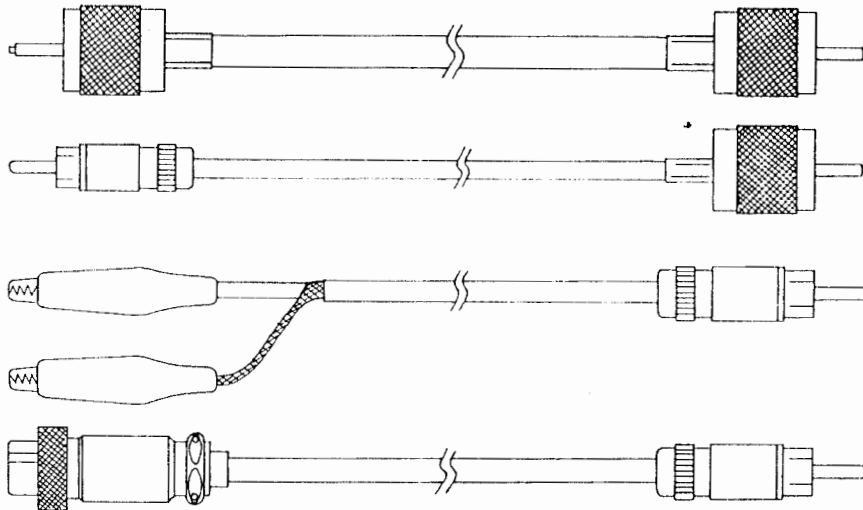

Interconnection cables

# CONTROLS & SWITCHES

## FRONT PANEL

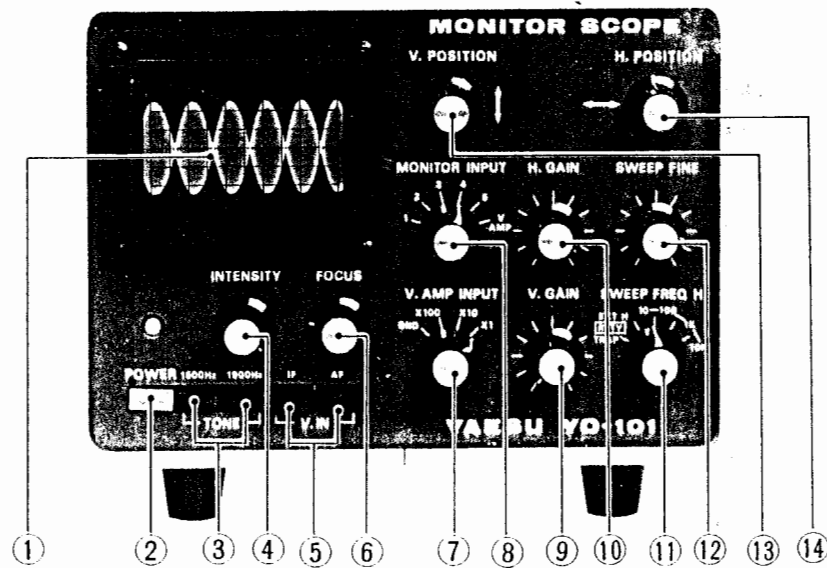

Prior to using the Monitorscope, it is recommended that you study and thoroughly understand the function of each control and switch described below:

### (1) SCOPE TUBE

The pattern is displayed on this surface. A 6 mm/division scale is provided.

### (2) POWER

Depressing the POWER switch activates the Monitorscope through application of AC power.

### (3) TONE SELECTOR

These switches are used for internal two-tone signal generation. Tone frequencies are 1500 and 1900 Hz. Depressing both switches results in two-tone output.

### (4) INTENSITY

This control varies the brightness of the pattern on the scope screen. Excessive brightness may burn the phosphor on the face of the CRT (Cathode Ray Tube).

### (5) V. IN SELECTOR

These switches select the desired vertical input. With the IF button depressed, and the AF button not depressed, IF vertical input is selected. With any other configuration of these buttons — both depressed, both not depressed, or AF only depressed — AF vertical input is selected.

### (6) FOCUS

This control adjusts the focus of the trace. There may be some interaction between this control and the INTENSITY control. Adjust this control for the sharpest trace resolution.

### (7) V. AMP INPUT

This switch functions as an attenuator, and it also selects the input level to the vertical amplifier. In the G position, the vertical input is grounded.

**(8) V. GAIN**

This control is used to vary the gain of the vertical amplifier. When the Monitorscope is used as a transmitter monitor, the pattern height cannot be varied by this control. The transmitted signal pattern can be varied by the monitor level control.

**(9) SWEEP FREQ**

This switch selects the horizontal sweep frequency range and the horizontal input. The sweep frequency covers from 10 Hz to 10 kHz in three steps, as shown on the scale. In the EXT II (RTTY) position, the horizontal input is connected to the external signal; this position is also used for RTTY cross pattern observation. The TRAP position is used for trapezoidal pattern monitoring.

**(10) SWEEP FINE**

This control is used for fine tuning of the sweep frequency set by the SWEEP FREQ switch.

**(11) H. GAIN**

This control is used to vary the gain of the horizontal amplifier.

**(12) MONITOR INPUT**

This is a six position switch. Positions 1 through 5 are used as an attenuator for the transmit signal monitor. This switch should be set to V. AMP position for receiver monitor or oscilloscope use.

**(13) V. POSITION**

This control determines the vertical position of the displayed pattern.

**(14) H. Position**

This control determines the horizontal position of the displayed pattern.

## REAR PANEL

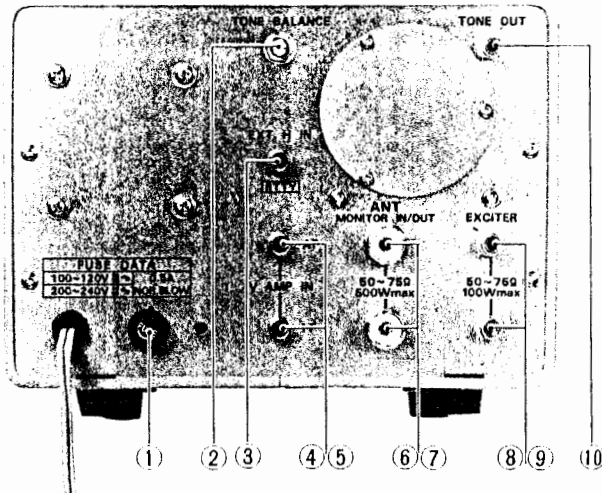

### (1) FUSE

Fuse holder. Use a 0.5 amp fuse. When replacing fuses, be absolutely certain that a fuse of the proper rating is installed. **WARRANTY DOES NOT CAUSE DAMAGE CAUSED BY IMPROPER FUSE USE.**

### (2) TONE BALANCE

This control is used to balance the output level of the two tone signal.

### (3) EXT. H IN (RTTY)

Input terminal for the horizontal amplifier.

### (4)(5) V. AMP IN

For IF receiver monitoring, connection is made to the IF jack, and for AF monitoring, connect the cable to the AF jack. The front panel V. IN SELECTOR switch selects between the two inputs for the vertical amplifier.

### (6)(7) ANT

Two coax connectors for transmitter signal monitoring.

### (8)(9) EXCITER

These terminals are used for trapezoidal pattern monitoring.

### (10) TONE OUT

This control is the output terminal of the internal two tone signal.

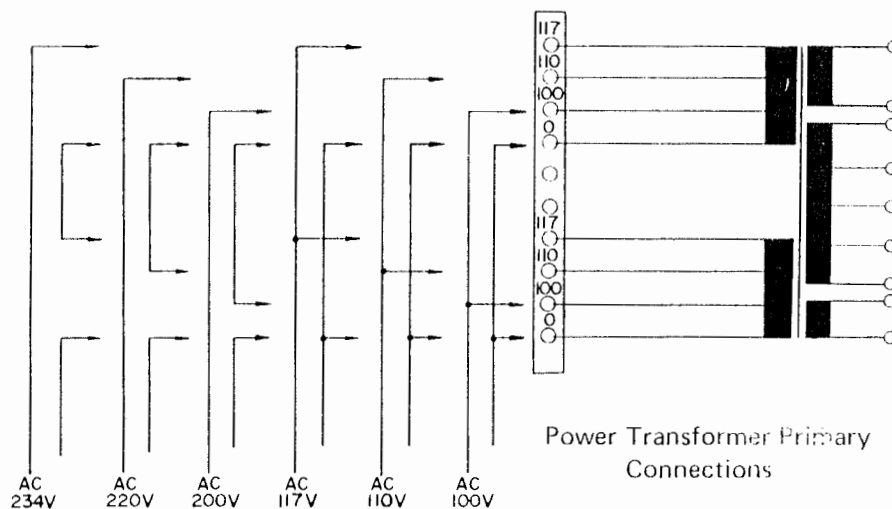

Figure 1

## INSTALLATION

The Monitorscope may be installed side by side with other radio equipment for transmitter or receiver signal monitoring. The YO-101 Monitorscope is designed for use in many areas of the world, with provision for operation from a variety of AC supply voltages. Therefore, BEFORE CONNECTING THE AC CORD TO THE POWER OUTLET, be certain that the voltage marked on the rear of the Monitorscope agrees with the local supply voltage.

### CAUTION

PERMANENT DAMAGE WILL RESULT IF IMPROPER AC SUPPLY VOLTAGE IS APPLIED TO THE MONITORSCOPE. WARRANTY DOES NOT COVER DAMAGE CAUSED BY APPLICATION OF IMPROPER SUPPLY VOLTAGE.

### INITIAL SETTING OF THE CONTROLS

The following set-up procedure is required prior to operating the Monitorscope.

POWER.....OFF  
INTENSITY.....12 o'clock position  
FOCUS.....12 o'clock position  
V. POSITION.....12 o'clock position  
H. POSITION.....12 o'clock position  
V. GAIN.....12 o'clock position  
H. GAIN.....12 o'clock position  
SWEEP FINE.....12 o'clock position  
V. AMP INPUT.....X100  
SWEEP FREQ.....10 Hz - 100 Hz  
MONITOR INPUT.....V. AMP  
TONE SELECTOR.....OFF

Set the POWER switch to ON position and wait until a bright trace is present on the screen of the scope. Adjust the INTENSITY control for a proper brightness. Excessive brightness for a prolonged period of time may burn the phosphor on the CRT screen.

Adjust the FOCUS control for a clear and sharp trace. There is an interaction between this control and the INTENSITY control. Therefore, adjust them for the best focus at the desired brightness.

Adjust the H. POSITION and V. POSITION to bring the spot to the center of the screen. Rotate the H. GAIN control and observe that the spot produces a horizontal line in the center of the screen.

# OPERATION

## TRANSMITTER MONITORING

The following instructions are for the transmitter which has a 50 - 75 ohm coaxial output.

- (1) Connect the RF output of the transmitter, transceiver, or linear amplifier (500 watts maximum) to either coaxial connector marked ANT on the rear of the Monitorscope. Connect a dummy load or antenna to the other ANT connector. Figure 2 details these connections.
- (2) Set the MONITOR INPUT switch to the proper setting as shown in Table 1.

OUTPUT	MONITOR INPUT	HEIGHT
5W	5	5 DIV.
15W	4	6 DIV.
100W	3	6 DIV.
100W	2	5 DIV.
500W	1	6 DIV.

Table 1 (Measured with 50 ohm dummy load)

- (3) Push the POWER switch of the Monitorscope and adjust the controls as described in the initial adjustment procedure.

- (4) Turn on the transmitter and adjust the H. GAIN, SWEEP FREQ and SWEEP FINE controls for the desired pattern display.
- (5) The internal tone generator may be used for testing purposes with an SSB or AM transmitter/transceiver. Use the accessory cable to connect the TONE OUT jack to the FT-101 MIC jack. Then depress the appropriate button(s) for the tone(s) desired. Refer to Figure 3 for interconnection details.
- (6) Refer to the patterns on page 9 for evaluation of observed waveforms of transmitted signals.

### NOTE:

For a two tone test, the amplitude of each tone signal should be set to the same value. Connect the TONE OUT jack to the VERT AMP IN jack with a patch cable. Depress the 1500 Hz tone button, and adjust the V. GAIN control until the display reaches the second calibration marking. Then depress the 1900 Hz button (1500 Hz button OFF), and adjust the TONE BALANCE control until the display height is the same as that of the 1500 Hz tone.

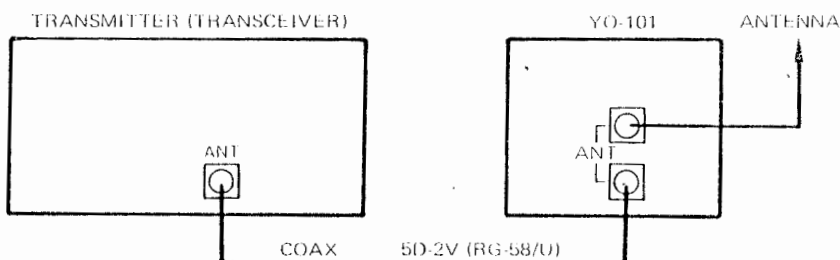

Figure 2

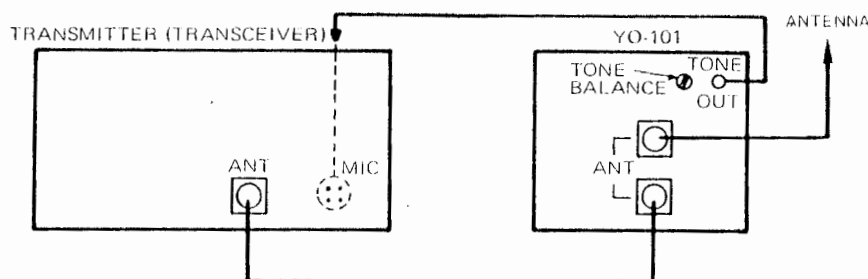

Figure 3



The following are typical transmitted signal patterns displayed on the Monitoroscope screen when it is connected as in Figure 4.

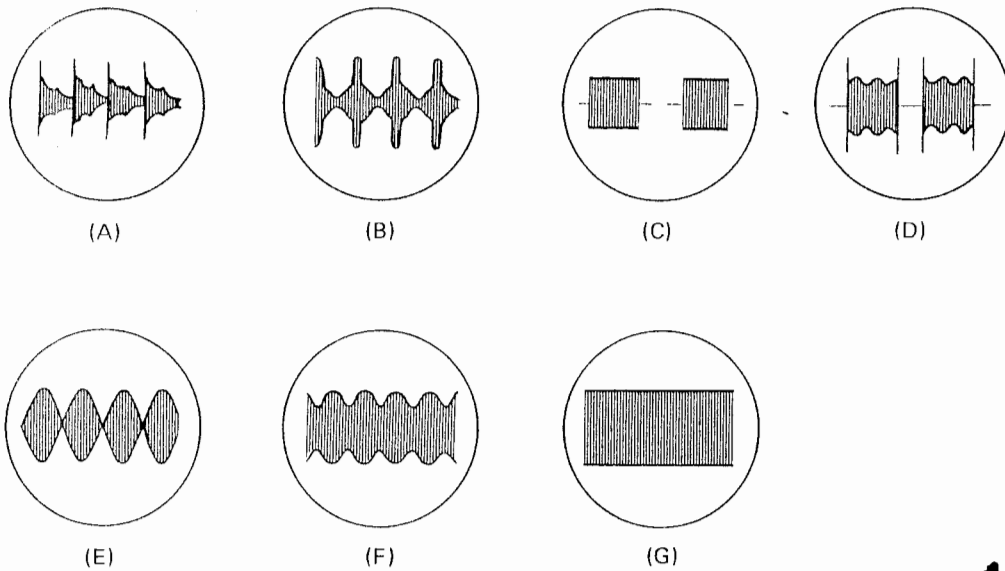

Figure 4

- (A) SSB signal voice modulated. Correctly adjusted.
- (B) SSB signal voice modulated. Excessive mic gain or insufficient loading. Flat-topping can be seen.
- (C) Pure CW signal.
- (D) CW signal with hum and key clicks.
- (E) SSB signal, two-tone modulated. Correctly adjusted.
- (F) SSB signal, two-tone modulated. Carrier leaking.
- (G) SSB signal, single-tone modulated. Correctly adjusted.

## RF TRAPEZOID TEST

Set up the Monitoroscope and transmitting equipment as illustrated in Figure 5, for the purpose of testing the linearity of the RF amplifier. The patterns from this test are called trapezoid patterns. Place the SWEEP FREQ Hz switch in the TRAP position.

### CAUTION:

IF YOUR AMPLIFIER PRODUCES MORE THAN 500 WATTS OUTPUT, AN RF ATTENUATOR MUST BE USED IN THE LINE BETWEEN THE AMPLIFIER AND THE YO-101 TO REDUCE THE POWER PASSED TO THE MONITORSCOPE. USE OF AN RF ATTENUATOR ALLOWS MONITORING OF THE AMPLIFIER OUTPUT UNDER NORMAL OPERATING CONDITIONS, WHILE ENSURING THAT THE POWER CAPABILITY OF THE MONITORSCOPE IS NOT EXCEEDED.

- (1) Connect a coaxial cable from the output of the exciter to one of the connectors marked EXCITER and connect the other connector to the input of the linear amplifier under test with a coaxial cable as illustrated in Figure 5.
- (2) Connect a coaxial cable from the RF output connector of the amplifier to one of the ANT connectors on the Monitoroscope. Connect the dummy load or antenna to the other ANT connector.

- (3) Connect a shielded patch cable from the TONE OUT jack of the Monitoroscope to the microphone input of the exciter.
- (4) Turn on the power switch of the Monitoroscope, and adjust the controls as described in previous sections.
- (5) Set the SWEEP FREQ switch to the TRAP position, and push the 1500 Hz and 1900 Hz buttons.
- (6) Turn on the exciter and linear amplifier and adjusted the switch and H. GAIN control of the Monitoroscope for the desired pattern display.
- (7) Refer to the patterns on page II for evaluation of the linearity of the amplifier under test.

### NOTE:

To avoid burn-out of the screen phosphor when there is no output from the transmitter, the INTENSITY control should be set as low as possible.

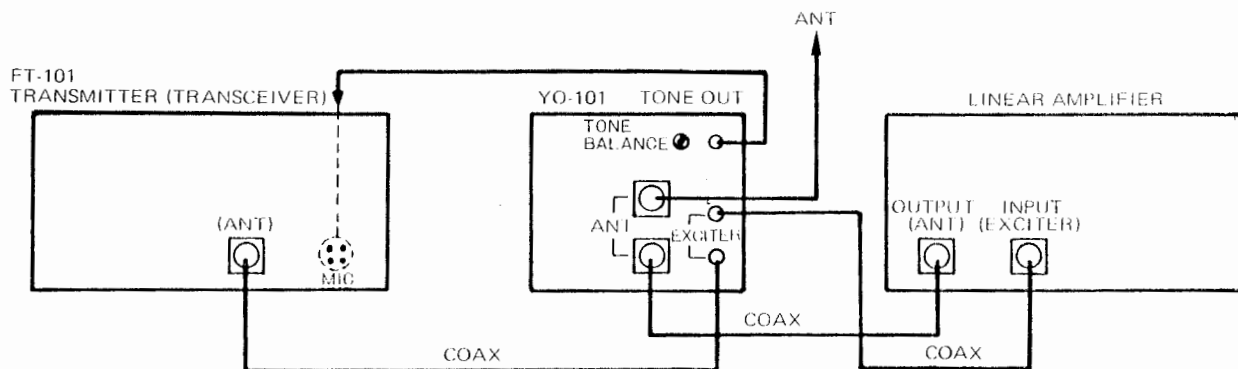

Figure 5

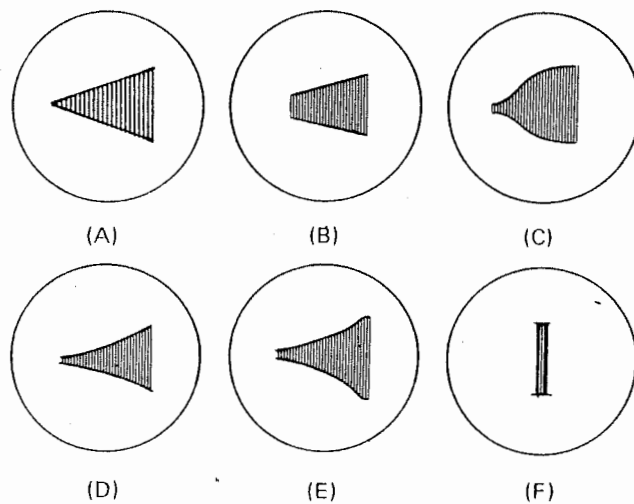

Figure 6

- (A) Good linearity.
- (B) Modulation less than 100% and good linearity.
- (C) Non-linear pattern indicating overdrive, insufficient antenna loading, grid current curvature or regeneration.
- (D) Non-linear pattern indicating regeneration or excessive grid bias.
- (E) Non-linear and parasitic oscillation on modulation peaks.
- (F) Unmodulated carrier.

## RTTY CROSS TEST

- (1) Connect a shielded cable from the mark terminal of the RTTY terminal unit to the EXT. H. IN (RTTY) jack, and a second cable from the space terminal to the V. AMP IN jack of the Monitor-scope, as illustrated in Figure 7.
- (2) Set the front panel controls as described in previous sections. Then set the V. AMP INPUT switch to V. AMP, and set the SWEEP FREQ switch to the EXT. II (RTTY) position. Make sure that the INTENSITY control is set as low as possible, to protect the screen when no signal is applied to the Monitor-scope.
- (3) The mark and space output of the terminal unit should be adjusted for an equal output when the receiver is properly tuned in. To check the equal output, insert the mark and space signal alternately into the vertical input of the scope and adjust the balance potentiometer of the scope and adjust the balance potentiometer of the terminal unit until equal height is obtained.
- (4) After the balance potentiometer for equal output as described above, adjust the V. GAIN and H. GAIN controls for a cross pattern of equal length of horizontal and vertical trace. Once the desired pattern has been set, the gain controls on the Monitor-scope should be changed.

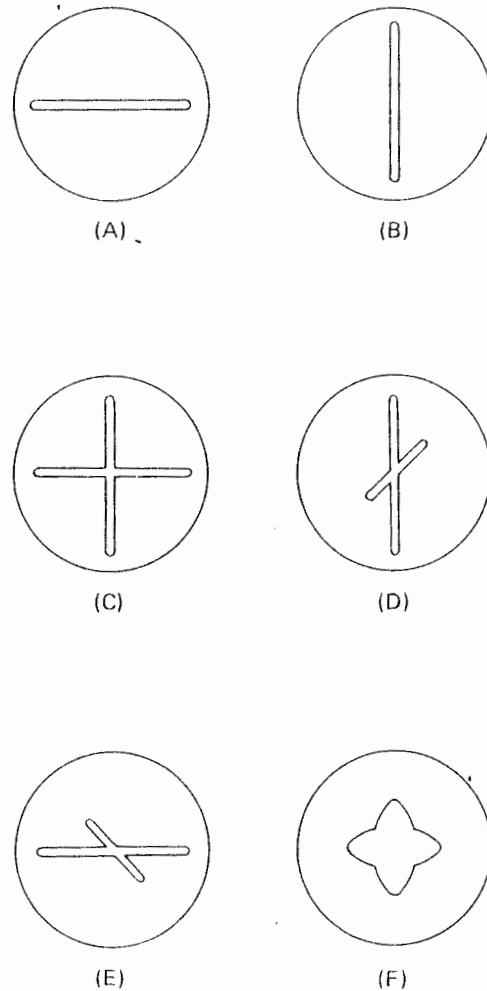

Figure 8.

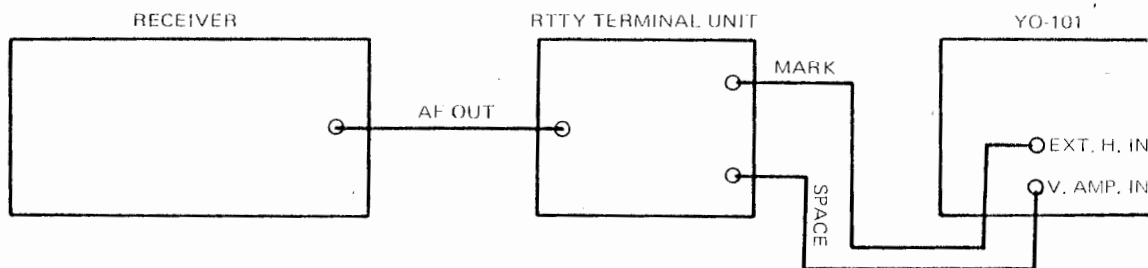

Figure 7

## RECEIVER MONITORING

The YO-101 Monitorscope can be used to monitor the received signal, with proper connections to the receiver. The IF signal is applied to the V. AMP IN (HF) terminal, and the MONITOR INPUT switch is set to the V. AMP position.

### FOR FT-101:

An IF output connector is provided on the FT101. However, the output from this connector is not sufficient for the YO-101. The following modification will allow receiver monitoring with the FT-101.

- (1) Remove PB-1183 from its socket.
- (2) Solder the 5 PF capacitor and coax cable as illustrated in Figure 9.
- (3) Reinsert PB-1183 to its socket.
- (4) Disconnect the coax cable from the IF OUT connector on the FT-101, and solder the other end of the coax cable installed in step (2) to this jack. Solder the outer conductor of the coax cable to ground.
- (5) Solder a 100K ohm 1/4 watt resistor between the inner and outer conductors of the cable at the connector.
- (6) Peak T109 after the above modification.

### FOR FR-101:

- (1) Locate the IF printed board, PB-1251, and solder the 5 PF capacitor and coax cable as illustrated in Figure 11.
- (2) Install the coax cable as illustrated and solder the other end of the coax cable to AUX connector on rear panel.
- (3) Solder a 100K ohm 1/4 watt resistor between the inner and outer conductor of the coax cable at the AUX connector.
- (4) Peak T119 after the above modification.

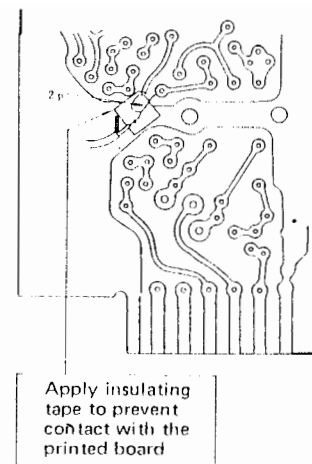

Figure 9

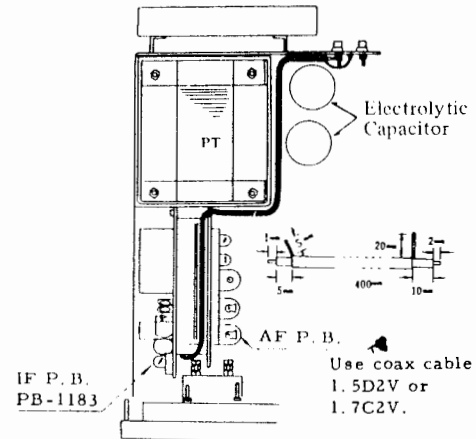

Figure 10

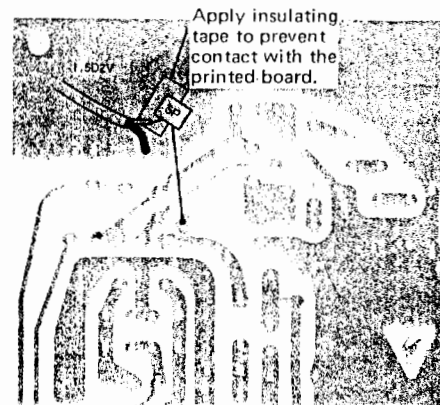

Figure 11

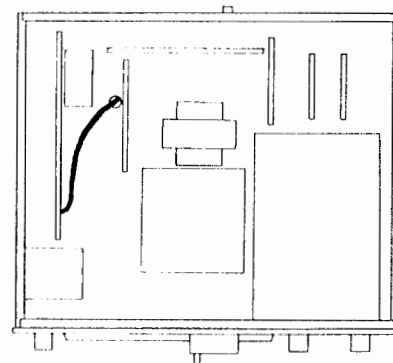

Figure 12

**FOR FT-301:**

The IF output is provided with Pin 4 of the accessory socket. Pin 6 is connected to ground.

**FOR FT-221/FT-225RD:**

As IF output is not provided, the following modification is necessary.

- (1) Remove the SSB IF UNIT from its socket.
- (2) Solder a 5 PF ceramic capacitor and a 47 cm length of coax cable to the board, as illustrated in Figure 13.
- (3) Install the coax cable as illustrated in Figs. 14 and 15.
- (4) Disconnect the wire from the ALC connector on the rear panel of the transceiver, and use the terminal for IF output.
- (5) Solder the coax cable to the ALC connector, and solder a 100K ohm 1/4 watt resistor between the ALC terminal and ground.

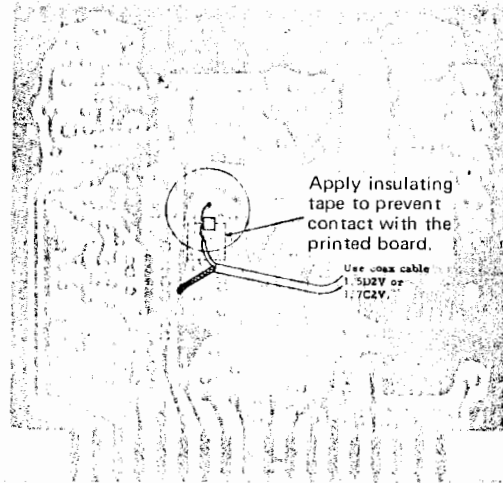
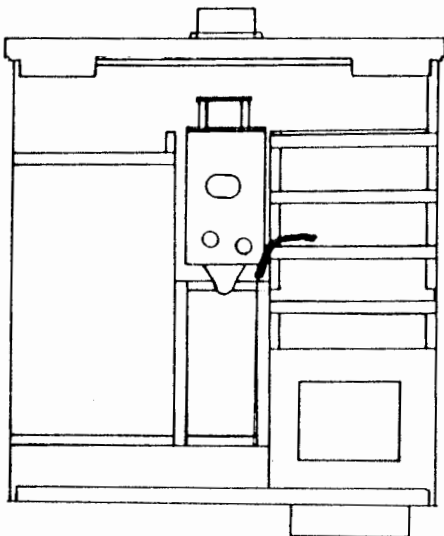
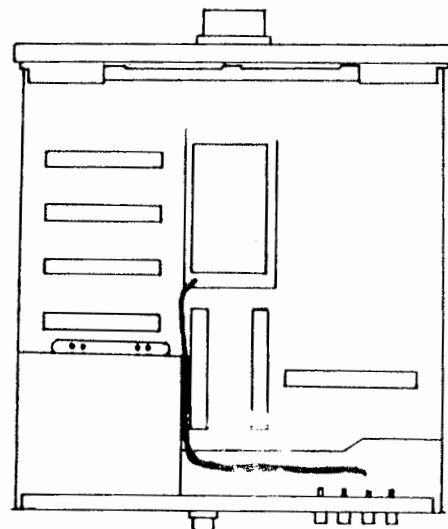

Figure 13



FT-221  
TOP VIEW

Figure 14



FT-221  
BOTTOM VIEW

Figure 15

# CIRCUIT DESCRIPTION

## GENERAL

Refer to the block diagram during this discussion, as it will be helpful in making clear the signal flow through the Monitor scope.

## VERTICAL AMPLIFIER CIRCUIT

The signal applied to the V. AMP IN jack J<sub>201</sub> is coupled through attenuator switch S<sub>201</sub> and the V. GAIN potentiometer to the high-input-impedance amplifier Q<sub>202</sub> (2SK30AY), from which the signal is delivered to the following stage at low impedance. Q<sub>201</sub> and Q<sub>203</sub> (both 2SC3720) work as a protective circuit against excessive input voltage by clipping the signal peaks.

The output from Q<sub>202</sub> is then applied to a differential amplifier, consisting of Q<sub>204</sub> and Q<sub>205</sub> (2SC1215), which converts the input to a balanced configuration for delivery to push-pull buffer amplifiers Q<sub>206</sub> and Q<sub>207</sub> (2SC3720). The signal is further amplified by vertical amplifiers Q<sub>208</sub> and Q<sub>209</sub> (2SC1514) and fed to vertical deflection electrodes Y+ and Y-.

## HORIZONTAL AMPLIFIER CIRCUIT

The horizontal signal selected by SWEEP FREQ switch S<sub>301</sub> is applied through H. GAIN potentiometer V<sub>303</sub> to amplifier Q<sub>306</sub> (2SK30AY), which converts the high input impedance to a low output impedance. The output is amplified by horizontal amplifier Q<sub>307</sub>/Q<sub>308</sub> (2SC1514) and fed to horizontal deflection electrodes X+ and X-.

## SWEEP CIRCUIT

A multivibrator, consisting of Q<sub>304</sub> and Q<sub>305</sub> (2SC3720), produces a saw-tooth sweep signal at the emitter of Q<sub>305</sub>. The saw-tooth sweep signal is amplified by Q<sub>302</sub> and Q<sub>303</sub> (2SC3720), and fed through the SWEEP FREQ switch, S<sub>301</sub>, to the horizontal amplifier.

The sweep frequency covers 100 Hz to 10 kHz continuously via the SWEEP FREQ switch and the SWEEP FINE control. A portion of the vertical signal is fed to buffer amplifier Q<sub>301</sub> (2SK30AY), the output signal of which is used for synchronization of the sweep frequency.

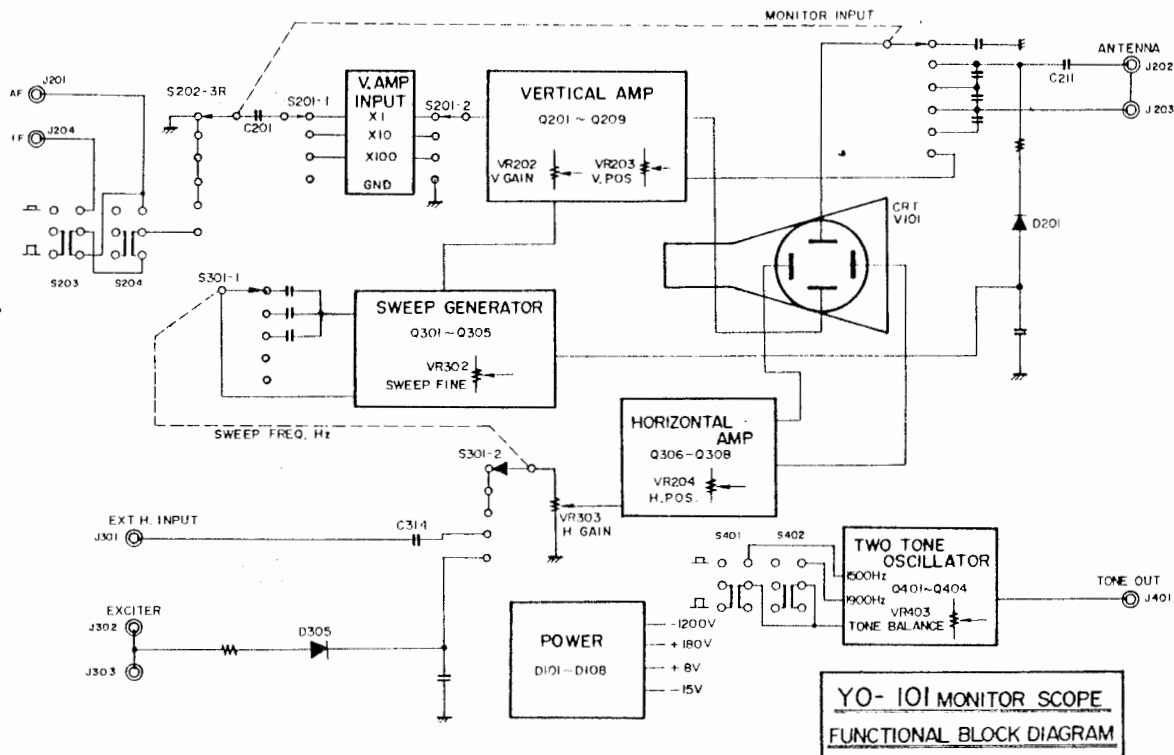

Figure 16

## TWO-TONE GENERATOR CIRCUIT

The Wien-bridge oscillators  $Q_{402}/Q_{403}$  (2SK30 AGR) oscillate at 1900 Hz and 1500 Hz, respectively. The bias voltage is stabilized by  $Q_{401}$  and  $Q_{403}$  (both 2SA733P), and the output level is equalized by TONE BALANCE control  $VR_{403}$ .

The sine wave signal is fed to buffer amplifier  $Q_{405}$  (2SC373), and the signal level is set by TWO TONE LEVEL control  $VR_{404}$ .

## TRANSMITTER MONITOR CIRCUIT

A portion of the transceiver power output is sampled through  $C_{211}$  from the Monitorscope ANT connectors. The sampled RF voltage is applied through MONITOR INPUT switch  $S_{202}$  to the vertical deflection plate, in order to obtain the proper height on the display screen. Since the input circuit is untuned, the Monitorscope can be used up to 100 MHz; however, some distortion of the pattern may be observed if operation is attempted on 144 MHz.

The RF voltage is detected by an envelope detector  $D_{201}$  (1N60), and used to synchronize the sweep generator for a stable display of the signal.

When the exciter output is fed through the EXCITER terminals to a linear amplifier, and the output of the amplifier is fed through the ANT connectors to the antenna, a portion of the exciter signal is detected by envelope detector  $D_{305}$  (1N60) and fed through the horizontal input selector switch to the horizontal deflection plate. The output of the linear amplifier is fed to the vertical deflection plate for display of a trapezoidal pattern, used in checking for linear operation of the amplifier.

## POWER SUPPLY

The power transformer has two primary windings for selection of various AC supply voltages. Unless otherwise specified, the power transformer is wired for 117 VAC operation. The secondary of the transformer has three windings, to deliver four different DC voltages (after rectification) plus AC heater voltage for the cathode ray tube. Diodes  $D_{101}-D_{104}$  (SIR150) provide -1200 volts DC from the 470 volt winding of the transformer via a full-wave voltage doubler circuit. This high voltage is supplied to the CRT. The 190 volt winding is connected to a full-wave rectifier circuit consisting of  $D_{105}$  and  $D_{108}$  (1S1830) for the vertical and horizontal amplifiers.

$D_{106}$  and  $D_{107}$  (1DZ61) provide 30 volts DC for the transistors. The 30 volt supply is regulated by zener diodes  $D_{109}$  (RD15FA) and  $D_{110}$  (RD8.2FA), providing -15 and +8 volts, respectively.



## MAINTENANCE & ALIGNMENT

Prior to shipment, your YO-101 was carefully aligned and tested at the factory, using precise test instruments. With normal usage, this unit should require only the usual attention given to any electronic apparatus. Service involving replacement of major components may require substantial realignment, which should only be performed by experienced personnel. Realignment should never be attempted unless the operation of the Monitoroscope is fully understood, and the malfunction has been fully analyzed and definitely traced to misalignment.

### WARNING

DANGEROUS VOLTAGES IN EXCESS OF 1200 VOLTS ARE PRESENT WITHIN THE MONITORSCOPE CABINET. THEREFORE, EXTREME CAUTION SHOULD BE EXERCISED WHEN MAKING ANY ADJUSTMENTS INSIDE THE CABINET. BEFORE REMOVING THE CABINET, UNPLUG THE AC LINE FROM THE OUTLET. DISCHARGE THE HV FILTER CAPACITORS BY SHORTING THE HV LINE TO GROUND WITH AN INSULATED SCREWDRIVER.

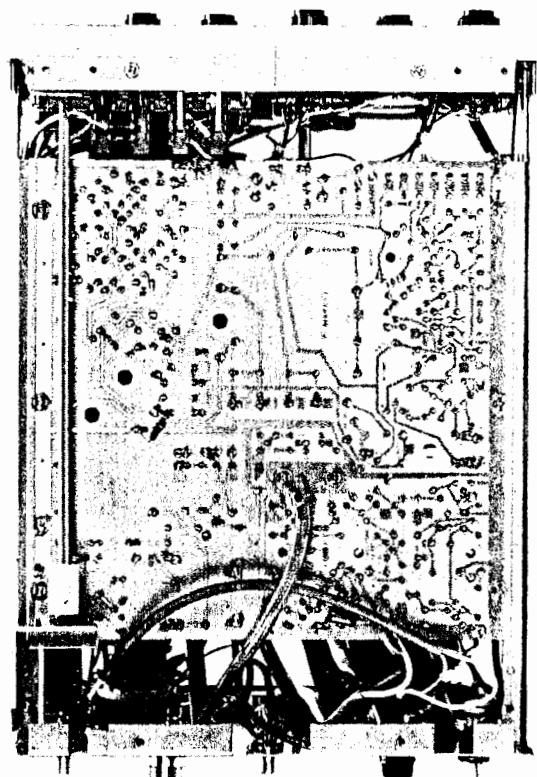
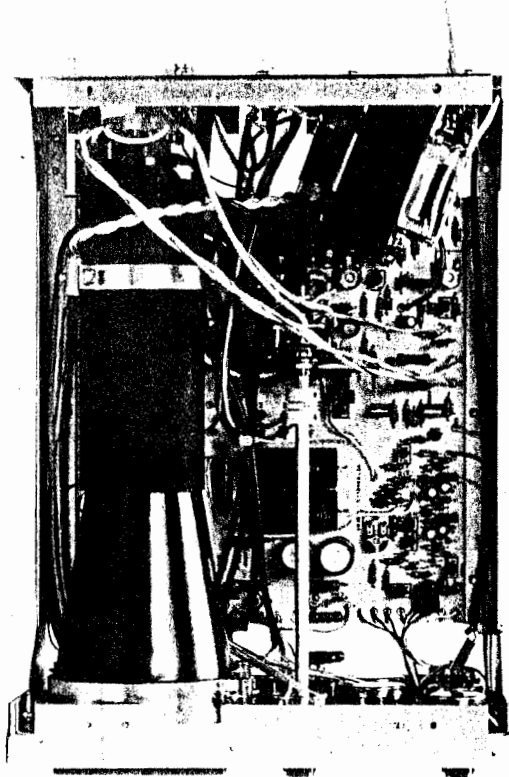

## 1. FREQUENCY RESPONSE COMPENSATION OF VERTICAL ATTENUATOR

(TC<sub>201</sub>, TC<sub>202</sub>)

Apply a pure square wave (50 Hz - 5 kHz) to the vertical input and observe the display on the CRT. Adjust TC<sub>201</sub> for the X10 and TC<sub>202</sub> for the X100 positions of the V. AMP INPUT switch until the display becomes identical with that obtained in the X1 switch position.

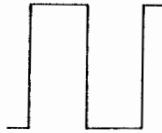

CORRECT

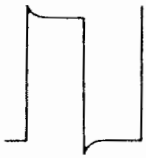

UNDER-COMPENSATION

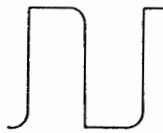

OVER-COMPENSATION

Figure 17

## 2. VERTICAL AMPLIFIER BALANCE

Wait for 30 minutes after the POWER switch is turned on. Check the position of the display when the vertical gain control is rotated throughout its range. If the display moves up or down, then adjustment of the balance is required.

Set the V. AMP INPUT switch to GND, and the V. GAIN control to the fully CCW position. Adjust the V. POSITION control to set the display (horizontal line) in the center of the CRT screen.

Rotate the V. GAIN control to the fully CW position. If the display moves, adjust VR<sub>201</sub> until the display remains at the center of the screen, regardless of the setting of the V. GAIN control position.

## 3. TWO TONE GENERATOR (VR<sub>401</sub>-VR<sub>404</sub>)

Adjust VR<sub>401</sub> and VR<sub>402</sub> until pure, stable sine waves of 1500 Hz and 1900 Hz, respectively, are obtained. The 1900 Hz output voltage is adjusted by VR<sub>404</sub>, and balanced with the 1500 Hz output voltage by the TONE BALANCE control VR<sub>403</sub>, located on the rear panel.

## 4. ASTIGMATISM (VR<sub>101</sub>)

This adjustment is required only when the CRT is replaced. Set the FOCUS control to the 12 o'clock position. Adjust VR<sub>101</sub> for a sharp focus.

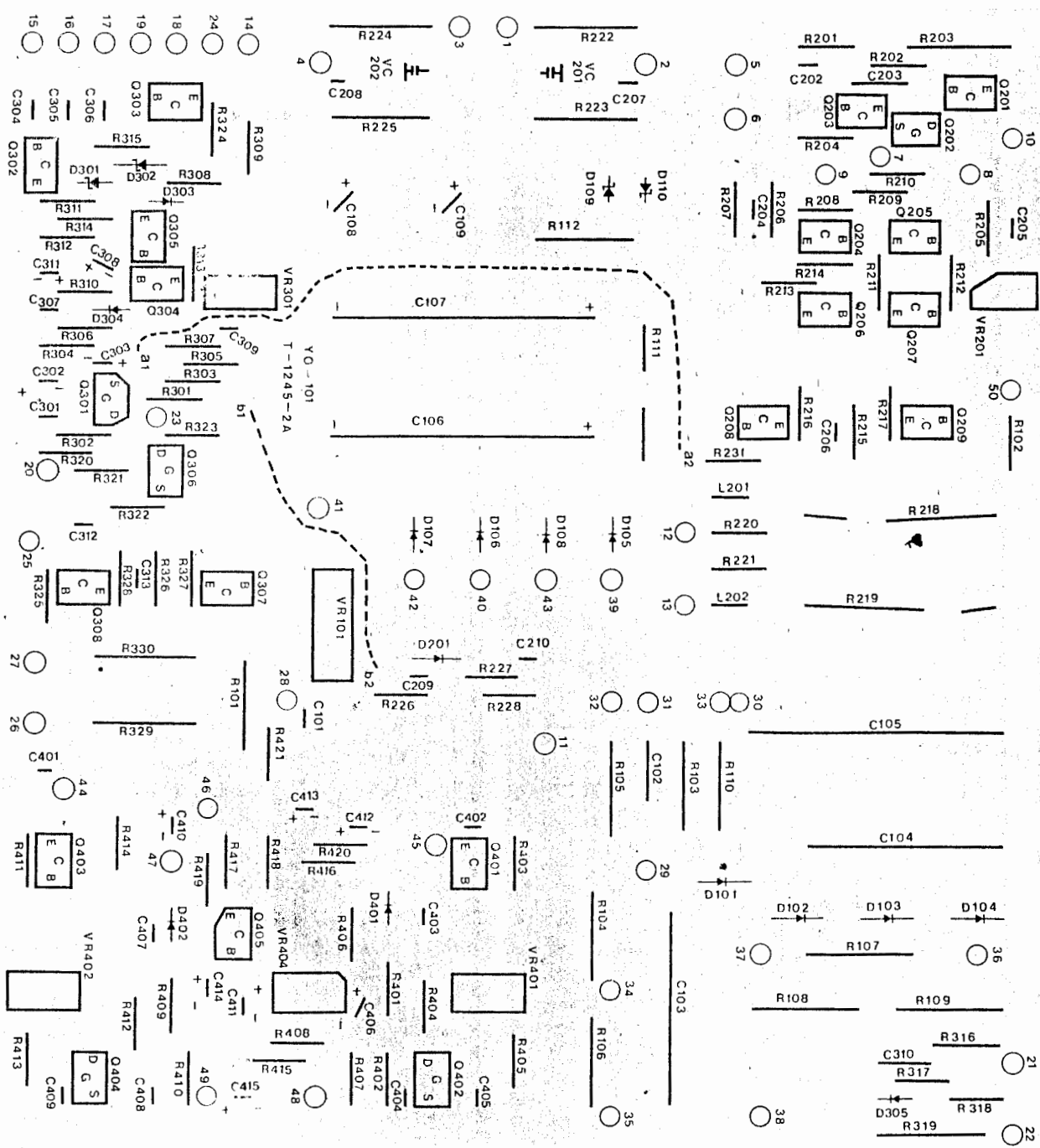
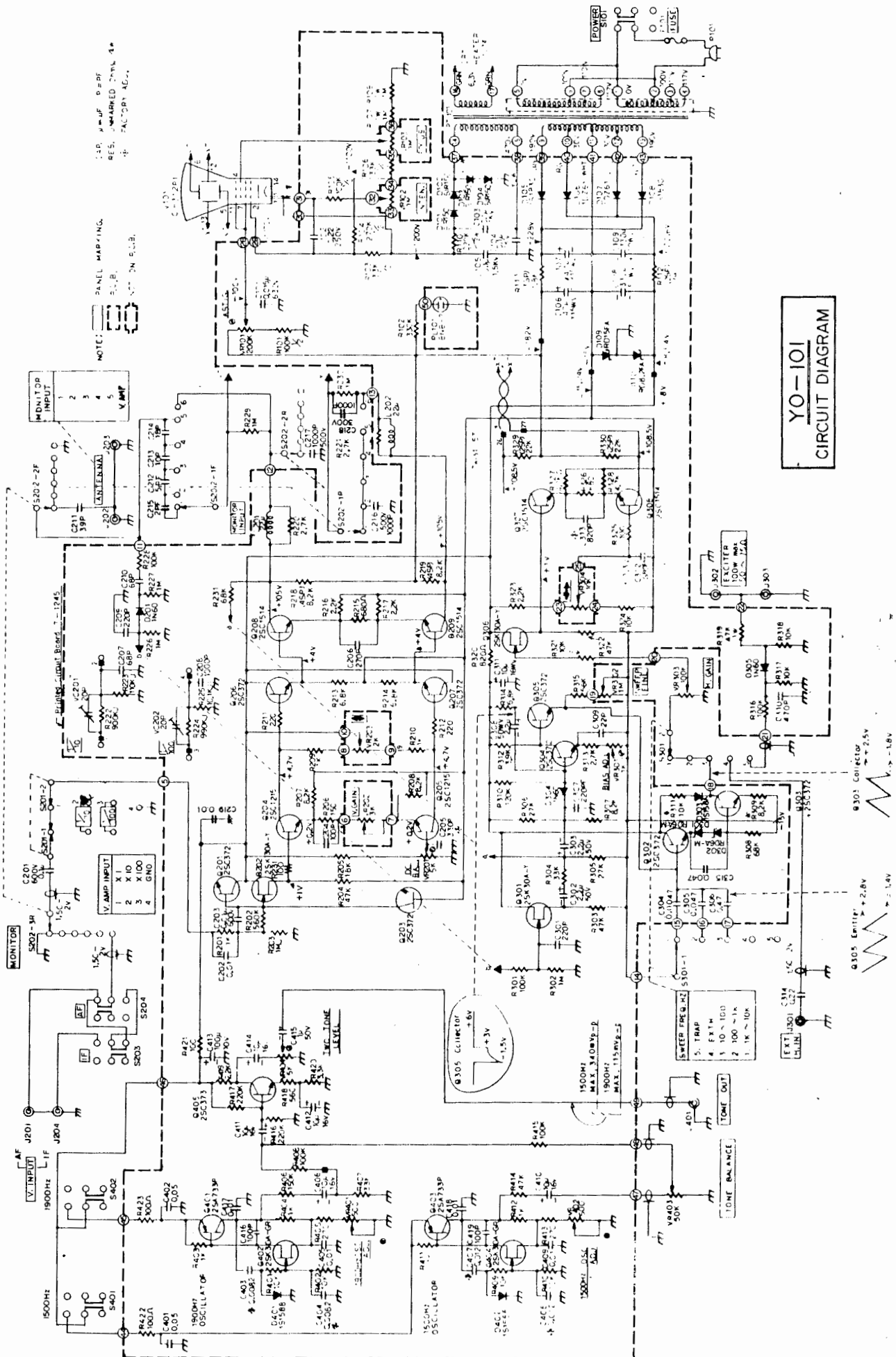

Figure 18



NOTE: PANEL WIRING.  
RES. MARKED WITH 4.  
+ FACTORY AG.

YO-101  
CIRCUIT DIAGRAM

# PARTS LIST

PB PRINTED CIRCUIT BOARD		222	1/2 W PYJ	900KΩ
T-1245A		224	1/2 W PYJ	990KΩ
		203	1/2 W PYJ	1MΩ
V CATHODE RAY TUBE				
101	C312P1	317	1 W PSJ	47KΩ
		107	1 W PSJ	1MΩ
Q FET & TRANSISTOR				
402, 404	FET 2SK30A GR			
202, 301, 306	FET 2SK30AY			
401, 403	Tr 2SA733P	METALLIC FILM		
201, 203, 206, 207	Tr 2SC3720	112	2 W	390Ω
302 ~ 305		329, 330	2 W	22KΩ
405	Tr 2SC373	111	3 W	1.8KΩ
204, 205	Tr 2SC1215	218, 219	4 W	8.2KΩ
208, 209, 307, 308	Tr 2SC1514			
D DIODE				
201, 304, 305	Ge 1N60	401, 402	V10K8 2 2	500Ω
106, 107	Si 1DZ61	301	V10K8 2 2	1KΩ
303, 401, 402	Si 1S1588	201, 404	V10K8 2 2	5KΩ
105, 108	Si 1S1830	403	V16L4N10SB	50KΩ
101 ~ 104	Si SIR150	101	V18K3 2B	200KΩ
301	Zener RD5.6EB	203	V24L5N20KC B	2KΩ
302	Zener RD6.2EB	202	V24L5N20KC C	3KΩ
110	Zener RD8.2FA	304	V24L5N20KC-B	10KΩ
109	Zener RD15FA	303	V24L5N20KC-B	100KΩ
		302	V24L5N20KC-B	1MΩ
		102, 103	V24L5N (8×10) 20KC-B	1MΩ
R RESISTOR				
CARBON FILM				
231, 325, 421 ~ 423	1/4 W	100Ω		
206	1/4 W	150Ω		
211, 212	1/4 W	220Ω		
405, 413	1/4 W	270Ω		
418	1/4 W	560Ω		
215, 326	1/4 W	680Ω		
320	1/4 W	820Ω		
201, 209, 210	1/4 W	1KΩ		
403, 404, 411, 412				
216, 217, 323, 419	1/4 W	2.2KΩ		
313	1/4 W	2.7KΩ		
220, 221, 420	1/4 W	3.3KΩ		
312	1/4 W	3.9KΩ		
327, 328	1/4 W	4.7KΩ		
213, 214, 314	1/4 W	6.8KΩ		
207, 208, 307, 309	1/4 W	8.2KΩ		
311, 317, 318, 321, 324	1/4 W	10KΩ		
401, 402, 409, 410				
205	1/4 W	18KΩ		
305, 306	1/4 W	27KΩ		
304, 407	1/4 W	33KΩ		
204, 303, 322, 414	1/4 W	47KΩ		
315	1/4 W	56KΩ		
231, 308	1/4 W	68KΩ		
228, 301, 316, 408, 415	1/4 W	100KΩ		
310	1/4 W	120KΩ		
406	1/4 W	150KΩ		
416, 417	1/4 W	220KΩ		
102	1/4 W	330KΩ		
202	1/4 W	560KΩ		
226, 227, 302	1/4 W	1MΩ		
103, 106	1/2 W PSJ	33KΩ		
101, 105	1/2 W PSJ	100KΩ		
110	1/2 W PSJ	220KΩ		
104	1/2 W PSJ	270KΩ		
229, 230	1/2 W PSJ	1MΩ		
225	1/2 W PYJ	10.1KΩ		
223	1/2 W PYJ	110KΩ		
C CAPACITOR				
DIPPED MICA				
209, 301, 307	50 WV	220PF		
206	50 WV	270PF		
205	50 WV	330PF		
215	500 WV	2PF		
212	500 WV	5PF		
213	500 WV	10PF		
214	500 WV	18PF		
309	500 WV	22PF		
211	500 WV	39PF		
207, 210	500 WV	68PF		
204, 416, 419	500 WV	100PF		
CERAMIC DISC				
219, 405, 409, 417, 418	50 WV	0.01μF		
315, 401, 402	50 WV	0.05μF		
216, 217, 218	500 WV	0.001μF		
MYLAR				
208, 403, 404, 407, 408	50 WV	0.001μF		
304	50 WV	0.0047μF		
*403, 404	50 WV	0.0082μF		
202	50 WV	0.01μF		
407, 408	50 WV	0.012μF		
305	50 WV	0.047μF		
STYROL				
310	50 WV	470PF		
312	50 WV	680PF		
*313	50 WV	820PF		
METALLIZED FILM				
306	100 WV	0.47μF		
102, 314	250 WV	0.22μF		
203	630 WV	0.01μF		
101	630 WV	0.015μF		
201	630 WV	0.1μF		
ELECTROLYTIC				



