

INSTRUCTION

MANUAL
CPU-2500R

Downloaded by
RadioAmateur.EU

YAESU MUSEN CO , LTD.

TOKYO JAPAN.

TABLE OF CONTENTS

	(Page)
INTRODUCTION	1
SPECIFICATION	2
CONTROLS AND SWITCHES	4
REAR APRON CONNECTIONS AND SWITCH	6
UNDERSIDE CABINET SWITCHES	6
INSTALLATION	7
OPERATION	9
BLOCK DIAGRAM	17
CIRCUIT THEORY	18
MAINTENANCE & ALIGNMENT	22
PARTS LIST	31

CPU-2500R 2 METER FM TRANSCEIVER WITH CENTRAL PROCESSING UNIT



The CPU-2500R is a revolutionary, ultimate performance transceiver for the most demanding 2 meter FM operator. Controlled by a central processing unit, the CPU-2500R features full PLL synthesis in 5 kHz steps, thus producing 800 channels between 144 and 148 MHz. An optical coupling frequency selection system utilizes photo-interrupters, eliminating ordinary rotary switches which can become oxidized and noisy.

The central processing unit allows never-before-possible operating flexibility. As many as four memory channels may be programmed for simplex or repeater operation, and an additional channel may be programmed for split operation on any frequency. The CPU-2500R PLL scanner will sweep up or down the band, and will also scan only the four memory channels, per your instructions.

Two microphones are available for use with the CPU-2500R. The standard microphone features the normal PTT switch plus up/down scanning controls. A versatile keyboard microphone allows

remote input of memory or dial frequencies, up/down scanning control, auxiliary repeater split selection of up to 4 MHz, and two-tone input for autopatch or control link purposes.

Among the other exciting features of the CPU-2500R are automatic or manual tone burst/tone call operation, selectable power output of 25W/3W, and a memory backup feature for holding memorized frequencies when the transceiver is turned off. A fully adjustable subaudible tone guarded squelch (TGS) is available as an option.

Famous Yaesu design features include automatic final protection for the output transistors, as well as reversed polarity protection for the supply input. The CPU-2500R is supplied complete with all mounting hardware, cables, and accessories required for mobile use, as well as a stand for base station use. The solid state devices used in the space-age CPU-2500R assure you of many years of trouble-free operation.

SPECIFICATIONS

Frequency range:

144–148 MHz*
144.000–147.995 MHz receive
144.010–147.995 MHz transmit

*Factory modified to 144–146 MHz,
if required by local regulations.

Synthesizer steps:

10 kHz, with 5 UP switch for intermediate
steps.

Emission type:

F3 variable reactance frequency modulation.

Deviation:

± 5 kHz factory preset, ± 16 kHz maximum

Power output:

25 watts (HI), 3 watts (LOW) @ 13.6 VDC
into 50 ohm load.

Spurious emissions:

Better than 60 dB down.

Antenna impedance:

50 ohms nominal.

Microphone impedance:

600 ohms

Tone burst frequency:

1800 Hz (USA model),
1750 Hz (Europe, etc.)

Receiver type:

Double conversion superheterodyne.

Receiver sensitivity:

0.3 μ V for 20 dB QS

Selectivity:

±6 kHz at 6 dB down, ±12 kHz at 60 dB
down.

First IF:

10.7 MHz

Second IF:

455 kHz

Audio output:

1.5 watts @ 10% THD.

Audio output impedance:

8 ohms.

Voltage requirement:

13.6 volts ± 10%

Current consumption:

0.5 A receive
6.0 A transmit (HIGH), 2.5 A (LOW)

Case dimensions:

180 (W) x 72 (H) x 270 (D) mm.

Weight:

3.2 kg.

SEMICONDUCTOR COMPLEMENT

Integrated Circuits

MN9003 (CPU)	1
MC14011B	5
MC14042B	1
MC14069B	1
MC14410	1
MC14556B	1
MSM5576	1
TA7060P	1
TC5081P	1
μ PC575C2	1
μ PC577H	1

μ PC14305	1
μ PD857C	1
78L05	2
VP-20A	1
Field-Effect Transistors	
2SK19BL	1
2SK19GR	3
2SK30AY	1
3SK40M	3
3SK51	3

Transistors

2SA496Y	1
2SA564Q	9
2SA719P	4
2SC373	1
2SC496Y	2
2SC535A	3
2SC741	1
2SC1000GR	1
2SC1815Y	32
2SD235-O	1

Photo-Interrupter		Varactor Diodes		LED Display	
ON1105	2	1S2209	5	5082-7740	7
		1SV50	1		
Germanium Diodes		Varistor Diode			
1S188FM	11	MV103	1		
Silicon Diodes		Zener Diode			
1S1555	28	RD8.2EB	1		
V05B	1				

Specifications subject to change without notice or obligation.

2 Lowmount BWO
5 Speaker

ACCESSORIES

1. MICROPHONE 1 ea.

The standard microphone comes with a flexible, coiled cord and 6 pin connector for insertion into the front panel microphone jack. The microphone includes a PTT switch and UP/DOWN scanner controls. The keyboard microphone includes a tone pad and remote programming controls.

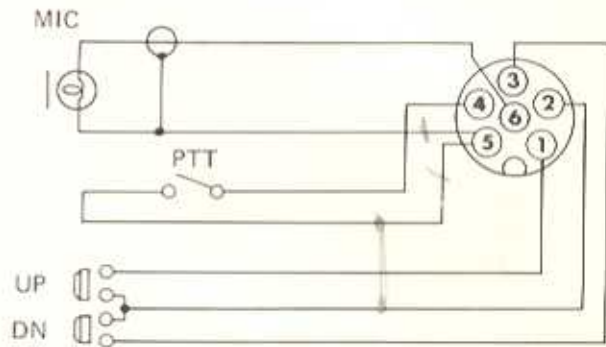

2. MICROPHONE HANGER 1 ea.

The hanger may be installed wherever convenient for easy access to the microphone.

3. POWER CORD 1 ea.

The power cord comes equipped with a 10 ampere fuse in the DC line.

4. SPARE FUSES 1 ea.

These fuses are for replacement if the line fuse blows. When replacing fuses, be absolutely certain to use a replacement fuse of 10 amps rating.

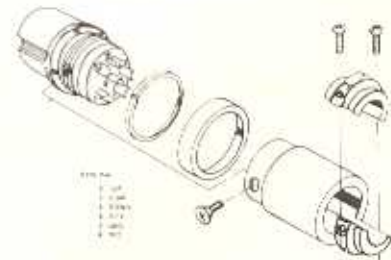

Standard Microphone Connector

WARRANTY DOES NOT COVER DAMAGE CAUSED BY IMPROPER FUSE REPLACEMENT.

5. MOBILE MOUNTING BRACKET 1 ea.

For mobile installations, a universal mounting bracket is supplied.

6. STAND 1 ea.

For easy viewing in base station use.

7. MINIATURE PHONE PLUG 1 ea.

For use of headphones or an external speaker.

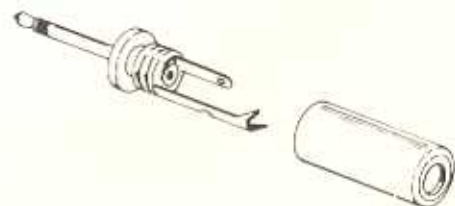
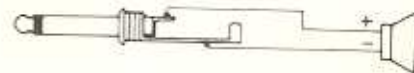

Speaker Plug

FRONT PANEL CONTROLS AND SWITCHES

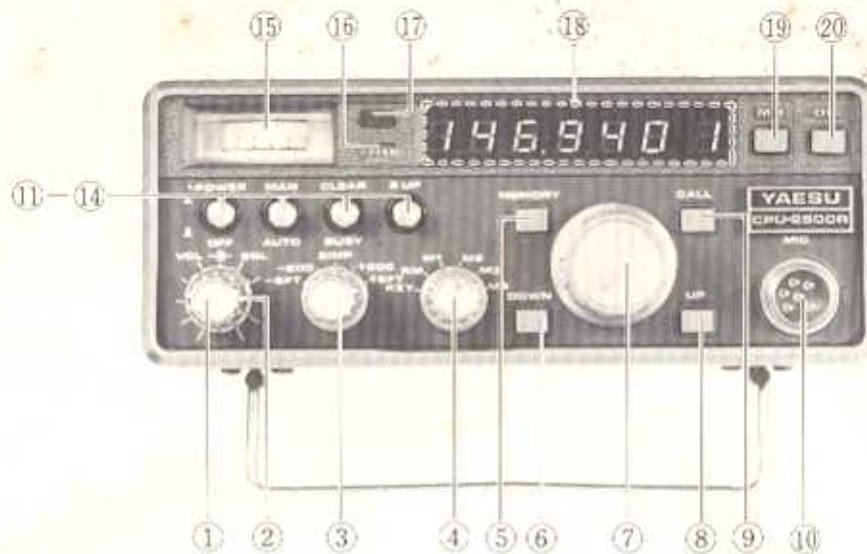

(1) VOL

This is the AF gain (volume) control for the transceiver. Clockwise rotation increases the audio output.

(2) SQL

This is the squelch threshold adjustment control. With no signal present, it should be adjusted to the point where receiver noise just disappears, to provide silent listening.

(3) TX OFFSET SELECTOR

SIMP – This position chooses simplex operation on the main dial frequency or memory frequencies M1–M4.

+600, –600 – These positions select the normal plus or minus 600 kHz repeater offset on the dial or M1–M4 frequencies.

+SFT, –SFT – When the keyboard microphone is used, these switch positions select remotely programmed auxiliary offset frequencies for transmit. In this way, unusual repeat splits may be accommodated.

(4) MEMORY CHANNEL SELECTOR

This six-position switch allows selection of the memorized frequencies as desired by the operator.

KEY – When the keyboard microphone is used, placing the switch in the KEY position allows programming and recall of memory frequencies from the keyboard.

RM (RECEIVE MEMORY) – When this position is selected, split operation throughout the range of the transceiver is possible. Memory position M0 is used for reception, while transmission is on the dial frequency. Refer to the "Operation" section for details.

M1–M4 – These are the four main memory channels which may be programmed and recalled.

(5) MEMORY

This switch is used for programming a frequency into memory.

(6) DOWN

This button activates the CPU scanner for scanning lower in frequency. When the lower band edge is reached, the scanner's next step will be to 147.990 MHz (145.990 MHz on the European model), thus assuring in-band operation at all times.

(7) CHANNEL SELECTOR

This is the main tuning dial for the transceiver. It is activated when the DIL button is pushed. Each tuning step is 10 kHz, with the intermediate 5 kHz steps being provided via the 5 UP switch. When the transceiver is initially turned on, the display will indicate 147.000 MHz (145.000 on the European model), and the dial may be tuned from that point to the desired operating frequency. Tuning is via an optical coupling photo-interrupter circuit.

(8) UP

This button activates the CPU scanner for scanning higher in frequency. When the upper band edge is reached, the scanner's next step will be to 144.000 MHz.

(9) CALL

When pushed, this button activates the tone burst and PTT circuit for as long as it remains depressed. In this way, a number of differing repeater access requirements may be accommodated.

(10) MIC

This is the microphone receptacle for the standard microphone. Microphone impedance is 600 ohms.

(11) POWER

Pushing this switch supplies power to all transceiver circuits.

(12) SCAN STOP

When this switch is pressed (MANUAL scan mode), the scanning feature of the CPU-2500R will scan continuously until the microphone PTT switch or the front panel CALL switch is pressed.

When this switch is not pushed (AUTO mode), the scanner will hold on a busy or clear channel, according to the position of the SCAN STOP MODE switch.

(13) SCAN STOP MODE

When using the AUTO scanner, pressing this switch (CLEAR position) will cause the scanner to halt when a clear channel is found. This is very useful when searching for an unused frequency for simplex operation, etc.

In the BUSY position, (switch not pushed), the scanner will stop and hold on an occupied channel. This feature is useful for checking a number of channels for activity.

(14) 5 UP

This switch, when pressed, shifts the operating frequency 5 kHz up from the normal 10 kHz channel spacing.

(15) METER

On receive, signal strength is displayed, and on transmit, relative power output is displayed.

(16) BUSY

This lamp lights when the squelch is tripped by an incoming signal, thus indicating that the frequency is occupied.

(17) ON AIR

This lamp lights up during transmission.

(18) DISPLAY

Full frequency readout is provided by the digital display. As well, the memory channel selected is displayed at the right-hand side.

(19) MR (MEMORY RECALL)

This button transfers control from the main dial to the memory channels.

(20) DIL (DIAL)

This switch, when pressed, transfers control from the memory channels to the main tuning dial.

CABINET RIGHT SIDE

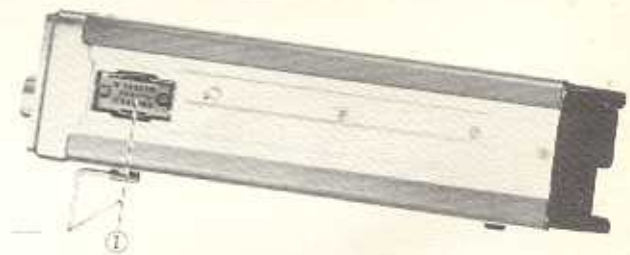

(1) KEYBOARD MIC JACK

When the keyboard microphone is used, its input is through this jack.

REAR APRON CONNECTIONS AND SWITCH

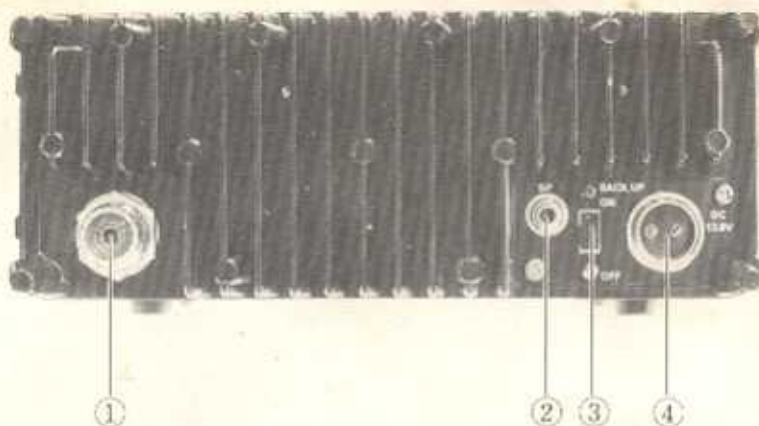

(1) ANT

This is the main antenna connector.

(2) EXT SP

This is a miniature phone jack for accommodation of an external speaker. Audio output impedance is 8 ohms, and the internal speaker will be cut off when an external speaker is used via this jack.

(3) BACKUP switch

When this switch is placed in the ON position, and DC power is still connected to the POWER

connector, the memory circuits will still be held in operating condition. If DC power is removed, though, the memorized frequencies will be lost.

(4) POWER

This receptacle accommodates the power cord. A fuse is located in the power cord, rated at 10 amps. WHEN REPLACING FUSES, BE CERTAIN TO USE A FUSE OF 10 AMPS RATING. OUR WARRANTY DOES NOT COVER DAMAGE CAUSED BY IMPROPER FUSE REPLACEMENT.

UNDERSIDE CABINET SWITCHES

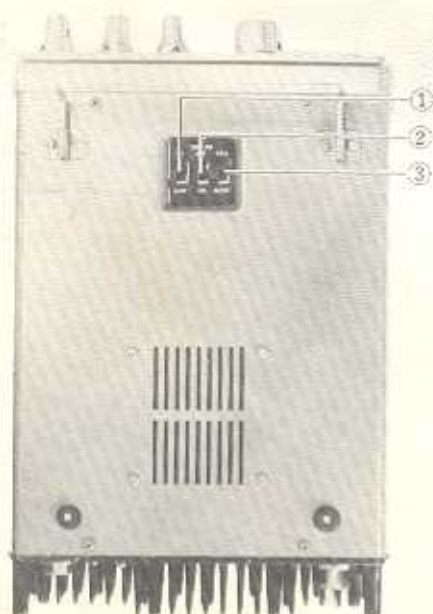

(1) LOW POWER SWITCH

In the LOW position, power output will be approximately 3 watts, and in the HIGH position, power output will be approximately 25 watts.

(2) TONE SQ

When the optional tone squelch unit is installed, placing this switch in the ON position will activate the subaudible encoder/decoder.

(3) BURST/CALL

When this switch is placed in the BURST position, a 1/2 second tone burst will be generated whenever the PTT switch is activated. In the CALL position, pressing the PTT switch will cause no tone to be sent. The front panel CALL button will send a tone and activate the PTT circuit for as long as the switch is pushed, regardless of the position of the BURST/CALL switch.

INSTALLATION

MOBILE INSTALLATION

For mobile service, the CPU-2500R should be installed where the digital display, controls, and microphone are easily accessible for operation. The transceiver may be installed in any position without loss of performance. A suitable location would be atop the transmission tunnel. A universal bracket is supplied with your transceiver for mobile installation. Refer to Fig. 1 for mounting details.

1. Use the universal mounting bracket as a template for positioning the mounting holes. Use a 3/16" diameter bit for drilling these holes, allowing clearance for the transceiver, its cables and microphone, and its controls. Secure the mounting bracket with the screws, washers, and nuts supplied, as shown in the drawing.
2. Ease the transceiver into the guide rail, and slide it into the desired position. Tighten the knobs on the outside of the universal bracket to secure the transceiver.
3. The microphone hanger may be installed wherever convenient for access to the microphone.

Power connections should be made directly to the automobile battery. Routing through the cigarette lighter may cause the lighter fuse to blow if the fuse is not of sufficient rating. As well, connection directly to the battery allows the memory circuits to remain activated when the ignition is turned off, using the BACK UP switch.

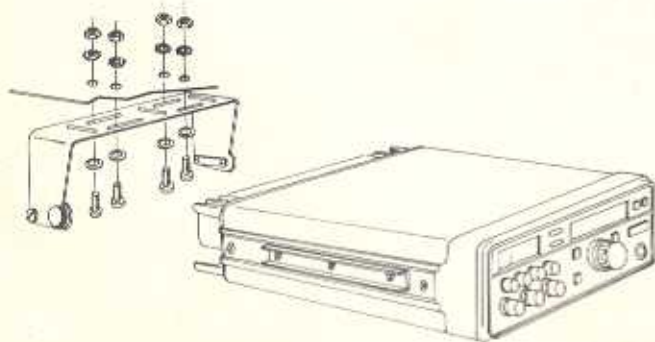

Figure 1

Connect the RED lead of the power cord to the POSITIVE (+) battery terminal, and connect the BLACK lead to the NEGATIVE (-) terminal. If it is necessary to extend the power cable, use #16 AWG insulated copper wire, and use the minimum length practicable to reduce voltage drop.

CAUTION

BEFORE CONNECTING THE POWER CABLE TO THE TRANSCEIVER, CHECK THE BATTERY VOLTAGE WITH THE ENGINE RUNNING (BATTERY CHARGING). IF THE VOLTAGE EXCEEDS 15 VOLTS DC, THE REGULATOR SHOULD BE READJUSTED SO THAT THE HIGHEST CHARGING RATE DOES NOT EXCEED 15 VOLTS. ALSO, BE ABSOLUTELY CERTAIN THAT THE CORRECT BATTERY POLARITY IS OBSERVED WHEN MAKING CONNECTIONS. REVERSED POLARITY WILL NOT DAMAGE THE CPU-2500R BECAUSE OF THE PROTECTIVE CIRCUITRY INCORPORATED IN DESIGN. HOWEVER, THE CPU-2500R WILL NOT OPERATE UNDER CONDITIONS OF REVERSED SUPPLY POLARITY.

Connect the power cable to the POWER receptacle on the rear apron, connect the coaxial cable from the antenna to the rear apron ANT receptacle, and connect the microphone to the jack appropriate for the microphone in use. An external speaker may be connected to the rear apron SP jack, if desired. Use the speaker plug supplied with the transceiver. Insertion of a plug into this jack automatically cuts off the internal speaker.

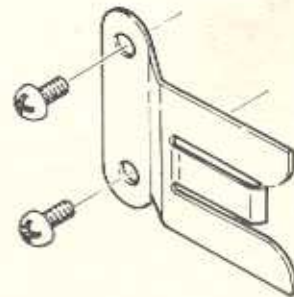

BASE STATION INSTALLATION

A base station mounting stand is supplied with your transceiver, to provide easier viewing of the display and controls. A power supply capable of supplying 7 amps at 13.6 VDC is required for operation from AC mains. See your Yaesu dealer.

ANTENNA CONSIDERATIONS

The CPU-2500R is designed for operation using an antenna presenting a 50 ohm resistive load. The automatic final transistor protection circuitry will reduce the power output to protect the transistors when a high antenna SWR is encountered. The SWR on the antenna should, if possible, be kept below 1.5:1 at all times to secure full output from the transceiver.

In most cases, coverage is a function of antenna height. The antenna for base station operation should be located as high and in the clear as possible. Vertical polarization is standard for FM communications in most areas, so be sure that your antenna is oriented appropriately. Popular antennas for base station use include the 5/8 wavelength vertical or one of the many stacked dipole arrays. For accessing repeaters a long distance away, a Yagi or other high gain directional array may be required.

For mobile applications, the most popular antennas are the 1/4 wavelength vertical and the 5/8 wavelength vertical, which shows approximately 3 dB gain over the 1/4 wavelength vertical. See your Yaesu dealer for details of the Yaesu RSE-series of antennas for mobile use.

Do not economize on coaxial cable, as much power can be wasted in lossy transmission line. For mobile use, the RG-58A/U type of coax may be used. To minimize loss, use the shortest length that is possible. For base stations, use type RG8A/U coaxial cable. For very long runs, type RG17A/U, aluminum-jacketed "foamflex" coax, or air dielectric "heliac" cable may be used.

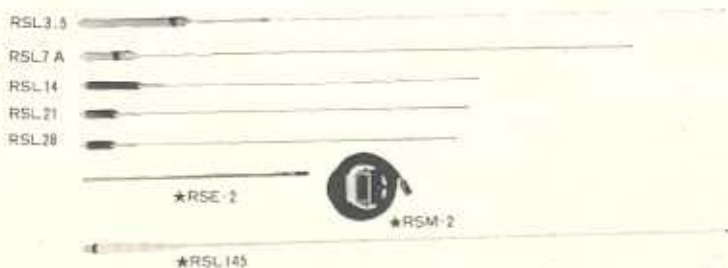

OPERATION

INITIAL CHECK

1. Rotate the VOL and SQL controls fully counterclockwise. Push the POWER switch to turn the transceiver on. The digital display should read 147.000 MHz (145.000 if your unit is designed only for 144–146 MHz operation).
2. Advance the VOL control to the point where background noise is plainly heard. If the channel is clear, advance the SQL control clockwise until the receiver is just silenced, and the BUSY lamp turns off. Do not advance the SQL control past this threshold point, so as not to degrade the sensitivity of the receiver to weak signals. The TONE SQ switch should be OFF for this adjustment.
3. Set the HI/LOW switch on the underside of the cabinet to the power level desired.

FREQUENCY SELECTION USING MAIN DIAL

When the transceiver is initially turned on, frequency control will be via the main tuning dial. After memory operation, pressing the DIL button will return control to the main dial. Rotate the dial to secure the operating frequency desired. As the synthesizer steps are 10 kHz increments, pressing of the 5 UP button is required for securing a frequency such as 147.955 MHz. When the upper or lower band edge is reached, the next synthesizer step will automatically be to the opposite band edge. Thus, after 147.990 MHz, the next step is to 144.000 MHz. When a repeater split frequency falls outside the amateur band, the transceiver will disable itself to prevent illegal operation.

Channel selection should not be made while the CPU-2500R is transmitting.

MEMORY OPERATION

In order to store a frequency selected per the preceding section, proceed as follows: rotate the MEMORY CHANNEL SELECTOR switch to the M1 position and press the MEMORY button. The frequency is now stored. Another frequency can be stored by rotating the MEMORY CHANNEL SELECTOR switch to M2, dialing another frequency, and pressing the MEMORY button again.

In like fashion, memory positions M3 and M4 may be programmed at the discretion of the operator.

To recall a memorized frequency, press the MR button. Now frequency control is in the memory circuitry. Rotating the MEMORY CHANNEL SELECTOR to positions M1–M4 will select the desired frequency. To return frequency control to the main tuning dial, push DIL.

For holding memorized frequencies after the transceiver is turned off, activate the rear apron BACK UP switch (before the CPU-2500R is turned off). Remember that power must be applied to the rear apron power connector for this backup function to be performed. Current drain during backup operation is approximately 30 mA.

SCANNER OPERATION

Press the front panel DIL and MAN switches. Pressing the UP switch will now cause the CPU scanner to scan higher in frequency in 10 kHz steps. Pressing the microphone PTT switch or the front panel CALL button will halt the scan without transmitting a signal. A second press of the PTT or CALL switch will cause the transmitter to be activated.

In like fashion, pressing the DOWN button will cause the scanner to scan lower in frequency. Press the PTT or CALL buttons to halt the scan.

If frequencies are programmed in the memory slots, pressing MR and either the UP or DOWN button will cause the four memory channels to be scanned. The scan may be halted as described previously.

To secure automatic stopping of the scan at a desired frequency, set the SCAN STOP switch to AUTO. Now, when the SCAN STOP MODE switch is in the BUSY position, the scanner will hold on the first channel it finds which is occupied (containing a signal strong enough to trip the squelch). When the SCAN STOP MODE switch is in the CLEAR position, the scanner will stop when it finds a clear channel. Note that, when the SCAN STOP MODE switch is in the BUSY position, the squelch must be adjusted to mute the receiver under no-signal conditions; otherwise, if the SQL control is fully counter-clockwise, for example, the scanner will only advance one channel at a time, thinking that a busy channel has been found.

When using the optional tone squelch, the auto scan is controlled by the main squelch, not the tone squelch. Thus, the scan may be halted in the BUSY mode by a signal not breaking the tone squelch.

When using the standard microphone, pressing the UP or DOWN switches on the microphone will have the same effect as the UP and DOWN switches on the front panel of the CPU-2500R.



KEYBOARD MICROPHONE YM 2500

KEYBOARD MICROPHONE OPERATION

The keyboard microphone for the CPU 2500R allows remote programming of memory frequencies, dialing in of transceive frequencies, remote actuation of the scanner, and remote programming of auxiliary splits for repeaters.

PTT and scanning operation is identical to that of the standard microphone.

When the PTT switch is depressed for transmission, the keyboard becomes a tone pad for accessing autopatch facilities on repeaters, or for other control purposes. The two-tone audio frequencies are shown in Fig. 2. VR₉₀₁, located on the MONITOR UNIT (PB-1897), sets the level for the speaker monitor of the two-tone signal. VR₉₀₁ sets the two-tone audio output level to the transmitter.

		HIGH TONE		
		1209Hz	1336Hz	1477Hz
LOW TONE	697Hz	1	2	3
	770Hz	4	5	6
	852Hz	7	8	9
	941Hz	*	0	#

Fig. 2

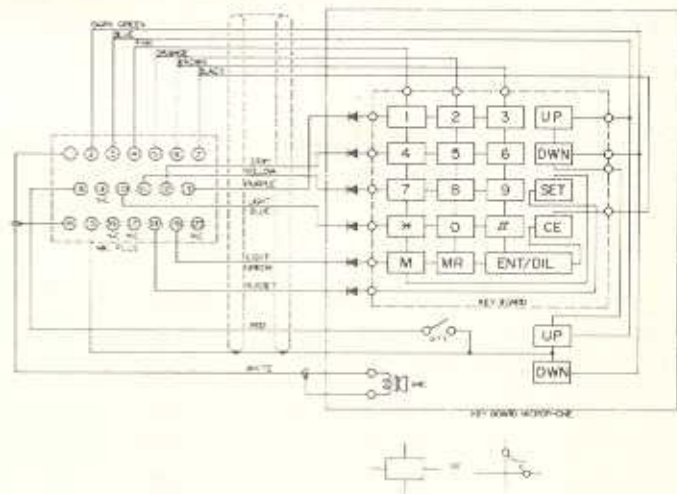
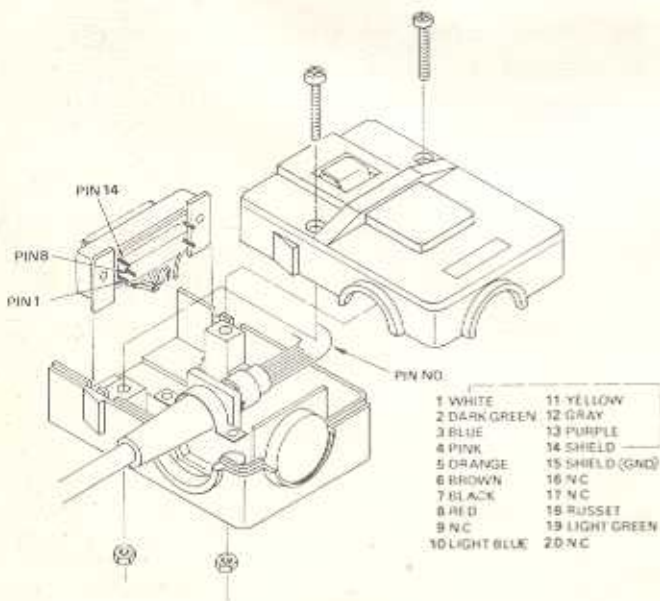

For dialing in an operating frequency, place the front panel MEMORY CHANNEL SELECTOR switch in the KEY position. To dial in 146.52 MHz, press "652" and DIL. 146.52 MHz will now be your operating frequency. Do not press "6520", as the final digit is already programmed. If four numbers are addressed, the display will, when you press DIL, indicate "14E. ___" which means an error has been made. Press CE (Clear Entry) to erase the mistake and return to the original operating frequency.

If you should press "6520" but not DIL, simply press "652" again, then DIL. The digits will simply be shifted in the register, making error correction easy. When "14E. ___" is displayed, the transmitter will not function, thus preventing out-of-band operation.

Press	Display	Comments
DIL	146.450	Original frequency.
6	14 . 60	Program 146.520 MHz.
5	14 .650	
2	146.520	
ENT/DIL	146.520	Correctly programmed.

To store 146.940 MHz in memory position M1, press "694" and DIL. Now press "1" and M on the keyboard. 146.940 MHz will now be stored in M1. To store 146.520 MHz in M2, press "652" and DIL, then press "2" and M. To recall 146.940 MHz, press "1" and MR. To recall 146.520 MHz, press "2" and MR. The other memory channels may be treated in like fashion.

Press	Display	Comments
	146.520	Original frequency.
6	14 . 60	Now program 146.940 MHz.
9	14 .690	
4	146.940	
ENT/DIL	146.940	Correctly entered.
1	14 . 10	Enter 146.940 into memory position 1.
M	146.940	Correctly stored in M1.

The following examples will demonstrate typical input errors when using the keyboard microphone, as well as the remedial action required.

OVERFLOW ERROR CORRECTION

Press	Display	Comments
	146.520	Original frequency.
6	14 . 60	Now program 146.940 MHz.
9	14 .690	
4	146.940	
0	14 . 00	Overflow.
ENT/DIL	14E. 0	Error.
CE	146.520	Return to original frequency, try again.
6	14 . 60	
9	14 .690	
4	146.940	
ENT/DIL	146.940	Correctly entered.

IMPROPER MEMORY CHANNEL PROGRAMMING

Press	Display	Comments
	146.520	Original frequency
6	14 . 60	Program 146.940 into memory.
9	14 .690	
4	146.940	
ENT/DIL	146.940	
5	14 . 50	
M	14E. 0	No memory position 5, error detected.
CE	146.940	Clear, return to programmed frequency.
2	14 . 20	Try again.
M	146.940	146.940 correctly stored in memory position, 2

SCANNING WITHOUT FREQUENCY DISPLAYED

Press	Display	Comments
	146.520	Original frequency.
6	146. 60	Program 146.940 MHz.
DN or UP	14 . 0	Scanning, no display.
CE	14 . 0	Scanning, no display, CE will not clear.
PTT sw.	146.680	Scan halted normally, scan stop frequency displayed.

USE OF OVERFLOW FOR ERROR CORRECTION

Press	Display	Comments
	146.520	Original frequency.
6	14 . 60	Program 146.940 MHz.
9	14 .690	
5	146.950	Pressed wrong button.
6	14 . 60	No need to clear, deliberately overflow.
9	14 .690	
4	146.940	
ENT/DIL	146.940	Correctly programmed.

FAILURE TO PRESS ENT/DIL

Press	Display	Comments
	146.520	Original frequency.
6	14 . 60	Program 146.940 MHz.
9	14 .690	
4	146.940	
PTT sw.	14E. 0	Transmit, did not press ENT/DIL.
PTT off	146.520	Returned to original frequency, no transmission occurred.
6	14 . 60	Try again.
9	14 .690	
4	146.940	
ENT/DIL	146.940	Correctly programmed.

ATTEMPTS TO PROGRAM OUTSIDE BAND

Press	Display	Comments
	146.520	Original frequency.
8	14 . 80	Program 148.880 MHz.
8	14 .880	
8	148.880	
ENT/DIL	14E. 0	Error, frequency outside band.
CE	146.520	Return to original frequency.
	146.520	Original frequency.
8	14 . 80	Mistake, intended to press 7.
CE	14 . 0	Clear register.
7	14 . 70	Program 147.390 MHz.
3	14 .730	
9	147.390	
ENT/DIL	147.390	Correctly programmed.
	146.520	Original frequency.
8	14 . 80	Program 148.880 MHz.
8	14 .880	
8	148.880	
ENT/DIL	14E. 0	Error, frequency outside.
DN or UP	14E. 0	Pressed scan switch with no frequency programmed.
CE	14E. 0	CE does not clear here.
PTT sw.	14E. 0	
CE	146.520	Return to original frequency.

REPEATER OPERATION

Repeater operation is easily accomplished with the CPU-2500R. Placing the front panel TX OFFSET SELECTOR switch in the +600 or -600 position will provide transmit frequency offset of +600 kHz or -600 kHz, respectively. In the United States, -600 kHz shift is generally used between 144 and 147 MHz, while +600 kHz is used above 147 MHz.

STANDARD ± 600 kHz REPEATER SHIFT OPERATION



Choose receive frequency on dial.
TX OFFSET to -600.

Press PTT switch; TX frequency displayed.



Choose receive frequency on dial. TX OFFSET to +600.



Press PTT switch; TX frequency displayed.

To program an auxiliary split when using the standard type microphone, set the CPU-2500R dial to the desired receive frequency (repeater output frequency). Rotate the MEMORY CHANNEL SELECTOR switch to the RM (Receive Memory) position. Press the MEMORY switch to store the receive frequency in memory. Now, rotate the main tuning dial to the desired transmitting frequency. Press the MR switch, and you will be receiving on the memorized frequency (stored in the M0 position), while transmitting on the dialed frequency. If you wish to change the transmit frequency, press DIL again, dial in a new TX frequency, press MR again, and the new combination will be programmed.

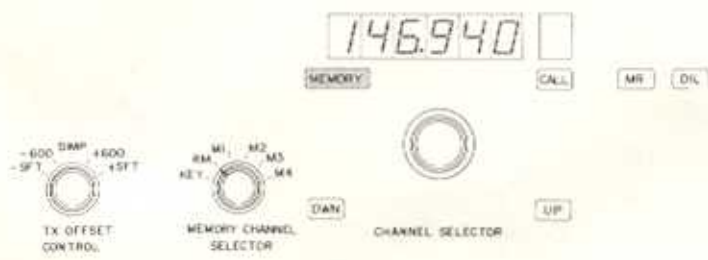

Choose receive frequency and press MEMORY switch. MEMORY CHANNEL SELECTOR to RM.

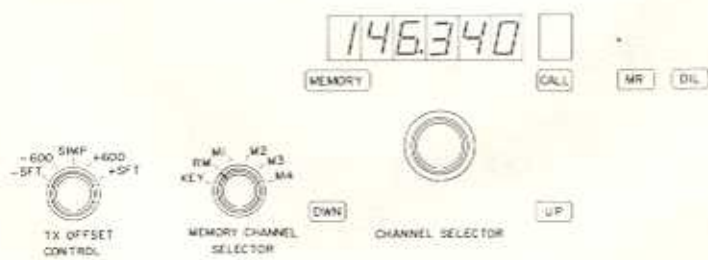

Choose transmit frequency.



Press MR switch to recall receive frequency.



Press PTT switch; TX on dial frequency.

When the keyboard microphone is used, the above operation is accomplished thus: dial in the desired receive frequency on the keyboard. Press DIL, "0" (zero), and M. Now dial in the desired transmit frequency on the keyboard, and press MR. The auxiliary split is now programmed. To program another TX frequency, press DIL, dial in the new frequency, press DIL, then press "0" M and MR to program the new split.

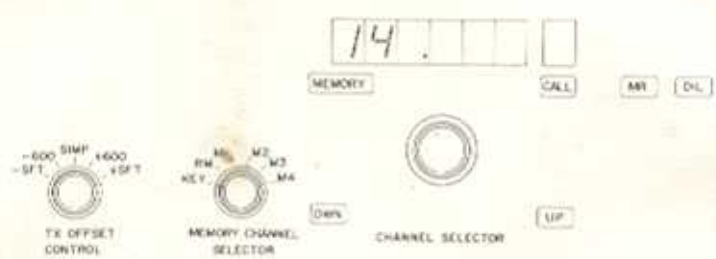

Set to KEY position.

Press	Display	Comments
	146.520	Original frequency.
6	14 . 60	Program 146.940 into Receive Memory (M0).
9	14 .690	
4	146.940	
ENT/DIL	146.940	Frequency now entered.
0	14 . 00	Store frequency in M0.
M	146.940	Frequency now stored correctly.
6	14 . 60	Program 146.240 as transmit frequency.
2	14 .620	
4	146.240	
ENT/DIL	146.240	Transmit frequency entered.
MR	146.940	SELECT sw. to RM. RX on 146.940.
PTT sw.	146.240	On the air, TX on 146.240.



Set to -SFT.

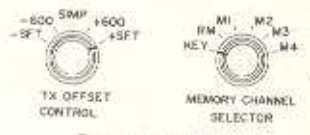

Set to +SFT.



± 600 kHz shift.



No shift.

If a particular frequency shift is frequently used, the shift may be programmed from the keyboard microphone. For example, to program a +700 kHz shift, dial in "70" on the keyboard, push SET, then place the TX OFFSET SELECTOR to the +SFT (+SHIFT) position.

Press	Display	Comments
	146.940	Original frequency.
7	14 . 70	Set automatic shift of 700 kHz.
0	14 .700	TX OFFSET SELECTOR TO -SFT.
SET	146.940	Shift of -700 kHz now programmed.
PTT sw.	146.240	On the air, TX on 146.240.

Place TX OFFSET SELECTOR to +SFT for +700 kHz shift.

This may be extended to any frequency within the operating range of the transceiver. For example, it is possible to program a shift of 2.2 MHz down as follows: dial in "220" on the keyboard, press SET, and then set the TX OFFSET SELECTOR to + or - SFT, as desired. If the shift is outside the amateur band, the display will indicate that an error has been made when the PTT switch is activated, thus preventing illegal operation.

Be careful when using alternative splits not to interfere with the operation of other users. For example, the inadvertant transmission of FM near 144.100 MHz might cause interference to weak-signal DXers or other operators using SSB or CW. **THINK BEFORE YOU SHIFT!**

Tone-actuated repeaters can be accessed by means of the built-in tone burst generator, which is activated by placing the BURST/CALL switch (cabinet bottom) in the BURST position. In this mode, pushing the microphone PTT switch will cause insertion of the burst signal at the beginning of each transmission. In the CALL position, pushing the front panel CALL button will activate the tone and the PTT for as long as the button is depressed.

The audio frequency of the tone burst signal may be programmed for any frequency between 671 and 2900 Hz, by use of a crystal and by positioning the selector plug on the tone burst unit. The US model normally is set up for 1800 Hz operation, and the European model for 1750 Hz operation. The charts will show the relation between the position of the selector plug, the crystal frequency, and the tone frequency. Moving the selector plug will change the tone frequency by a factor of two or four, as shown in the charts.

Tone Frequency (Hz)	Multiplier	Plug Position	Crystal Frequency (kHz)
671-1342	4096	A	2750-5500
1343-2685	2048	B	2750-5500
2686-2900	1024	C	2750-2970

Crystal frequency = Tone frequency × Multiplier.

Table 1

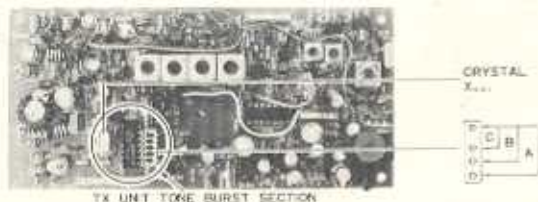

OPTIONAL TONE SQUELCH OPERATION

The optional tone squelch circuit consists of a sub-audible encoder and decoder which can provide selective communication on otherwise busy channels. The tone frequency is preset to 77 Hz at the factory.

When the TONE SQ switch on the bottom of the cabinet is placed in the ON position, the receiver will be quieted until a signal containing an identical audio tone is received, at which time the tone squelch will activate the receiver.

If other stations are present on the channel, without the tone squelch signal, the front panel BUSY lamp will light up, indicating that the channel is in use.

Before transmitting on a channel, make sure that the BUSY lamp is not lighted, to avoid interference to other users. The purpose of the tone squelch system is to provide silent listening on a channel where there are many stations calling. It is not designed to allow two stations equipped with tone squelch to have priority use of a channel.

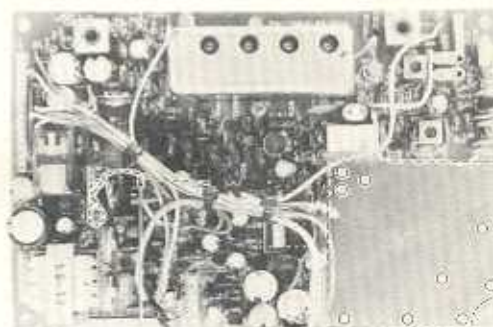

RED WIRE MUST BE CUT WHEN TONE SQUELCH UNIT INSTALLED.

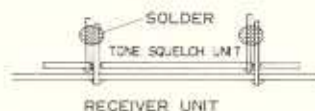

TONE SQUELCH INSTALLATION (OPTION)

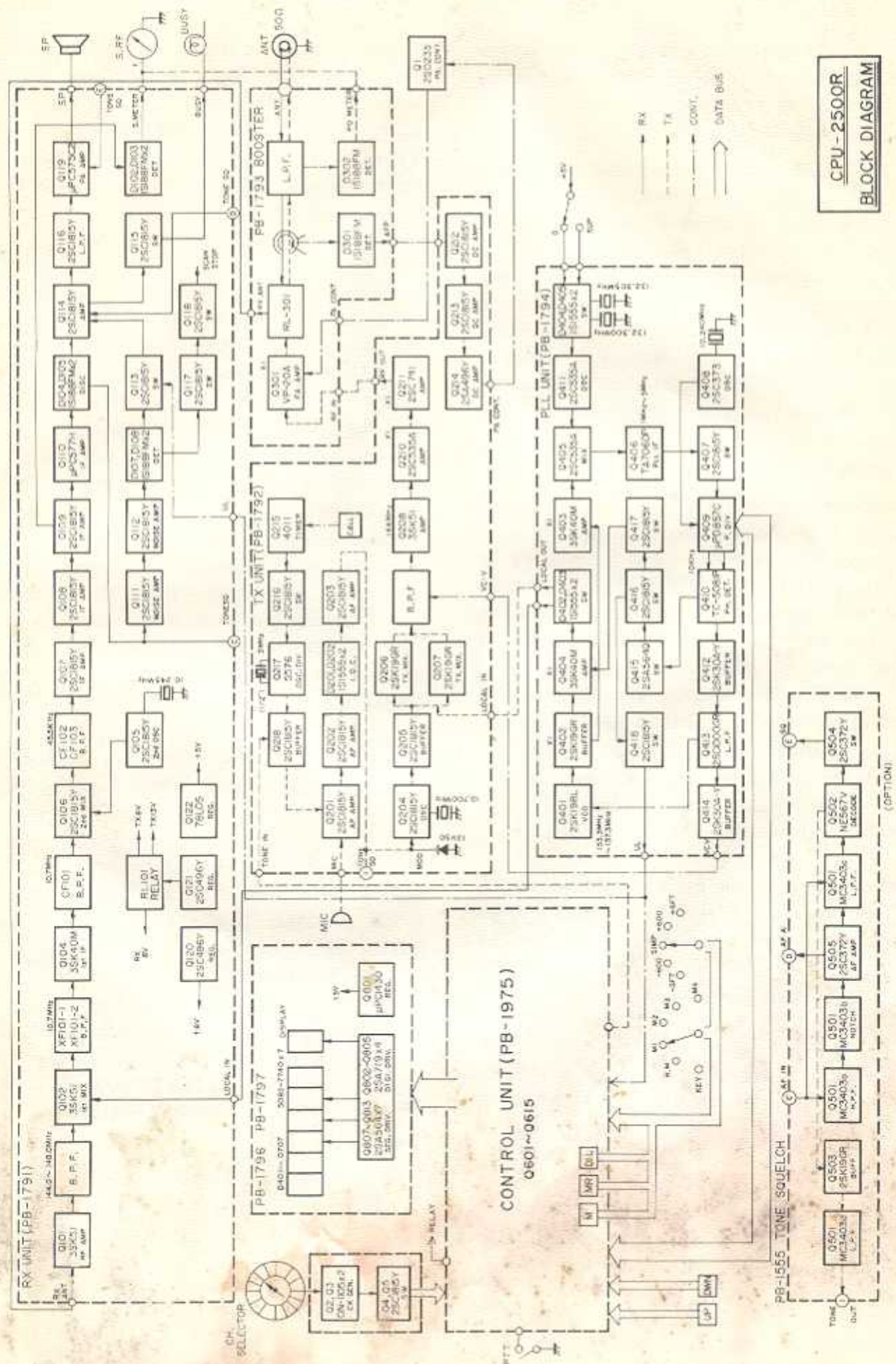

CPU-2500R
BLOCK DIAGRAM

CIRCUIT THEORY

The block diagram and circuit description to follow will provide you with a better understanding of this transceiver. Refer to the schematic diagram for specific component details.

The CPU-2500R consists of a transmitter and a double-conversion superheterodyne receiver. A phase lock loop synthesizer provides channel selection over the entire 144–148 MHz band, in conjunction with the optical coupling system. The frequency range may be limited at the factory to 144–146 MHz or 144–148 MHz, to conform to local regulations. Solid state circuitry is employed throughout the CPU-2500R, which is designed for operation from a 13.6 VDC \pm 10% negative ground power source.

TRANSMITTER

The transmitter produces a frequency modulated signal. The audio signal from the microphone is set to a proper level by VR₂₀₁, and is amplified by Q₂₀₁, Q₂₀₂, and Q₂₀₃ (2SC1815Y). The audio output from Q₂₀₂ is coupled to the instantaneous deviation control (IDC), where both positive and negative peaks are clipped by diodes D₁₀₁ and D₁₀₂ (1S1555). The output from Q₂₀₃ is fed through a low-pass filter consisting of C₂₁₃, L₂₀₁, and C₂₁₄, thus eliminating harmonics above the speech range caused by clipping. The deviation level is set by VR₂₀₂, and it is adjusted at the factory for a nominal deviation of \pm 5 kHz.

The speech signal is then applied to a phase modulator varactor diode D₂₀₃ (1SV50), which varies the frequency of the 10.7 MHz crystal controlled oscillator Q₂₀₄ (2SC1815Y). The frequency modulated 10.7 MHz signal is then amplified by buffer amplifier Q₂₀₅ (2SC1815Y) and fed to a balanced mixer consisting of Q₂₀₆ and Q₂₀₇ (2SK19GR). Here the signal is converted up to 144–148 MHz by mixing with the 133.3–137.3 MHz signal supplied from the VCO (voltage controlled oscillator) on the PLL UNIT. The output from the balanced mixer is fed through a bandpass filter consisting of T₂₀₃–T₂₀₆ to amplifiers Q₂₀₈ (3SK51), Q₂₀₉ (2SC535A), and Q₂₁₁ (2SC741), providing 200 mW of drive to the RF POWER UNIT. T₂₀₃–T₂₀₆ are tuned to the transmitting frequency by varactor diodes D₂₀₅–D₂₀₈ (1S2209). PA amplifier module Q₃₀₁ (VP-20A) provides 25 watts of RF energy through a diode switch and low-pass filter into a 50 ohm load.

A small portion of the RF output is rectified by diode D₃₀₂ (1S188FM); the resulting DC voltage is fed to the front panel meter for an indication of the relative power output from the transmitter. VR₃₀₃ allows setting of the relative power output meter deflection range. The DC output from D₃₀₂ is also fed to the control unit for activation of the ON AIR lamp while transmitting.

If the transmitter is activated without an antenna being connected, or if a high VSWR is present at the antenna receptacle, the reflected power is detected through T₃₀₁ and D₃₀₁ (1S188FM), producing a DC voltage. Q₂₁₂ (2SC1815Y) conducts with the application of DC voltage through VR₃₀₂, causing a decrease in the collector current of Q₂₁₃ (2SC1815Y). As a result, the collector voltage of Q₂₁₄ (2SA496Y) drops, causing Q₂₁₂ to decrease current and supply voltage to the PA transistor, thus protecting that component. The threshold level is set by VR₃₀₂. This circuit is also used to switch the power output down to 3 watts when the HIGH/LOW switch is placed in the LOW position. The amount of power reduction is set by VR₂₀₄.

The tone burst circuit consists of a timing generator and a gated multivibrator. With the BURST/CALL switch in the BURST position, a DC voltage is applied to trigger Q₂₁₅ (4011), which generates a pulse of 0.5–1 second duration. The pulse switches Q₂₁₆ (2SC1815Y) to supply DC voltage to Q₂₁₇ (MSM5576), where the clock signal is divided by 1024, 2048, or 4096, producing an accurate tone burst signal. The burst signal is fed to the base of microphone amplifier Q₂₀₁. The front panel CALL button provides a manual switch for actuation of the audio tone, as well as the transceiver PTT. The tone level is set by VR₂₀₆, while the burst length is set by VR₂₀₅.

RECEIVER

The input signal from the antenna is fed through a low-pass filter consisting of L₁, L₃₀₁, C₂, C₃₀₁–C₃₀₃, and C₃₁₃, and T/R relay RL₃₀₁, to RF amplifier Q₁₀₁ (3SK51), a dual-gate FET. The amplified signal is then fed through a four-stage high-Q coaxial resonator to the first mixer, Q₁₀₂ (3SK51). This front end configuration provides high immunity from cross modulation and other spurious responses, while providing a low system noise figure.

The 144–148 MHz signal is heterodyned with the first local oscillator, producing a 10.7 MHz first IF signal. The first local oscillator signal is delivered from the PLL VCO circuit. The first IF signal is fed through crystal filter XF-101, which has a passband of ± 15 kHz, and amplified by IF amplifier Q₁₀₄ (3SK51). The amplified IF signal is fed through CF-101, and then delivered to the second mixer, Q₁₀₆ (2SC1815Y), where the heterodyne signal of 10.245 MHz from Q₁₀₅ (2SC1815Y) is injected; the result is a 455 kHz second IF signal. CF-101, with a bandwidth of ± 200 kHz, prevents image responses (produced by mixing) from degrading receiver performance.

Cascaded ceramic filters CF₁₀₂ and CF₁₀₃ provide a ± 7.5 kHz bandwidth for the receiver. IF amplifiers Q₁₀₇–Q₁₀₉ (2SC1815Y) deliver the 455 kHz IF signal to Q₁₁₀ (μ PC577H), where any amplitude variation is eliminated. The signal is then delivered to ceramic discriminator CD₁₀₁ and diodes D₁₀₄ and D₁₀₅ (1S188FM).

The discriminator produces an audio output in response to a corresponding frequency shift in the IF signal. The audio output signal is amplified by Q₁₁₄ and Q₁₁₆ (2SC1815Y) for application across the VOLUME control VR_{1a} to the input of Q₁₁₉ (μ PC575C2), which delivers 1.5 watts of audio to the loudspeaker. The audio response is shaped by the low pass filter at Q₁₁₆.

A portion of the 455 kHz IF signal is rectified by D₁₀₂ and D₁₀₃ (1S188FM) for S-meter indication. VR₁₀₁ provides calibration of the S-meter deflection level.

When no carrier is present in the 455 kHz IF, the high frequency noise at the discriminator output is amplified by Q₁₁₁ and Q₁₁₂ (2SC1815Y) and detected by D₁₀₇ and D₁₀₈ (1S188FM), producing a DC voltage. This voltage activates switch Q₁₁₃ (2SC1815Y). As Q₁₁₃ conducts, the base of Q₁₁₄ is grounded, thus disabling the audio amplifier. When a carrier is present in the 455 kHz IF, the noise is removed from the discriminator output; the audio amplifier then returns to normal operation.

When the squelch circuit opens (Q₁₁₄ conducting), lamp driver Q₁₁₅ (2SC1815Y) draws current, causing the BUSY lamp to light up. The squelch is preset by VR₁₀₂, and VR_{1b} is the front panel SQL control.

HETERODYNE OSCILLATOR

The heterodyne signal is generated by the PLL (phase lock loop) circuit consisting of a voltage controlled oscillator (VCO), a reference crystal oscillator, a programmable divider, and a phase comparator.

VCO oscillator Q₄₀₁ (2SK19GR) generates a 133.3–137.3 MHz signal. The oscillator frequency is controlled by varactor diode D₄₀₁ (1S2209), which varies the capacitance of a tuned circuit consisting of L₄₀₁, TC₄₀₁, and C₄₀₄, C₄₀₆ in accordance with a DC voltage supplied from phase comparator Q₄₀₁ (TC5081).

The output signal from Q₄₀₁ is amplified by buffer amplifiers Q₄₀₂ (2SK19GR) and Q₄₀₄ (3SK40M) and fed through diode switch D₄₀₂/D₄₀₃ (1S1555) to the receiver or transmitter mixers.

A portion of the output from Q₄₀₄ is fed through buffer amplifier Q₄₀₃ (3SK40M) to a PLL mixer Q₄₀₅ (2SC535A), producing a 1–5 MHz PLL IF signal through mixing with the PLL heterodyne signal.

The PLL heterodyne signal is generated by an overtone-crystal-controlled oscillator Q₄₁₁ (2SC535A).

Diode switches D₄₀₄ and D₄₀₅ (1S1555) select the appropriate crystal in accordance with the TX OFFSET SELECTOR switch and the 5 UP switch. The output from Q₄₁₁ is fed to the PLL mixer Q₄₀₅.

Crystal oscillator Q₃₁₂ (2SC373) generates a 10.24 MHz signal, and its output is fed to scaler/divider Q₄₀₉ (μ PD857C), where a 10 kHz reference signal is produced.

Digital phase comparator Q₄₀₁ (TC5081P) compares the phase of the PLL IF signal with that of the reference signal, and any phase difference is converted into an error correcting voltage. This error correcting voltage is fed through buffer Q₄₁₂ (2SK30AY) and amplifier Q₄₁₃ (2SC1000GR) to varactor diode D₄₀₁, which changes the output signal phase to lock with that of the reference signal.

When the VCO is locked, the constant voltage at pin 4 of Q₄₁₀ is applied to Q₄₁₅ (2SA564Q), causing it to conduct; in turn, Q₄₁₆ (2SC1815Y) cuts off. The "H" voltage at the collector of Q₄₁₆ turns Q₄₁₇ (2SC1815Y) ON, supplying DC voltage to the earlier exciter stages Q₄₀₂ and Q₄₀₄. When the VCO is unlocked, the DC voltage at the emitter of Q₄₁₇ drops, preventing normal operation of Q₄₀₂ and Q₄₀₄.

The output voltage from Q₄₁₆ is reversed in polarity by Q₄₁₇ (2SC1815Y) and applied to Q₄₁₈ (2SC1815Y), keeping the collector of Q₄₁₈ "H" in order to drive the digital display. The voltage is also applied to Q₁₁₃ (2SC1815Y), which supplies DC voltage to audio amplifier Q₁₁₄.

When the VCO is unlocked, the collector DC voltage drops, causing the LED's to turn off; simultaneously, audio amplifier Q₁₁₄ is muted, silencing the receiver. The receiver remains muted until VCO lock is achieved.

PLL CONTROL

Control of the PLL circuitry is by means of a 4-bit central processing unit (CPU). The CPU controls frequency selection by means of the main tuning dial, the scanners, the memory, and the keyboard microphone. The necessary memory storage capability is provided for in a read-only memory, located within the CPU.

DISPLAY

The digital display consists of 7 seven-segment light emitting diode display digits, D₇₀₁-D₇₀₇ (5082-7740). Drivers Q₈₀₂-Q₈₀₅ (2SA719) and segment drivers Q₈₀₇-Q₈₁₃ (2SA564) provide the necessary input to drive the display correctly.

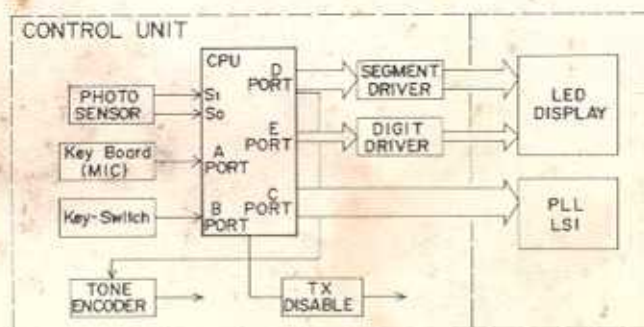
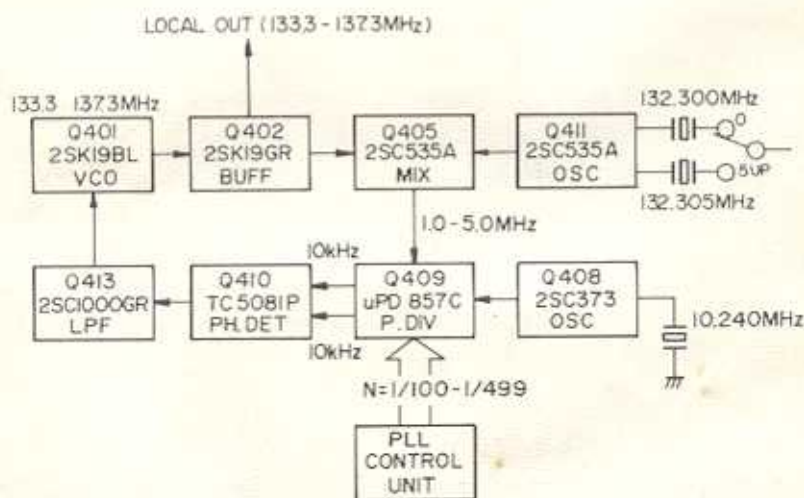

POWER SUPPLY

A DC 13.6 VDC is required for operation of the transceiver. DC 13.6 VDC is used for audio PA Q₁₁₉, relay RL₃₀₁, and the lamps. The supply voltage to the driver and transmitter PA is fed through voltage regulator Q₁ (2SD235), which is controlled by the HIGH/LOW switch and the automatic final protection circuit.

Voltage regulator Q₅₀₁ (μ PC14305) regulates the supply voltage at 5 VDC to supply the memory backup circuit, thus holding the memorized frequencies when the transceiver is turned off. Q₁₂₀ (2SC496Y) provides a regulated 8 VDC for the control circuitry. Q₁₂₁ (2SC496Y) provides 8 volts for the receiver strip and the transmitter low level circuits. Q₁₂₂ provides 5 VDC for the logic circuits.

OPTIONAL TONE SQUELCH CIRCUIT

The tone squelch circuitry permits selective calling and listening on otherwise busy channels. The encoder transmits a subaudible low-frequency tone, and the decoder mutes the receiver until a similar subaudible tone is received on an incoming signal. The tone signal can be set to any frequency within the range of 70–250 Hz.

The tone signal is generated by Q₅₀₂ (NE567); its frequency is set by R₅₁₆, VR₅₀₂, and C₅₁₆. The level of the tone signal is set by VR₅₀₄ and fed through buffer amplifier Q₅₀₃ (2SK19GR) to a low-pass filter consisting of the "d" unit of operational amplifier Q₅₀₁ (MC3403). The tone signal is then superimposed on the speech signal. The constants for setting the frequency are obtained from Table 2.

The audio output from the receiver discriminator is fed to unit "a" of Q₅₀₁. Unit "a" forms a high-pass filter, while unit "b" forms a T-notch filter. Both filters remove the tone signal from the audio signal which subsequently is fed through audio amplifier Q₅₀₅ (2SC372Y) to the receiver audio amplifier Q₁₁₄.

The tone signal passes through a low-pass filter at unit "c" of Q₅₀₁, and is fed to Q₅₀₂. When the tone frequency on the incoming signal matches that of the transmitted signal from the CPU-2500R, the voltage at pin 8 of Q₅₀₂ becomes low, causing Q₅₀₄ (2SC372Y) to switch off. In turn, proper bias is applied to Q₁₁₉ for normal operation.

Without a proper tone signal, Q₅₀₄ conducts, removing bias from Q₁₁₉, and hence disabling the audio circuit.

As the conventional squelch circuit is operative when the tone squelch is switched in, the BUSY lamp will light up when the channel is occupied, indicating that no transmission should be made out of courtesy to the other operators.

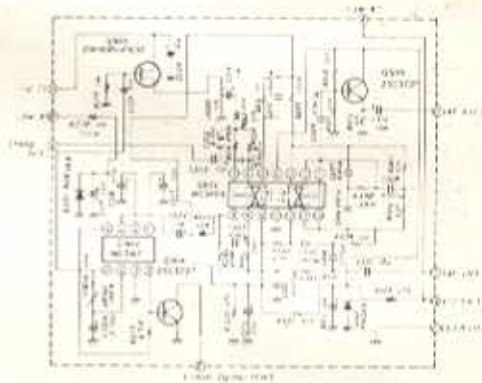

	C 516 *	R 516 *	R 517 *	R 518 *	R 524 *
70Hz + 160Hz	0.15 μ F	39K Ω	15K Ω	470K Ω	15K Ω
180Hz + 250Hz	0.1 μ F	39K Ω	8.2K Ω	270K Ω	8.2K Ω

Table 2

TONE SQUELCH UNIT (OPTION)

MAINTENANCE & ALIGNMENT

GENERAL

The CPU-2500R has been carefully aligned and tested at the factory prior to shipment. The reliability of the solid-state devices used in the CPU-2500R should provide years of trouble-free service if the transceiver is not abused, and if normal, routine maintenance is carried out.

THE FOLLOWING PRECAUTIONS SHOULD BE OBSERVED IN ORDER TO PREVENT DAMAGE TO THE TRANSCEIVER:

- (1) Do not exceed 15 volts DC at the power receptacle. When operating mobile, check the battery voltage under load (transmitter keyed) with the engine running fast enough that the ammeter shows a charge. As well, do not operate the CPU-2500R if the battery voltage is below 12 VDC.
- (2) Avoid prolonged exposure to direct sunshine, and do not expose the transceiver directly to water.

ROUTINE MAINTENANCE

Routine maintenance should be limited to keeping the transceiver clean, and making periodic checks of the transmitter power output and the receiver sensitivity.

Cleaning:

When the transceiver has been used in a dusty or sandy area, the interior may require periodic cleaning. A vacuum cleaner may be used for loose dirt, while caked or otherwise accumulated dirt may be removed with a soft brush. Check the interior to make sure that it is completely dry before replacing the case and operating the transceiver. The exterior may be wiped with a damp cloth as often as needed.

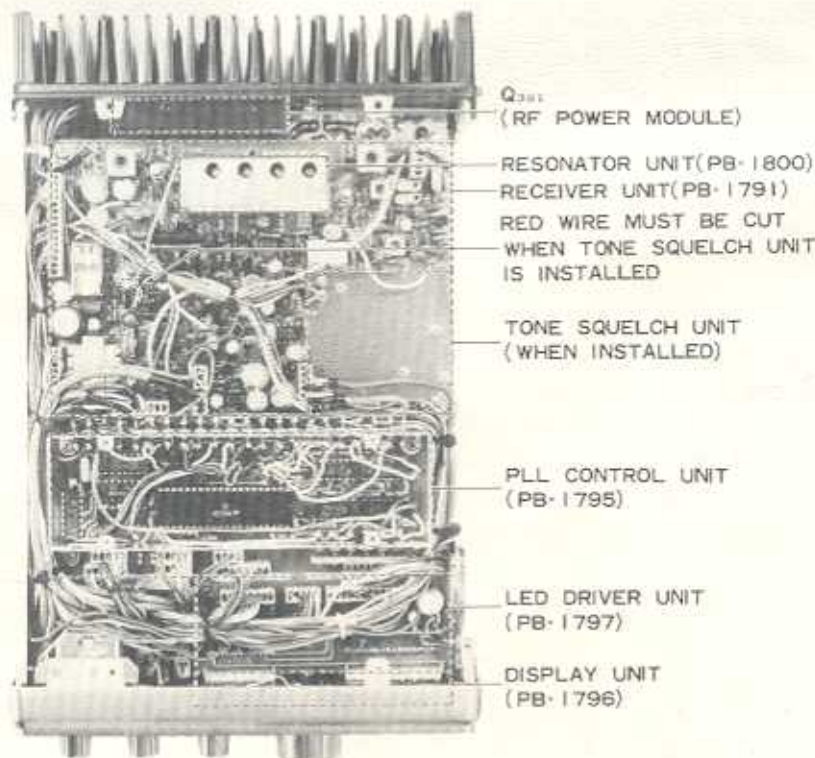

TOP VIEW

PERFORMANCE CHECKS

Make all performance checks at 13.5 VDC under load.

Check the transmitter output as follows:

- (a) Connect a suitable dummy load/RF wattmeter to the ANT receptacle.
- (b) Set the channel selector to any channel and key the transmitter. Observe the RF power output, which should be approximately 25 watts (HIGH). The S-meter should indicate between 6 and 8 on the relative output scale at full power.

Check the receiver sensitivity as follows:

- (a) Connect an AC voltmeter to the SP receptacle, and set the SQUELCH control fully counterclockwise.
- (b) Connect the RF output of a precision VHF signal generator to the ANT receptacle. Note the VTVM reading with no signal generator input. Adjust the VOLUME control and the

VTVM range, as required, to obtain approximately a full scale reading on the VTVM. Do NOT change the VOLUME control setting after this adjustment is made.

- (c) Set the signal generator to the receiving frequency of the transceiver, and adjust the output amplitude of the signal generator until the VTVM reads 1/100th (20 dB decrease) of the reading in step (b). The signal generator output voltage at this point is the 20 dB quieting sensitivity, and the level should be approximately $0.3 \mu\text{V}$.

If the above performance checks indicate the need for realignment, it is recommended that the unit be returned to your dealer for servicing. The sophisticated CPU and control circuitry, in particular, are so critical that they should not be touched by other than an experienced technician. Attempts to realign the transceiver tuned circuits without the proper test equipment may result in degraded transceiver performance.

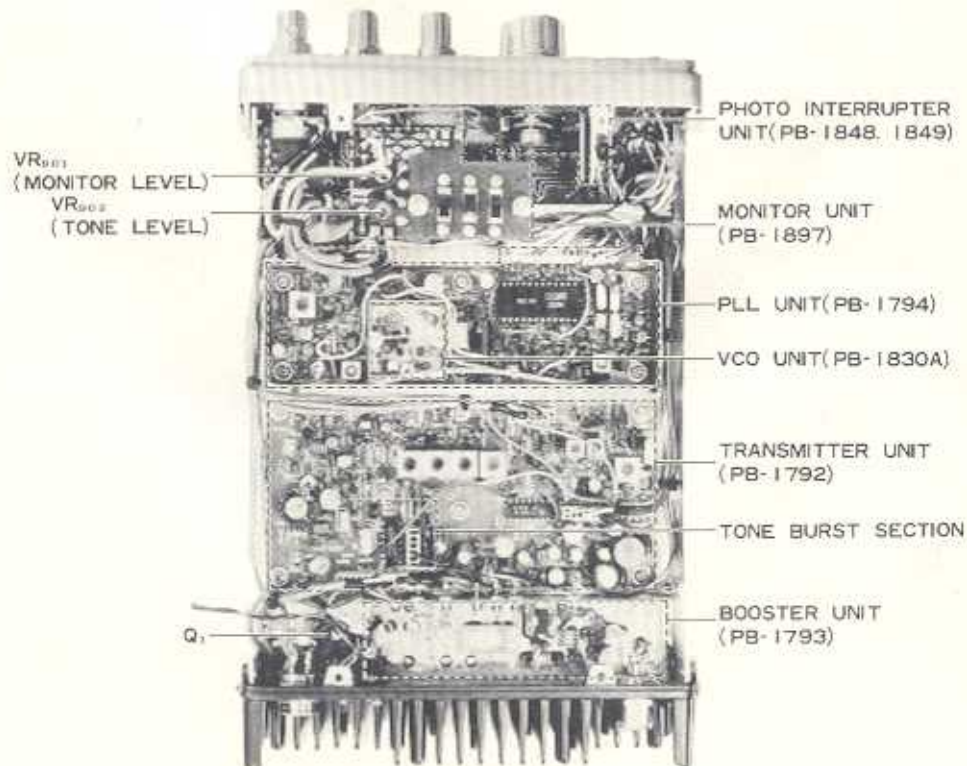

BOTTOM VIEW

ALIGNMENT

SOME OF THE FOLLOWING ALIGNMENT PROCEDURES REQUIRE SPECIALIZED TEST EQUIPMENT AND TECHNIQUES, AND SHOULD ONLY BE PERFORMED BY AN EXPERIENCED TECHNICIAN.

RECEIVER

(1) RF Amplifier

- a) Connect a calibrated VHF signal generator to the antenna receptacle, and set the channel selector to 147.000 MHz.
- b) Tune the signal generator to the receive frequency, and peak L₁₀₁, L₁₀₄, TC₁₀₁ - TC₁₀₄, T₁₀₁, and T₁₀₂ for a maximum S-meter reading.

(2) First IF Amplifier

- a) Connect a sweep generator to the second gate of Q₁₀₂. Connect an oscilloscope through a detector to the drain of Q₁₀₃.
- b) Set the frequency of the sweep generator to 10.7 MHz, and apply output from the generator. Adjust T₁₀₁ until the scope pattern illustrated in Figure 3 is obtained.

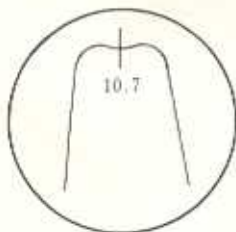

Fig. 3

- c) Disconnect the sweep generator and scope. Measure the RF injection voltage to the second gate of Q₁₀₅. A nominal value is 1 volt RMS.

(3) S-Meter Sensitivity

- a) Apply the output from the signal generator to the antenna receptacle. Peak T₁₀₃ for a maximum S-meter reading on the generator signal.
- b) Set the output level of the signal generator to 20 dB, and adjust VR₁₀₁ for a full-scale deflection of the S-meter.

(4) Noise Squelch Threshold

- a) Apply a 0 dB signal from the signal generator at 147.000 MHz.
- b) Set the front panel SQL switch to the fully clockwise position. Adjust VR₁₀₂ until the squelch just opens. Do not advance VR₁₀₂ past the threshold point.

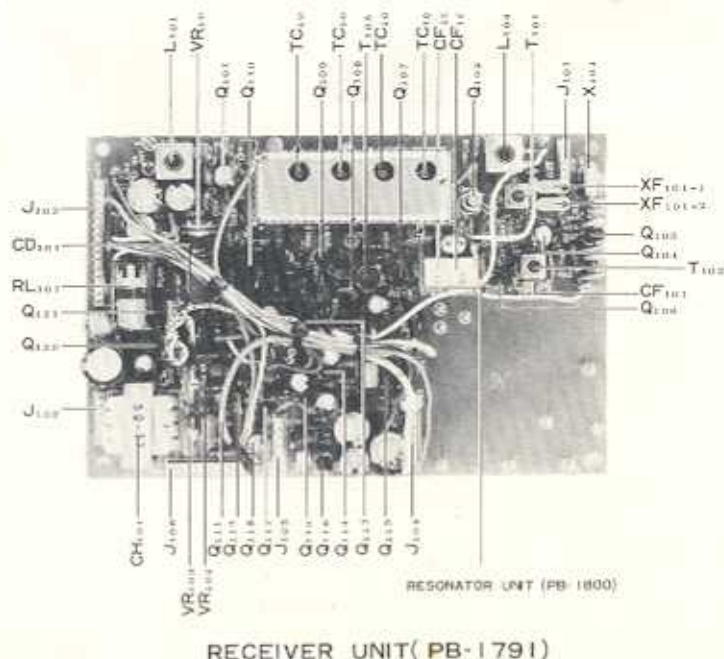
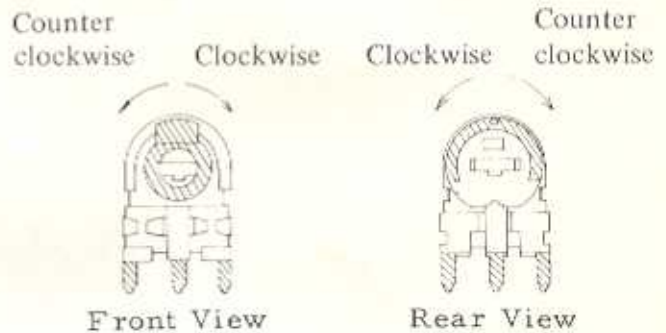

- c) Place the TONE SQ switch in the ON position. Set the signal generator output to -10 dB.
- d) Adjust VR₁₀₃ until the squelch threshold is found. Do not vary VR₁₀₃ away from the threshold point.
- e) Turn off the signal generator.
- f) Rotate the front panel SQL control until the squelch threshold is found. Back off on the SQL control very slightly so that the receiver is just muted. Now apply output from the signal generator. A signal of approximately -12 dB should be required to trip the squelch.

TRANSMITTER ALIGNMENT (Align at 146.000 MHz)

Note: When making the automatic final protection (AFP) circuit adjustment, be certain to follow the instructions regarding connection of the dummy load explicitly. If no load is connected when the AFP is out of alignment, the final transistor may be damaged.

(1) 10.7 MHz TX Alignment

- a) Connect the RF probe of a VTVM to TP₂₀₁.
- b) Adjust T₂₀₁ for a maximum indication on the VTVM. A nominal value is 550 mV RMS.
- c) Connect a frequency counter to TP₂₀₁, and adjust L₂₀₂ for a reading of 10.700 MHz ± 100 Hz on the counter.

(2) Mixer/Interstage Alignment

- a) Connect a dummy load/wattmeter to the antenna jack.
- b) Connect the RF probe of a VTVM to gate 1 of Q₂₀₈.
- c) Close the microphone PTT switch, and adjust T₂₀₁-T₂₀₆ for a maximum VTVM indication. A nominal reading is 100 mV RMS.
- d) Connect a DC voltmeter to TP₂₀₂, and adjust T₂₀₁-T₂₀₆ and TC₂₀₁ for a maximum reading on the DC voltmeter.
- e) Remove the DC voltmeter, and adjust T₂₀₁-T₂₀₆ and TC₂₀₁-TC₂₀₃ for maximum power output as indicated on the wattmeter.

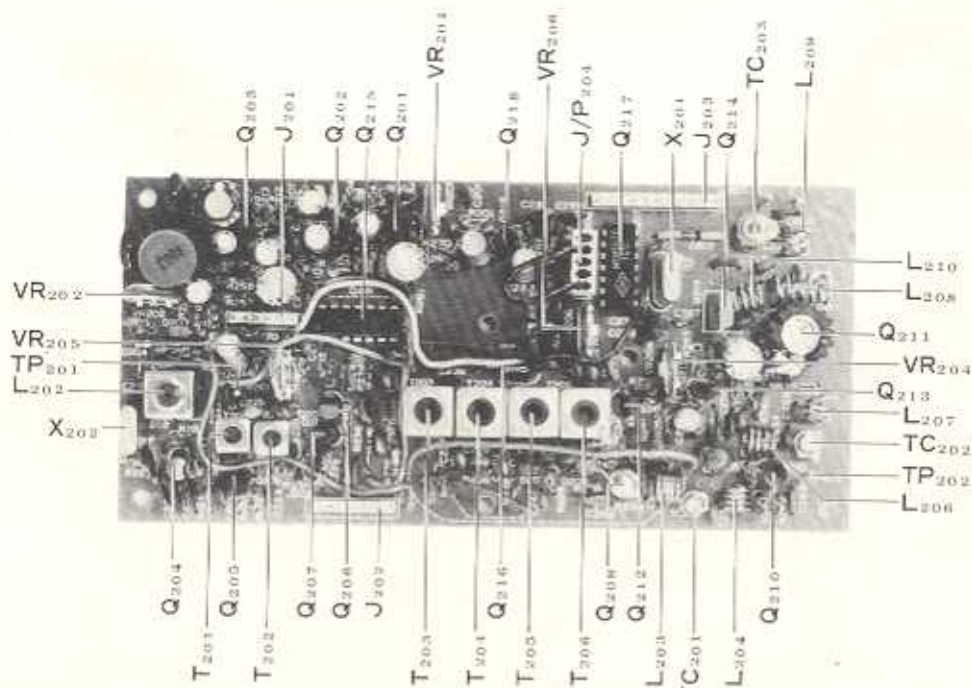

TRANSMITTER UNIT(PB-1792)

(3) Modulator Alignment

- Set up the test equipment as specified in Figure 4.
- As shown in Figure 4, set VR₂₀₁ and VR₂₀₂ to the center of their ranges. Apply a signal of 1 kHz at 25 mV from an audio oscillator connected to the microphone jack.
- Short the PTT connection at pin 4 of the mic jack to ground. Adjust VR₂₀₂ for an indication of ± 4.5 kHz on the deviation meter.
- Set the audio generator for an output of 2.5 mV. Adjust VR₂₀₁ for a deviation of ± 3.5 kHz as indicated on the deviation meter.

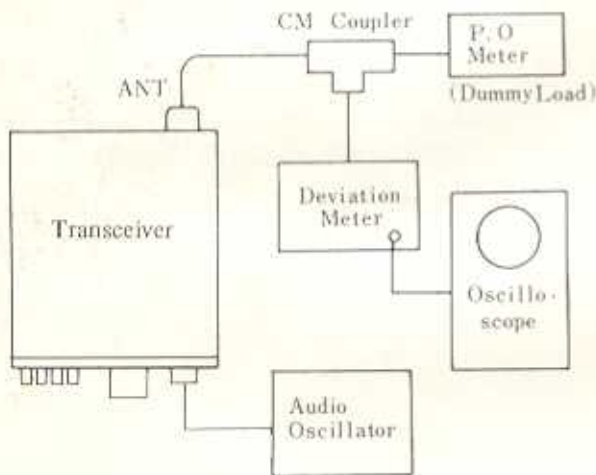

Fig. 4

(4) Tone Burst

- Push the front panel CALL switch.
- Connect an oscilloscope to the center pin of VR₂₀₂, and confirm that oscillation of the circuit is taking place.
- Connect a frequency counter to the center pin of VR₂₀₆, and confirm that the burst signal is of the proper frequency (1800 Hz for the USA model, etc.). Release the CALL switch.
- Return to step a) of section 3, "Modulator Alignment". Adjust VR₂₀₆ while pressing the CALL switch to establish that the FM deviation is ± 3.5 kHz with application of the burst signal. Release the CALL button after this alignment.
- While listening on a monitor receiver, place the BURST/CALL switch in the BURST position, and close the microphone PTT switch. Confirm that the burst signal is of the desired duration (factory set at 0.5 second). VR₂₀₅ provides adjustment of the burst length.

(5) AFP Circuit, PO Meter, and Local Output

- Connect a dummy load/wattmeter to the antenna receptacle.
- Connect a DC voltmeter (+) lead to the cathode of D₃₀₁, and the (-) lead to ground. Adjust VR₃₀₁ for minimum cathode voltage.

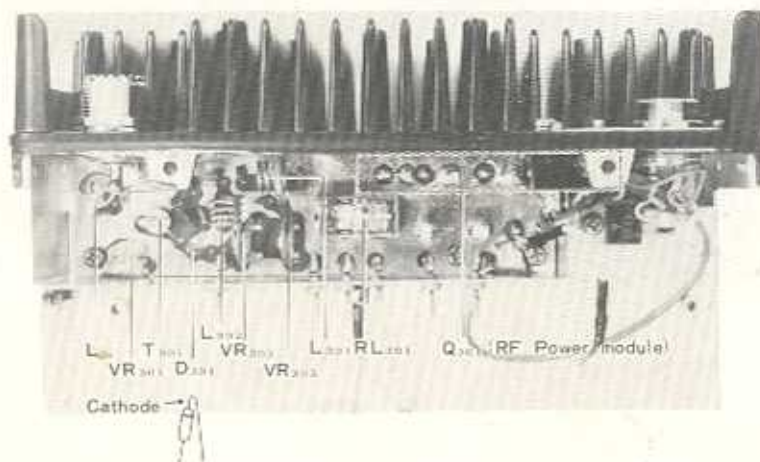

BOOSTER UNIT (PB-1793)

- c) Remove the dummy load/wattmeter from the antenna receptacle.
- d) Connect a DC ammeter with a 10 ampere full scale capability to the (+) lead of the power cord.
- e) While transmitting, adjust VR₃₀₂ for a reading of 2 amps on the DC ammeter.
- f) Reconnect the dummy load/wattmeter to the antenna receptacle. Adjust VR₃₀₃ for a reading of 8 on the front panel meter. This calibrates the relative output meter.
- g) To set the low power mode output power, set the power switch to the LOW position. Adjust VR₂₀₄ while transmitting for a reading of 3 watts output on the wattmeter.

(2) PLL Local, Multiplier Stages

- a) In the receive mode, connect the RF probe of a VTVM to the emitter of Q₁₁₁. Confirm that the stage is oscillating at a level of approximately 180 mV RMS.
- b) Connect a DC voltmeter using a 10 volt scale to TP₃. Adjust TC₄₀₁ to secure a voltage of 3.3 volts.
- c) Connect an oscilloscope to TP₂, and adjust T₄₀₂ and T₄₀₃ for a maximum deflection on the scope.
- d) Connect the RF probe of a VTVM to the cathodes of D₄₀₂/D₄₀₃. Adjust T₄₀₁ for a maximum reading on the VTVM. A nominal reading is 540 mV RMS.

(3) PLL Local Frequency

- a) Connect a frequency counter to the cathodes of D₄₀₂/D₄₀₃.
- b) Adjust TC₄₀₃ for a reading of 135,300 MHz ± 100 Hz on the counter.
- c) Press the front panel 5 UP button, and adjust TC₄₀₄ for a reading of 135,305 MHz ± 100 Hz on the counter.

(4) UNLOCK Circuit

- a) Short TP₂ to ground. Digits 3, 4, and 5 of the display should be blanked to indicate PLL unlock.

PLL ALIGNMENT

(1) 10.240 MHz Oscillator Alignment

- a) Connect the RF probe of a VTVM to the emitter of Q₄₀₈. Confirm that oscillation is taking place at a level of approximately 1.1 V RMS.
- b) Connect a frequency counter to TP₁, located on the PLL Unit. Adjust TC₄₀₂ for a reading of exactly 5.1200 MHz.

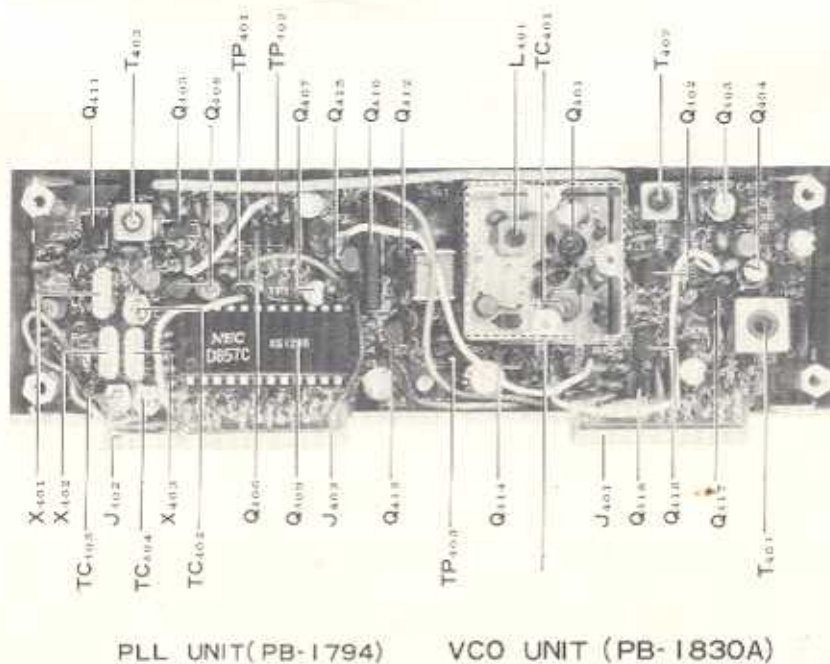

PLL CONTROL, DISPLAY UNITS

The CMOS circuitry used in these units is extremely critical in its adjustment. Under no circumstances should this circuitry be touched for alignment purposes.

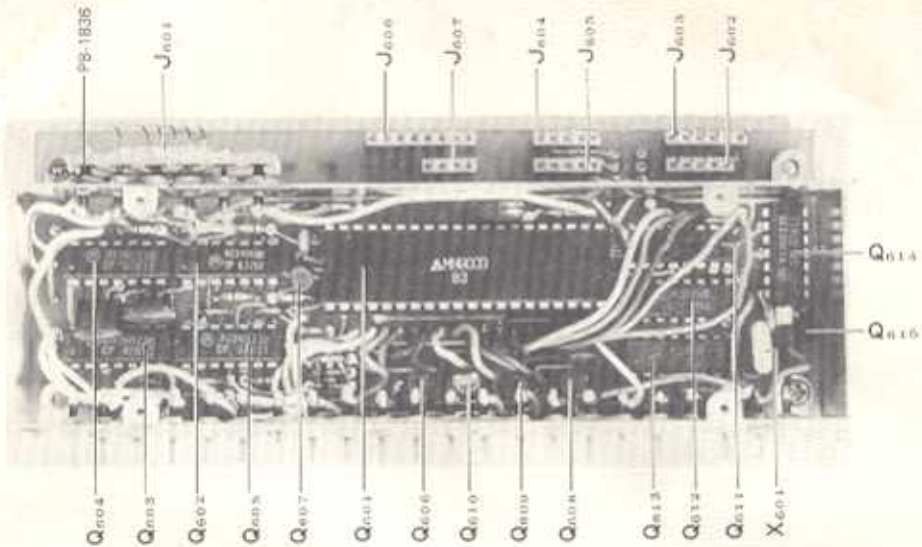

PLL CONTROL UNIT (PB-1795)

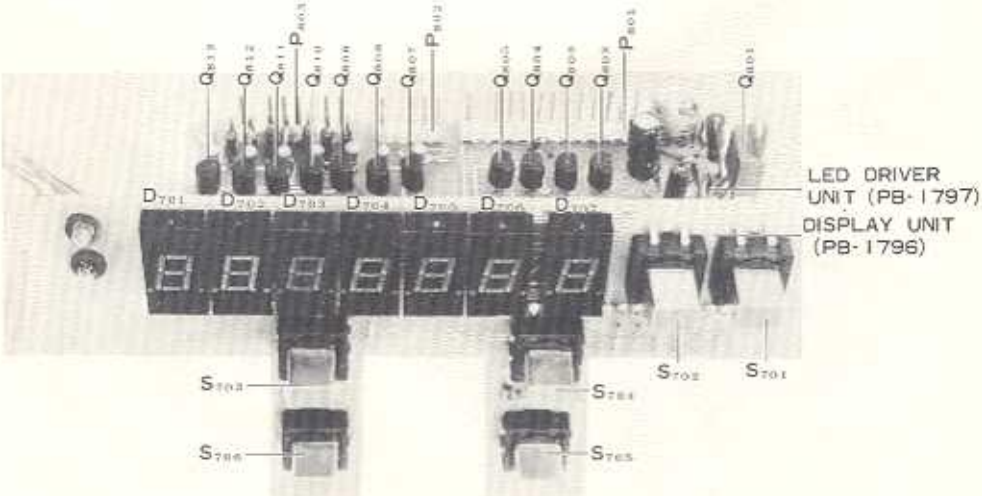

LED DRIVER UNIT (PB-1797)
DISPLAY UNIT (PB-1796)

TRANSISTOR & IC CONNECTIONS

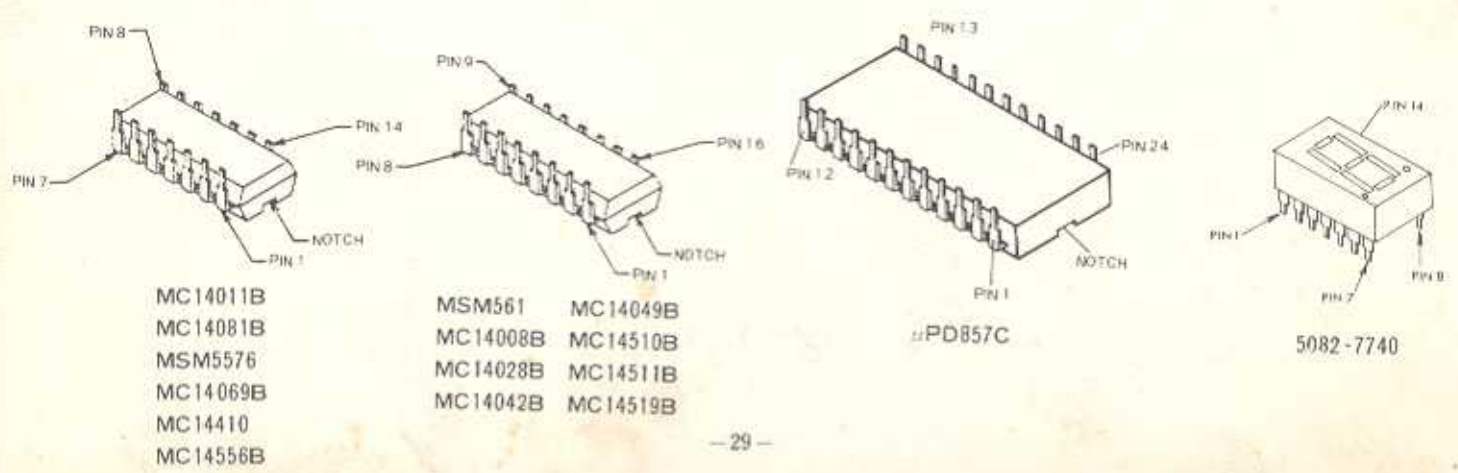
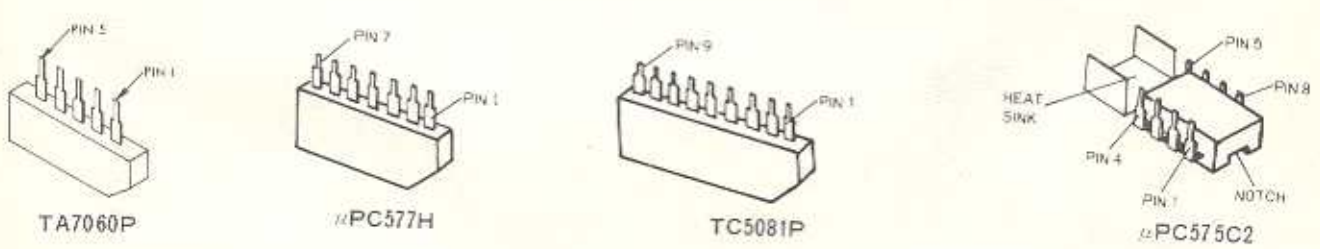
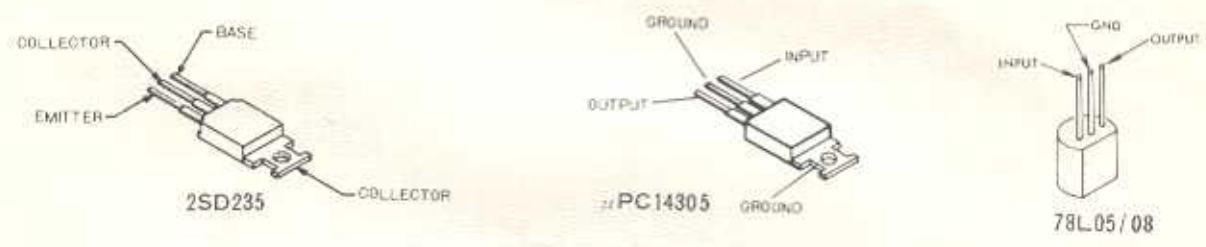
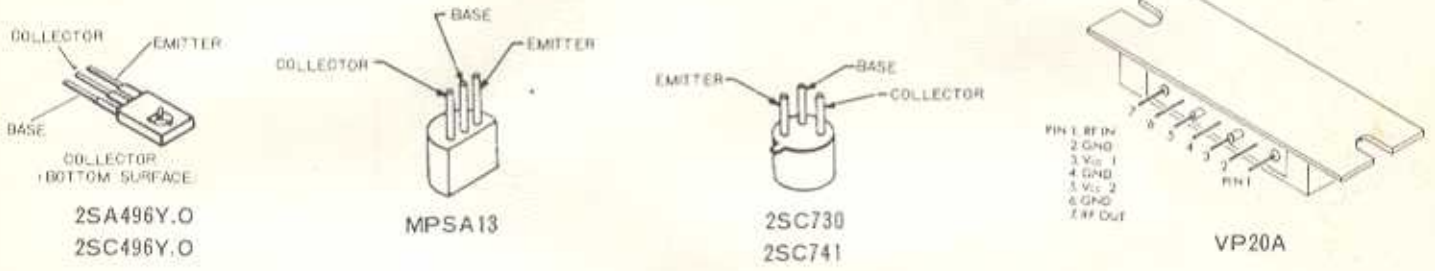
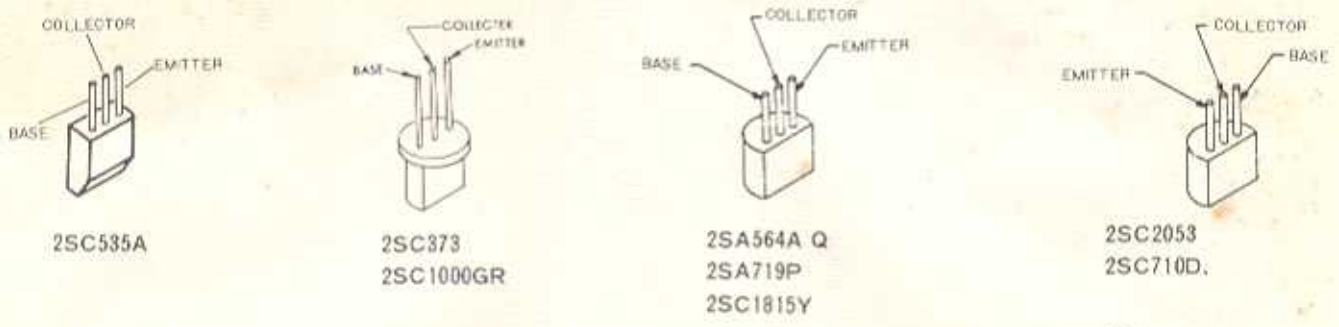
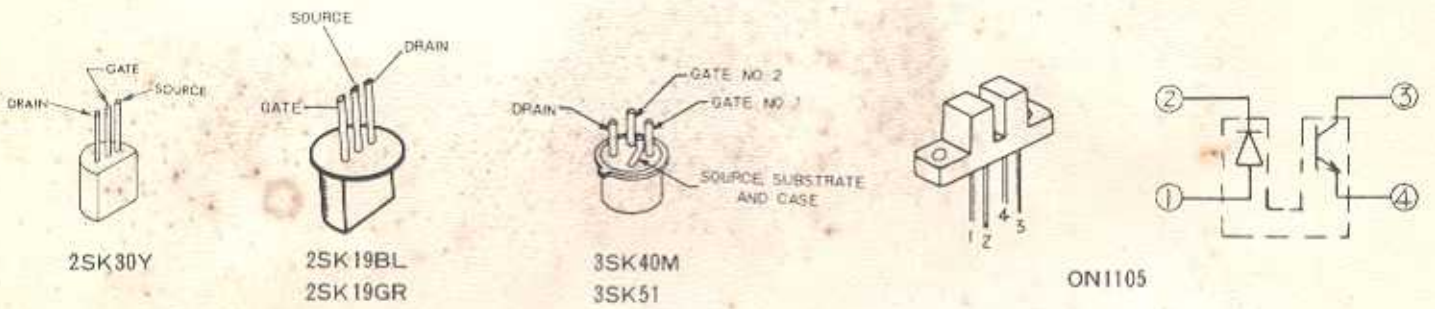

Q409 (μ PD857C) PROGRAMMABLE DIVIDER CODE

Q 409 PIN NUMBER →		1	2	3	4	5	6	7	8	9	10	11
P/J403 →		1	2	3	4	5	6	7	8	9	10	11
DIAL DISPLAY ↓	PROGRAMMABLE DIVIDER RATIO ↓	P_1	P_2	P_3	P_4	P_5	P_6	P_7	P_8	P_9	P_{10}	P_{11}
		144.000	1/100	0	0	0	0	0	0	0	0	1
4.010	1/101	1	0	0	0	0	0	0	0	1	0	0
4.020	1/102	0	1	0	0	0	0	0	0	1	0	0
4.030	1/103	1	1	0	0	0	0	0	0	1	0	0
4.040	1/104	0	0	1	0	0	0	0	0	1	0	0
4.050	1/105	1	0	1	0	0	0	0	0	1	0	0
4.060	1/106	0	1	1	0	0	0	0	0	1	0	0
4.070	1/107	1	1	1	0	0	0	0	0	1	0	0
4.080	1/108	0	0	0	1	0	0	0	0	1	0	0
4.090	1/109	1	0	0	1	0	0	0	0	1	0	0
144.100	1/110	0	0	0	0	1	0	0	0	1	0	0
4.110	1/111	1	0	0	0	1	0	0	0	1	0	0
4.120	1/112	0	1	0	0	1	0	0	0	1	0	0
4.130	1/113	1	1	0	0	1	0	0	0	1	0	0
4.140	1/114	0	0	1	0	1	0	0	0	1	0	0
4.150	1/115	1	0	1	0	1	0	0	0	1	0	0
4.160	1/116	0	1	1	0	1	0	0	0	1	0	0
4.170	1/117	1	1	1	0	1	0	0	0	1	0	0
4.180	1/118	0	0	0	1	1	0	0	0	1	0	0
4.190	1/119	1	0	0	1	1	0	0	0	1	0	0
144.200	1/120	0	0	0	0	0	1	0	0	1	0	0
4.300	1/130	0	0	0	0	1	1	0	0	1	0	0
4.400	1/140	0	0	0	0	0	0	1	0	1	0	0
4.500	1/150	0	0	0	0	1	0	1	0	1	0	0
4.600	1/160	0	0	0	0	0	1	1	0	1	0	0
4.700	1/170	0	0	0	0	1	1	1	0	1	0	0
4.800	1/180	0	0	0	0	0	0	0	1	1	0	0
4.900	1/190	0	0	0	0	1	0	0	1	1	0	0
145.000	1/200	0	0	0	0	0	0	0	0	0	1	0
5.010	1/201	1	0	0	0	0	0	0	0	0	1	0
5.020	1/202	0	1	0	0	0	0	0	0	0	1	0
5.030	1/203	1	1	0	0	0	0	0	0	0	1	0
5.040	1/204	0	0	1	0	0	0	0	0	0	1	0
5.050	1/205	1	0	1	0	0	0	0	0	0	1	0
5.060	1/206	0	1	1	0	0	0	0	0	0	1	0
5.070	1/207	1	1	1	0	0	0	0	0	0	1	0
5.080	1/208	0	0	0	1	0	0	0	0	0	1	0
5.090	1/209	1	0	0	1	0	0	0	0	0	1	0
145.100	1/210	0	0	0	0	1	0	0	0	0	1	0
5.200	1/220	0	0	0	0	0	1	0	0	0	1	0
5.300	1/230	0	0	0	0	1	1	0	0	0	1	0
5.400	1/240	0	0	0	0	0	0	1	0	0	1	0
5.500	1/250	0	0	0	0	1	0	1	0	0	1	0
5.600	1/260	0	0	0	0	0	1	1	0	0	1	0
5.700	1/270	0	0	0	0	1	1	1	0	0	1	0
5.800	1/280	0	0	0	0	0	0	0	1	0	1	0
5.900	1/290	0	0	0	0	1	0	0	1	0	1	0
146.000	1/300	0	0	0	0	0	0	0	0	1	1	0
147.000	1/400	0	0	0	0	0	0	0	0	0	0	1
147.990	1/499	1	0	0	1	1	0	0	1	0	0	1

*1 HIGH LEVEL (5V)
*0 LOW LEVEL (0V)

PARTS LIST

R131, 140, 142, 143	40143471	Carbon Film	1/2W VJ	470Ω				INDUCTOR
R102	40143102	*	*	1KΩ	L101, 104	54140910	R12-4091	#220105
R155, 161	40143152	*	*	1.5KΩ	L102	53020004	Micro Inductor FL-4H 2R2M 2.2μH	
R132, 145, 175	40143222	*	*	2.2KΩ	L105	53010004	*	220μH
R119, 120, 134, 137, 151, 153	40143332	*	*	3.3KΩ	L106-108	53020009	* *	FL-5H 102K 1mH
R128, 130, 167	40143472	*	*	4.7KΩ				
R116, 136, 146, 147, 154	40143562	*	*	5.6KΩ				AF CHOKE
R164, 165, 180	40143862	*	*	8.2KΩ	CH101	52000063		#50-13
R125, 126, 148, 157	40143103	*	*	10KΩ				
R124	40143153	*	*	15KΩ				
R104, 105, 129, 135, 149, 170	40143223	*	*	22KΩ				TRANSFORMER
R101, 107, 108, 121, 122, 139, 141, 159, 172, 179	40143473	*	*	47KΩ	T101, 102	55000185	3005	#220187
R156	40143563	*	*	56KΩ	T103	55003084	7MC-312162NO	#220188
R150, 152, 158, 162, 163, 171	40143104	*	*	100KΩ				RELAY
R174	40143124	*	*	120KΩ	RI-101	70000036	AW-6221-10C12V	
R173	40143154	*	*	150KΩ				MINI CONNECTOR
					P101	67040007	5048-04A	
					P102, 104	67050005	5048-05A	
		THERMISTOR			P105	67060004	5048-06A	
TH101	29090001	SDT-250			P106	67080006	5048-08A	
					P103	67140001	5048-14A	
		POTENTIOMETER						
VR102	49902502	TR-11R300		5KΩB				
VR101, 103	49902103	*		10KΩB	J101	68040009	5047-04 with wire	#240105
					J102	68050006	5047-05 *	#240101
					J104	68050007	5047-05 *	#240104
		CAPACITOR			J105	68060015	5047-06 *	#240100
C120, 125	31820030	Ceramic disc	50WV CH	3PF	J106	68080008	5047-08 *	#240099
C101, 102	31820100	*		CH 10PF	J103	68140008	5047-14 *	#240105
C133	31829100	*		SL 10PF				
C160	31829200	*		SL 20PF				
C129	31820470	*		CH 47PF				
C141	31829101	*		SL 100PF				
C130, 131	31829151	*		SL 150PF		56000024	Ferrite Beads 4A-R1 3×3-1	
C116, 118, 123, 144, 177, 180, 186	30820102	*		0.001μF		91100008	Wrapping Terminal C.	
C103-106, 108, 117, 122, 124, 126, 127, 135, 139, 188	30820103	*		0.01μF				
C128, 132, 134, 140, 187	30820473	*		0.047μF				
C136, 138, 150, 153, 158	36825102	Mylar Film	*	0.001μF				
C172	36825472	*	*	0.0047μF				
C142, 145, 151, 157, 159, 162, 171	36825103	*	*	0.01μF				
C154-156, 174, 176	36825223	*	*	0.022μF				
C137, 143, 146-149, 152, 161, 164, 175, 195	36825473	*	*	0.047μF				
C183	36825104	*	*	0.1μF				IC, FET & TRANSISTOR
C194	36526104	Tantalum	35WV	0.47μF	Q215	25000114	IC	MCI4011B
C167, 170	34820105	Electrolytic	50WV R	1μF	Q217	25000155	*	MSM5576
C163, 166, 169, 178	34320475	*		25WV R 4.7μF	Q206, 207	22800195	FET	2SK19GR
C165, 173, 191, 192	34220106	*		16WV R 10μF	Q208	23800510	*	3SK51
C179, 182	34120476	*		10WV R 47μF	Q214	22104964	Transistor	2SA496Y
C168, 185, 190	34120107	*		100μF	Q210	22305351	*	2SC2053
C181, 184, 193	34220107	*		16WV R 100μF	Q211	22307410	*	2SC741
C189	34220108	*		R 1000μF	Q201-205, 212, 213, 216, 218	22318154	*	2SC1815Y

PARTS LIST

		DIODE		C222	31829470	Ceramic disc	50WVSL 47PF
D201, 202, 209, 212	21015550	Silicon Diode	1S1555	C219, 220	31820101	"	* CH 100PF
D204	29090004	Varistor *	MV-103	C217	31827101	"	* UJ 100PF
D203	21090108	Varactor *	1SV50	C201, 204, 216, 243, 248	30820102	"	* 0.001µF
D205-208	21022090	"	1S2209	257-259, 263, 266, 267			
				272, 273, 286, 287			
		CRYSTAL		C221, 223, 224, 228, 229	30820103	"	* 0.01µF
X201	71500174	HC-25/U	1800Hz, $\pm 100\mu\text{Hz}$ 210060-1	233-235, 246, 247, 249			
	71500188	"	1750Hz, $\pm 100\mu\text{Hz}$ 210061-2	250, 253, 256, 260, 265			
		"	option 210061-3	269			
X202	71800113	HC-18/U	10.7MHz 210049	C288	30820473	"	* 0.047µF
				C284, 285	30825103	Ceramic Chip	25WV 0.01µF
		RESISTOR		C280, 281	36825472	Mylar Film	50WV 0.0047µF
R250	41143470	Carbon Film	1/4W Tj 47Ω	C270, 277-279	36825103	"	* 0.01µF
R243, 244, 248	40143560	"	VJ 56Ω	C202	36825223	"	* 0.022µF
R236	41143101	"	TJ 100Ω	C213, 214	36825473	"	* 0.047µF
R201, 208, 225, 256, 270	40143101	"	VJ 100Ω	C274	36526104	Tantalum	35WV 0.1µF
R221	41143221	"	TJ 220Ω	C271	36526474	"	* 0.47µF
R215, 231-233	40143221	"	VJ 220Ω	C205	36226106	"	16WV 10µF
R254	40143471	"	* 470Ω	C206, 208, 215, 264, 282	34820105	Electrolytic	50WV R 1µF
R209	40143561	"	* 560Ω	C209, 212, 268, 283	34220106	"	16WV R 10µF
R206, 216, 224, 228, 263	40143102	"	* 1KΩ	C207	34120476	"	10WV R 47µF
269				C261	34220476	"	16WV R 47µF
R203	40143182	"	* 1.8KΩ	C203, 210	34120107	"	10WV R 100µF
R246, 255	40143222	"	* 2.2KΩ	C211	34120227	"	10WV R 220µF
R210	40143272	"	* 2.7KΩ				
R204	40143332	"	* 3.3KΩ				
R249, 251-253, 257	40143472	"	* 4.7KΩ				
264, 268						TRIMMER CAPACITOR	
R202, 219	40143562	"	* 5.6KΩ	TC201, 202	39000010	ECV-1Z/W	10×53 10PF
R205, 212, 213, 226, 229	40143103	"	* 10KΩ	TC203	39000005	ECV-1Z/W	50×32 50PF
230, 247, 258, 261							
R217, 223, 227, 241, 242	40143223	"	* 22KΩ				
267						INDUCTOR	
R218	40143333	"	* 33KΩ	L207, 209	55003298		* 220193
R222	40143473	"	* 47KΩ	L203	55003299		* 220195
R220, 234, 237-240	40143104	"	* 100KΩ	L204, 206, 210	55003300		* 220197
262, 265, 266, 271				L202	55003301		* 220319
R235	41143104	"	TJ 100KΩ	L208	55003294		* 220380
R211, 214	40143154	"	VJ 150KΩ	L201	53030008	Micro Inductor L10-104J	100mH
R207	40143274	"	* 270KΩ	L205	53020018	"	* FL-5H 100M 10µH
R259, 260	40143105	"	* 1MΩ	L211	53020022	"	* FL-4H 4R7M4.7µH
		POTENTIOMETER				TRANSFORMER	
VR202, 206	49902102	TR-11R300	1KΩB	T201, 202	55003083	3005	* 220187
VR204	49902202	"	2KΩB	T203-206	54141020	R12-4102	* 220111
VR201	49902502	"	5KΩB				
VR205	49902205	"	2MΩB				
						CRYSTAL SOCKET	
				XS201	69010012	SD-0105	
		CAPACITOR					
C239, 243	31829059	Ceramic disc	50WV 0.5PF				
C230, 238, 241	31820010	"	* CH 1PF				
C218	31827040	"	* UJ 4PF			MINI CONNECTOR	
C254	31829040	"	* SL 4PF	P204	67040007	5048-04A	
C236	31820050	"	* CH 5PF	P201	67050005	5048-05A	
C244	31827086	"	* UJ 8PF	P202	67060004	5048-06A	
C231, 232, 237, 240	31827090	"	* 9PF	P203	67100007	5048-10A	
C255	31829150	"	* SL 151PF				
C226, 227	31820200	"	* CH 20PF				
C225, 245, 252	31829270	"	* SL 27PF				
C262	31829330	"	* 33PF				
C275, 276	31820470	"	* CH 47PF				

PARTS LIST

C417,459	31820050	Ceramic disc	50WV CH5PF		80044711	PLL Case	#004471
C412	31829050	*	* SL5PF		80044721	* Cover A	#004472
C483	31820090	*	* CH9PF		80044731	* Cover B	#004473
C414	31829100	*	* SL10PF		80044741	Hex. Spacer	#004474
C484	31829120	*	* SL12PF		91100008	Wrapping Terminal C	
C433,434	31829180	*	* SL18PF				
C424,440,461,462	31820330	*	* CH33PF				
C443	31829470	*	* SL47PF				
C423,438,445,446-450 453-457,465,466,468 469	30820102	*	* 0.001 μ F				
VCO BOARD (P/O PLL UNIT)							
C413,415,416,418,419 422,426,427,431,432 435,444,451,458,460 476,480,485	30820103	*	* 0.01 μ F	Symbol Number	Parts Number	Description	
					018301AZ	VCO Board with components	
				PT-1830A	60418301	Printed Circuit Board	
C420,436,477-479 481,482	30820473	*	* 0.047 μ F			FET	
C470	36825103	Mylar Film	50WV 0.01 μ F	Q401	22800195		2SK191BL
C471,473	36825473	*	* 0.047 μ F				
C475	34320475	Electrolytic	25WV R 4.7 μ F				
C421,437	34220106	*	* 16WV R 10 μ F			DIODE	
C452	34120476	*	* 10WV R 47 μ F	D401	21022090	Varactor Diode	1S2209
C472	34120107	*	* * 100 μ F				
C474	36526104	Tantalum	35WV 0.1 μ F				
C441	36824101	Styrol	50WV 100 μ F			RESISTOR	
C442	36824221	*	* 220 μ F	R402,403	40143101	Carbon Film	$\frac{1}{4}$ W VJ 100 Ω
C467	36133105	Polyester Film	100WV 1 μ F	R401	40143563	*	* * 56K Ω
						CAPACITOR	
		TRIMMER CAPACITOR		C409	31820030	Ceramic disc	50WV CH 3PF
TC402-404	39000011	ECV-1ZW 20x53	20PF	C405,406	31827040	*	* 1U 4PF
				C404,407	31820070	*	* CH 7PF
				C402	31820100	*	* CH 10PF
		INDUCTOR		C408	31820120	*	* CH 12PF
L408	55003150	OSC COIL	\neq 220205	C401,411	30820102	*	* 0.001 μ F
L407	55003120	RFC	\neq 220206	C410	34220106	Electrolytic	16WV R 10 μ F
L406	53020033	Micro Inductor	10 μ H				
L405	53020020	*	15 μ H				
L409	53020007	*	22 μ H			TRIMMER CAPACITOR	
L404	53020021	*	220 μ H	TC401	39000080	TZ01Y010A	7PF
		TRANSFORMER				INDUCTOR	
T401	54141020	R12-4102	\neq 220111	L401	55003289	S6-B	#220359A
T402,403	55003303		\neq 220312	L403	53020031	Micro Inductor	0.68 μ H
				L402	53020010	*	10 μ H
		MINI CONNECTOR			80041041	VCO Case	#004104
P402	67040006	5048-04A			80041051	VCO Cover	#004105
P403	67110004	5048-11A			91100008	Wrapping Terminal C	
P401	67120010	5048-12A					
J402	68040011	5047-4 with wire	\neq 240097				
J403	68110009	5047-11	\neq 240096				
J401	68120008	5047-12	\neq 240105				
		IC SOCKET					
QS401	68240001	116-24-30-114					

PARTS LIST

PLL CONT UNIT			DISPLAY UNIT		
Symbol Number	Parts Number	Description	Symbol Number	Parts Number	Description
PB-1795	60517950	Printed Circuit Board	J604	68040012	5047-04 with wire #240103
	017950AZ	P.C.B with components	J605	68040013	5047-04 " #240093
PB-1836	60518360	Connector Board	J603	68050008	5047-05 " #240092
			J601	68060017	5047-06 " #240095
			J606	68070030	5047-07 " #240090
					IC SOCKET
		IC, FET & TRANSISTOR	Q5601	68280002	SE-OC8340-02
Q601	25000194	IC MN-9003			
Q603-605,614	25000114	IC MC-14011B			
Q611	25000090	" MC-14042B		91001102	Seal Terminal A102
Q602	25000178	" MC-14069B			
Q613	25000179	" MC-14410			
Q612	25000180	" MC-14556B			
Q615	25000132	" 781 05			
Q607	22105641	Transistor 2SA564Q (A)			
Q606,608-610	22318154	" 2SC1815Y			
					DIODE
D601-605,609,610,611	21015550	Silicon Diode 1S1555	D701-707	21090135	LED 5082-7740
D606-608	21001880	Germanium Diode 1S188FM	D708	21015550	Silicon Diode 1S1555
					CRYSTAL
X601	71750001	HC-43/U 1MHz #210071			RESISTOR
			R707	42144101	Carbon Composition 1/4W GK 100Ω
		RESISTOR	R701-706,708-714	41183471	Carbon Film 1/4W TJ 470Ω
R623,624	41183102	Carbon Film 1/4W TJ 1KΩ			PUSH SWITCH
R605,610	41183103	" " " 10KΩ	S701-706	65000042	AKC-8N
R616	41183183	" " " 18KΩ			MINI CONNECTOR
R620	41183223	" " " 22KΩ	P702	67110096	3022-11A
R601,603,618,619	41183333	" " " 33KΩ	P701	67150010	3022-15A
R613,614	41183473	" " " 47KΩ			
R602,604,606,607-609 611,612,615,617	41183104	" " " 100KΩ			
R621	41183275	Carbon Composition 1/4W GK2,7MΩ			
					BLOCK RESISTOR
R18601	47000008	7x100KΩ RA-7R			
					DRIVER UNIT
		CAPACITOR	Symbol Number	Parts Number	Description
C603	31820101	Ceramic 50WV CH100PF	PB-1797	60517970	Printed Circuit Board
C604,606-608	30820104	Ceramic RPE112F104Z50V0.1μF		017970AZ	P.C.B with components
C601,602,605	36825104	Mylar Film 50WV 0.047μF			IC & TRANSISTOR
C609	36226685	Tantalum 20WV 6.8μF	Q801	25000109	IC μPC-14305
C611-635	32821102	Feedthru 50WV 1000PF	Q807-813	22105641	Transistor 2SA564Q
			Q802-805	23900011	" 2SA719-P
					MINI CONNECTOR
P607	67030005	5048-03A			DIODE
P602,604,605	67040007	5048-04A	D801	21015550	1S1555
P603	67050005	5048-05A			
P601	67060004	5049-06A			
P606	67070006	5048-07A			RESISTOR
			R802	42124229	Carbon Composition 1/4W GK 2.2Ω
			R801	42124220	" " 22Ω
J607	68030007	5047-03 with wire #240091	R810-816	40143220	Carbon Film 1/4W VJ 22Ω
J602	68040014	5047-04 " #240094	R803-809	40143472	" " 4.7KΩ

PARTS LIST

CAPACITOR			RESONATOR BOARD P O RX UNIT				
Symbol Number	Parts Number	Description	Symbol Number	Parts Number	Description		
C802	36526474	Tantalum 35WV 0.47µF					
C803	34220226	Electrolytic 16WV R 22µF	PB-1500	60315000	Printed Circuit Board		
C801	34220107	" " 100µF		018000AZ	RESONATOR BOARD		
					with components		
MINI CONNECTOR			CAPACITOR				
P802	67040007	5048-04A	C109,110,112,114	31820050	Ceramic	50WV CH5PF	
P803	67070006	5048-07A	C107,115	31820150	" " "	5PF	
P801	67120010	5048-12A	C111,113	31820180	" " "	18PF	
					CERAMIC TRIMMER		
J802	68040012	5047-04 with wire #240103	TC101-104	39000010	ECV-12W 10x53	10PF	
J803	68070029	5047-07 " #240089					
J805	67110005	3024-11A			INDUCTOR		
J801	68120010	5047-12 with wire #240092	L103	55003293		#220409	
J804	67150009	3024-15A					
				80044941	Resonator Case	#004494	
				91100003	Wrapping Terminal C		
					MONITOR UNIT		
SW UNIT			Symbol Number	Parts Number	Description		
			PB-1897A	60318971	Printed Circuit Board		
				018971AZ	P.C.B with components		
					RESISTOR		
		PUSH SWITCH		R901,903	42144103	Carbon Composition 1/4W GK 10KΩ	
S1	65000040	MP0001AA2060	R902	42144153	" " " "	15KΩ	
S7,8,9	65000041	SPJ2-22-A01					
						POTENTIOMETER	
			VR901,902	49901203	EVL-S3AA 00B24	20KΩB	
					CAPACITOR		
			C901	36825224	Mylar Film 50WV	0.022µF	
		PHOTO A BOARD					
Symbol Number	Parts Number	Description					
PB-1848	60418460	Printed Circuit Board					
		PHOTO INTERRUPTER					
Q3	29090014	ON-1105					
		TRANSISTOR					
Q5	22318154	2SC1815Y					
		RESISTOR					
R13	40143103	Carbon Film 1/4W VJ 10KΩ					
				73000005	Fuse	10A	
				67020003	External Speaker Plug P-2240		
				80038631	Stand		
				80038661	Mobile Bracket Assembly	with Set Screws	
		PHOTO B BOARD					
Symbol Number	Parts Number	Description					
PB-1849	60418490	Printed Circuit Board					
		PHOTO INTERRUPTER					
Q2	29090014	ON-1105					
		TRANSISTOR					
Q4	22318154	2SC1815Y					
		RESISTOR					
R12	40143103	Carbon Film 1/4W VJ 10KΩ					
		ACCESSORIES					
Symbol Number	Parts Number	Description					
		77000016	Microphone Assembly YE-17				
			with Microphone Hanger, Screws				
		67060001	Microphone Plug FM-146P				
		96000020	Power Cord Assembly #240067				
		67020006	Power Plug FM-142P				
		69000002	Fuse Holder SN-1102				
		73000005	Fuse 10A				
		73000005	Fuse 10A				
		67020003	External Speaker Plug P-2240				
		80038631	Stand				
		80038661	Mobile Bracket Assembly				
			with Set Screws				
		OPTIONAL KEYBOARD MICROPHONE					
Symbol Number	Parts Number	Description					
		77000015	Microphone Assembly YE-16				
			with Microphone Hanger, Screws				
		67200001	Microphone Plug P-1620A				

PARTS LIST

TONE SQUELCH UNIT			
Symbol Number	Parts Number	Description	
PB-1555A	60315551	Printed Circuit Board	
IC, FET & TRANSISTOR			
Q502	25000126	IC	NE567V
Q501	25000125	*	MC3403
Q503	22800195	FET	2SK19GR
Q504, 505	22303724	Silicon Transistor 2SC372Y	
DIODE			
D501, 502	21090131	Zener Diode	RD8, 2FB
RESISTOR			
R518	42124151	Carbon Composition 1/2W GK150Ω	
R523	40143271	Carbon Film	1/4W VJ 270Ω
R517	40143472	*	* * 4.7KΩ
R513*, R524*	40143822	*	* * 8.2KΩ
R512	40143103	*	* * 10KΩ
R504	40143123	*	* * 12KΩ
R510, 511, 525	40143223	*	* * 22KΩ
R516*	40143333	*	* * 33KΩ
R502, 508	40143393	*	* * 39KΩ
R501, 505, 521, 522	40143473	*	* * 47KΩ
R506, 507	40143823	*	* * 82KΩ
R509	40143154	*	* * 150KΩ
R514	40143274	*	* * 270KΩ
R503	40143474	*	* * 470KΩ
R515, 519	40143105	*	* * 1MΩ
POTENTIOMETER			
VR502	49800084	TM062P	100KΩ/B
VR504	49905102	SR-19R	1KΩ 1B
CAPACITOR			
C503	36825102	Mylar Film	50VV 0.001μF
C511	36825222	*	* 0.0022μF
C512	36825472	*	* 0.0047μF
C506, 507, 520	36825103	*	* 0.01μF
C502, 504, 505, 508	36825223	*	* 0.022μF
C509	36825473	*	* 0.047μF
C516*	36825104	*	* 0.1μF
C523	36226154	Tantalum	35VV 0.15μF
C518	36226475	*	* 4.7μF
C514, 522	34226105	Electrolytic	16VV 1μF
C501, 510, 513, 521, 524	34226106	*	* 10μF
C515, 517, 519	34226226	*	* 22μF
91100008		Wrapping Terminal C	

