

FT-767GX

**OPERATING
MANUAL**

YAESU MUSEN CO., LTD.

TOKYO JAPAN

CONTENTS

Section	Page	Section	Page
§1.0 SPECIFICATIONS	2	4.7 Transmitter Operation: General	21
1.1 General	2	4.7.1 SWR Measuring & Ant. Matching	21
1.2 Transmitter	3	4.7.2 SSB Transmission	22
1.3 Receiver	3	4.7.3 CW Transmission	24
§2.0 CONTROLS, SWITCHES & CONNECTORS	4	4.7.4 FM Transmission	24
2.1 Front Panel Controls	4	4.7.5 AM Transmission	24
2.2 Rear Panel Jacks & Switches	10	4.7.6 RTTY, HF Packet & SSTV Transmission	25
§3.0 INSTALLATION	14	4.8 Programmable Tuning Steps	25
3.1 Preliminary Inspection	14	4.9 Memory Operation	26
3.2 Power Connection	14	4.9.1 Memory Storage	26
3.3 Transceiver Location and Grounding	14	4.9.2 Memory Recall	26
3.4 Antenna Considerations	14	4.9.3 Changing Memory Frequency	26
3.5 Interconnection of Accessories	14	4.10 Scanning	27
3.6 Memory Backup	15	4.10.1 Memory Channel Scanning	27
3.7 Tuning Knob Steps	15	4.10.2 Programmable Memory Scanning	27
§4.0 OPERATION	16	4.11 Split Frequency Operation	27
4.1 Preliminary Steps	16	4.11.1 Offset Frequency Memory	28
4.2 Initial Power Up, Band Selection	16	4.12 Tone Squelch Operation	29
4.3 Mode Selection	17	4.13 Tips for SSB (LSB/USB) Operation	29
4.4 Tuning Methods	17	4.13.1 Weak Signal SSB Reception	29
4.5 Keypad Frequency Entry	18	4.13.2 Strong Signal SSB Reception	30
4.6 Controls for Enhancing Reception	18	4.13.3 Suppressing Interference	30
4.6.1 Noise Blanker	18	4.13.4 Miscellanea	30
4.6.2 RF Gain Control	19	4.14 Tips for CW Operation	31
4.6.3 NARrow IF Filter Selection	19	4.15 Tips for AM Broadcast Reception	32
4.6.4 RF AMP Switch	19	4.16 Tips for FM Communications	32
4.6.5 ATTenuator Switch	19	4.17 VHF Packet (F2 Mode) Operation	33
4.6.6 APF (Audio Peak Filter)	19	4.18 CAT System Computer Control	34
4.6.7 IF Passband Shift	20		
4.6.8 IF Notch Filter	20		
4.6.9 AGC (Automatic Gain Control)	20		

FT-767GX
ALL-MODE, ALL-BAND TRANSCEIVER

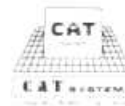

The FT-767GX is a solid-state, all mode synthesized amateur transceiver incorporating automatic antenna tuner, power supply and provisions for up to three optional internal VHF and UHF band modules. The standard model provides 100 watts RF power output on all hf amateur bands in SSB, CW, FM and FSK modes (and 25 watts AM carrier power). Optional band modules provide 10 watts output on the 6m, 2m and 70cm bands.

The die-cast top half of the chassis incorporates the Duct Flow Cooling system originated for amateur radio by Yaesu, where air is circulated over the circuit boards and throughout the chassis by a quiet internal cooling fan when operating temperature rises.

Four internal microprocessors with a custom gate array provide the highest level of digital integration and control ever offered to radio amateurs: including features previously unknown in a transceiver, such as freely user-programmable independent tuning steps for each mode, an auto-calculating digital SWR meter, digital RF wattmeter, synchronous tracking VFOs and autospeed AGC (when tuning or scanning). Popular operating conveniences such as dual (A-B) independent VFOs, ten memories storing both frequency and mode, all mode squelch and range/step programmable scanner, continuously variable noise blanker threshold, IF shift and IF notch are included with recent improvements in response to operators' requests.

For CW operators, the FT-767GX operates QSK and includes (as standard) an iambic keyer with linear speed control, selectable sidetone and carrier offset (600/700/800 Hz), 3-speed AGC (plus OFF), and tunable audio peak filter, all adjustable from the front panel. A narrow (600 Hz) CW crystal filter is also included as standard.

For especially convenient VHF and UHF operation with the optional band modules, an FM discriminator center tuning meter is provided, and to facilitate repeater operation, a split-frequency and clarifier offset display function plus the mode-dependent programmable tuning steps and tracking VFOs are particularly useful. An optional subaudible Tone Squelch Unit can be programmed from the front panel, and a Burst Tone Generator is installed as standard in European versions.

An expanded CAT System with enhanced command set allows practically unlimited addition of features and user-designed controls from an external computer. The FT-767GX also includes connections for automatic control of the FL-7000 Solid-State HF QSK Linear Amplifier, and digital i/o connection directly to the FM modulator for high performance packet radio tnc interfacing (personal computers and packet tncs not supplied by Yaesu).

Please read this manual carefully before operating the FT-767GX.

1.0 SPECIFICATIONS

1.1 GENERAL

Receiving frequency ranges:

- 100 kHz to 29.99999 MHz (continuous)
- 50 to 53.99999 MHz (option)
- 144 to 145.99999 (or 147.99999*) MHz (option)
- 430 to 439.99999 (or 440 to 449.99999*) MHz (option)

Transmitting frequency ranges:

- 1.5 to 1.99999 MHz
- 3.5 to 3.99999 MHz
- 7.0 to 7.49999 MHz
- 10.0 to 10.49999 MHz
- 14.0 to 14.49999 MHz
- 18.0 to 18.49999 MHz
- 21.0 to 21.49999 MHz
- 24.5 to 24.99999 MHz
- 28.0 to 29.99999 MHz
- 50 to 53.99999 MHz (option)
- 144 to 145.99999 (or 147.99999*) MHz (option)
- 430 to 439.99999 (or 440 to 449.99999*) MHz (option)

Emission types:

- LSB/USB (J3E); CW (A1A); AFSK (J1B, F1B);
- AM (A3E); FM (F3E)

Reference oscillator stability:

- better than ± 3 ppm (-10 to +50°C)
- after 15 minutes warmup

Antenna impedance:

- Receive, and transceive above 50 MHz:
 - 50 ohms, unbalanced
- Transmit - 40, 30, 20, 17, 15, 12 & 10m amateur bands: 20 - 150 ohms
- Transmit - 160 & 80m: 25 - 100 ohms

Supply voltage:

- 100, 110, 117, 200, 220 or 234 VAC,
- 50/60 Hz

Power consumption (approx.):

- Receive: 55 VA
- Transmit: 650 VA

Dimensions (WHD):

368 x 129 x 295 mm

Weight (with/without options):

15.5/13.5 kg (35/30 lbs)

* per local requirements and Band Module

1.2 TRANSMITTER

Power output:

HF (all modes except AM): 100W
 HF (AM carrier): 25W
 VHF/UHF (all modes except AM): 10W
 VHF/UHF (AM carrier): 2.5W

Modulation types:

SSB Balanced, filtered carrier
 AM Low level (early stage)
 FM Variable reactance (± 5 kHz deviation)
 FSK Audio frequency shift

Harmonic radiation:

HF: better than -50dB below peak output
 VHF/UHF: better than -60dB

Carrier suppression (SSB):

better than -40dB below peak output

Undesired sideband suppression (SSB):

better than -50dB below peak output

Audio response (SSB, with TX Shift off):

not more than -6dB from 350 - 2900 Hz

3rd order IMD (vs single tone, @100W PEP, 14 MHz):

better than -35dB below peak output

Microphone impedance:

500 - 600 ohms

1.3 RECEIVER

Circuit type:

triple-conversion superheterodyne

Intermediate frequencies:

45.03 MHz, 8.215 MHz and 455 kHz

Sensitivity:

see chart below

Image rejection:

1.5 to 30 MHz: 70dB or better
 VHF/UHF: 60dB or better

IF rejection:

1.5 to 30 MHz: 70dB or better
 VHF/UHF: 60dB or better

Selectivity (-6/-60dB):

SSB, CW, AM(N): 2.7/4.5 kHz
 CW(N) (optional): 600/1300 Hz
 AM(W): 6/16 kHz
 FM: 15/30 kHz

Notch filter rejection:

better than -30dB

Variable IF shift:

± 1 kHz

Audio output power:

1.5W into 4 ohms with 10% THD

Audio output impedance:

4 to 16 ohms

FT-767GX Sensitivity Chart

	100 to 200 kHz	200 to 500 kHz	0.5 to 1.5 MHz	1.5 to 29.9 MHz	6m*	2m*	70cm*
[10dB S+N/N (uV)]							
SSB/CW/FSK	2.5	1	4	0.25	0.25	0.25	0.25
AM	25	4	20	1	1	1	1
[12dB SINAD (uV)]							
FM	-	-	-	0.5	0.32	0.32	0.32
[Squelch sens]							
SSB/CW/FSK/AM	20	10	20	2	1	1	1
FM	-	-	-	0.32	0.32	0.32	0.32

* with optional unit

2.0 CONTROLS, SWITCHES & CONNECTORS

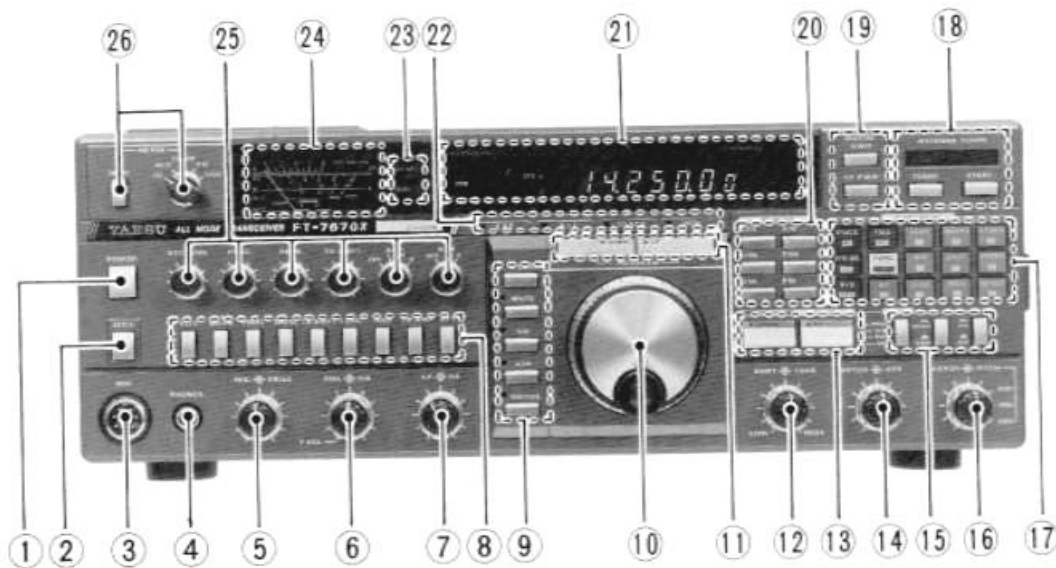

2.1 FRONT PANEL CONTROLS

(1) POWER

This button turns the transceiver on and off.

(2) MOX

This button manually activates the transmitter when depressed. This button must be in the undepressed position for reception, and for automatic transmitter activation via the VOX and semi break-in or QSK systems.

(3) MIC Jack

This 8-pin jack accepts the MD-1B8 Desktop Microphone, MH-1B8 Handie Scanning Microphone, or the YM-48A Handie DTMF Scanning Microphone. Mic pinouts are shown on page 9. Acceptable microphone input impedance is 500 to 600 ohms.

(4) PHONES Jack

This 3-contact jack accepts either stereo or monaural headphones with a 2- or 3-contact plug. When a plug is inserted the internal or external loudspeaker is disabled.

(5) MIC \odot DRIVE

The inner MIC control sets the transmitter audio amplifier gain during SSB and AM transmission. Output power for SSB transmission and modulation level for AM transmission are set by this control when the speech processor is off.

The DRIVE control sets the transmitter carrier level for CW, AM, FSK and FM transmission. Also, when the speech processor is used in SSB or AM modes, this control sets the processor drive level.

(6) SQL \odot NB

The inner SQL (squelch) control sets the signal threshold level at which receiver audio is muted, in all modes. When the optional FTS-8 Tone Squelch Unit is installed, turning this knob fully counterclockwise into the T SQL position activates tone squelch (FM only). Set this control counterclockwise but not into the click-stop for unsquelched reception.

The outer NB (Noise Blanker) control adjusts the width of the blanking pulse when the noise blanker is activated during reception. If set very far clockwise receiver audio may be distorted.

(7) AF \odot RF

The inner AF gain control adjusts the audio volume of the receiver output in the speaker or headphones.

The outer RF gain control adjusts the gain of the receiver RF and IF amplifiers. This control is normally set fully clockwise for maximum sensitivity. When rotated counterclockwise from maximum, the S-meter minimum deflection point will move up the scale. The peak deflection for a particular signal will remain the same if it is greater than the level set by this control, but the receiver will be insensitive to weaker signals. This control also affects the SQL setting, and should be preset fully clockwise when setting the squelch threshold.

(8) 2-Position Pushbutton Switches

VOX: enables automatic voice-actuated transmit/receive switching in SSB, AM and FM modes; semi break-in keying in CW mode; and tone-actuated transmit/receive switching in FSK mode. This button must be pressed together with the Full BK-IN button for QSK operation.

FULL BK-IN: activates full break-in CW (QSK) on the hf bands. When activated, the receiver will be audible between dits and dahs. The VOX button must be depressed for this switch to function.

PROC: enables the rf speech processor in SSB and AM modes. Processing level is set by the control with the same name.

MONI: enables the CW sidetone monitor in CW mode, and the transmit (IF) monitor in other modes. Volume is set by the control with the same name.

TX SHIFT: enables custom setting of the transmitter IF bandpass in SSB modes, using the control of the same name.

T ENC: activates either the Burst Tone generator (when the FTE-2 Burst Unit is installed), or the CTCSS (subaudible) tone generator on FM transmissions when the optional FTS-8 Tone Squelch Unit is installed.

NAR: selects narrow IF filtering in CW and AM modes. Narrow AM -6dB bandwidth is 2.7 kHz, and narrow CW is 600 Hz.

RF AMP: activates the receiver front-end RF amplifier for extra sensitivity on HF bands, when needed.

ATT: adds a 20dB attenuator between the antenna and the receiver front end for extra immunity to overload on the HF bands, when needed. The 'ATT' indicator LED below the display window is lit when this button is depressed.

(9) Pushbuttons with LED Indicators

D LOCK (with red LED): disables the tuning knob to prevent inadvertent frequency changes.

MUTE (with yellow LED): disables receiver audio, for keeping the receiver on in standby.

NB (with green LED): activates the noise blanker.

APF (with green LED): activates the audio peak filter (for CW reception).

NOTCH (with green LED): activates the IF notch filter.

(10) Tuning Knob

Controls displayed frequency in selectable 10 Hz or 100 Hz steps.

(11) ▼DOWN▲UP PROGRAM Keys

Tune displayed frequency in programmable steps, which may be different for each mode. Pressing and holding one of these keys for more than one half second activates multiple stepping in the programmed steps. Steps are originally preset at the factory to 5 kHz for all modes.

(12) SHIFT TONE

The inner SHIFT control allows the center of the receiver IF passband to be positioned above or below that of the received signal, to eliminate interference from signals on adjacent frequencies. Normal setting is the 12 o'clock position.

The outer TONE control adjusts receiver audio characteristics in all modes.

(13) BAND / MCH Keys

Use these keys to select operating frequency band or memory channel (according to the operating status selected by the keypad). The key on the left steps down, and the key on the right steps up. Press and hold for a half second for multiple stepping. In General Coverage mode, steps are 500 kHz. In Ham mode, steps are in 500 kHz ham band segments. If the FTS-8 Tone Squelch Unit is installed, these keys also select tone frequency.

(14) NOTCH APF

The inner NOTCH control adjusts the frequency of the IF notch within the receiver passband when the NOTCH button is depressed, except in the FM mode.

The outer APF (Audio Peak Filter) control adjusts the frequency of the filter passband during CW operation when the APF button is depressed.

(15) FAST, MIC U/D and KEYER pushbuttons

Press the FAST button to select coarse tuning steps for the tuning knob, PROGRAM DOWN and UP keys, microphone up/down keys; and PMS (Programmable Memory Scan) function. When this button is pressed the 10 Hz digit on the frequency display is blanked.

The MIC U/D key selects the step size of the microphone UP and DWN keys on the optional scanning microphone. When this key is in the NOR (undepressed) position, the microphone buttons will duplicate the tuning steps of the tuning knob. When in the PROG (depressed) position, microphone tuning steps are the same as the PROGRAM DOWN and UP keys.

The KEYER button turns the internal CW keyer on and off.

(16) KEYER PITCH

The inner KEYER control sets the speed of the internal CW keyer.

The outer PITCH control is a 3-position switch, selecting 600, 700 or 800 Hz CW carrier offset and sidetone pitch. Set to the most comfortable sidetone frequency.

(17) FUNCTION Keypad

These 15 keys each have dual functions: the default function labelled on the upper half of each key, and the alternate function that becomes active after the orange key is pressed (labelled in reverse letters/symbols on the lower half of each key). Throughout this manual, the alternate key functions will be indicated by parentheses () following the default function name: e.g., the default function of the H/G (ENT) key toggles Ham/Gen states, while the alternate function ENTers programmed data into a VFO or memory.

TRACK (▶)

The default function of this key toggles simultaneous tracking of the two VFOs (A and B), so that when the frequency of one is changed, the frequency of the other changes by the same amount. The green TRACK indicator below the display lights when this function is active. This is convenient for tuning repeater sub-bands where the repeaters all have the same offset. The alternate function of this key (right arrow) causes the blinking display digit selected for keypad frequency entry to shift one place to the right. Keypad frequency entry is described later in the 'Operation' section.

PMS (V/U)

The default PMS (Programmable Memory Scan) function sets memory channels as the limits for the scanner, when activated by the SCAN button. A 'P' appears in the CH position on the display when PMS is active. The alternate V/U function selects the VHF and UHF bands (if the optional Band Modules are installed), and multiple presses also cause the blinking display digit selected for frequency entry to shift one place to the left (the converse of the preceding key, not labelled on this key).

SCAN (7)

The default SCAN function starts the scanner, scanning either the VFO; memory channels (if the memory recall (MR) mode is active); or between the frequencies stored in preset adjacent channels (if the PMS function is active). The alternate function enters the digit 7 in place of the blinking display digit selected for frequency entry.

M▶VFO (8)

The default function transfers the data stored in the selected memory to the selected VFO, overwriting previous VFO data. The alternate function enters the digit 8 in place of the blinking display digit selected for frequency entry.

VFO▶M (9)

The default function transfers the data stored in the selected VFO to the selected memory channel, overwriting previous memory channel data. The alternate function enters the digit 9 in place of the blinking display digit selected for frequency entry.

VFO AB (CE)

The default function causes exit from memory mode to a VFO, or the alternate VFO (A or B) to be selected. The currently selected VFO or memory is indicated on the display. The alternate 'Clear Entry' function is enabled only after keying in other digits on the keypad, before pressing the (ENT) key: the entered digits are cleared, and the blinking display digit is reset to the far left so that you can reenter data.

FUNC (T SET) (Orange Key)

This is the special key that activates (with one push) the alternate functions of all other keys. If this key is pressed twice in succession, the subaudible tone frequencies for the (optional) FTS-8 Tone Squelch Unit can be selected by the BAND/MCH keys.

MR (4)

The default function causes exit from the VFO mode and recalls the last-used memory channel (indicated to the right of the operating frequency on the display). The alternate function enters the digit 4 in place of the blinking display digit selected for keypad frequency entry.

SPLIT (5)

When operating on a VFO, the default function causes the other VFO frequency to become the transmitting frequency, while the displayed VFO then serves as receive frequency only. The alternate function enters the digit 5 in place of the blinking display digit selected for frequency entry.

VFO  M (6)

The default function exchanges the memory and mode of the selected VFO with the memory and mode of the selected memory channel. No data is overwritten. The alternate function enters the digit 6 in place of the blinking display digit selected for frequency entry.

H/G (ENT)

The default function toggles the selected VFO between Ham bands and General Coverage on HF. When General Coverage is selected the green LED beneath the display window is lit. The alternate (ENT) function causes whatever digits have been selected by the numeric keys and displayed (with one digit blinking) to be entered into the VFO, at which time operation shifts to the new frequency and the functions of all keypad keys return to their default states. Once the orange FUNC key is pressed, this key must be pressed to return the display and keypad to normal (default) operation.

AC (0)

The default function requires two presses of this key in succession, and cancels clarifier and/or split offsets. The alternate function enters the digit 0 in place of the blinking display digit selected for frequency entry.

CLAR (1)

The default function toggles the clarifier on and off, which causes the transmit frequency to remain fixed while the tuning knobs and buttons control only the receiving frequency. Note that once a clarifier offset is tuned, it is stored in a special memory even when this key is used to turn the clarifier off (only the 'AC' key erases the clarifier memory). The alternate function of this key enters the digit 1 in place of the blinking display digit selected for frequency entry.

MCK (2)

The default (memory check) function allows display of the contents of the memory channels without disturbing operation. When this key is pressed the MR indicator at the left of the display and the CH indicator at the right of the display both blink. The contents of each memory channel can be checked by pressing the BAND/MCH keys to step through the memories. Press this key again to return the display to normal. The alternate function enters the digit 2 in place of the blinking display digit selected for frequency entry.

OFFSET (3)

When the clarifier or split operation is active, the default function of this key causes the difference between the transmit and receive frequencies to be displayed (with a preceding '-' if the transmit frequency is lower). Press this key again to return the display to normal. The alternate function enters the digit 3 in place of the blinking display digit selected for frequency entry.

(18) ANTENNA TUNER

TUNER Pushbutton

This switch places the antenna tuner in the line between the transmitter and the HF antenna (the receiver connection to the antenna is unaltered). When depressed, the tuner status is indicated in the window above the switch:

READY (green) indicates the tuner is matched and ready for transmission.

WAIT (yellow) indicates the tuner is readjusting itself. Wait until the **READY** indicator lights before transmitting.

WARN (red) indicates the tuner cannot match the antenna to a low enough SWR. Check the antenna and feedline for a problem.

START Momentary Pushbutton

This pushbutton causes the antenna tuner to readjust itself for minimum SWR. The transmitter must be sending a steady carrier while the antenna tuner is readjusting itself.

(19) DIGITAL SWR, RF PWR Pushbuttons

These momentary buttons toggle the digital SWR and wattmeter functions of the display on and off. Transceiver operation is not disturbed. The selected function is indicated by 'SWR' or 'W' (watts) to the right of the displayed parameter.

(20) MODE Selector Pushbuttons

These six momentary buttons select the operating mode of emission.

(21) Display

The diagram below shows the various segments of the display.

(22) CAT ATT TRACK GEN LEDs

These indicators glow when their respective functions are active:

CAT = external control via the CAT System,
ATT = HF frontend receiver attenuator,
TRACK = VFO A/B tracking tuning,
GEN = General Coverage.

(23) ON AIR and BUSY LEDs

The red ON AIR indicator glows while transmitting. The green BUSY indicator glows when the main squelch is open while receiving.

(24) Multimeter

The meter indicates either relative received signal strength (S scale) or FM discriminator center tuning (DISC scale) while receiving; and relative transmitter power output (PO scale), final transistor current (IC scale), transmitter automatic level control (ALC scale), or speech processor compression level (COMP scale) while transmitting. Also, the VCC scale may be used to check power supply voltage (at the final transistors), at any time.

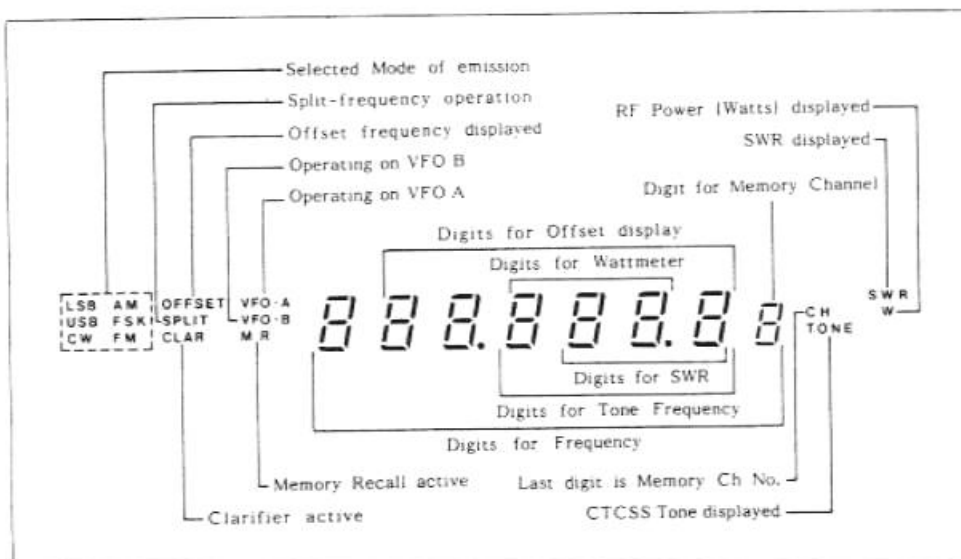

(25) Small Controls

VOX GAIN: adjusts sensitivity of the VOX circuit to audio at the microphone during voice modes, when the VOX button is pressed.

PROC: sets the compression level of the speech processor in SSB modes when the button of the same name is pressed. The COMP meter function may be used to monitor compression level.

MONI: sets the volume of the CW sidetone and transmit IF monitor (in relation to the setting of AF control).

TX SHIFT: adjusts the carrier frequency of SSB transmissions ± 100 Hz when the button of the same name is pressed. This is used with the transmit monitor to set the desired transmitter spectrum.

AGC: selects the desired receiver AGC decay time (fast, medium, slow), or disables receiver AGC (off).

DIM: sets the brightness of the display and meter pilot lamp, or turns them off.

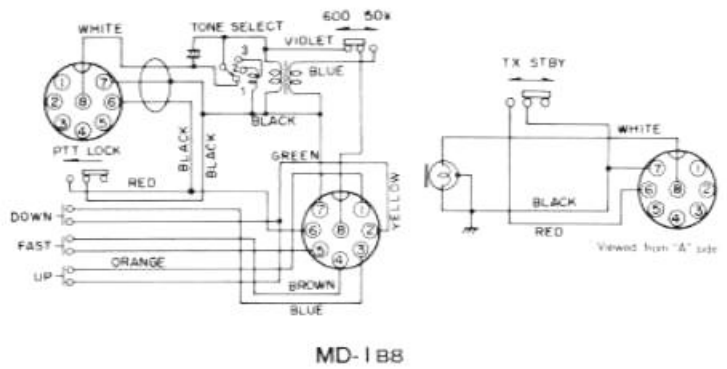
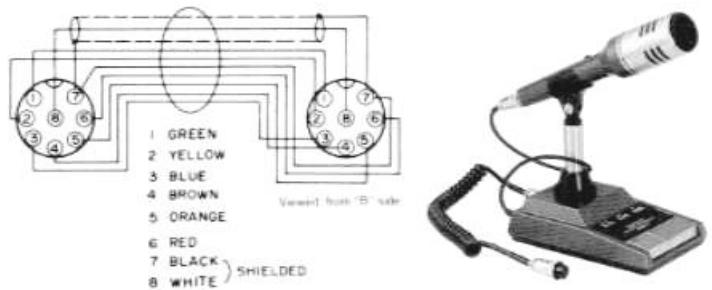

MD-1B8

(26) METER Selectors

The DISC button causes the meter to indicate FM discriminator center tuning (instead of signal strength) in the FM mode. Meter functions in other modes are unaffected. The discriminator meter indication is to center-scale when no signal is received, and also when an FM signal is precisely tuned in. When an FM signal is off-tuned the meter will deflect to the right or left of center, according to whether the signal is above or below the frequency of the receiver.

The IC/ALC/COMP/PO/VCC selector determines the function of the multimeter, aside from the DISC button. In the first four positions, the meter will indicate the selected parameter during transmission, serving as an S-meter (or DISC meter) during reception. In the VCC position, the voltage at the collectors of the final transistors will be indicated (transmit and receive).

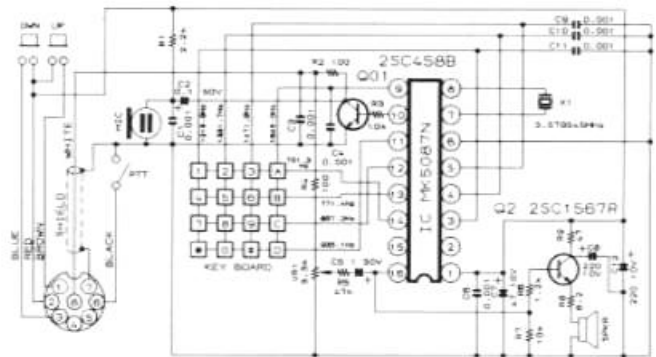
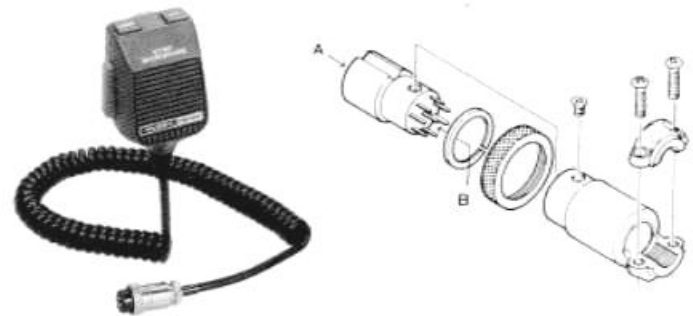

YM-48A

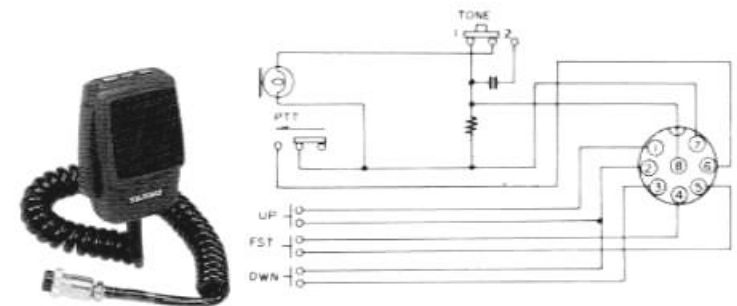

MH-1B8

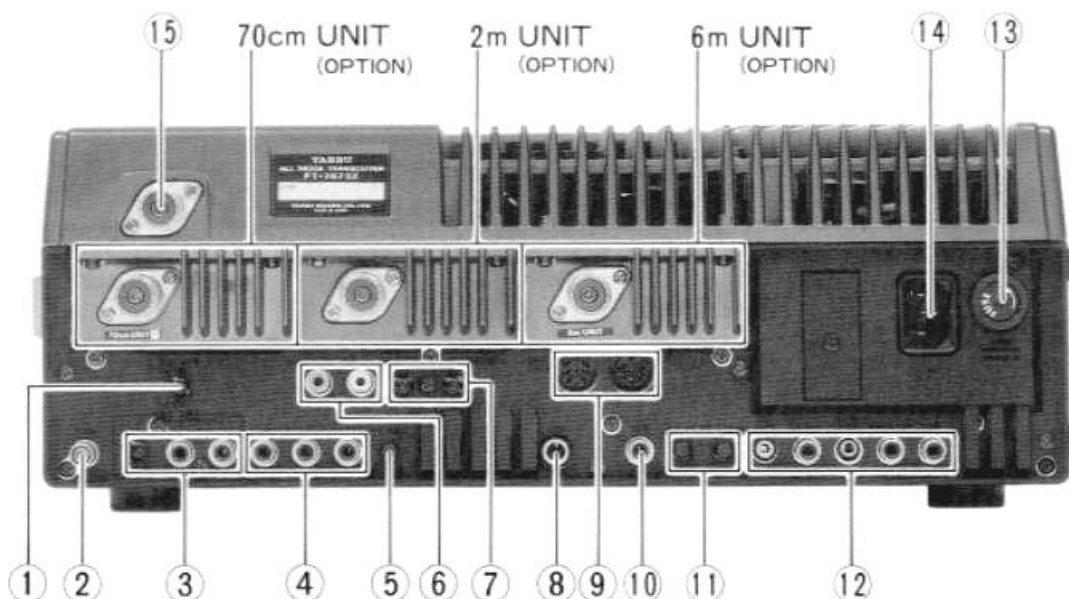

2.2 REAR PANEL JACKS & SWITCHES

(1) BACKUP Pushbutton Switch

Turns the internal lithium battery backup system for memory and VFO data off (when depressed). This switch is normally kept on (undepressed), except when the transceiver is to be stored.

(2) GND Terminal Post

Connect this terminal to a good earth ground using heavy braided cable.

(3) RX ANT Switch and Jacks

The NOR (undepressed) switch position connects the transceiver to the main coaxial (HF) ANT socket on both transmit and receive. The SEP (depressed) position connects the transceiver to the smaller (HF) ANT phono jack just to the right of the switch when receiving.

The EXT RCVR phono jack is for connection of the input of a separate (HF) receiver, which will share the (HF) antenna at the main coaxial ANT socket when the FT-767GX is not transmitting.

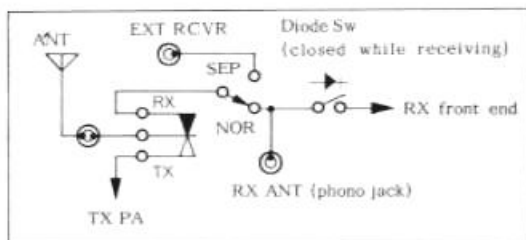

(4) RF OUT, EXT ALC, TX GND Jacks

The RF OUT phono jack provides a low-level (-6dBm @ 50 ohms, 0.1 Vrms) output of the transmit signal (HF only).

The EXT ALC phono jack accepts transmitter automatic level control input from a linear amplifier. Acceptable levels are -1 to -7V (attack threshold is -3 to -4V).

The TX GND phono jack is connected across contacts of a special transmit/receive relay in the FT-767GX, which are closed-circuit during transmission, and open-circuit during reception. Maximum ratings are 0.1A @250 VAC, 0.2A @220 VDC. Resistive load ratings are 2A @30 VDC, or 0.4A @125 VDC. NOTE: internal switch S2002 (on the RF Unit) must be set to the ON position when this jack is used.

(5) PO ADJ Control

This control sets the sensitivity of the relative power output (PO) function of the multimeter on the front panel. The digital wattmeter is unaffected.

(6) DC OUTPUT +13.5V, +8V

These phono jacks provide DC voltage for operating external accessories. Maximum current capability is 200 mA at the 13.5V jack, and 100 mA at the 8V jack.

(7) MARK & LINEAR AMP Switches

The MARK switch activates a calibrating carrier at multiples of 25 kHz throughout the HF range of the receiver. This switch should be OFF (undepressed) for normal operation.

The LINEAR switch, when depressed (position 1) enables QSK transmit/receive switching control by an external linear amplifier which is designed for full break-in operation, such as the Yaesu FL-7000. When operating the FT-767GX without a linear amp, or with a non-QSK linear amp, this switch must be in the undepressed position (position 2).

(8) KEY Jack

This ¼-inch, 3-contact stereo jack accepts a CW key or keyer paddles (for the built-in electronic keyer), or your external electronic keyer. DO NOT USE A 2-CONTACT PLUG in this jack. Pinout is shown below. Key up voltage is 4.5V, and key down current is 2 mA.

(9) BAND DATA & CAT DIN Jacks

The 8-pin BAND DATA jack provides control and band selection data to the FL-7000 Linear Amplifier. Pinout is shown below. Pins 4 - 7 are 500 kHz band selection data in parallel BCD format, TTL levels. Pin 8 is connected in parallel with the LINEAR switch. Pinout is shown below.

The 6-pin CAT jack includes serial I/O, AGC and PTT data for external computer control. Data rate is 4800 bits/sec, TTL level. Pinout is shown below.

(10) PTT Jack

This RCA jack is connected in parallel with the MOX switch, and allows activation of the transmitter by external devices, such as a packet TNC or a footswitch. Open-circuit voltage is 8V DC, and closed-circuit current is 8 mA.

(11) DELAY & ANTI-TRIP Controls

The DELAY control sets the hang time between key up and receiver reactivation of the VOX and CW semi break-in functions. The ANTI-TRIP control sets the level of negative feedback from the speaker audio output to the VOX amplifier, to prevent speaker audio from tripping the VOX.

(12) IF Unit Jacks

EXT SPKR is a 2-contact mini phone jack for connection of an external 4- to 8-ohm speaker, such as the SP-102.

AF OUT is a phono jack which provides constant-level 100mV audio output at 10-kilohms, for an external tape recorder or audio amplifier. The audio at this jack is not affected by the AF or TONE controls.

DATA IN/OUT is a 3-contact mini stereo jack which allows direct connection to the FM receiver demodulator and FM transmitter modulator, for digital terminal equipment such as a packet radio TNC on VHF or UHF. No pre- or de-emphasis is added to the signals at this jack. Input impedance (ring contact) is 600 ohms (for FM mode only) and input signal level should be 30 mVrms. Output (center contact, all modes) level is 800 mVrms maximum at 10 kilohms.

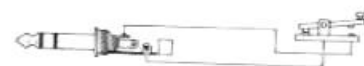

KEY PLUG PINOUT



- ① +13V
- ② TX GND
- ③ TUN CNTL
- ④ A
- ⑤ B
- ⑥ C
- ⑦ D
- ⑧ LINEAR

BAND DATA PLUG PINOUT



- ① GND (common)
- ② SO (serial output)
- ③ SI (serial input)
- ④ PTT (push-to-talk line)
- ⑤ AGC (0 to 4V Hi-Z)
- ⑥ NC

CAT PLUG PINOUT

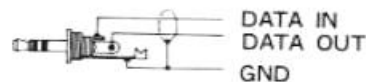

DATA IN/OUT PLUG PINOUT

PATCH IN is a phono jack which accepts transmitter audio input from a phone patch, external AFSK generator or other source with 600 ohms impedance. Optimum input level is 2 mVrms. The MIC control on the front panel affects this input.

FSK is a phono jack which provides 8 VDC whenever the FSK mode is selected. This may be used as a control line for your terminal unit (to turn it off when operating on other modes).

(13) FUSE Holder

For 100 - 117 VAC operation, install a 10A fuse here. For 200 - 234 VAC operation install a 5A fuse.

(14) AC Jack

After ensuring that the installed fuse has the correct rating for the AC voltage to be used, connect the mating end of the supplied AC cable to this 3-pin jack.

(15) ANT Coaxial Jack

This type 'M' (SO-239) jack is for connection of your hf antenna, or linear amplifier input. Optimum impedance is 50 ohms, unbalanced.

FT-767GX POWER TRANSFORMER VOLTAGE SELECTION

If your local AC mains voltage does not match the label on the rear of the FT-767GX, the taps on the primary winding of the power transformer in the FT-767GX should be changed according to the following procedure. Make sure to change the label on the rear of the transceiver to match the new voltage after changing the taps.

- 1) Disconnect all cables from the transceiver.
- 2) Remove the two screws affixing each VHF or UHF Band Module, and slide the modules out of the transceiver (Figure 1).
- 3) Remove the two screws at the front of the top cover (heatsink, see Figure 2).
- 4) Place the transceiver upside down, and remove the four screws from the bottom corners and two on each side (including the carrying handle screws, see Figure 3). Then remove the handle and the bottom cover.
- 5) Referring to Figure 4, remove the seven black painted screws from the rear panel. Then remove the (black) outer rear panel.
- 6) Referring to Figure 5, remove the ten screws from the inner rear panel, and remove this panel.
- 7) Remove one screw from each side, as indicated in Figure 6.
- 8) Locate the white molex connectors (for power and loudspeaker) inside the rear of the chassis, and disconnect them.
- 9) Fold the lower half of the chassis away from the upper half, placing a book or similar support of about the same thickness as the heatsink under the bottom half as shown in Figure 8.
- 10) Remove the seven screws from the shield cover on the inside of the heatsink, as shown in Figure 9.
- 11) Locate the power transformer (Figure 10), and change the wiring as indicated by the labels on the transformer.
- 12) Reassemble the transceiver in the reverse order of disassembly, and change the voltage label on the rear panel to match the new transformer voltage.

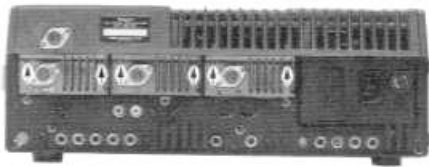

Figure 1

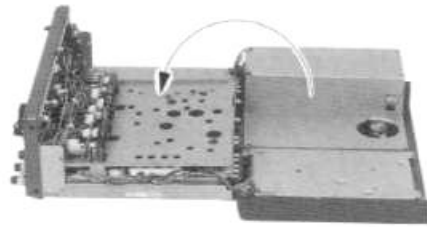

Figure 7

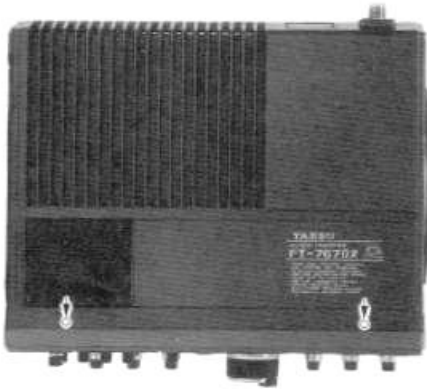

Figure 2

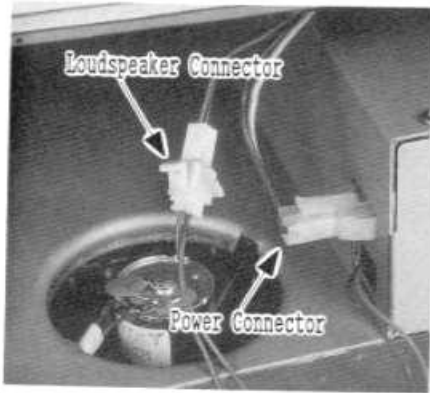

Figure 8

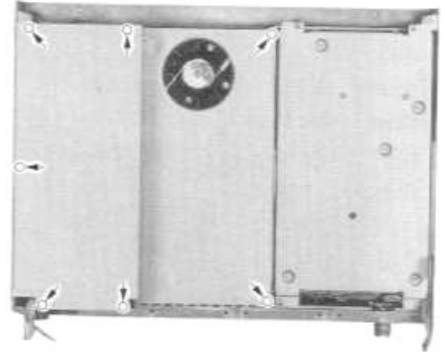

Figure 9

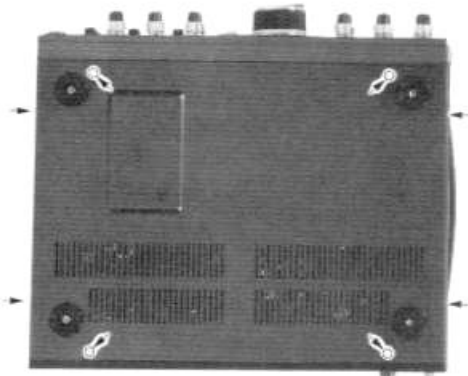
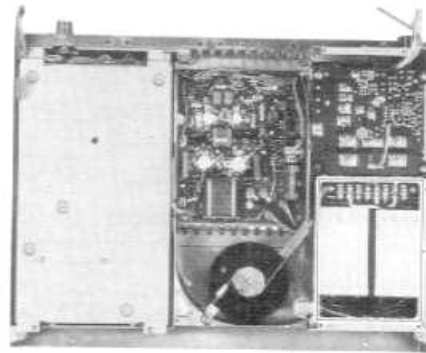

Figure 3



POWER TRANSFORMER

Figure 10

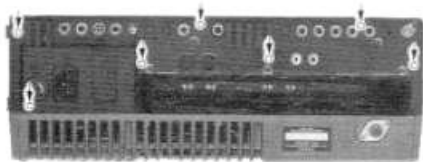

Figure 4

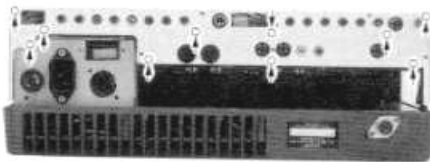

Figure 5

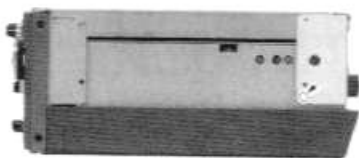

Figure 6

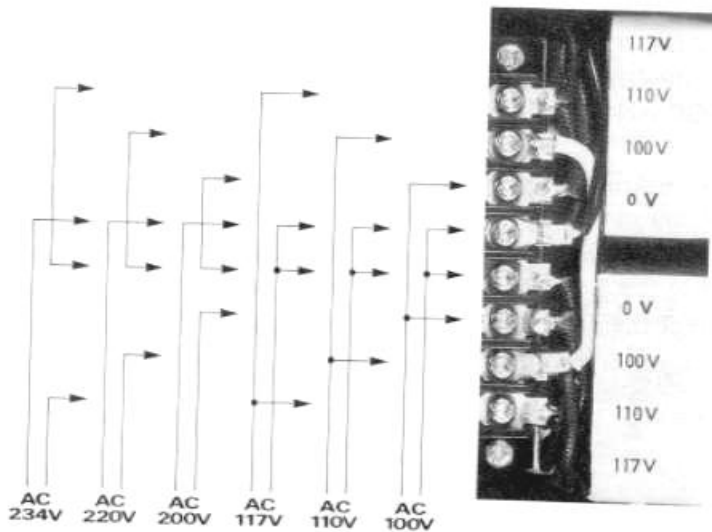

Figure 11

3.0 INSTALLATION

The FT-767GX is designed for operation from AC power only. The proper AC voltage is marked on the rear panel.

3.1 Preliminary Inspection

Inspect the transceiver thoroughly immediately upon opening the packing carton. Check to see that all controls and switches work freely, and inspect the cabinet for any signs of damage. If any damage is found document it completely, and contact the shipping company (or dealer, if you purchased it over the counter) right away. Save the packing materials for possible use at a later date.

3.2 Power Connection

Before connecting power, check the AC voltage label on the rear panel, to make sure it matches your local line voltage. If your mains voltage is different, the taps on the power transformer inside the transceiver must be changed. Follow the procedure on page 12, or contact your dealer for assistance.

NOTE: if you change the transformer wiring from 117V or below to 220V or above, or vice-versa, you must change the fuse in the fuse holder. The lower voltages require a 10A fuse, and the higher voltages require a 5A fuse.

CAUTION

PERMANENT DAMAGE WILL RESULT IF IMPROPER AC SUPPLY VOLTAGE IS APPLIED TO THE TRANSCEIVER. YOUR WARRANTY DOES NOT COVER DAMAGE CAUSED BY APPLICATION OF IMPROPER SUPPLY VOLTAGE, OR USE OF AN IMPROPER FUSE.

After making certain the AC voltage is correct for your mains voltage, and that the correct fuse is installed in the fuse holder, connect the AC power cord to the 3-pin AC jack on the rear panel. Do not connect the other end of the power cord to the wall outlet until all other transceiver interconnections have been made.

3.3 Transceiver Location and Grounding

When setting up the FT-767GX make sure there is plenty of ventilation around the top and rear of the cabinet. The cooling system of the FT-767GX must be free to draw cool air in at the lower rear of the transceiver, and to expel warm air out of the top, toward the back. Do not place the transceiver on top of another heat-generating device such as a linear amplifier, and do not place equipment, books or papers on top of the transceiver. Avoid heating vents and window locations that could expose the transceiver to excessive direct sunlight, especially in hot climates.

Connect the GND terminal on the rear panel to a good earth ground, using a heavy braided cable of the shortest length possible. All other station equipment should be connected to the same grounding cable, as close together as practical. If you use a computer with or near the FT-767GX, you may need to experiment with ground wiring to suppress computer noise in the receiver.

3.4 Antenna Considerations

The automatic antenna tuner in the FT-767GX is capable of matching antennas with an SWR of up to 3:1 or more (on the amateur bands above 80m) to the transmitter. Nevertheless, best performance for both reception and transmission will be had with an antenna designed to provide a 50-ohm unbalanced resistive load at the operating frequency. An antenna that is not designed for resonance at the operating frequency may present too high an SWR to allow proper matching with the built-in antenna tuner, in which case the antenna itself should be readjusted, or an outboard antenna tuner used. If the tuner is unable to bring the SWR down to an acceptable level, attempting to transmit will result in an automatic reduction in power output and increased losses in the feedline. Operation under such conditions is not recommended: it is better to install another antenna designed for that band. Also, if your antenna has a balanced feedpoint and you use a balanced feedline, install a balun between the transceiver ANT jack and the feedline.

3.5 Interconnection of Accessories

The diagrams on the following pages show interconnections of various accessories. If you have any questions on connecting devices not shown, contact your dealer for advice.

3.6 Memory Backup

Before leaving the factory, the lithium memory backup system is switched off. Set this on by pushing the BACKUP switch on the rear panel so that it is in the out (undeepressed) position. This will allow VFO and memory data to be retained while power is off. Backup current is miniscule, so it is not necessary to turn the BACKUP switch off unless you wish to intentionally clear all memories, or if the transceiver is to be stored for an extended period.

After five or more years of operation the transceiver may fail to retain memories, at which time the lithium battery should be replaced. Contact your dealer for replacement of the battery.

3.7 Tuning Knob Steps

The tuning knob rate is preset by switch S3005 on the Local Unit for 5kHz per revolution (Fast 50kHz/rev).

To change this to 10kHz/100kHz per revolution, locate S3005 as shown below, and move it to the 10kHz position.

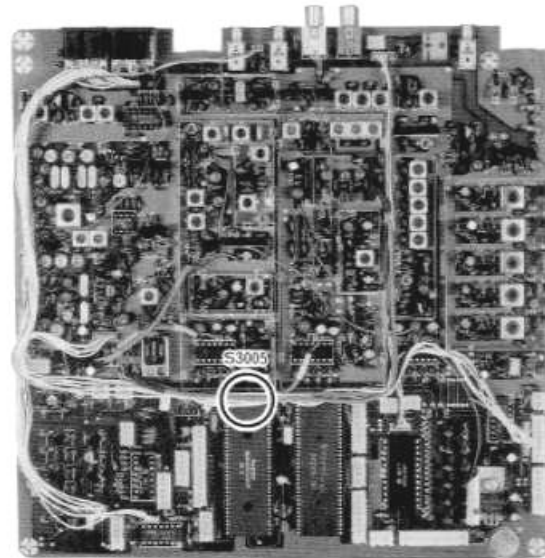

LOCAL UNIT

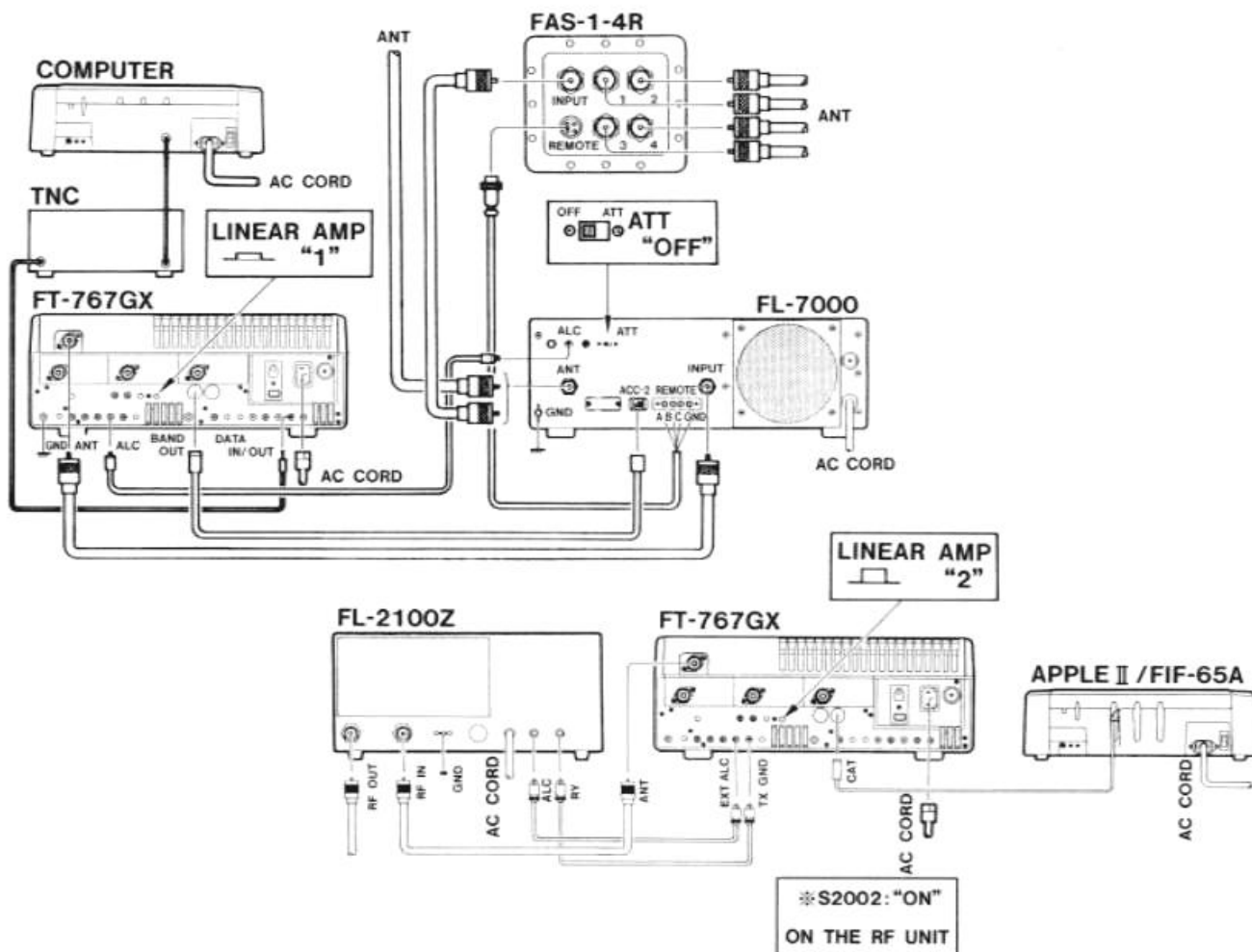

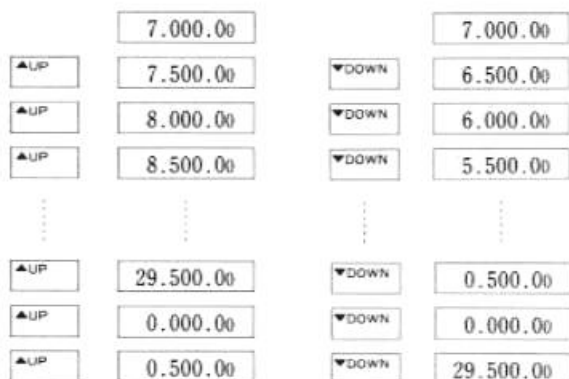

Press the H/G (ENT) key again to return to the Ham mode, and then use the BAND/MCH keys to select a band on which your antenna is resonant.

Note: The only difference between the Ham and Gen modes is the stepping action of the BAND keys, just described. The transmitter is disabled in either mode when tuned outside of the 500 kHz amateur band segments (§1.1). You can, however, use both Gen and Ham modes to receive on any frequency in the receiving range of the FT-767GX, or to transmit in the amateur bands.

4.3 Mode Selection

The six MODE keys just below the right side of the display allow quick selection of operating mode. Just press the key below the desired label to select that mode.

Adjust the AF (volume) control (inner knob to the left of the tuning knob) for a comfortable audio volume, and the TONE control (outer knob, to the right of the tuning knob) for comfortable audio tone from the loudspeaker.

Note: The MUTE switch to the left of the tuning knob disables audio output (in which case the yellow indicator next to the switch glows). This function allows you to leave the AF control undisturbed while putting the transceiver in standby (leaving it on, but not using it). Make sure that the MUTE switch is in the undepressed (out) position and the indicator is off before adjusting the AF control.

4.4 Tuning Methods

Aside from BAND switching, there are three ways to tune the FT-767GX: the tuning knob, the DOWN/UP keys just above the tuning knob, labelled 'PROGRAM', and the microphone (mic) up/down buttons. The tuning steps and rates for each tuning method have both a normal and a 'fast' setting, determined by either the FAST button on the front panel beneath the keypad, or the FAST button on the microphone (these two buttons have the same effect). When either FAST button is depressed, the 10 Hz digit on the display is blanked.

(1) Tuning Knob

When the FAST button is not depressed (ie., out), the tuning knob steps are 10 Hz, and one revolution of the knob tunes either 5 or 10 kHz. Press the FAST button to change 100 Hz steps. One revolution now tunes 50 or 100 kHz (see §3.7 for how to change between 5/50 and 10/100 kHz/revolution).

Note: The D LOCK switch above and to the left of the tuning knob will disable the tuning knob when it is pressed. A red indicator next to the switch will glow when the knob is locked. Press the D LOCK switch when you wish to avoid frequency changes by inadvertent bumping of the knob.

(2) DOWN/UP PROGRAM Keys

The tuning steps of these keys are programmable, and may be set differently for each mode (SSB, CW, AM, FM and FSK). The default steps (before programming) are 5 kHz on all modes. Set the FAST button back to the undepressed position, and try these keys while watching the frequency display.

Notice that if you press and hold one of the DOWN/UP PROGRAM keys for more than ½-second, manual scanning (repeated stepping) occurs at about 3 steps/sec until you release the key.

The FAST button does not affect the step size of the PROGRAM keys, but does change the manual scanning rate. Press the FAST button and notice that the rate increases to about 45 steps/sec.

Programming new tuning step sizes is described in §4.8.

(3) UP/DWN Buttons on Microphone

The mic buttons can be selected to duplicate either the steps of the tuning knob or of the PROGRAM keys, by the setting of the MIC U/D button (below the keypad to the right of the front panel FAST button).

When the MIC U/D button is in its undepressed (NOR) position, the mic button steps are the same as the tuning knob (10 Hz or 1 kHz). Manual scanning with the microphone buttons provides a rate of about 50 steps/sec.

Press the MIC U/D button (to the PROG position) and the steps and manual scanning rates will change to those of the PROGRAM keys.

4.5 Keypad Frequency Entry

Aside from selecting your operating frequency with the tuning methods described above, you can also key in a desired frequency directly using the 15 keys at the right side of the front panel.

To activate the keys for frequency entry, first press the orange FUNC key once. The 10's of MHz digit will start blinking, indicating that you can now 'edit' a new frequency on the display (while reception continues on the original frequency).

While a display digit is blinking, each of the keypad keys has its alternate function (labelled in reverse lettering on each keyface) activated, for changing the blinking digit. Pressing any of the light gray keys will cause the blinking digit to change to the number on the face of the key, and the next digit to the right will begin to blink. Pressing the H/G (ENT) key will end the display editing and enter the displayed frequency for operation.

EXAMPLE: Enter 14.25000 MHz

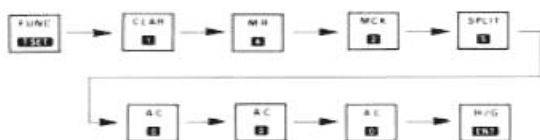

While editing, if you want to leave a digit unchanged, but change another digit further to the right, press the TRACK (▶) key to shift the blinking digit one place to the right.

To shift the blinking digit one place to the left, press the PMS (V/U) key. Notice that this key must be pressed to enter the hundreds of MHz digit if the optional VHF or UHF band modules are installed. If you press this key and then decide that you want to stay on HF (below 30 MHz), press VFO AB (CE) to cancel edited changes, and then continue.

EXAMPLE: Enter 449.70000 MHz
(requires optional 440 MHz Band Module)

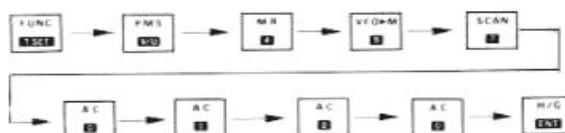

You can continue to key in digits down to 10 Hz (or stop any time). If you wish to cancel all edited changes and re-edit, press VFO AB (CE) to Clear Entries.

When the display shows the frequency you want, press the H/G (ENT) key at the lower left corner of the keypad. If the displayed frequency is valid (below 30 MHz, or within the range of any installed VHF/UHF band modules), the receiving frequency will shift to that displayed, as the blinking stops (if not, re-enter a valid frequency).

Remember - the keypad keys now return to their primary functions (labelled on the upper half of each key).

4.6 Controls for Enhancing Reception

The functions described so far allow you to receive any signal within the range of the FT-767GX, in any mode. This section describes features that allow you to tailor the receiver to the mode in use and existing band conditions.

4.6.1 Noise Blanker

The noise blanker controls consist of the NB switch and green indicator immediately to the left of the tuning knob, and the NB decay adjustment (outer knob of the middle control at the bottom left). When pulse type noise is encountered on the receiving frequency, press the NB switch and adjust the NB control from counterclockwise just to the point where the pulses are blanked.

As the NB control is set further clockwise the blanking pulse becomes wider. This is useful in blanking the 'woodpecker' on HF if the echoes are not too long, but wider blanking pulses also cause more of the desired signal to be lost, so distortion is greater. Therefore, for best performance, always turn the noise blanker off when it is not needed.

4.6.2 RF Gain Control

The RF gain control (outer knob on the same shaft as the AF control, just left of the tuning knob) allows manual setting of the gain of the early stages of the receiver. The gain of these stages is controlled automatically by AGC (unless switched off, see §4.6.9) so the RF gain control is usually kept in the fully clockwise position (maximum gain).

When the RF gain control is turned counter-clockwise from maximum, the minimum S-meter indication will rise, and signals (or noise) below that level will be suppressed. This is useful for eliminating background noise when listening to a moderately strong signal.

4.6.3 NAR (Narrow) IF Filter Select

When operating in the CW or AM modes, pressing the NAR switch (left side of the panel, third from the right) activates the narrow CW or AM filters in the receiver IF, reducing the receiver bandwidth. This decreases the noise level, so CW signals (and sometimes AM signals) may be more readable. Note, however, that tuning also becomes more critical (sharper), so especially for CW, it may be easier to tune initially with this switch off, and only turn it on for fine tuning. See also §4.14 'Tips for CW Operation'.

In the AM mode, the narrow bandwidth will reduce noise and adjacent channel interference, but fidelity is also reduced when the NAR switch is pressed. See also §4.15 'Tips for AM Broadcast Reception'.

4.6.4 RF AMP Switch

This switch (left side of the panel, second from right) activates the receiver RF amplifier, for increased sensitivity below 30 MHz. However, the receiver also becomes more susceptible to distortion and interference from strong signals when the RF AMP is on, so we recommend using it only on quiet bands.

On lower frequencies (about 3 MHz in winter, 10 MHz in summer) atmospheric noise is generally too high for the RF AMP to be effective: although it will make the S-meter read higher, the readability of weak signals is not likely to be improved, while interference may become worse. For best performance, always turn this switch off when listening to strong signals.

4.6.5 ATT (RF Attenuator) Switch

Pressing this switch (left side of panel, right end of the row of switches) decreases the susceptibility of the receiver (below 30 MHz) to distortion and interference from strong signals, but reduces receiver sensitivity (the opposite of the RF AMP). The ATT indicator (above and to the left of the tuning knob) glows green when the attenuator is on.

When band noise is high, such as on low frequencies during the summer, use this switch to reduce noise when receiving strong signals. Also use this switch if strong signals on other frequencies seem to be causing interference on your receiving band. However, before pressing this switch check to ensure that the RF AMP switch is off (the RF AMP and ATT should not both be turned on at the same time, as they counteract one another).

Make sure the attenuator is off when tuning for weak signals.

4.6.6 APF (Audio Peak Filter)

The APF provides a very narrow audio bandwidth for CW reception. It is activated by the switch of the same name to the left of the tuning knob, and adjusted by the outer knob of the middle control at the bottom right. While activated, the indicator next to the APF switch glows green.

To use the APF, first tune in the desired CW signal with the APF off, and then switch it on and adjust the APF control for peak volume on the desired signal. Turn the APF off before tuning to a new frequency. See also §4.14 'Tips for CW Operation'.

4.6.7 IF Passband Shift

The location of the IF passband relative to the carrier frequency of the receiver in SSB, CW, AM and FSK modes can be adjusted by the SHIFT control (inner knob on the control just below and to the right of the tuning knob). Think of this control as a sliding window adjustment, which allows the receiving passband (window) to be slid back and forth, providing different views of the receiving frequency.

Normally, the SHIFT control is kept in the 12 o'clock position until a desired signal has been tuned in. Then, if the signal is being interfered with by another signal just above or below the desired one, the SHIFT control can be adjusted to the left or right, respectively, to move the passband window farther from the interference. Notice also that the audio tone characteristics of the receiver change: this is useful in AM reception, supplementing the TONE control.

Note: Before adjusting the SHIFT control, make sure the NOTCH filter is switched off. Also, return the SHIFT control to the 12 o'clock position when tuning to another frequency.

4.6.8 IF Notch Filter

The IF notch filter provides a means to suppress carrier heterodyne interference in SSB, CW, AM and FSK reception. The notch is activated by the switch of the same name to the left of the tuning knob, and adjusted by the inner knob of the middle control at the bottom right. While activated, the indicator next to the NOTCH switch glows green.

The notch filter should be activated only after the desired signal has been tuned in, and after the SHIFT control has been adjusted for minimum adjacent-channel interference. Press the NOTCH switch and adjust the control gradually back and forth to find the point where the unwanted heterodyne suddenly drops.

If the heterodyne level is stronger than the desired signal, the S-meter indication will dip when the notch is properly set. Turn the notch switch off before tuning to a new frequency or adjusting the SHIFT control. See also §4.13.3.

4.6.9 AGC (Automatic Gain Control)

If you have been tuning around the bands you may have already noticed that the main microprocessor automatically selects fast AGC when the tuning knob is rotated quickly. This allows you to detect weak signals while tuning across the band, even when strong signals are present.

While listening to a station, you can select the AGC decay rate that provides the most comfortable reception, using the four-position AGC selector (small knob, second from the right, next to DIM). Usually, for AM and SSB, this will be the 'S' (Slow) position, but when signals are fluttering, or when looking for a weak signal you may find 'M' (Medium) or 'F' (Fast) better, at least until you make contact. For CW, the Medium or Fast positions will be helpful at higher speeds or under noisy conditions with weak signals. When the band is very quiet and signals are very weak, the OFF position may provide best copy (don't try this if it is noisy).

4.7 Transmitter Operation: General

At this point you are probably ready to try out the transmitter. Recall that valid transmitting frequencies below 30 MHz are only the 500 kHz frequency segments that include amateur bands (§1.1), and that you should be using an antenna designed for the bands on which you wish to operate.

Do not transmit without a proper antenna
(see §3.4 for antenna information).

4.7.1 SWR Measuring & Antenna Matching

Note: To obtain an accurate SWR reading and to set the automatic antenna tuner you must transmit a steady carrier at full power on the air. Please make certain that the frequency is not in use by other stations before tuning up. Always ask first with a short transmission if the frequency is in use, and then listen carefully for at least 15 seconds before keying the transmitter for SWR measuring or antenna tuning.

Keying the Transmitter

If you do not have a key or keyer paddles connected to the KEY jack on the rear panel, use the CW mode for SWR measuring and antenna tuning, and use the MOX button (above the MIC jack) to key the transmitter during these procedures. If you have a key or paddles connected, make sure the KEYSwitch at the right side of the front panel is OFF (out). You still use the CW mode, but close the key (or squeeze the paddles) to key the transmitter with the VOX switch on, instead of using the MOX switch.

If you have an external electronic keyer connected to the KEY jack, and if it is not equipped with a 'tune' function to short the keying line, use the FM mode and the MOX button to key the transmitter. In this case, however, be careful not to speak or make noises in the microphone when transmitting, as that could cause severe interference to other stations on nearby frequencies.

Determine now how you will key the transmitter during the following procedures, with your station setup.

SWR

- (1) Preset the DRIVE control (outer knob, leftmost control) fully clockwise.
- (2) Make sure the frequency is clear (if not, retune to a nearby frequency and check again).
- (3) Press the DIGITAL SWR button near the upper right corner of the display ('SWR' will appear at the right side of the display).
- (4) Select the tune-up mode (CW or FM, as determined above, under 'Keying the Transmitter').
- (5) Key the transmitter, wait one second, and note the (digital) SWR indication on the display. Then unkey the transmitter (return to receive).

If the SWR was below 1.5, press the DIGITAL SWR switch again to return to frequency display: antenna tuning is not necessary.

If the SWR was above 1.5, you can use the antenna tuner to rematch the antenna if your operating frequency is below 30 MHz. If on VHF or UHF, you must readjust the antenna itself.

Antenna Matching

The internal automatic antenna tuner can be used to match your antenna to the transmitter in the amateur bands below 30 MHz. Once a particular antenna has been matched on a band and you select another band, the tuner settings are automatically stored in memory, to be recalled automatically whenever that band is reselected. Before leaving the factory, the antenna tuner memories are set for a 50-ohm load on all bands. You can rematch the antenna at any time as described next (the new settings will overwrite the old ones).

After you have set the tuner for your antenna and favorite operating frequencies, you will rarely need to reset it - your settings will be recalled automatically. However, if you use a different antenna, don't forget to reset the tuner.

If, after several years, the tuner does not seem to recall your settings when changing bands, the lithium backup battery may have run down. Contact your Yaesu dealer for replacement of the battery.

All antenna tuner controls are in the upper right corner of the front panel. The indicator window shows 'READY' (in green) when it has recalled previous settings, or found an acceptable match with new settings; 'WAIT' (yellow) while the tuner is actively retuning; or 'WARN' (red) when it has failed to find a match below 3:1.

Note: you must transmit a steady carrier at full power while the antenna tuner is seeking a new match. Refer to the note at the beginning of this section (§4.7.1) for how to do this.

To use the antenna tuner:

- (1) Select your operating band and frequency (must be HF ham band).
- (2) Press the TUNER switch. 'READY' will appear in the status window. If 'WAIT' appears, the tuner is recalling its previous settings, and 'READY' should appear in a moment.
- (3) Press the DIGITAL SWR switch to monitor SWR on the display. This step is not necessary, but is convenient when setting the tuner memories up initially for your station setup.
- (4) After ensuring that the frequency is clear, key the transmitter to transmit a carrier (and keep it keyed for the next step).
- (5) If the SWR is below 3:1, hit the START switch momentarily. 'WAIT' appears in the status window while the tuner seeks the lowest SWR, and then either 'READY' or 'WARN' will appear.
- (6) Unkey the transmitter.

If 'READY' is indicated, the tuner has found an acceptable match: press the DIGITAL SWR switch to return the display to the operating frequency, select your desired operating mode and proceed with normal operation.

If 'WARN' is indicated, the tuner could not find an acceptable match: you will need to find another frequency where the antenna does match, or replace or readjust the antenna itself. You can also use the FT-767GX with an external antenna tuner, in which case just set the TUNER switch on the front panel off.

Note: The antenna tuner circuitry will be bypassed if the TUNER switch is turned off (out). Keep this switch in the depressed position if you want the tuner active.

While the TUNER switch is on, if you transmit on a frequency where the SWR of the antenna is above 3:1, 'WAIT' will be indicated in the tuner window as the tuner automatically starts retuning. It will require a steady carrier to find the minimum SWR point, so if operating CW, hold the key down (with the keyer off). If operating SSB, you must provide long, steady modulation ('aaahhhhhh') until 'READY' or 'WARN' comes on, or better yet, switch to CW or FM (don't make noise in the mic if you use FM!).

PO Meter Calibration

To use the PO function of the analog multimeter as a wattmeter, you should first calibrate it to the digital wattmeter. Set the Meter Selector to the PO position, and press the RF PWR switch to the right of the display after selecting the test frequency. The key the transmitter and adjust the PO ADJ control on the rear panel so that the analog meter indication (on the PO scale) matches the digital display of power output.

4.7.2 SSB Transmission

With a microphone (MD-1B8 Desktop Mic, MH-1B8 Handie Scanning Mic or YH-48A Handie Scanning DTMF Mic) connected to the MIC jack on the front panel, ensure the following controls are preset as indicated:

METER selector ALC

MIC gain control 12 o'clock
(this is inner knob to the right of the MIC jack)

PROC switch OFF (out)
(left side of panel, third from left)

MONI control counterclockwise (small knob, third to the right of the power switch).

VOX switch OFF (out) (to the right of the MOX switch)

MODE switches press LSB or USB

Tune to a valid transmitting frequency (in the amateur bands).

To activate the transmitter, close the PTT switch on the microphone, and watch the ALC indication (blue scale) on the meter. Adjust the MIC gain control, if necessary, so that the meter does not deflect beyond the ALC zone (heavy blue line on the scale) on voice peaks.

You can monitor your transmitted audio by setting the MONI switch on and advancing the MONI control clockwise, but this may cause feedback unless you are using headphones. If you have headphones (stereo or monaural, with a $\frac{1}{4}$ -inch plug), connect them to the PHONES jack now.

While monitoring your transmissions, you can optimize the transmitter audio to your voice using the TX SHIFT feature (yellow-labelled switch and small control below the meter). Press the TX SHIFT switch and adjust the control for the desired audio characteristic while transmitting.

To use the RF speech processor:

- (1) Set the METER selector to COMP.
- (2) Press the PROC switch.
- (3) Adjust the PROC control (second knob to the right of the POWER switch) while transmitting for 5 - 10dB of compression (maximum) on voice peaks, as indicated on the COMP scale (beneath the ALC scale) on the meter.
- (4) Return the METER selector to ALC.
- (5) Adjust the DRIVE control for meter indication within the ALC zone (the MIC gain control is inoperative while the processor is on).

If possible, use the monitor to listen to your transmitted audio when adjusting the PROC control (step 3 above), so you can hear the

effect of the compression adjustment (and avoid unwanted distortion). Other stations will hear you just as you hear yourself (if they have a good receiver).

VOX (Voice-actuated Transmit Switching)

In any of the voice modes, you can activate the VOX system to automatically activate the transmitter when you speak into the microphone. Press the VOX switch (next to the MOX switch) to activate the VOX, and then adjust the VOX GAIN control so that the transmitter activates when you speak (without pressing the PTT switch on the microphone). When you stop talking the transceiver should return to receive after a slight delay.

The DELAY adjustment on the rear panel sets the hang time for VOX switching from transmit to receive. The ANTI-TRIP adjustment on the rear panel should be set so that receiver audio from the speaker does not trip the VOX.

Clarifier (Receiver Offset Tuning)

While in contact with another station, you can retune the receiver (if, for example, his transmitter drifts) without changing your transmitting frequency: while receiving, press the CLAR key at the bottom center of the keypad. 'CLAR' (Clarifier) will appear to the left of the receiving frequency on the display, and tuning will only affect the receiver.

If you wish to view the offset of the receiving frequency from the transmitter during clarifier operation, press the OFFSET button (the displayed offset will be preceded by '-' if the transmit frequency is below the receiving frequency. Clarifier tuning range is unlimited, but the offset display can only show up to +/-9.99999 MHz.

Once the clarifier has been tuned, the new frequency will remain in the clarifier even if it is turned off (by pressing the CLAR key again), as long as you remain on the same band. In this way, the clarifier actually serves as an auxiliary (short-term) memory.

To clear the clarifier without changing bands you must press the AC (0) key twice.

Remember to press the CLAR key again to return the receiver to the transmitting frequency when your QSO is finished.

4.7.3 CW Transmission

The FT-767GX includes an internal electronic keyer, which can be used by connecting keyer paddles to the KEY jack (§2.2(8)). You can also use a straight key or an external electronic keyer, in which cases the internal keyer must be switched off.

Set up the following controls:

MODE switches press CW
DRIVE control clockwise (max)
VOX switch ON (depressed)
FULL BK-IN switch OFF (out)
(to the right of the VOX switch)
METER selector ALC
MONI switch ON (depressed)

Also, if you are using keyer paddles and the internal keyer, press the KEYER switch on the right side of the panel. Otherwise, with a straight key or external keyer, make sure the KEYER switch is OFF (out).

With the controls set as above, you are ready for semi break-in operation. When you close the key the transmitter will be activated, and when you release the key the transceiver will return to receive after a slight delay (set by the DELAY control on the rear panel).

You should be able to hear the sidetone from the loudspeaker (or headphones) when you close the key. If not, advance the MONI control for comfortable sidetone volume.

To set the keyer speed (and to practice CW transmission), set the DRIVE control fully counterclockwise. Now when you close the key the sidetone will be heard, but no power will be transmitted. Adjust the KEYER control for the desired speed.

On the amateur bands below 30 MHz you can activate full break-in (QSK) operation by pressing the FULL BK-IN switch. This allows you to listen to signals on the channel between dots and dashes.

While transmitting, note the indication on the ALC scale of the meter. If the meter deflects farther than the ALC zone reduce the DRIVE control setting. Also reduce the DRIVE level if you want to reduce power output.

You can also activate the clarifier as described previously for SSB to retune only the receiving frequency.

4.7.4 FM Transmission

For FM transmission, just select the FM mode and close the PTT switch to transmit. Below 30 MHz, power output should be held below 50 watts. Use the PO function of the meter to observe power output, or press the RF PWR switch to display power output digitally, and adjust the DRIVE control for 50 watts. Power output is 10 watts on VHF and UHF (with the optional Band Modules installed). The MIC gain control, speech processor and TX SHIFT controls do not function during FM transmission, but you can use the VOX system and IF monitor to listen to your transmissions as described for SSB transmission (§4.7.2).

If working through repeaters that require a Burst tone (and you have the FTE-2 Burst Unit installed), set the T ENC switch on and close the PTT to send the tone. Then set the T ENC switch off. The tone is transmitted while the T ENC switch and PTT are both depressed.

If the optional FTS-8 CTCSS Unit is installed, after setting the tone frequency as described in §4.12, turn the T ENC switch on if you require a CTCSS tone. When you transmit, the subaudible tone will be sent along with your voice.

See §4.11 for details of split-frequency selection.

4.7.5 AM Transmission

Preset the MIC gain and DRIVE controls fully counterclockwise (minimum), and set the METER selector to PO. Also, press the RF PWR switch so you can observe power output on both the meter and digital display.

Close the PTT switch on the microphone and advance the DRIVE control while watching the digital display: power should be held below 25 watts on HF, and below 3 watts on VHF or

UHF. Then speak into the microphone and advance the MIC gain control until the PO meter just starts to increase on voice peaks. Do not advance the MIC gain further, or overmodulation (and distortion) may result.

If desired, you can activate the RF speech processor for AM transmissions. Set the METER selector to COMP, and press the PROC switch. Then close the PTT and adjust the PROC control for 10dB compression (or less) during voice peaks on the COMP meter scale (use the IF monitor to listen to your transmissions as described for SSB transmission).

The VOX system and clarifier control can also be used with AM transmission (see §4.7.2).

4.7.6 RTTY, HF Packet & SSTV Transmission

Transmission of narrowband FSK (F1; RTTY, SSTV and Bell 103 HF packet) requires input of the (equal level) audio tones (AFSK) at the PATCH IN jack on the rear panel. Remove the microphone from the MIC jack so that extraneous sounds do not interfere with your transmitted signal. The PROC and TX SHIFT switches must be off.

Press the VOX button to allow automatic transmit/receive switching (FULL BK-IN may also be used), and select the FSK mode. Note that the displayed frequency is the SSB carrier frequency, so your actual MARK and SPACE frequencies will be displaced from the display by the audio frequencies of the tones.

Use the MIC gain control to adjust power output while transmitting: if using full power (100 watts), transmissions must be limited to 20 minutes to avoid overheating the power supply.

After transmitting, if the cooling fan is on, don't turn the POWER switch off until the set has had a few minutes to cool and the fan switch off.

See §4.17 for VHF packet operation.

4.8 Programmable Tuning Steps

Different tuning (and scanning) steps can be programmed by the operator for each mode of emission. Minimum steps are 10 Hz, and maximum steps are 99.99 kHz. Programmable steps are active when tuning by the PROGRAM DOWN/UP keys above the tuning knob, or by the microphone UP/DWN buttons when the MIC U/D switch is pressed. The default step size is 5 kHz in all modes.

To reprogram tuning steps;

- (1) Select the mode for which the new steps are to be programmed.
- (2) Press the orange FUNC key: the 10 MHz frequency digit on the display will blink.
- (3) Press either the DOWN or UP PROGRAM key: the display will now show the present step size, with the 10 kHz digit of step size blinking.
- (4) Using the ten numbered keys, key in the desired step size for this mode. For example, to set 2.5 kHz steps, press 0250.



- (5) Press the H/G (ENT) key to enter the new step size into the step memory.

Now, when you press the PROGRAM DOWN/UP keys the tuning steps will be as you have programmed when operating on the same mode.

4.9 Memory Operation

Ten memory channels, numbered 0 through 9, are available for storing operating frequency and mode of emission selected on a VFO. In addition there are two VFOs, labelled VFO A and VFO B, each of which may hold operating frequencies and mode. Selection and manipulation of the memories and VFOs is accomplished via the primary functions of the keypad keys (so alternate function labels will be ignored in the following descriptions).

4.9.1 Memory Storage

The following procedure allows storage of the VFO to one of the memory channels, without interrupting operation on the VFO. Key-strokes can only be entered while receiving, however.

- (1) Set the VFO to the frequency and mode of emission to be stored.
- (2) Press the MCK key to check the memories: the display will change to the last memory channel accessed (or CH 0 by default). 'MR' will appear blinking to the right of the mode, and the channel frequency will appear with the channel number as the rightmost digit, followed by a small blinking 'CH'.
- (3) While watching the rightmost display digit (channel number), press the BAND/MCH DOWN and UP keys to select a different memory channel, if desired. If you change memories you must press MCK twice before proceeding.
- (4) Press the VFO-M key to write the data to the memory.
- (5) Press the MCK key again to return the display to the VFO after confirming that the desired data has been stored (and is now displayed).

Notice that steps (2), (3) and (5) are required only to select the memory channel that is to be written.

CAUTION: If only the VFO-M key is pressed when operating on a VFO, the selected frequency and mode will be instantly written into the last selected memory. In any case, storing a memory overwrites all data previously stored in that channel.

4.9.2 Memory Recall

- (1) Press the MR key to recall memories: the display will change to the last memory channel accessed (or CH 0 by default), and the channel frequency will appear with the channel number as the rightmost digit, followed by a small 'CH'.
- (2) While watching the rightmost display digit (channel number), press the BAND/MCH DOWN and UP keys to select a different memory channel, if desired.

Default memory data for all channels is 7.000.0 MHz, LSB mode.

The mode of emission of a recalled memory channel may be changed (and is automatically rewritten) by the MODE keys.

Press VFO AB once to return to the last selected VFO.

4.9.3 Changing Memory Channel Frequency

To change the frequency data stored in a memory channel it is necessary to shift the data to the VFO, where it can be manipulated and restored in memory later, if desired. Two methods are available to do this.

For both methods, it is first necessary to select or determine the VFO (A or B) and the memory channel (0 through 9) to be used:

- (1) Press VFO AB to select the VFO to be written to (A or B).
- (2) Press MCK and select the channel to be moved, using the BAND/MCH DOWN and UP keys.
- (3) Press MCK again to return to the VFO display.

If you do not wish to preserve the VFO data, but do wish to save the memory data, press the M-VFO key to copy the memory channel data to the VFO. This leaves the memory data intact, but overwrites all data in the VFO.

Otherwise, if you wish to preserve the VFO data but do not care to save the memory, press the VFO-M key to swap the memory and VFO.

Now the VFO data is moved into the memory channel while you can retune the previously stored memory data. When you wish to recall the previous VFO data, just press the VFO **M** key again, and the data will be swapped again.

4.10 Scanning

When the squelch control is adjusted to silence the receiver, either the memories or a preselected frequency segment may be scanned automatically. Signals that are strong enough to open the squelch will halt the scanner. Note that the RF AMP and ATT switches and the RF (gain) control must be set for the desired sensitivity before adjusting the SQL control, as these will affect the squelch sensitivity.

4.10.1 Memory Channel Scanning

To scan the 10 memory channels:

- (1) Preset the SQL control to the point where background noise is just silenced.
- (2) Press MR to recall the memories.
- (3) Press SCAN to start the scanner.

The first channel having a signal strong enough to open the squelch will halt the scanner, which can be restarted by pressing the SCAN key again.

To stop the scanner manually, press the SCAN key, PTT switch (briefly, on the microphone), or the VFO AB key. The first two methods halt on the presently recalled memory, while the latter also returns you to the VFO.

4.10.2 Programmable Memory Scanning (PMS)

The PMS feature allows you to scan all frequencies between those stored in two adjacent memory channels. The starting frequency and mode of the scanner are determined by the lower-numbered memory channel. Scanning steps are 1 kHz for AM, 2.5 kHz for FM, or 100 Hz for other modes. Slow and fast (x10) scanning rates are selectable.

To use programmable memory scanning;

- (1) Store the lower and upper limits (§4.9.1) in adjacent memories (or 9 and 0, with 9 being the lower-numbered memory), and set the lower-numbered memory to the desired mode.
- (2) Preset the SQL control to the point where background noise is just silenced.
- (3) While the lower-numbered memory is recalled (§4.9.2), press PMS. 'P' will be displayed in place of the memory channel number, indicating that the PMS system is now activated.
- (4) Press SCAN to start the scanner.

Scanning speed is determined by the position of the FAST switch.

Scanning can be manually halted by the PTT switch or SCAN key, in which case the PMS function remains active ('P' still displayed); or by the VFO AB or MR key, in which case PMS is cancelled and operation resumes on the VFO or (lower-numbered) memory, respectively.

4.11 Split Frequency (semi-duplex) Operation

Split frequency operation with the FT-767GX is implemented by using the two VFOs*. The offset display and VFO tracking features make split operation especially convenient for working VHF and UHF (or HF) repeaters.

* The clarifier can also be used for split operation as described in §4.7.2, since the clarifier range is the same as the VFOs. Using the clarifier in this way allows one VFO to be preserved, but does not permit use of the TRACK function.

To operate split;

- (1) Tune the displayed VFO to the frequency you want to transmit on.
- (2) Press the VFO AB key once to select the alternate VFO, and set this one to the receiving frequency.
- (3) Press SPLIT ('SPLIT' will appear on the display, and whenever the transmitter is keyed, frequency will shift to that set in step (1).

Note: make certain that the emission mode of both VFOs is the same (unless you want to operate cross-mode).

You can press the TRACK key at any time to cause the two VFOs to be linked, so that tuning one will cause the other to tune by the same amount (whether or not split operation is activated!). The green TRACK indicator beneath the display will glow while this function is active. Press TRACK again to cancel.

To reverse your transmit and receive frequencies while working split, just press VFO AB.

To display the offset between your transmit and receive frequencies, press OFFSET. The display will now indicate 'OFFSET', and show the difference frequency between the VFOs (up to 9.99999 MHz, with a leading '-' sign if the transmit frequency is lower than the receiving frequency). If the track function is not active, the effect of tuning on the offset will be displayed by the change in difference frequency. The next section explains how to store offset frequencies in memory. To return to operating frequency display, press OFFSET again.

To cancel split, track, offset or clarifier operation (or any combination of these), press either the keys of the same name, or press the AC key twice, which cancels all of them and leaves you back on the VFO, simplex.

4.11.1 Offset Frequency Memory

As a further convenience for split frequency operation, up to four offset frequencies may be stored in special memories: one each for HF, 6m, 2m and 70cm bands (the VHF and UHF bands require the optional band modules). Both VFOs are required for this feature.

To store an offset frequency;

- (1) Perform steps (1) - (3) to set up split operation.
- (2) Press OFFSET to display the offset.
- (3) Press VFO►M to store the offset.

EXAMPLE: Store +600 kHz offset for 2m (requires optional 2m Band Module).

- (1) Starting on VFO A, tune to 146.000 MHz (or whatever frequency you intend to transmit on).
- (2) Press the VFO AB key to switch to VFO B, and tune to 145.400 MHz (or whatever frequency you intend to receive on).
- (3) Press SPLIT and then OFFSET. Check that the display now shows 0.6000 MHz.
- (4) Press VFO►M to store this offset.
- (5) Press AC to return to simplex operation.

To recall a stored offset frequency memory, press OFFSET and then SPLIT. The unselected VFO is automatically reset to the proper offset frequency. For example, if the above steps have been performed and you have since retuned VFO A to 145.000 MHz, just press OFFSET and then SPLIT. Now your transmit frequency will be 145.600 MHz, which will be found in VFO B (regardless of where it may have been tuned previously).

4.12 Tone Squelch Operation

When the optional FTS-8 Tone Squelch Unit is installed (and the FTE-2 Burst Unit is not installed), the FT-767GX can be used for silent monitoring of busy channels in the FM mode, as well as for accessing repeaters requiring CTCSS tones on VHF or UHF (when the appropriate Band Modules are installed).

Two different tones may be stored, one in each of the VFOs. Available tone frequencies are listed in Table 3 on page 36.

To set the CTCSS (subaudible) tone frequency;

- (1) Press the orange FUNC (T SET) key twice. The display now shows the selected tone frequency (in Hz).
- (2) Use the BAND/MCH keys to select the desired tone frequency from those displayed.
- (3) Press H/G (ENT) to store the displayed tone and return to the operating frequency.

To activate tone squelch monitoring, turn the SQL control counterclockwise into the click stop (T SQL position). The receiver will remain silent until a signal is received with a subaudible tone matching that programmed in the VFO. Other signals not having the correct tone will cause the BUSY indicator to glow, but will not open the squelch.

To transmit the programmed tone, the T ENC switch must be ON (depressed). The subaudible tone will be sent at all times while the PTT switch is closed.

4.13 Tips for SSB (LSB/USB) Operation

Although all of the controls and features available for SSB operation have already been described, obtaining optimum performance on SSB modes requires skillful manipulation of these features by the operator, brought on mainly by experience and experimentation. The tips in this section are provided to guide your experimentation, and (hopefully) help shorten learning time.

4.13.1 Weak Signal SSB Reception

Weak SSB signals, by definition, are very close to the background noise level, suggesting that you will want to take all steps possible to decrease the effects of background noise while enhancing the desired signal(s), by taking every advantage of the differences between the two. Of course, squelch cannot be used, since the SSB squelch circuitry cannot distinguish between noise and signals.

The noise blanker can be useful for reducing noise, and may be left on and set to a very low level, to blank switching transients that often occur (if you live in a crowded area). The blanker can sometimes help a little with lightning crashes, but cannot stop 'white' band noise. If high level pulse noise appears (like the 'woodpecker'), just advance the blanking (NB) control. As the nature of band noise varies widely with time, frequency, season and station location, you will have to experiment.

The fast AGC setting can be useful for setting the noise blanker with some types of noise if the level is high enough to cause S-meter deflection. Advance the NB control just to the point where the S-meter deflection no longer drops. Fast AGC also helps you to hear signals 'around' noise pulse noise, by causing receiver gain to recover quickly after a pulse. However, fast AGC also makes listening a bit of a strain, so try medium or slow AGC once you have a station tuned in.

Once the noise blanker and AGC are set up, you will want to take steps to tailor receiver sensitivity (signal-to-noise ratio). The objective here is to obtain a background noise level that is only a slight hiss (or nothing at all!), without losing any wanted signals.

If background noise is strong enough to cause the S-meter to deflect above S-3, switch off the RF AMP. If the S-meter still deflects on the noise, and if more than S-3, turn the ATTenuator on.

If the S-meter deflects, but to less than S-3, turn the RF gain control counterclockwise gradually until the S-meter just begins to rise, and then drop the RF gain back a little to the threshold point. Your receiver is now set for maximum useful sensitivity on that band (the settings are different at different times, on different bands, and with different antennas and station locations).

On the other hand, if the background noise causes no S-meter deflection, you may need more receiver gain: switch off the ATTenuator if it is on, and if still no S-meter deflection, switch on the RF AMP (they should never both be on together). As soon as you see a little S-meter deflection, adjust the RF gain as just described.

Note: Remember: there is no advantage to setting receiver gain higher than what is necessary to receive signals above the background noise. The S-meter can be set to read higher on signals and noise, but this usually causes the receiver to be more susceptible to distortion from strong signals, decreasing overall reception quality. For best reception quality, always use the minimum sensitivity needed.

4.13.2 Strong Signal SSB Reception

For strong signal reception, follow the same steps as above. Set the AGC to slow, and turn the RF gain back as much as possible so that you can still hear the incoming signal during any fading that may occur. When the receiver is set properly, signal-to-noise quality should be almost as good as FM.

4.13.3 Suppressing Man-made Interference

If unwanted stations are heard near the signal you are listening to, first make sure you have your station tuned in precisely (press CLAR if you retune during a QSO), and then press D LOCK to disable the tuning knob. Now try rotating the SHIFT control slightly. Notice that the pitch of the signals will shift, and you may be able to reduce the interference while still copying. The TONE control can be helpful in correcting for the altered pitch caused by SHIFT adjustment.

If the SHIFT adjustment does not help, the interference might not be due to nearby signals, but to intermodulation from strong signals on far frequencies. If the station you are listening to is strong enough, turn off the RF AMP, turn on the ATTenuator, and reduce the RF gain, one at a time in that order, stopping while the desired station is still readable.

Make certain to re-center the SHIFT control before you turn the D LOCK off and retune.

For heterodyne interference such as from AM stations, or for many types of 'buzzing' signals such as those used for jamming on the HF bands, the NOTCH filter can be helpful. Press D LOCK to disable the tuning knob, and then turn on the NOTCH filter and adjust it very gradually for a dip in the interference (shown on the S-meter).

Remember to turn the NOTCH filter off before turning the D LOCK off and retuning.

4.13.4 Miscellanea

Use care when tuning in an SSB signal, and then press D LOCK so you can make fine adjustments to the IF passband and audio without having them suddenly upset by an accidental bump of the tuning knob. Use the memories for net or schedule frequencies.

4.14 Tips for CW Operation

All of the tips for SSB operation apply equally to CW reception, with a few important additions. For automatic transmit/receive switching, the VOX must be switched on.

When tuning around the bands, wider IF selectivity (NAR switch off) allows you to hear more signals at one time, often making tuning easier. However, when you find a station you wish to listen to (or call), press the NAR switch, to cut out nearby signals and decrease noise. To avoid losing the desired signal you must tune so that the pitch of his signal is near the center of the passband, which you set with the PITCH selector. To check it, set the DRIVE control to minimum (to avoid creating QRM), and close the key. Tune the receiver so that the pitch of the desired signal matches the sidetone (if you want to zero-beat). Then press the NAR switch.

After selecting the narrow IF filter, you can also activate the APF, for extra-narrowband selectivity (there is little point using the APF without the NAR switch on). This is most practical if you have first preset the APF frequency to the sidetone:

- (1) Press the MARK button on the rear panel to activate the marker generator, and press FULL BK-IN to activate QSK.
- (2) Set the DRIVE control to minimum, and squeeze the keyer paddles. Tune the receiver for a heterodyne of the same pitch on the nearest 25 kHz marker.
- (3) Turn on the APF, and adjust the control for peak on the heterodyne: now note the precise setting of the APF control.
- (4) Turn off the APF and MARK switches, and advance the DRIVE control.

Now, whenever you tune a signal to the same pitch as your sidetone, just hit the APF switch - only slight adjustment of the APF control may be needed.

You can change your PITCH selection at any time: it does not affect your operating frequency. However, the APF will have to be reset for the different pitch.

AGC selection is a bit more critical when receiving CW, and depends on the code speed: select the setting that provides the smoothest sounding code.

Handling interference on CW is similar to SSB: both SHIFT and NOTCH are even more effective - the NOTCH filter can be used to suppress CW signals on nearby frequencies.

If using the internal electronic keyer, adjust the KEYSER speed control while squeezing the keyer paddles (generating ---|---|). Make sure the DRIVE control is at minimum (counterclockwise) when you do this.

If you send very fast CW with FULL BK-IN on, the receiver may not have time to recover between code elements, and your transmitted code elements may be foreshortened. Try semi break-in (with only VOX on).

4.15 Tips for AM Broadcast Reception

The FT-767GX is ideal for serious shortwave broadcast reception - especially if you have an antenna tuned for the shortwave broadcast bands. Tune to the desired band and set up the receiver sensitivity as described in §4.13.1 and §4.13.2. Then select slow AGC, and key in a frequency that is an even multiple of 5 kHz. Since nearly all shortwave broadcasting signals are spaced in 5 kHz channels, press D LOCK and MIC U/D, and use the PROGRAM or microphone DOWN UP keys for tuning in 5 kHz steps (we suggest you leave these set as the programmed steps for AM and SSB).

Very strong signals will provide best fidelity when the NAR switch is off, but for weak signals you can reduce noise by turning it on, which causes the SSB filter to be used for AM. Unfortunately, this also reduces fidelity quite a bit, and may be uncomfortable for music, or long periods of listening. Also, if rapid fading occurs, you should move the AGC selection to medium. Even so, distortion may occur during the fades due to selective fading.

Both of these problems can be solved by using an SSB mode for AM reception (this is called ECSS, Exhaulted Carrier Single Sideband mode). Merely select the sideband (LSB or USB) that provides the best reception. This mode has the added benefit of allowing you to suppress interference that might be caused by an adjacent station, by selecting the sideband on the opposite side of the carrier. However, for this feature to be useful, the receiver must be tuned exactly to the carrier frequency of the signal (or it will sound awful): this is where the 5 kHz programmed tuning steps on SSB modes are useful. Once you have keyed in a frequency with 5.00 as the last two digits, the up/down keys will keep you tuned to the carrier channels when you change stations.

Note: When the FT-767GX is first turned on about 15 to 30 minutes may be required for the oscillators to stabilize. The receiver is stable enough for comfortable ECSS reception after it has warmed up.

During AM or ECSS reception, use the SHIFT and TONE controls to tailor the audio of a broadcast as you desire. If two AM stations are close together you will hear a heterodyne of their carriers. Use the NOTCH filter to remove the undesired carrier if it is close (under 2.5 kHz), or the SHIFT control (in ECSS mode) if it is farther away (higher pitch).

4.16 Tips for FM Communications

FM operation with the FT-767GX uses ± 5 kHz deviation, which mode is used on the upper end of the 10m amateur band, and on VHF and UHF. By convention, each band has certain channel steps, which should be set up for selection by the PROGRAM and microphone up/down keys (§4.8). Press the MIC U/D switch, and set the SQL control so that the noise is just silenced on a clear channel.

When fine tuning the receiver in between channel steps, press the DISC button at the top left corner. This causes the meter to indicate discriminator center tuning: when a signal is tuned in correctly (or when no signal is present at all), the meter deflects to the center of its range. If the meter deflects to either side of center, a signal is being received off-center. You can always turn the DISC switch off to check signal strength after a signal is 'centered'.

For working through repeaters, store the standard repeater shifts for each band in the offset memories (§4.11.1). Store your favorite repeater output frequencies in the memories for scanning, and use the TRACK function when tuning repeater sub-bands.

Use the YM-48A DTMF microphone to generate DTMF tones for autopatching. Close the PTT switch while entering digits on the microphone keypad.

See §4.7.4 and §4.12 for tone burst and tone squelch operation.

4.17 VHF Packet (F2 mode) Operation

The FT-767GX offers special features for packet radio operation on VHF or UHF, using the FM mode of emission. You must determine, however, the AFSK signal levels provided by your tnc (terminal node controller) for transmission, as well as the signal levels required by the tnc for reception.

If your tnc has balanced AFSK tone output (that is, without any added de-emphasis), connect the AFSK signal from your terminal node controller to the outer contact of the DATA IN/OUT jack: impedance should be 600 ohms, which corresponds with most tncs. Output signal level from the tnc should be set to 30mVrms.

If your tnc has de-emphasis applied to the AFSK output, the levels of the two tones will be different, and must be re-balanced by pre-emphasis in the FT-767GX. In this case you can connect the AFSK signal from the tnc for transmission to the PATCH IN jack (also 600-ohm impedance), but you must also adjust the tnc output level for 2mVrms maximum. The PATCH IN audio connects in parallel with the microphone audio input. A better solution is to remove the de-emphasis, if possible, and make connection as described in the preceding paragraph.

For receiving, there are also two available output points for FSK, again depending on whether your tnc pre-emphasizes receive audio. If the tnc can accept balanced tone levels (such as the GLB PKT-1), connect the center contact of the DATA IN/OUT jack to the receiving input on the tnc: output level is 800mV at 10 kilohms, so make sure your tnc can handle this high level (or add a 10k resistor to ground and another in series to set the level).

If your tnc requires unbalanced tones (and includes its own pre-emphasis, such as the TAPR TNC-2 and clones), use either the low-level signal at the AF OUT jack (100mV at 10 kilohms), or the high level signal at the EXT SP or PHONES jack.

Note, however, that using the EXT SP or PHONES jack has two serious disadvantages: (1) plugging into these jacks disables the loudspeaker, making it impossible to monitor the receiver (this is not recommended); and (2), the AF gain and TONE control setting will affect the packet input to the tnc.

The low-level signal at the AF OUT jack is the best choice, as the receiver AF power amplifier is bypassed. If your tnc attenuates the receiver input for high level speaker audio, you might wish to bypass that attenuation, and then use the AF OUT jack.

Set the FT-767GX to the FM mode for VHF and UHF packet (to be compatible with most other operators using 1200 bits/sec on these bands), and set the MONI, APF and NOTCH switches OFF (out). Also, if you have the FTE-2 Burst Unit or FTS-8 Tone Squelch Unit installed, make sure the T ENC switch is OFF (out) and the SQL control is not in the T SQL position. Receiver tuning is as described for FM (§4.16). Use the memories to store the common packet channels in your area, for easy recall.

4.18 CAT System Computer Control

The CAT (Computer-Aided Tuning) System in the FT-767GX allows control of VFO/memory data entry, selection and tuning; IF shift and CTCSS tone selection by the operator's external personal computer. Bi-directional serial data is passed via the CAT jack on the rear panel of the transceiver, in the format below:

```

DATA RATE: 4800 bits/sec
START BIT: 1
DATA BITS: 8
STOP BITS: 2
PARITY: none
    
```

The chart at the bottom of this page shows the entire data sequence for one CAT command. Data is transmitted from left to right, so, for example, Parameter (Parm) 4 of the Command Block is sent first. 'SI' (Serial Input) and 'SO' (Serial Output) are the serial data bus lines at pins 3 and 2, respectively, on the CAT jack.

Note: All data blocks sent to the 767 must be five bytes long.

The Instruction Code sent by the external computer at the end of each 5-byte Command Block is the 'opcode' that instructs the FT-767GX what action is to be performed. The Instruction Code Chart on the next page describes each valid Instruction Code.

Notice that most Instructions require few or no arguments in the Parameter Bytes. However, every Command Block sent to the 767 must always consist of five bytes. The unused parameter bytes will be ignored when such Instructions are executed, so their value is irrelevant (they need not be zeroed).

After the computer sends the first Command Block the 767 should echo the same Block back to the computer (within 5 to 20ms), allowing your computer software to check that the Block was received properly, (if error checking is desired). If the echoed block does not match, an error has occurred in the serial interface, and the Command Block must be resent until the echo from the 767 matches (your software should time out and process the error after three tries).

When the echo from the 767 matches the Command Block, the computer next sends the 5-byte ACK Block, which is merely four dummy parameter bytes and a special Instruction Code (0Bh), which is not echoed. There is no time limit between the return of the echo by the 767 and sending of the ACK Block by your computer.

Upon receiving the ACK Block, the 767 processes the command, and responds on the CAT SO line (within 5 to 20ms) with the Status Update data, which is either 5, 8, 26 or 86 bytes long, according to the original Instruction Code (see the following Charts and Tables).

CAT SYSTEM TIMING CHART

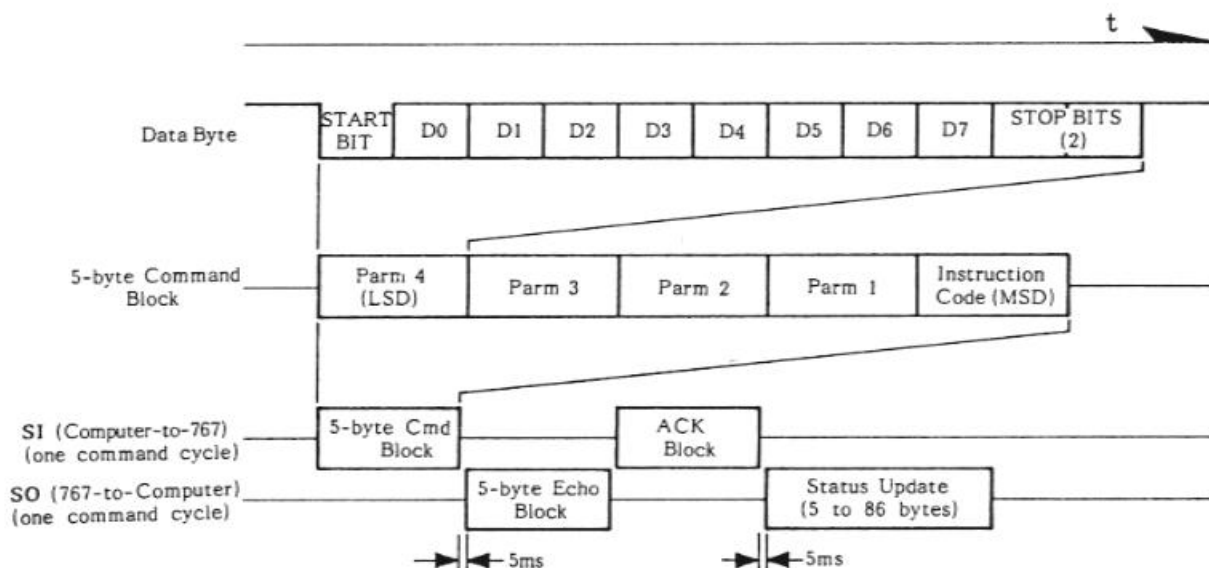

EXAMPLE: to set 14.25000 MHz as the current operating frequency;

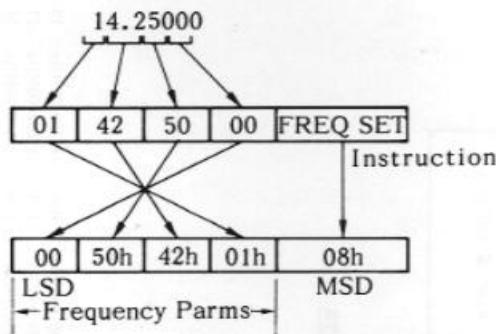

Notice that, for frequency parameters, the 100 MHz digit must be present and set to zero for frequencies below 100 MHz. Also notice that decimal frequency data must be translated into BCD (binary-coded decimal) parameters for sending, and that the LSD (least significant digit, Parameter 4, 100's and 10's of Hz) is sent first.

The rightmost column of the Instruction Code Chart indicates the number of Status Update bytes to be expected after sending each command. The Status Update Chart and accompanying tables show the format of these bytes: notice some parameters and flags are carried in bit fields.

The CAT jack also provides access to the PTT (Push-To-Talk) line at pin 4 to allow keying the transmitter. This pin has 8V DC on it when open-circuit (during reception), and activates the transmitter when grounded (sourcing 8 mA).

Also, the AGC signal at pin 5 of the CAT jack provides a high-impedance analog sample of the receiver AGC voltage: from 4V (with no signal) to 0V (with strong signal). This may be applied to an A-D converter to provide a digital signal for signal strength indication and scanning control by your computer.

INSTRUCTION CODE CHART

Instruction Name	Code (Hex)	Parameters (BCD)					Remarks	Status Update Size
		MSD	1	2	3	4 LSD		
CAT SW	00h	p1	xx	xx	xx		p1 value: 00=ON, 01=OFF	86
CHECK	01h	xx	xx	xx	xx		No op: return Status Only	86
UP10Hz	02h	xx	xx	xx	xx		Step frequency up 10 Hz	5
DN10Hz	03h	xx	xx	xx	xx		Step frequency down 10 Hz	5
PROG UP	04h	p1	p2	xx	xx		p1 & p2 = step size*	5
PROG DN	05h	p1	p2	xx	xx		p1 & p2 = step size*	5
BAND UP	06h	xx	xx	xx	xx		Step up one Band**	5
BAND DN	07h	xx	xx	xx	xx		Step down one Band**	5
FREQ SET	08h	p1	p2	p3	p4		Frequency Set (see EXAMPLE)	5
VFOMR	09h	p1	xx	xx	xx		VFO/Memory Select: p1 value: 00=VFO A, 01=VFO B, 02=MR	5
MEMSEL	0Ah	p1	xx	xx	xx		p1 value = memory no. (0 - 9)	8
MODESEL	0Ah	p1	xx	xx	xx		p1 value: 10h=LSB, 11h=USB, 12h=CW, 13h=AM, 14h=FM, 15h=FSK	8
HGSEL	0Ah	p1	xx	xx	xx		p1 value: 20h=HAM, 21h=GEN	26
SPLIT TOG	0Ah	30h	xx	xx	xx		Toggles SPLIT on/off	26
CLAR TOG	0Ah	40h	xx	xx	xx		Toggles Clarifier on/off	26
MTOV	0Ah	50h	xx	xx	xx		Memory to VFO	26
VTOM	0Ah	60h	xx	xx	xx		VFO to Memory	86
SWAP	0Ah	70h	xx	xx	xx		Swap VFO and Memory	86
ACLR	0Ah	80h	xx	xx	xx		Turn off SPLIT, CLAR, OFFSET	26
TONE SET	0Ch	p1	p2	p3	xx		p1,p2 = Tone Freq (BCD)***, p3=00 for Low-Q, 01 for Hi-Q	26
ACK	0Bh	xx	xx	xx	xx		required after each Code, no echo	

xx = any value: byte will be echoed, but will not affect command function.

* 00 00 to 99 99 representing 0 to 99.99 kHz (BCD).

** Band steps determined by current Ham/Gen selection: Ham bands, or 0.5 MHz.

*** 06 70 to 25 03 representing 67.0 to 250.3 Hz (BCD). See Tone Table 3 for list of valid tone frequencies.

TABLE 2. FREQUENCY DATA

Frequency digits appear in the data stream as binary-coded decimal (BCD: hexadecimal representation of decimal digits), with leading zero-fill to the 100's of MHz digit.

(EXAMPLE) 012.34567 MHz: Address 1 = 01h Address 2 = 23h
Address 3 = 45h Address 4 = 67h

TABLE 3. CTCSS TONE DATA

This data is significant only if the optional FTS-8 Tone Squelch Unit is installed. Note that CTCSS tones are only active in the FM mode; that the T ENC switch on the front panel must be pressed for the tone to be transmitted; and that the SQL control must be in the T SQL position for tone-squelched reception.

Freq. (Hz)	Value (Hex)	Freq. (Hz)	Value (Hex)	Freq. (Hz)	Value (Hex)
67.0	3Eh	136.5	2Fh	241.8	1Fh
71.9	3Dh	141.3	2Eh	250.3	1Eh
77.0	3Ch	146.2	2Dh	C57.0*	1Dh
82.5	3Bh	151.4	2Ch	C71.9	1Ch
88.5	3Ah	156.7	2Bh	C74.7	1Bh
94.8	39h	162.2	2Ah	C77.0	1Ah
100.0	38h	167.9	29h	C79.7	19h
103.5	37h	173.8	28h	C82.5	18h
107.2	36h	179.9	27h	C85.4	17h
110.9	35h	186.2	26h	C88.5	16h
114.8	34h	192.8	25h	C91.5	15h
118.8	33h	203.5	24h		
123.0	32h	210.7	23h		
127.3	31h	218.1	22h		
131.8	30h	225.7	21h		
		233.6	20h		

* 'C' tones have High Q (80).

TABLE 4. MODE DATA

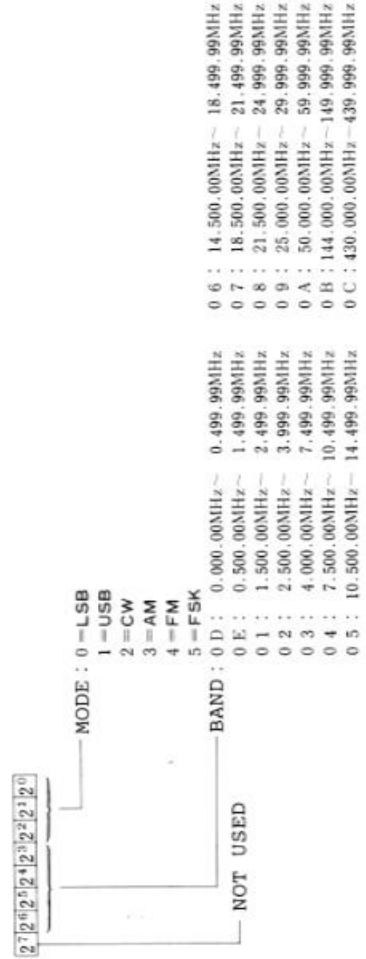

STATUS UPDATE CHART

(indicating format of data returned by 767)

Byte No.	Contents	Ref. Table
1	Status Flags	1
2-5	Operating Frequency (BCD)	2
6	Selected CTCSS Tone	3
7	Selected Mode	4
8	Selected Memory Channel No. (0-9)	Update
9-12	Clarifier Frequency (BCD)	8-Byte Status Update
13	Clarifier CTCSS Tone*	3
14	Clarifier Mode	4
15-18	VFO A Frequency (BCD)	2
19	VFO A CTCSS Tone*	3
20	VFO A Mode	4
21-24	VFO B Frequency (BCD)	2
25	VFO B CTCSS Tone*	3
26	VFO B Mode	4
27-30	Memory Channel 0 Frequency (BCD)	2
31	Memory Channel 0 CTCSS Tone*	3
32	Memory Channel 0 Mode	4
33-38	Memory Ch 1 (same format as 27-32)**	26-Byte Status Update
39-44	Memory Ch 2 (same format as 27-32)**	
45-50	Memory Ch 3 (same format as 27-32)**	
51-56	Memory Ch 4 (same format as 27-32)**	
57-62	Memory Ch 5 (same format as 27-32)**	
63-68	Memory Ch 6 (same format as 27-32)**	
69-74	Memory Ch 7 (same format as 27-32)**	86-Byte Status Update
75-80	Memory Ch 8 (same format as 27-32)**	
81-86	Memory Ch 9 (same format as 27-32)**	

* Optional FTS-8 Tone Squelch Unit must be installed

** Calculate Memory Channel addresses by:

- Channel Frequency Address = (Channel No. x 6) + 27
- Channel Tone Address = (Channel No. x 6) + 31
- Channel Mode Address = (Channel No. x 6) + 32

TABLE 1. STATUS FLAG BYTE

