

YAESU

The radio

HF/VHF/UHF ALL MODE TRANSCEIVER

FT-991

OPERATING MANUAL

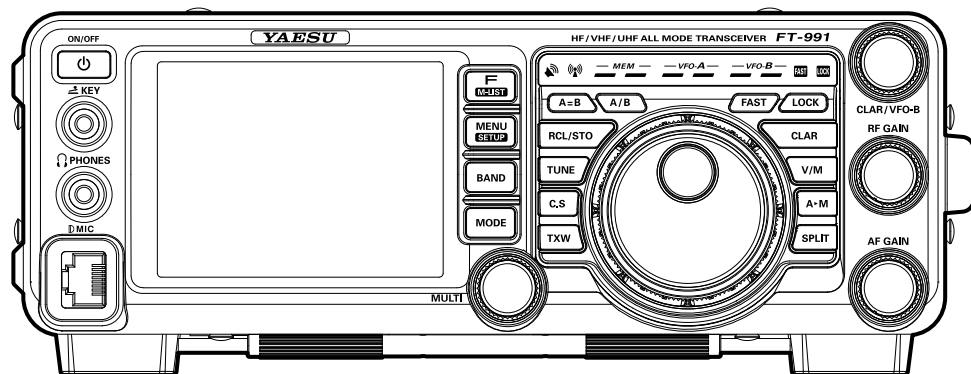

YAESU MUSEN CO., LTD.

Tennozu Parkside Building
2-5-8 Higashi-Shinagawa, Shinagawa-ku, Tokyo 140-0002 Japan

YAESU USA

6125 Phyllis Drive, Cypress, CA 90630, U.S.A.

YAESU UK

Unit 12, Sun Valley Business Park, Winnall Close
Winchester, Hampshire, SO23 0LB, U.K.

ABOUT THIS MANUAL . . .

The **FT-991** is a leading-edge transceiver with a number of new and exciting features, some of which may be unfamiliar to you. In order to gain the most enjoyment and operating efficiency from your **FT-991**, we recommend that you read this manual in its entirety, and keep it handy for reference as you explore the many capabilities of your new transceiver.

Before using your **FT-991**, be sure to read and follow the instructions in the “Before You Begin” section of this manual.

About TFT Displays

FT-991 utilizes a TFT liquid-crystal display.

- Although TFT liquid-crystal displays are made using very precise technology, they are prone to develop dead pixels (dark dot) or pixels that are always on (bright dot). Please understand that such phenomena do not constitute product defects or malfunctions. Rather, this phenomena occurs due to limitations in the manufacturing technology with respect to TFT liquid-crystal displays.
- Depending on the viewing angle, unevenness in color or brightness may occur. Please note that any unevenness observed is inherent to the construction of TFT liquid crystal displays and therefore does not constitute a product defect or malfunction.
- If your TFT liquid-crystal display becomes dirty, please use a dry soft cloth or tissue to wipe the display clean. Use of glass cleaner, household cleaners, organic solvents, alcohol, abrasives, and/or like substance may damage the TFT liquid-crystal display.

Built-in high-brightness TFT full-color display with touch-panel functionality

The **FT-991** is equipped with a 3.5 inch full-color TFT display. Functions, including the receiving band, the noise and signal interference reduction tools are graphically displayed. Even while performing rigorous operations, during DX pditions or contests, the operator may instantly grasp the status of each function.

Equipped with C4FM digital mode

This transceiver C4FM mode provides good error correction performance, and supports the V/D mode (voice/data simultaneous transmission mode) which makes the transceiver suitable for mobile communication, and the Voice FR mode (voice full rate mode) which allows the transceiver to transmit high quality digital audio. The AMS function recognizes the contacting stations transmission method and automatically switches the transceiver to the same C4FM digital or analog (FM) communications mode as the received signal.

GM (Group Monitor) function allows registering frequently communicating stations to a memory group. The group members may then automatically exchange (send/receive) station location information.

The transceiver automatically checks the channel frequency for registered member stations that are within communicating range. The distance and direction information of the call sign members of the group may be shown on the TFT display.

Comes equipped with two types of roofing filters

This transceiver is equipped with two types of roofing filters for 3kHz and 15kHz bandwidths. These narrow band filters are especially useful on a very crowded band during contests, because they can dramatically attenuate powerful out-of-band signals in the first IF stage and reduce their impact in the second stage to further optimizing the excellent dynamic range and IP3 characteristics for processing signals ranging from faint to powerful.

Two selectable RF amplifiers provide the optimal receiver gain for each low-to high HF band (see page 46.)

Configure the front end RF circuitry for the precise gain and performance to suit the conditions of each HF band. Select the IPO (Intercept Point Optimization) feature to optimize the proximal multi-signal and mutual modulation characteristics in order to minimize the effects of powerful broadcast stations, especially in the low-band so that even the faintest signals can be received. When higher gain is advantageous, select the single low noise RF amplifier AMP1. In the high bands, adding AMP2 provides maximum useful gain.

High stability built-in TCXO

The 30.225 MHz standard oscillator provides exceptional frequency stability. It is temperature compensated and boasts an enhanced ± 0.5 ppm stability from -10°C to $+50^{\circ}\text{C}$.

WIDTH feature and continuously variable bandwidth SHIFT feature. Optimal wide to narrow bandwidth switching (see pages 49, 50.)

The SHIFT feature, can eliminate interference in one side of the passband. The WIDTH feature allows the bandwidth to be narrowed by rotating the WIDTH knob. The moment weak signals disappear due to interfering signals (including pile-ups), you can eliminate the interfering signals and extract only the desired signal, thanks to the unique DSP sharp filtering characteristic.

CONTOUR feature is renowned for effective noise control (see page 48.)

Rather than using the DSP extremely sharp attenuation characteristics, the CONTOUR circuit provides gentle shaping of the DSP passband filter and can thus attenuate or peak bandwidth components in segments. The interfering signal can be naturally shaped without having part of the signal suddenly interrupted. The contour function is very effective in making the desired signal rise out of the interference.

DNR (Digital Noise Reduction) by DSP digital processing (see page 54.)

The incorporated digital noise reduction circuit may be set to the optimal working point by varying the 15 step parameters according to the noise type.

NOTCH feature that significantly eliminates unwanted beat signals; and DNF feature that instantly attenuates multiple beat signals (see page 54.)

When interfering beat signals are present in the receiver passband, the IF NOTCH feature can significantly eliminate a part of the passband and remove the beat signal. Moreover, the function is equipped with an Automatic Tracking System DNF (Digital Notch Filter) that can be engaged by DSP when there are multiple interfering signals, even when the frequency is changing.

Reliable High-output Final Amplifier Stage

In the HF/50MHz frequency range, a pair of RD100HHF1 transistors in a push-pull RF amplifier arrangement delivers 100 watts of low-distortion, high-quality transmitter power. The final amplifier for the 144 MHz/430 MHz bands uses the high-output RDH70HUF2 device, providing ample output power of 50 watts.

GENERAL DESCRIPTION

Microphone Amplifier that includes Parametric Equalizer (see page 63.)

The microphone amplifier equalizer feature is equipped with a three-stage parametric equalizer that can alter the Low, Mid, and High frequencies of the audio separately; this feature permits the bandwidth and gain for each part of the audio spectrum to be precisely adjusted independently.

High Speed Spectrum Scope (see page 40.)

The spectrum scope function provides a visual display of the intensity and distribution of signals across the band . When using the ASC (Automatic Spectrum-Scope Control) mode, the scope spectrum is automatically swept in response to the movement of the main tuning dial; the scanned spectrum signal distribution can be observed in real-time.

High speed antenna tuner (see page 61.)

The transceiver is equipped with the relay switching high speed digital tuner which supports 1.8 MHz to 50 MHz. The large 100-channel tuning data memory allows immediate recall of the optimum matching conditions for previously tuned frequencies.

Optional Five Channel Message Memory (voice memory) (see page 68.)

You can use the 5 channel voice memory function which is useful for operating in contests, etc. This voice memory enables recording of up to 20 seconds of audio for each message you want to send.

Custom selection (C.S) button (see page 37.)

This feature lets you select any Menu item for one-touch access via the **C.S** button.

TABLE OF CONTENTS

General Description	1	Interference Rejection	45
Table of Contents	3	ATT (Attenuator).....	45
Accessories & Options	5	IPO (Intercept Point Optimization).....	46
Supplied Accessories.....	5	IF Noise Blanker (NB) Operation	47
Available Options.....	6	CONTOUR Control Operation	48
Before You Begin	7	IF SHIFT Operation	
Base Station Wire Stand.....	7	(SSB/CW/RTTY/PKT Modes).....	49
Adjusting the Main Tuning Dial Torque	7	WIDTH (IF DSP Bandwidth) Tuning	
Adjusting the Clock.....	8	(SSB/CW/RTTY/DATA Modes).....	50
Inputting the Call Sign	9	NARROW (NAR) One-Touch IF Filter	
Resetting the Microprocessor.....	10	Selection	52
Antenna Considerations	11	IF NOTCH Filter Operation	
About Coaxial Cable	11	(SSB/CW/RTTY/DATA/AM Modes)	53
Grounding.....	12	Digital NOTCH Filter (DNF) Operation.....	54
Connection of Antenna and Power Cables.....	13	Digital Noise Reduction (DNR) Operation.....	54
Installation and Interconnections.....	14	Tools for Comfortable and Effective Reception	55
Connection of Microphone, Headphone and		RF Gain	55
Remote Control Keypad.....	14	Audio Peak Filter	56
Key, Keyer, and Computer-Driven Keying		AGC (Automatic Gain Control).....	57
Interconnections	15	Adjustable Receiver Audio Filter.....	58
VL-1000 Linear Amplifier Interconnections.....	16	SSB/AM Mode Transmission	59
Plug/Connector Pinout Diagrams.....	17	Using the Automatic Antenna Tuner	61
Front Panel Controls & Switches	18	ATU Operation	61
About the Display.....	22	About ATU Operation	62
TFT Liquid Crystal Display	22	Enhancing Transmit Signal Quality	63
LED Indicators	24	Parametric Microphone Equalizer	
Rear Panel.....	25	(SSB/AM mode).....	63
MH-31A8J Microphone Switches.....	27	Using the Speech Processor (SSB Mode)	66
Optional FH-2 Remote Control Switches	28	Adjusting the SSB Transmitted Bandwidth	
Optional MH-36E8J Microphone Switches.....	29	(SSB Mode).....	67
Basic Operation: Receiving on Amateur Bands	30	Transmitter Convenience Features	68
Operation on 60-Meter (5 MHz) Band		Voice Memory (SSB/AM modes)	68
(U.S. and U.K. version only).....	33	VOX (SSB/AM/FM Modes: Automatic TX/RX	
CLAR (Clarifier) Operation	34	Switching using Voice Control)	70
LOCK.....	35	MONITOR (SSB/AM modes).....	72
DIMMER	35	Split Operation Using the TX Clarifier	73
VFO COLOR	36	Split-Frequency Operation	74
Convenience Features	37	CW Mode Operation	76
Band Stack Operation.....	37	Setup for Straight Key	
C.S (Custom Switch).....	37	(and Straight Key emulation) Operation	76
AMS (Automatic Mode Select) Operation.....	38	Using the Built-in Electronic Keyer.....	78
SCOPE	40	CW Convenience Features	82
More Frequency Navigation Techniques	42	CW Spotting (Zero-Beating).....	82
Receiver Operation (Front End Block Diagram) ...	44	CW Delay Time Setting	83
		CW Pitch Adjustment.....	83
		Contest Memory Keyer	84
		FM Mode Operation	91
		Basic Operation.....	91
		Repeater Operation.....	92
		Tone Squelch Operation	94
		C4FM Mode (Digital Mode) Operation	95
		Memory Operation	97
		Convenient Memory functions.....	97
		QMB (Quick Memory Bank)	97
		Standard Memory Operation.....	98
		Memory Groups	104

TABLE OF CONTENTS

Operation on Alaska Emergency Frequency:	
5167.5 khz (U.S. Version Only)	106
VFO and Memory Scanning	107
VFO Scanning	107
Memory Scan	108
PMS (Programmable Memory Scanning)	109
Using the GPS Function	110
What is GPS?	110
Positioning Using GPS	110
Displaying the Position Information	112
Using the GM Function	113
What is the GM Function?	113
Basic Methods to Use the GM Function	113
RTTY (Radio Teletype) Operation	116
Example of Connecting RTTY Communications Device.....	116
DATA (PSK) Operation	118
Example of Data Communications Device	118
Menu Mode.....	120
Installation of Optional Accessories	139
FC-40 External Automatic Antenna Tuner (for Wire Antenna)	139
Active-Tuning Antenna System (ATAS-120A) Operation	141
Mounting Bracket MMB-90 Installation.....	143
Specifications	144
Index.....	146

SUPPLIED ACCESSORIES

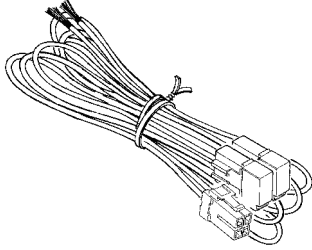

DC Power Cord

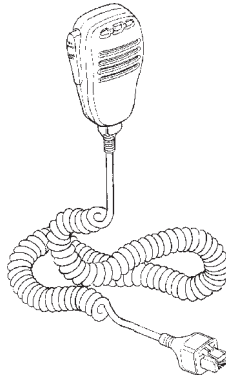

Hand Microphone (**MH-31A8J**)

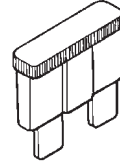

Spare Fuse (25A)

Operating Manual
Warranty Card
World Map
Sticker

The illustrations above may vary slightly from the actual accessories.

ACCESSORIES & OPTIONS

AVAILABLE OPTIONS

☐ For details, see “Installation of Optional Accessories” on page 139 or the catalog.

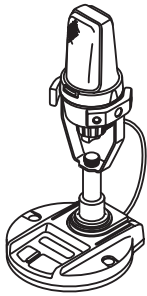

Ultra-High-Fidelity Desktop
Microphone
MD-200A8X



Lightweight Stereo Headphone
YH-77STA

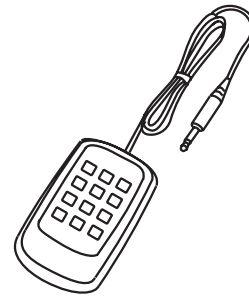

Remote Control Keypad
FH-2

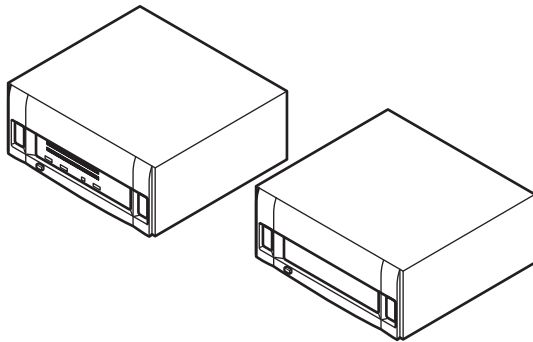

Linear Amplifier/AC Power Supply
VL-1000/VP-1000

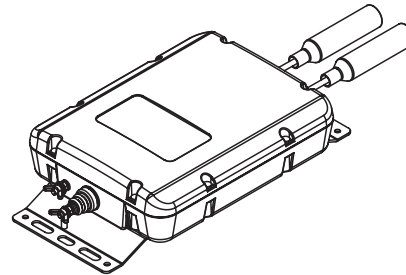

External Automatic Antenna Tuner
FC-40

Others

Hand Microphone

DTMF Hand Microphone

Desktop Microphone

Active Tuning Antenna (Automatic Type)

Antenna Base Kit

Active Tuning Antenna (Manual Type)

Mobile Bracket

External Power Supply (13.8 VDC 23 A)

External Power Supply (13.8 VDC 25 A)

VL-1000 Linear Amplifier Connection Cable

Packet Interface Cable

MH-31A8J (equivalent to the supplied microphone)

MH-36E8J

MD-100A8X

ATAS-120A

ATBK-100

ATAS-25

MMB-90

FP-1023A (U.S.A. only)

FP-1030A

CT-58

CT-39A

BASE STATION WIRE STAND

The heavy wire stand on the bottom of the transceiver allows the transceiver to be tilted upward for better viewing. Simply fold the stand forward to raise the front of the transceiver, and fold it back against the bottom case to lower the front of the **FT-991**.

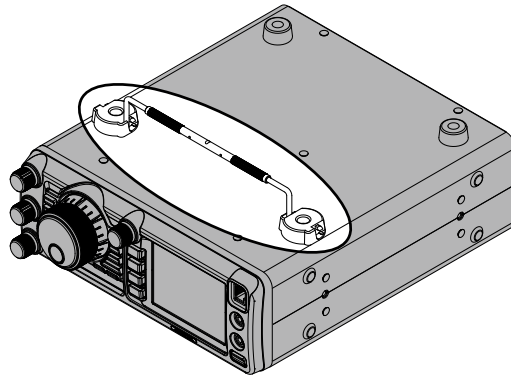

ADJUSTING THE MAIN TUNING DIAL TORQUE

The torque (drag) of the Main Tuning Dial knob may be adjusted according to your preferences. Rotate the skirt at the base of the knob clockwise to reduce the drag, or counter-clockwise to increase the drag.

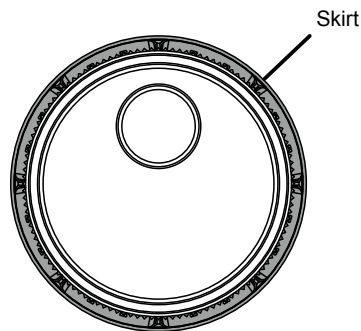

BEFORE YOU BEGIN

ADJUSTING THE CLOCK

Use the following procedure to adjust the clock shown at the top right of the LCD display.

1. Press and hold the **MENU(SETUP)** button.
2. Touch **[TIME/DATE]** on the LCD.

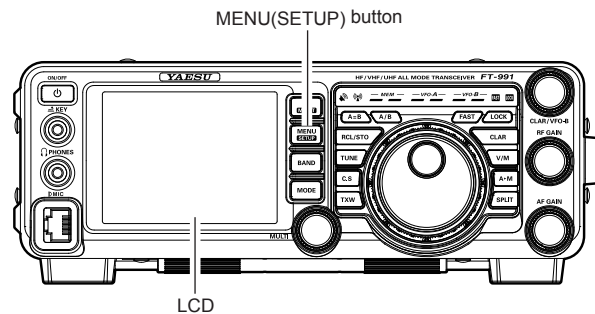
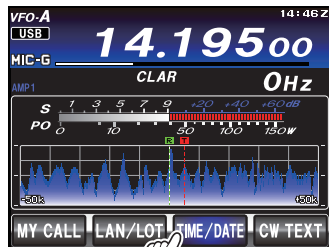

3. Enter the present time with the number keys on the LCD, then touch **[ENT]**.

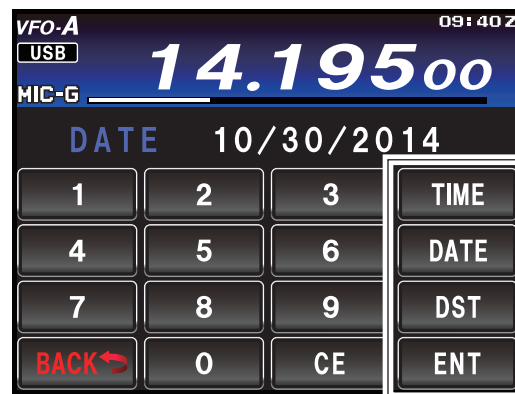

4. Touch **[DATE]** on the LCD to switch the screen.



5. Enter month, day, and year with the number keys on the LCD, then touch **[ENT]**.



6. Touch **[BACK]** on the LCD to return to the setup mode display.
7. Press the **MENU(SETUP)** button to return to the radio operation display.

[TIME]

Sets the time display. Touching this button toggles between UTC (Coordinated Universal Time) and the local time. When UTC is displayed, “Z” appears on the right side of the time.

[DATE]

Sets the date display. Touching this button toggles between MM/DD/YYYY and YYYY/MM/DD.

[DST]

Touching this button switches daylight saving time between ON and OFF. When daylight saving time is set to on, “D” appears on the right side of the time.

INPUTTING THE CALL SIGN

When turning on the power for the first time after purchase, or after resetting the transceiver, enter your own call sign.

The call sign will be displayed on the start screen when turning on the power and will be used to identify the station when sending messages during digital communication.

1. Press and hold the **MENU(SETUP)** button.
2. Touch **[MY CALL]** on the LCD.

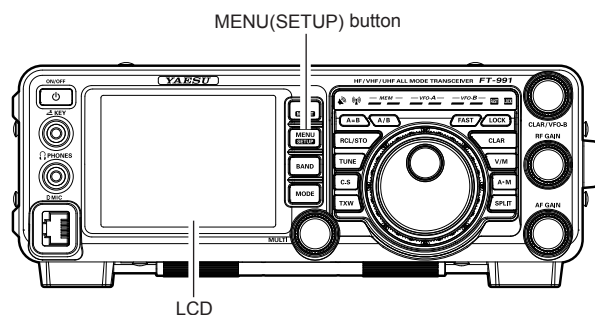
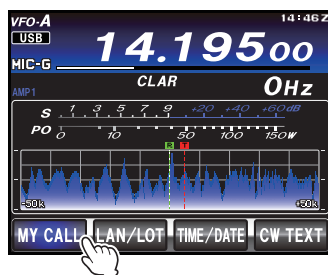

ADVICE:

The time duration of the initial call sign start up screen display may be changed from the Menu item "005 MY CALL INDICATION".

3. Touch a character key. The touched character will be displayed at the top of the screen. Enter each character of your call sign.



ADVICE:

- Up to 10 characters (letters, numbers, and symbols) can be entered.

4. Touch **[ENT]** on the LCD. The call sign setting is completed and the display will switch to the frequency display screen.



RESETTING THE MICROPROCESSOR

RESETTING MEMORIES (ONLY)

Use this procedure to reset (clear) the previously stored Memory channels, without affecting any configuration changes you may have made to the Menu settings.

1. Press the front panel **ON/OFF** switch to turn the transceiver off.
2. While holding the **A►M** button in, press and hold in the front panel **ON/OFF** switch to turn the transceiver on. Once the transceiver comes on, you may release the buttons.

NOTE:

The **FT-991** cannot erase the memory channels “01” (and “5-01” through “5-10”: U.S. version).

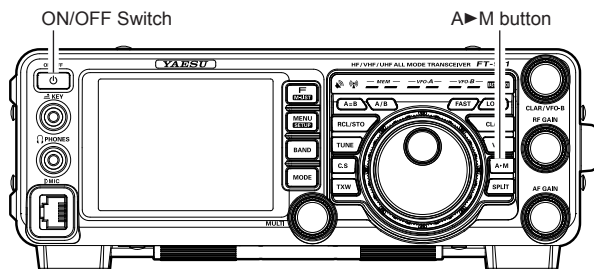

MENU RESETTING

Use this procedure to restore the Menu settings to their factory defaults, without affecting the programmed memories.

1. Press the front panel **ON/OFF** switch to turn the transceiver off.
2. While holding the **MENU(SETUP)** button in, press and hold in the front panel **ON/OFF** switch to turn the transceiver on. Once the transceiver comes on, release the buttons.

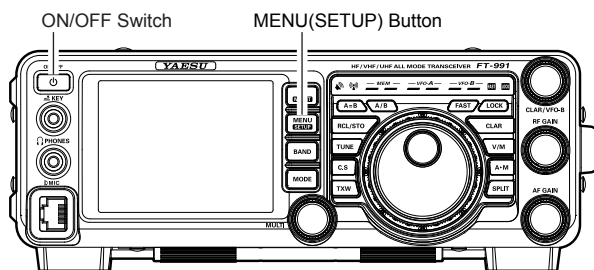

FULL RESET

Use this procedure to restore all Menu and Memory settings to their original factory defaults. All Memories will be cleared by this procedure.

1. Press the front panel **ON/OFF** switch to turn the transceiver off.
2. While holding the **FAST** and **LOCK** buttons in, press and hold in the front panel **ON/OFF** switch to turn the transceiver on. Once the transceiver comes on, release the buttons.

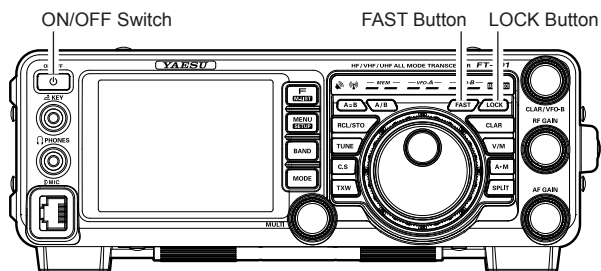

ANTENNA CONSIDERATIONS

The **FT-991** is designed for use with any antenna system providing a 50 Ohm resistive impedance at the desired operating frequency. While minor excursions from the 50-Ohm specification are of no consequence, if the Standing Wave Ratio (SWR) present at the Antenna jack is greater than 3:1, the transceiver's Automatic Antenna Tuner may not be able to reduce the impedance mismatch to an acceptable value.

Every effort should be made to ensure that the impedance of the antenna system be as close as possible to the specified 50-Ohm value. Note that the "G5RV" type antenna does not provide a 50-Ohm impedance on all HF Amateur bands. An external wide-range antenna coupler must be used with this antenna type.

Any antenna to be used with the **FT-991** must be fed from the transceiver with 50 Ohm coaxial cable. Therefore, when using a "balanced" antenna such as a dipole, remember that a balun or other matching/balancing device must be used to ensure proper antenna performance.

The same precautions apply to any additional (receive-only) antennas connected to the antenna jacks. If the receive only antennas do not have impedance near 50 Ohms at the operating frequency, It may be necessary to install an external antenna tuner to obtain optimum performance.

ABOUT COAXIAL CABLE

Use high-quality 50-Ohm coaxial cable for the lead-in to your **FT-991** transceiver. All efforts at providing an efficient antenna system will be wasted if poor quality, lossy coaxial cable is used. This transceiver utilizes standard "M" ("PL-259") type connectors.

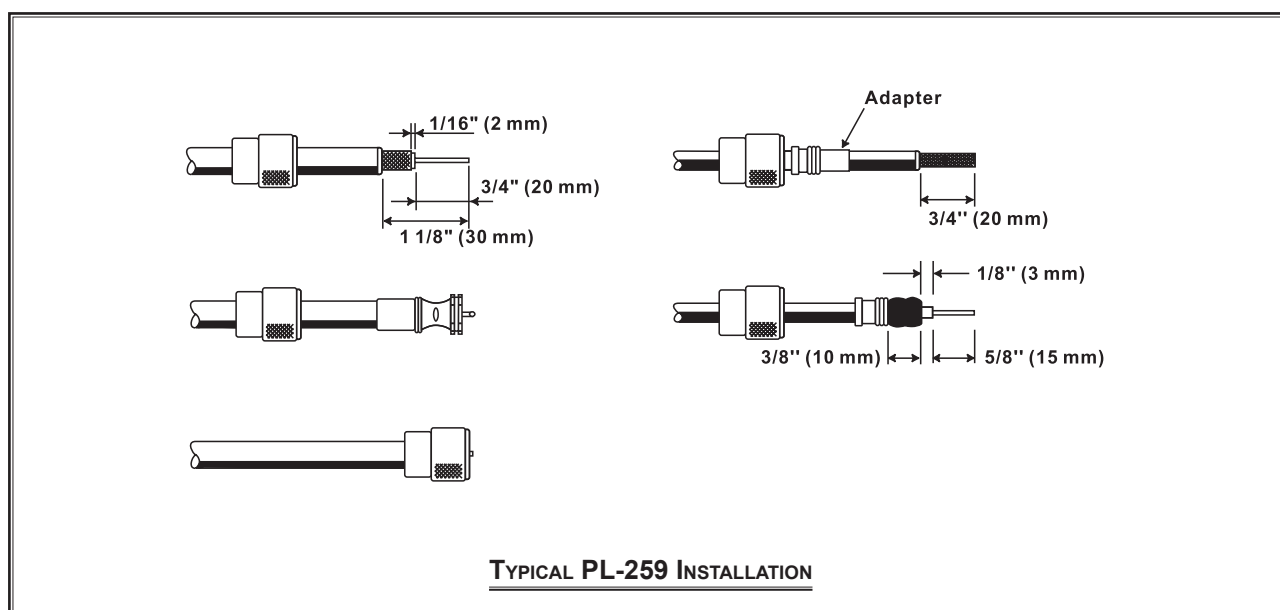

BEFORE YOU BEGIN

GROUNDING

The **FT-991** transceiver, like any other HF communications apparatus, requires an effective ground system for maximum electrical safety and best communications effectiveness. A good ground system can contribute to station efficiency in a number of ways:

- ❑ It can minimize the possibility of electrical shock to the operator.
- ❑ It can minimize RF currents flowing on the shield of the coaxial cable and the chassis of the transceiver. Such currents may lead to radiation, which can cause interference to home entertainment devices or laboratory test equipment.
- ❑ It can minimize the possibility of erratic transceiver/accessory operation caused by RF feedback and/or improper current flow through logic devices.

An effective earth ground system may take several forms. For a more complete discussion, see an appropriate RF engineering text. The information below is intended only as a guideline.

Typically, the ground connection consists of one or more copper-clad steel rods, driven into the ground. If multiple ground rods are used, they should be positioned in a “V” configuration and bonded together at the base of the “V” which is nearest the station location. Use a heavy, braided cable (such as the discarded shield from type RG-213 coaxial cable) and strong cable clamps to secure the braided cable(s) to the ground rods. Be sure to weatherproof the connections to ensure many years of reliable service. Use the same type of heavy, braided cable for the connections to the station ground bus (described below).

Inside the station, a common ground bus consisting of a copper pipe of at least 25 mm diameter should be used. An alternative station ground bus may consist of a wide copper plate (single-sided circuit board material is ideal) secured to the bottom of the operating desk. Grounding connections from individual transceivers, power supplies, and data communications devices (TNCs, etc.) should be made directly to the ground bus using a heavy, braided cable.

Do not “Daisy-Chain” ground connections from one electrical device to another and thence to the ground bus. This method may nullify any attempt at effective radio frequency grounding. See the drawing below for examples of proper grounding techniques.

Inspect the ground system - inside the station as well as outside - on a regular basis to ensure continued performance and safety.

Besides following the above guidelines carefully, note that household or industrial gas lines must never be used in an attempt to establish an electrical ground. Cold water pipes may, in some instances, help in the grounding effort, but gas lines represent a significant explosion hazard, and must never be used.

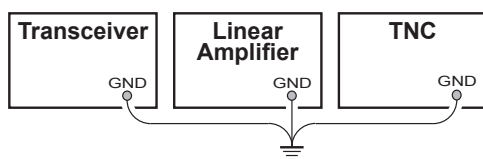

PROPER GROUND CONNECTION

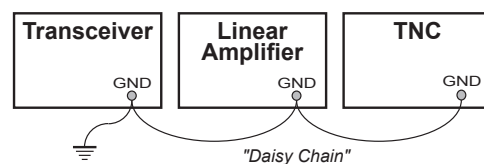

IMPROPER GROUND CONNECTION

CONNECTION OF ANTENNA AND POWER CABLES

Please follow the outline in the illustration regarding the proper connection of antenna coaxial cables, as well as the DC power cable. The DC power connector for the **FT-991** must only be connected to a DC source providing 13.8 Volts DC ($\pm 15\%$), and capable of at least 23 Amperes of current. Always observe proper polarity when making DC connection:

The RED DC power lead connects to the Positive (+) DC terminal.

The BLACK DC power lead connects to the Negative (-) DC terminal.

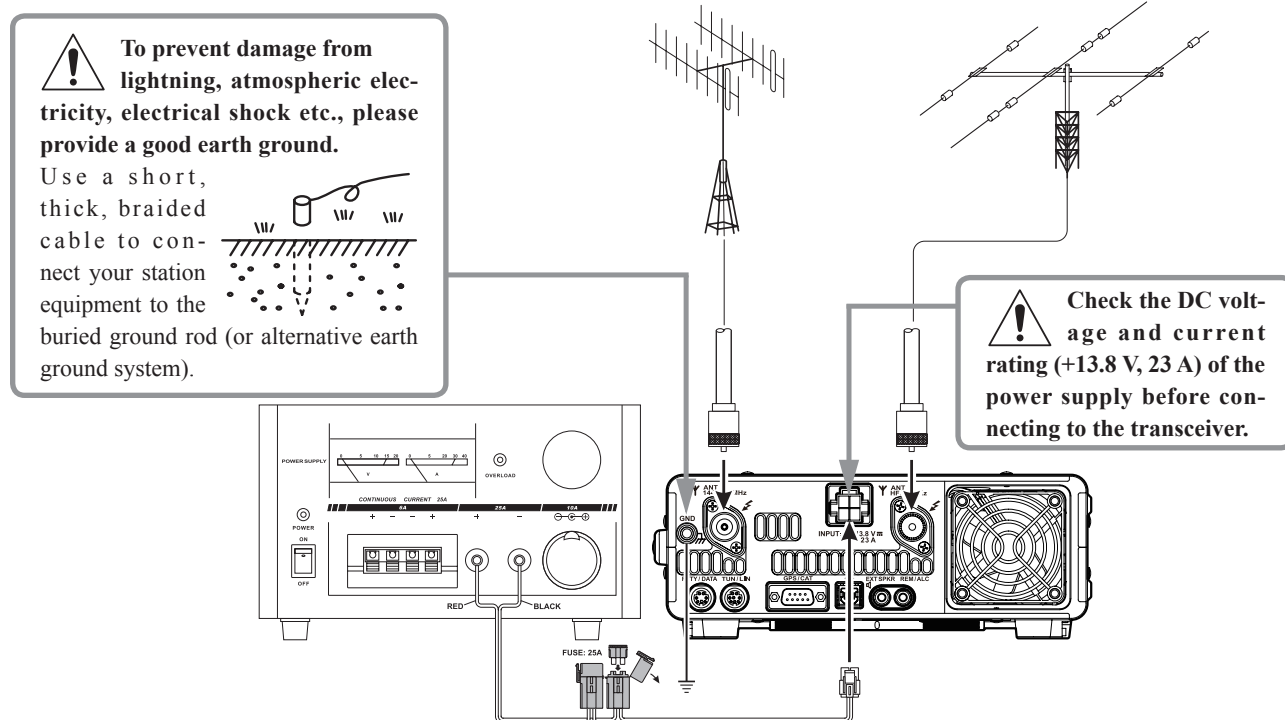

We recommend the use of the **FP-1030A** (USA market only) AC Power Supply. Other models of power supplies may be used with the **FT-991**, but the 13.8 VDC input voltage, 23 Ampere current capability, and DC cable polarity guidelines described above must be strictly followed.

Note that other manufacturers may use the same type of DC power connections as the **FT-991** transceiver; however, the wiring configuration may be different from that specified for the **FT-991** transceiver. Serious damage can be caused if improper DC connections are made; consult with a qualified service technician when in doubt.

High RF voltage is present in the TX RF section of the transceiver while transmitting.



Absolutely! Do not touch the TX RF section while transmitting.



Permanent damage can result when improper supply voltage, or reverse-polarity voltage, is applied to the **FT-991**. The Limited Warranty on this transceiver does not cover damage caused by application of AC voltage, reverse polarity DC, or DC voltage outside the specified range of 13.8 V $\pm 15\%$. When replacing fuses, be certain to use a fuse of the proper rating. The **FT-991** requires a 25 Amp blade fuse.

NOTE:

- Do not place the **FT-991** in a location with direct exposure to sunshine.
- Do not place the **FT-991** in a location exposed to dust and/or high humidity.
- Ensure adequate ventilation around the **FT-991**, to prevent heat build-up and possible reduction of performance due to high heat.
- Do not install the **FT-991** on an unstable desk or table. Do not place it in a location where objects may fall onto it from above.
- To minimize the possibility of interference to home entertainment devices, take all precautionary steps including separation of TV/FM antennas from Amateur transmitting antennas to the greatest extent possible, and keep transmitting coaxial cables separated from cables connected to home entertainment devices.
- Ensure that the DC power cord is not subject to undue stress or bending, which could damage the cable or cause it to be accidentally unplugged from the rear panel **DC IN** jack.
- Be certain to install your transmitting antenna(s) so they cannot possibly come in contact with TV/FM radio or other antennas, or with power or telephone lines.

INSTALLATION AND INTERCONNECTIONS

CONNECTION OF MICROPHONE, HEADPHONE AND REMOTE CONTROL KEYPAD

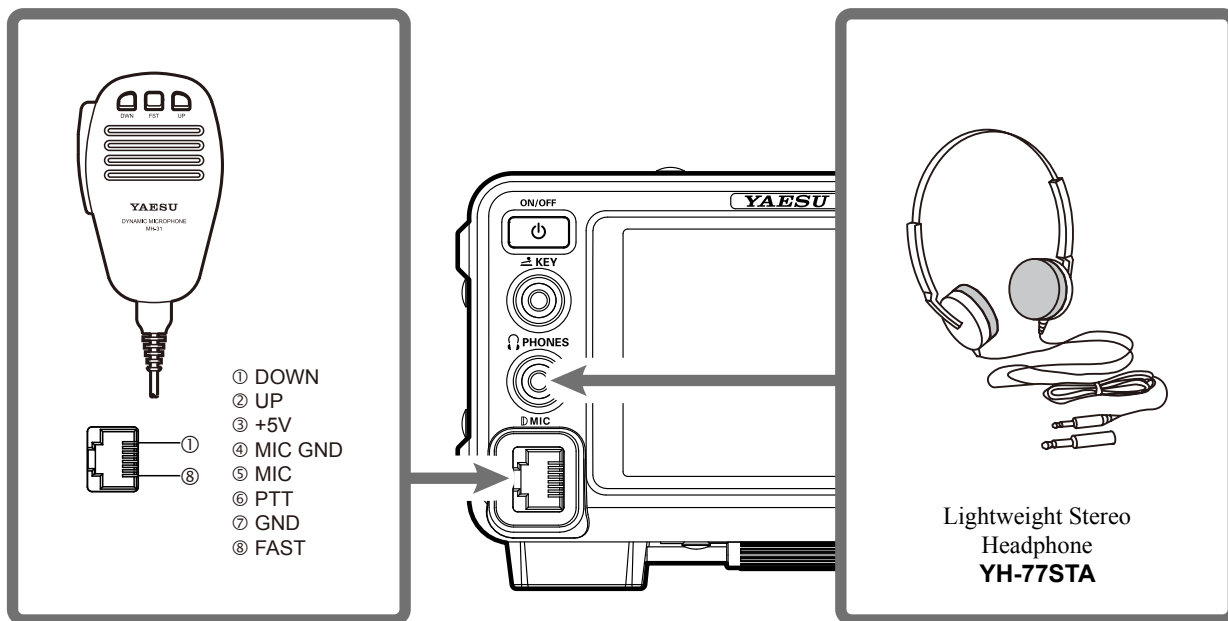

NOTE:

Make sure to turn off the power of the transceiver before connecting or disconnecting the microphone.

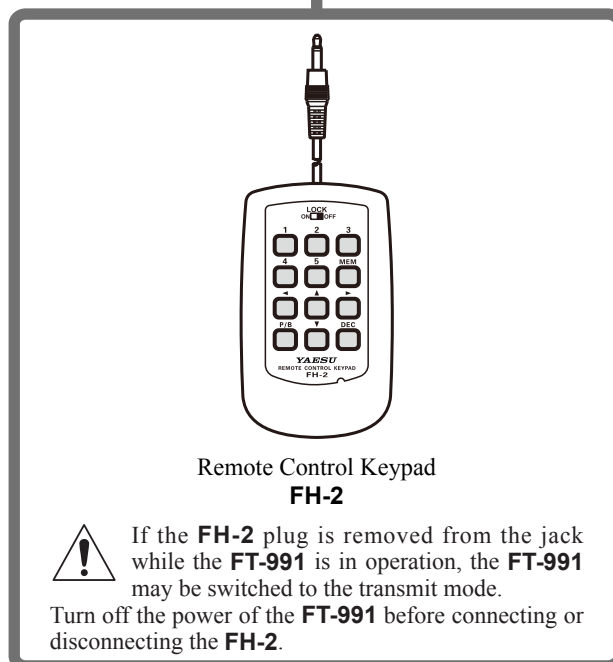
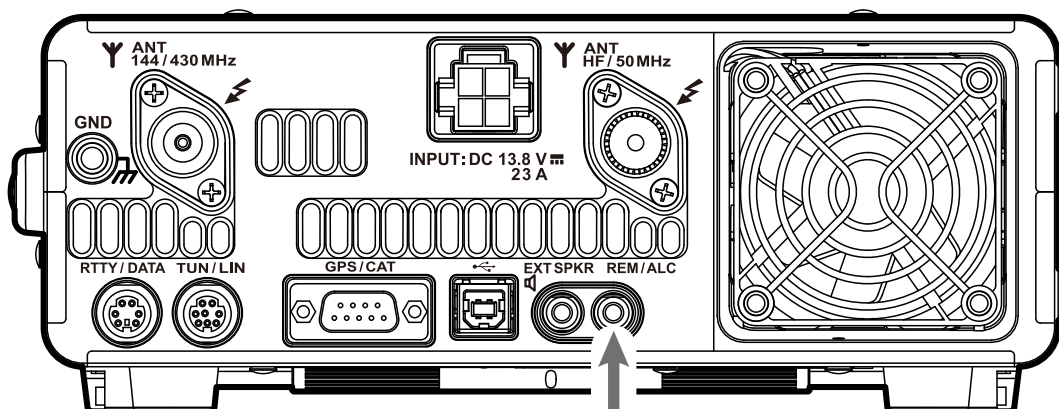

INSTALLATION AND INTERCONNECTIONS

KEY, KEYER, AND COMPUTER-DRIVEN KEYING INTERCONNECTIONS

The **FT-991** includes many features for the CW operator. These functions will be detailed in the “Operation” section later. Besides the built-in Electronic Keyer, two key jacks are provided, one on the front and one on the rear panel, for convenient connection to keying devices.

The Menu selections permit configuring the front panel **KEY** jack according to the device connected. For example, a keyer paddle may be connected to the front panel **KEY** jack, and Menu item “012 KEYSER TYPE” used to select paddle input.

The **KEY** jack on the **FT-991** utilize “Positive” keying voltage. Key-up voltage is approximately +3.3V DC, and key-down current is approximately 4 mA. When connecting a key or other device to the **KEY** jack, use *only* a 3-contact (“stereo”) 1/4” phone plug; a 2-contact plug will place a short between the ring and shaft (ground) of the plug, resulting in a constant “key-down” condition in some circumstances.

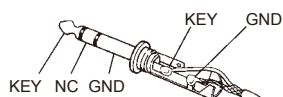
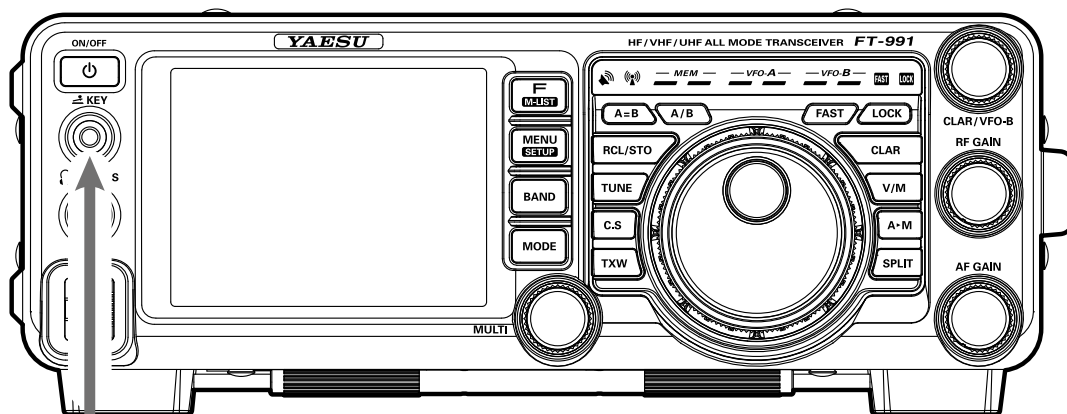

Single key/Double-speed key

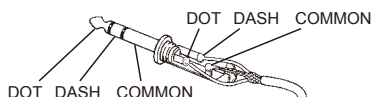

Manipulator



If the Keyer plug is removed from the jack while the **FT-991** is in operation, the **FT-991** may be switched to the transmit mode.

Turn off the power of the **FT-991** before connecting or disconnecting the Keyer.

INSTALLATION AND INTERCONNECTIONS

VL-1000 LINEAR AMPLIFIER INTERCONNECTIONS

Be sure that both the **FT-991** and **VL-1000** are turned off, and then follow the installation recommendations contained in the illustration.

NOTE:

- ❑ Refer to the **VL-1000** Operating Manual for details regarding amplifier operation.
- ❑ Do not attempt to connect or disconnect coaxial cables when your hands are wet.
- ❑ Set the Menu item “143 TUNER SELECT” to “LAMP”.
- ❑ Since the ALC cable is connected to the **REM/ALC** jack, the optional **FH-2** cannot be connected.

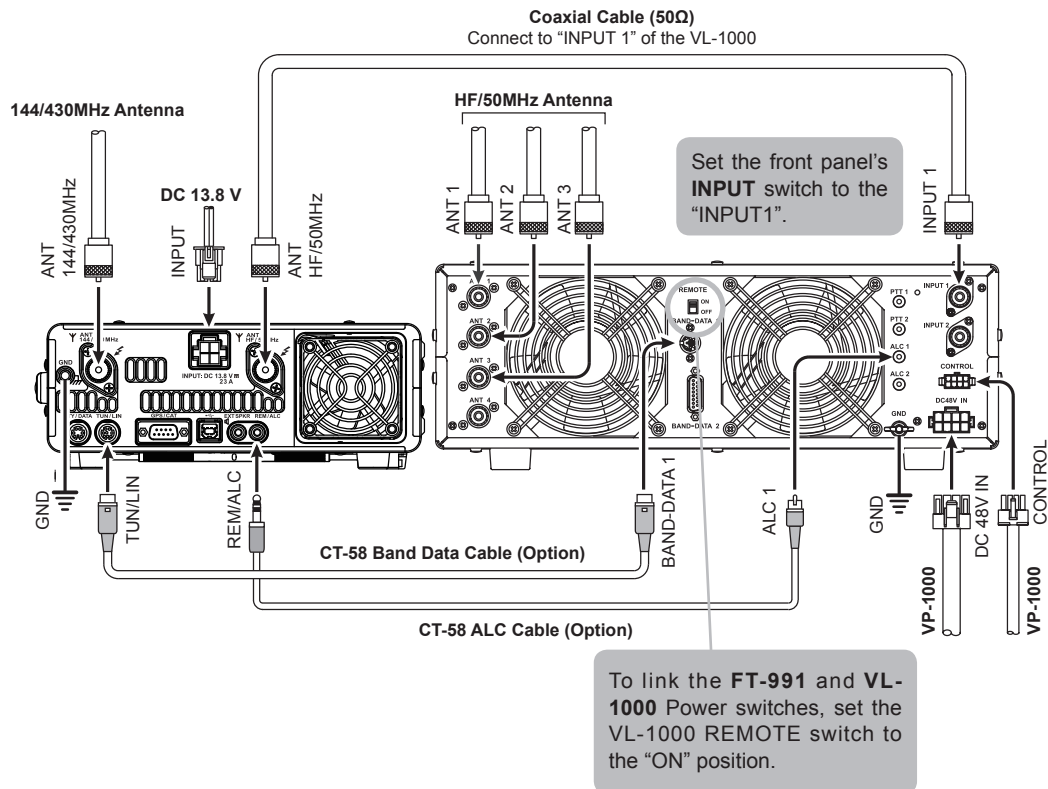

INSTALLATION AND INTERCONNECTIONS

PLUG/CONNECTOR PINOUT DIAGRAMS

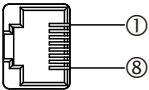
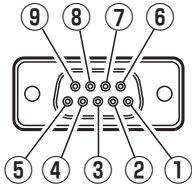
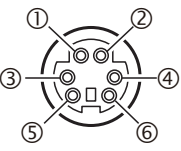
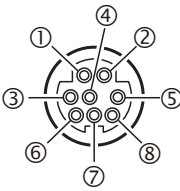
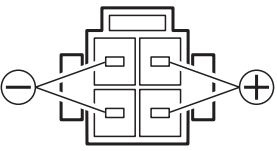
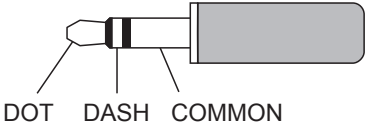
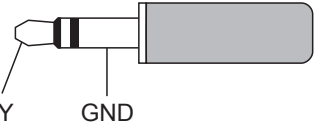
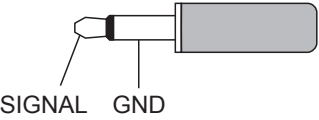
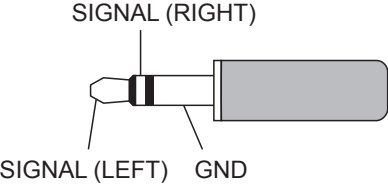
MIC		GPS/CAT	
 <ul style="list-style-type: none"> ① DOWN ② UP ③ +5V ④ MIC GND ⑤ MIC ⑥ PTT ⑦ GND ⑧ FAST <p>(as viewed from front panel)</p>		 <ul style="list-style-type: none"> ① DCD ② SERIAL OUT/RXD (GPS DATA IN) ③ SERIAL IN ④ DTR ⑤ GND ⑥ DSR ⑦ RTS ⑧ CTS ⑨ RI <p>(as viewed from rear panel)</p>	
RTTY/DATA		TUN/LIN	
 <ul style="list-style-type: none"> ① DATA IN ② GND ③ DAKY ④ SHIFT ⑤ RTYO ⑥ BUSY <p>(as viewed from rear panel)</p>		 <ul style="list-style-type: none"> ① +13V OUT ② TX GND ③ GND ④ TX D (BAND A) ⑤ RX D (BAND B) ⑥ BAND C ⑦ RESET (BAND D) ⑧ TX INH <p>(as viewed from rear panel)</p>	
DC IN		KEY	
 <p>(as viewed from rear panel)</p>		<p>Manipulator</p>  <p>Single key/Double-speed key</p>  <p>Do not use 2-conductor type plug</p>	
EXT SPKR, REM/ALC		PHONE	
			

FRONT PANEL CONTROLS & SWITCHES

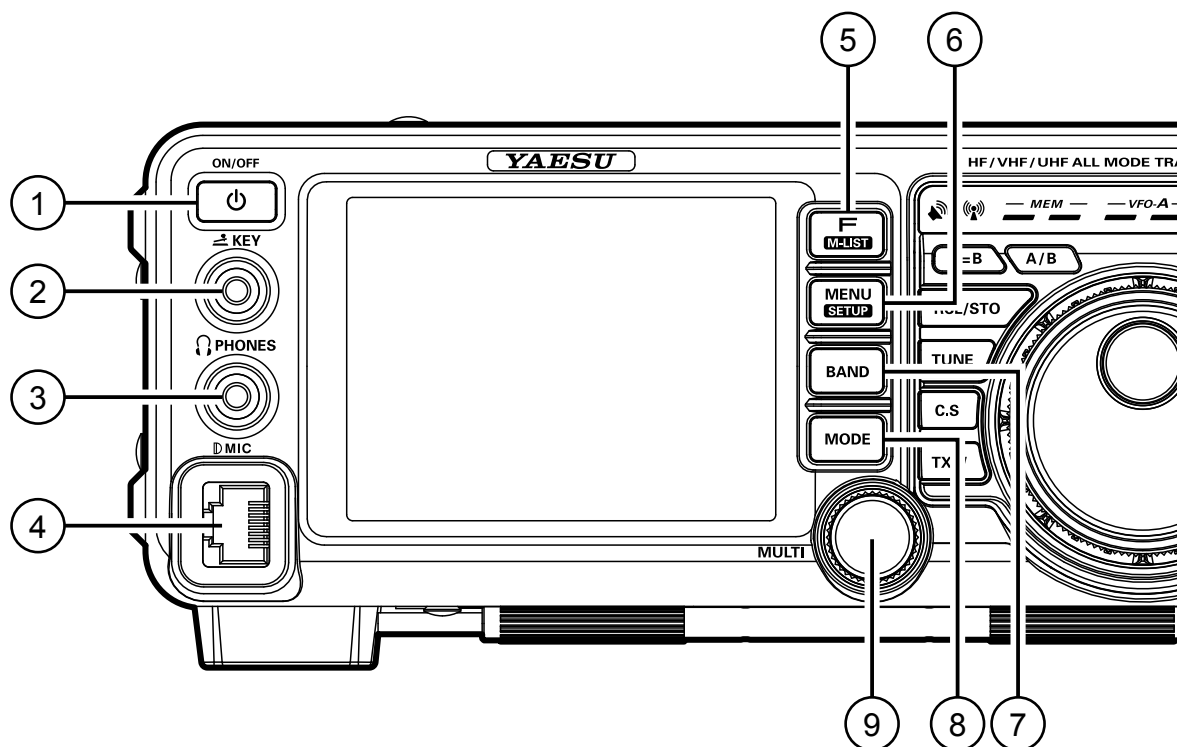

① ON/OFF Switch

Press and hold in this switch for one second to turn the transceiver on. Similarly, press and hold in this switch for one second to turn the transceiver off.

- Connect the **FT-991** transceiver to a commercially available DC power supply. Turn the DC supply on to place the transceiver in standby mode. The transceiver must be in standby mode to turn it on using the **ON/OFF** switch. For details on how to connect a commercially available DC power supply, see page 13.
- Press the **ON/OFF** switch briefly while the power is on, the receiver audio from the speaker will be muted for about 3 seconds (Mute function).

② KEY Jack

Connect a telegraph key or electronic keyer paddle to use for CW mode operation.

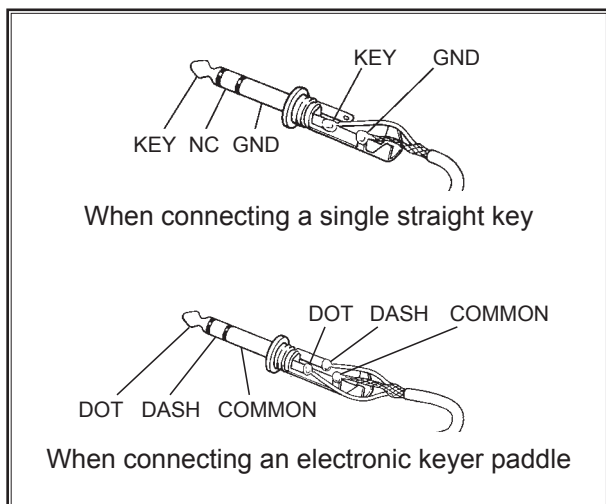

- When connecting a key or other device to the **KEY** jack, use **only** a 3-contact (“stereo”) 1/4” phone plug; a 2-contact plug will place a short between the ring and the (grounded) shaft of the plug, resulting in a constant “key-down” condition.
- Key-up voltage is +3.3 V, and key-down current is about 4 mA.

NOTE:

A 2-contact plug cannot be used in this jack.

③ PHONES Jack

Connect headphones to this $\phi 3.5$ standard stereo jack.

- Inserting a headphone plug into this jack will deactivate the internal and external speakers.

NOTE:

When wearing headphones, we recommend that you turn the AF Gain levels down to their lowest settings before turning power on, to minimize the impact on your hearing caused by audio “pops” during switch-on.

④ MIC Jack

This 8-pin jack accepts input from a microphone utilizing a traditional YAESU HF transceiver pinout.

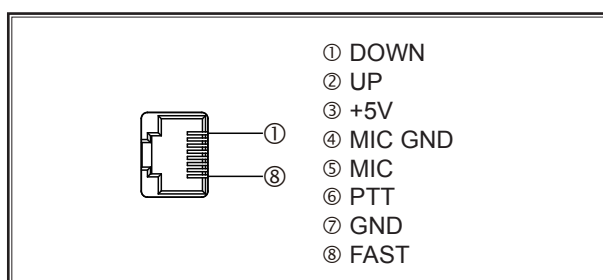

FRONT PANEL CONTROLS & SWITCHES

⑤ F(M-LIST) Button

Press the button briefly to display the function menu screen where the operation settings for a variety of functions may be configured.

Press this button again to close the function menu screen.

Press and hold this button for more than one second to display the menu list screen where the memory channel data may be reviewed.

- While displaying the memory data, rotate the [MULTI] knob to review all data in memory channels.

Press this button again to close the memory list screen.

⑥ MENU(SETUP) Button

Press this button briefly to display the menu mode screen (see page 120) where you can set a variety of functions.

Press this button again (or touch [BACK] on the touch panel) to close the menu mode screen.

Press and hold this button for more than 1 second to display the setup screen where you can configure the following settings.

- **MY CALL:** Setting the call sign (see page 9)
- **LAT/LON:** Setting longitude/latitude (see page 112)
- **TIME/DATE:** Setting date and time (see page 8)
- **CW TEXT:** Entering CW TEXT (see page 87)

Press this button again to close the setup screen.

⑦ BAND Button

Switch the operation band (operation frequency band). Press this button to display the operation band selection screen, then touch and select the desired band.

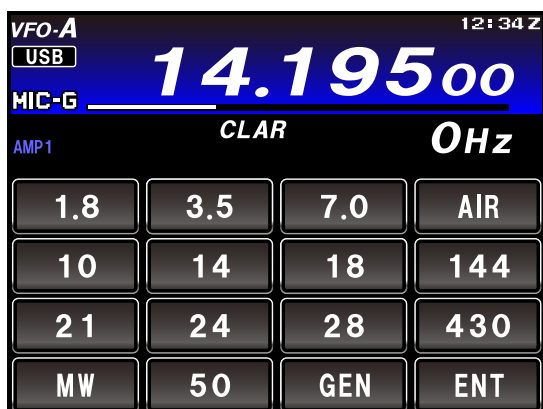

⑧ MODE Button

Switch the radio modulation form (operating mode). Press this button to display the radio modulation form selection screen, then touch and select your desired modulation form.

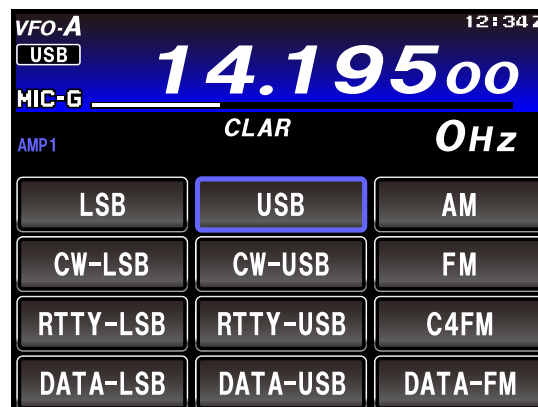

⑨ MULTI Knob

Adjust transmit output, microphone gain and operations of other functions (see page 22).

FRONT PANEL CONTROLS & SWITCHES

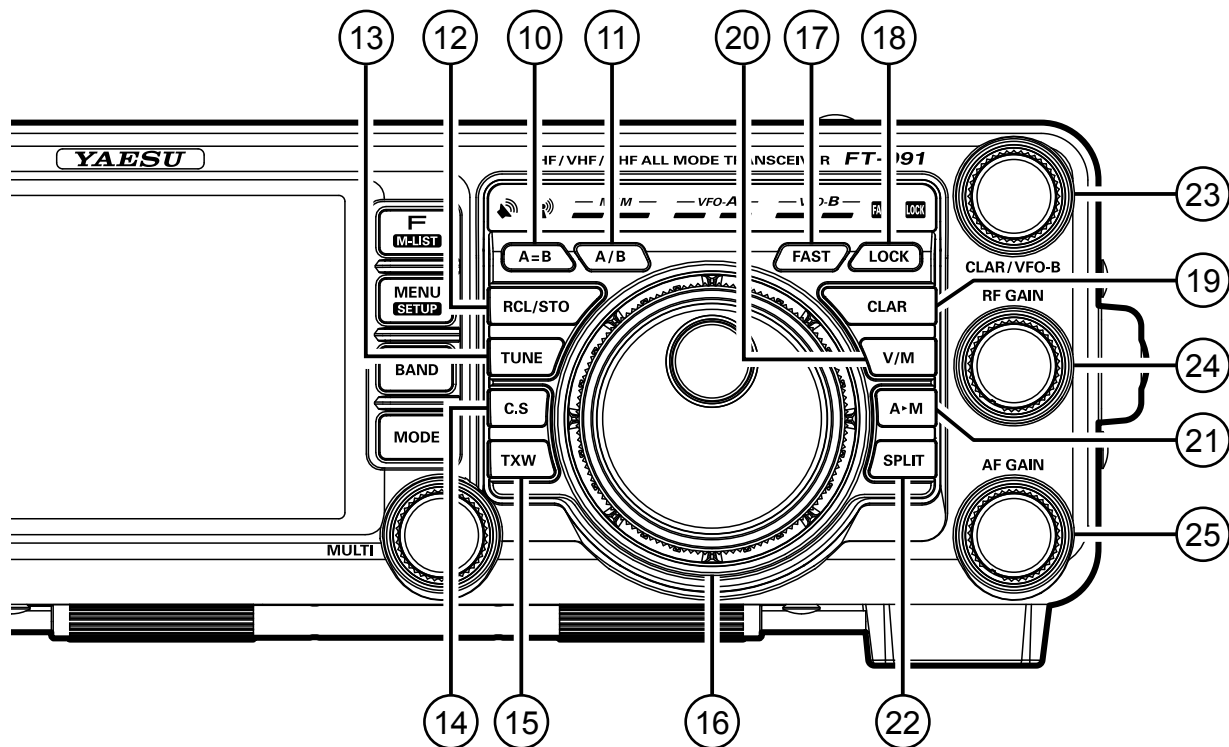

⑩ **A=B** Button

Pressing this button momentarily, sets the same frequency and data values of VFO-A to VFO-B.

⑪ **A/B** Button

Pressing this button momentarily, exchanges the frequency and memory channel data, of VFO-A and VFO-B.

⑫ **RCL/STO** Button

Press and hold this button for more than one second to write the frequency and data currently set for VFO-A onto the quick memory bank (QMB) (see page 97).

- 5 channels are available for QMB memories.

Press the button briefly to recall the data written onto the quick memory banks (QMB) one by one.

⑬ **TUNE** Button

This is the on/off switch for the **FT-991** Automatic Antenna Tuner.

- Press the [**TUNE**] button briefly to display the “**TUNER**” indicator on the touch panel and activate the antenna tuner.

Press the [**TUNE**] button briefly again to turn the “**TUNER**” indicator off and disable the antenna tuner.

- Press the [**TUNE**] button for about 1 second to start “automatic tuning”. The “**TUNER**” indicator will flash.

NOTE:

- Since the transceiver transmits automatically during automatic tuning, make sure to connect an antenna or dummy load before tuning up.
- When the antenna or dummy load does not match the impedance, “**HI-SWR**” will appear on the touch panel.

⑭ **C.S** Button

Press this button momentarily to directly recall a favorite Menu Selection.

- To program a Menu selection to the **C.S** button, press the **MENU(SETUP)** button to enter the Menu. Select the Menu item you want to set as the short cut. Press the **C.S** button, then press the **MENU(SETUP)** button; this will lock in the selected Menu item as the short cut.

⑮ **TXW** Button

During a split operation, press and hold the **TXW** button to listen on the transmitter frequency while holding the button.

FRONT PANEL CONTROLS & SWITCHES

⑩ Main Tuning Dial Knob

This large knob adjusts the operating frequency of VFO-A.

Rotate clockwise to increase the operating frequency and rotate counter-clockwise to decrease the operating frequency.

OPERATING MODE	1 STEP	1 DIAL ROTATION
LSB/USB/CW/RTTY/ DATA-LSB/DATA- USB/AM	5 Hz (100 Hz) 10 Hz (100 Hz)	1 kHz (200 kHz) 2 kHz (20 kHz)
FM/DATA-FM/C4FM	100 Hz (1 kHz)	20 kHz (200 kHz)

Numbers in parentheses indicate steps when the **FAST** button is On.

ADVICE:

The tuning steps for the Main Dial knob are set at the factory to: 10Hz (SSB/AM), 5 Hz (CW/RTTY/DATA-LSB/DATA-USB) and 100 Hz (FM/DATA-FM/C4FM) per step.

In LSB, USB, CW, RTTY, DATA-LSB or DATA-USB mode, the frequency change amount (step width) may be toggled between “5Hz” and “10Hz” by pressing the **F(M-LIST)** button, and then touching [**5/10Hz**] on the LCD.

⑪ FAST Button

Pressing this button will change the tuning of the Main Tuning Dial knob (VFO-A) to a higher step rate.

Press this button to double the main dial frequency variation. “**FAST**” in the LED indicator area will light up.

Press this button again to restore the frequency variation to the original value. “**FAST**” will disappear.

⑫ LOCK Button

This button toggles on/off locking of the Main Tuning Dial knob.

Press this button to lock the main dial operations. “**LOCK**” will light up in the LED indicator area.

Press this button again to unlock the main dial operations. “**LOCK**” will disappear.

⑬ CLAR Button

During reception, press this button, then rotate the **CLAR/VFO-B** knob to adjust the VFO-A RX clarifier offset value (see page 34).

○ The clarifier offset value (frequency) can be restored to “0 (zero)” by pressing the **CLAR** button for more than 1 second.

○ Depending on the menu mode “040 CLAR MODE SELECT” setting, this button can work as the TX clarifier for changing only the transmit frequency (see page 73) or RX/TX clarifier for both receiving and transmitting (see page 34, 73).

⑭ V/M Button

This button toggles frequency control between VFO-A and the memory system.

○ Pressing this button alternately recalls the VFO frequency data and the frequency data saved in a memory channel by turns.

⑮ A▶M Button

Pressing and holding this key for one second (until the double beep) copies the current operating data into the currently selected memory channel, overwriting any previous data stored there.

Press this button briefly to display the memory check function screen, where the data saved in a memory channel may be reviewed.

○ While displaying memory data, rotate the **MULTI** knob to review the data in each memory channel. Press this button again, to close the memory list screen.

⑯ SPLIT Button

Press this button to operate split frequency between VFO-A (used for reception) and VFO-B (used for transmission) (see page 74).

○ Press and hold in the **SPLIT** button for one second to engage the “Quick Split” (see page 74) feature. VFO-B transmit will automatically be set to a frequency 5 kHz higher than the VFO-A receive frequency, with the same operating mode. The transceiver will operate in the Split mode.

⑰ CLAR/VFO-B Knob

During the VFO-A operation, rotate this knob to adjust the clarifier.

During Split operation, this knob adjusts the operating frequency of VFO-B.

⑱ RF GAIN Knob

Adjust the receiver gain of the high frequency and mid-range frequency amplifier stages.

○ Rotate the knob clockwise to increase the gain. Rotate the knob fully clockwise to set the gain to the highest level for normal operations.

⑲ AF GAIN Knob

The **AF GAIN** knob sets the receiver audio volume level.

○ Rotate the knob clockwise to increase the receiver audio volume level.

ABOUT THE DISPLAY

TFT LIQUID CRYSTAL DISPLAY

A variety of information such as VFO-A/VFO-B frequencies, mode, S-meter will appear on the LCD.

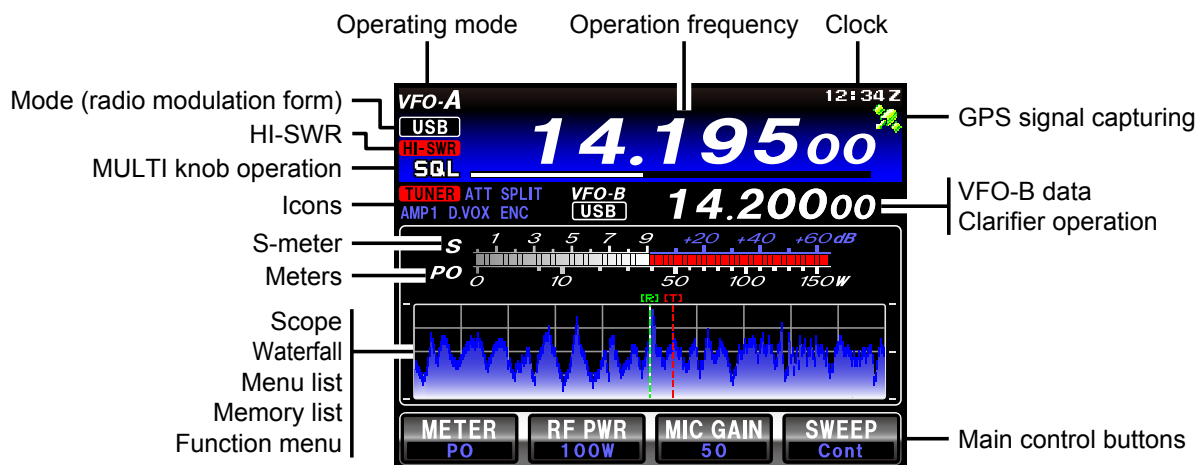

Operating Mode Indicators

Displays the current operating mode.

VFO-A	Operating in VFO-A mode
MEM	Operating in memory mode
MT	The memory tuning feature is in use
QMB	Operating with the quick memory feature
PMS	Programmable memory scanning
MCK	The memory check function is in use
HOME	Recalling the home channel
EMG	Recalling the frequency for emergency contact

Current Mode

(Modulation Form) Indicator

Displays the current modulation form.

HI-SWR Indicator

Indicates antenna matching errors.

When this warning appears, stop transmitting immediately, check and repair the antenna, connectors, cables, etc.

MULTI Knob Operations

Displays the functions operated with the **MULTI** knob (see page 19).

The progress bar shows the operation status.

RF-P	Adjusts transmission output
MIC-G	Adjusts the microphone gain
NB-L	Adjusts the noise blanker level
SHIFT	Shift function
WIDTH	Width function
NOTCH	Notch function
CONT	Contour function

DNR	Digital Noise Reduction function
PROC	Adjusts Speech Processor Gain
MONI	Adjusts the monitor level
DT-G	Adjusts the input level during data communication
CH-D	Frequency tuning in the pre-programmed steps
SPEED	Adjusts keying speed
APF	Audio Peak Filter function
PITCH	Adjusts the CW pitch
SQL	Adjusts the squelch level
STONE	Selects the tone frequency
DCS	Selects the DCS code
MCH	Selects the memory channel
GRP	Selects the memory group

Icons

Displays currently used functions.

TUNER	Antenna tuner
ATAS	Active Tuning Antenna System
ATT	The attenuator is in use
SPLIT	Running split operation
DUP	Recalling duplex memories
[+]	Plus shift
[-]	Minus shift
IPO	The receiver amplifier is OFF
AMP1	The receiver amplifier is ON
AMP2	
D.VOX	The VOX function activates during data communication
VOX	The VOX function is in use
ENC	The tone encoder is in use
DEC	The tone decoder is in use
DCS	The digital code squelch is in use

TFT LIQUID CRYSTAL DISPLAY

PLAY	The voice memory/contest memory keyer functions are in use.
REC	PLAY: Playing, REC: Recording

S-Meter

Displays the reception signal strength.

To change the meter peak hold time

1. Press the **MENU(SETUP)** button.
2. Rotate the **MULTI** knob to select “009 BAR MTR PEAK HOLD”.
3. Touch [**SELECT**], then rotate the **MULTI** knob to select the time to hold (OFF/0.5/1.0/2.0 seconds).
4. Touch [**ENTER**], then [**BACK**] or press the **MENU(SETUP)** button.

Meters

The following information can be displayed below the S-meter.

The displayed information is switched each time [**METER**] is touched on the panel.

PO	Displays transmitter output power.
ALC	Displays ALC voltage
SWR	Displays antenna matching state
COMP	Displays the speech processor compression level
ID	Displays the drain current of the final stage FET transistors
VDD	Displays the drain voltage of the final stage amplifier. The proper voltage is 13.8 V.

Scope/Waterfall

Displays a spectrum or waterfall when the scope function (see page 40) is in use.

Menu List

Displays the menu item list when making settings in the menu mode.

Memory List

Displays the data saved in the memory channels.

Function Menu

Displays the function menu from which you can set a variety of functions.

Touch [**BACK**]/[**FWD**] to switch the menu screen.

Operation Frequency

Displays the current operation frequency.

Clock

Indicates the current time.

When receiving a GPS signal, the time is set automatically.

GPS Signal Capturing Indicator

Appears when an external GPS device is connected to the **GPS/CAT** jack on the rear panel and GPS signals are being acquired.

VFO-B Data/Clarifier Operation

Displays operation status of the radio modulation form and VFO-B frequency, etc.

Displays the offset operation status and the clarifier offset value, etc.

Main Control Buttons

Frequently used functions can be assigned to these buttons.

To change the function assigned to the main control button

1. Press the **F(M-LIST)** button.
2. Touch [**BACK**]/[**FWD**] to display screens “**SWAP F1**” to “**SWAP F4**”.
3. Touch one of the “**SWAP F1**” to “**SWAP F4**” screens and confirm the function you want to change flashes.
4. Touch [**BACK**]/[**FWD**] to display the function you want to assign, then select and touch the function.
5. Press the **F(M-LIST)** button.

LED INDICATORS

Displays the transmit/receive status of the transceiver, and the main dial “**FAST**” and “**LOCK**”.

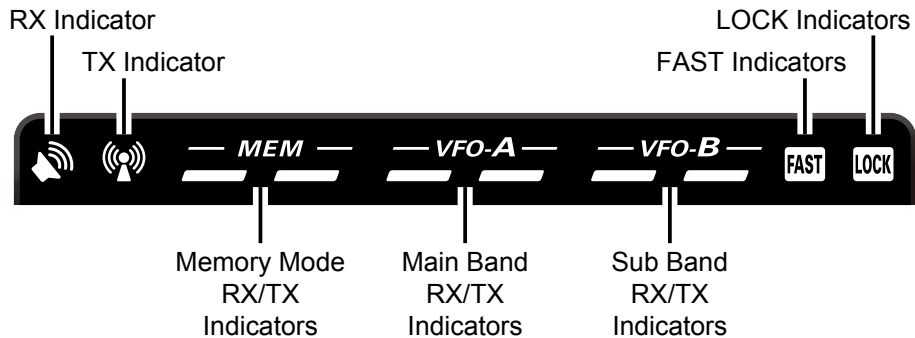

RX Indicator (Green)

This indicator illuminates when the squelch opens.

TX Indicator (Red)

This indicator illuminates during transmission.

Memory Mode RX/TX Indicators

Green (Left):

This indicator illuminates when the receiver is active on the memory channel.

Red (Right):

This indicator illuminates when the transmitter is active on the memory channel.

Main Band RX/TX Indicators

Green (Left):

This indicator illuminates when the receiver is active on the main band (VFO-A).

Red (Right):

This indicator illuminates when the transmitter is active on the main band (VFO-A).

Sub Band RX/TX Indicators

Green (Left):

This indicator illuminates when the receiver is active on the main band (VFO-B).

Red (Right):

This indicator illuminates when the transmitter is active on the main band (VFO-B).

FAST Indicators

This indicator appears when the Main Tuning Dial knob tuning rate is set to “fast” (see page 21).

LOCK Indicators

This indicator appears when the Main Tuning Dial knob is locked (see page 21).

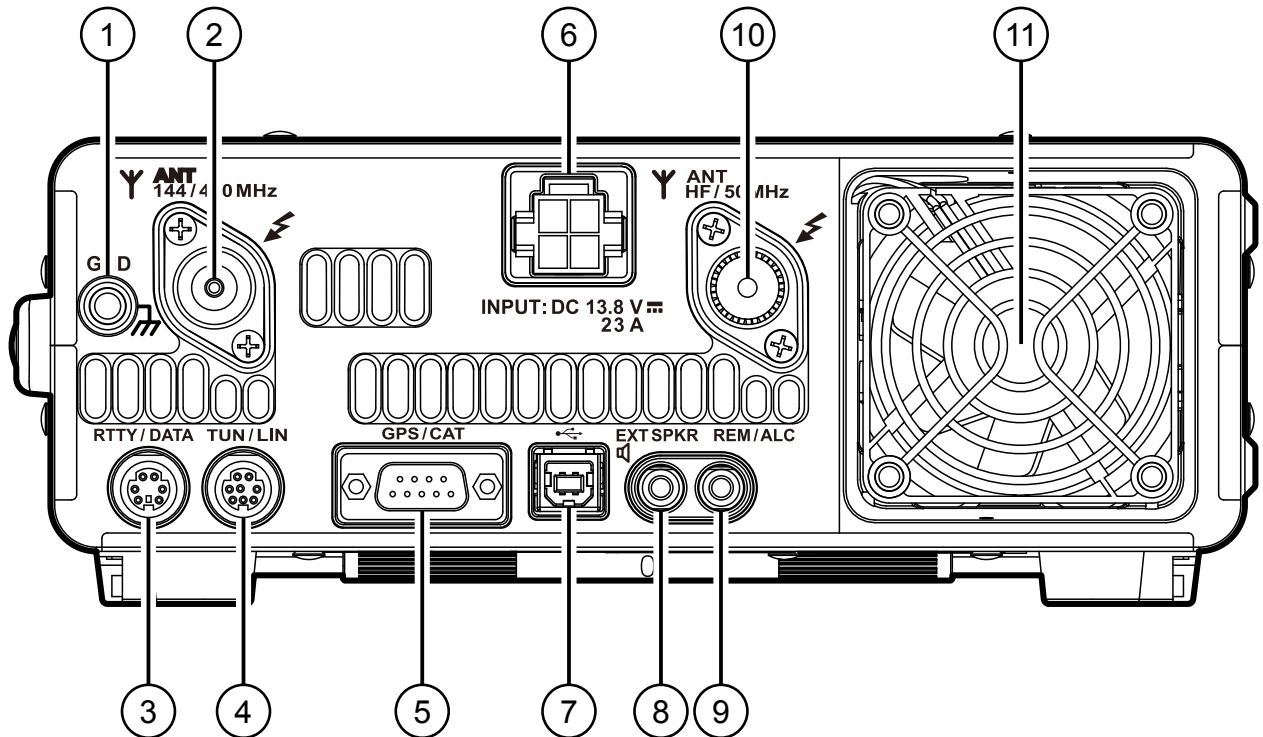

① GND

Use this terminal to connect the transceiver to a good earth ground, for safety and optimum performance. Use a large diameter, short braided cable to make the ground connections. For details on grounding the transceiver, see “Grounding” on page 12.

② ANT Jack (144/430MHz)

This is the M-type coaxial connector for the 144 MHz band and 430 MHz band antennas (50 ohms).

③ RTTY/DATA Jack

This is the input/output jack to connect a terminal unit for RTTY and TNC for packet communications.

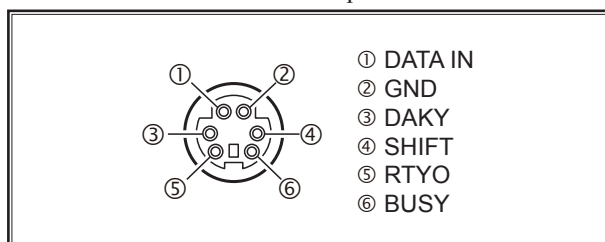

④ TUN/LIN Jack

Connect the optional external antenna tuner “FC-40” or the linear amplifier “VL-1000”.

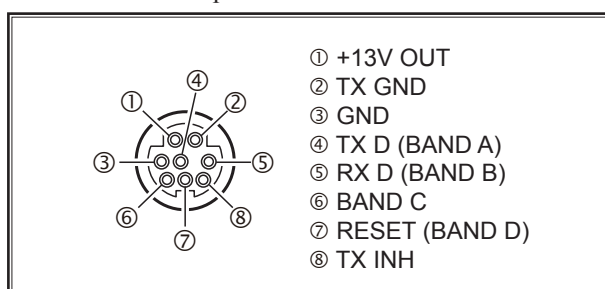

⑤ GPS/CAT Jack

This is the **RS-232C** jack for connecting a computer or a commercially available external GPS device. This is the **RS-232C** jack for connecting a computer. Connecting a computer to this jack, using a commercially available **RS-232C** straight cable, enables CAT control of the transceiver.

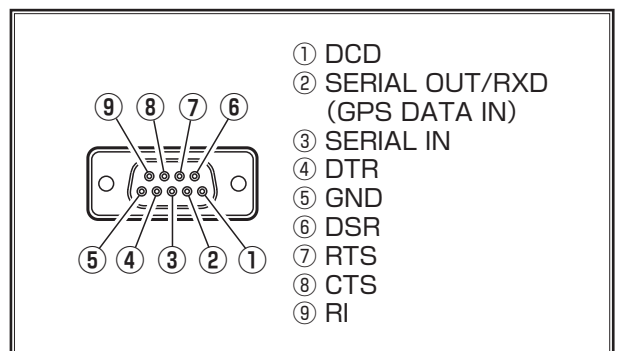

⑥ DC IN Jack

This is the DC power supply connection for the transceiver. Use the supplied DC cable to connect directly to a DC power supply, which must be capable of supplying at least 23 A @13.8 VDC.

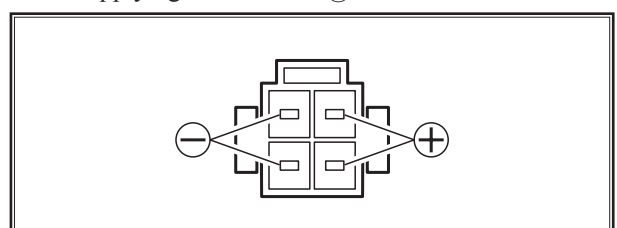

⑦ USB Jack

Connect a computer with a commercially available USB cable to control the transceiver remotely from the computer using the CAT command.

Inputting/Outputting audio signals and transmission control can also be done from the computer.

NOTE:

- ❑ To control the transceiver remotely from the computer, a USB driver is required. For details on the USB driver, visit the Yaesu WDXC website.
- ❑ When using a USB cable connected to a computer, the transceiver may change to the transmit mode when the computer is started.

⑧ EXT SPKR Jack

This is the monaural jack to connect an external speaker (4 Ω to 8 Ω).

Connecting an external speaker to this jack will deactivate the internal speaker.

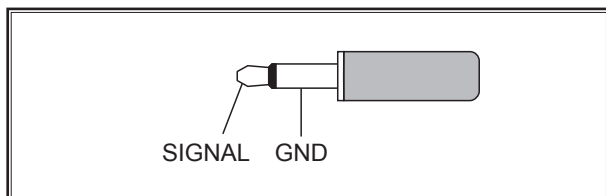

⑨ REM/ALC Jack

Connect the optional remote control keypad “FH-2”. When a device such as a linear amplifier is connected, this is an external ALC current input jack.

⑩ ANT Jack (HF/50MHz)

This is the M-type coaxial connector to connect HF band and 50 MHz band antennas (50 ohms).

⑪ Cooling fan

MH-31A8J MICROPHONE SWITCHES

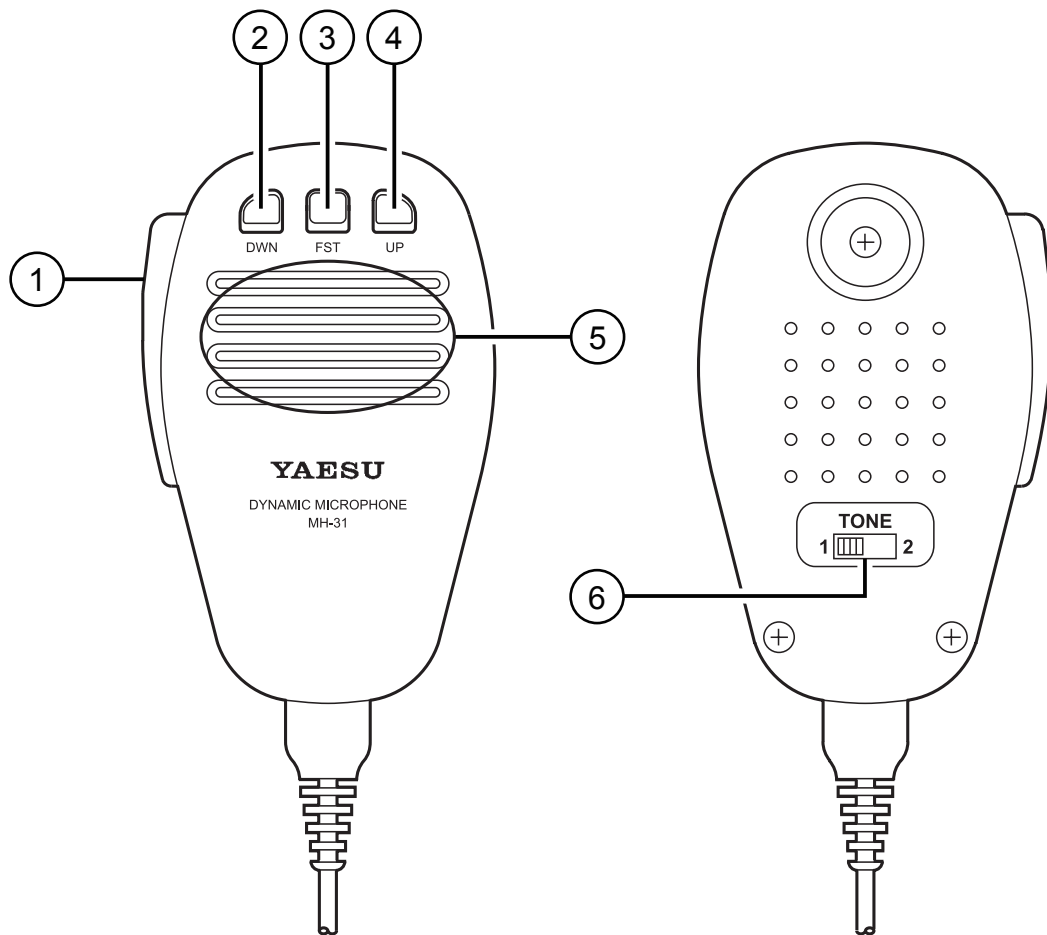

① PTT Switch

Switches transmission/reception.
Press to transmit and release to receive.

② DWN Button

Press the **DWN** (Down) button to scan the frequency downward.

③ FST Button

Allows switching the frequency variation (step), working in the same way as the **FAST** button on the transceiver front panel.

④ UP Button

Press the **UP** button to scan the frequency upward.

⑤ Microphone

Speak into the microphone in a normal tone of voice with the microphone 5 cm away from the mouth.

⑥ TONE Switch

Switches transmission sound quality.
Slide to the “1” side to make the transmit audio flat.
Slide to the “2” side to emphasize transmit audio.

OPTIONAL FH-2 REMOTE CONTROL SWITCHES

With the optional remote control keypad **FH-2**, you can record and transmit your voice (Voice Memory) and control the Contest Memory Keyer during CW operation.

- On SSB/AM/FM modes, five channels of storage and playback of voice memory (20 seconds each), using your own voice for recording (see page 68).
- For the CW Memory Keyer, 5 channels are available for each of the MESSAGE Memory and the TEXT Memory (see page 84).

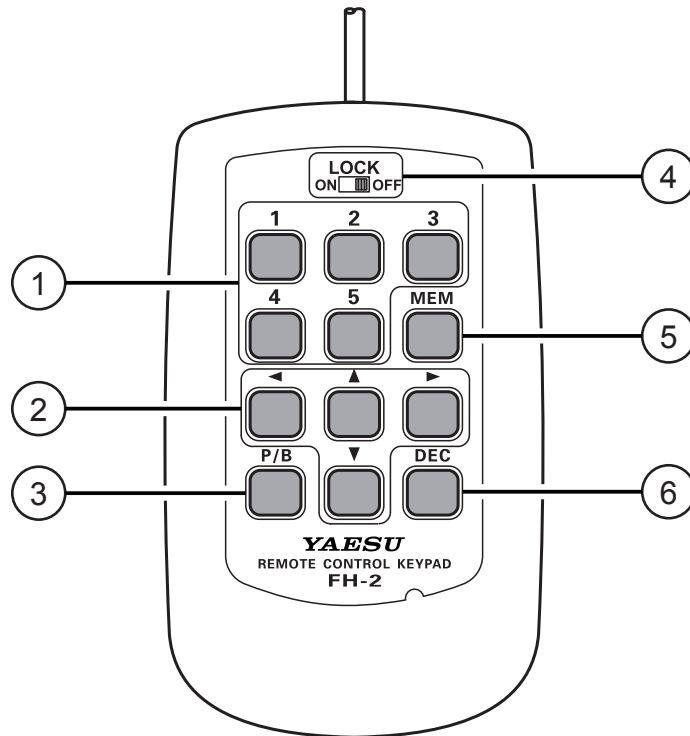

① Voice Memory: 5 Memory Channels for the Memory Keyer

In the case of Voice Memory, up to 20 seconds of audio may be stored on each channel.

“MESSAGE Memory” and “TEXT Memory” are available for the Contest Memory Keyer.

Each “MESSAGE Memory” channel is capable of retaining a 50-character CW message using the PARIS standard for characters and word length.

Each “TEXT Memory” channel is capable of retaining a maximum of 50 characters.

② Cursor Buttons

When programming the Contest Memory Keyer, these buttons are used to move the cursor and select the text characters.

The cursor may be moved in 4 different directions (up/down/right/left).

Usually, these buttons are used for tuning the VFO frequency. Press the [▲]/[▼] buttons to change the frequency in the same increments as the microphone [UP]/[DWN] switches. Press the [◀]/[▶] buttons to change the frequency by 100 kHz steps.

③ [P/B] Button

When entering text, a space may be inserted where the cursor is flashing.

④ [LOCK] Button

The **FH-2** key buttons may be locked by setting this switch to “ON”.

⑤ [MEM] Button

Press this button to store either a Voice Memory, or a Contest Keyer Memory.

⑥ [DEC] Button

When utilizing the sequential contest number capability of the Contest Keyer, press this button to decrement (decrease) the current Contest Number by one digit (i.e. to back up from #198 to #197, etc.).

OPTIONAL MH-36E8J MICROPHONE SWITCHES

The optional **MH-36E8J** is a handheld microphone equipped with the DTMF function that enables DTMF (Dual Tone Multi Frequencies) transmission.

A lamp switch illuminates the DTMF keypad for easy viewing in the dark.

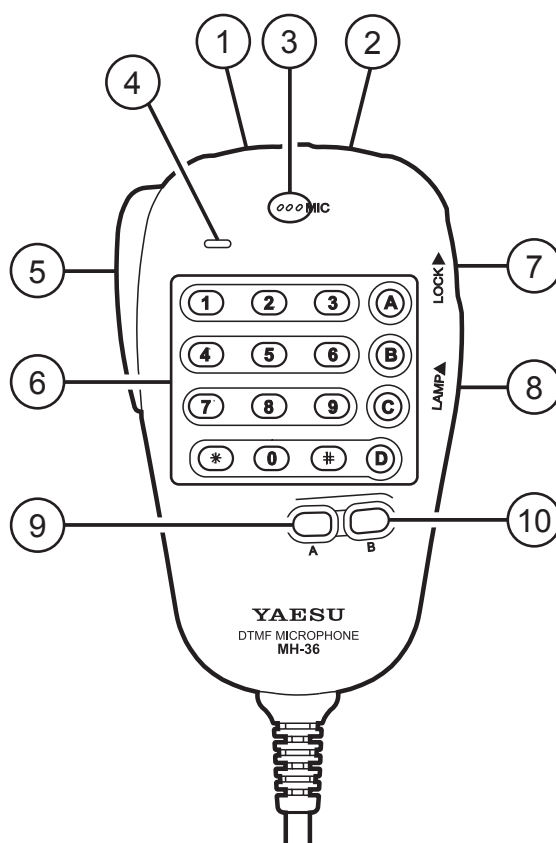

- ① **DWN Button**
Press to tune down, hold to start scanning.
- ② **UP Button**
Press to tune up, hold to start scanning.
- ③ **Microphone Element**
Speak across the face of the mic from about two inches away.
- ④ **DTMF Indicator**
When the DTMF is transmitted, this indicator glows red.
- ⑤ **PTT Switch**
Press and hold to transmit.
- ⑥ **DTMF Keypad**
Press a key button while holding the **PTT** switch to transmit a DTMF tone.
- ⑦ **LOCK Switch**
Slide upward to lock the microphone controls and buttons.
- ⑧ **LAMP Switch**
Slide upward to illuminate the keypad.
- ⑨ **A Button**
This activates an accessory function.
Activates the “first” mode when used with the **FT-991**.
- ⑩ **B Button**
This activates a second accessory function.
This button has no function when used with the **FT-991**.

BASIC OPERATION: RECEIVING ON AMATEUR BANDS

Before turning on the main power, please verify the following items once more.

- Have you made all ground connections securely? See page 12 for details.
- Do you have your antenna(s) connected to the rear-panel Antenna jack(s)? See page 13 for details.
- Is your microphone (and/or key or paddle) connected? See pages 14, 15 for details.
- If using a linear amplifier, have all interconnections been successfully completed? See pages 16 for details.
- Please rotate the **AF GAIN** control to the fully counter-clockwise position, to avoid a loud blast of audio when the transceiver turns on. See page 21 for details.

BASIC OPERATION: RECEIVING ON AMATEUR BANDS

Here is the typical start-up procedure for normal operation:

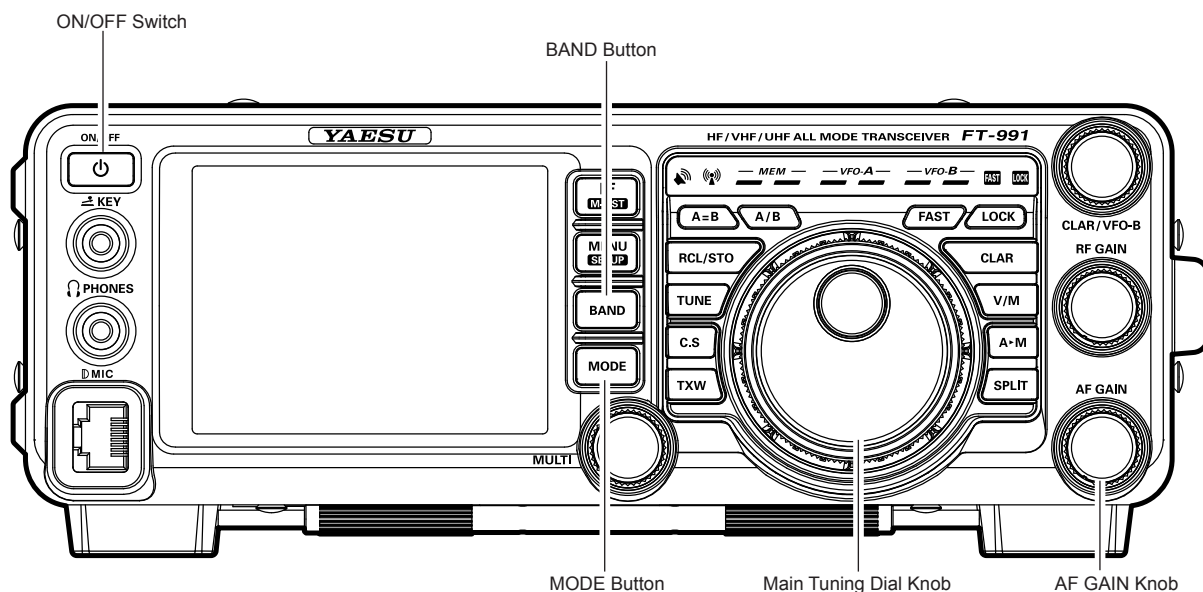

1. Turn on the external DC power supply.
2. Press and hold in the front-panel **ON/OFF** switch until the transceiver turns on.
3. The transceiver will start up on 7.000.00 MHz LSB, (or the previously used operating frequency) and normal operation may begin.

NOTE:

To turn power off, press and hold in the front panel **ON/OFF** switch for one second.

4. Rotate the **AF GAIN** knob to set a comfortable audio level of the incoming signals or noise. Clockwise rotation of the **AF GAIN** knob increases the volume level.

NOTE:

When using headphones, start by rotating the **AF GAIN** knob counter-clockwise, then bring the volume level up after you put the headphones on. This will minimize the chance of damage to your hearing caused by an unexpectedly high audio level.

5. Press the **BAND** button to display the list of Amateur bands on the LCD, then touch a key corresponding to the band on which you wish to begin operation.

ADVICE:

- One-touch selection of each Amateur band between 1.8 and 50 MHz, 144 MHz, and 430 MHz is provided.
- The **FT-991** utilizes a triple band-stack VFO selection technique, which permits storing up to three favorite frequencies and modes onto each VFO band register. For example, you may store one frequency each on 14 MHz CW, RTTY, and USB, then recall these frequencies by successive, momentary touches of the [14] on the screen displayed by pressing the **BAND** button. Each Amateur band key may similarly have up to three frequency/mode settings applied.

6. Press the **MODE** button to display the available selections.

Touch the corresponding key to select the desired operating mode.

ADVICE:

- By convention in the Amateur bands, LSB is used on the 7 MHz and lower bands (with the exception of 60 meters), while USB is utilized on the 14 MHz and higher bands.
- When changing modes from SSB to CW, you will observe a frequency shift on the display. This shift represents the BFO offset between the “zero beat” frequency and the audible CW pitch (tone) you can hear (the pitch is programmed via the Menu item “059 CW FREQ DISPLAY”), even though the actual tone that you hear is not changing.
- To eliminate noise while the transceiver is not receiving any signal, press the **F(M-LIST)** button, then touch [SQL] on the LCD. “SQL” will appear on the LCD and the **MULTI** knob will function as the squelch knob. Rotate the **MULTI** knob to adjust the squelch until the noise disappears.

BASIC OPERATION: RECEIVING ON AMATEUR BANDS

7. Rotate the Main Tuning Dial knob to tune around the band, and begin normal operation.

ADVICE:

- Clockwise rotation of the Main Tuning Dial knob increases the operating frequency, one “step” of the synthesizer at a time; similarly, counter-clockwise rotation of the Main Tuning Dial knob will decrease the frequency. Two settings, one “normal” and one “fast”, are available for each operating mode. Pressing the **FAST** button engages the “Fast” tuning selection (see chart below).

MAIN TUNING DIAL KNOB TUNING RATE

OPERATING MODE	1 STEP	1 DIAL ROTATION
LSB/USB/CW/RTTY/ DATA-LSB/DATA- USB/AM	5 Hz (100 Hz) 10 Hz (100 Hz)	1 kHz (20 kHz) 2 kHz (20 kHz)
FM/DATA-FM/C4FM	100 Hz (1 kHz)	20 kHz (200 kHz)

Numbers in parentheses indicate steps when the **FAST** button is On.

- If you want to make rapid frequency changes, there are several techniques available:
 - Direct keyboard entry of the frequency.
 - Use the microphone **UP/DWN** scanning keys, if your microphone is so equipped.

BASIC OPERATION: RECEIVING ON AMATEUR BANDS

OPERATION ON 60-METER (5 MHz) BAND (U.S. AND U.K. VERSION ONLY)

The recently-released 60-meter band is covered, in the **FT-991**, by fixed memory channels. These channels are set to USB or CW, and they appear between the “last” PMS channel (“P9U”) and the first “regular” memory channel (Channel 1):

1. Press the **V/M** button once to enter the “Memory” mode; the “**MEM**” icon will appear in the display.
2. Touch **[MCH]** on the screen displayed by pressing the **F(M-LIST)** button. The “**MCH**” notation and a memory channel number will appear on the display to signify that rotation of the **MULTI** knob will allow selection of the memory channel.

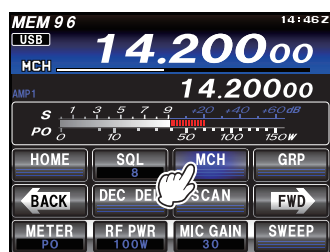

3. Memory channels (“5-01” through “5-10”) are pre-programmed, at the factory, with the permitted frequencies in the 5 MHz band, and the USB or CW mode is automatically selected on these channels.
4. To exit from 60-meter operation and return to the VFO mode, just press the **V/M** button.

NOTE:

The frequencies and operating mode for 5 MHz band operation are fixed, and may not be changed.

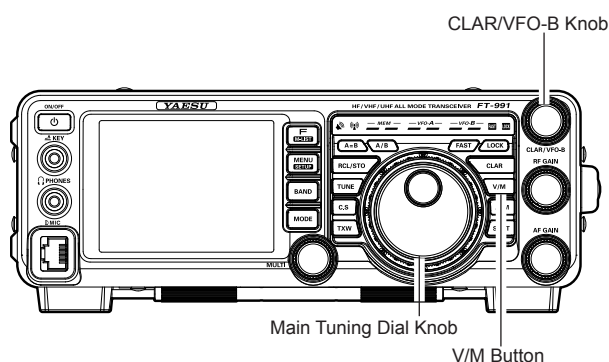

CHANNEL NUMBER	FREQUENCY
5-01	5.332000 MHz
5-02	5.348000 MHz
5-03	5.358500 MHz
5-04	5.373000 MHz
5-05	5.405000 MHz
5-06	5.332000 MHz
5-07	5.348000 MHz
5-08	5.358500 MHz
5-09	5.373000 MHz
5-10	5.405000 MHz

BASIC OPERATION: RECEIVING ON AMATEUR BANDS

CLAR (CLARIFIER) OPERATION

The **CLAR** button and **CLAR/VFO-B** knob are used to offset the receive frequency, the transmit frequency, or both, from their settings on the VFO-A frequency. Four small numbers on the TFT Display show the current Clarifier offset. The Clarifier controls on the **FT-991** are designed to allow setting a preset offset (up to ± 9.99 kHz) without actually re-tuning, and then to activate it via the Clarifier **CLAR** button. This feature is ideal for following a drifting station, or for setting the small frequency offsets sometimes utilized in DX “Split” work.

Here is the technique for utilizing the Clarifier:

1. Press the **CLAR** button. The “**RX**” notation will appear in the TFT Display, and the programmed offset will be applied to the receive frequency.
2. Rotation of the **CLAR/VFO-B** knob will allow you to modify your initial offset on the fly. Offsets of up to ± 9.99 kHz may be set using the Clarifier.

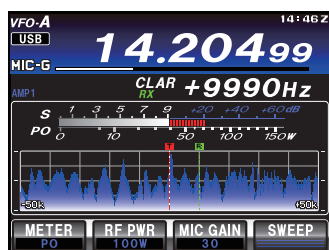
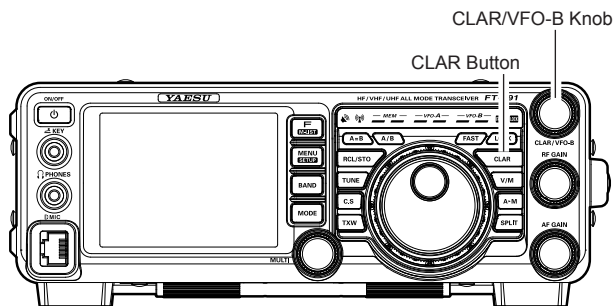

To cancel Clarifier operation, press the **CLAR** button. The “**RX**” notation will disappear from the display.

ADVICE:

Turning the Clarifier off merely cancels the application of the programmed offset from the receive and/or the transmit frequencies. To clear the Clarifier offset, and reset it to “zero,” press and hold the **CLAR** button. The programmed offset is displayed in the small multi-channel window of the frequency display.

BASIC OPERATION: RECEIVING ON AMATEUR BANDS

LOCK

You may lock the setting of the Main Tuning Dial knob (for VFO-A frequency tuning) to prevent accidental frequency change.

Main Tuning Dial Knob Lock

To lock the Main Tuning Dial knob, press the **LOCK** button that is located to the right of the Main Tuning Dial knob.

☐ “Lock” in the LED indicator area will light up

To unlock the Dial setting, and restore normal tuning, press the **LOCK** button once more.

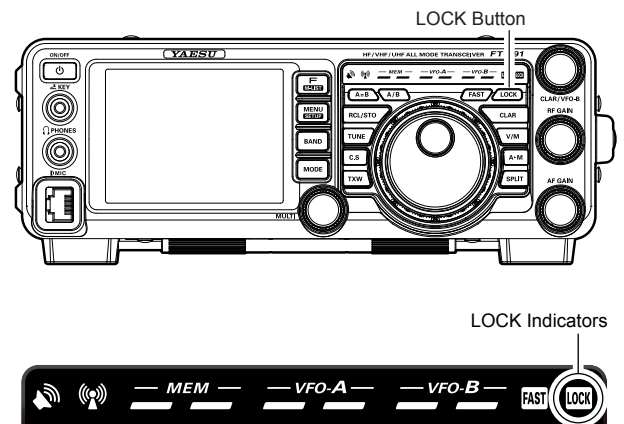

DIMMER

The illumination level of the TFT display and LED indicators (above the Main Tuning Dial knob), may be adjusted via Menu items 007 and 008.

To adjust the illumination level:

1. Press the **MENU** button to enter the Menu mode.
2. Rotate the **MULTI** knob to select Menu item “007 DIMMER LED” (for LED indicators) or “008 DIMMER TFT” (for TFT display).
3. Touch [**SELECT**] on the LCD then rotate the **MULTI** knob to select the desired illumination level.

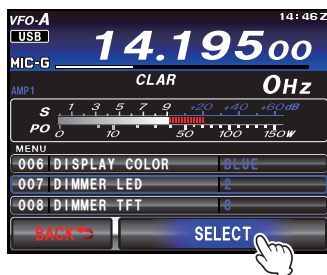
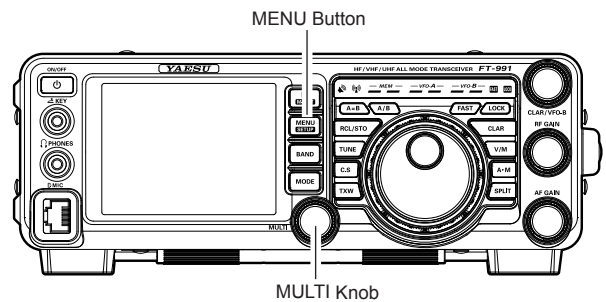

4. Touch [**ENTER**] on the LCD, then touch [**BACK**] on the LCD or press the **MENU** button to save the new setting and exit to normal operation.

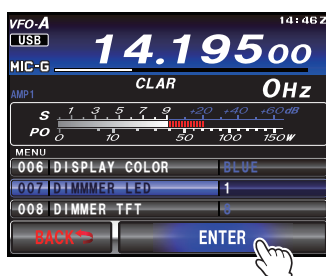

BASIC OPERATION: RECEIVING ON AMATEUR BANDS

VFO COLOR

The background color of the VFO-A frequency in the TFT display may be selected via Menu item 006.

1. Press the **MENU** button to enter the Menu mode.
2. Rotate the **MULTI** knob to select Menu item “006 DISPLAY COLOR”.
3. Touch **[SELECT]** on the LCD, then rotate the **MULTI** knob to select from the following colors:
BLUE (default) / GRAY / GREEN / ORANGE / PURPLE / RED / SKY BLUE



4. Touch **[ENTER]** on the LCD, then touch **[BACK]** on the LCD or press the **MENU** button to save the new setting and exit to normal operation.

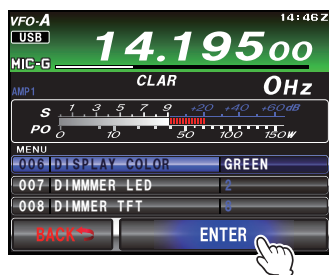

Background color

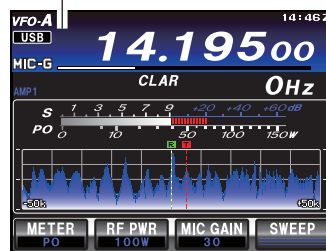

MENU Button

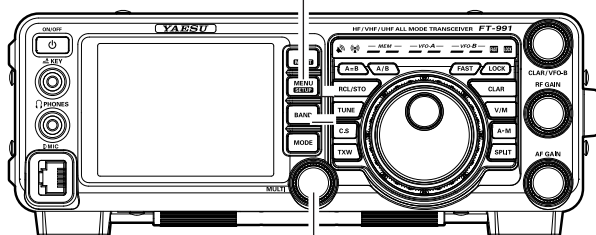

MULTI Knob

BAND STACK OPERATION

The **FT-991** utilizes a triple band-stack VFO selection technique that permits storing of up to three favorite frequencies and modes onto each band VFO register. For example, one frequency each on 14 MHz CW, RTTY, and USB may be stored and then recalled by successive, momentary touches of [14] on the screen displayed by the **BAND** button. Each Amateur band key may similarly have up to three frequency/mode settings applied. Note that only the VFO-A system has the band stacks.

A typical setup, for the 14 MHz band, might be arranged like this:

1. Program 14.025 MHz, CW Mode, then press the **BAND** button, and then touch [14] on the LCD.
2. Program 14.080 MHz, RTTY Mode, then press the **BAND** button, and then touch [14] on the LCD.
3. Program 14.195 MHz, SSB Mode, then press the **BAND** button, and then touch [14] on the LCD.

With this configuration, successive momentary touches of [14] on the screen displayed when the **BAND** button is pressed will allow you to step sequentially through these three VFOs.

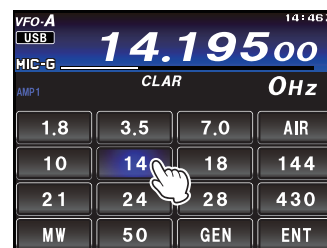
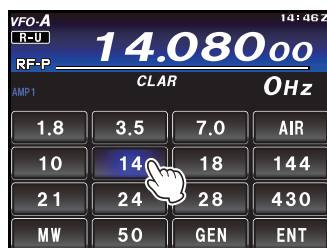
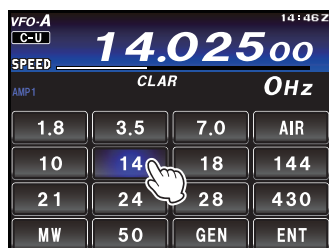
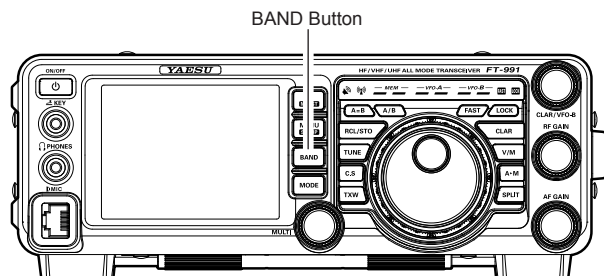

C.S (CUSTOM SWITCH)

The front panel **C.S** button may be programmed to directly access an often-used Menu Mode selection.

C.S Setup

1. Press the **MENU** button to engage the Menu mode; the Menu list will appear on the display.
2. Rotate the **MULTI** knob to select the Menu item you want to access with the front panel **C.S** button.
3. Press the **C.S** button to lock in your selection.
4. Press the **MENU** button or touch [BACK] on the LCD to save the new configuration and exit to normal operation.

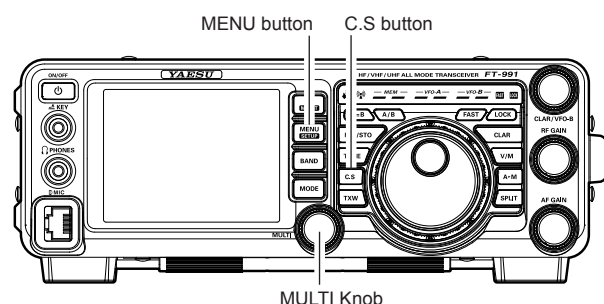

Menu Selection Recall via C.S button

Press the **C.S** button.

The programmed Menu item will appear on the display. Press the **MENU** button or touch [BACK] on the LCD exit to normal operation.

CONVENIENCE FEATURES

AMS (AUTOMATIC MODE SELECT) OPERATION

The transceiver has the AMS (Automatic Mode Select) function which enables the transceiver to automatically select the most appropriate option out of the three communication modes according to the received signal while operating in C4FM mode.

Besides C4FM digital signals, analog signals (FM) are also identified in order to automatically match the communication mode of the partner station.

NOTE:

The AMS function recognizes the three modes listed in the following table. Other communication modes cannot be recognized.

OPERATING MODE	DISPLAY	EXPLANATION OF MODES
V/D mode (simultaneous voice and data communication mode)	DN When AMS is "ON": Red When AMS is "OFF": Light blue	As the audio signal error is detected and repaired at the same time as the transmission of the digital audio signal, it becomes more difficult for conversations to be cut off. A basic digital mode of C4FM FDMA.
Voice FR mode (Voice full-rate mode)	VW When AMS is "ON": Red When AMS is "OFF": Light blue	Digital voice data is transmitted using the entire 12.5 kHz bandwidth. High quality voice communication is possible.
Analog FM mode	AN Only when AMS is "ON": Lights red	Analog communication mode using the FM mode. This mode is effective for communication when the signal strength is so weak that the voice is cut off midway in the digital mode.

1. Press the **MODE** button, and then touch the corresponding key on the LCD to select the C4FM operating mode. The "C4FM" icon appears in the display. Press the **MODE** button once more.

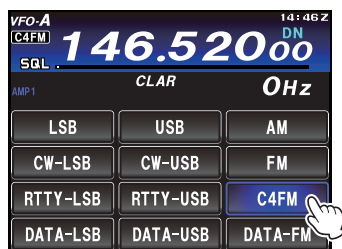

2. Touch **[AMS]** on the LCD. The AMS function will be switched to "ON" and the communication mode will be switched to match the received signal.

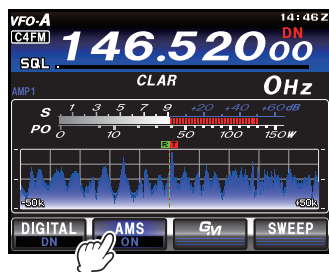

MODE Button

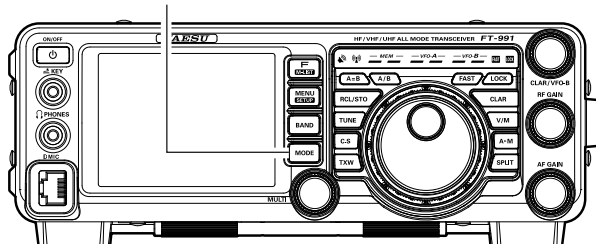

NOTE:

In the V/D mode ("DN" displayed), the position information is included in the transmitted signal during the conversation, but in the Voice FR mode ("VW" displayed), the position information is not included.

AMS (AUTOMATIC MODE SELECT) OPERATION

Setting the Operation of the AMS Function

Using the AM function switches the communication mode to match the received signal but you can alternatively select and lock the transmission mode.

1. Press the **MENU(SETUP)** button to enter the Menu mode.
2. Rotate the **MULTI** knob to select Menu item “092 AMS TX MODE”.
3. Touch [SELECT] on the LCD, rotate the **MULTI** knob to select the desired operation (see the following table).

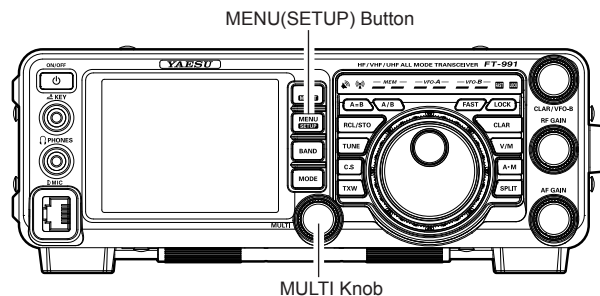
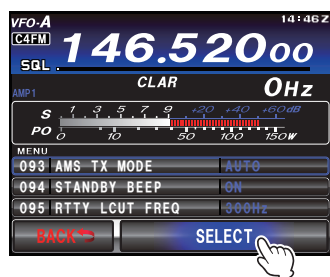

4. Touch [ENTER] on the LCD to save the new setting.

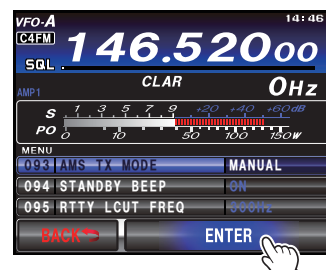

5. Press the **MENU(SETUP)** button or touch [BACK] on the LCD to exit to normal operation.

AVAILABLE SETTINGS	EXPLANATION OF FUNCTION	
AUTO	TX/RX	The operating mode is automatically selected from the three communication modes to match the received signal.
MANUAL	TX/RX	The operating mode is automatically selected from three communication modes to match the received signal. Pressing the Microphone PTT switch momentarily, toggles between the Digital (C4FM) and Analog (FM) communication modes.
DN	RX	The RX mode is automatically selected from the three communication modes to match the received signal.
	TX	The TX mode is automatically changed to the “DN” mode.
VW	RX	The RX mode is automatically selected from the three communication modes to match the received signal.
	TX	The TX mode is automatically changed to the “VW” mode.
ANALOG	RX	The RX mode is automatically selected from the three communication modes to match the received signal.
	TX	The TX mode is automatically changed to the “FM” mode.

Toggling to the Digital Communication Mode

Without using the AMS function, you can select and lock the digital communication mode (DN or VW).

1. Touch [AMS] on the screen to set the AMS function to “OFF”.
2. Touching [DIGITAL] on the screen switches the digital communication mode between the following modes.

DN (V/D Mode): As the audio signal error is detected and repaired at the same time as the transmission of the digital audio signal, it becomes more difficult for conversations to be cut off. A basic digital mode of C4FM FDMA.

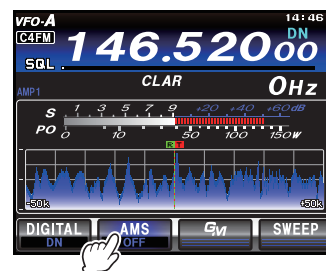

VW (FR Mode): Digital voice data is transmitted using the entire 12.5 kHz bandwidth. High quality voice communication is possible.

CONVENIENCE FEATURES

SCOPE

The SCOPE function provides a spectrum display of the band conditions. Both strong and weak signals can be clearly displayed on the TFT screen. In the MANUAL mode, the scope frequency spectrum is scanned one time and displayed. In the “Continuous Sweeping mode”, the scope spectrum is repeatedly swept and displayed. When operating in the “ASC (Automatic Spectrum-Scope Control) mode” the sweep is automatically carried out in conjunction with the movement and operation of the main dial. The scope sweep and span may be optimized according to your preferences and purposes.

Note: Since the **FT-991** has only one receiver the audio will be muted while the spectrum scope is scanning.

Touch [**SWEEP**] on the LCD to display the band conditions (spectrum).

- ❑ The transceiver is equipped with three types of sweeping mode: “MANUAL mode”, “Continuous sweeping mode” and “ASC (Automatic Spectrum-Scope Control) mode”. Refer to the advice below to select the optimal mode according to your preferences and purposes.

ADVICE:

- ❑ Width of scope display may be set in Menu item “120 SCP SPAN FREQ”.
- ❑ The sweeping interval may be set in Menu item “118 SCP START CYCLE”.
- ❑ “Spectrum display mode” or “Waterfall display mode” may be selected in Menu item “117 SCP DISPLAY MODE”.

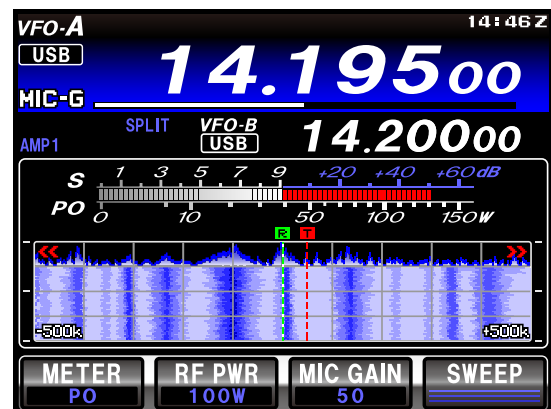
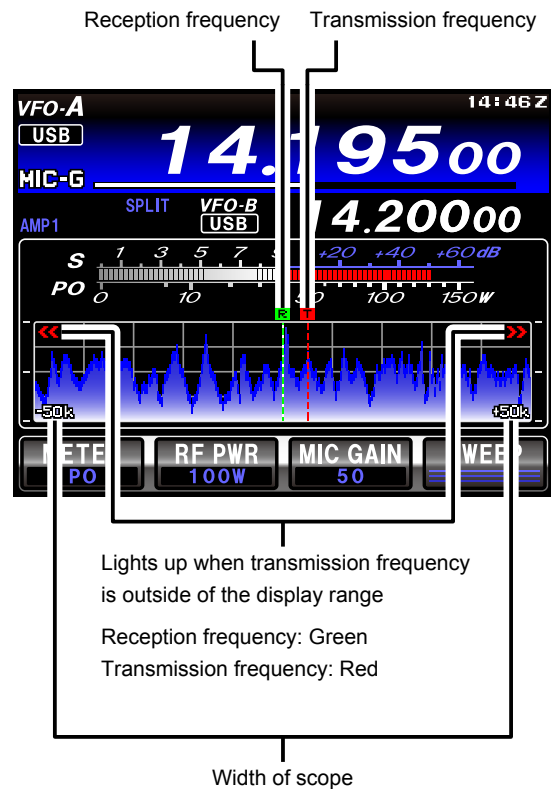

Example of waterfall display

SCOPE

Sweep Mode

Three sweep modes are available for the scope function as described below.

MANUAL Mode

Touch [SWEEP] on the LCD to sweep across the band one time, and display band conditions.

Continuous Sweeping Mode

Touch and hold [SWEEP] on the LCD to mute the receiver begin the continuous sweep operation. The spectrum scope will start sweeping the band segment continuously. While rotating the main dial, you can continuously monitor the band condition.

To stop sweeping, touch [SWEEP] on the LCD again.

ASC (Automatic Spectrum-Scope Control) Mode

Quickly rotate the main dial to mute the reception sound. The spectrum scope will automatically start sweeping and continue sweeping until you completely stop rotating the main dial. While observing the display, move the dial close to the desired frequency. Stop turning the main dial to stop the spectrum scope completely, and then you can hear the received signal. Now you may slowly rotate the main dial to tune in the received signal while listening to the receiver audio and the sweeping is disabled.

- You can change the rotation speed of the main dial to switch to sweeping motion in the Menu item “119 ASC DIAL SPEED”.

CONVENIENCE FEATURES

MORE FREQUENCY NAVIGATION TECHNIQUES

Keyboard Frequency Entry

The Operating frequency may be entered directly into the current VFO, using the display screen keyboard by pressing the front panel **BAND** button.

Example: Enter 14.250.00 MHz

1. Press the **BAND** button to begin the direct frequency entry process.
2. Touch **[ENT]** on the LCD. The first digit of the frequency (the leftmost digit) will blink.
3. Enter, in order, the digits of the operating frequency, touching the keys on the LCD

The decimal point after the “MHz” portion of the frequency must be entered, but no decimal point is required after the “kHz” portion.

4. Touch **[ENT]** on the LCD once more to complete the operating frequency entry. A short “beep” will confirm that the entry was successful, and the new operating frequency will appear on the display.



ADVICE:

If you attempt to enter a frequency outside the operating range of 30 kHz - 56 MHz, the microprocessor will ignore the attempt, and will return to the previous operating frequency. If this happens, please try again, taking care not to repeat the error in the frequency entry process.

Setting with the MULTI Knob

Rotate the **MULTI** knob to set the frequency in the pre-programmed frequency steps. The frequency step can be changed.

1. Press the **F(M-LIST)** button to display the function menu list. Touch the **[CH DIAL]** icon to activate this function and cause the **MULTI** knob to function as the frequency adjustment knob.

CH-D (CH DIAL) indicator

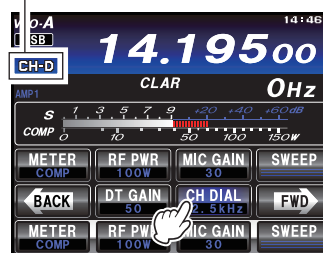

2. Touch **[CH DIAL]** to select the desired frequency step. Touching **[CH DIAL]** switches the frequency as follows.

OPERATING MODE	FREQUENCY STEP
AM	2.5 → 5 → 9 → 10 → 12.5 → 25 → 2.5 → ...
SSB/CW/RTTY/ DATA-LSB/DATA-USB	1 → 2.5 → 5 → 1 → ...
FM/C4FM/ DATA-FM	5 → 6.25 → 10 → 12.5 → 15 → 20 → 25 → 5 → ...

3. Rotate the **MULTI** knob to change the frequency in the selected frequency steps.

MORE FREQUENCY NAVIGATION TECHNIQUES

Using the UP/DWN Buttons of the Supplied MH-31A8J Hand Microphone

The **UP/DWN** buttons on the supplied **MH-31A8J** Hand Microphone may also be used to manually scan the frequency upward or downward.

In modes other than AM/FM, the frequency changes by the same step as the main dial.

When the microphone **FST** button is pressed, the tuning rate increases by a factor of ten, in a manner similar to the transceiver front panel **FAST** button.

The frequency change amount (step size) differs depending on the preset modulation form and FST button condition.

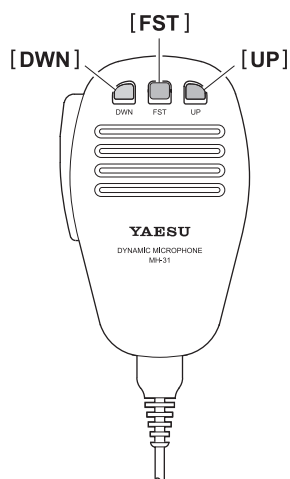

OPERATING MODE	UP	DWN	FST + UP	FST + DWN
CW/RTTY/ DATA-LSB/ DATA-USB	+5 Hz	-5 Hz	+100 Hz	-100 Hz
LSB/USB/AM	+10 Hz	-10 Hz	+100 Hz	-100 Hz
FM/C4FM/ DATA-FM	+5 kHz	-5 kHz	+50 kHz	-50 kHz

CONVENIENCE FEATURES

RECEIVER OPERATION (FRONT END BLOCK DIAGRAM)

The **FT-991** includes a wide range of special features to suppress the many types of interference that may be encountered on the HF bands. However, real world interference conditions are constantly changing, so optimum setting of the controls is somewhat of an art, requiring familiarity with the types of interference and the subtle effects of some of the controls. Therefore, the following information is provided as a general guideline for typical situations, and a starting point for your own experimentation.

The **FT-991** interference-fighting circuitry begins in its “RF” stages, and continues throughout the entire receiver section. **FT-991** allows configuration of the features described below.

CONTOUR Filter

The DSP Contour filter has the unique ability to provide either a null or a peak in tunable segments of the receiver passband. You may suppress interference and excessive frequency components of an incoming signal, or you may peak those tunable frequency segments. The level of the null or peak, and the bandwidth, over which it is applied, are adjustable via the Menu.

IF SHIFT

The passband center frequency of the IF DSP filter may be moved up or down by adjusting this control.

IF WIDTH

The width of the IF DSP filtering may be adjusted using this control.

IF NOTCH

The IF Notch filter is a high-Q notch filter that can eliminate, or significantly reduce an interfering carrier.

DNF (Digital Notch filter)

When multiple interfering carriers are encountered during reception, the Digital Notch Filter can significantly reduce the level of these signals.

DNR (Digital Noise Reduction)

The DSP’s Digital Noise Reduction (DNR) feature utilizes 15 different mathematical algorithms to analyze and suppress different noise profiles encountered on the HF/50 MHz bands. Choose the selection that provides the best noise suppression, and allows the signal to rise up out of the noise.

AGC

The AGC system automatically adapts to changing signal and fading characteristics, making reception possible under the most difficult conditions.

The **FT-991** uses the 15 kHz roofing filter on AM/FM/C4FM modes. All the other modes use the 3 KHz filter automatically. There is no manual selection possible.

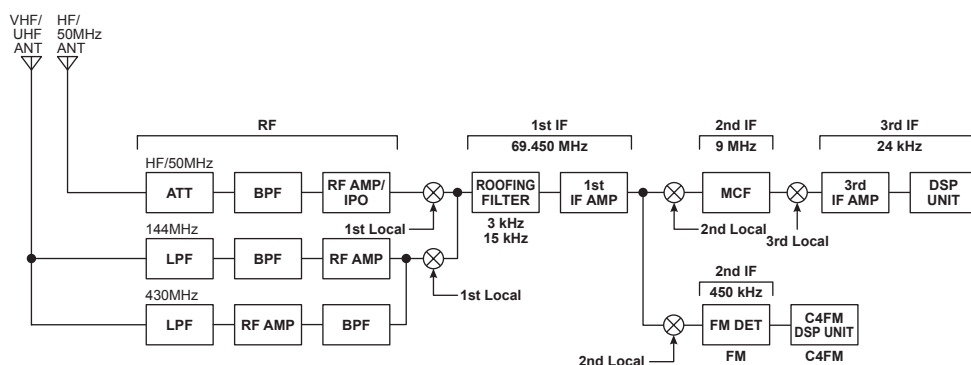

FRONT END BLOCK DIAGRAM

ATT (ATTENUATOR)

When the desired signal is extremely strong or the noise level is high on a low frequency band, activate the attenuator to reduce the incoming signal from the antenna.

1. Press the **F(M-LIST)** button, then touch [ATT] on the LCD. The “ATT” indicator will appear in the DSP display.

ADVICE:

- The incoming signal level is reduced by 12dB (Signal voltage is reduced to 1/4 compared to OFF).

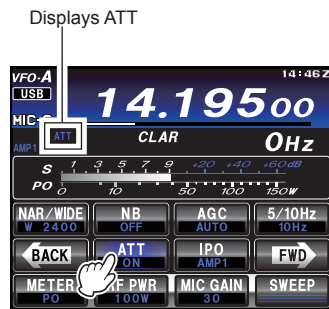
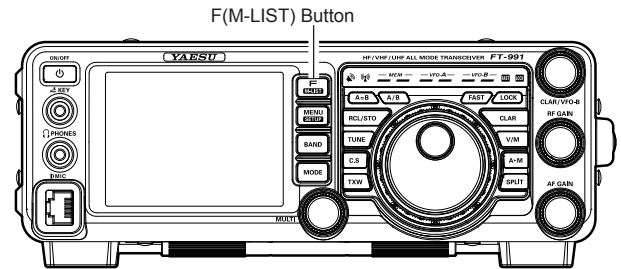

2. To restore full signal strength through the Attenuator circuit, touch [ATT] on the LCD to return the ATT display to the “OFF” position.

ADVICE:

If the noise level is high or the received signal is extremely strong, the incoming signal level can be suppressed with the IPO/ATT settings.

If the S-meter fluctuates S-3 or more in the noise level, or the received signal is extremely strong and it causes a high S-meter indication (+20dB or more), activate the attenuator.

Since IPO does not only attenuate the incoming signal, but also improves the cross modulation characteristic, try to activate the IPO first. If the signal is still strong, also use the ATT. In this way, you can attenuate the incoming signal and noise effectively.

INTERFERENCE REJECTION

IPO (INTERCEPT POINT OPTIMIZATION)

The IPO feature allows the operator to optimize the characteristics of the receiver front end, contingent on the current noise level and the strength of incoming signals.

Press the **F(M-LIST)** button to display the function menu list. Touch the **[IPO]** function repeatedly, to set the desired characteristic of the receiver front end, according to the chart below.

- AMP1:** Amplifies the incoming signals, using a low distortion RF preamplifier (gain: approx. 10 dB).
- AMP2:** Amplifies the incoming signals, using a 2-stage low-distortion RF preamplifier (total gain: approx. 20 dB).
- IPO:** Bypasses the RF preamplifier, yielding direct feed to the first mixer.

NOTE:

AMP1 does not function below the 1.8 MHz frequency range.

The selected receiver RF preamplifier will be indicated in the IPO column of the Key Function Display on the TFT screen.

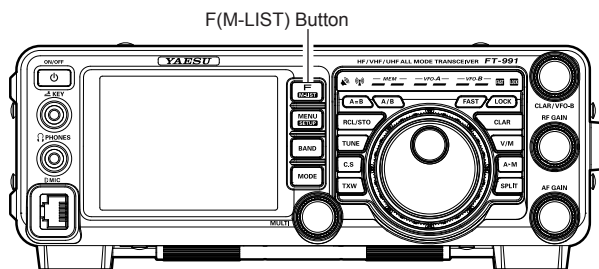

Displays IPO

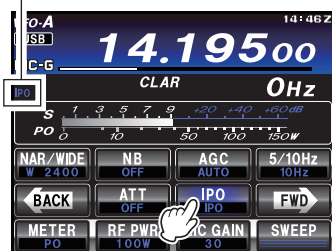

ADVICE:

- On the 10 MHz and lower bands, it is generally not necessary to use any preamplifier at all; selecting the "IPO" position as described above will increase the strong-signal-handling capability of the receiver, and generally result in more pleasant reception due to the reduced ambient noise level. If you can hear band noise with the preamplifiers disengaged, then a preamplifier is generally not needed.

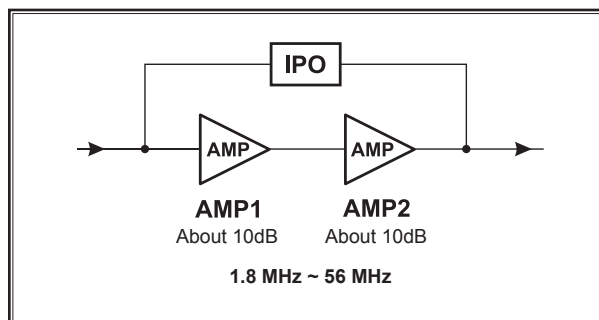

IF NOISE BLANKER (NB) OPERATION

The **FT-991** includes an effective IF Noise Blanker, which can significantly reduce noise caused by automotive ignition systems.

1. Press the **F(M-LIST)** button to display the function menu list. Touch the **[NB]** function icon briefly to reduce *short duration pulse noise* like that from switching transients, automobile ignitions and power lines. The Noise Blanker will be set to “ON”.

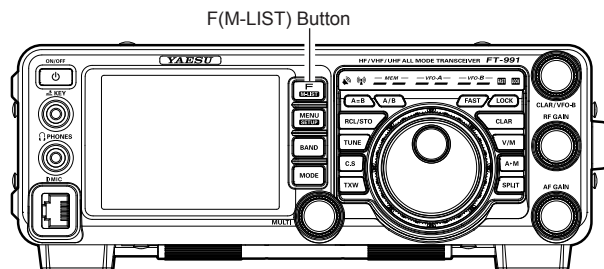
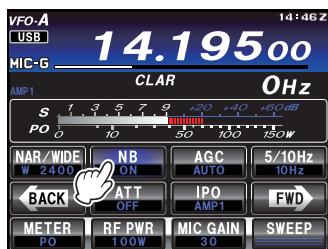

2. If desired, the Noise Blanker level may be adjusted via Menu item “025 NB LEVEL” to the point where the offending noise is best reduced or eliminated. See box below for details.

ADVICE:

- The noise attenuation can be selected from 10dB/30dB/50dB via Menu item “024 NB REJECTION”.
3. To end Noise Blanker operation, touch **[NB]** on the TFT display once more. The “OFF” will appear in the TFT display, confirming the Noise Blanker is no longer in operation.

Adjusting the Noise Blanker Level

1. Press the **MENU** button to engage the Menu mode.
2. Rotate the **MULTI** knob to select Menu item “025 NB LEVEL”.
3. Touch **[SELECT]** on the LCD

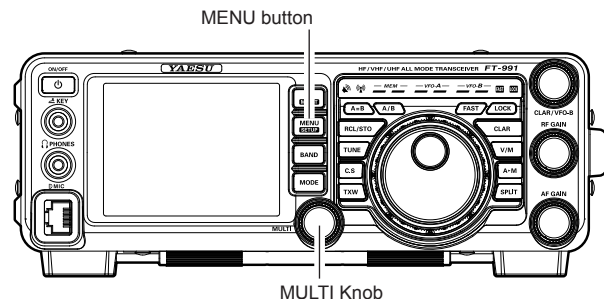
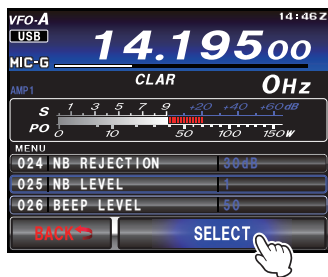

4. Rotate the **MULTI** knob to the point where the offending noise is best reduced or eliminated.
5. Touch **[ENTER]** on the LCD, then press the **MENU** button or touch **[BACK]** on the LCD to lock in the new setting and exit to normal operation.

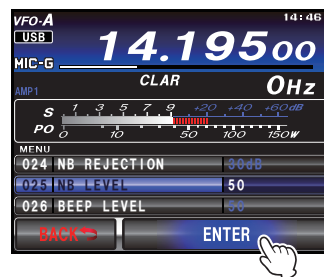

INTERFERENCE REJECTION

CONTOUR CONTROL OPERATION

The Contour filter system provides a gentle perturbation of the IF filter passband. The Contour is set to either suppress, or boost specific frequency components, and thus enhances the sound and readability of a received signal.

1. Press the **F(M-LIST)** button to display the function menu list. Touch **[CONT]** to activate the CONTOUR function and set the **MULTI** knob as the CONTOUR adjustment knob.
2. Touch **[CONT]** on the TFT display. The Contour function will be set to “ON”.

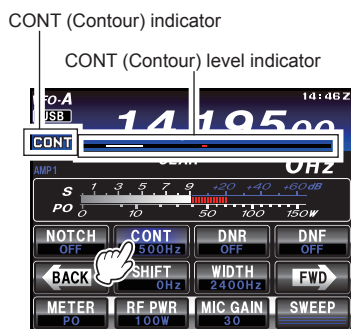

3. Rotate the **MULTI** knob to achieve the most natural sounding audio reproduction of the incoming signal.

ADVICE:

- Rotate the **MULTI** knob to display the Contour center frequency (10 Hz to 3,200 Hz) below the **[CONT]** indicator.
 - The level indicator shows the amount of attenuation for your reference.
4. To cancel Contour tuning, touch **[CONT]** on the TFT display.

ADVICE:

- The Contour circuit operation will be set to “OFF”.
- Touching **[CONT]** changes the Contour circuit operation between “ON” and “OFF”.
- The Contour function attenuation and bandwidth can be set in Menu items “114 CONTOUR LEVEL” and “115 CONTOUR WIDTH” (refer to the instruction on the right).

QUICK POINT:

By judicious use of the Contour filter, the “shoulder” of the passband response may be altered, or components may be removed from within the passband, allowing the desired signal to rise above the background noise and interference in a manner not obtainable with other filtering systems.

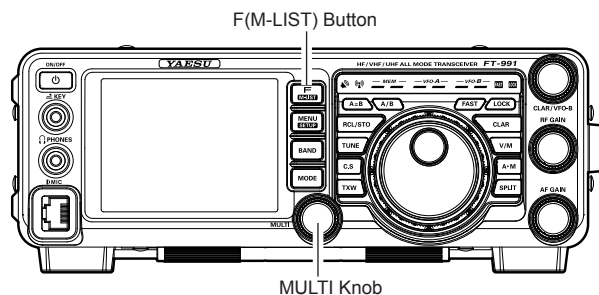

Refer to Figure “B”, this illustrates a “dip” in the center of the Contour filter passband. The Contour filter places a low-Q “notch” in the passband, per the settings of Menu items “114 CONTOUR LEVEL” and “115 CONTOUR WIDTH”. Counter-clockwise rotation of the **MULTI** knob causes the notch to move toward a lower frequency within the passband, while clockwise rotation causes the notch to move toward a higher frequency within the passband. By removing interference or unwanted frequency components of the incoming signal, it is possible to make the desired signal rise out of the background noise/interference, and significantly enhance intelligibility.

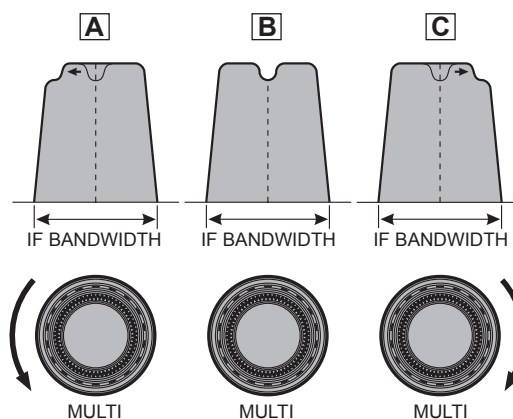

IF SHIFT OPERATION (SSB/CW/RTTY/DATA MODES)

IF SHIFT permits moving the DSP filter passband higher or lower, without changing the pitch of the incoming signal, and thus reduces or eliminates interference. Because the tuned carrier frequency is not varied, there is no need to re-tune the operating frequency to eliminate the interference. The total passband tuning range for the IF SHIFT system is ± 1.2 kHz.

1. Press the **F(M-LIST)** button to display the function menu list. Touch **[SHIFT]** to reduce the interference. The **MULTI** knob functions as the SHIFT adjustment knob.

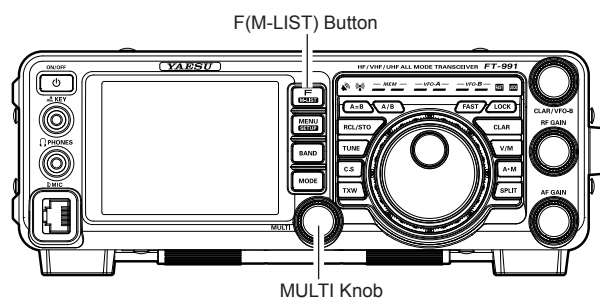
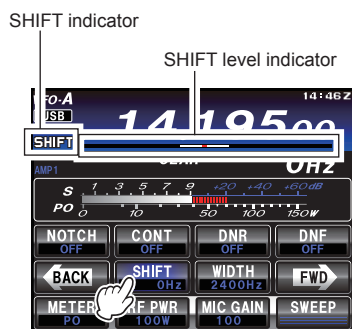

2. Rotate the **MULTI** knob to the left or right to reduce interfering signals.

ADVICE:

- Rotate the **MULTI** knob to display the shift offset of the IF filter ($-1,200$ Hz to $+1,200$ Hz) below the **[SHIFT]** indicator.
- The level indicator shows the shift offset direction for your reference.

Referring to Figure "A", note the depiction of the IF DSP filter as the thick line, with **MULTI** knob in the 12 o'clock position. In Figure "B", an interfering signal has appeared inside the original passband. In Figure "C", you can see the effect of rotating the **MULTI** knob. The interference level is reduced by moving the filter passband so that the interference is outside of the passband.

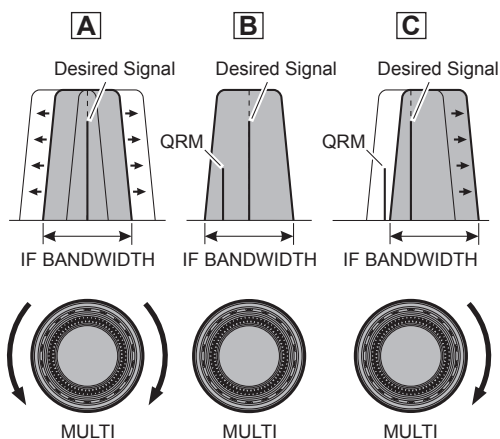

INTERFERENCE REJECTION

WIDTH (IF DSP BANDWIDTH) TUNING (SSB/CW/RTTY/DATA MODES)

The IF WIDTH tuning system allows you to vary the width of the DSP IF passband, to reduce or eliminate interference. Moreover, the bandwidth may actually be *expanded* from its default setting, should you wish to enhance incoming signal fidelity when interference on the band is low.

1. Press the **F(M-LIST)** button to display the function menu list. Touch the **[WIDTH]** icon to activate this function and cause the **MULTI** knob to function as the WIDTH adjustment knob.

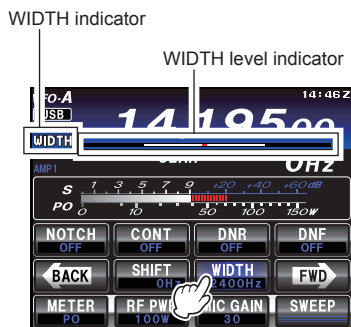

2. Rotate the **MULTI** knob counter-clockwise to narrow the bandwidth and reduce interference.

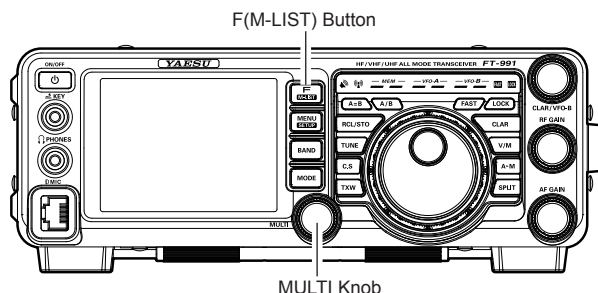

ADVICE:

- To increase the bandwidth, rotate the knob clockwise.
- Rotate the **MULTI** knob to display the bandwidth of the IF filter below the **[WIDTH]** indicator (Refer to the instruction below).
- For reference, the level indicator on the TFT display shows the bandwidth.

Referring to Figure “B”, you can see the default bandwidth of the SSB mode.

By rotating the **MULTI** knob to the left, the bandwidth will narrow (see Figure “A”), while rotation of the **MULTI** knob to the right, will increase the bandwidth as depicted in Figure “C”.

The default bandwidths, and total bandwidth adjustment range, will vary according to the operating mode:

SSB Mode: 1.8 kHz - 3.2 kHz (default: 2.4 kHz).

CW Mode: 500 Hz - 3 kHz (default: 2.4 kHz)

RTTY/DATA (LSB, USB) Modes: 500 Hz - 3 kHz (default: 500 Hz)

AM Mode: Fixed at 9 kHz

FM/DATA-FM/C4FM Modes: Fixed at 16 kHz

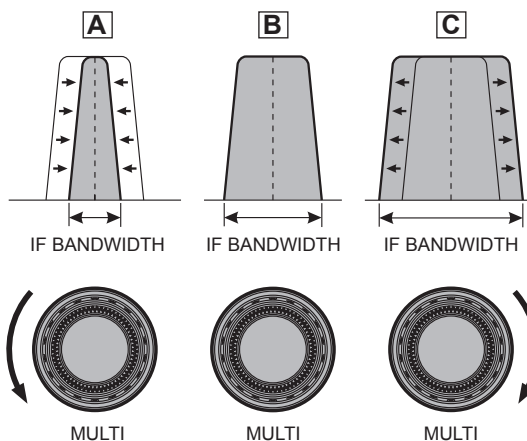

WIDTH (IF DSP BANDWIDTH) TUNING (SSB/CW/RTTY/DATA MODES)

Using IF SHIFT and WIDTH Together

The IF SHIFT and Variable IF WIDTH features together form a very effective interference-fighting filtering system.

For example, in Figure "A", you can see how interference has appeared both on the high and low sides of the desired signal. Touch [WIDTH] on the LCD, the interference from one side can be eliminated (Figure "B"). Next, rotate the **MULTI** knob to re-position the passband (Figure "C"), the interference on the opposite side can be removed, without re-introducing the interference previously eliminated in Figure "B".

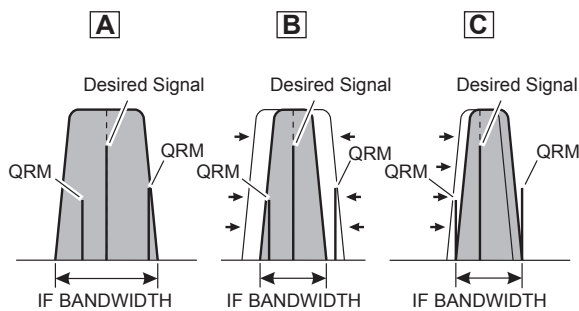

ADVICE:

The WIDTH and SHIFT features are the primary tools to use for best interference reduction. After narrowing the bandwidth (WIDTH) and/or adjusting the center of the passband (SHIFT), the Contour control may then yield additional signal-enhancement benefits on the net residual bandwidth. Even more, the IF NOTCH Filter (described later) may also be used, in conjunction with these filter systems, to significant advantage.

INTERFERENCE REJECTION

NARROW (NAR) ONE-TOUCH IF FILTER SELECTION

Press the **F(M-LIST)** button to display the function menu list. Touch the **[NAR/WIDE]** button to enable one-touch, mode-specific, selection of a narrow IF DSP filter setting that does not require resetting the bandwidth control to the WIDTH/SHIFT system.

Touching **[NAR/WIDE]** on the LCD once more returns the bandwidth control to the WIDTH/SHIFT system. The factory default bandwidths are:

OPERATING MODE	[NAR/WIDE] TOUCH KEY	
	"ON"	"OFF"
SSB	200 Hz - 1.8 kHz* (1.5 kHz)	1.8 - 3.0 kHz* (2.4 kHz)
CW	50 - 500 Hz* (500 Hz)	500 Hz - 3.0 kHz* (2.4 kHz)
RTTY/DATA-LSB/ DATA-USB	50 - 500 Hz* (300 Hz)	500 Hz - 3.0 kHz* (500 Hz)
AM	6 kHz	9 kHz
FM/DATA-FM (28/50/144/430 MHz Bands)	9 kHz	16 kHz

*: Depends on the [WIDTH] setting
(): Default Bandwidth

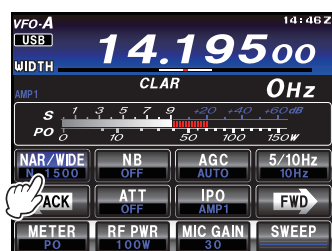
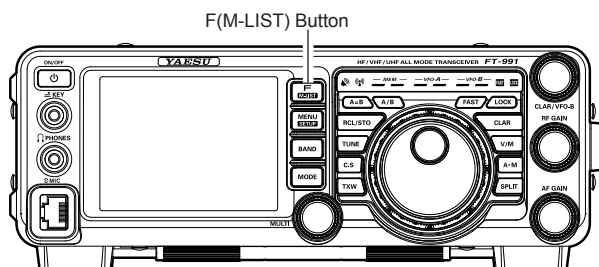

ADVICE:

- If **[NAR/WIDE]** on the LCD has been touched to engage the narrow filter, you may further adjust the narrow IF bandwidth by touching **[WIDTH]** on the TFT display and rotating the **MULTI** knob. The IF SHIFT may also be operated.
- When in the FM mode, touching **[NAR/WIDE]** on the TFT display will narrow both transmit and receive bandwidths.

IF NOTCH FILTER OPERATION (SSB/CW/RTTY/DATA/AM MODES)

The IF NOTCH filter is a highly effective system that allows cutting out an interfering beat note or other carrier signal from inside the receiver passband.

1. Press the **F(MLIST)** button to show the functions listed on the TFT display.
2. Touch **[NOTCH]** on the TFT display. The Notch function will be set to “ON”.

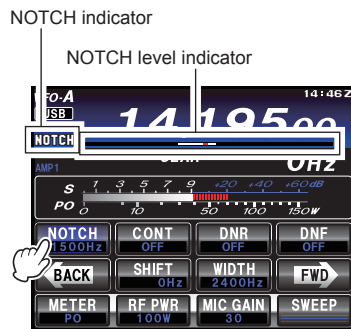

3. Rotate the **MULTI** knob to adjust the “null” position of the Notch filter.
4. To cancel the NOTCH filter, touch **[NOTCH]** on the TFT display, “OFF” will appear in the display, confirming that the NOTCH filter is no longer in operation.

ADVICE:

Alternate touches of **[NOTCH]**, will switch the NOTCH filter between on and off.

ADVICE:

- ❑ The bandwidth of the NOTCH filter (either narrow or wide) may be adjusted using Menu item “116 IF NOTCH WIDTH”. The factory default setting is “WIDE”.

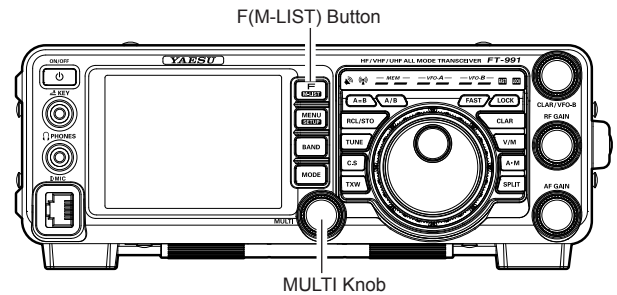

The performance of the IF NOTCH filter is illustrated in Figure “A”, where the desired signal and the interfering heterodyne are shown within the IF passband. In Figure “B” the notching effect of the IF NOTCH filter is illustrated as the **MULTI** knob is rotated to eliminate the interfering heterodyne.

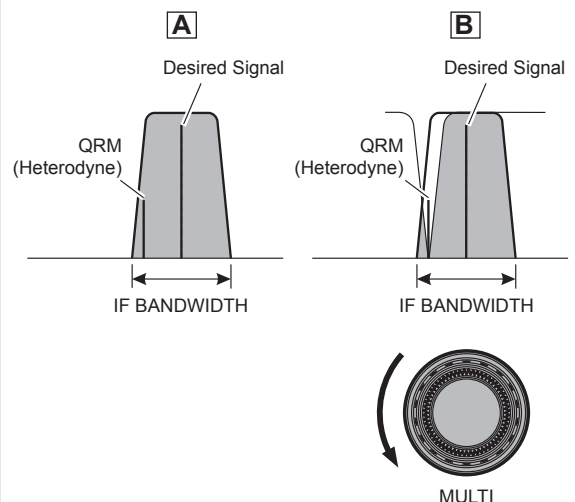

INTERFERENCE REJECTION

DIGITAL NOTCH FILTER (DNF) OPERATION

The Digital NOTCH Filter (DNF) is an effective beat-canceling filter that can null out a number of interfering beat notes inside the receiver passband. Because this is an Auto-Notch feature, there is no adjustment knob associated with this filter.

ADVICE:

If a very strong interfering carrier is encountered, we recommend using the IF NOTCH filter first, as it is the most effective notching tool in the receiver section.

1. Press the **F(M-LIST)** button to show the functions listed on the TFT display, then touch **[DNF]** on the TFT display. The Digital NOTCH Filter will be set to “ON”.

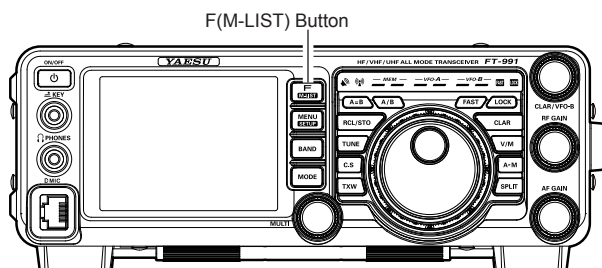
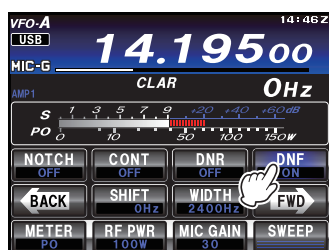

To disable the Digital NOTCH Filter, just repeat the above procedure, touching **[DNF]** on the LCD to choose “OFF”. The “DNF” will turn off, confirming that the Digital NOTCH Filter is not active.

DIGITAL NOISE REDUCTION (DNR) OPERATION

The Digital Noise Reduction (DNR) system is designed to reduce the level of ambient noise found on the HF and 50 MHz bands. The (DNR) system is especially effective during SSB operation. While DNR is functioning, rotate the **MULTI** knob to adjust the DNR level. Any of 15 different noise-reduction algorithms can be selected; each of these algorithms was created to deal with a different noise profile. You will want to experiment with the DNR system to find the best setting corresponding to the noise currently being experienced.

1. Press the **F(MLIST)** button to reveal the functions list on the TFT LCD display.
2. Touch **[DNR]** on the LCD. The DNR function will be set to “ON”.

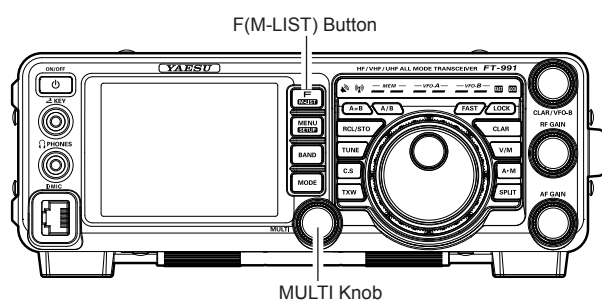
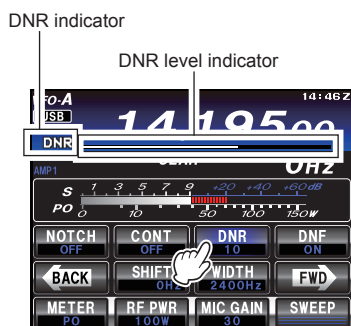

3. Rotate the **MULTI** knob to choose one of 15 algorithms that best reduces the noise level.
4. To cancel the DNR filter, touch **[DNR]** on the LCD, “OFF” will appear in the display, confirming that the DNR system is no longer in operation.

RF GAIN

The RF Gain control provides manual adjustment of the gain levels for the receiver RF and IF stages, to account for noise and signal strength conditions at the moment.

1. The **RF GAIN** knob should, initially, be rotated to the fully clockwise position. This is the point of maximum receiver sensitivity.
2. Counter-clockwise rotation of the **RF GAIN** knob will gradually reduce the system gain.

ADVICE:

- As the **RF GAIN** knob is rotated counterclockwise to reduce the gain, the S-meter reading will rise. This indicates that the AGC voltage being applied to the receiver is increasing (this causes a *reduction* in receiver gain).
- Rotating the **RF GAIN** knob control to the fully counter-clockwise position will essentially disable the receiver, as the gain will be greatly reduced. In this case, the S-meter will appear to be “pegged” against the right edge of the analog S-meter scale.

QUICK POINT:

- Reception frequently can be improved by rotating the **RF GAIN** knob slightly counter-clockwise to the point where the “stationary” meter indication is set just about the same as the incoming noise level. This will reduce the RF gain to find a level of improved signal to noise ratio.
- The RF Gain control, along with the IPO and the Attenuator features, all affect the system receiver gain in different ways. The IPO generally should be the first feature engaged when dealing with a high noise level, or a crowded, high-level signal environment. Also, the IPO generally should be the first feature engaged, if the frequency is low enough to allow the preamplifier to be bypassed. Thereafter, the RF Gain and Attenuator features may be employed to provide precise, delicate adjustment of the receiver gain to fully optimize performance.

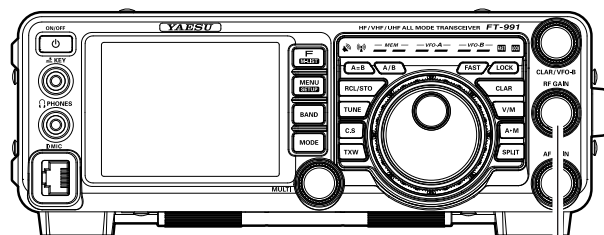

RF GAIN Knob

AUDIO PEAK FILTER

1. Press the **F(MLIST)** button to reveal the functions list on the TFT LCD display.
2. Touch **[APF]** on the LCD. The APF function will be set to “ON”.

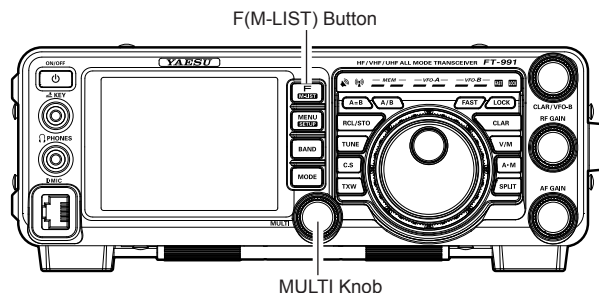
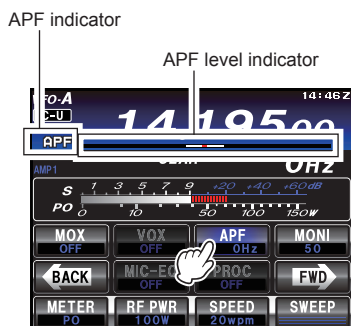

3. Rotate the **MULTI** knob to set the sound volume to a comfortable level.

ADVICE:

- The APF bandwidth can be selected from NARROW/MEDIUM/WIDE via the Menu item “113 APF WIDTH”.
4. To cancel the APF action, touch **[APF]** on the LCD. The “OFF” will appear in the display, confirming that the APF system is no longer in operation.

ADVICE:

The APF may only be activated while the transceiver is in CW mode.

TOOLS FOR COMFORTABLE AND EFFECTIVE RECEPTION

AGC (AUTOMATIC GAIN CONTROL)

The AGC system is designed to help compensate for fading and other propagation effects. The AGC characteristics can be individually set for each operating mode. The basic objective of AGC is to maintain a constant audio output level once a certain minimum threshold of signal strength is achieved.

Press the **F(M-LIST)** button, then touch **[AGC]** on the LCD repeatedly to select the desired receiver-recovery time constant. You will observe the AGC status notation in the AGC column of the Key Function Display on the TFT display, denoting the AGC receiver-recovery time currently in use. For most operations, we recommend the “AUTO” mode. Additionally, you may disable the AGC by touching **[AGC]** on the LCD.

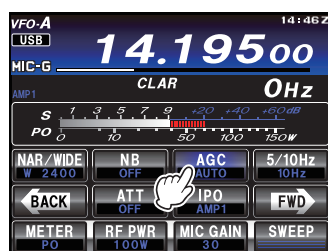

NOTE:

- ❑ The “AUTO” selection mode selects the optimum receiver-recovery time for the reception mode. In this case, the selected receiver-recovery time in the AGC column of the Key Function Display glows green (Normally it glows blue).
- ❑ Touching **[AGC]** on the LCD allows selection of the desired receiver-recovery time constant. Normally, the “AUTO” selection is satisfactory for most situations, but in the event of operation on a crowded band where you wish to receive a weak signal, you may wish to change the setting to FAST. The AUTO mode selections are:

OPERATING MODE	AUTO AGC SELECTION
LSB/USB/AM	SLOW
CW/FM/DATA-FM	FAST
RTTY/DATA-LSB/DATA-USB	MID

F(M-LIST) Button

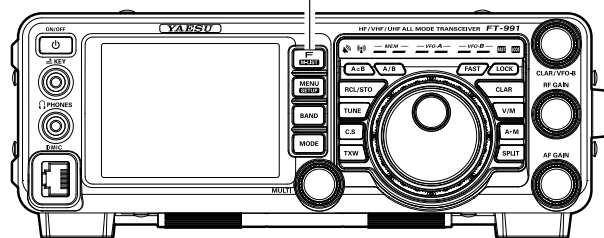

ADVICE:

- ❑ If the AGC receiver-recovery time is set to “Off” by touching **[AGC]** on the LCD, the S-meter will no longer deflect. Additionally, you will likely encounter distortion on stronger signals, as the IF amplifiers and the following stages are probably being overloaded.

QUICK POINT:

Several aspects of AGC performance may be configured via the Menu. However, because AGC can have such a profound impact on overall receiver performance, we generally do not recommend any changes to the AGC Menu selections until you are thoroughly familiar with the performance of the **FT-991**.

TERMINOLOGY:

Automatic Gain Control, or AGC, is a circuit that senses the received signal strength, and then limits the gain of the RF and IF stages to keep the output audio volume at a more-or-less constant level. AGC also protects the RF, IF, Audio, and DSP stages from overload, as it limits the signal strength that is allowed to flow, irrespective of the input signal level.

TOOLS FOR COMFORTABLE AND EFFECTIVE RECEPTION

ADJUSTABLE RECEIVER AUDIO FILTER

The **FT-991** includes an adjustable receiver audio filter, that provides precise, independent control of the low; and upper audio ranges.

1. Press the **MENU** button to enter the Menu mode.
2. Rotate the **MULTI** knob to find Menu items “041” through “044” these parameters apply to the adjustment of the receiver audio filter in the AM mode, Menu items “050” through “053” apply to the adjustment of the RX audio filter in the CW mode, Menu items “066” through “069” apply to the adjustment of the RX audio filter in the DATA mode, Menu items “094” through “097” apply to the adjustment of the RX audio filter in the RTTY mode, and Menu items “104” through “107” apply to the adjustment of the RX audio filter in the SSB mode
3. Touch **[SELECT]** on the LCD.

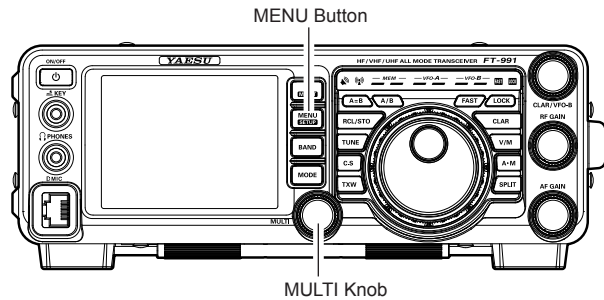

4. Rotate the **MULTI** knob to adjust the receiver audio response as desired.
5. Touch **[ENTER]** on the LCD to save the new setting.

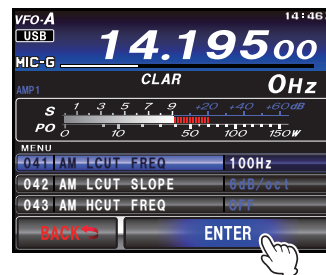
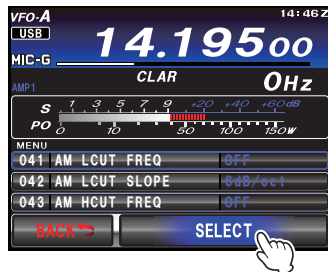

6. Press the **MENU** button or touch **[BACK]** on the LCD to exit to normal operation.

MODE	MENU ITEM	AVAILABLE VALUES
AM	041 AM LCUT FREQ	OFF/100(Hz) - 1000(Hz)
	042 AM LCUT SLOPE	6dB/oct / 18dB/oct
	043 AM HCUT FREQ	700(Hz) - 4000(Hz)/OFF
	044 AM HCUT SLOPE	6dB/oct / 18dB/oct
CW	050 CW LCUT FREQ	OFF/100(Hz) - 1000(Hz)
	051 CW LCUT SLOPE	6dB/oct / 18dB/oct
	052 CW HCUT FREQ	700(Hz) - 4000(Hz)/OFF
DATA	066 DATA LCUT FREQ	OFF/100(Hz) - 1000(Hz)
	067 DATA LCUT SLOPE	6dB/oct / 18dB/oct
	068 DATA HCUT FREQ	700(Hz) - 4000(Hz)/OFF
	069 DATA HCUT SLOPE	6dB/oct / 18dB/oct
RTTY	094 RTTY LCUT FREQ	OFF/100(Hz) - 1000(Hz)
	095 RTTY LCUT SLOPE	6dB/oct / 18dB/oct
	096 RTTY HCUT FREQ	700(Hz) - 4000(Hz)/OFF
SSB	097 RTTY HCUT SLOPE	6dB/oct / 18dB/oct
	104 SSB LCUT FREQ	OFF/100(Hz) - 1000(Hz)
	105 SSB LCUT SLOPE	6dB/oct / 18dB/oct
	106 SSB HCUT FREQ	700(Hz) - 4000(Hz)/OFF
	107 SSB HCUT SLOPE	6dB/oct / 18dB/oct

SSB/AM MODE TRANSMISSION

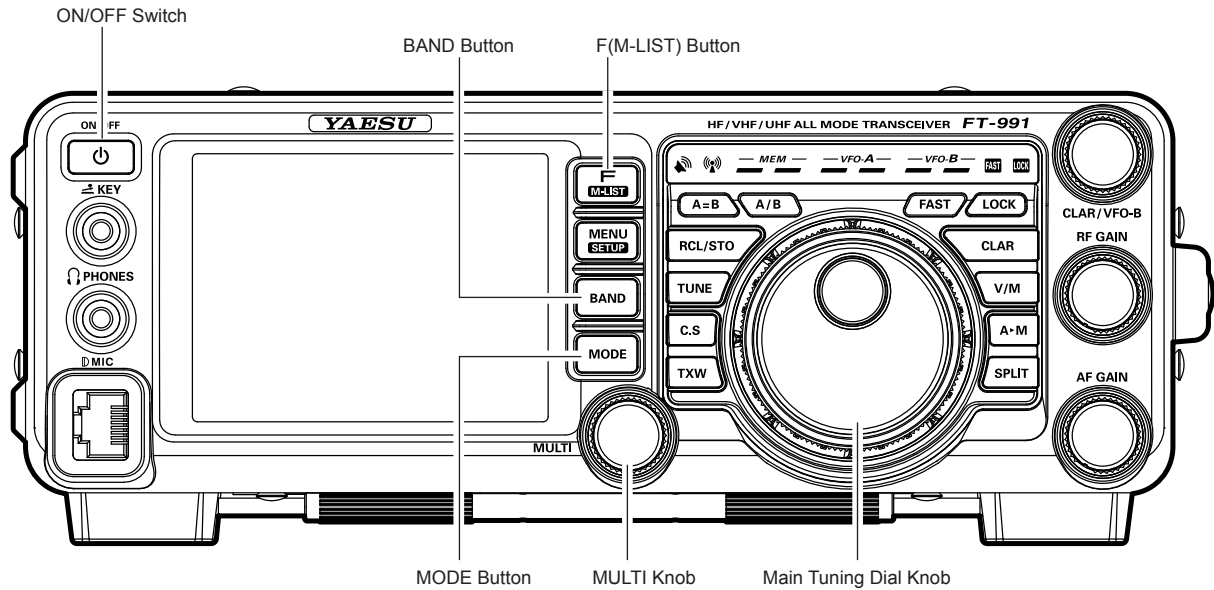

1. Press the **BAND** button to show the band list, and then touch a band key corresponding to the Amateur band on which you wish to operate. Press the **BAND** button again, to close the band list screen.
2. Press the **MODE** button to show the mode list, and then select the operating mode by touching the corresponding key. Press the **MODE** button again, to close the mode list screen.

ADVICE:

By convention, LSB is used in the 7 MHz and lower Amateur bands for SSB communication, and USB is used on the 14 MHz and higher bands (the 10 MHz band is used for CW and data modes only).

3. Rotate the Main Tuning Dial knob to adjust the operating frequency. Alternately, you may use the **UP/DWN** scanning buttons on the **MH-31A8J** Hand Microphone to scan up or down the current band.
4. Press the microphone **PTT** (Push To Talk) switch to begin transmitting; speak into the microphone in a normal voice level.

ADVICE:

- The “” indicator will light up in the TFT LED indicators area, confirming that transmission is in progress.
- When transmitting in the AM mode, set a maximum (carrier) power output of 25 Watts by pressing [**RF PWR**], then rotate the **MULTI** knob.

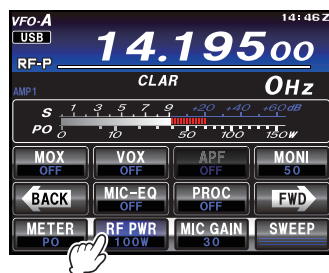

5. Adjust the microphone amplifier gain to match the microphone and your voice level: Touch [**METER**] on the LCD repeatedly to select the “ALC”. Press and hold the **PTT** switch, and speak into the microphone in a normal voice level.

In the SSB mode, touch [**MIC GAIN**] and then adjust **MULTI** knob so that the ALC meter stays within the ALC zone of the meter (up to half scale deflection) on voice peaks.

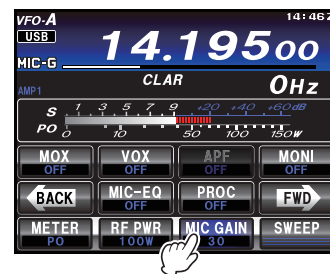

In the AM mode, touch [**MIC GAIN**] and then adjust the **MULTI** knob so that the ALC meter does not deflect on voice peaks.

- When transmitting In the AM mode, adjust the MIC gain so that the PO meter does not deflect when speaking.
6. Release the **PTT** switch at the end of the transmission. The transceiver will return to the receive mode.

SSB/AM MODE TRANSMISSION

ADVICE:

- ❑ ALC meter deflection may be caused by excessive drive power, but also by reflected power detected in the antenna system. If the antenna impedance presented to the transceiver is other than 50 Ohms, ALC meter action may be observed that is not related to the proper setting of [MIC GAIN] on the LCD. Therefore, we recommend that you make [MIC GAIN] adjustments into a dummy load or antenna system presenting impedance very close to 50 Ohms.
- ❑ When making “on air” tests (such as setting the microphone gain), be sure to listen on the frequency before transmitting, to avoid interference to others who may already be using the frequency.

- ❑ Four techniques to implement Transmit/Receive control are provided on the **FT-991**. You may choose the technique(s) that best suit your operating needs:
 - Pressing the microphone **PTT** switch will engage the transmitter.
 - The rear panel **PTT** jack may be connected to a foot switch or other manual switching device in order to engage the transmitter.
 - Touching [MOX] on the TFT display functions list will lock the transmitter on (The functions list may be displayed by pressing the **F(MLIST)** button). Touch [MOX] on the LCD again to return to receive.

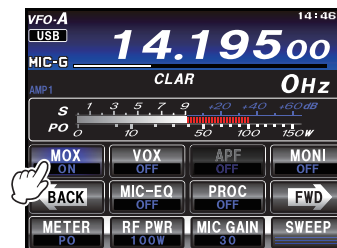

- The VOX (Voice Operated Xmit) circuit will engage the transmitter automatically when you speak into the microphone. For details of VOX operation refer to page 70.

USING THE AUTOMATIC ANTENNA TUNER

The Automatic Antenna Tuner (hereinafter referred to as the “ATU”) built into each **FT-991** is designed to ensure a 50-Ohm load for the final amplifier stage of the transmitter. We recommend using the ATU whenever operating the **FT-991**.

ADVICE:

- ❑ Because the ATU of the **FT-991** is located inside the station, it only adjusts the impedance presented to the transceiver at the station end of your coaxial cable feedline. It does not “tune” the SWR at the antenna feed point itself. When designing and building your antenna system, we recommend that every effort be made to ensure a low SWR at the antenna feed point.
- ❑ The ATU of the **FT-991** includes 100 memories for tuning data. Eleven of these memories are allocated, one for each Amateur band, so that each band has at least one setting preset for use on that band. The remaining 89 memories are reserved for the 89 most-recent tuning points, for quick frequency change without the need to retune the ATU.
- ❑ The ATU in the **FT-991** is designed to match impedances within the range of 16.7 Ohms to 150 Ohms, corresponding to an SWR of 3:1 or less on the 160 through 6 meter amateur bands. Accordingly, simple non-resonant whip antennas, along with random-length wires and the “G5RV” antenna (on most bands) may not be within the impedance matching range of the ATU.

ATU OPERATION

1. Use the Main Tuning Dial knob to set the radio to the desired operating frequency within the Amateur band.
2. Press the **TUNE** button momentarily to place the ATU in the transmit line (no adjustment/tuning will occur yet). The “**TUNER**” icon will appear in the display.

QUICK POINT:

The momentary press of the **TUNE** button will turn the tuner on, and the microprocessor will automatically select the tuning point closest to the current operating frequency.

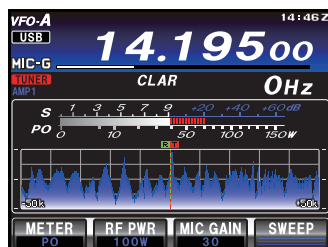

3. Press and hold in the **TUNE** button for one second to begin automatic tuning. The transmitter will be engaged, and the “**TUNER**” icon will blink while tuning is in progress. When the optimum tuning point has been reached, the radio will return to receive, and the “**TUNER**” icon will again glow steadily (instead of blinking).
4. To disconnect the ATU from the transmit line, press the **TUNE** button momentarily. The “**TUNER**” icon will turn off, confirming that the ATU has been turned off. In the “Off” mode, the transceiver will be directly connected to the coaxial cable connected to your antenna, and will respond to whatever impedance is present at the station end of the coax.

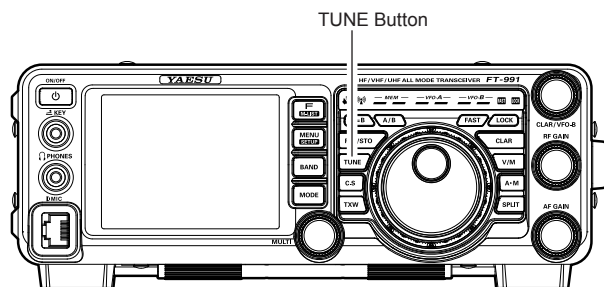

ADVICE:

The ATU circuit is located between the final amplifier and the rear-panel antenna jack; reception is not affected by the ATU.

QUICK POINTS:

As shipped from the factory, only one ATU alignment point is saved on each Amateur band. This was memorized during the final alignment and performance verification stages on the production line.

NOTE:

Please listen to the operating frequency before beginning the tuning process, to be sure you are not interfering with others who may already be using the frequency.

TERMINOLOGY:

Antenna Tuner Memories: The ATU microprocessor makes a note of the selected tuning capacitors and inductors, and stores the data for each 10 kHz window in which tuning has occurred. This eliminates the need to re-tune every time you return to a frequency on which you have already completed the tuning process.

USING THE AUTOMATIC ANTENNA TUNER

ABOUT ATU OPERATION

Figure 1 depicts a situation where normal tuning via the ATU has been successfully completed, and the tuning data has been stored in the ATU memory. The antenna system as seen by the transmitter is shown.

In Figure 2, the operator has changed frequency, and the “**HI-SWR**” icon has appeared. The operator presses and holds in the **TUNE** button for one second to begin impedance matching using the ATU.

If a high SWR condition exists (above 3:1), corrective action must be taken in the antenna system to bring the impedance closer to 50 Ohms. The ATU will refuse to memorize settings on frequencies where the SWR exceeds 3:1. A High SWR may indicate a mechanical failure in the feed system, and can lead to the generation of spurious signals causing TVI, etc.

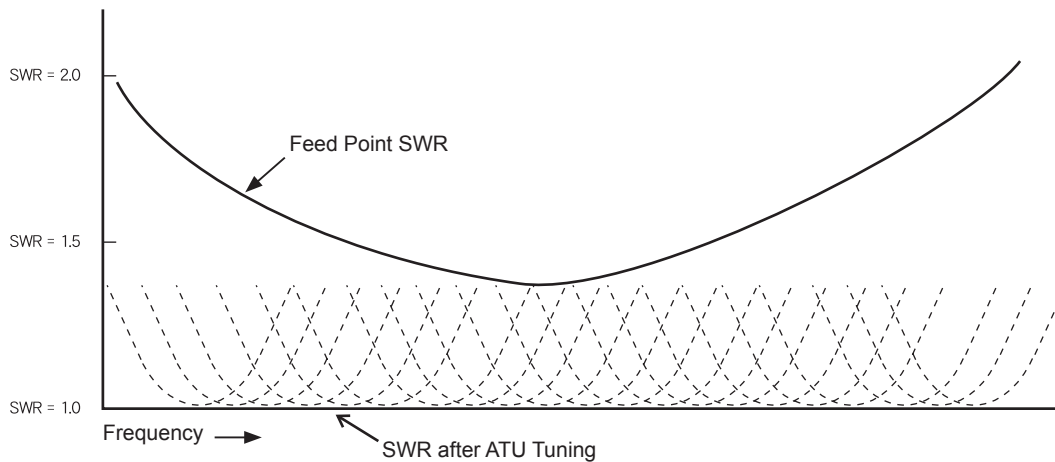

FIGURE 1

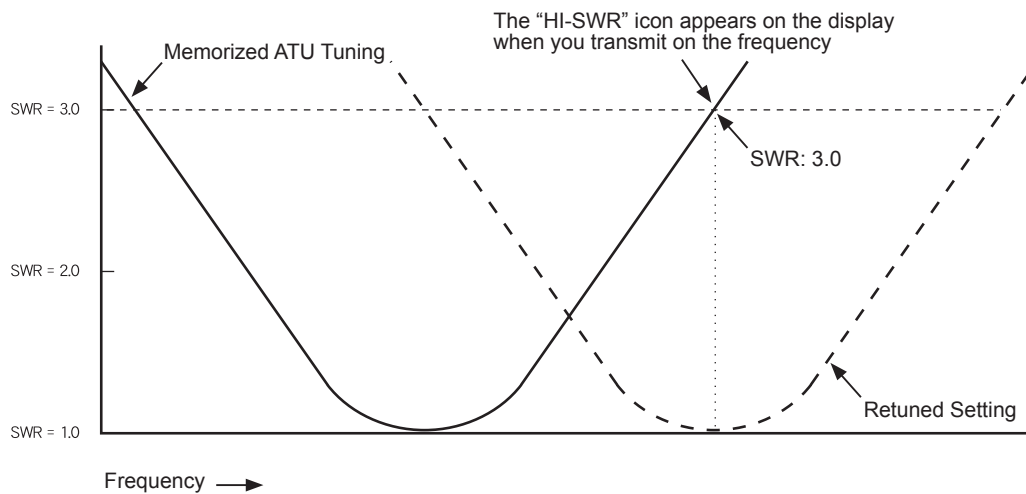

FIGURE 2

About ATU Memories

SWR (After tuning) Less than 2:1

The tuner settings are stored in the ATU memory.

SWR (After tuning) Greater than 2:1

Tuning data will not be retained in memory. If you return to the same frequency, the tuning process must be repeated.

SWR (After tuning) Greater than 3:1

The “**HI-SWR**” icon will light up, and the tuner settings, if achieved, will not be memorized. Please investigate the high SWR condition and resolve the problem before attempting further operation using this antenna.

ENHANCING TRANSMIT SIGNAL QUALITY

PARAMETRIC MICROPHONE EQUALIZER (SSB/AM MODE)

The **FT-991** includes a unique Three-Band Parametric Microphone Equalizer that provides precise, independent control over the low, mid and treble ranges in the voice waveform. You may utilize one group of settings when the speech processor is off and use an alternate group of settings when the speech processor is on. The speech processor feature is described in the next chapter.

QUICK POINT:

The Parametric Equalizer is a unique technique for adjusting the signal quality. The three audio ranges may be adjusted so precisely, it is possible to craft an audio response that provides a natural and pleasant sound that you may not have ever experienced before. Alternately, the effective “talk power” can be significantly enhanced.

The configuration aspects that may be adjusted on the Parametric Equalizer are:

- Center Frequency:** The center frequency of each of the three bands may be adjusted.
- Gain:** The amount of enhancement (or suppression) within each band may be adjusted.
- Q:** The bandwidth over which the equalization is applied may be adjusted.

Setup of the Parametric Microphone Equalizer

1. Connect the microphone to the **MIC** jack.
2. Set the RF output power to minimum value.

ADVICE:

- We recommend that you connect a dummy load to one of the Antenna jacks, and monitor your signal on a separate receiver, to prevent interference to other users.
 - You will have the best chance of hearing the effects of adjustments if you wear headphones (connected to the separate monitor receiver) while listening to your transmitted signal.
3. To adjust the Parametric Microphone Equalizer while the speech processor is disabled, press the **F(M-LIST)** button, then touch **[MIC-EQ]** to select “ON”.

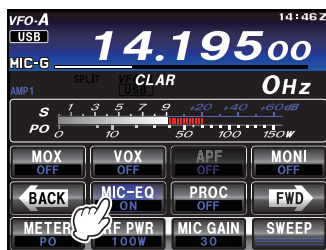
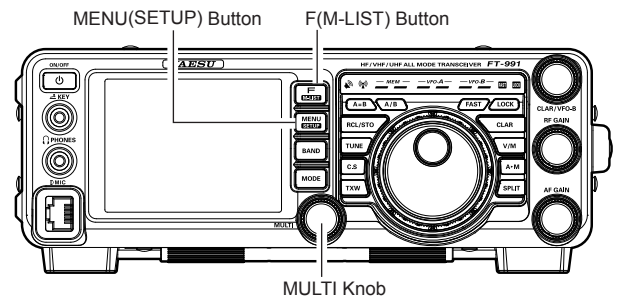

To adjust the Parametric Microphone Equalizer with the speech processor engaged, press the **F(M-LIST)** button, then touch **[PROC]** to select “ON”.

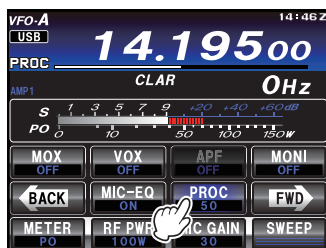

4. Touch **[MONI]**, if you want to listen on the **FT-991** internal monitor.

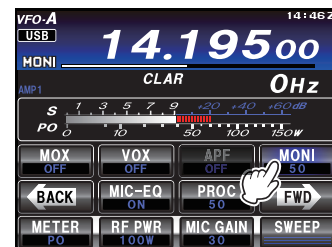

5. Press the **MENU(SETUP)** button. The Menu list will appear in the TFT display.
6. Rotate the **MULT** knob to find the “EQ” Menu area, containing Menu items “121” through “129”; these parameters apply to the adjustment of the Parametric Microphone Equalizer when the speech processor is disabled. Menu items “130” through “138” apply to the adjustment of the Parametric Microphone Equalizer when the speech processor is engaged.
7. Touch **[SELECT]** on the LCD, then rotate the **MULT** knob to adjust a particular Menu item.

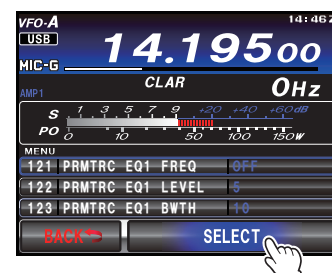

ENHANCING TRANSMIT SIGNAL QUALITY

PARAMETRIC MICROPHONE EQUALIZER (SSB/AM MODE)

- Press and hold the **PTT** switch, and speak into the microphone while listening to the effect of the changes you are making. Because the overall effect on the sound will change with each adjustment, make several passes through each adjustment area, to be sure that you achieve the optimum settings.
- When all adjustments have been completed, touch **[ENTER]** on the LCD to save the new settings.



- Press the **MENU(SETUP)** button or touch **[BACK]** on the LCD to return to normal operation. If you only touch **[BACK]** momentarily to exit the setup menu, none of the changes you performed will be stored.

ADVICE:

To roll off the excessive bass response prevalent in a wide-range of studio microphones, try setting the microphone equalizer for a 10 dB null at 100 Hz with a bandwidth of “1” or “2”, a 3 dB null centered on 800 Hz with a bandwidth of “3”, and then put an 8 dB peak centered on 2100 Hz with a bandwidth of “1.” These are starting recommendations; each microphone and user’s voice will be different, often requiring different settings.

ENHANCING TRANSMIT SIGNAL QUALITY

PARAMETRIC MICROPHONE EQUALIZER (SSB/AM MODE)

Activating the Parametric Microphone Equalizer

1. Adjust [MIC GAIN] on the TFT display, as described on page 59.
2. Press the **F(M-LIST)** button, then touch [MIC-EQ] on the TFT display to select "ON". If you use the Parametric Microphone Equalizer with the speech processor engaged, press the **F(M-LIST)** button, then touch [PROC] to display the PROC level (from 1 to 100), confirming that the Parametric Microphone Equalizer is engaged.

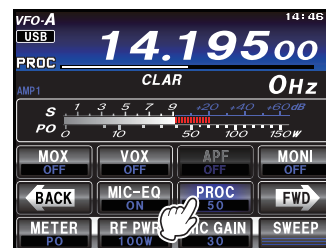
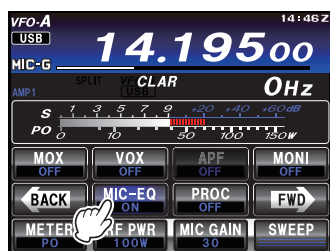
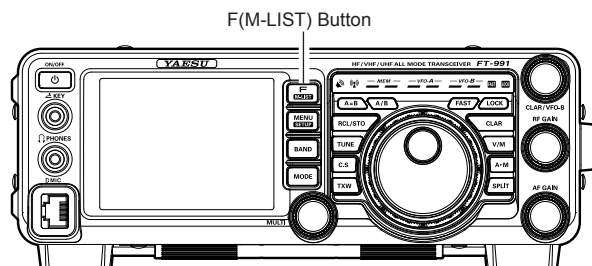

3. Press the **PTT** switch on the microphone, and speak into the microphone in a normal voice level.
4. To switch the Parametric Microphone Equalizer off, touch [MIC-EQ] on the LCD again.

3-STAGE PARAMETRIC EQUALIZER ADJUSTMENTS (SPEECH PROCESSOR: "OFF")		
Center Frequency	"121 PRMTRC EQ1 FREQ"	"100" (Hz) - "700" (Hz) / "OFF"
	"124 PRMTRC EQ2 FREQ"	"700" (Hz) - "1500" (Hz) / "OFF"
	"127 PRMTRC EQ3 FREQ"	"1500" (Hz) - "3200" (Hz) / "OFF"
Parametric Gain	"122 PRMTRC EQ1 LEVEL"	(Low) "-20" (dB) - "10" (dB)
	"125 PRMTRC EQ2 LEVEL"	(Mid) "-20" (dB) - "10" (dB)
	"128 PRMTRC EQ3 LEVEL"	(High) "-20" (dB) - "10" (dB)
Q (Bandwidth)	"123 PRMTRC EQ1 BWTH"	(Low) "1" - "10"
	"126 PRMTRC EQ2 BWTH"	(Mid) "1" - "10"
	"129 PRMTRC EQ3 BWTH"	(High) "1" - "10"

3-STAGE PARAMETRIC EQUALIZER ADJUSTMENTS (SPEECH PROCESSOR: "ON")		
Center Frequency	"130 P-PRMTRC EQ1 FREQ"	"100" (Hz) - "700" (Hz) / "OFF"
	"133 P-PRMTRC EQ2 FREQ"	"700" (Hz) - "1500" (Hz) / "OFF"
	"136 P-PRMTRC EQ3 FREQ"	"1500" (Hz) - "3200" (Hz) / "OFF"
Parametric Gain	"131 P-PRMTRC EQ1 LEVEL"	(Low) "-20" (dB) - "10" (dB)
	"134 P-PRMTRC EQ2 LEVEL"	(Mid) "-20" (dB) - "10" (dB)
	"137 P-PRMTRC EQ3 LEVEL"	(High) "-20" (dB) - "10" (dB)
Q (Bandwidth)	"132 P-PRMTRC EQ1 BWTH"	(Low) "1" - "10"
	"135 P-PRMTRC EQ2 BWTH"	(Mid) "1" - "10"
	"138 P-PRMTRC EQ3 BWTH"	(High) "1" - "10"

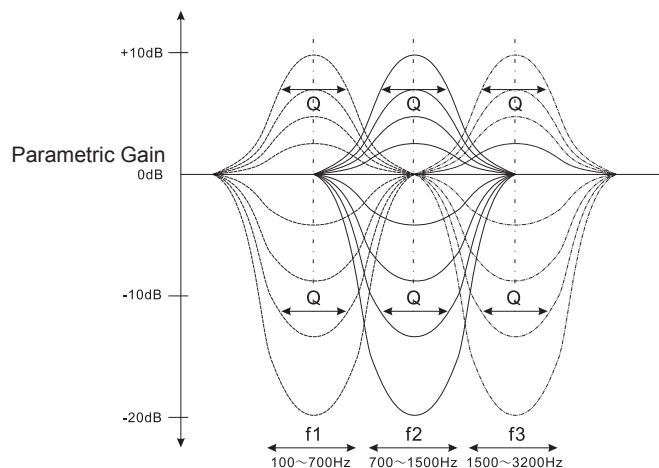

ENHANCING TRANSMIT SIGNAL QUALITY

USING THE SPEECH PROCESSOR (SSB MODE)

The **FT-991** Speech Processor is designed to increase “talk power” by increasing the average power output (via a sophisticated compression technique) and adjusting the audio quality to the menu settings (“130 P-PRMTRC EQ1 FREQ”, “133 P-PRMTRC EQ2 FREQ”, “136 P-PRMTRC EQ3 FREQ”). The result is improved intelligibility when conditions are difficult.

1. Adjust [**MIC GAIN**] on the TFT display, as described on page 59.
2. Touch [**METER**] on the TFT display to select “COMP” (Compression) meter.

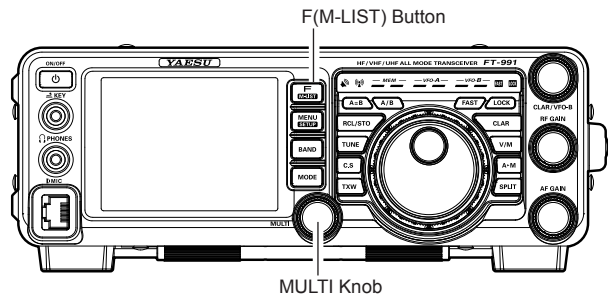
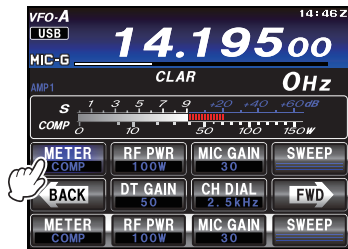

3. Press the **F(M-LIST)** button, then touch [**PROC**] to display the PROC level (from 1 to 100), confirming that the Speech Processor is engaged.

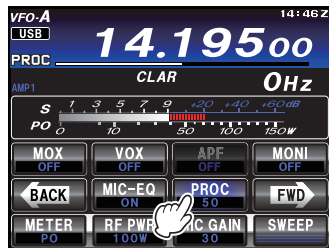

4. Press the **PTT** switch on the microphone, and speak into the microphone in a normal voice level.
5. Adjust the **MULT** knob to set the compression level within the 5 dB to 10 dB range.
6. To switch the Speech Processor off, touch [**PROC**] on the TFT display once more. The “OFF” will appear in the display, confirming that the Speech processor is turned off.

ADVICE:

- You may adjust the Parametric Microphone Equalizer when the speech processor is engaged, using Menu Items “130” through “138”. See page 136 for details.

ENHANCING TRANSMIT SIGNAL QUALITY

ADJUSTING THE SSB TRANSMITTED BANDWIDTH (SSB MODE)

For SSB transmission, a default bandwidth of 2.4 kHz is available. This bandwidth provides reasonable fidelity along with good talk power, and is the typical bandwidth used for decades for SSB transmission. The transmit bandwidth may be varied by the operator, to provide different levels of fidelity or talk power, according to individual preferences.

Here are the steps to adjust the SSB transmit bandwidth:

1. Press the **MENU(SETUP)** button to engage the Menu.
2. Rotate the **MULTI** knob to select Menu item “112 SSB TX BPF”.
3. Touch **[SELECT]** on the TFT display, then rotate the **MULTI** knob to select the desired bandwidth. The available selections are: 100-3000 Hz, 100-2900 Hz, 200-2800 Hz, 300-2700 Hz, 400-2600 Hz. The default is 300-2700 Hz. A wider bandwidth will provide greater fidelity. A narrow bandwidth will compress the available transmitter power into less spectrum, resulting in more “talk power” for DX pile-ups.

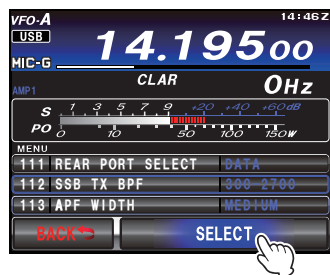
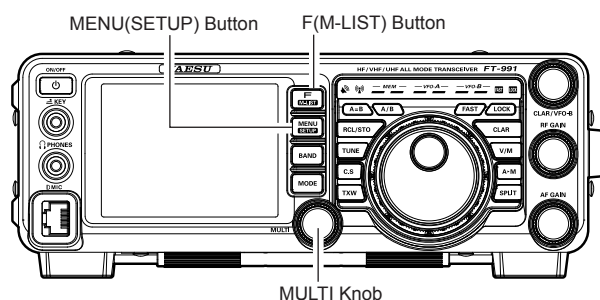

4. Touch **[ENTER]** on the TFT display to save the new setting.

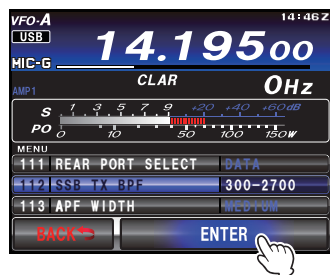

5. Press the **MENU(SETUP)** button or touch **[BACK]** on the TFT display to exit to normal operation.

ADVICE:

The Transmit Monitor function is a very helpful way to confirm the effect that changing the bandwidth will have on fidelity. To activate the Monitor function, press the **F(MLIST)** button to reveal the functions list on the TFT LCD display. Then touch the **[MONI]** button, you will be able to hear the difference in sound quality as you make bandwidth changes.

QUICK POINTS:

The higher fidelity associated with wide bandwidth will be particularly enjoyable on the low bands during local rag-chew QSOs.

TRANSMITTER CONVENIENCE FEATURES

VOICE MEMORY (SSB/AM MODES)

You may utilize the Voice Memory capability of the **FT-991** for repetitive messages. The Voice Memory system includes five memories capable of storing up to 20 seconds of voice audio each. The maximum that any memory can hold is 20 seconds.

Voice Memory Operation

You may also utilize the Voice Memory capability of the **FT-991** by operating from the display or the optional **FH-2** Remote Control Keypad, which plugs into the rear panel **REM/ALC** jack.

Recording Your Own Voice in Memory

1. Select the LSB, USB, or AM mode using the front panel **MODE** button.
2. Adjust **[MIC GAIN]** on the LCD, as described on page 59.
3. Touch **[MEM]** on the LCD or press the **[MEM]** key on the **FH-2**. A blinking “**REC**” icon will appear in the display.

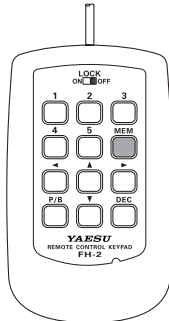
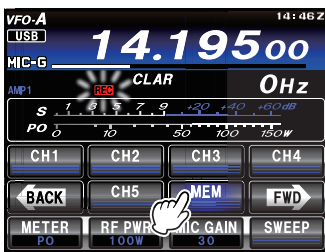

7. Touch **[MEM]** on the LCD or press the **FH-2 [MEM]** key to complete the message storage process.

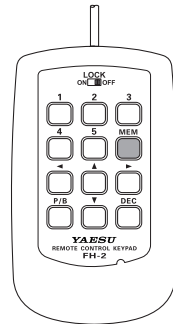
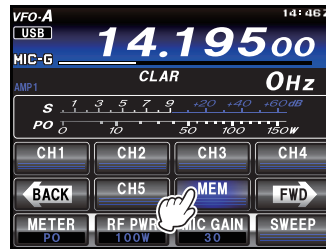

4. Touch **[CH1]** through **[CH5]** on the LCD or press any of the **FH-2** keys numbered **[1]** through **[5]** to select that memory storage register.

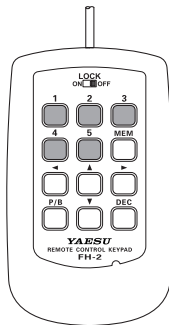
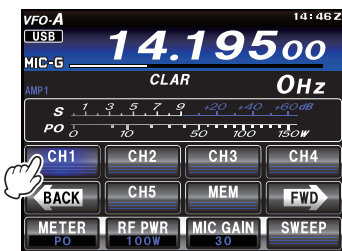

Checking Your Recording

1. Be sure that **[VOX]** and **[BK-IN]** functions are “Off” so transmit will not be activated. The function statuses may be observed on the TFT display by pressing the **F(M-LIST)** button.
2. Touch **[CH1]** - **[CH5]** on the LCD or press the **FH-2 [1]** - **[5]** key (whichever register you just recorded in). The “**PLAY**” icon will appear in the display and you will hear the contents of the Voice Memory you just recorded.

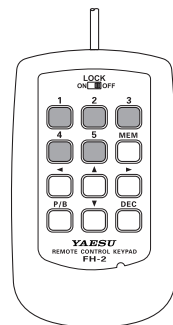
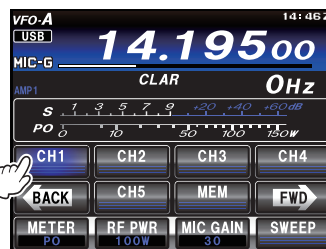

ADVICE:

If you do not press the **PTT** key (see next step) within five seconds, the memory storage process will be cancelled.

5. Press the microphone **PTT** switch momentarily. The “**REC**” icon will glow steadily and recording will begin.
6. Speak into the microphone in a normal voice level to record the message (such as “CQ DX, CQ DX, this is W 6 Delta X-Ray Charlie, W 6 Delta X-Ray Charlie, Over”). Remember that the time limit for recording any message is 20 seconds.

ADVICE:

The playback level of the recording may be adjusted via Menu item “**O10 DVS RX OUT LEVEL**”.

TRANSMITTER CONVENIENCE FEATURES

VOICE MEMORY (SSB/AM MODES)

Transmitting the Recorded Message

1. Select the LSB, USB, or AM mode using the front panel **MODE** button.
2. Press the front panel **F(M-LIST)** button to reveal the functions list on the TFT LCD display, then touch **[BK-IN]** on the LCD.

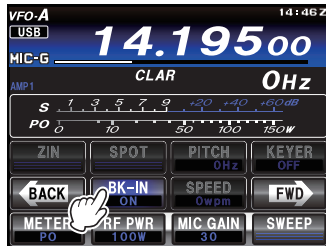

3. Touch **[CH1]** - **[CH5]** on the LCD or press the **FH-2** **[1]** - **[5]** key (whichever register you just recorded in). A “**PLAY**” icon will appear in the display and the message will be transmitted.

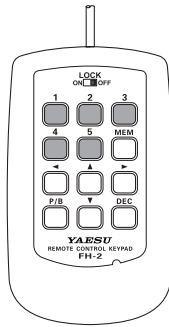
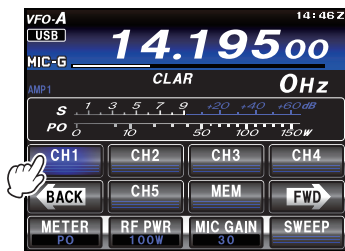

ADVICE:

The transmit (audio) level of the recording may be adjusted via Menu item “011 DVS TX OUT LEVEL”.

TRANSMITTER CONVENIENCE FEATURES

VOX (SSB/AM/FM MODES: AUTOMATIC TX/RX SWITCHING USING VOICE CONTROL)

Instead of using the microphone **PTT** switch or the **[MOX]** function (that may be displayed by pressing the **F(M-LIST)** button) to activate the transmitter, the VOX (Voice Operated Transmit) system may be used for hands-free activation of the transmitter, by the voice input to the microphone.

1. Press the **F(M-LIST)** button, to reveal the functions list on the TFT LCD display, then touch **[VOX]** on the LCD to activate the function, “ON” will appear in the display.

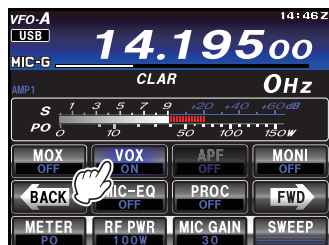

2. Without pressing the **PTT** switch, speak into the microphone in a normal voice level. When you start speaking, the transmitter should be activated automatically. When you finish speaking, the transceiver should return to the receive mode (after a short delay).
3. To cancel VOX and return to **PTT** operation, touch **[VOX]** on the LCD once more. The “VOX” indication will turn OFF, signifying that the VOX circuitry has been turned off.

ADVICE:

- The VOX Gain may be adjusted to prevent accidental transmitter activation in a noisy environment. To adjust the VOX Gain:
 - 1) Activate the VOX circuitry, if necessary.
 - 2) Press the **MENU(SETUP)** button to engage the Menu mode.
 - 3) Rotate the **MULTI** knob to select Menu item “145 VOX GAIN”, then touch **[SELECT]** on the LCD.

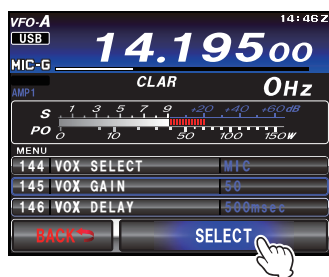

- 4) While speaking into the microphone, rotate the **MULTI** knob to the point where the transmitter is quickly activated by your voice, without background noise causing the transmitter to activate.
- 5) When you are satisfied with the setting, touch **[ENTER]** on the TFT LCD display to save the new setting.

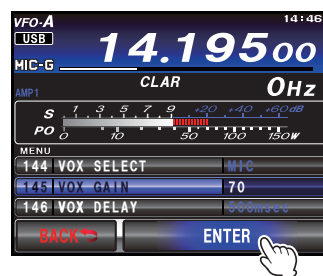
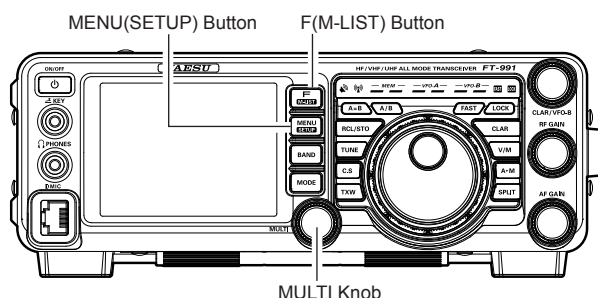

- 6) Press the **MENU(SETUP)** button or touch **[BACK]** on the LCD to exit to normal operation.
- The “Hang-Time” of the VOX system (the transmit/receive delay after the cessation of speech) may also be adjusted via the Menu mode. The default delay is 500 msec. To set a different delay time:
 - 1) Activate the VOX circuitry, if necessary.
 - 2) Press the **MENU(SETUP)** button to engage the Menu mode.
 - 3) Rotate the **MULTI** knob to select Menu item “146 VOX DELAY”, then touch **[SELECT]** on the LCD.

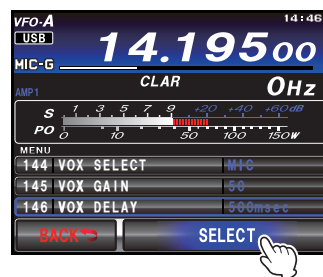

- 4) Rotate the **MULTI** knob while saying a brief syllable like “Ah” and listening to the hang time for the desired delay.

TRANSMITTER CONVENIENCE FEATURES

VOX (SSB/AM/FM MODES: AUTOMATIC TX/RX SWITCHING USING VOICE CONTROL)

- 5) When you are satisfied with the setting, touch [ENTER] on the TFT LCD display to save the new setting.



- 6) Press the **MENU(SETUP)** button or touch [BACK] on the LCD to exit to normal operation.
- The Anti-Trip setting adjusts the level of negative receiver audio feedback to the microphone, to prevent receiver audio from activating the transmitter (via the microphone). This setting can also be adjusted via Menu item “147 ANTI VOX GAIN”.
 - VOX operation may be engaged on either Voice modes (SSB/AM/FM) or on AFSK-based Data modes. Use Menu item “144 VOX SELECT” (the selections are “MIC” and “DATA”).

TRANSMITTER CONVENIENCE FEATURES

MONITOR (SSB/AM MODES)

You may listen to the quality of your transmitted signal using the Monitor feature.

1. Touch **[MONI]** displayed by pressing the **F(M-LIST)** button to reveal the functions list on the TFT LCD display.
2. Touch **[MONI]** on the LCD, the Monitor function will be set to “ON”. The **MULTI** knob serves as the MONITOR adjustment knob.

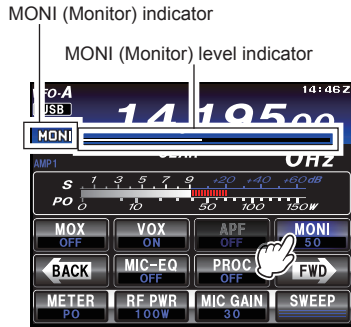
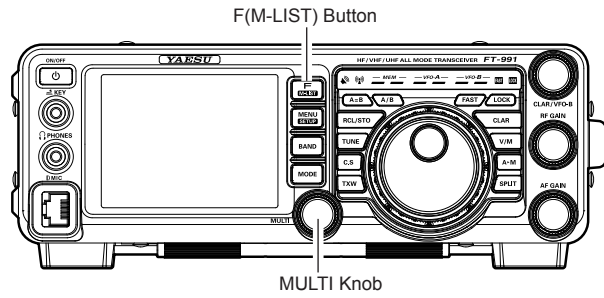

3. During transmission, rotate the **MULTI** knob to adjust the audio level in the Headphones or speaker. Clockwise rotation of this knob will increase the volume level.
4. To switch the Monitor off again, touch **[MONI]** on the LCD once more. “OFF” will be displayed, confirming that the Monitor function is disengaged.

ADVICE:

- Because the Monitor feature samples the transmitter IF signal, it can be very useful for checking the adjustment of the Speech Processor or Parametric Equalizer on SSB, and for checking the general signal quality on AM.

TRANSMITTER CONVENIENCE FEATURES

SPLIT OPERATION USING THE TX CLARIFIER

For split TX/RX operation in “casual” pile-ups, where the split is less than 10 kHz, the TX Clarifier (Offset Tuning) feature may be utilized.

1. Press the **MENU(SETUP)** button to enter the Menu mode.
2. Rotate the **MULTI** knob to select Menu item “040 CLAR MODE SELECT”.
3. Touch [**SELECT**] on the LCD, then rotate the **MULTI** knob to set this Menu item to “TX” (the default setting is “RX”).

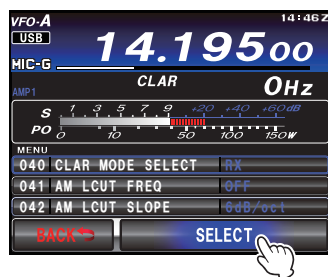

4. Touch [**ENTER**] on the LCD to save the new setting.

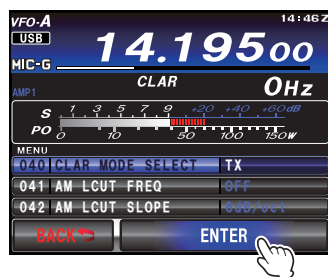

5. Press the **MENU(SETUP)** button or touch [**BACK**] on the LCD to exit to normal operation.
6. Press the **CLAR** button. The “TX” icon will appear in the TFT display.

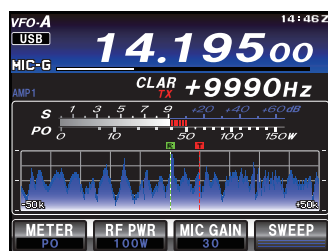

QUICK POINT:

The Clarifier is frequently used for receiver offset tuning. However, for DX pile-ups where the DX station is using a split of less than 10 kHz, the TX Clarifier function is usually the quickest way to set the transmitter to the desired offset frequency.

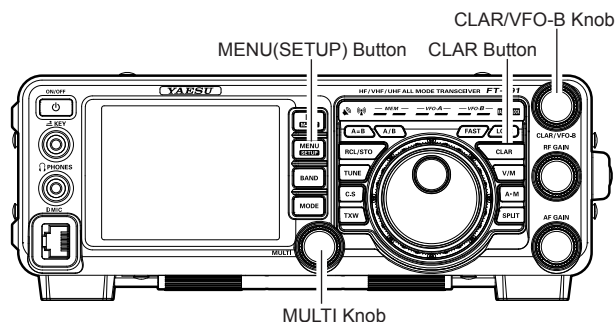

7. Rotate the **CLAR/VFO-B** knob to set the desired transmitter offset. A maximum split of ± 9.999 kHz may be set.
8. To exit from TX Clarifier operation, press the **CLAR** button once more. The “TX” icon will disappear from the display.

ADVICE:

- When listening to a “pile-up” calling a DX station, in order to find the station currently being worked, you may press the **CLAR** button. Then, use the **CLAR/VFO-B** knob to zero in on the station calling the DX (use the SPOT function on CW for precise alignment of your frequency). You may then press the **CLAR** button again to cancel the RX Clarifier, and return to reception on the DX station’s frequency.
- Just as with receiver Clarifier operation, the amount of offset from the original VFO frequency will appear in the display.
- As with receiver Clarifier operation, when you turn the TX Clarifier off, the last-used offset is remembered, and will be available if you turn the TX Clarifier back on. To clear the Clarifier offset, press and hold the **CLAR** button for more than 1 second.

QUICK POINT:

When attempting to work a DX station on CW in a split frequency pile-up, remember that a large number of other stations may also be using Yaesu transceivers with capability similar to that of your **FT-991**. On the DX side of the pile-up, everyone calling precisely on the same CW frequency will sound like a single tone! So you may have more success if you use the RX Clarifier to find a *hole* in the pile-up, instead of trying to zero-beat the last station worked by the DX station.

TRANSMITTER CONVENIENCE FEATURES

SPLIT-FREQUENCY OPERATION

A powerful capability of the **FT-991** is its flexibility in Split Frequency operation using the VFO-A and VFO-B frequency registers. This makes the **FT-991** especially useful for high-level DX-peditions. The Split operation capability is very advanced and easy to use.

1. Rotate the Main Tuning Dial knob to set the desired RX frequency.
2. Press the **A/B** button, then rotate the Main Tuning Dial knob to set the desired split TX frequency.
3. Press the **A/B** button, then press the **SPLIT** button. The VFO-B frequency will be shown in the TFT display and the LED indicators will appear as below:
VFO-A RX Indicator: "ON" (LED glows Green)
VFO-A TX Indicator: "OFF" (LED Off)
VFO-B RX Indicator: "OFF" (LED Off)
VFO-B TX Indicator: "ON" (LED glows Red)

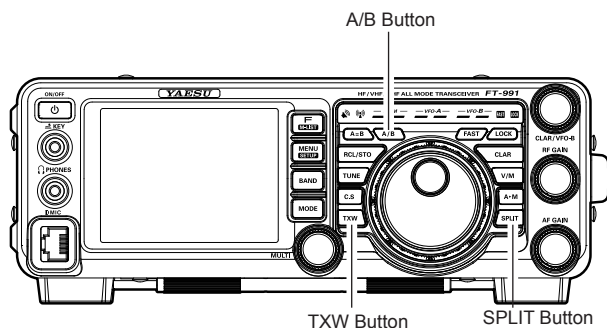

During Split operation, the VFO-A register will be used for reception, while the VFO-B register will be used for transmission. If you press the **SPLIT** button once more, Split operation will be cancelled.

ADVICE:

- During Split operation, pressing the **A/B** button will reverse the contents of VFO-A and VFO-B. Press the **A/B** button once more to return to the original frequency alignment.
 - During Split operation you may listen to the TX frequency temporarily while pressing the **TXW** button located on the bottom left of the Main Tuning Dial knob.
- While pressing the **TXW** button during split operations, the frequency of transmit on VFO-B can be changed.
- During Split operation it is also possible to set VFO-A and VFO-B to different Amateur bands if a multi band antenna is used.

Quick Split Operation

The Quick Split feature allows setting a one-touch offset of +5 kHz compared to the VFO-A frequency, to be applied to the transceiver VFO-B (transmit) frequency,

1. Start with regular transceiver operation on the VFO-A.
VFO-A RX Indicator: "ON" (LED glows Green)
VFO-A TX Indicator: "ON" (LED glows Red)
VFO-B RX Indicator: "OFF" (LED Off)
VFO-B TX Indicator: "OFF" (LED Off)
2. Press and hold in the **SPLIT** button for one second to engage the Quick Split feature, and apply a frequency 5 kHz above the VFO-A frequency to the VFO-B frequency register.
The VFO configuration will then be:
VFO-A RX Indicator: "ON" (LED glows Green)
VFO-A TX Indicator: "OFF" (LED Off)
VFO-B RX Indicator: "OFF" (LED Off)
VFO-B TX Indicator: "ON" (LED glows Red)
3. Press and hold in the **SPLIT** switch for one second to increment the Sub (VFO-B) offset frequency another +5 kHz.

QUICK POINTS:

- The offset of VFO-B from VFO-A is programmed via the Menu and is set to +5 kHz at the factory. However, other offsets may be selected using the following procedure:

~~~~~

1. Press the **MENU(SETUP)** button to engage the Menu mode.
2. Rotate the **MULTI** knob to select Menu item "035 QUICK SPLIT FREQ".
3. Touch [**SELECT**] on the LCD, then rotate the **MULT** knob to select the desired offset. The available setting range is -20kHz - +20kHz (factory default: +5 kHz).

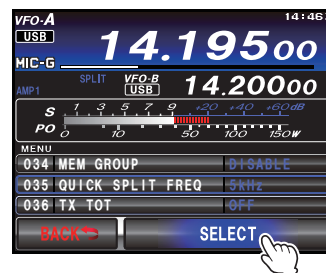

# TRANSMITTER CONVENIENCE FEATURES

## SPLIT-FREQUENCY OPERATION

4. Touch [ENTER] button to save the new setting.

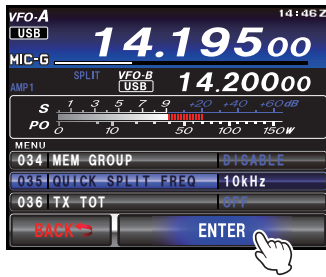

5. Press the **MENU(SETUP)** button or touch [BACK] on the LCD to exit to normal operation.

# CW MODE OPERATION

The powerful CW operating capabilities of the **FT-991** permit operation using an electronic keyer paddle, a “straight key”, or a computer-based keying device.

## SETUP FOR STRAIGHT KEY (AND STRAIGHT KEY EMULATION) OPERATION

Before starting, connect your key line(s) to the front panel **KEY** jack. Be sure **[BK-IN]** displayed by pressing the **F(M-LIST)** button is turned off for now.

1. Press the **MODE** button, then touch **[CW-LSB]** or **[CW-USB]** on the TFT LCD display. The “**C-L**” or “**C-U**” icon will appear in the display. The CW monitor is activated.

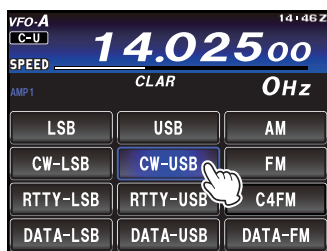

2. Rotate the Main Tuning Dial knob to select the desired operating frequency.
3. Press the **F(M-LIST)** button, then touch **[BK-IN]** on the LCD to engage automatic activation of the transmitter when you close the CW key. The Break-in will be set to “ON”.

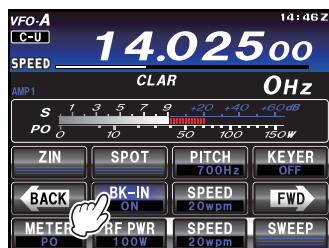

### ADVICE:

- ❑ When you close the CW key, the transmitter will automatically be activated, and the CW carrier will be transmitted. When you release the key, transmission will cease, and after a brief delay, receive will be restored. The delay time is user-programmable per the discussion on page 83.
  - ❑ As shipped from the factory, the **FT-991** TX/RX system for CW is configured for “Semi-break-in” operation. However, using Menu item “056 CW BK-IN TYPE”, you may change this setup for full break-in (QSK) operation, whereby the switching is quick enough to hear incoming signals in the spaces between the dots and dashes of your transmission. This may prove very useful during contest and traffic handling operations.
4. CW operation using the CW key may now proceed.

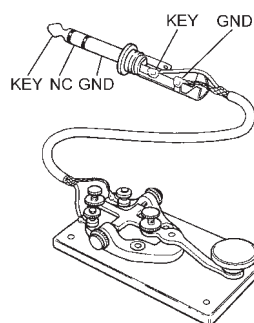
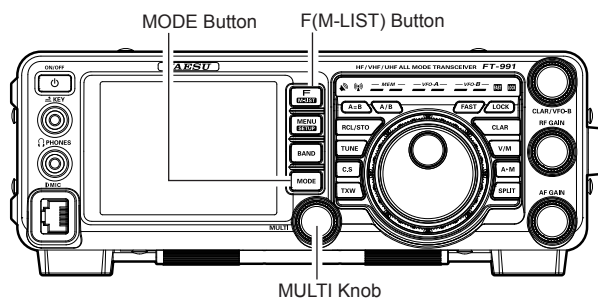

### ADVICE:

- ❑ The CW sidetone audio level may be adjusted by setting “MONITOR” (see page 72).
- ❑ You may practice sending CW listening to the sidetone only, without having the signal transmitted out over the air, if you press the front panel **F(M-LIST)** button to reveal the functions list on the TFT LCD display, and then touch the **[BK-IN]** button to set break-in to Off.
- ❑ If you reduce transmit power via the **[RF PWR]** function that may be displayed by pressing the **F(M-LIST)** button, the ALC meter reading will increase; this is normal and does not indicate any problem whatsoever (because increased ALC voltage is being used to lower the power).
- ❑ To enable the keying operation in LSB/USB mode and send the CW signal without switching to CW mode, change Menu item “055 CW AUTO MODE”.
- ❑ The same frequency may be displayed when switching between SSB mode and CW mode by setting Menu item “059 CW FREQ DISPLAY”.
- ❑ By connecting the **FT-991** to a computer, CW can be operated using free or commercially available software and setting Menu item “060 PC KEYING”.

---

## **SETUP FOR STRAIGHT KEY (AND STRAIGHT KEY EMULATION) OPERATION**

---

### **TERMINOLOGY:**

#### **Semi-break-in**

This is a pseudo-“VOX” mode used on CW, whereby the closure of the CW key will engage the transmitter, and release of the key will allow the receiver to recover after a short delay. No signals will be heard during the spaces between dots and dashes (unless the sending speed is extremely slow).

#### **Full break-in**

Full break-in (also known as “Full QSK”) involves very fast switching between transmit and receive, incoming signals may be heard between the dots and dashes as you send them. This allows you to hear a station that suddenly starts transmitting on your frequency, while you are in the midst of a transmission.

## USING THE BUILT-IN ELECTRONIC KEYS

Connect the cable from your keyer paddle to the front panel **KEY** jack.

1. Press the **MODE** button, then touch **[CW-LSB]** or **[CW-USB]** on the TFT LCD display. The “**C-L**” or “**C-U**” icon will appear in the display. The CW monitor is activated.

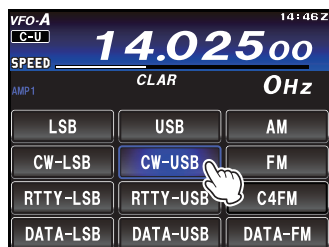

2. Rotate the Main Tuning Dial knob to select the desired operating frequency.
3. Press the **F(M-LIST)** button, then touch **[KEYER]** on the LCD to select “**ON**” to confirm that the built-in Electronic Keyer is now active.

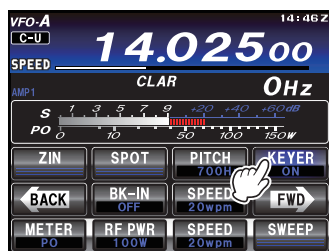

4. Touch **[SPEED]** on the LCD, then rotate the **MULTI** knob to set the desired sending speed (4 - 60 WPM).

### ADVICE:

- Rotate the **MULTI** knob to display the keying speed (4 - 60 WPM) below the **[SPEED]** indicator.
  - By pressing either the “Dot” or “Dash” side of the paddle, the CW keying tone will automatically be generated.
5. Touch **[BK-IN]** on the TFT display to engage automatic activation of the transmitter when either the “Dot” or “Dash” side of the paddle is pressed. The Break-in will be set to “**ON**”.

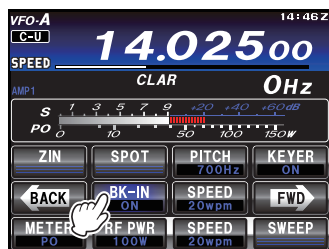

6. CW operation utilizing the CW paddle may now commence.

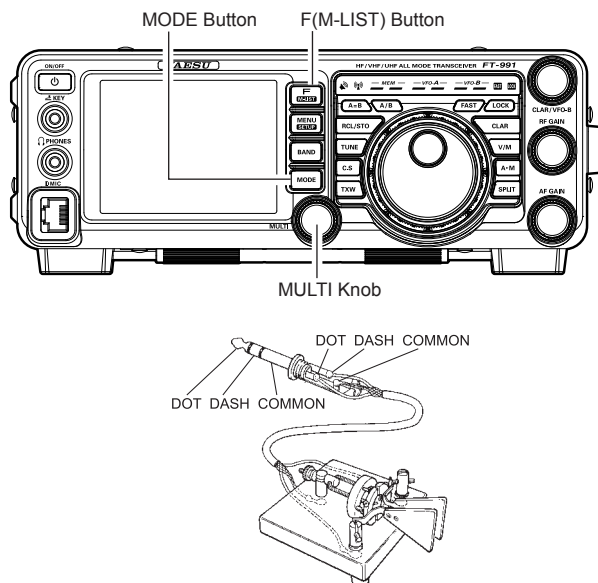

### ADVICE:

- When the keyer paddle is pressed, the transmitter will automatically be activated, and the CW characters (or a string of dots or dashes) will be transmitted. When the keyer paddle is released, transmission will cease, and after a brief delay, reception will be restored. The delay time is user-programmable, per the discussion on page 83.
- The CW sidetone audio level may be set using “**MONITOR**” (see page 72).
- If **[BK-IN]** is set to “**OFF**”, you may practice sending CW with the sidetone only, without having the signal go out over the air. (Press the front panel **F(M-LIST)** button to reveal the functions list on the TFT display).
- If the transmitter power is reduced via **[RF PWR]** function, the ALC meter reading will increase; this is normal and does not indicate any problem whatsoever (because increased ALC voltage is being used to lower the power).
- The keying operation may also be enabled in LSB/USB mode to send the CW signal via the Menu item “**055 CW AUTO MODE**” without switching to CW mode.
- The same frequency may be displayed when switching between SSB mode and CW mode by setting Menu item “**059 CW FREQ DISPLAY**”.
- By connecting a computer, CW can be operated using free or commercially available software and setting Menu item “**060 PC KEYING**”.
- The electronic keyer operation mode can be changed via the Menu item “**012 KEYS TYPE**”.

## USING THE BUILT-IN ELECTRONIC KEYS

### Full Break-in (QSK) Operation

As shipped from the factory, the **FT-991** TX/RX system for CW is configured for “Semi-break-in” operation. However, this setup may be changed to full break-in (QSK) operation by setting Menu item “056 CW BK-IN TYPE”. With full break-in QSK, the TX/RX switching is quick enough to hear incoming signals in the spaces between the dots and dashes of your transmission.

1. Press the **MENU(SETUP)** button to engage the Menu.
2. Rotate the **MULTI** knob to select Menu item “056 CW BK-IN TYPE”.
3. Press the [**SELECT**] button, and then rotate the **MULTI** knob to set this Menu item to “FULL”.

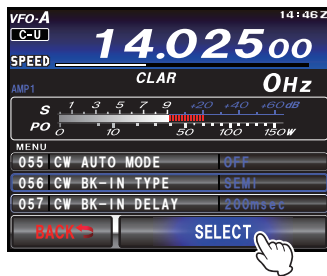

4. When the adjustments are complete, touch [**ENTER**] on the LCD to save the new setting.

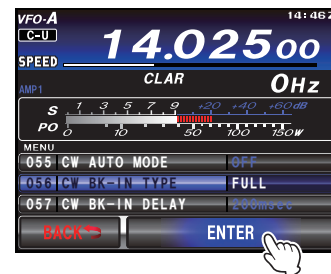
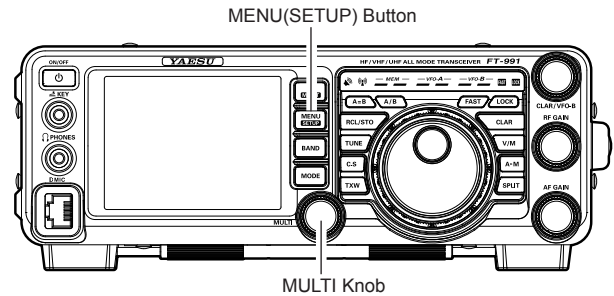

5. Press the **MENU(SETUP)** button or touch [**BACK**] on the LCD to exit to normal operation.

A number of interesting and useful features are available for use with the Electronic Keyer operation.

### Setting the Keyer Weight (Dot/Dash) Ratio

This Menu item may be used to adjust the dot/dash ratio for the built-in Electronic Keyer. The default weighting is 3:1 (a dash is three times longer than a dot).

1. Press the **MENU(SETUP)** button to engage the Menu.
2. Rotate the **MULTI** knob to select Menu item “014 CW WEIGHT”.
3. Touch the [**SELECT**] button, and then rotate the **MULTI** knob to set the weight to the desired value. The available adjustment range is a Dot/Dash ratio of 2.5 - 4.5 (default value: 3.0).

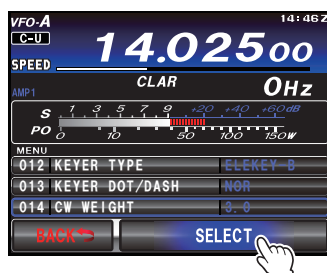

4. When your adjustments are complete, touch [**ENTER**] on the LCD to save the new setting.

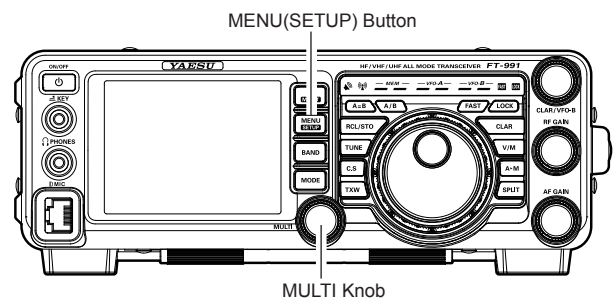

5. Press the **MENU(SETUP)** button or touch [**BACK**] on the LCD to exit to normal operation.



## USING THE BUILT-IN ELECTRONIC KEYS

### Selecting the Keyer Operating Mode

The configuration of the Electronic Keyer may be customized independently for the front panel **KEY** jack of the **FT-991**. This permits utilization of Automatic Character Spacing (ACS), if desired. This allows the use of an electronic keyer via the front jack and a straight key or computer-driven keying line via the rear panel jack.

1. Press the **MENU(SETUP)** button to engage the Menu.
2. Rotate the **MULTI** knob to select Menu item "012 KEYSER TYPE".

3. Press the [**SELECT**] button, and then rotate the **MULTI** knob to set the keyer to the desired mode. The available selections are:

**OFF:** The built-in Electronic Keyer is turned off ("straight key" mode).

**BUG:** Dots will be generated automatically by the keyer, but dashes must be sent manually.

**ELEKEY-A:** A code element ("Dot" or "Dash" side) is transmitted upon releasing both sides of the paddle.

**ELEKEY-B:** Releasing both sides of the paddle transmits the currently generated "Dash" side followed by "Dot" side (or reverse order).

**ELEKEY-Y:** Pressing both sides of the paddle transmits the currently generated "Dash" side followed by "Dot" side (or reverse order).

While transmitting the "Dash" side, the first transmitted "Dot" side will not be stored.

**ACS:** Same as "ELEKEY" except that the spacing between characters is precisely set by the keyer to be the same length as a dash (three dots in length).

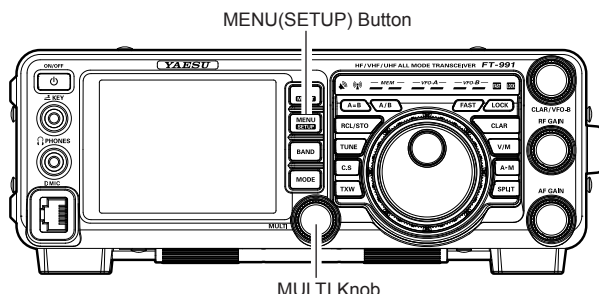

**ACS OFF**

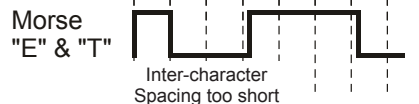

**ACS ON**



4. When the adjustments are complete, touch [**ENTER**] on the LCD to save the new setting.

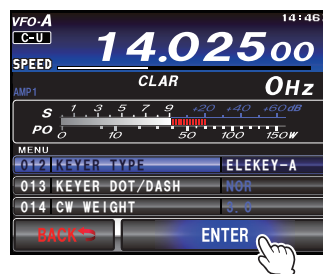

5. Press the **MENU(SETUP)** button or touch [**BACK**] on the LCD to exit to normal operation.

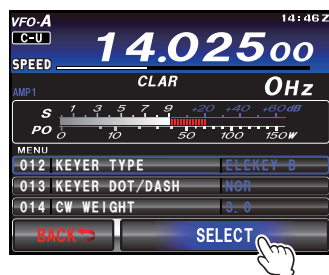



## USING THE BUILT-IN ELECTRONIC KEYS

### Reversing the Keyer Polarity

For left-handed operators in a contest, for example, the polarity can be reversed easily in the Menu mode without changing the keyer connection (the default setting is “NOR”).

1. Press the **MENU(SETUP)** button to engage the Menu.
2. Rotate the **MULTI** knob to select Menu item “013 KEYS DOT/DASH”.
3. Press the [**SELECT**] button, then rotate the **MULTI** knob to select “REV.”



4. Touch [**ENTER**] on the LCD to save the new setting.

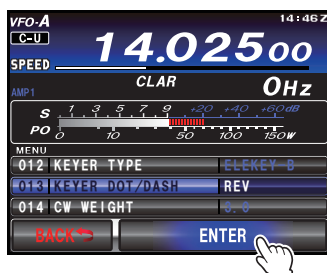

5. Press the **MENU(SETUP)** button or touch [**BACK**] on the LCD to exit to normal operation.

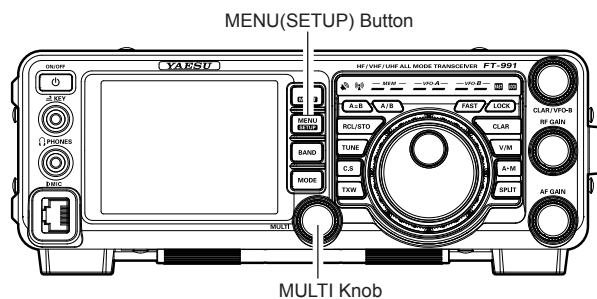

### ADVICE:

- In the steps on the left, only polarities of the ELEKEY and ACS keys can be changed.

# CW CONVENIENCE FEATURES

## CW SPOTTING (ZERO-BEATING)

“Spotting” (zeroing in on a received CW station) is a handy technique to ensure you and the other station are precisely on the same frequency.

The Tuning Offset Indicator in the display may also be observed so you can adjust the receiver frequency to center the incoming station on the pitch corresponding to that of your transmitted signal.

### Using the Auto Zeroing System

Press the **F(M-LIST)** button, then touch **[ZIN]** on the LCD to cause the receiving frequency to zero-in automatically while receiving the CW signal.

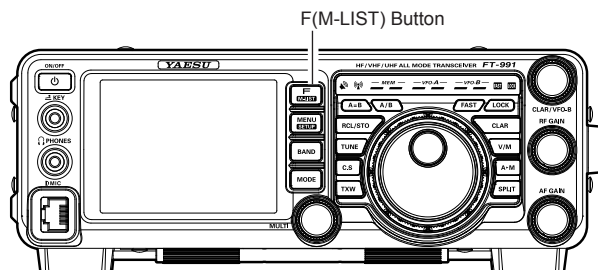

### Using the SPOT System

1. Press the **F(M-LIST)** button to display the function list.
2. Touch **[MONI]** on the LCD. The Monitor function will be set to “ON”. The **MULTI** knob will function as the MONITOR adjustment knob.

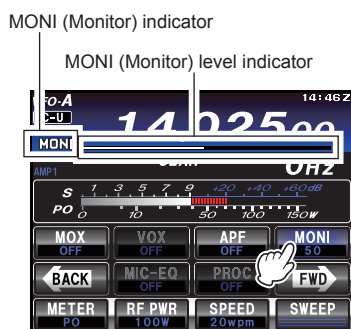

3. Touch **[SPOT]** on the LCD. While you are pressing and holding **[SPOT]**, the tone is output from the speaker.

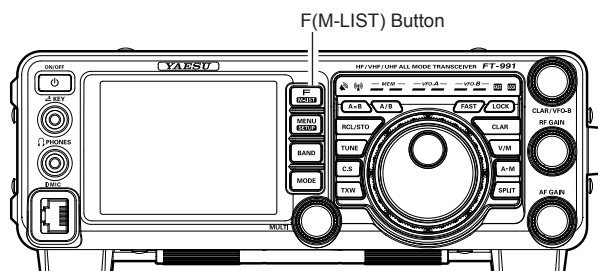
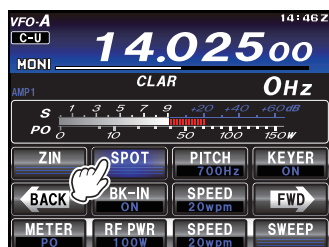

### ADVICE:

- In a tough DX pile-up, you may actually want to use the SPOT system to find a “gap” in the spread of calling stations, instead of zeroing in precisely on the last station being worked by the DX station. From the DX side, if a dozen or more operators (also using Yaesu’s SPOT system) all call precisely on the same frequency, their dots and dashes merge into a single, long tone that the DX station cannot decipher. In such situations, calling slightly higher or lower in frequency may get your call through.

### QUICK POINTS:

- The displayed frequency on CW normally reflects the “zero beat” frequency of your offset carrier. That is, if you were to listen on USB on 14.100.00 MHz to a signal with a 700 Hz offset, the “zero beat” frequency of that CW carrier would be 14.100.70 MHz; the latter frequency is what the **FT-991** displays, by default. However, you can change the display to be identical to what you would see on SSB by using Menu item “059 CW FREQ DISPLAY” and setting it to “DIRECT FREQ” instead of the default “PITCH OFFSET” setting.

# CW CONVENIENCE FEATURES

## CW DELAY TIME SETTING

During semi-break-in (not QSK) operation, the hang time of the transmitter, after you have finished sending, may be adjusted to a comfortable value consistent with your sending speed. This is the functional equivalent of the “VOX Delay” adjustment used on voice modes, and the delay may be varied anywhere between 30 msec and 3 seconds via Menu item “057 CW BK-IN DELAY”.

1. Press the **F(M-LIST)** button to display the function list, then touch **[BK-IN]** on the LCD to enable CW transmission (Menu item “056 CW BK-IN TYPE” must be set to “SEMI”).

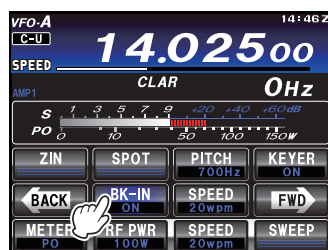

2. Press the **MENU(SETUP)** button to enter the Menu mode.
3. Rotate the **MULTI** knob to select Menu item “057 CW BK-IN DELAY”, then touch **[SELECT]** on the LCD.

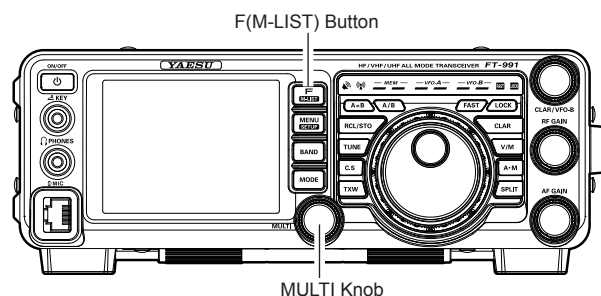
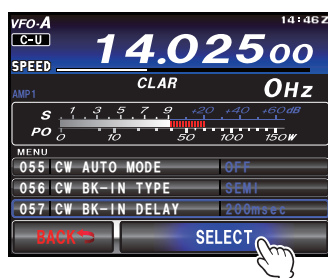

4. Start sending and rotate the **MULTI** knob to adjust the hang time, as you prefer for comfortable operation.
5. When the adjustments are complete, touch **[ENTER]** on the LCD to save the new setting.



6. Press the **MENU(SETUP)** button or touch **[BACK]** on the LCD to exit to normal operation.

## CW PITCH ADJUSTMENT

The center frequency of the receiver passband may be adjusted to the CW tone you prefer. By touching **[PITCH]** on the LCD, the pitch of the CW offset carrier may be varied between 300 Hz and 1050 Hz, in 10 Hz steps.

1. Press the **F(M-LIST)** button to display the function list, then touch **[PITCH]** on the LCD. The **MULTI** knob functions as the PITCH adjustment knob.

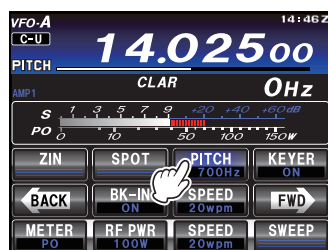

2. Rotate the **MULTI** knob to adjust the PITCH (300 Hz to 1,050 Hz).

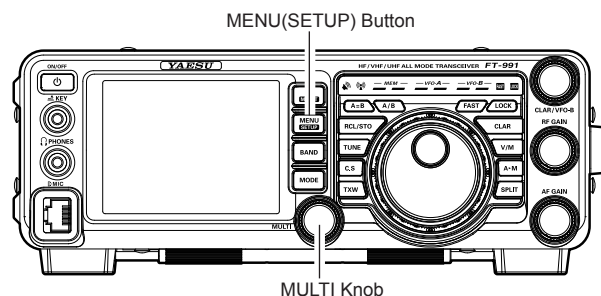

### TERMINOLOGY:

**CW Pitch:** If the receiver is tuned to an exact “zero beat” on an incoming CW signal, you could not copy it (“Zero beat” implies a 0 Hz tone). Therefore, the receiver is offset several hundreds of Hz (typically), to produce a beat tone that can be heard. The BFO offset associated with this tuning (that produces the comfortable audio tone) is called the CW Pitch.



## CONTEST MEMORY KEYS

### Contest Number Programming

Use this process if you are starting a contest, or if you somehow get out of sync with the proper number in the middle of a contest.

1. Press the **MENU(SETUP)** button to enter the Menu mode.
2. Rotate the **MULTI** knob to select Menu item “017 CONTEST NUMBER”. The current contest number appears on the TFT display.
3. Touch [**SELECT**] on the LCD, then rotate the **MULTI** knob to set the Contest Number to the desired value.

**ADVICE:**

Touch [**BACK**] on the LCD to cancel the setting.

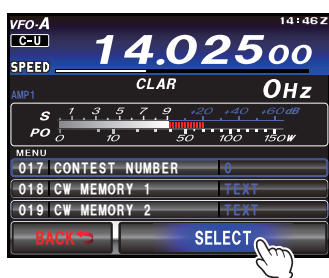
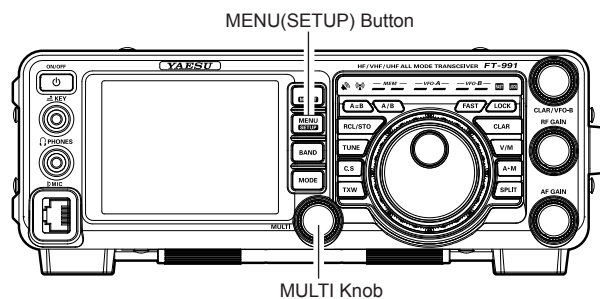

4. Touch [**ENTER**] on the LCD to save the new setting.

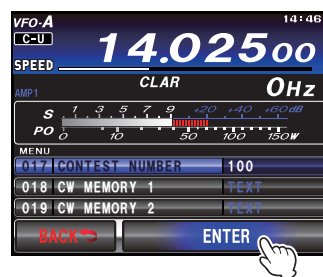

5. Press the **MENU(SETUP)** button or touch [**BACK**] on the LCD to exit to normal operation.

# CW CONVENIENCE FEATURES

## CONTEST MEMORY KEYS

### MESSAGE MEMORY PROGRAMMING (USING YOUR PADDLE)

1. Set the operating mode to CW.
2. Set **[BK-IN]** on the LCD to “Off”.
3. Set **[KEYER]** on the LCD to “On”.
4. Touch **[MEM]** on the LCD or press the **[MEM]** key on the **FH-2**. A blinking “**REC**” icon will appear in the display.

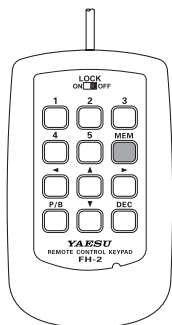
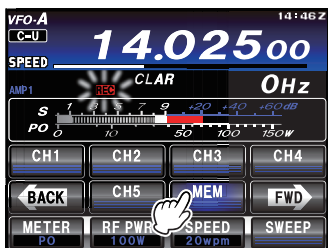

5. Touch **[CH1]** through **[CH5]** on the LCD or press any of the **FH-2** keys numbered **[1]** through **[5]** to begin the memory storage process, and the “**REC**” icon will glow steadily.

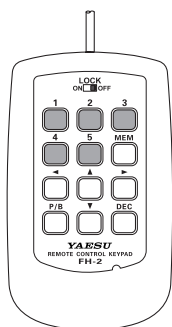
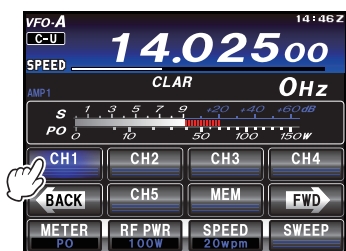

6. Send the desired message using your keyer paddle.

#### ADVICE:

If you do not start keying within ten seconds, the memory storage process will be cancelled.

7. Touch **[MEM]** on the LCD or press the **[MEM]** key on the **FH-2** once more at the end of your message. Up to 50 characters may be stored in each of the five memories.

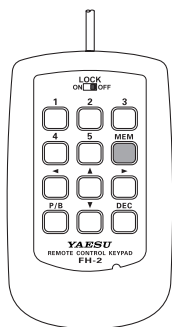
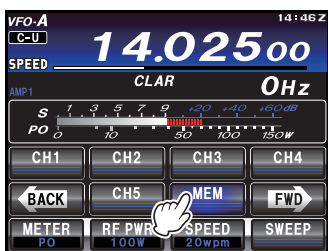

#### NOTE:

Care must be exercised when sending to ensure that the spaces between letters and words are accurately done; if the timing is off, the spacing may not come out right in the stored message. For ease in setting up the keyer memories, we recommend setting Menu item “012 KEYER TYPE” to “ACS” (Automatic Character Spacing) while programming the keyer memories.

### CHECKING THE CW MEMORY CONTENTS

1. Be sure that Break-in is still turned “Off” by **[BK-IN]** on the LCD.
2. Touch **[MONI]** on the LCD to enable the CW monitor.
3. Touch **[CH1]** - **[CH5]** on the LCD or press the **FH-2** **[1]** - **[5]** key, whichever memory you just recorded in. You will hear the message played in the sidetone monitor, but no RF energy will be transmitted.

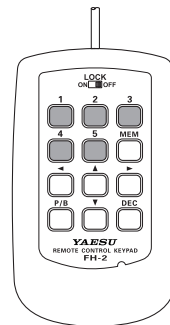
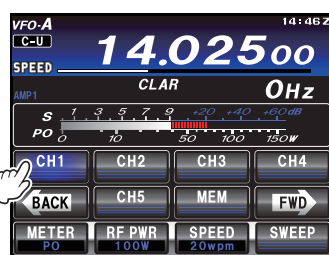

### ON-THE-AIR CW MESSAGE PLAYBACK

1. Touch **[BK-IN]** on the LCD to enable transmission. Either Full- or Semi-break-in will be engaged, depending on the setting of Menu item “056 CW BK-IN TYPE”.
2. Touch **[CH1]** - **[CH5]** on the LCD or press the **FH-2** **[1]** - **[5]** key, depending on which CW Memory Register message you wish to transmit. The programmed message will be transmitted on the air.

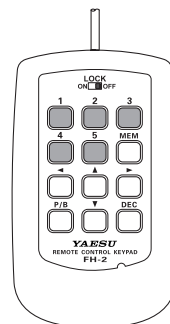
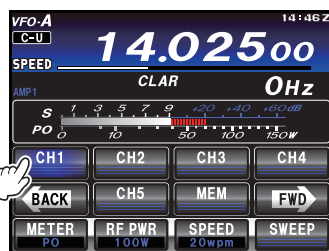

#### NOTE:

If you subsequently decide to use the “Text Memory” technique for memory storage, please note that a message stored using keyer paddle input will not be transferred over when you select “Text Memory technique” on a particular memory register (the Menu Mode Setting is set to “TEXT”).



# CW CONVENIENCE FEATURES

## CONTEST MEMORY KEYS

### TEXT Memory

The five channels of CW message memory (up to 50 characters each) may also be programmed using a text-entry technique. This technique is somewhat slower than sending message directly from the keyer paddle, but accuracy of character spacing is ensured. Be sure to enter the character “}” at the end of the text message.

**Example 1:** CQ CQ CQ DE W6DXC K} (20 characters)

The sequential Contest Number (“Count up”) feature is another powerful feature of the CW Memory Keyer.

**Example 2:** 599 10 200 # K} (15 characters)

### TEXT MEMORY STORAGE

1. Press the **MENU(SETUP)** button to enter the Menu mode.
2. Rotate the **MULTI** knob to select the CW Memory Register into which you wish to store the message; we are now setting the message entry technique to (Text entry).

018 CW MEMORY 1  
 019 CW MEMORY 2  
 020 CW MEMORY 3  
 021 CW MEMORY 4  
 022 CW MEMORY 5

#### ADVICE:

The following texts are programmed to the MEMORY 4 and MEMORY 5 in factory default.

MEMORY 4: DE FT-991 K}  
 MEMORY 5: R 5NN K}

3. Touch [**SELECT**] on the LCD, then rotate the **MULTI** knob to set the selected CW Memory Register to “TEXT”. If you want to use text message entry on all memories, set all five Menu items (#018 - 022) to “TEXT”.
4. Touch [**ENTER**] on the LCD to save the new setting.
5. Press the **MENU(SETUP)** button or touch [**BACK**] on the LCD to exit to normal operation.

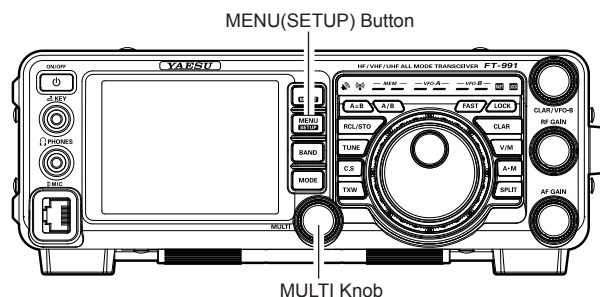

| TEXT | CW CODE | TEXT | CW CODE | TEXT | CW CODE | TEXT | CW CODE | TEXT | CW CODE | TEXT | CW CODE |
|------|---------|------|---------|------|---------|------|---------|------|---------|------|---------|
| !    | SN̄     | &    | AS̄     | +    | AR̄     | :    | OS̄     | ?    | IMĪ    | ^    | —       |
| ”    | AF̄     | ’    | WḠ     | ,    | MIM̄    | ;    | KR̄     | @    | @       | _    | IQ̄     |
| #    | —       | (    | KN̄     | -    | DŪ     | <    | —       | [    | —       | }    | —       |
| \$   | SX̄     | )    | KK̄     | .    | AAĀ    | =    | BT̄     | ¥(\) | AL̄     |      |         |
| %    | KĀ     | *    | —       | /    | DN̄     | >    | —       | }    | —       |      |         |



# CW CONVENIENCE FEATURES

## CONTEST MEMORY KEYS

### TEXT MESSAGE PROGRAMMING

1. Press the **MODE** button to set the operating mode to CW.
2. Be sure that Break-in is “Off” with **[BK-IN]** on the LCD, if necessary.
3. Touch **[MEM]** on the LCD or press the **FH-2 [MEM]** key. A blinking “REC” icon will appear in the display.

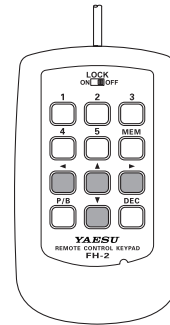
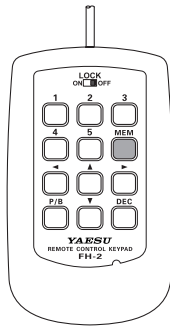
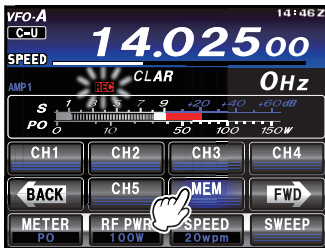

4. Touch **[CH1] - [CH5]** on the LCD or press an **FH-2 [1] - [5]** key to select the desired CW Memory Register into which you wish to program the text. The text input screen will appear.

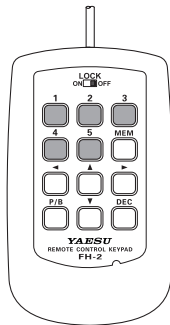
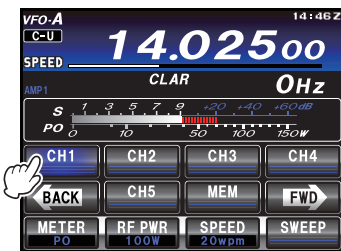

5. Touch a key on the LCD to enter the letters, numbers, or symbols of the desired label.
6. Repeat step 5 to program the remaining letters, numbers, or symbols of the desired text. 12 characters may be used in the creation of a text.  
Use **[←]** and **[→]** on the LCD to set the cursor position and **[✕]** on the LCD to erase a letter at the left of the cursor.
7. When you have completed the creation of the text, touch **[ENT]** on the LCD.



### ADVICE:

Use the **FH-2 [←]** and **[→]** keys to set the cursor position and use the **FH-2's [▲]** and **[▼]** keys to choose the letter/number to be programmed in each slot of the memory. In the case of the second example on the previous page the “#” character designates the slot where the Contest Number will appear.

8. When the message is complete, add the “}” character at the end to signify the termination of the message.
9. Touch **[MEM]** on the LCD or press and hold in the **FH-2 [MEM]** key for one second to exit, once all characters (including “}”) have been programmed.

### CHECKING THE CW MEMORY CONTENTS

1. Be sure that Break-in is still turned “Off” with **[BK-IN]** on the LCD.
2. Touch **[MONI]** on the LCD to enable the CW monitor.
3. Touch **[CH1] - [CH5]** on the LCD or press an **FH-2 [1] - [5]** key, whichever memory you just recorded in. You will hear the results in the sidetone, but no RF energy will be transmitted.

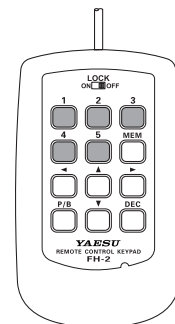
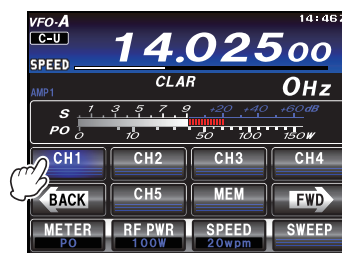

## CONTEST MEMORY KEYS

### Inputting the CW TEXT directly on the screen

Without using the remote control keypad **FH-2**, you can also input the CW TEXT directly on the screen.

1. Press and hold the **MENU(SETUP)** button.
2. Touch [**CW TEXT**] on the LCD. The CW text display screen will appear.

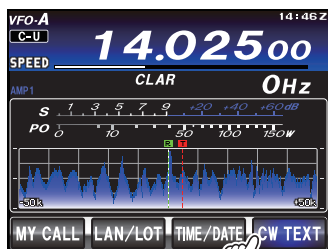

3. Rotate the **MULTI** knob to select the CW TEXT you want to input, then touch [**EDIT**]. The text input screen will appear.



4. Touch a key on the LCD to enter the letters, numbers, or symbols of the desired text.



5. Repeat step 4 to program the remaining letters, numbers, or symbols of the desired text. 12 characters may be used in the creation of a text. Use [**←**] and [**→**] on the LCD to set the cursor position and [**✕**] on the LCD to erase a letter at the left of the cursor.
6. When you have completed the creation of the text, touch [**ENT**] on the LCD.

7. Press the **MENU(SETUP)** button to save the new setting and return to normal operation.

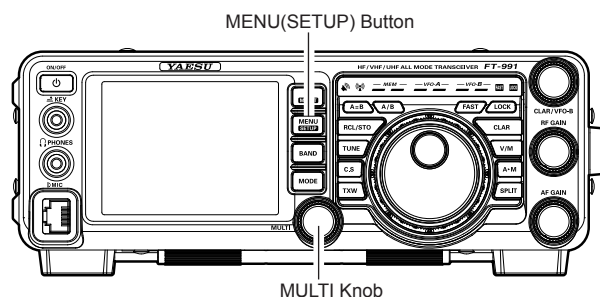

# CW CONVENIENCE FEATURES

## CONTEST MEMORY KEYER

### ON-THE-AIR CW MESSAGE PLAYBACK

1. Touch **[BK-IN]** on the LCD to enable transmission. Either Full-break-in or Semi-break-in will be engaged, depending on the setting of Menu item “056 CW BK-IN TYPE”.
2. Touch **[CH1]** - **[CH5]** on the LCD or press an **FH-2 [1]** - **[5]** key, depending on which CW Memory Register message you wish to transmit. The programmed message will be transmitted on the air.

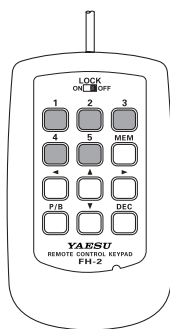
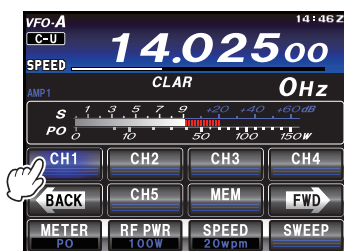

### NOTE:

If you subsequently decide to use the “Message Memory” technique for memory storage, please note that the contents of a message stored using text input will not be transferred over when you set entry to “Message Memory technique” on a particular memory register (the Menu Mode Setting is set to “MESSAGE”).

### Decrementing the Contest Number

Use this process if the current contest number gets slightly ahead of the actual number you want to send (in case of a duplicate QSO, for example).

Press the **FH-2 [DEC]** key momentarily. The current Contest Number will be reduced by one. Press of the **FH-2 [DEC]** key as many times as necessary to reach the desired number. If you go too far, use the “Contest Number Programming” technique described previously.

### Transmitting in the Beacon Mode

In “Beacon” mode, it is possible to repeatedly transmit any message programmed, either via paddle input, or via the “Text” input method. The time delay between message repeats may be set anywhere between 1 and 690 seconds (1 - 240 sec (1 sec/step) or 270 - 690 sec (30 sec/step)) via Menu item “015 BEACON INTERVAL” If you do not wish the message to repeat in a “Beacon” mode, please set this Menu item to “OFF”.

To transmit the message:

1. Touch **[BK-IN]** on the LCD to enable transmission. Either Full-break-in or Semi-break-in will be engaged, depending on the setting of Menu item “056 CW BK-IN TYPE”.
2. Touch **[CH1]** - **[CH5]** on the LCD or press an **FH-2 [1]** - **[5]** key. Repetitive transmission of the Beacon message will begin.

## BASIC OPERATION

1. Press the **MODE** button, then touch the corresponding key on the LCD to select the FM operating mode. The “**FM**” icon appears in the display.

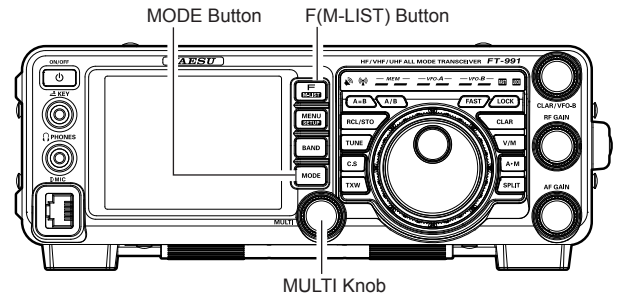
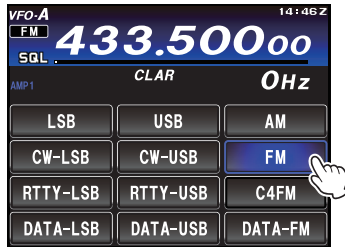

2. Set the transceiver to the desired frequency.
3. Press the microphone **PTT** switch to transmit. Speak into the microphone in a normal voice level. Release the **PTT** switch to return to receive.

**ADVICE:**

The **MULTI** knob can serve as the frequency setting knob.

To change the **MULTI** knob frequency step, follow the below procedure:

Press the **F(M-LIST)** button, then touch [**CH DIAL**] on the TFT display. Rotate the **MULTI** knob or touch [**CH DIAL**] repeatedly to select the frequency steps in the following order.

You can also switch the frequency steps by touching [**CH DIAL**] repeatedly.

“2.5kHz” → “5kHz” → “9kHz” → “10kHz”  
 → “12.5kHz” → “25kHz” → “2.5kHz”

4. Adjustment of the microphone gain may be accomplished in two ways. At the factory, a default level has been programmed that should be satisfactory for most situations. To change the microphone gain, press the **F(M-LIST)** button, then touch [**MIC GAIN**] on the LCD. Rotate the **MULTI** knob function as the microphone gain adjustment knob. Rotate the **MULTI** knob to adjust the microphone gain.

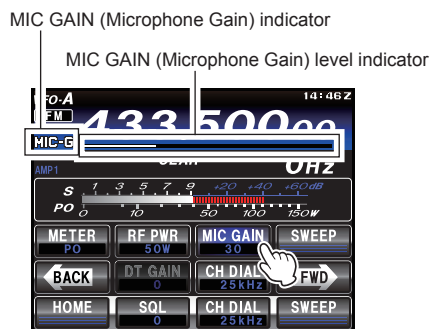

**ADVICE:**

- FM is only used in the 28 MHz, 50 MHz, 144 MHz and 430 MHz Amateur bands covered by the **FT-991**. Please do not use FM on any other bands.

# FM MODE OPERATION

## REPEATER OPERATION

The **FT-991** may be utilized on 29 MHz, 50 MHz, 144 MHz and 430 MHz repeaters.

1. Rotate the Main Tuning Dial knob to set the **FT-991** to the desired repeater's output frequency (downlink from the repeater).
2. If CTCSS Tone operation is desired/needed, press the **F(M-LIST)** button, then touch **[TONE/DCS]** on the LCD to engage the CTCSS mode.

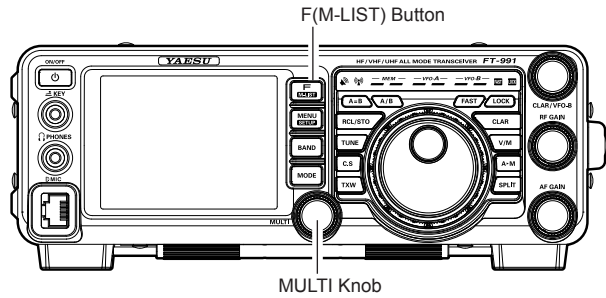

3. Touch **[TONE/DCS]** on the LCD repeatedly to select the desired CTCSS mode. If the repeater requires an uplink encoding tone, select "ENC." For both uplink and downlink encode/decode operation, choose "CTCSS". The available choices are:  
 "OFF" → "ENC (Tone Encoder)"  
 → "CTCSS (Tone Squelch)"  
 → "DCS (Digital Code Squelch)" → "OFF"
4. Touch **[RPT]** repeatedly on the LCD to select the desired repeater shift direction. The selections are:  
 "SIMP" → "+" → "-" → "SIMP"  
 where "SIMP" represents "Simplex" operation (not used on a repeater).



5. Touch **[FWD]** to switch the display screen, and then touch **[TONE]**. Rotate the **MULTI** knob to select the desired CTCSS Tone to be used. A total of 50 standard CTCSS tones are provided (see the CTCSS Tone Chart).



| CTCSS TONE FREQUENCY (Hz) |       |       |       |       |       |       |       |
|---------------------------|-------|-------|-------|-------|-------|-------|-------|
| 67.0                      | 69.3  | 71.9  | 74.4  | 77.0  | 79.7  | 82.5  | 85.4  |
| 88.5                      | 91.5  | 94.8  | 97.4  | 100.0 | 103.5 | 107.2 | 110.9 |
| 114.8                     | 118.8 | 123.0 | 127.3 | 131.8 | 136.5 | 141.3 | 146.2 |
| 151.4                     | 156.7 | 159.8 | 162.2 | 165.5 | 167.9 | 171.3 | 173.8 |
| 177.3                     | 179.9 | 183.5 | 186.2 | 189.9 | 192.8 | 196.6 | 199.5 |
| 203.5                     | 206.5 | 210.7 | 218.1 | 225.7 | 229.1 | 233.6 | 241.8 |
| 250.3                     | 254.1 | -     | -     | -     | -     | -     | -     |

6. Press and hold the microphone **PTT** switch to begin transmission. You will observe that the frequency has shifted to correspond to the programming set up in the previous steps. Speak into the microphone in a normal voice level. Release the **PTT** switch to return to the receive mode.

### ADVICE:

- ❑ The conventional repeater shift used on 29 MHz is 100 kHz, while on the 50 MHz band the shift may vary between 500 kHz and 1.7 MHz (or more). On the 144 MHz band, the shift will be 600 kHz; on the 430 MHz band, the shift will be 1.6 MHz or 7.6 MHz (5 MHz for the U.S.A. version). To program the proper repeater shift, use Menu items "080 RPT SHIFT 28MHz" (28 MHz), "081 RPT SHIFT 50MHz" (50 MHz), "082 RPT SHIFT 144MHz" (144 MHz), and "083 RPT SHIFT 430MHz" (430 MHz) as appropriate.
- ❑ Press the **F(M-LIST)** button, then touch **[REV]** on the LCD to reverse the transmission and reception frequencies temporarily to check whether direct communication with the partner station is possible. When reversing the frequencies, + or - will flash. When **[REV]** is touched one more time, the reverse is cancelled.

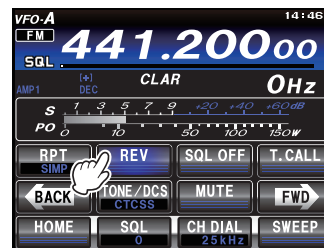

## REPEATER OPERATION

### Automatic Repeater Shift (ARS)

The **FT-991** ARS feature causes the appropriate repeater shift to be automatically applied whenever it is tuned into the designated repeater sub-bands.

If the ARS feature does not appear to be working, you may have accidentally disabled it.

To re-enable ARS:

1. Press the **MENU(SETUP)** button to enter the Menu mode.
2. To use the ARS function at 144 MHz, select “084 ARS 144MHz”. To use the ARS function at 430 MHz, select “085 ARS 430MHz” by rotating the **MULTI** knob.
3. Touch [**SELECT**] on the LCD, then rotate the **MULTI** knob to set this Menu item to “ON”.

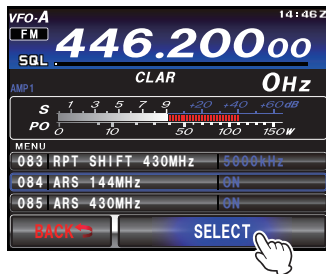
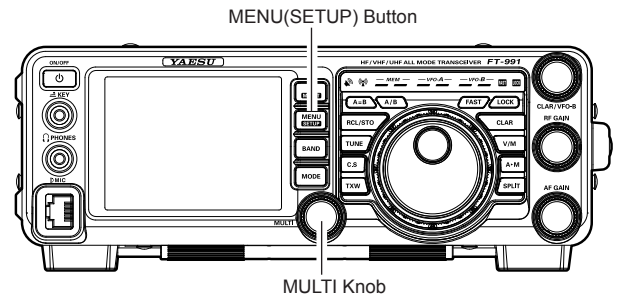

4. Touch [**ENTER**] on the LCD to save the new setting.
5. Press the **MENU(SETUP)** button or touch [**BACK**] on the LCD to exit to normal operation.

### Tone Calling (1750 Hz)

Press the **F(M-LIST)** button to display the function list, then touch [**T.CALL**] on the LCD. While you are pressing and holding [**T.CALL**] to generate a 1750 Hz burst tone to access the repeater. The transmitter will automatically be activated, and a 1750 Hz audio tone will be superimposed on the carrier. Once access to the repeater has been gained, you may release the [**T.CALL**], and use the **PTT** switch for activating the transmitter thereafter.

# FM MODE OPERATION

## TONE SQUELCH OPERATION

The “Tone Squelch” may be activated to keep the receiver silent until an incoming signal modulated with a matching CTCSS tone is received. The receiver squelch will then open in response to the reception of the required tone.

1. Press the **MODE** button, and then touch the corresponding key on the LCD to select the FM operating mode. The “**FM**” icon appears in the display.
2. Set the transceiver to the desired frequency.
3. If CTCSS Tone operation is desired/needed, press the **F(M-LIST)** button, then touch [**TONE/DCS**] on the LCD to engage the CTCSS mode.

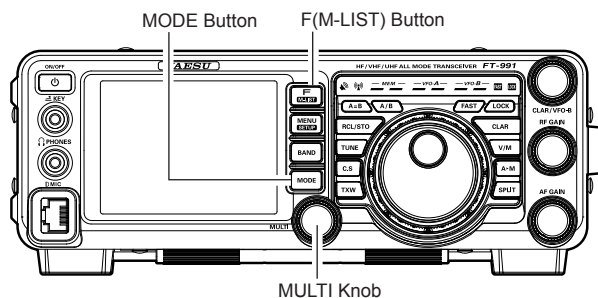

| CTCSS TONE FREQUENCY (Hz) |       |       |       |       |       |       |       |
|---------------------------|-------|-------|-------|-------|-------|-------|-------|
| 67.0                      | 69.3  | 71.9  | 74.4  | 77.0  | 79.7  | 82.5  | 85.4  |
| 88.5                      | 91.5  | 94.8  | 97.4  | 100.0 | 103.5 | 107.2 | 110.9 |
| 114.8                     | 118.8 | 123.0 | 127.3 | 131.8 | 136.5 | 141.3 | 146.2 |
| 151.4                     | 156.7 | 159.8 | 162.2 | 165.5 | 167.9 | 171.3 | 173.8 |
| 177.3                     | 179.9 | 183.5 | 186.2 | 189.9 | 192.8 | 196.6 | 199.5 |
| 203.5                     | 206.5 | 210.7 | 218.1 | 225.7 | 229.1 | 233.6 | 241.8 |
| 250.3                     | 254.1 | -     | -     | -     | -     | -     | -     |

4. Touch [**TONE/DCS**] on the LCD repeatedly to choose “CTCSS” from the available choices of “OFF” → “ENC (Tone Encoder)” → “CTCSS (Tone Squelch)” → “DCS (Digital Code Squelch)” → “OFF”
5. Touch [**FWD**] to switch the screen, and then touch [**TONE**]. Rotate the **MULTI** knob to select the desired CTCSS Tone to be used. A total of 50 standard CTCSS tones are provided (see the CTCSS Tone Chart).

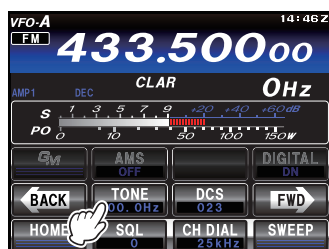



# C4FM Mode (Digital Mode) Operation

The **FT-991** transceiver is capable of using 2, C4FM digital modes: the “V/D mode” which communicates voice and data simultaneously, and the “Voice FR mode” which transmits digital voice data using the full 12.5 kHz bandwidth.

1. Press the **MODE** button, and then touch the corresponding key on the LCD to select the C4FM operating mode. The “**C4FM**” icon appears in the display.

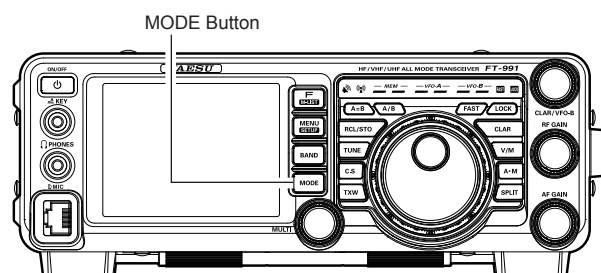
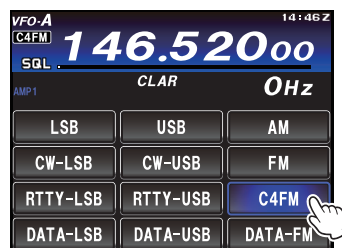

2. Set the transceiver to the desired operating frequency.

**ADVICE:**

The VFO-A frequency can be changed by rotating the Main Tuning Dial knob or using one of the following methods. For details, see page 42.

- Setting the frequency directly using the number keys.
- Setting the frequency by rotating the **MULTI** knob.
- Setting the frequency using the **UP/DWN** buttons on the microphone.

3. Press and hold the **PTT** button on the microphone (or touch the [**MOX**] on the LCD) to change the transceiver to transmit mode, then speak into the microphone.

Release the **PTT** button (or touch the [**MOX**] again if you pressed [**MOX**] to enter the transmit mode) to change the transceiver back to the receive mode.

**ADVICE:**

- Digital communication mode can be switched between V/D mode and FR mode (see “Toggling to the Digital Communication Mode” on page 39).
- The AMS (Automatic Mode Select) function enables the transceiver to select the appropriate communication mode according to the received signal. Using the AMS function, the transceiver recognizes either analog (FM) or C4FM digital signals and automatically changes to the same communication mode as the contact station.

**NOTE:**

- When communicating in V/D mode (“DN” is displayed on the LCD), the station location information is contained within the transmitted digital signal. In Voice FR mode (“VV” is displayed on the LCD), the location information is not included in the transmitted signals.

# C4FM Mode (Digital Mode) Operation

## Notification When the Contact Station Completes a Transmission (Standby Bep Function)

When communicating in C4FM mode, an audible beep sounds to indicate that the contact station has completed a transmission (Standby Bep function).

To change the Standby Bep function “ON/OFF”, follow the procedure below.

1. Press the **MENU(SETUP)** button to enter the Menu mode.
2. Rotate the **MULTI** knob to select Menu item “093 STANDBY BEEP”.
3. Touch **[SELECT]** on the LCD, then rotate the **MULTI** knob to set this Menu item to “ON” or “OFF” (the default setting is “ON”).

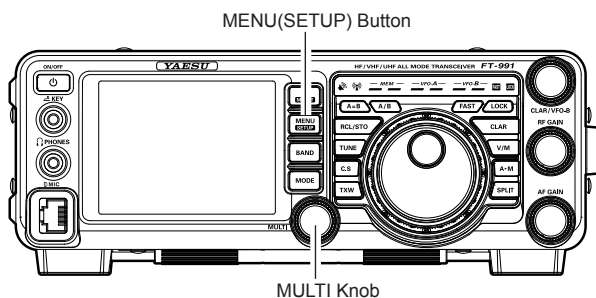
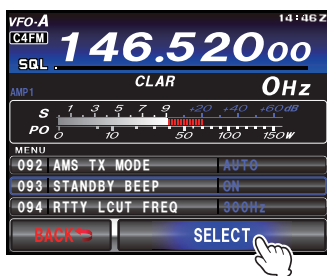

4. Touch **[ENTER]** on the LCD to save the new setting.



5. Press the **MENU(SETUP)** button or touch **[BACK]** on the LCD to exit to normal operation.

## CONVENIENT MEMORY FUNCTIONS

The **FT-991** contains ninety-nine regular memories, labeled “01” through “99”, nine special programmed band edge memory pairs, labeled “P-1L/P-1U” through “P-9L/P-9U”, and five QMB (Quick Memory Bank) memories. Each memory stores various settings, in addition to the VFO-A frequency and mode (See below). By default, the 99 regular memories are contained in one group; however, they can be arranged in up to six separate groups, if desired.

### QUICK POINT:

The **FT-991** memory channels store the following data (not just the operating frequency):

- VFO-A Frequency
- VFO-A Mode
- Clarifier status and its Offset Frequency
- IPO status
- Attenuator status
- Noise Blanker status
- IF SHIFT and WIDTH status
- CONTOUR status and its Peak Frequency
- DSP Noise Reduction (DNR) status and its Reduction algorithm selection.
- DSP Notch filter (NOTCH) status
- NAR bandwidth status
- DSP Auto Notch filter (DNF) status
- Repeater Shift Direction

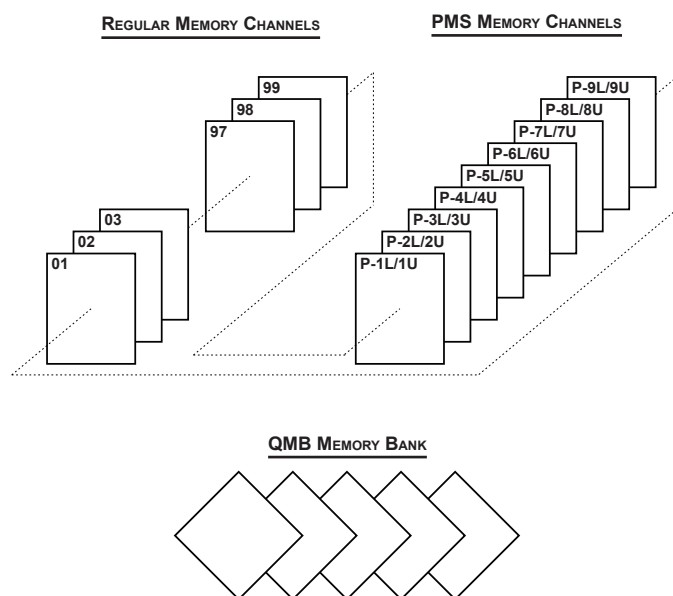

## QMB (QUICK MEMORY BANK)

The Quick Memory Bank consists of five memories independent from the regular and PMS memories. The QMB memories can quickly store operating parameters for later recall.

### QMB Channel Storage

1. Tune to the desired frequency on VFO-A.
2. Press and hold the **RCL/STO** button for one second. The “beep” will confirm that the VFO-A contents have been written to the currently available QMB memory.

Repeated one second presses of the **RCL/STO** button will write the VFO-A contents to successive QMB memories.

Once all five QMB memories have data on them, previous data will be over-written on a first-in, first-out basis.

### QMB Channel Recall

1. Press the **RCL/STO** button briefly. The current QMB channel data will be shown on the frequency display area. The “**QMB**” icon will also appear and the Memory Mode indicators in the LED indicators area will illuminate.
2. Repeated brief presses of the **RCL/STO** button will toggle through the QMB channels.
3. Press the **V/M** button to return to the VFO or Memory mode.

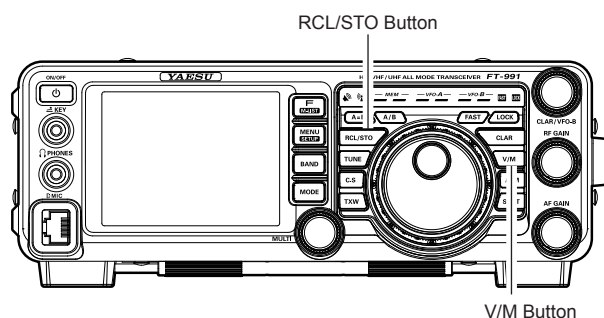

### ADVICE:

Rotating the Main Tuning Dial knob, or changing the operating mode, will place the transceiver in the “Memory Tune” mode, which is a temporary “pseudo-VFO” method of tuning off of a stored memory channel. If you do not over-write the contents of the current memory channel, the original contents will not be disturbed by the initiation of Memory Tune operation.

# MEMORY OPERATION

## STANDARD MEMORY OPERATION

The Standard Memory of the **FT-991** allows storage and recall of up to 99 memories, each storing frequency, mode, and a wide variety of status information, detailed previously. Memories may be grouped into as many as six Memory Groups. Additionally there are nine pairs of band-limit (PMS) memories along with five QMB (Quick Memory Bank) memories.

### Memory Storage

1. Set VFO-A up with the frequency, mode, and status, the way you want to have it stored.
2. Press the **A▶M** button momentarily; the current channel number will appear in the display and the “**MCK**” notation will appear.

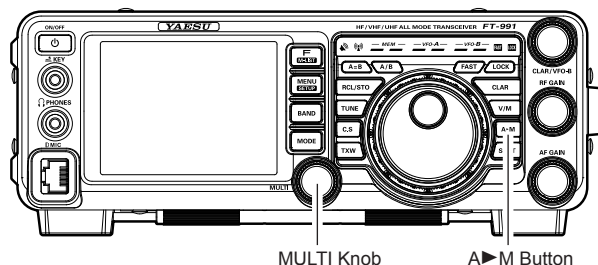
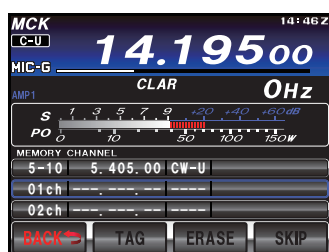

3. Rotate the **MULTI** knob to select the memory channel that you wish to store the data on.
4. Press and hold in the **A▶M** button for one second to store the frequency and other data into the selected memory channel. A double beep will sound to confirm that the operation is completed.

### Memory Channel Recall

1. Press the **V/M** button, if necessary, to enter the “Memory mode”.
2. Press the **F(M-LIST)** button, then touch **[MCH]** on the LCD. A memory channel number and the “**MCH**” notation will appear in the display.

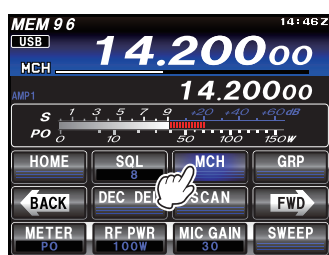

3. Touch **[MCH]** on the LCD, and then rotate the **MULTI** knob to select the desired memory channel.

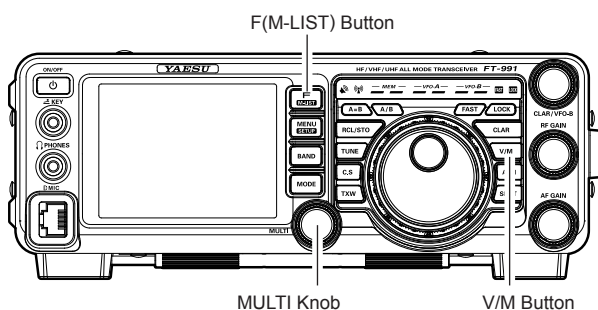

#### ADVICE:

To work within a particular Memory Group, press the **F(M-LIST)** button, then touch **[GRP]** on the LCD. Rotate the **MULTI** knob to select the desired Memory Group, then touch **[MCH]** on the LCD (the “**MCH**” notation will appear instead of the “**GRP**”); Now the memory channel may be chosen from within the selected Memory Group.

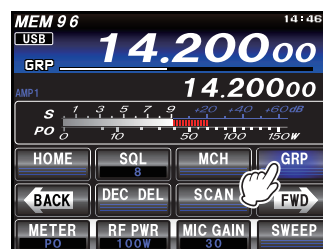

## STANDARD MEMORY OPERATION

### Recalling the Home Channel

1. Press the **F(M-LIST)** button, then touch **[HOME]** on the LCD. The home channel frequency will be shown in the display.

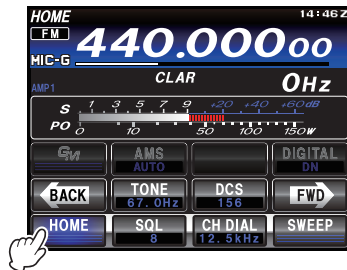

**ADVICE:**

Change the frequency using Main Tuning Dial knob to return to the VFO mode.

Touch **[HOME]** again to return to the VFO mode and display the frequency that was selected before the home channel was recalled.

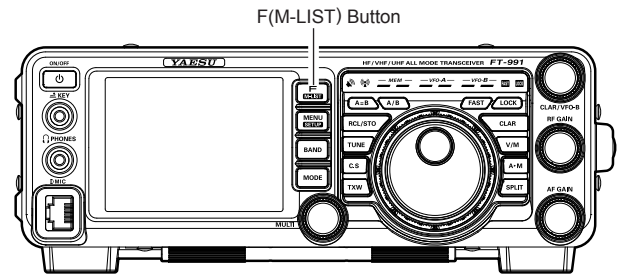
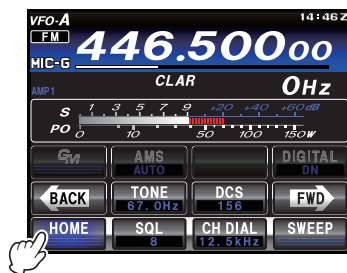

**ADVICE:**

In the default setting, the Home channel frequencies of each band are set as follows.

- HF band: 2,960000 MHz
- 50 MHz band: 52,52500 MHz
- 144 MHz band: 146,52000 MHz
- 430 MHz band: 446,00000 MHz

### Changing the Frequency of the Home Channel

The default frequency setting of the home channel when shipped from the factory can be changed.

1. Press the **F(M-LIST)** button, then touch **[HOME]** on the LCD. The home channel will be shown in the display.

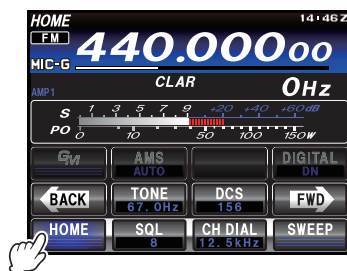

2. Press the **BAND** button, then touch **[ENT]**.

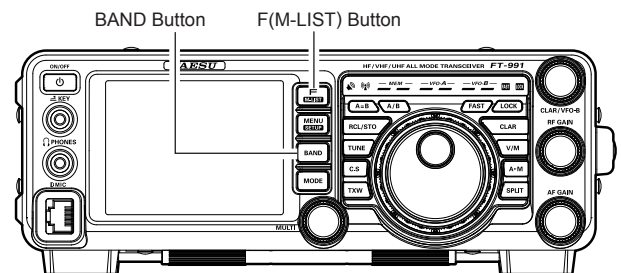
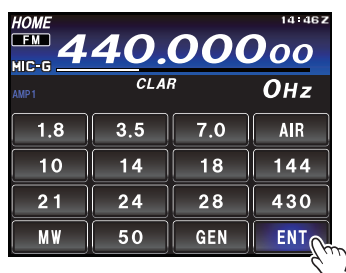

3. Set the desired frequency, then touch **[ENT]** on the LCD to exit to normal operation.



When the writing to the home channel is completed, the updated home channel frequency will be displayed.

# MEMORY OPERATION

## STANDARD MEMORY OPERATION

### Labeling Memories

An Alphanumeric “Tag” (label) may be appended to a memory or memories, to aid in recollection of the channel’s use (such as a club name, etc.). To do this:

1. Press and hold in the **F(M-LIST)** button.  
The data stored in the currently selected memory channel will be displayed on the TFT.
2. Rotate the **MULTI** knob to recall the memory channel that you wish to append a label.
3. Touch **[TAG]** on the LCD.  
A cursor will appear on the first digit.

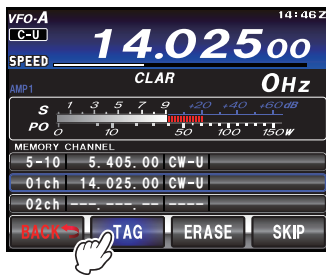

4. Touch a key on the LCD to enter the letters, numbers, or symbols of the desired label.
5. Repeat step 5 to program the remaining letters, numbers, or symbols of the desired label. 12 characters may be used in the creation of a label.  
Use **[←]** and **[→]** on the LCD to set the cursor position and **[✕]** on the LCD to erase a letter at the left of the cursor.
6. When you have completed the creation of the label, touch **[ENT]** on the LCD.



7. Press the **F(M-LIST)** button to save the new setting and return to normal operation.

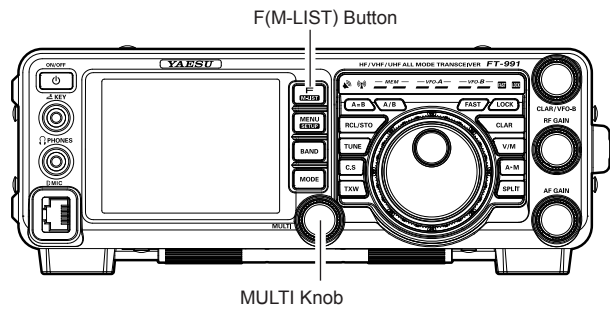



## STANDARD MEMORY OPERATION

### Checking a Memory Channel Status

Before programming a channel into memory, you can check the current contents of that channel without the danger of over-writing the channel accidentally.

1. Press the **A▶M** button momentarily.

The data stored in the currently selected memory channel will be displayed on the TFT. However, since you are only checking the contents of the memory channel, the radio will not have moved to the memory channel frequency.

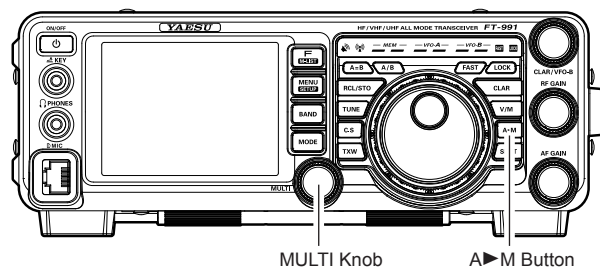

MULTI Knob

A▶M Button

2. Rotate the **MULTI** knob to select a different memory channel. To exit from the Memory Check mode, press the **A▶M** button momentarily once more.

#### ADVICE:

- ❑ While operating in the VFO mode, using Memory Check, you may store the current VFO frequency into the selected memory by pressing and holding in the **A▶M** button for one second (until the double beep).

### Erasing Memory Channel Data

1. Press and hold in the **F(M-LIST)** button.
2. Rotate the **MULTI** knob to select the memory channel that you would like to erase.
3. Touch **[ERASE]** on the LCD.

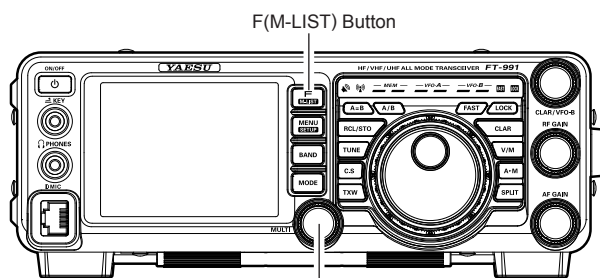

F(M-LIST) Button

MULTI Knob

#### ADVICE:

- ❑ The **FT-991** cannot erase memory channel "01" (and channels "5-01" through "5-10": U.S. version).
- ❑ If you make a mistake and wish to restore the memory contents, just repeat steps (1) through (3) above.



## STANDARD MEMORY OPERATION

### Memory Tune Operation

The frequency may be freely tuned off from any memory channel in “Memory Tune” mode; this is similar to VFO operation. So long as you do not over-write the contents of the current memory, Memory Tune operation will not alter the contents of the memory channel.

1. Press the **V/M** button to recall any memory channel.
2. Press the **F(M-LIST)** button, then touch **[MCH]** on the LCD.

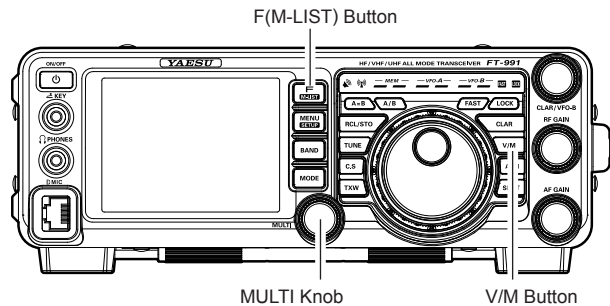
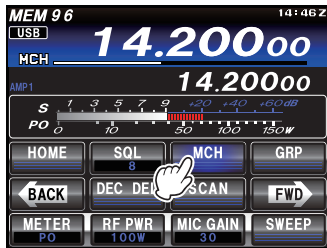

3. Rotate the **MULTI** knob to select the memory channel.
4. Rotate the Main Tuning Dial knob; you will now observe that the memory channel frequency is changing.

#### ADVICE:

- During Memory Tune operation, you may change operating modes, and engage the offset Clarifier, if desired.
5. Press the **V/M** button momentarily to return to the originally memorized frequency of the current memory channel. One more press of the **V/M** button will return to VFO operation.

#### NOTE:

Computer software programs utilizing the CAT system interface port may presume that the transceiver is operating in the VFO mode, for certain features like “band mapping” and/or frequency logging, because the “Memory Tune” mode so closely resembles the VFO mode. Be sure that you have the **FT-991** operating in a control mode compatible with the software’s requirements. Use the VFO mode if you’re not sure.

## STANDARD MEMORY OPERATION

### Split Memory

Separate frequencies for transmit and receive can be registered for each memory channel.

1. Set VFO-A up with the frequency, mode, and status, the way you want to have it stored.
2. Press the **A▶M** button momentarily; the current channel number will appear in the display and the “MCK” notation will appear.

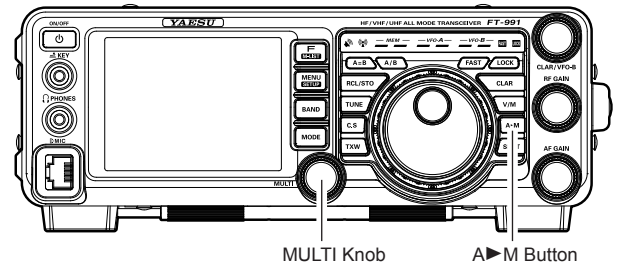

3. Rotate the **MULTI** knob to select the memory channel that you wish to store the data on.
4. Press and hold in the **A▶M** button for one second to store the receive frequency and other data into the selected memory channel. A double beep will confirm that the **A▶M** button was held in long enough and the data is registered.
5. Enter the transmit frequency.

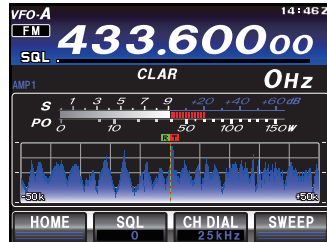

6. Press the **A▶M** button. Make sure that the memory channel storing the receive frequency is selected.

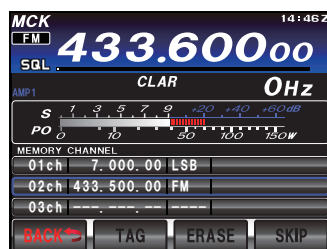

7. To register the transmit frequency, press and hold the **PTT** button on the microphone, and simultaneously press and hold the **A▶M** button. A double beep will confirm that the **A▶M** button was held in long enough and the data is registered. When the memory writing is completed, the receive frequency will be shown in the display.

#### ADVICE:

When a split-frequency memory channel is recalled, “DUP” is displayed on the LCD.

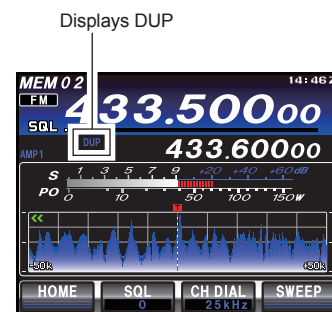

# MEMORY OPERATION

## MEMORY GROUPS

Memory channels may be arranged into as many as six convenient groups, for easy identification and selection. For example, different memory groups may be designated for AM BC stations, short-wave broadcast stations, contest frequencies, repeater frequencies, PMS limits, or any other groupings you might like.

Each memory group is capable of holding up to 20 memory channels (except Memory Group 01 is 19 memory channels, and the Group size is fixed).

### Memory Group Assignment

1. Press the **MENU(SETUP)** button to enter the Menu mode.
2. Rotate the **MULTI** knob to select Menu item “034 MEM GROUP”.
3. Touch **[SELECT]** on the LCD, then rotate the **MULTI** knob to set this Menu item to “ENABLE” (the default setting is “DISABLE”).



4. Touch **[ENTER]** on the LCD to save the new setting.

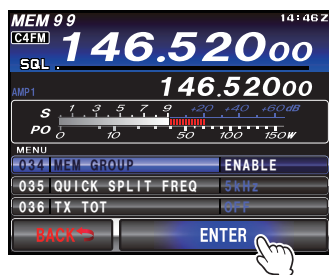

5. Press the **MENU(SETUP)** button or **[BACK]** on the LCD to exit. Operation will now be restricted to the six Memory Groups.

To cancel Memory Group operation, repeat steps (1) through (4) above, choosing “DISABLE” in step (3).

#### ADVICE:

To avoid confusion, note that the PMS memory group and the PMS memories “P-1L” through “P-9U” will be so designated.

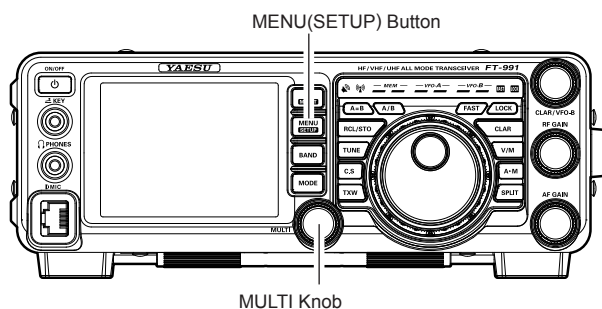

| MEMORY CHANNEL NUMBER |                   |
|-----------------------|-------------------|
|                       | 01 - 19           |
|                       | 20 - 39           |
|                       | 40 - 59           |
|                       | 60 - 79           |
|                       | 80 - 99           |
|                       | P-1L/1U - P-9L/9U |
|                       | 5M-01 - 5M-10     |

## MEMORY GROUPS

### Choosing the Desired Memory Group

If desired, memories just within a particular Memory Group may be recalled.

1. Press the **V/M** button, if necessary, to enter the “Memory” mode.
2. Press the **F(M-LIST)** button, then touch **[GRP]** on the LCD. The “**GRP**” icon will appear on the display.

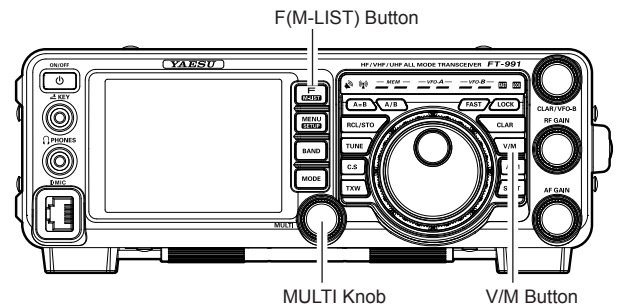
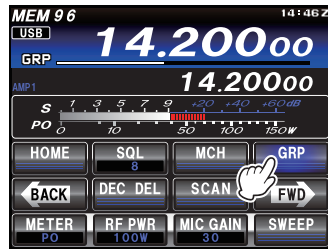

3. Rotate the **MULTI** knob to select the desired Memory Group.
4. Touch **[MCH]** on the LCD. The “**MCH**” icon will appear on the display.

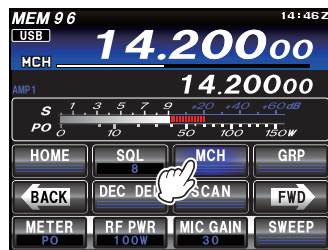

5. Rotate the **MULTI** knob to select the desired Memory Channel within the Selected Memory Group.

#### **ADVICE:**

If no channels have been assigned to a particular Memory Group, that Group cannot be accessed.

# OPERATION ON ALASKA EMERGENCY FREQUENCY: 5167.5 KHZ (U.S. VERSION ONLY)

Section 97.401(d) of the regulations governing amateur radio in the United States permit emergency amateur communications on the spot frequency of 5167.5 kHz by stations in (or within 92.6 km of) the state of Alaska. This frequency is only to be used when the immediate safety of human life and/or property are threatened, and is never to be used for routine communications.

The **FT-991** includes the capability for transmission and reception on 5167.5 kHz under such emergency conditions via the Menu system. To activate this feature:

1. Press the **MENU(SETUP)** button to enter the Menu mode.
2. Rotate the **MULTI** knob to select Menu item “151 EMERGENCY FREQ TX”.
3. Touch **[SELECT]** on the LCD, then rotate the **MULTI** knob to select “ENABLE.”

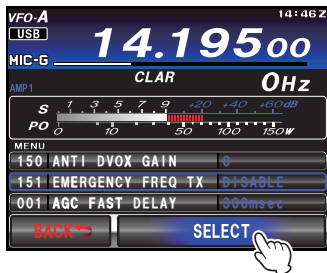
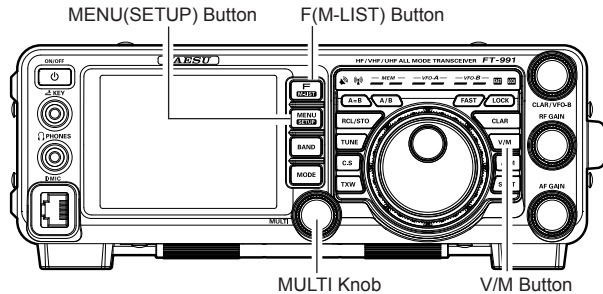

4. Touch **[ENTER]** on the LCD to save the new setting.

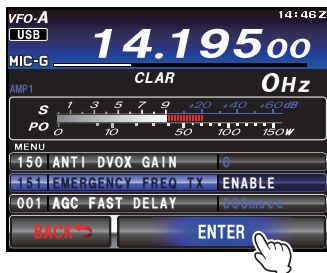

5. Press the **MENU(SETUP)** button or **[BACK]** on the LCD to exit to normal operation. Emergency communication on this spot frequency is now possible.
6. Press the **V/M** button, as necessary, to enter the Memory mode.
7. Press the **F(M-LIST)** button, then touch **[MCH]** on the LCD.

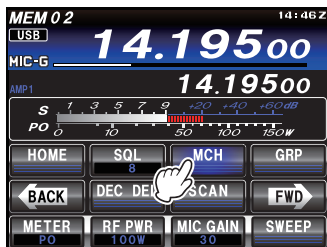

8. Rotate the **MULTI** knob to select the emergency channel (“EMG”), which is found between channels “5-10” and “01ch”).

**NOTE:**

- The receive-mode CLARIFIER functions normally while using this frequency, but variation of the transmit frequency is not possible. The full specifications of the **FT-991** are not necessarily guaranteed on this frequency, but power output and receiver sensitivity should be fully satisfactory for the purpose of emergency communication.
- If you wish to disable operation capability on the Alaska Emergency Frequency, repeat the above procedures, but set the Menu item “151 EMERGENCY FREQ TX” to “DISABLE” in step 3.
- In an emergency, note that a half-wave dipole cut for this frequency should be approximately 45’3” on each leg (90’6” total length). Emergency operation on 5167.5 kHz is shared with the Alaska-Fixed Service. This transceiver is not authorized for operation, under the FCC Part 87, for aeronautical communications.

## VFO SCANNING

Either the VFO or the memory channels of the **FT-991** may be scanned, and the receiver will halt scanning on any frequency with a signal strong enough to open the receiver squelch.

1. Set the VFO-A to the frequency on which you would like to begin scanning.
2. Press the **F(M-LIST)** button, then touch **[SQL]** on the LCD. Rotate the **MULTI** knob so that the background noise is just silenced.

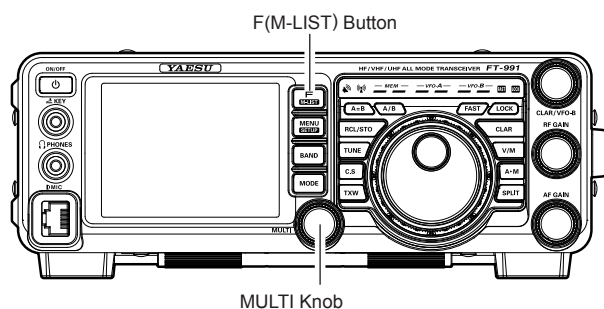
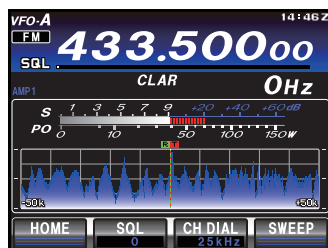

3. Press and hold in the microphone **UP** or **DWN** button for one second, or press the **F(M-LIST)** button followed by **[SCAN]** to start scanning in the specified direction on the VFO frequency.

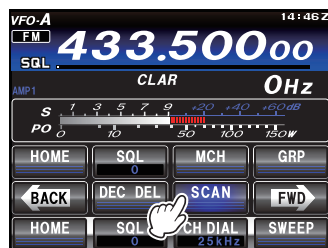

4. If the scanner halts on an incoming signal, the decimal point between the “MHz” and “kHz” digits of the frequency display will blink.

### ADVICE:

- If the incoming signal disappears, scanning will resume in about five seconds.
  - On the SSB/CW and SSB-based Data modes, the scanner will pause on a received signal, then will step across the signal very slowly, giving you time to stop the scan, if you like. In these modes on the VFO, the scanner does not stop, however.
5. To cancel scanning, press the **PTT** switch, or touch **[SCAN]** on the LCD.

### ADVICE:

- If the scan has paused on a signal, pressing the microphone **UP** or **DWN** button, or touching **[SCAN]** on the LCD will cause scanning to resume instantly.
- If you press the microphone **PTT** button during scanning, the scanner will halt at once. However, pressing the **PTT** button during scanning will not cause transmission.
- The manner in which the scanner resumes after it has paused on a signal may be selected by using Menu item “038 MIC SCAN RESUME”. The default “TIME” (5 sec) setting will cause the scanner to resume scanning after five seconds; however the scan setting may be changed to resume only after the received signal has dropped out.
- If the Main Tuning Dial knob is rotated while scanning is in progress, the scanning will continue up or down in frequency according to the direction of the Dial Knob rotation. (in other words, if the dial is rotated to the left when scanning toward a higher frequency, the direction of the scan will reverse.)

### QUICK POINT:

If you have no interest in scanning, and wish to prohibit the microphone **UP/DWN** buttons from initiating scanning, you may disable scanning control from the microphone using Menu item “037 MIC SCAN” (set it to “DISABLE”).

## MEMORY SCAN

1. Set the transceiver to the “Memory” mode by pressing the **V/M** button, if necessary.
2. Press the **F(M-LIST)** button, then touch **[SQL]** on the LCD. Rotate the **MULTI** knob so that the background noise is just silenced.

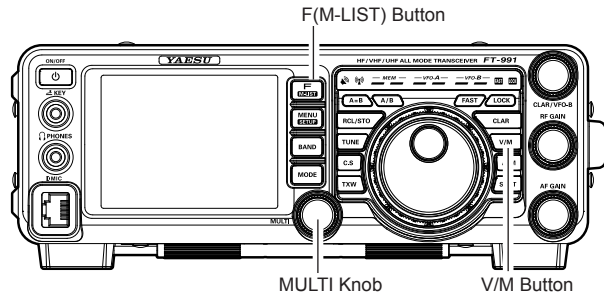
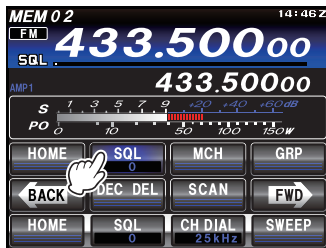

3. Press and hold in the microphone **UP** or **DWN** button for one second, or press the **F(M-LIST)** button followed by **[SCAN]** to start scanning in the specified direction.

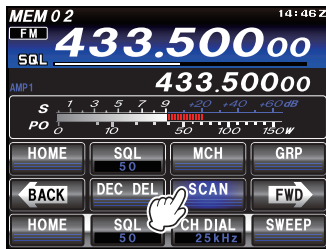

### ADVICE:

- If the scanner halts on an incoming signal, the decimal point between the “MHz” and “kHz” digits of the frequency display will blink.
  - If the incoming signal disappears, scanning will resume in about five seconds.
4. To cancel scanning, press the **PTT** switch, or touch **[SCAN]** on the LCD.

### ADVICE:

- During Memory Group operation, only the channels within the current Memory Group will be scanned.
- If the scan has paused on a signal, pressing the microphone **UP** or **DWN** button, or touching **[SCAN]** on the LCD will cause scanning to resume instantly.
- If you press the microphone **PTT** button during scanning, the scanner will halt at once. However, pressing the **PTT** button during scanning will not cause transmission.
- The manner in which the scanner resumes after it has paused on a signal may be selected by using Menu item “038 MIC SCAN RESUME”. During memory scanning, the default “TIME” (5 sec) setting will cause the scanner to resume scanning after five seconds; however the scan may be set, to resume only after the received signal has dropped out.
- If the Main Tuning Dial knob is rotated while scanning is in progress, the memory channel scanning will continue up or down in accordance with the direction of the Dial Knob rotation. (In other words, if the dial is rotated to the left when scanning toward a higher channel number, the direction of the scan will reverse.)

### QUICK POINT:

If you have no interest in scanning, and wish to prohibit the microphone **UP/DWN** buttons from initiating scanning, you may disable scanning control from the microphone using Menu item “037 MIC SCAN” (set it to “DISABLE”).



# PMS (PROGRAMMABLE MEMORY SCANNING)

To limit scanning (and manual tuning) within a particular frequency range, the Programmable Memory Scanning (PMS) feature utilizes nine special-purpose memory pairs (“P-1L/P-1U” through “P-9L/P-9U”). The PMS feature is especially useful in helping you to observe any operating sub-band limits, which apply to your Amateur license class.

1. Store the Lower and Upper tuning/scanning limit frequencies into the memory pair “P-1L” and “P-1U”, respectively, or any other “L/U” pair of memories in the special PMS memory area. See page 98 for details regarding memory storage.
2. Press the **V/M** button to enter the “Memory” mode.
3. Press the **F(M-LIST)** button, then touch **[MCH]** on the TFT display. The LEDs indicating the Memory mode will illuminate.

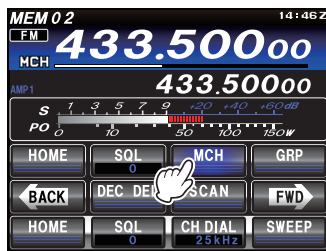
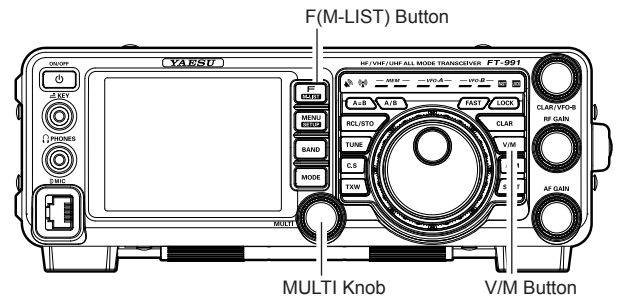

4. Rotate the **MULTI** knob to select memory channel “P-1L” or “P-1U”.
5. Press the **F(M-LIST)** button, then touch **[SQL]** on the LCD. Rotate the **MULTI** knob so that the background noise is just silenced.

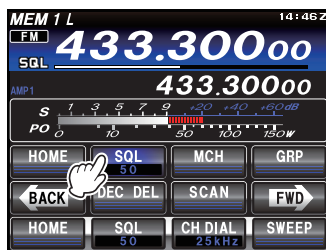

6. Turn the Main Tuning Dial knob slightly (to activate memory tuning). Tuning and scanning are now limited to the range within the P-1L/P-1U limits until the **V/M** button is pressed again to return to memory channel or VFO operation.
7. Press and hold in the microphone **UP** or **DWN** button for one second, or press the **F(M-LIST)** button followed by **[SCAN]** to start scanning in the specified direction.

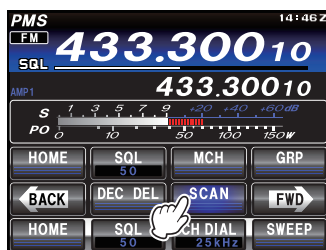

## ADVICE:

- ❑ If the scanner halts on an incoming signal, the decimal point between the “MHz” and “kHz” digits of the frequency display will blink.
- ❑ If the incoming signal disappears, scanning will resume in about five seconds.
- ❑ On the SSB/CW and SSB-based Data modes, the scanner will pause on a received signal, then will step across the signal very slowly, giving you time to stop the scan, if you like. However, in these modes on the VFO, the scanner does not stop.
- ❑ If the scan has paused on a signal, pressing the microphone **UP** or **DWN** button, or touching **[SCAN]** on the LCD will cause scanning to resume instantly.
- ❑ If the Main Tuning Dial knob is rotated while scanning is in progress, the scanning will continue up or down in frequency according to the direction of the Dial Knob rotation. (in other words, if the dial is rotated to the left when scanning toward a higher frequency, the direction of the scan will reverse.)
- ❑ If the microphone **PTT** button is pressed during scanning, the scanner will halt at once. Pressing the **PTT** button *during scanning* will not cause transmission.

# USING THE GPS FUNCTION

Connecting a YAESU **FT1DR**, **FTM-400DR** or a commercially available GPS receiver/antenna to the **FT-991** will permit the transceiver to constantly receive and display the station location information.

By utilizing the GPS location information, you can register stations with which you frequently communicate and use the GM function to confirm whether they are within communication range.

## WHAT IS GPS?

GPS or Global Positioning System is a satellite location system that is used to determine the current position on earth. It is a military system developed by the US Department of Defense with approximately 30 GPS satellites orbiting the earth at an altitude of about 20,000 km. When signals from three or more satellites in space are received, the current position information (longitude, latitude, altitude etc.) may be determined within an accuracy of several meters. The accurate time can also be received from the atomic clock built into the GPS satellite.

## POSITIONING USING GPS

1. Press and hold in the front panel **ON/OFF** switch to turn the transceiver on.

The satellite search will begin and the “📶” icon will be displayed at the top right of the screen.

### ADVICE:

- It may take several minutes to acquire the satellites.
- When three or more satellites cannot be acquired, the icon display will disappear. In this case, positioning is not possible and the position information cannot be used.



ON/OFF Switch

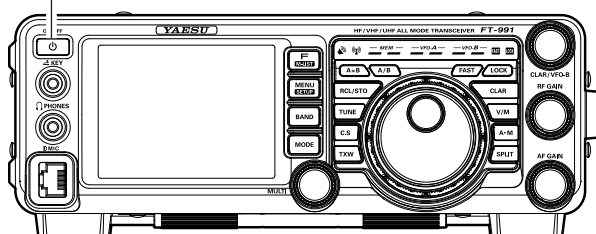

### About GPS Positioning

Positioning refers to the calculation of one's own position derived from the satellites orbit information and the transmission time of the radio waves. Positioning requires that three or more satellites be acquired. When positioning cannot be carried out properly, move to an open space as far away from buildings as possible and where there are fewer obstructions.

### About the Error

Depending on the surrounding environment of the receiver location, an error of several hundred meters may occur. Although positioning is possible using only three satellites, depending on the positioning conditions, the positioning accuracy may become worse, or may no longer be possible under the following conditions:

- Between high rise buildings, narrow roads between buildings, indoors and under the shade of buildings, below high voltage lines and underneath overhead structures, between trees and shrubs such as in forests and woods, inside tunnels and underground, when used behind a solar-energy reflecting glass, locations where a strong magnetic field occurs

### When not Using the Radio for a Long Period of Time

When using the GPS function for the first time after purchasing the **FT-991** transceiver, and when turning it on after it has not been used for a long period time, positioning may take several minutes in order to search for the satellites. Also, when using the device again several hours after switching off the power, positioning may take several minutes in order to search for the satellites.

# USING THE GPS FUNCTION

## POSITIONING USING GPS

### Positioning Using an External GPS Device

A YAESU FT1DR/DE, FTM-400DR/DE or a commercially available GPS receiver/antenna may be connected to the **GPS/CAT** jack on the rear panel.

The **GPS/CAT** jack connector is illustrated below.

#### CONNECTING TO THE FT1DR/DE

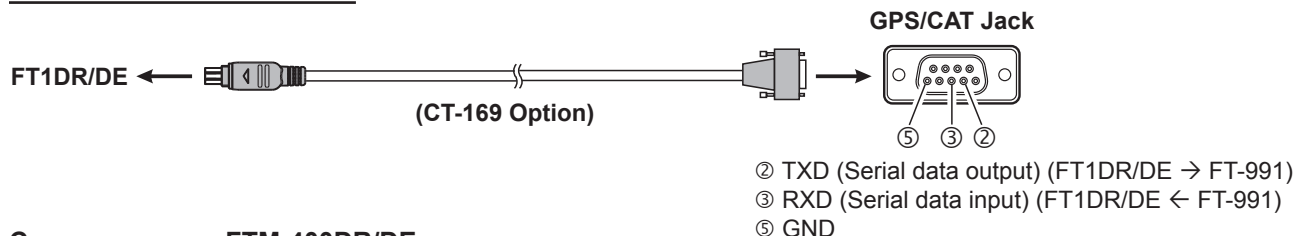

#### CONNECTING TO THE FTM-400DR/DE

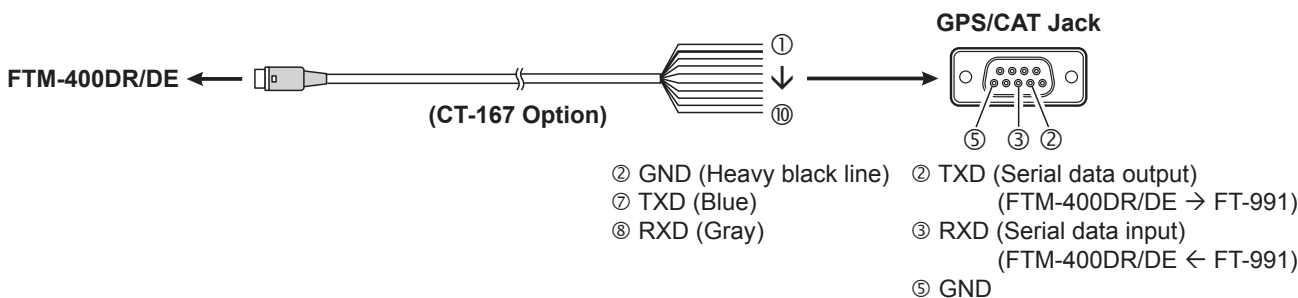
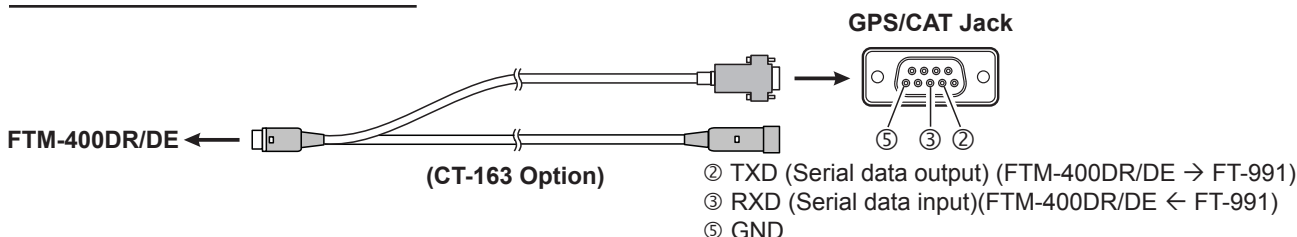

1. Press the front panel **ON/OFF** switch to turn the transceiver off.
2. Plug the connector of the external device into the **GPS/CAT** jack on the rear panel.
3. Press and hold in the front panel **ON/OFF** switch to turn the transceiver on.
4. Press the **MENU(SETUP)** button to enter the Menu mode.
5. Rotate the **MULTI** knob to select Menu item “028 GPS/232C SELECT”.
6. Touch [**SELECT**] on the LCD, then rotate the **MULTI** knob to set this Menu item to “GPS” (the default setting is “GPS”).
7. Touch [**ENTER**] on the LCD to save the new setting.
8. Press the **MENU(SETUP)** button or touch [**BACK**] on the LCD to exit to normal operation.

When the external device acquires three or more satellites, the “” icon will be displayed on the top right of the screen.

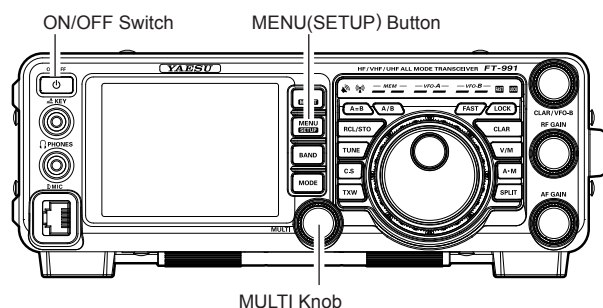
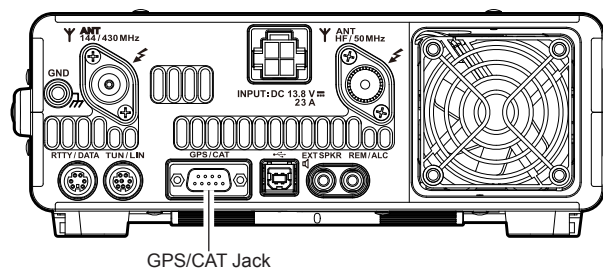
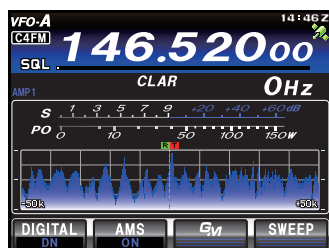

#### ADVICE:

- ❑ When connecting to an external GPS device, refer to the operating manual of the connected device as well.
- ❑ When using an external GPS device, separate the **FT-991** transceiver away from the external GPS device to reduce the possibility of RF interference.

# USING THE GPS FUNCTION

## DISPLAYING THE POSITION INFORMATION

### Displaying the Current Station Position Information

1. Press and hold the **MENU(SETUP)** button.
2. Touch **[LAT/LON]** on the LCD.
3. Touch **[GPS]** on the LCD.

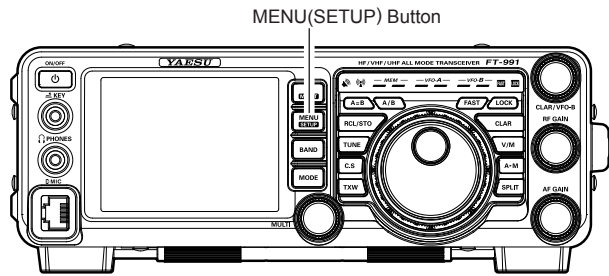

The latitude and longitude of this station will be displayed.

### Entering the Location Information Manually

1. Press and hold the **MENU(SETUP)** button.
2. Touch **[LAT/LON]** on the LCD.
3. Touch **[LAT]** on the LCD.



4. Enter the latitude, then touch **[ENT]** followed by **[BACK]**.

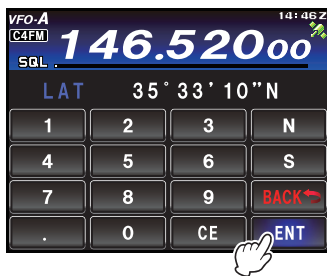

5. Touch **[LON]** on the LCD.

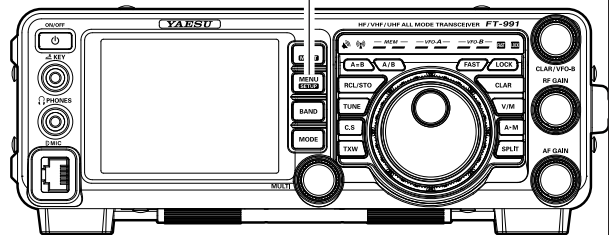

6. Enter the longitude, then touch **[ENT]** followed by **[BACK]**.



7. Press the **MENU(SETUP)** button to exit to normal operation.

---

## WHAT IS THE GM FUNCTION?

---

The GM (group monitor) function automatically inquires to find if there are any stations with the GM function in operation on the same frequency within communication range.

The **FT-991** can then display the position and distance and other information for each group member call sign on the screen.

Besides letting you know who is within your sphere of communications, the GM function is also a convenient method to instantly note the relative positions of all the members in the group.



### ADVICE:

The GM function does not work in the analog FM mode.

---

## BASIC METHODS TO USE THE GM FUNCTION

---

There are two ways to use the GM function:

- (1) Display all stations operating the GM function that are within communications range (maximum of 24 stations can be displayed)
- (2) Register the ID of partners into a memory group and then display only the Group Member partners

An explanation of the two methods of starting the GM operation is given on the following pages.

Refer to the separate Operating Manual GM Edition for additional details on using the GM Functions (download the manual from our YAESU website).

# USING THE GM FUNCTION

## BASIC METHODS TO USE THE GM FUNCTION

### Displaying all the Stations where the GM Function is in Operation

1. Press the **MODE** button, and then touch the corresponding key on the LCD to select the C4FM operating mode. The “C4FM” icon appears in the display.

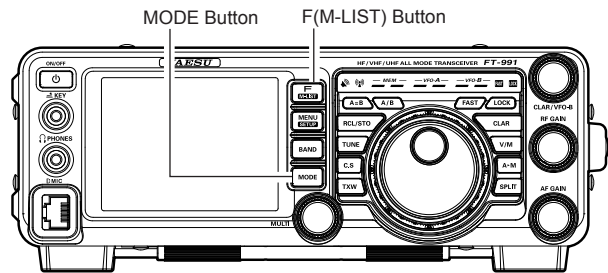
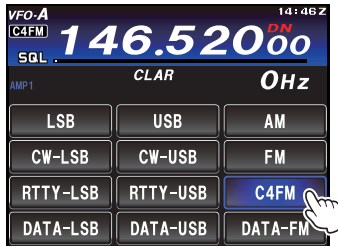

2. Set the desired operating frequency.
3. Press the **F(M-LIST)** button, then touch **[GM]** on the LCD.

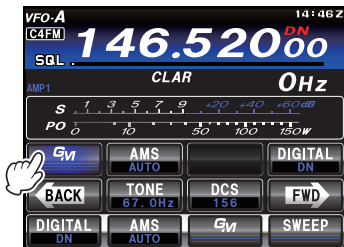

Up to 24 stations operating with the GM function within the sphere of communications will be listed on the TFT display.

#### ADVICE:

- Stations within the sphere of communications are displayed in blue.
  - Stations outside the sphere of communications are displayed in grey.
4. Touch **[BACK]** on the LCD. The GM function will be turned off and the display will return to the previous screen.

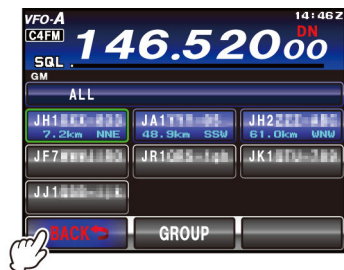



## BASIC METHODS TO USE THE GM FUNCTION

### Displaying only Partners Registered in the GM Group

When a group that has been created beforehand is selected from the group list and the screen is touched, the status of the members registered in that group will be displayed.

A total of up to 5 groups can be created. Names such as “FRIENDS”, “CAMP” etc. can be assigned to the groups. Up to 24 stations can be registered as members in each group.

1. Press the **MODE** button, then touch the corresponding key on the LCD to select the C4FM operating mode. The “**C4FM**” icon appears in the display.

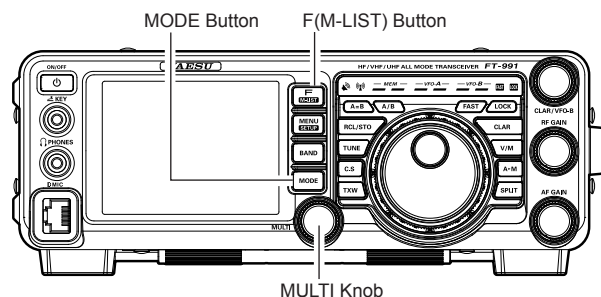
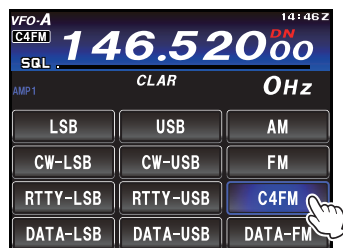

2. Set the desired operating frequency.
3. Press the **F(M-LIST)** button, then touch **[GM]** on the TFT display.



6. Touch **[GROUP]** on the LCD. The display will return to the group list.



4. Touch **[GROUP]** on the LCD, then rotate the **MULTI** knob, or touch the screen to select a group.



#### ADVICE:

Touch **[BACK]** on the LCD. The GM function will be turned off and the display will return to the previous screen.

5. Touch the screen to select the group.



7. Touch **[BACK]** twice on the LCD. The GM function will be turned off and the display will return to the previous screen.

Up to 24 group members with the GM function in operation at the same frequency will be displayed.



# RTTY (RADIO TELETYPE) OPERATION

## EXAMPLE OF CONNECTING RTTY COMMUNICATIONS DEVICE

### Connecting to the TU (Terminal Unit)

Connect the RTTY communications TU (Terminal Unit) to the rear panel RTTY/DATA terminal. Be sure to read the instruction manual of the TU device before connecting it.

#### ADVICE:

Adjust the RTTY data output level using Menu item “101 RTTY OUT LEVEL”.

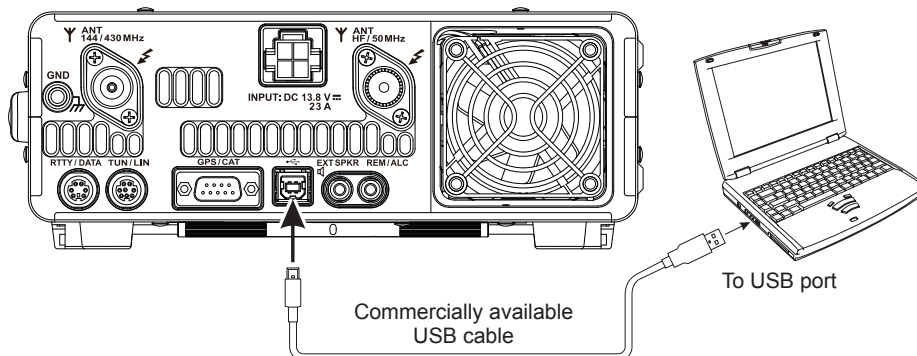
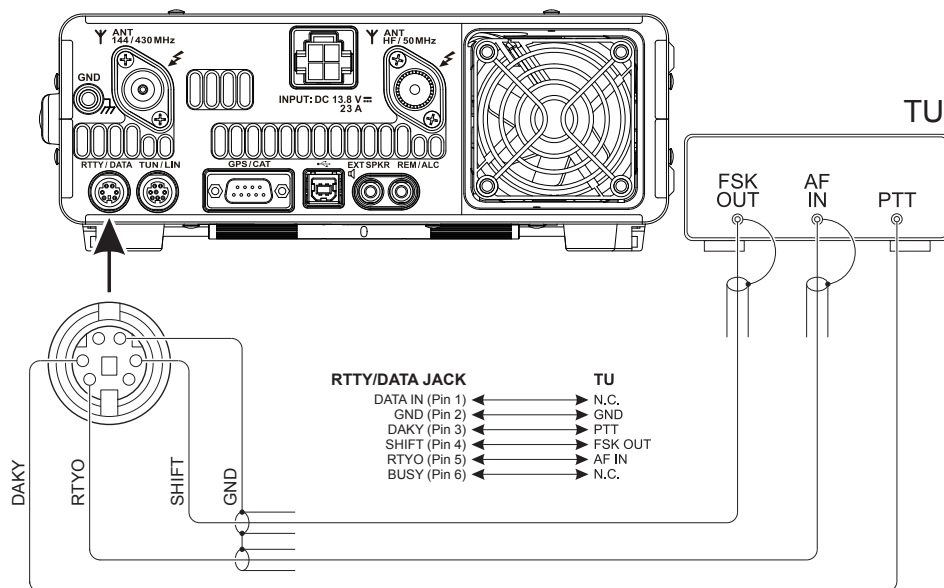

# RTTY (RADIO TELETYPE) OPERATION

## EXAMPLE OF CONNECTING RTTY COMMUNICATIONS DEVICE

### Connecting to your Computer

#### NOTE:

Install the RTTY application software and driver on your computer in advance.

- ❑ RTTY communication application (YAESU does not provide technical support for the use or operation of the application.)
- ❑ Virtual COM port driver (Visit the Yaesu website <http://www.yaesu.com/> to download the designated driver and Installation Manual.)

1. Use a commercially available USB cable to connect the USB jack on the rear panel of the **FT-991** and the computer.
2. Press the **MODE** button, and then touch the corresponding key on the LCD to select the RTTY-LSB operating mode. The “**R-L**” icon appears in the display.

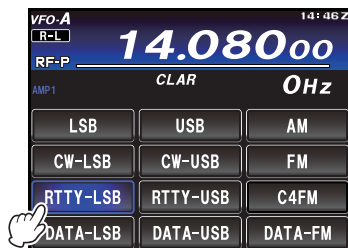

3. Press the **MENU(SETUP)** button. The Menu list will appear in the display. Rotate the **MULTI** knob to select Menu item “060 PC KEYING”. Touch [**SELECT**] on the LCD, then rotate the **MULTI** knob to set this Menu item to “RTS” or “DTR”. Press the **MENU(SETUP)** button or touch [**BACK**] on the LCD to exit to normal operation.



“RTS” and “DTR” will be set as shown below.

|                 |     | RTTY-PTT | RTTY-SHIFT |
|-----------------|-----|----------|------------|
| Menu item       | RTS | RTS      | DTR        |
| “060 PC KEYING” | DTR | DTR      | RTS        |

RTTY-PTT and RTTY-SHIFT operations can be set from the Standard-COM port of the virtual COM port.

On the computer, open Device Manager from the Control Panel to check the COM port number and set each item of the RTTY communication application.

4. From the computer Control Panel, open the Sound setting window to set “USB Audio CODEC” as the recording device.

# DATA (PSK) OPERATION

## EXAMPLE OF DATA COMMUNICATIONS DEVICE

Use commercial or free computer software for PSK data communications. See the illustration below for connecting the **FT-991** transceiver to a computer.

Be sure to read the instruction manual of the interface device to be connected to the radio and computer.

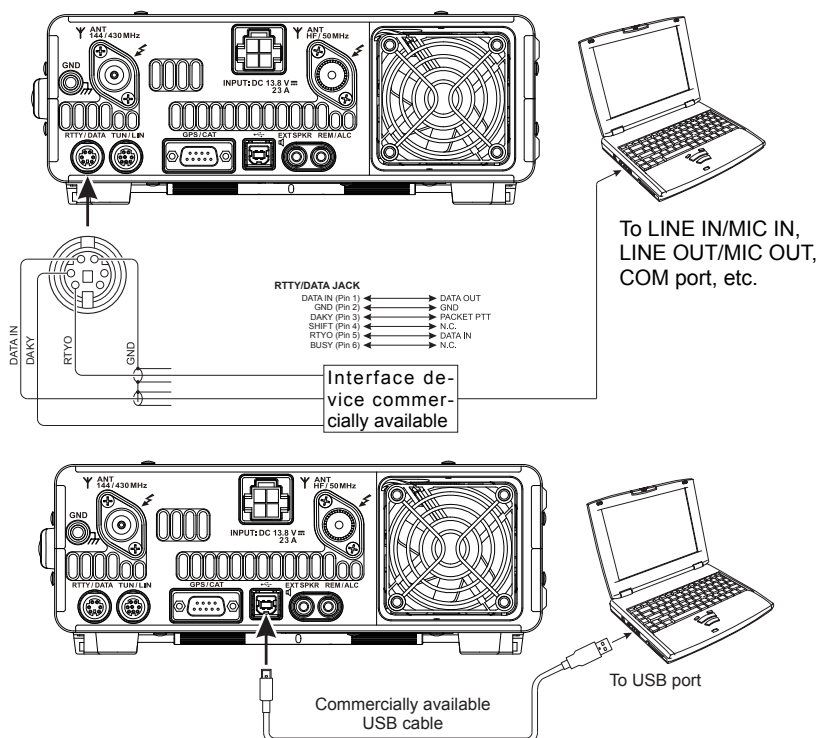

### ADVICE:

The **FT-991** allows for PSK, Olivia, Contestia, etc. digital mode to be sent by the Data method or SSB. The conventional method is to use USB, except RTTY, however the Data method allows for more accurate carrier frequency control, which is helpful in a Contest or DX environment.

### DATA-AFSK

**(PSK, OLIVIA, CONTESTIA, RTTY etc.)**

#### FT-991 Settings

1. Press the **MODE** button, and then touch the corresponding key on the LCD to select the USB operating mode. The “**USB**” icon appears in the display.

#### ADVICE:

USB is the conventional mode for AFSK transmission on all bands, however some users may be using LSB.

2. Press the **F(M-LIST)** button to display the function list.
3. Touch **[MONI]** on the LCD. The Monitor function will be set to “ON”. The **MULTI** knob will function as the MONITOR adjustment knob.
4. Press the **MENU(SETUP)** button. The Menu list will appear in the display.
5. Rotate the **MULTI** knob to select Menu item “110 SSB PTT SELECT”. Touch **[SELECT]** on the LCD, then rotate the **MULTI** knob to set this Menu item to “RTS”. Touch **[ENTER]** on the LCD.
6. Rotate the **MULTI** knob to select Menu item “111 SSB PORT SELECT”. Touch **[SELECT]** on the LCD, then rotate the **MULTI** knob to set this Menu item to “USB”. Touch **[ENTER]** on the LCD. Press

the **MENU(SETUP)** button or touch **[BACK]** on the LCD to exit to normal operation.

#### NOTE:

All other SSB and DATA settings remain at their default.

### Connect a USB Cable from the FT-991 USB port and your computer

#### ADVICE:

Before connecting the USB cable you must download the SCU-17 Drivers. The Drivers can be found on the **FT-991 FILES** page at the Yaesu Web page, [www.yaesu.com](http://www.yaesu.com). Once the Drivers have been installed connect the USB cable to the computer and then to the radio. At your computer's Device Manager you will find a Standard Driver and Enhanced Driver installed.

### Computer Settings

#### Soundcard

At your Computer Control Panel Sound set your Speaker Audio default to USB AUDIO CODEC.

#### COM PORT

Check your Com Port assignments at your Computer's Device Manager to be sure you have the Enhanced and Standard Drivers. Make a note of the Com Port numbers assigned.

## EXAMPLE OF DATA COMMUNICATIONS DEVICE

### Software Settings

#### NOTE:

There are many good Data Mode Operating Software programs available on the internet. Each of these programs will have their own Setup instructions, therefore to assist you, the following, while general in nature is common to most software setup.

#### COM PORT Settings

To start set the Com Port setting to the Enhanced Driver. If there is a problem switch to the Standard Driver.

#### PTT Settings

Set the PTT to RTS on DTR off.

#### SOUNDCARD

- At the software Soundcard setting, set to USB CODEC AUDIO
- At the software Soundcard Volume setting increase the volume to about 70% to start.

#### ADVICE:

If the soundcard volume setting is to low the radio will not switch to Transmit.

### DATA MODE

(PSK, OLIVIA, CONTESTIA, RTTY etc.)

#### FT-991 Settings

- Press the **MODE** button, and then touch the corresponding key on the LCD to select the DATA-USB operating mode. The “**D-U**” icon appears in the display.

#### ADVICE:

USB is the conventional mode for Digital (not RTTY) transmission on all bands, however some users may be using LSB.

- Press the **MENU(SETUP)** button. The Menu list will appear in the display.
- Rotate the **MULTI** knob to find Menu item “062”, “063”, “070”, “071” or “072”.
- Touch [**SELECT**] on the LCD.
- Rotate the **MULTI** knob to set these Menu item as shown below.

| Menu Function        | Setting                              |
|----------------------|--------------------------------------|
| 062 DATA MODE        | PSK                                  |
| 063 PSK TONE         | Adjust for desired center frequency. |
| 070 DATA IN SELECT   | MIC                                  |
| 071 DATA PTT SELECT  | RTS                                  |
| 072 DATA PORT SELECT | USB                                  |

- Touch [**ENTER**] on the LCD, then press the **MENU(SETUP)** button or touch [**BACK**] on the LCD to exit to normal operation.

#### NOTE:

All other SSB and DATA settings remain at their default.

### Connect a USB Cable from the FT-991 USB port and your computer

#### ADVICE:

Before connecting the USB cable you must download the SCU-17 Drivers. The Drivers can be found on the **FT-991 FILES** page at the Yaesu Web page, [www.yaesu.com](http://www.yaesu.com). Once the Drivers have been installed connect the USB cable to the computer and then to the radio. At your computer's Device Manager you will find a Standard Driver and Enhanced Driver installed.

### Computer Settings

#### Soundcard

At your Computer Control Panel Sound set your Speaker Audio default to USB AUDIO CODEC.

#### COM PORT

Check your Com Port assignments at your Computer's Device Manager to be sure you have the Enhanced and Standard Drivers. Make a note of the Com Port numbers assigned.

### Software Settings

#### NOTE:

There are many good Data Mode Operating Software programs available on the internet. Each of these programs will have their own Setup instructions, therefore to assist you, the following, while general in nature is common to most software setup.

#### COM PORT Settings

To start set the Com Port setting to the Enhanced Driver. If there is a problem switch to the Standard Driver.

#### PTT Settings

Set the PTT to RTS on DTR off.

#### SOUNDCARD

- At the software Soundcard setting, set to USB CODEC AUDIO
- At the software Soundcard Volume setting increase the volume to about 70% to start.

#### ADVICE:

If the soundcard volume setting is to low the radio will not switch to Transmit.

# MENU MODE

The Menu system of the **FT-991** provides extensive customization capability; the transceiver may be setup to complement personal operating preferences. Menu items are grouped by general utilization categories, and are numbered from “001 AGC FAST DELAY” to “151 EMERGENCY FREQ TX”.

## Using the Menu

1. Press the **MENU(SETUP)** button to engage the Menu mode.  
The display will show the Menu Number and the Menu Item.
2. Rotate the **MULTI** knob to select the Menu item to be modified.
3. Touch **[SELECT]** on the LCD, then rotate the **MULTI** knob to change the current setting of the selected Menu item.

### ADVICE:

Touch **[BACK]** on the LCD to cancel the setting.

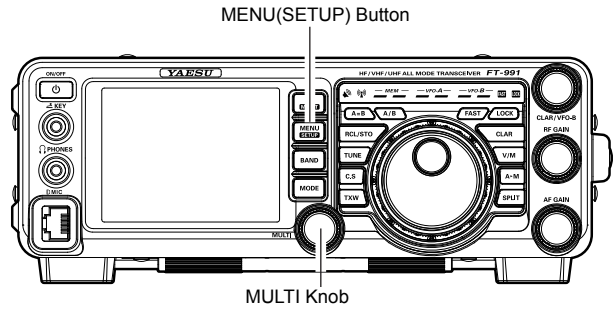

4. When the adjustment or setting is completed, touch **[ENTER]** on the LCD to save the new setting, then press the **MENU(SETUP)** button or touch **[BACK]** on the LCD to exit to normal operation.

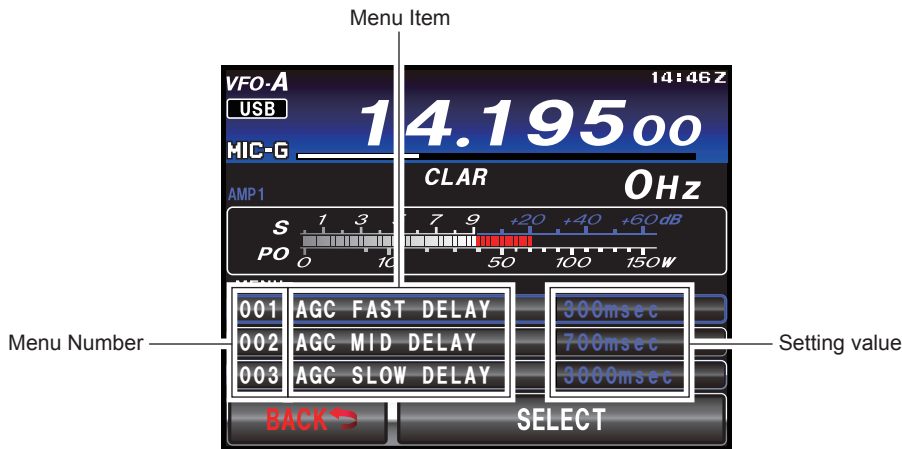
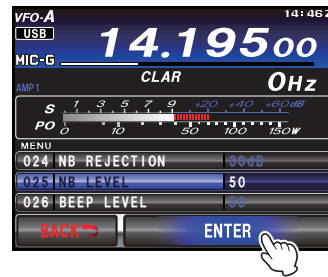
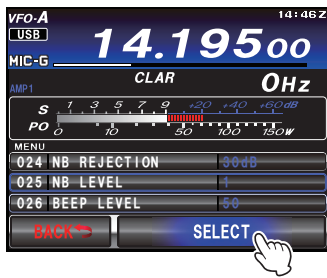

## Menu Resetting

Use this procedure to restore the Menu settings to their factory defaults, without affecting the programmed frequency memories.

1. Press the front panel **ON/OFF** switch to turn the transceiver off.
2. While holding the **MENU(SETUP)** button in, press and hold in the front panel **ON/OFF** switch to turn the transceiver on. Once the transceiver comes on, release the buttons.

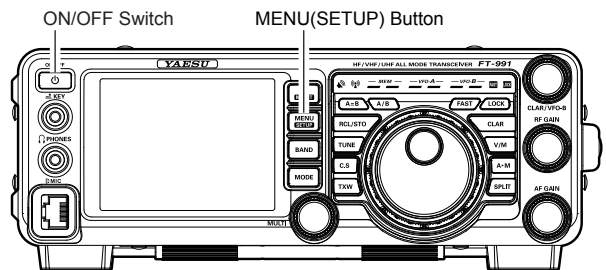

| No. | Menu Function      | Available Settings                            | Default Value |
|-----|--------------------|-----------------------------------------------|---------------|
| 001 | AGC FAST DELAY     | 20 - 4000 (20msec/step)                       | 300msec       |
| 002 | AGC MID DELAY      | 20 - 4000 (20msec/step)                       | 700msec       |
| 003 | AGC SLOW DELAY     | 20 - 4000 (20msec/step)                       | 3000msec      |
| 004 | HOME FUNCTION      | SCOPE/FUNCTION                                | SCOPE         |
| 005 | MY CALL INDICATION | OFF - 5sec                                    | 1sec          |
| 006 | DISPLAY COLOR      | BLUE/GRAY/GREEN/ORANGE/PURPLE/RED/SKY<br>BLUE | BLUE          |
| 007 | DIMMER LED         | 1/2                                           | 2             |
| 008 | DIMMER TFT         | 0 - 15                                        | 8             |
| 009 | BAR MTR PEAK HOLD  | OFF/0.5/1.0/2.0 (sec)                         | OFF           |
| 010 | DVS RX OUT LEVEL   | 0 - 100                                       | 50            |
| 011 | DVS TX OUT LEVEL   | 0 - 100                                       | 50            |
| 012 | KEYER TYPE         | OFF/BUG/ELEKEY-A/ELEKEY-B/ELEKEY-Y/ACS        | ELEKEY-B      |
| 013 | KEYER DOT/DASH     | NOR/REV                                       | NOR           |
| 014 | CW WEIGHT          | 2.5 - 4.5                                     | 3.0           |
| 015 | BEACON INTERVAL    | OFF/1 - 240sec/270 - 690sec                   | OFF           |
| 016 | NUMBER STYLE       | 1290/AUNO/AUNT/A2NO/A2NT/12NO/12NT            | 1290          |
| 017 | CONTEST NUMBER     | 0 - 9999                                      | 1             |
| 018 | CW MEMORY 1        | TEXT/MESSAGE                                  | TEXT          |
| 019 | CW MEMORY 2        | TEXT/MESSAGE                                  | TEXT          |
| 020 | CW MEMORY 3        | TEXT/MESSAGE                                  | TEXT          |
| 021 | CW MEMORY 4        | TEXT/MESSAGE                                  | TEXT          |
| 022 | CW MEMORY 5        | TEXT/MESSAGE                                  | TEXT          |
| 023 | NB WIDTH           | 1/3/10msec                                    | 3msec         |
| 024 | NB REJECTION       | 10/30/50dB                                    | 30dB          |
| 025 | NB LEVEL           | 0 - 10                                        | 5             |
| 026 | BEEP LEVEL         | 0 - 100                                       | 50            |
| 027 | TIME ZONE          | -12:00 - 0:00 - +14:00                        | 0:00          |
| 028 | GPS/232C SELECT    | GPS/RS232C                                    | GPS           |
| 029 | 232C RATE          | 4800/9600/19200/38400 (bps)                   | 4800bps       |
| 030 | 232C TOT           | 10/100/1000/3000 (msec)                       | 10msec        |
| 031 | CAT RATE           | 4800/9600/19200/38400 (bps)                   | 4800bps       |
| 032 | CAT TOT            | 10/100/1000/3000 (msec)                       | 10msec        |
| 033 | CAT RTS            | ENABLE/DISABLE                                | ENABLE        |
| 034 | MEM GROUP          | ENABLE/DISABLE                                | DISABLE       |
| 035 | QUICK SPLIT FREQ   | -20 - 20kHz                                   | 5kHz          |
| 036 | TX TOT             | OFF/1 - 30 (min)                              | OFF (10※)     |
| 037 | MIC SCAN           | ENABLE/DISABLE                                | ENABLE        |
| 038 | MIC SCAN RESUME    | PAUSE/TIME                                    | TIME          |
| 039 | REF FREQ ADJ       | -25 - 0 - 25                                  | 0             |
| 040 | CLAR MODE SELECT   | RX/TX/TRX                                     | RX            |
| 041 | AM LCUT FREQ       | OFF/100Hz - 1000Hz (50Hz/step)                | OFF           |
| 042 | AM LCUT SLOPE      | 6dB/oct / 18dB/oct                            | 6dB/oct       |
| 043 | AM HCUT FREQ       | 700Hz - 4000Hz (50Hz/step) / OFF              | OFF           |
| 044 | AM HCUT SLOPE      | 6dB/oct / 18dB/oct                            | 6dB/oct       |
| 045 | AM MIC SELECT      | MIC/REAR                                      | MIC           |
| 046 | AM OUT LEVEL       | 0 - 100                                       | 50            |
| 047 | AM PTT SELECT      | DAKY/RTS/DTR                                  | DAKY          |
| 048 | AM PORT SELECT     | DATA/USB                                      | DATA          |
| 049 | AM DATA GAIN       | 0 - 100                                       | 50            |
| 050 | CW LCUT FREQ       | OFF/100Hz - 1000Hz(50Hz/step)                 | 250Hz         |
| 051 | CW LCUT SLOPE      | 6dB/oct / 18dB/oct                            | 18dB/oct      |
| 052 | CW HCUT FREQ       | 700Hz - 4000Hz(50Hz/step) / OFF               | 1200Hz        |

※: European Version.



# MENU MODE

| No. | Menu Function      | Available Settings                                                                                  | Default Value |
|-----|--------------------|-----------------------------------------------------------------------------------------------------|---------------|
| 053 | CW HCURT SLOPE     | 6dB/oct / 18dB/oct                                                                                  | 18dB/oct      |
| 054 | CW OUT LEVEL       | 0 - 100                                                                                             | 50            |
| 055 | CW AUTO MODE       | OFF/50M/ON                                                                                          | OFF           |
| 056 | CW BK-IN TYPE      | SEMI/FULL                                                                                           | SEMI          |
| 057 | CW BK-IN DELAY     | 30 - 3000 (msec)                                                                                    | 200msec       |
| 058 | CW WAVE SHAPE      | 2/4 (msec)                                                                                          | 4msec         |
| 059 | CW FREQ DISPLAY    | DIRECT FREQ/PITCH OFFSE                                                                             | PITCH OFFSE   |
| 060 | PC KEYING          | OFF/DAKY/RTS/DTR                                                                                    | OFF           |
| 061 | QSK DELAY TIME     | 15/20/25/30(msec)                                                                                   | 15msec        |
| 062 | DATA MODE          | PSK/OTHERS                                                                                          | PSK           |
| 063 | PSK TONE           | 1000/1500/2000(Hz)                                                                                  | 1000Hz        |
| 064 | OTHER DISP (SSB)   | -3000 - 0 - 3000(10Hz/step)                                                                         | 0Hz           |
| 065 | OTHER SHIFT (SSB)  | -3000 - 0 - 3000(10Hz/step)                                                                         | 0Hz           |
| 066 | DATA LCUT FREQ     | OFF/100 - 1000(Hz)(50Hz/step)                                                                       | 300Hz         |
| 067 | DATA LCUT SLOPE    | 6dB/oct / 18dB/oct                                                                                  | 18dB/oct      |
| 068 | DATA HCURT FREQ    | 700Hz - 4000Hz(50Hz/step)/OFF                                                                       | 3000Hz        |
| 069 | DATA HCURT SLOPE   | 6dB/oct / 18dB/oc                                                                                   | 18dB/oct      |
| 070 | DATA IN SELECT     | REAR/MIC                                                                                            | REAR          |
| 071 | DATA PTT SELECT    | DAKY/RTS/DTR                                                                                        | DAKY          |
| 072 | DATA PORT SELECT   | DATA/USB                                                                                            | DATA          |
| 073 | DATA OUT LEVEL     | 0 - 100                                                                                             | 50            |
| 074 | FM MIC SELECT      | MIC/REAR                                                                                            | MIC           |
| 075 | FM OUT LEVEL       | 0 - 100                                                                                             | 50            |
| 076 | FM PKT PTT SELECT  | DAKY/RTS/DTR                                                                                        | DAKY          |
| 077 | FM PKT PORT SELECT | DATA/USB                                                                                            | DATA          |
| 078 | FM PKT TX GAIN     | 0 - 100                                                                                             | 50            |
| 079 | FM PKT MODE        | 1200/9600                                                                                           | 1200          |
| 080 | RPT SHIFT 28MHz    | 0 - 1000kHz (10kHz/step)                                                                            | 100kHz        |
| 081 | RPT SHIFT 50MHz    | 0 - 4000kHz (10kHz/step)                                                                            | 1000kHz       |
| 082 | RPT SHIFT 144MHz   | 0 - 4000kHz (10kHz/step)                                                                            | 600kHz        |
| 083 | RPT SHIFT 430MHz   | 0 - 10000kHz (10kHz/step)                                                                           | 5000kHz       |
| 084 | ARS 144MHz         | OFF/ON                                                                                              | ON            |
| 085 | ARS 430MHz         | OFF/ON                                                                                              | ON            |
| 086 | DCS POLARITY       | Tn-Rn/Tn-Riv/Tiv-Rn/Tin-Riv                                                                         | Tn-Rn         |
| 087 | RADIO ID           | Displays the unique transceiver ID<br>(The ID is unique to each transceiver and cannot be changed.) | *****         |
| 088 | DIGITAL SQL TYPE   | OFF/CODE/BREAK                                                                                      | OFF           |
| 089 | DIGITAL SQL CODE   | 000 - 126                                                                                           | 000           |
| 090 | GM DISPLY          | DISTANCE/STRENGTH                                                                                   | DISTANCE      |
| 091 | DISTANCE           | km/mile                                                                                             | mile          |
| 092 | AMS TX MODE        | AUTO/MANUAL/DN/VW/ANALOG                                                                            | AUTO          |
| 093 | STANDBY BEEP       | ON/OFF                                                                                              | ON            |
| 094 | RTTY LCUT FREQ     | OFF/100Hz - 1000Hz (50Hz/step)                                                                      | 300Hz         |
| 095 | RTTY LCUT SLOPE    | 6dB/oct / 18dB/oct                                                                                  | 18dB/oct      |
| 096 | RTTY HCURT FREQ    | 700Hz - 4000Hz (50Hz/step) / OFF                                                                    | 3000Hz        |
| 097 | RTTY HCURT SLOPE   | 6dB/oct / 18dB/oct                                                                                  | 18dB/oct      |
| 098 | RTTY SHIFT PORT    | SHIFT/DTR/RTS                                                                                       | SHIFT         |
| 099 | RTTY POLARITY-RX   | NOR/REV                                                                                             | NOR           |
| 100 | RTTY POLARITY-TX   | NOR/REV                                                                                             | NOR           |
| 101 | RTTY OUT LEVEL     | 0 - 100                                                                                             | 50            |
| 102 | RTTY SHIFT FREQ    | 170/200/425/850 (Hz)                                                                                | 170Hz         |
| 103 | RTTY MARK FREQ     | 1275/2125 (Hz)                                                                                      | 2125Hz        |



| No. | Menu Function      | Available Settings                           | Default Value |
|-----|--------------------|----------------------------------------------|---------------|
| 104 | SSB LCUT FREQ      | OFF/100Hz - 1000Hz (50Hz/step)               | 100Hz         |
| 105 | SSB LCUT SLOPE     | 6dB/oct / 18dB/oct                           | 6dB/oct       |
| 106 | SSB HCUT FREQ      | 700Hz - 4000Hz (50Hz/step) / OFF             | 3000Hz        |
| 107 | SSB HCUT SLOPE     | 6dB/oct / 18dB/oct                           | 6dB/oct       |
| 108 | SSB MIC SELECT     | MIC/REAR                                     | MIC           |
| 109 | SSB OUT LEVEL      | 0 - 100                                      | 50            |
| 110 | SSB PTT SELECT     | DAKY/RTS/DTR                                 | DAKY          |
| 111 | SSB PORT SELECT    | DATA/USB                                     | DATA          |
| 112 | SSB TX BPF         | 100-3000/100-2900/200-2800/300-2700/400-2600 | 300-2700      |
| 113 | APF WIDTH          | NARROW/MEDIUM/WIDE                           | MEDIUM        |
| 114 | CONTOUR LEVEL      | -40 - 0 - 20                                 | -15           |
| 115 | CONTOUR WIDTH      | 1 - 11                                       | 10            |
| 116 | IF NOTCH WIDTH     | NARROW/WIDE                                  | WIDE          |
| 117 | SCP DISPLAY MODE   | SPECTRUM/WATER FALL                          | SPECTRUM      |
| 118 | SCP START CYCLE    | OFF/3/5/10 (sec)                             | OFF           |
| 119 | ASC DIAL SPEED     | 0.25kHz/0.5kHz/1kHz/2kHz/4kHz (sec)/DISABLE  | 4kHz/sec      |
| 120 | SCP SPAN FREQ      | 50/100/200/500/1000 (kHz)                    | 100kHz        |
| 121 | PRMTRC EQ1 FREQ    | OFF/100 - 700 (100/step)                     | OFF           |
| 122 | PRMTRC EQ1 LEVEL   | -20 - 0 - 10                                 | 5             |
| 123 | PRMTRC EQ1 BWTH    | 1 - 10                                       | 10            |
| 124 | PRMTRC EQ2 FREQ    | OFF/700 - 1500 (100/step)                    | OFF           |
| 125 | PRMTRC EQ2 LEVEL   | -20 - 0 - 10                                 | 5             |
| 126 | PRMTRC EQ2 BWTH    | 1 - 10                                       | 10            |
| 127 | PRMTRC EQ3 FREQ    | OFF/1500 - 3200 (100/step)                   | OFF           |
| 128 | PRMTRC EQ3 LEVEL   | -20 - 0 - 10                                 | 5             |
| 129 | PRMTRC EQ3 BWTH    | 1 - 10                                       | 10            |
| 130 | P-PRMTRC EQ1 FREQ  | OFF/100 - 700 (100/step)                     | 200           |
| 131 | P-PRMTRC EQ1 LEVEL | -20 - 0 - 10                                 | 0             |
| 132 | P-PRMTRC EQ1 BWTH  | 1 - 10                                       | 2             |
| 133 | P-PRMTRC EQ2 FREQ  | OFF/700 - 1500 (100/step)                    | 800           |
| 134 | P-PRMTRC EQ2 LEVEL | -20 - 0 - 10                                 | 0             |
| 135 | P-PRMTRC EQ2 BWTH  | 1 - 10                                       | 1             |
| 136 | P-PRMTRC EQ3 FREQ  | OFF/1500 - 3200 (100/step)                   | 2100          |
| 137 | P-PRMTRC EQ3 LEVEL | -20 - 0 - 10                                 | 0             |
| 138 | P-PRMTRC EQ3 BWTH  | 1 - 10                                       | 1             |
| 139 | HF TX MAX POWER    | 5 - 100                                      | 100           |
| 140 | 50M TX MAX POWER   | 5 - 100                                      | 100           |
| 141 | 144M TX MAX POWER  | 0 - 50                                       | 50            |
| 142 | 430M TX MAX POWER  | 0 - 50                                       | 50            |
| 143 | TUNER SELECT       | OFF/INTERNAL/EXTERNAL/ATAS/LAMP              | INTERNAL      |
| 144 | VOX SELECT         | MIC/DATA                                     | MIC           |
| 145 | VOX GAIN           | 0 - 100                                      | 50            |
| 146 | VOX DELAY          | 30 - 3000 (msec)                             | 500msec       |
| 147 | ANTI VOX GAIN      | 0 - 100                                      | 50            |
| 148 | DATA VOX GAIN      | 0 - 100                                      | 50            |
| 149 | DATA VOX DELAY     | 30 - 3000 (msec)                             | 100msec       |
| 150 | ANTI DVOX GAIN     | 0 - 100                                      | 0             |
| 151 | EMERGENCY FREQ TX  | DISABLE/ENABLE                               | DISABLE       |

## 001 AGC FAST DELAY

Function: Sets the AGC-FAST DELAY voltage decay characteristics.

Available Values: 20 - 4000msec (20msec/step)

Default Setting: 300msec

Description: Sets the AGC voltage decay characteristics in 20 msec steps after the input signal level becomes lower than the AGC detection level and the HOLD time is over.

## 002 AGC MID DELAY

Function: Sets the AGC-MID DELAY voltage decay characteristics.

Available Values: 20 - 4000msec (20msec/step)

Default Setting: 700msec

Description: Sets the AGC voltage decay characteristics in 20 msec steps after the input signal level becomes lower than the AGC detection level and the HOLD time is over.

## 003 AGC SLOW DELAY

Function: Sets the AGC-SLOW DELAY voltage decay characteristics.

Available Values: 20 - 4000msec (20msec/step)

Default Setting: 3000msec

Description: Sets the AGC voltage decay characteristics in 20 msec steps after the input signal level becomes lower than the AGC detection level and the HOLD time is over.

## 004 HOME FUNCTION

Function: Selects the information to be displayed on the HOME screen.

Available Values: SCOPE/FUNCTION

Default Setting: SCOPE

Description: Selects the information to be displayed on the HOME screen (main screen).

SCOPE:

Displays the scope screen.

FUNCTION:

Displays the function key screen.

## 005 MY CALL INDICATION

Function: Sets the display time duration for MY CALL.

Available Values: OFF - 5sec

Default Setting: 1sec

Description: Sets the display time duration for a message such as the call sign set from MY CALL when turning on the power.

## 006 DISPLAY COLOR

Function: Sets the background color of the VFO-A frequency display field.

Available Values: BLUE/GRAY/GREEN/ORANGE/PURPLE/RED/SKY BLUE

Default Setting: BLUE

Description: Sets the background color of the VFO-A frequency display field. The color may be previewed before the selection is confirmed.

## 007 DIMMER LED

Function: Sets the key LED brightness level.

Available Values: 1 / 2

Default Setting: 2

Description: Sets the brightness level of the LED indicator located above the Main Tuning Dial knob. The effect of the changes may be observed as the brightness level is adjusted. "1" is the darkest.

## 008 DIMMER TFT

Function: Sets the TFT display brightness level.

Available Values: 0 - 15

Default Setting: 8

Description: Sets the brightness level of the TFT display. The effect of the changes may be observed as the brightness level is adjusted. The higher the setting, the brighter the illumination becomes.

## 009 BAR MTR PEAK HOLD

Function: Sets the bar meter peak hold.

Available Values: OFF/0.5/1.0/2.0 (sec)

Default Setting: OFF

Description: Sets the time length the maximum value reading is shown on the meter (peak hold).

OFF:

Disables the peak hold function.

0.5/1.0/2.0:

Holds the maximum value for the time length that is set.

## 010 DVS RX OUT LEVEL

Function: Sets the voice memory monitoring level.

Available Values: 0 - 100

Default: 50

Description: You can adjust the voice memory monitoring level. The higher the setting, the higher the output level becomes.

## 011 DVS TX OUT LEVEL

Function: Sets the microphone output level for the voice memory.

Available Values: 0 - 100

Default: 50

Description: The microphone output level may be adjusted to the operators own voice and preference. For example, the output level may be set differently between the microphone and the voice memory. The higher the setting, the higher the output level becomes.

## 012 KEYER TYPE

Function: Switches the keyer operation.

Available Values: OFF/BUG/ELEKEY-A/ELEKEY-B/  
ELEKEY-Y/ACS

Default Setting: ELEKEY-B

Description: Switches the keyer operation.

OFF:

Disables the keyer function.

BUG:

Functions as a “BUG key”. Only the “Dot” side is automatically generated (the “Dash” side is generated manually).

ELEKEY-A:

A code element (“Dot” or “Dash” side) is transmitted upon pressing both sides of the paddle.

ELEKEY-B:

Pressing both sides of the paddle transmits the currently generated “Dash” side followed by “Dot” side (or reverse order).

ELEKEY-Y:

Pressing both sides of the paddle transmits the currently generated “Dash” side followed by “Dot” side (or reverse order).

While transmitting the “Dash” side, the first transmitted “Dot” side will not be stored.

ACS:

Functions as the “Keyer with automatic spacing control feature” which sets spacing between characters precisely to be the same length as a dash (three dots in length).

## 013 KEYER DOT/DASH

Function: Reverses the connections of the CW paddle front panel key jack

Available Values: NOR/REV

Default Setting: NOR

Description: Reverses the connections of the CW paddle.

NOR:

Press the right side of the paddle to transmit the “Dot” signal and press the left side of the paddle to transmit the “Dash” signal.

REV:

Press the left side of the paddle to transmit the “Dash” signal and press the right side of the paddle to transmit the “Dot” signal.

## 014 CW WEIGHT

Function: Adjusts the keyer CW weight.

Available Values: 2.5 - 4.5

Default Setting: 3.0

Description: Sets the “Dot”：“Dash” ratio for the built-in electronic keyer.

## 015 BEACON INTERVAL

Function: Sets the interval time between repeats of the beacon message.

Available Values: OFF/1 - 240sec (1sec/step)/270 - 690sec (30sec/step)

Default Setting: OFF

Description: Sets the interval time between repeats of the beacon message.

A message (message memory/text memory) registered in the contest memory keyer, may be transmitted as a CW Beacon message.

If you do not want the message to repeat in a beacon mode, set this item to “OFF”.

## 016 NUMBER STYLE

Function: Selects the contest number “Cut” format for an imbedded contest number.

Available Values: 1290/AUNO/AUNT/A2NO/A2NT/  
12NO/12NT

Default Setting: 1290

Description: Abbreviates numbers “One”, “Two”, “Nine” and “Zero” using Morse code when sending the contest number.

1290:

Does not abbreviate the contest number.

AUNO:

Abbreviates to “A” for “One”, “U” for “Two”, “N” for “Nine”, and “O” for “Zero”.

AUNT:

Abbreviates to “A” for “One”, “U” for “Two”, “N” for “Nine”, and “T” for “Zero”.

A2NO:

Abbreviates to “A” for “One”, “N” for “Nine”, and “O” for “Zero”. Does not abbreviate number “Two”.

A2NT:

Abbreviates to “A” for “One”, “N” for “Nine”, and “T” for “Zero”. Does not abbreviate number “Two”.

12NO:

Abbreviates to “N” for “Nine”, and “O” for “Zero”. Does not abbreviate numbers “One” and “Two”.

12NT:

Abbreviates to “N” for “Nine”, and “T” for “Zero”. Does not abbreviate numbers “One” and “Two”.

## 017 CONTEST NUMBER

Function: Enters the contest number using Morse code.

Available Values: 0 - 9999

Default Setting: 1

Description: Enters the contest number using Morse code (page 84).

## 018 CW MEMORY 1

Function: Selects the registration method for the contest memory keyer "CW MEMORY 1".

Available Values: TEXT/MESSAGE

Default Setting: TEXT

Description: Selects how to register text to the contest memory keyer "CW MEMORY 1".

TEXT:

Use the optional **FH-2** or the touch panel to enter text (page 87).

MESSAGE:

Use the keyer to register text to the contest memory keyer (page 84).

## 019 CW MEMORY 2

Function: Selects the registration method for the contest memory keyer "CW MEMORY 2".

Available Values: TEXT/MESSAGE

Default Setting: TEXT

Description: Selects how to register text to the contest memory keyer "CW MEMORY 2".

TEXT:

Use the optional **FH-2** or the touch panel to enter text (page 87).

MESSAGE:

Use the keyer to register text to the contest memory keyer (page 84).

## 020 CW MEMORY 3

Function: Selects the registration method for the contest memory keyer "CW MEMORY 3".

Available Values: TEXT/MESSAGE

Default Setting: TEXT

Description: Selects how to register text to the contest memory keyer "CW MEMORY 3".

TEXT:

Use the optional **FH-2** or the touch panel to enter text (page 87).

MESSAGE:

Use the keyer to register text to the contest memory keyer (page 84).

## 021 CW MEMORY 4

Function: Selects the registration method for the contest memory keyer "CW MEMORY 4".

Available Values: TEXT/MESSAGE

Default Setting: TEXT

Description: Selects how to register text to the contest memory keyer "CW MEMORY 4".

TEXT:

Use the optional **FH-2** or the touch panel to enter text (page 87).

MESSAGE:

Use the keyer to register text to the contest memory keyer (page 84).

## 022 CW MEMORY 5

Function: Selects the registration method for the contest memory keyer "CW MEMORY 5".

Available Values: TEXT/MESSAGE

Default Setting: TEXT

Description: Selects how to register text to the contest memory keyer "CW MEMORY 5".

TEXT:

Use optional **FH-2** or the touch panel to enter text (page 87).

MESSAGE:

Use the keyer to register text to the contest memory keyer (page 84).

## 023 NB WIDTH

Function: Sets the duration of the noise blanking pulse to match various types of noise compatible with the noise blanker function.

Available Values: 1msec/3msec/10msec

Default Setting: 3msec

Description: Reduces long duration noise as well as pulse noise by changing the setting.

## 024 NB REJECTION

Function: Selects the level of noise attenuation.

Available Values: 10dB/30dB/50dB

Default Setting: 30dB

## 025 NB LEVEL

Function: Sets the noise blanker level.

Available Values: 0 - 10

Default Setting: 5

Description: Sets the noise blanker level to reduce pulse noise such as noise caused by automotive ignition systems. The higher the setting, the higher the noise blanker level becomes.

## 026 BEEP LEVEL

Function: Sets the beep level.

Available Values: 0 - 100

Default Setting: 50

Description: Sets the beep sound volume level. The higher the setting, the louder the sound becomes.

## 027 TIME ZONE

Function: Sets the time zone.

Available Values: -12:00 - 0:00 - +14:00

Default Setting: 0:00

Description: Sets the time difference with respect to the UTC (Coordinated Universal Time) in 30 minute increments.

## 028 GPS/232C SELECT

Function: Selects mode of **GPS/CAT** jack.

Available Values: GPS/RS232C

Default Setting: GPS

Description: Selects the device that is to be connected to the **GPS/CAT** jack on the rear panel.

GPS:

Enables connection to an external GPS device.

RS232C:

Enables connection to a CAT command input.

## 029 232C RATE

Function: Sets the baud rate for a **GPS/CAT** jack command input.

Available Values: 4800/9600/19200/38400 bps

Default Setting: 4800 bps

Description: Sets the baud rate for an **RS-232C** command input.

## 030 232C TOT

Function: Sets the Time-Out Timer for an **RS-232C** command input.

Available Values: 10/100/1000/3000 (msec)

Default Setting: 10msec

Description: Sets the Time-Out Timer countdown time for a **RS-232C** command input.

## 031 CAT RATE

Function: Sets the baud rate for a CAT command input.

Available Values: 4800/9600/19200/38400 bps

Default Setting: 4800 bps

Description: Sets the baud rate for a CAT command input.

## 032 CAT TOT

Function: Sets the Time-Out Timer for a CAT command input.

Available Values: 10/100/1000/3000 (msec)

Default Setting: 10msec

Description: Sets the Time-Out Timer countdown time for a CAT command input.

## 033 CAT RTS

Function: Configures the CAT RTS port setting.

Available Values: ENABLE/DISABLE

Default Setting: ENABLE

Description: Monitors the computer using the RTS signal.

ENABLE:

Monitors the computer status using the RTS signal.

DISABLE:

Disables the monitoring function.

## 034 MEM GROUP

Function: Sets the memory group function.

Available Values: ENABLE/DISABLE

Default Setting: DISABLE

Description: Set this setting to "ENABLE" to divide the memory channels into 6 groups.

## 035 QUICK SPLIT FREQ

Function: Selects the amount of frequency offset when the Quick Split feature is enabled.

Available Values: -20 - 0 - 20kHz (1kHz/step)

Default Setting: 5kHz

Description: Sets the amount of frequency offset when the Quick Split feature is enabled.

Advice: Press and hold the **SPLIT** button on the front panel to activate VFO-B split frequency operation, thereby offsetting the transmitter by the specified frequency.

Each time the **SPLIT** button is pressed and held, the offset frequency is increased by the setting amount.

## 036 TX TOT

Function: Sets the Time-Out Timer countdown time.

Available Values: OFF/1 - 30min

Default Setting: OFF (10 min, European Version)

Description: Forces the transceiver to return to receiving mode after continuous transmission of the programmed time.

## 037 MIC SCAN

Function: Sets the microphone automatic scanning function to ON or OFF.

Available Values: ENABLE/DISABLE

Default Setting: ENABLE

Description: Selects the operation of the **UP/DWN** buttons on the microphone.

ENABLE (ON):

Starts scanning automatically by pressing and holding the **UP/DWN** button for 1 second or more (Scanning continues even after releasing the button). To stop scanning, press the **UP/DWN** button again briefly or press the **PTT** button to transmit.

DISABLE (OFF):

Scans only while pressing and holding the **UP/DWN** button. To stop scanning, release the button.

## 038 MIC SCAN RESUME

Function: Sets the Scan Resume function.

Available Values: PAUSE/TIME

Default Setting: TIME

Description: Sets the Scan Resume function (in AM/FM mode).

PAUSE:

During automatic scanning, the scanner will hold until the signal disappears.

TIME:

If the signal does not disappear within five seconds, the scanner will resume scanning for the next active channel (frequency). If there is no signal, the scanner continues scanning automatically.



## 039 REF FREQ ADJ

Function: Adjusts the reference oscillator.

Available Values: -25 - 0 - 25

Default Setting: 0

Description: The frequency may be calibrated when connecting a frequency counter to the transceiver, or when receiving a standard frequency such as WWV or WWVH.

## 040 CLAR MODE SELECT

Function: Selects the clarifier operation.

Available Values: RX/TX/TRX

Default Setting: RX

Description: Selects the clarifier operation when the **CLAR** button is pressed.

RX:

Functions as the RX clarifier which changes only the receiver frequency without changing transmit frequency.

TX:

Functions as the TX clarifier which changes only the transmit frequency without changing the receiver frequency.

TRX:

Functions as the TRX clarifier which changes the transmit frequency and the receiver frequency simultaneously.

## 041 AM LCUT FREQ

Function: Sets the low-frequency cutoff audio filter in AM mode.

Available Values: OFF/100Hz - 1000Hz (50Hz/step)

Default Setting: OFF

Description: This is the low-frequency cutoff audio filter in AM mode.

The cutoff frequency can be set at 50 Hz increments between 100 Hz and 1000 Hz.

## 042 AM LCUT SLOPE

Function: Sets the slope of the low-frequency cutoff audio filter in AM mode.

Available Values: 6dB/oct / 18dB/oct

Default Setting: 6dB/oct

Description: Selects the slope of the low-frequency cutoff audio filter in AM mode.

## 043 AM HCUT FREQ

Function: Sets the high-frequency cutoff audio filter in AM mode.

Available Values: OFF/700Hz - 4000Hz (50Hz/step)

Default Setting: OFF

Description: This is the high-frequency cutoff audio filter in AM mode.

The cutoff frequency can be set at 50 Hz increments between 700 Hz and 4000 Hz.

## 044 AM HCUT SLOPE

Function: Sets the slope of the high-frequency cutoff audio filter in AM mode.

Available Values: 6dB/oct / 18dB/oct

Default Setting: 6dB/oct

Description: Selects the slope of the high-frequency cutoff audio filter in AM mode.

## 045 AM MIC SELECT

Function: Selects the microphone input jack for AM mode.

Available Values: MIC/REAR

Default Setting: MIC

Description: Selects the microphone input jack to be used in AM mode.

FRONT:

Audio is input from the **MIC** jack on the front panel.

DATA:

Disables the microphone circuit on the front panel and inputs audio/data from the **USB** jack or **RTTY/DATA** jack on the rear panel.

## 046 AM OUT LEVEL

Function: Sets the level of the receive AM signal output from the **RTTY/DATA** jack.

Available Values: 0 - 100

Default Setting: 50

## 047 AM PTT SELECT

Function: Sets the PTT control for the AM transmit signal.

Available Values: DAKY/RTS/DTR

Default Setting: DAKY

Description: Selects the PTT control method for the AM transmit.

DAKY:

Controls the AM transmit signal from the **RTTY/DATA** jack (pin 3) on the rear panel.

DTR:

Controls the AM transmit signal from the USB virtual COM/DTR ports.

RTS:

Controls the AM transmit signal from the USB virtual COM/RTS ports.

## 048 AM PORT SELECT

Function: Selects the input jack of the AM signal.

Available Values: DATA/USB

Default Setting: DATA

Description: Selects the input jack of the AM signal when "045 AM MIC SELECT" is set to "DATA".

DATA:

Inputs from the **RTTY/DATA** jack on the rear panel.

USB:

Inputs from the **USB** jack on the rear panel.

## 049 AM DATA GAIN

Function: Sets the level of the AM signal input when “045 AM MIC SELECT” is set to “DATA”.

Available Values: 0 - 100

Default Setting: 50

## 050 CW LCUT FREQ

Function: Sets the low-frequency cutoff audio filter in CW mode.

Available Values: OFF/100Hz - 1000Hz (50Hz/step)

Default Setting: 250Hz

Description: This is the low-frequency cutoff audio filter in CW mode.

The cutoff frequency can be set at 50 Hz increments between 100 Hz and 1000 Hz.

## 051 CW LCUT SLOPE

Function: Sets the slope of the low-frequency cutoff audio filter in CW mode.

Available Values: 6dB/oct / 18dB/oct

Default Setting: 18dB/oct

Description: Selects the slope of the low-frequency cutoff audio filter in CW mode.

## 052 CW HCUT FREQ

Function: Sets the high-frequency cutoff audio filter in CW mode.

Available Values: OFF/700Hz - 4000Hz (50Hz/step)

Default Setting: 1200Hz

Description: This is the high-frequency cutoff audio filter in CW mode.

The cutoff frequency can be set at 50 Hz increments between 700 Hz and 4000 Hz.

## 053 CW HCUT SLOPE

Function: Sets the slope of the high-frequency cutoff audio filter in CW mode.

Available Values: 6dB/oct / 18dB/oct

Default Setting: 18dB/oct

Description: Selects the slope of the high-frequency cutoff audio filter in CW mode.

## 054 CW OUT LEVEL

Function: Sets the level of the CW signal output from the **RTTY/DATA** jack.

Available Values: 0 - 100

Default Setting: 50

## 055 CW AUTO MODE

Function: Enables/disables CW keying while operating on SSB.

Available Values: OFF/50M (50MHz)/ON

Default Setting: OFF

Description:

OFF:

Disables CW keying while operating on SSB.

50M:

Enables CW keying while operating SSB on 50 MHz (but not HF).

ON:

Enables CW keying while operating SSB on all TX bands.

## 056 CW BK-IN TYPE

Function: Sets the CW brake-in function.

Available Values: SEMI/FULL

Default Setting: SEMI

Description: Selects the CW brake-in function.

SEMI:

A brief delay is provided after the CW keying operation, before the transceiver returns to receive mode.

The receiver recovery time may be changed using MENU “057 CW BK-IN DELAY”.

FULL:

The transceiver immediately returns to receive mode after every CW key-up (QSK mode).

## 057 CW BK-IN DELAY

Function: Sets the CW delay time.

Available Values: 30msec - 3000msec (10msec/step)

Default Setting: 200msec

Description: In semi break-in mode, this setting determines the delay time before returning to receive mode after the CW keying operation.

The delay time can be changed in 10 msec steps between 30 msec and 3000 msec.

## 058 CW WAVE SHAPE

Function: Selects the CW carrier wave-form shape (rise/fall times).

Available Values: 2ms/4ms

Default Setting: 4ms (msec)

Description: Sets the rise and fall times of the keying envelope in CW mode (transmit waveform).



## 059 CW FREQ DISPLAY

Function: Sets the PITCH frequency offset.

Available Values: DIRECT FREQ/PITCH OFFSET

Default Setting: PITCH OFFSET

Description: Sets the displayed frequency offset when switching the transceiver mode between SSB and CW.

DIRECT FREQ:

Displays the same frequency in CW mode as in SSB mode without any offset added.

PITCH OFFSET:

Displays the frequency in CW mode with the pitch offset added. When CW BFO is set to USB, the displayed frequency will be increased and when CW BFO is set to LSB, the displayed frequency will be decreased with pitch offset added.

## 060 PC KEYING

Function: Sets the **RTTY/DATA** jack for keying.

Available Values: OFF/DAKY/RTS/DTR

Default Setting: OFF

Description:

OFF:

Disables keying from DATA PTT (pin 3) of the **RTTY/DATA** jack.

DAKY:

Controls the transmit from the **RTTY/DATA** jack (pin 3) on the rear panel.

RTS:

Controls the transmit from the USB virtual COM/RTS ports.

DTR:

Controls the transmit from the USB virtual COM/DTR ports.

## 061 QSK DELAY TIME

Function: Sets the time delay before transmitting the keying signal.

Available Values: 15/20/25/30msec

Default Setting: 15msec

Description: The delay time in QSK mode before transmitting the CW signal may be set in 5 msec steps.

## 062 DATA MODE

Function: Selects the operating scheme in DATA mode.

Available Values: PSK/OTHERS

Default Setting: PSK

Description: Selects the operating scheme (PSK or OTHERS) in DATA mode.

## 063 PSK TONE

Function: Set the PSK tone.

Available Values: 1000/1500/2000Hz

Default Setting: 1000Hz

Description: Selects the PSK tone frequency.

## 064 OTHER DISP (SSB)

Function: Sets the displayed frequency offset in DATA mode.

Available Values: -3000 - 0 - 3000Hz (10Hz/step)

Default: 0Hz

Description: Sets the displayed frequency offset in DATA mode. The frequency can be set in steps of 10 Hz.

## 065 OTHER SHIFT (SSB)

Function: Sets the carrier point in DATA mode.

Available Values: -3000 - 0 - 3000Hz (10Hz/step)

Default: 0Hz

Description: Sets the carrier point in DATA mode. The frequency can be set in steps of 10 Hz.

## 066 DATA LCUT FREQ

Function: Sets the low-frequency cutoff audio filter in DATA mode.

Available Values: OFF/100Hz - 1000Hz (50Hz/step)

Default Setting: 300Hz

Description: This is the low-frequency cutoff audio filter in DATA mode.

The cutoff frequency can be set at 50 Hz increments between 100 Hz and 1000 Hz.

## 067 DATA LCUT SLOPE

Function: Sets the slope of the low-frequency cutoff audio filter in DATA mode.

Available Values: 6dB/oct / 18dB/oct

Default Setting: 18dB/oct

Description: Selects the slope setting of the low-frequency cutoff audio filter in DATA mode.

## 068 DATA HCUT FREQ

Function: Sets the high-frequency cutoff audio filter in DATA mode.

Available Values: OFF/700Hz - 4000Hz (50Hz/step)

Default Setting: 3000Hz

Description: This is the high-frequency cutoff audio filter in DATA mode.

The cutoff frequency can be set at 50 Hz increments between 700 Hz and 4000 Hz.

## 069 DATA HCUT SLOPE

Function: Sets the slope of the high-frequency cutoff audio filter in DATA mode.

Available Values: 6dB/oct / 18dB/oct

Default Setting: 18dB/oct

Description: Selects the slope setting of the high-frequency cutoff audio filter in DATA mode.

## 070 DATA IN SELECT

Function: Selects the input jack for DATA mode.

Available Values: MIC/REAR

Default Setting: REAR

Description: Selects the input jack to be used in DATA mode.

MIC:

Inputs signals from the **MIC** jack on the front panel.

REAR:

Inputs signals from the **USB** jack or **RTTY/DATA** jack on the rear panel.

## 071 DATA PTT SELECT

Function: Sets the PTT control during the sending/receiving of data.

Available Values: DAKY/RTS/DTR

Default Setting: DAKY

Description: Selects the PTT control method during the sending/receiving of data.

DAKY:

Controls the transmit from the **RTTY/DATA** jack (pin 3) on the rear panel.

DTR:

Controls the transmit from the USB virtual COM/DTR ports.

RTS:

Controls the transmit from the USB virtual COM/RTS ports.

## 072 DATA PORT SELECT

Function: Selects the input jack of the data signal.

Available Values: DATA/USB

Default Setting: DATA

Description: Selects the input jack of the data signal when "070 DATA IN SELECT" is set to "REAR".

DATA:

Inputs the data from the **RTTY/DATA** jack on the rear panel.

USB:

Inputs the data from the **USB** jack on the rear panel.

## 073 DATA OUT LEVEL

Function: Sets the output level during the sending/receiving of data (PSK31, SSTV, etc.).

Available Values: 0 - 100

Default Setting: 50

Description: Sets the output level during the sending/receiving of data (PSK31, SSTV, etc.). The higher the setting, the higher the output level becomes.

## 074 FM MIC SELECT

Function: Selects the microphone input jack for FM mode.

Available Values: MIC/REAR

Default Setting: MIC

Description: Selects the microphone input jack to be used in FM mode.

FRONT:

Inputs from the **MIC** jack on the front panel.

DATA:

Disables the microphone circuit on the front panel and inputs from the **USB** jack or **PACKET** jack on the rear panel.

## 075 FM OUT LEVEL

Function: Sets the level of the FM receiving signal output from the **RTTY/DATA** jack.

Available Values: 0 - 100

Default Setting: 50

## 076 FM PKT PTT SELECT

Function: Sets the PTT control for the FM signal.

Available Values: DAKY/RTS/DTR

Default Setting: DAKY

Description: Selects the PTT control method for the FM signal.

DAKY:

Controls the transmit from the **RTTY/DATA** jack (pin 3) on the rear panel.

DTR:

Controls the transmit from the USB virtual COM/DTR ports.

RTS:

Controls the transmit from the USB virtual COM/RTS ports.

## 077 FM PKT PORT SELECT

Function: Selects the input jack of the FM packet signal.

Available Values: DATA/USB

Default Setting: DATA

Description: Selects the input jack of the FM signal when "074 FM MIC SELECT" is set to "DATA".

DATA:

Inputs from the **RTTY/DATA** jack on the rear panel.

USB:

Inputs from the **USB** jack on the rear panel.

## 078 FM PKT TX GAIN

Function: Sets the transmission gain during the FM packet operation.

Available Values: 0 - 100

Default Setting: 50

## 079 FM PKT MODE

Function: Sets the baud rate (communication speed) during the FM packet operation.

Available Values: 1200/9600

Default Setting: 1200

## 080 RPT SHIFT 28MHz

Function: Sets the RPT offset frequency on the 28 MHz band.

Available Values: 0 - 1000kHz (10kHz/step)

Default Setting: 100kHz

Description: Sets the repeater offset frequency on the 28 MHz band.

## 081 RPT SHIFT 50MHz

Function: Sets the RPT offset frequency on the 50 MHz band.

Available Values: 0 - 4000kHz (10kHz/step)

Default Setting: 1000kHz

Description: Sets the repeater offset frequency on the 50 MHz band.

## 082 RPT SHIFT 144MHz

Function: Sets the RPT offset frequency on the 144 MHz band.

Available Values: 0 - 4000kHz (10kHz/step)

Default Setting: 600kHz

Description: Sets the repeater offset frequency on the 144 MHz band.

## 083 RPT SHIFT 430MHz

Function: Sets the RPT offset frequency on the 430 MHz band.

Available Values: 0 - 10000kHz (10kHz/step)

Default Setting: 5000kHz

Description: Sets the repeater offset frequency on the 430 MHz band.

## 084 ARS 144MHz

Function: Sets the ARS function on the 144 MHz band.

Available Values: OFF/ON

Default Setting: ON

Description:

OFF:

Disables the ARS function.

ON:

Enables the ARS function.

## 085 ARS 430MHz

Function: Sets the ARS function on the 430 MHz band.

Available Values: OFF/ON

Default Setting: ON

Description:

OFF:

Disables the ARS function.

ON:

Enables the ARS function.

## 086 DCS POLARITY

Function: Selects the DCS code polarity.

Available Values: Tn-Rn/Tn-Riv/Tiv-Rn/Tiv-Riv

Default Setting: Tn-Rn

Description: When using the DCS function, the transceiver can transmit/receive the DCS code with the phase reversed.

Tn-Rn:

Transmit (in phase), receive (in phase)

Tn-Riv:

Transmit (in phase), receive (reverse phase)

Tiv-Rn:

Transmit (reverse phase), receive (in phase)

Tiv-Riv:

Transmit (reverse phase), receive (reverse phase)

## 087 RADIO ID

Function: Displays the unique transceiver ID assigned at the time of shipment (5-digit alphanumeric characters).

Available Values: Cannot be changed.

Default Setting: Differs depending on the transceiver.

## 088 DIGITAL SQL TYPE

Function: Sets the squelch type in digital mode.

Available Values: OFF/CODE/BREAK

Default Setting: OFF

Description: Selects the squelch type in digital mode.

OFF:

Outputs the audio whenever the transceiver receives a digital signal from another YAESU transceiver.

CODE:

The audio is output only when the SQL code of the received signal matches the setting.

BREAK:

With the BREAK setting on, the audio is output, whenever a signal is received from another station with the BREAK setting on, regardless of the code setting.

## 089 DIGITAL SQL CODE

Function: Sets the squelch code for digital mode.

Available Values: 000 - 126

Default Setting: 000

## 090 GM DISPLAY

Function: Sorts the group stations to be displayed when using the GM function.

Available Values: DISTANCE/STRENGTH

Default Setting: DISTANCE

Description:

DISTANCE:

Active group member stations are displayed according to their distance from this station, beginning with the closest member station.

STRENGTH:

Active group member stations are displayed according to their signal strengths, beginning with the strongest signal first.

## 091 DISTANCE

Function: Sets the unit of measure to indicate the distance between your station and communication stations when using the GM function.

Available Values: km/mile

Default Setting: mile

## 092 AMS TX MODE

Function: Sets the operation of the AMS function.

Available Values: AUTO/MANUAL/DN/VW/ANALOG

Default Setting: AUTO

Description: When using the AMS (AUTO) function, the transceiver selects one of the three transmission modes automatically according to the received signal.

AUTO:

Selects one of the transmission modes automatically according to the received signal.

MANUAL:

By briefly pressing the **PTT** switch, the operating mode may be switched between digital and analog mode.

DN:

Transmits in DN mode.

VW:

Transmits in VW mode.

ANALOG:

Transmits in FM mode (analog).

## 093 STANDBY BEEP

Function: Sets the Standby Beep function for digital communications.

Available Values: OFF/ON

Default Setting: ON

Description: During a digital communication, an audible beep sounds to indicate that the contact station has completed a transmission (Standby Beep function).

## 094 RTTY LCUT FREQ

Function: Sets the low-frequency cutoff audio filter in RTTY mode.

Available Values: OFF/100Hz - 1000Hz (50Hz/step)

Default Setting: 300Hz

Description: This is the low-frequency cutoff audio filter in RTTY mode.

The cutoff frequency can be set at 50 Hz increments between 100 Hz and 1000 Hz.

## 095 RTTY LCUT SLOPE

Function: Sets the slope of the low-frequency cutoff audio filter in RTTY mode.

Available Values: 6dB/oct / 18dB/oct

Default Setting: 18dB/oct

Description: Selects the slope setting of the low-frequency cutoff audio filter in RTTY mode.

## 096 RTTY HCUT FREQ

Function: Sets the high-frequency cutoff audio filter in RTTY mode.

Available Values: OFF/700Hz - 4000Hz (50Hz/step)

Default Setting: 3000Hz

Description: This is the high-frequency cutoff audio filter in RTTY mode.

The cutoff frequency can be set at 50 Hz increments between 700 Hz and 4000 Hz.

## 097 RTTY HCUT SLOPE

Function: Sets the slope of the high-frequency cutoff audio filter in RTTY mode.

Available Values: 6dB/oct / 18dB/oct

Default Setting: 18dB/oct

Description: Selects the slope setting of the high-frequency cutoff audio filter in RTTY mode.

## 098 RTTY SHIFT PORT

Function: Sets the SHIFT input jack for RTTY mode.

Available Values: SHIFT/DTR/RTS

Default Setting: SHIFT

Description: Selects the SHIFT input jack for RTTY mode.

SHIFT:

Inputs from the **RTTY/DATA** jack (pin 4) on the rear panel.

DTR:

Controls the signal from the USB virtual COM/DTR ports.

RTS:

Controls the signal from the USB virtual COM/RTS ports.

## 099 RTTY POLARITY-RX

Function: Sets the shift direction for receiving in RTTY mode.

Available Values: NOR/REV

Default Setting: NOR

Description: Sets the shift direction for receiving in RTTY mode.

NOR:

The space frequency will be lower than the mark frequency.

REV:

The mark frequency will be lower than the space frequency.

## 100 RTTY POLARITY-TX

Function: Sets the shift direction for transmitting in RTTY mode.

Available Values: NOR/REV

Default Setting: NOR

Description: Sets the shift direction for transmitting in RTTY mode.

NOR:

The space frequency will be lower than the mark frequency.

REV:

The mark frequency will be lower than the space frequency.

## 101 RTTY OUT LEVEL

Function: Sets the output level during the sending/receiving of data in RTTY mode.

Available Values: 0 - 100

Default Setting: 50

Description: Sets the data output level during the sending/receiving of data in RTTY mode. The higher the setting, the higher the output level becomes.

## 102 RTTY SHIFT FREQ

Function: Sets the shift width for RTTY mode.

Available Values: 170/200/425/850 (Hz)

Default Setting: 170Hz

Description: Sets the shift width for RTTY mode.

## 103 RTTY MARK FREQ

Function: Sets the mark frequency for RTTY mode.

Available Values: 1275/2125 (Hz)

Default Setting: 2125Hz

Description: Sets the mark frequency for RTTY mode.

## 104 SSB LCUT FREQ

Function: Sets the low-frequency cutoff audio filter in SSB mode.

Available Values: OFF/100Hz - 1000Hz (50Hz/step)

Default Setting: 100Hz

Description: This is the low-frequency cutoff audio filter in SSB mode.

The cutoff frequency can be set at 50 Hz increments between 100 Hz and 1000 Hz.

## 105 SSB LCUT SLOPE

Function: Sets the slope of the low-frequency cutoff audio filter in SSB mode.

Available Values: 6dB/oct / 18dB/oct

Default Setting: 6dB/oct

Description: Selects the slope setting of the low-frequency cutoff audio filter in SSB mode.

## 106 SSB HCUT FREQ

Function: Sets the high-frequency cutoff audio filter in SSB mode.

Available Values: OFF/700Hz - 4000Hz (50Hz/step)

Default Setting: 3000Hz

Description: This is the high-frequency cutoff audio filter in SSB mode.

The cutoff frequency can be set at 50 Hz increments between 700 Hz and 4000 Hz.

## 107 SSB HCUT SLOPE

Function: Sets the slope of the high-frequency cutoff audio filter in SSB mode.

Available Values: 6dB/oct / 18dB/oct

Default Setting: 6dB/oct

Description: Selects the slope setting of the high-frequency cutoff audio filter in SSB mode.

## 108 SSB MIC SELECT

Function: Selects the microphone input jack for SSB mode.

Available Values: MIC/REAR

Default Setting: MIC

Description: Selects the microphone input jack to be used in SSB mode.

FRONT:

Inputs from the **MIC** jack on the front panel.

DATA:

Disables the microphone circuit on the front panel and inputs from the **USB** jack or **RTTY/DATA** jack on the rear panel.

## 109 SSB OUT LEVEL

Function: Sets the level of the SSB receiving signal output from the **RTTY/DATA** jack.

Available Values: 0 - 100

Default Setting: 50

## 110 SSB PTT SELECT

Function: Sets the PTT transmit control for the SSB signal.

Available Values: DAKY/RTS/DTR

Default Setting: DAKY

Description: Selects the PTT transmit control method for the SSB signal.

DAKY:

Controls the transmit signal from the **RTTY/DATA** jack (pin 3) on the rear panel.

DTR:

Controls the transmit signal from the USB virtual COM/DTR ports.

RTS:

Controls the transmit signal from the USB virtual COM/RTS ports.

## 111 SSB PORT SELECT

Function: Sets the input jack of the SSB signal.

Available Values: DATA/USB

Default Setting: DATA

Description: Selects the input jack of the SSB signal when "108 SSB MIC SELECT" is set to "DATA".

DATA:

Inputs from the **RTTY/DATA** jack on the rear panel.

USB:

Inputs from the **USB** jack on the rear panel.



## 112 SSB TX BPF

Function: Sets the frequency characteristics of the DSP band-pass filter for transmitting in SSB mode.

Available Values: 100-3000/100-2900/200-2800/300-2700/400-2600

Default Setting: 300-2700Hz

Description: Selects the frequency characteristics setting of the DSP band-pass filter when transmitting in SSB mode.

## 113 APF WIDTH

Function: Sets the bandwidth of the audio peak filter.

Available Values: NARROW/MEDIUM/WIDE

Default Setting: MEDIUM

Description: In CW mode the APF peak center frequency is set according to the CW PITCH frequency and the chosen APF bandwidth value. In order to listen to the desired signal comfortably, select one of the three bandwidths of the peak filter.

## 114 CONTOUR LEVEL

Function: Adjusts the GAIN of the CONTOUR circuit.

Available Values: -40 - 0 - 20

Default Setting: -15

Description: Sets level of the attenuation or the gain of the CONTOUR circuit.

## 115 CONTOUR WIDTH

Function: Sets the bandwidth ("Q") of the CONTOUR circuit.

Available Values: 1 - 11

Default Setting: 10

Description: Sets the bandwidth (WIDTH) of the CONTOUR circuit.

## 116 IF NOTCH WIDTH

Function: Sets the attenuation bandwidth characteristic of the DSP IF notch filter on the VFO-A.

Available Values: NARROW/WIDE

Default Setting: WIDE

Description: Selects the attenuation bandwidth characteristic setting of the DSP IF notch filter to "NARROW" or "WIDE".

## 117 SCP DISPLAY MODE

Function: Sets the scope for either the spectrum or the waterfall display.

Available Values: SPECTRUM/WATER FALL

Default Setting: SPECTRUM

Description: Selects the type of display when the scope feature activates.

SPECTRUM:

Enables the spectrum display.

WATER FALL:

Enables the waterfall display.

## 118 SCP START CYCLE

Function: Selects the sweep interval of the Spectrum Scope feature.

Available Values: OFF/3sec/5sec/10sec

Default Setting: OFF

Description: The scope spectrum is repeatedly swept according to the set interval.

## 119 ASC DIAL SPEED

Function: Selects the start condition of the Dial Auto Scope feature whenever the Main Tuning Dial is turned.

Available Values: 0.25/0.5/1/2/4kHz (sec)/DISABLE

Default Setting: 4kHz/sec

Description: When the Main Tuning Dial knob is rotated at the set speed in ASC mode, the spectrum scope sweeping is started automatically.

## 120 SCP SPAN FREQ

Function: Sets the bandwidth of the spectrum scope sweeping.

Available Values: 50/100/200/500/1000 (kHz)

Default Setting: 100kHz

Description: Sets the bandwidth (SPAN) of the spectrum scope.

## 121 PRMTRC EQ1 FREQ

Function: Sets the center frequency of the low range for the 3 band parametric microphone equalizer.

Available Values: 100 - 700 (Hz)/OFF (100Hz/step)

Default Setting: OFF

Description: Selects the center frequency setting of the low range of the 3 band parametric microphone equalizer between "100 Hz" and "700 Hz".

## 122 PRMTRC EQ1 LEVEL

Function: Sets the gain for the low range of the 3 band parametric microphone equalizer.

Available Values: -20 - 0 - 10 (dB)

Default Setting: 5

Description: Adjusts the gain for the low range of the 3 band parametric microphone equalizer between "-20 dB" and "+10 dB".

## 123 PRMTRC EQ1 BWTH

Function: Sets the width variation ("Q") for the low range of the 3 band parametric microphone equalizer.

Available Values: 1 - 10

Default Setting: 10

Description: Selects the value of the width (Q) for the low range for the 3 band parametric microphone equalizer between "1" and "10".

## 124 PRMTRC EQ2 FREQ

Function: Sets the center frequency for the middle range of the 3 band parametric microphone equalizer.

Available Values: 700 - 1500 (Hz)/OFF (100Hz/step)

Default Setting: OFF

Description: Selects the center frequency setting for the middle range of the 3 band parametric microphone equalizer between “700 Hz” and “1500 Hz”.

## 125 PRMTRC EQ2 LEVEL

Function: Sets the gain for the middle range of the 3 band parametric microphone equalizer.

Available Values: -20 - 0 - 10 (dB)

Default Setting: 5

Description: Selects the gain setting for the middle range of the 3 band parametric microphone equalizer between “-20 dB” and “+10 dB”.

## 126 PRMTRC EQ2 BWTH

Function: Sets the width variation (“Q”) for the middle range of the 3 band parametric microphone equalizer.

Available Values: 1 - 10

Default Setting: 10

Description: Selects the width (“Q”) for the middle range of the 3 band parametric microphone equalizer between “1” and “10”.

## 127 PRMTRC EQ3 FREQ

Function: Sets the center frequency for the high range of the 3 band parametric microphone equalizer.

Available Values: 1500 - 3200 (Hz)/OFF (100Hz/step)

Default Setting: OFF

Description: Selects the center frequency setting for the high range of the 3 band parametric microphone equalizer between “1500 Hz” and “3200 Hz”.

## 128 PRMTRC EQ3 LEVEL

Function: Sets the gain for the high range of the 3 band parametric microphone equalizer.

Available Values: -20 - 0 - 10 (dB)

Default Setting: 5

Description: Selects the gain setting for the high range of the 3 band parametric microphone equalizer between “-20 dB” and “+10 dB”.

## 129 PRMTRC EQ3 BWTH

Function: Selects the width setting (“Q”) for the high range of the 3 band parametric microphone equalizer.

Available Values: 1 - 10

Default Setting: 10

Description: Selects the width (“Q”) setting for the high range of the 3 band parametric microphone equalizer between “1” and “10”.

## 130 P-PRMTRC EQ1 FREQ

Function: Sets the center frequency of the low range for the 3 band parametric microphone equalizer when the speech processor is activated.

Available Values: 100 - 700 (Hz)/OFF (100Hz/step)

Default Setting: 200

Description: Activates when the speech processor is “ON”. Adjusts the center frequency for the low range of the 3 band parametric microphone equalizer between “100 Hz” and “700 Hz”.

## 131 P-PRMTRC EQ1 LEVEL

Function: Selects the gain setting for the low range of the 3 band parametric microphone equalizer when the speech processor is activated.

Available Values: -20 - 0 - 10 (dB)

Default Setting: 0

Description: Activates when the speech processor is “ON” and sets the gain for the low range of the 3 band parametric microphone equalizer between “-20 dB” and “+10 dB”.

## 132 P-PRMTRC EQ1 BWTH

Function: Selects the width (“Q”) for the low range of the 3 band parametric microphone equalizer when the speech processor is activated.

Available Values: 1 - 10

Default Setting: 2

Description: Activates when the speech processor is “ON” and sets the width (“Q”) for the low range of the 3 band parametric microphone equalizer between “1” and “10”.

## 133 P-PRMTRC EQ2 FREQ

Function: Selects the center frequency for the middle range of the 3 band parametric microphone equalizer when the speech processor is activated.

Available Values: 700 - 1500 (Hz)/OFF (100Hz/step)

Default Setting: 800

Description: Selects the center frequency for the middle range of the 3 band parametric microphone equalizer between “700 Hz” and “1500 Hz” when the speech processor is activated.

## 134 P-PRMTRC EQ2 LEVEL

Function: Sets the gain for the middle range of the 3 band parametric microphone equalizer when the speech processor is activated.

Available Values: -20 - 0 - 10 (dB)

Default Setting: 0

Description: Selects the gain setting for the middle range of the 3 band parametric microphone equalizer between “-20 dB” and “+10 dB” when the speech processor is activated.



## 135 P-PRMTRC EQ2 BWTH

Function: Sets the width ("Q") for the middle range of the 3 band parametric microphone equalizer when the speech processor is activated.

Available Values: 1 - 10

Default Setting: 1

Description: Activates when the speech processor is "ON", and selects the width ("Q") setting for the middle range of the 3 band parametric microphone equalizer between "1" and "10".

## 136 P-PRMTRC EQ3 FREQ

Function: Sets the center frequency for the high range of the 3 band parametric microphone equalizer when the speech processor is activated.

Available Values: 1500 - 3200 (Hz)/OFF (100Hz/step)

Default Setting: 2100

Description: Activates when the speech processor is "ON", and selects the center frequency setting for the high range of the 3 band parametric microphone equalizer between "1500 Hz" and "3200 Hz".

## 137 P-PRMTRC EQ3 LEVEL

Function: Sets the gain for the high range of the 3 band parametric microphone equalizer when the speech processor is activated.

Available Values: -20 - 0 - 10 (dB)

Default Setting: 0

Description: Activates when the speech processor is "ON", and selects the gain setting for the high range of the 3 band parametric microphone equalizer between "-20 dB" and "+10 dB".

## 138 P-PRMTRC EQ3 BWTH

Function: Sets the width ("Q") for the high range of the 3 band parametric microphone equalizer when the speech processor is activated.

Available Values: 1 - 10

Default Setting: 1

Description: Activates when the speech processor is "ON", and sets the width ("Q") for the high range of the 3 band parametric microphone equalizer between "1" and "10".

## 139 HF TX MAX POWER

Function: Sets the transmit RF power output of the HF band.

Available Values: 5 - 100

Default Setting: 100

Description: Adjusts the setting of the HF bands transmitter power output.

## 140 50M TX MAX POWER

Function: Sets the transmit RF power output of the 50 MHz band.

Available Values: 5 - 100

Default Setting: 100

Description: Adjusts the setting of the 50 MHz band transmitter power output.

## 141 144 TX MAX POWER

Function: Sets the transmit RF power output of the 144 MHz band.

Available Values: 0 - 50

Default Setting: 50

Description: Adjusts the setting of the 144 MHz band transmitter power output.

## 142 430M TX MAX POWER

Function: Sets the transmit RF power output of the 430 MHz band.

Available Values: 0 - 50

Default Setting: 50

Description: Adjusts the setting of the 430 MHz band transmitter power output.

## 143 TUNER SELECT

Function: Sets the functions of the antenna tuner.

Available Values: OFF/INTERNAL/EXTERNAL/ATAS/LAMP

Default Setting: INTERNAL

Description: Selects the antenna tuner to be used or sets the connections for a linear amplifier.

INTERNAL:

Select this item when using the internal antenna tuner.

EXTERNAL:

Select this item when using the external antenna tuner (the optional **FC-40**, etc.).

ATAS:

Select this item when using the active tuning antenna system **ATAS-120A**.

LAMP:

Select this item when connecting the linear amplifier to the **TUN/LIN** jack on the rear panel.

OFF:

Select this item when not using the antenna tuner or the linear amplifier.

## 144 VOX SELECT

Function: Selects the function of the VOX operation.

Available Values: MIC/DATA

Default Setting: MIC

Description: Selects the function of the VOX operation.

MIC:

Operates via input from the **MIC** jack (microphone).

DATA:

Operates via input from the **RTTY/PKT** or **USB** jack.

## 145 VOX GAIN

Function: Sets the VOX gain.

Available Values: 0 - 100

Default Setting: 50

Description: Sets the operation sensitivity of the VOX circuit. "1" represents the minimum sensitivity and "100" represents the maximum sensitivity. The VOX operation sensitivity may be adjusted while transmitting the signal.

## 146 VOX DELAY

Function: Sets the VOX delay time.

Available Values: 30 - 3000 msec (10 msec/step)

Default Setting: 500 msec

Description: While operating VOX, the recovery time (delay time) before returning to receive mode from transmit mode may be set at 10 msec intervals. The delay time may be adjusted while transmitting the signal.

## 147 ANTI VOX GAIN

Function: Sets the VOX anti-trip.

Available Values: 0 - 100

Default Setting: 50

Description: The sensitivity of the anti-trip circuit may be adjusted so that the VOX circuit does not accidentally engage due to the sounds from the transceiver speaker. Increase the anti-trip value to the point that sounds from the transceiver speaker do not engage the transmitter while using VOX operation.

## 148 DATA VOX GAIN

Function: Sets the VOX GAIN while operating VOX during the sending/receiving of data (PSK31, RTTY, etc.).

Available Values: 0 - 100

Default Setting: 50

Description: Set the data input VOX gain to the point that the data signal reliably engages the transmitter, and also releases the transmit when there is no data signal.

## 149 DATA VOX DELAY

Function: Sets the VOX DELAY time while operating VOX during the sending/receiving of data (PSK31, RTTY, etc.).

Available Values: 30msec - 3000msec

Default Setting: 100msec

## 150 ANTI DVOX GAIN

Function: Sets the data VOX ant-trip.

Available Values: 0 - 100

Default Setting: 0

Description: The sensitivity of the anti-trip circuit may be adjusted so that the VOX circuit does not accidentally engage due to the received data while operating VOX. Increase the setting to a value that the VOX circuit does not engage due to the received data (the higher the value the greater the operation sensitivity).

## 151 EMERGENCY FREQ TX

Function: Enables TX/RX operation on the Alaska Emergency Channel, 5167.5kHz.

Available Values: ENABLE/DISABLE

Default Setting: DISABLE

Description: When this Menu Item is set to ENABLE, the spot frequency of 5167.5 kHz will be enabled. The Alaska Emergency Channel will be found between the PMS memory channel "P-9U" and the memory channel "01".

**Important:** The use of this frequency is restricted to stations operating in or near Alaska, and only for emergency purposes (never for routine operations). See §97.401(c) of the FCC regulations.

# INSTALLATION OF OPTIONAL ACCESSORIES

## FC-40 EXTERNAL AUTOMATIC ANTENNA TUNER (FOR WIRE ANTENNA)

The **FC-40** makes use of the control circuitry built into the transceiver, which allows the operator to control and monitor automatic operation of the **FC-40**, which mounts near the antenna feedpoint. The **FC-40** uses specially selected, thermally stable components, and is housed in a waterproof case to withstand severe environmental conditions with high reliability.

A carefully-chosen combination of solid-state switching components and high-speed relays allows the **FC-40** to match a wide variety of antennas to within a 2:1 SWR on any amateur band frequency (160 through 6 meters), typically in less than eight seconds. Transmitter power required for matching may be as little as 4 - 60 Watts, and matching settings are automatically stored in memory for instant recall when the same frequency range is selected later.

Please see the **FC-40** Operating Manual for detailed information.

### Interconnections to FT-991

After mounting the **FC-40**, connect the cables from the **FC-40** to the ANT and TUNER jacks on the rear panel of the **FT-991** Transceiver.

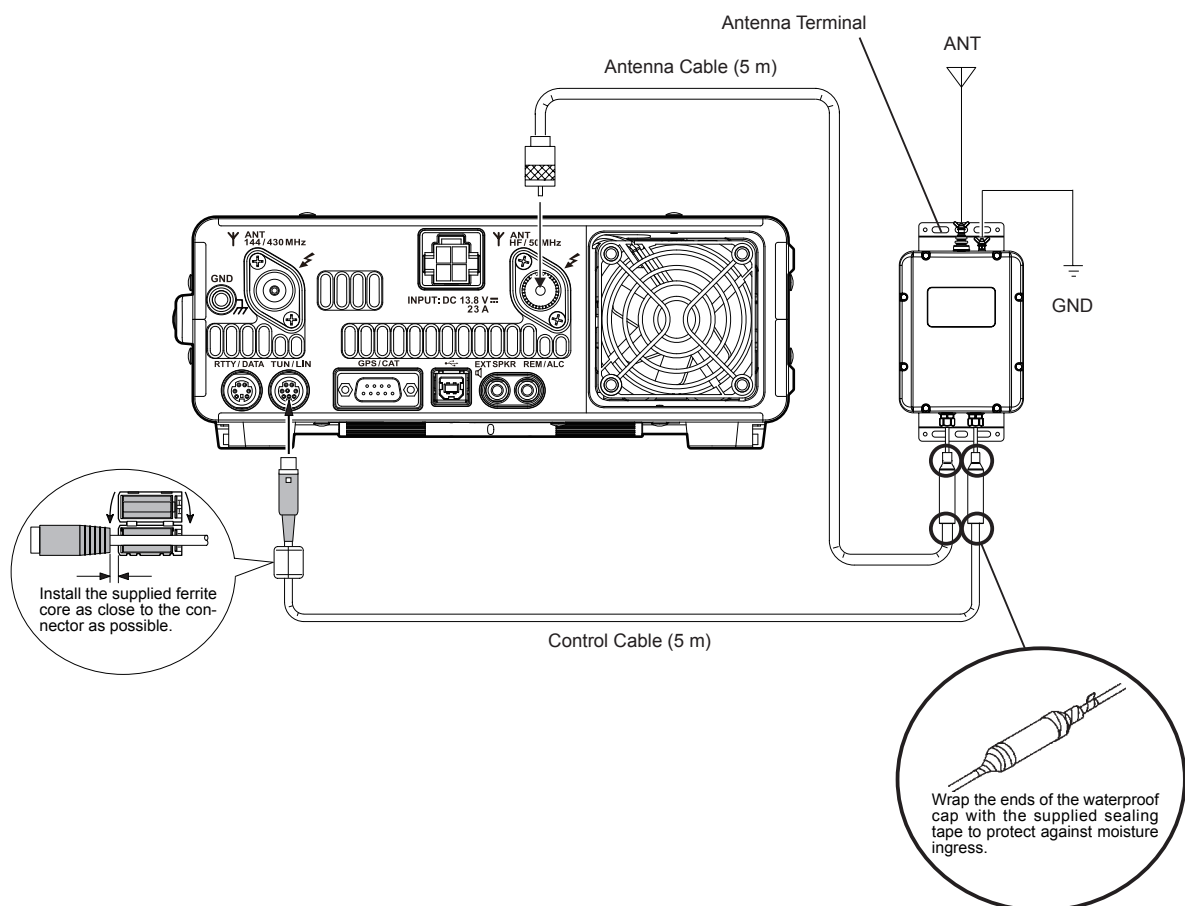

# INSTALLATION OF OPTIONAL ACCESSORIES

## FC-40 EXTERNAL AUTOMATIC ANTENNA TUNER (FOR WIRE ANTENNA)

### Setup the FT-991

The optional **FC-40** Automatic Antenna Tuner provides automatic tuning of a coaxial line to present nominal 50-ohm impedance to the **FT-991**'s ANT jack.

Before operation can begin, the **FT-991** microprocessor must be setup to accommodate the **FC-40** automatic tuner. This is done using the Menu Mode:

1. Press the **MENU(SETUP)** button to enter the Menu mode.
2. Rotate the **MULTI** knob to select the Menu Item "143 TUNER SELECT".
3. Touch **[SELECT]** on the LCD, then rotate the **MULTI** knob to select "EXTERNAL".

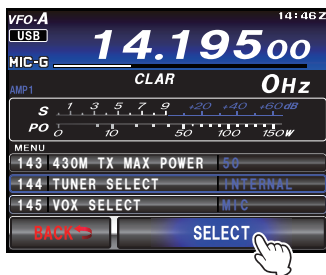

4. Touch **[ENTER]** on the LCD to save the new setting.

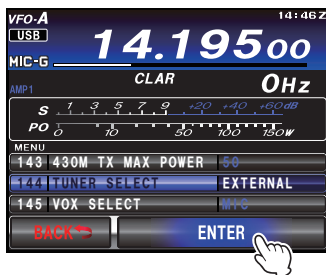

5. Press the **MENU(SETUP)** button or touch **[BACK]** on the LCD to exit to normal operation.

### Operation

1. Press the **TUNE** button briefly to activate the Automatic Antenna Tuner.
2. The "TUNER" icon will appear in the TFT display.
3. Press and hold the **TUNE** button for one second to begin automatic tuning. The transmitter will be engaged, and the "TUNER" icon will blink while tuning is in progress.
4. Tuning will stop automatically when a low SWR is achieved. You may Press the **TUNE** button while tuning is in progress, to cancel the automatic tuning.
5. To disable the Automatic Antenna Tuner, press the **TUNE** button briefly again.

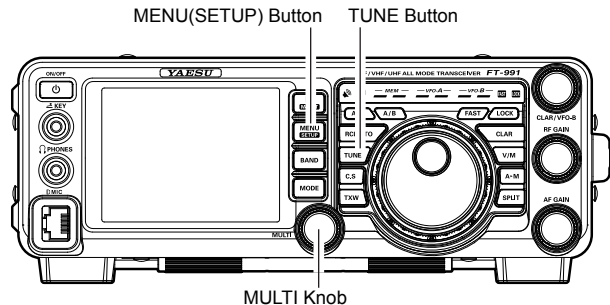

### NOTE:

- Be sure to connect a good earth ground to the GND terminal of the **FC-40**.
- The carrier signal transmits continuously while tuning is in progress. Please monitor the operating frequency before beginning the tuning process. Be sure you are not interfering with others who may already be using the frequency.
- It is normal to hear the sound of the relays while tuning is in progress.
- If the impedance cannot be matched by the **FC-40** better than 2:1, and the "HI-SWR" icon blinks, the microprocessor will not retain the tuning data for that frequency, as the **FC-40** presumes that you will want to adjust or repair your antenna system to correct the high SWR condition.

# INSTALLATION OF OPTIONAL ACCESSORIES

## ACTIVE-TUNING ANTENNA SYSTEM (ATAS-120A) OPERATION

**ATAS-120A** is a multi-band auto-tuning antenna that can be used in the amateur bands from the HF band to the UHF band (7/14/21/28(29) /50/144/430)

Using the active tuning mechanism, tuning can be carried out automatically by the control signal from **FT-991**. Please refer to the **ATAS-120A** Operating Manual for the assembly and installation of **ATAS-120A**.

### Interconnections to FT-991

Connect "**ATAS-120A**" to the ANT terminal of **FT-991** with a coaxial cable as shown in the diagram below.

#### ADVICE:

- Turn off the external power supply switch and the **FT-991** power supply switch first before connecting the cables.
- Grounding is required for the **ATAS-120A**. Make sure the antenna base is in contact with the car body to ensure proper grounding.

#### NOTE:

- Do not plug or unplug the connector of the antenna cable with wet hands. Do not plug or unplug the connector during transmission as well. This may result in electric shock, injury, etc.
- The unit cannot be used with both the antenna tuner and **ATAS-120A** connected.

When installing a dedicated VHF/UHF antenna simultaneously with the **ATAS-120A**, use a VHF/UHF antenna that does not include the HF - 50 MHz bands (144/430 MHz type).  
The reception circuit of the V/UHF band may be impacted by the transmitter energy from the **ATAS-120A**. In addition, install the 2 antennas as far away from each other as possible.

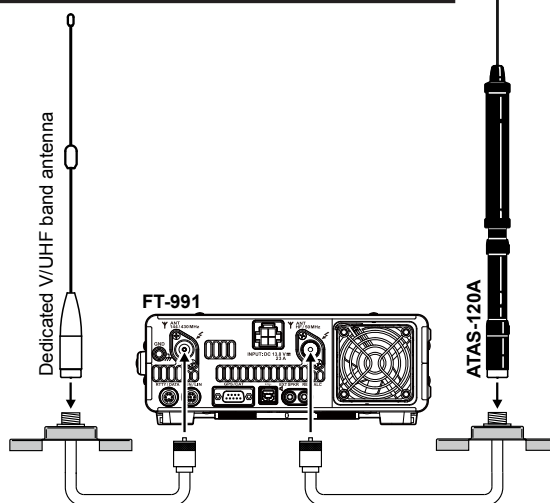

When using an antenna duplexer, the ANT terminal of the **ATAS-120A** and the HF/50 MHz ANT terminal of the **FT-991** must be connected in series and also insulated from the grounding in order to supply the control voltage for the **ATAS-120A**.

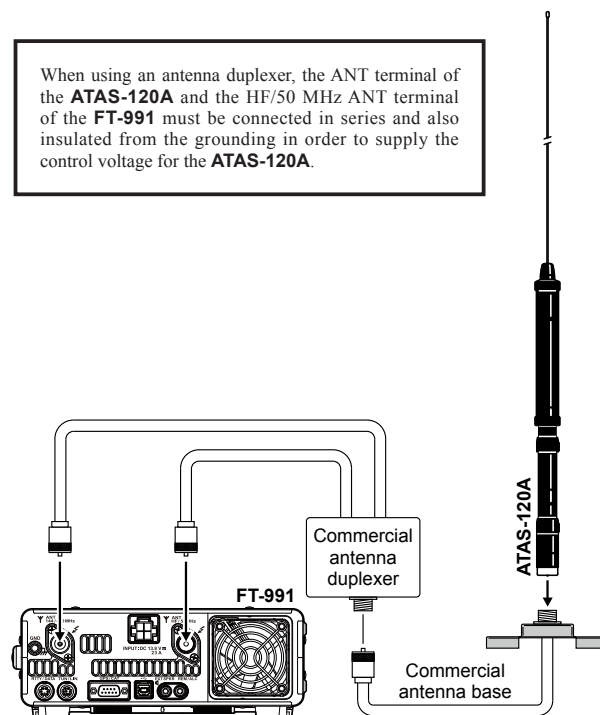

ATAS-120A connection example

# INSTALLATION OF OPTIONAL ACCESSORIES

## ACTIVE-TUNING ANTENNA SYSTEM (ATAS-120A) OPERATION

### Settings Before Operating the Tuner

1. Press the **MENU(SETUP)** button to enter the Menu mode.
2. Rotate the **MULTI** knob to select the Menu item “143 TUNER SELECT”.
3. Touch **[SELECT]** on the LCD, then rotate the **MULTI** knob to set this Menu item to “ATAS”. The “ATAS” icon will appear in the display.

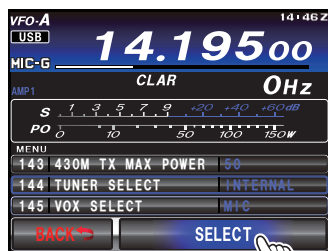

4. Touch **[ENTER]** on the LCD to save the new setting.



5. Press the **MENU(SETUP)** button or touch **[BACK]** on the LCD to exit to normal operation.

### Tuning Operation

The tuning of the **ATAS-120A** is carried out automatically.

1. Press the **TUNE** button to begin automatic tuning.  
The transmitter will be engaged, and the “**ATAS**” icon will blink while tuning is in progress.

Press the **TUNE** button to stop the tuning in the middle of the process.

#### NOTE:

- Check the grounding and installation conditions if “**HI-SWR**” is flashing (tuning cannot be carried out).
- As transmit signals are emitted during tuning, take note not to interfere with any communication that is already in progress on the frequency.

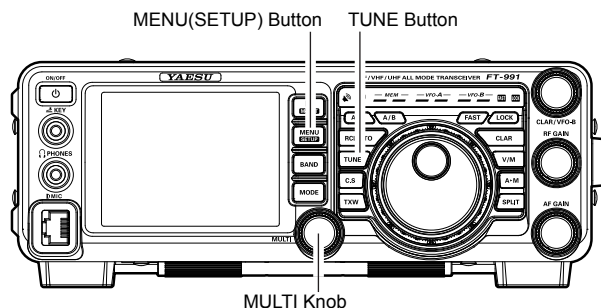

### Manual Tuning

Carry out the tuning of the **ATAS-120A** manually.

Press the **PTT** switch on the microphone to transmit and then press the **UP/DWN** button on the microphone to adjust the antenna until the meter indicates the minimum SWR.

The meter on the screen will automatically change to a SWR meter.



# INSTALLATION OF OPTIONAL ACCESSORIES

## MOUNTING BRACKET MMB-90 INSTALLATION

**MMB-90** is a mobile bracket used to mount the **FT-991** series in an automotive vehicle.

### Installation Procedure

1. Use the enclosed double-sided tape to temporarily mount the bracket at the installation location and then fasten the bracket securely with the enclosed screws so that it does not loosen or detach due to vibrations etc.

Mount the unit securely using commercial stays etc. if the installation location is weak.

If you are mounting the unit using tapping screws, pay due attention to the strength of the installation location and check that the bracket does not detach easily.

2. Use the enclosed knob screws to mount the main transceiver unit to **MMB-90**.

### NOTE:

To install the **MMB-90**, before commencing work, first use the following points as a guide to find a suitable installation location that will allow the transceiver to be easily operated.

- Please choose a location that will not affect the operation of the air bag system for cars equipped with air bags.
- That will not obstruct the field of view in front.
- That will not impede driving.
- That will not result in danger to the passengers in the assistant driver's seat and rear seats etc.
- That is not exposed to direct sunlight and hot air etc.
- That is well-ventilated.

Select a flat mounting surface. If the mounting surface is not flat, the bracket may be distorted, resulting in the inability to mount the transceiver.

Be sure to use screws of the specified size to install each part according to the specified method. Malfunctions will result if screws of the wrong sizes are used, or if the unit is mounted wrongly.

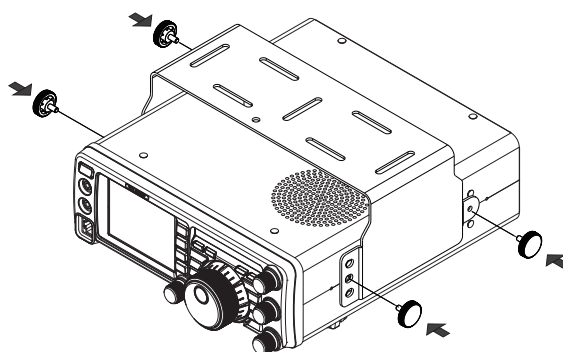
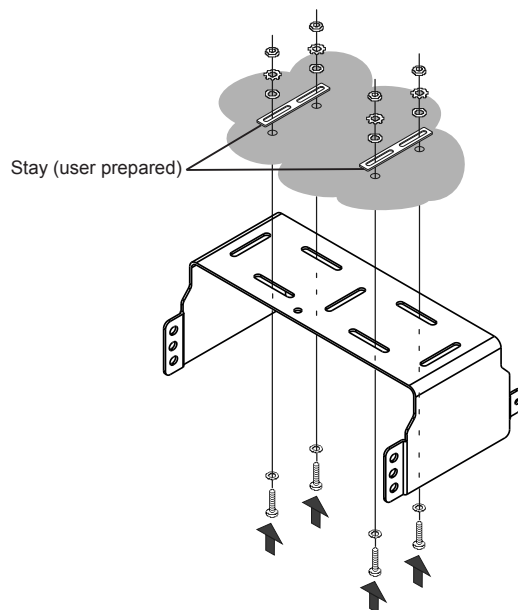

The viewing angle of the transceiver may be adjusted by changing the location of the front mounting screws.

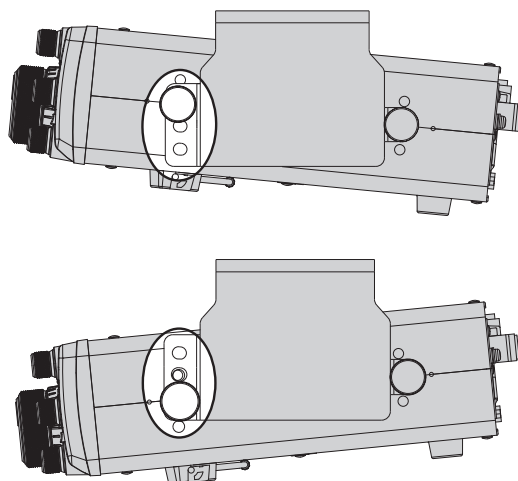



# SPECIFICATIONS

## General

|                                     |                                                                                                                                                                         |
|-------------------------------------|-------------------------------------------------------------------------------------------------------------------------------------------------------------------------|
| <b>Rx Frequency Range:</b>          | 30 kHz - 56 MHz, 118 MHz - 164 MHz, 420 MHz - 470 MHz (operating)<br>1.8 MHz - 54 MHz, 144 MHz - 148 MHz, 430 MHz - 450 MHz (specified performance, Amateur bands only) |
| <b>Tx Frequency Ranges:</b>         | 1.8 MHz - 54 MHz, 144 MHz - 148 MHz, 430 MHz - 450 MHz (Amateur bands only)                                                                                             |
| <b>Frequency Stability:</b>         | ±0.5 ppm (after 1 minute @+14 °F to +122 °F [-10 °C to +50 °C])                                                                                                         |
| <b>Operating Temperature Range:</b> | +14 °F to +122 °F (-10 °C to +50 °C)                                                                                                                                    |
| <b>Emission Modes:</b>              | A1A (CW), A3E (AM), J3E (LSB, USB), F3E (FM), F7W (C4FM), F2D                                                                                                           |
| <b>Frequency Steps:</b>             | 5/10 Hz (SSB, CW, & AM), 100 Hz (FM, C4FM)                                                                                                                              |
| <b>Antenna Impedance:</b>           | 50 Ohms, unbalanced<br>16.7 - 150 Ohms, unbalanced (Tuner ON, 1.8 MHz - 30 MHz Amateur bands)<br>25 - 100 Ohms, unbalanced (Tuner ON, 50 MHz Amateur band)              |
| <b>Power Consumption (Approx.):</b> | Rx (no signal) 1.8 A<br>Rx (signal present) 2.2 A<br>Tx 23 A (HF/50 MHz 100 W), 15 A (144/430 MHz 50 W)                                                                 |
| <b>Supply Voltage:</b>              | DC 13.8 V ± 15% (Negative Ground)                                                                                                                                       |
| <b>Dimensions (WxHxD):</b>          | 9.0" x 3.2" x 10.0" (229 x 80 x 253 mm)                                                                                                                                 |
| <b>Weight (Approx.):</b>            | 9.5 lbs (4.3 kg)                                                                                                                                                        |

## Transmitter

|                                        |                                                                                                                                                        |
|----------------------------------------|--------------------------------------------------------------------------------------------------------------------------------------------------------|
| <b>Power Output:</b>                   | 5 - 100 watts (2 - 25 watts AM carrier)                                                                                                                |
| <b>Modulation Types:</b>               | J3E (SSB): Balanced,<br>A3E (AM): Low-Level (Early Stage),<br>F3E (FM): Variable Reactance<br>F7W (C4FM): 4-level FSK                                  |
| <b>Maximum FM Deviation:</b>           | ±5.0 kHz/±2.5 kHz                                                                                                                                      |
| <b>Harmonic Radiation:</b>             | Better than -50 dB (1.8 MHz - 30 MHz Amateur bands)<br>Better than -63 dB (50 MHz Amateur band)<br>Better than -60 dB (144 MHz, 430 MHz Amateur bands) |
| <b>SSB Carrier Suppression:</b>        | At least 50 dB below peak output                                                                                                                       |
| <b>Undesired Sideband Suppression:</b> | At least 50 dB below peak output                                                                                                                       |
| <b>Bandwidth:</b>                      | 3 kHz (LSB/USB), 500 Hz (CW), 6 kHz (AM), 16 kHz (FM/C4FM)                                                                                             |
| <b>Audio Response (SSB):</b>           | Not more than -6 dB from 300 to 2700 Hz                                                                                                                |
| <b>Microphone Impedance:</b>           | 600 Ohms (200 to 10 kOhms)                                                                                                                             |



| <b>A</b>                                        |     |
|-------------------------------------------------|-----|
| A/B Button.....                                 | 20  |
| A=B Button.....                                 | 20  |
| About ATU Memories.....                         | 62  |
| About ATU Operation.....                        | 62  |
| About Coaxial Cable.....                        | 11  |
| About GPS Positioning.....                      | 110 |
| About the Display.....                          | 22  |
| Accessories & Options.....                      | 5   |
| Active-Tuning Antenna System (ATAS-120A).....   | 141 |
| Adjustable Receiver Audio Filter.....           | 58  |
| Adjusting the Clock.....                        | 8   |
| Adjusting the Main Tuning Dial Torque.....      | 7   |
| Adjusting the Noise Blanker Level.....          | 47  |
| Adjusting the SSB Transmitted Bandwidth.....    | 67  |
| AF GAIN Knob.....                               | 21  |
| AGC.....                                        | 57  |
| Alaska Emergency Frequency: 5167.5 khz.....     | 106 |
| A>M Button.....                                 | 21  |
| AM Mode Transmission.....                       | 59  |
| AMS (Automatic Mode Select) Operation.....      | 38  |
| Antenna Considerations.....                     | 11  |
| ANT Jack (144/430MHz).....                      | 25  |
| ANT Jack (HF/50MHz).....                        | 26  |
| ARS.....                                        | 93  |
| ATAS-120A.....                                  | 141 |
| ATT (Attenuator).....                           | 45  |
| Attenuator.....                                 | 45  |
| ATU Operation.....                              | 61  |
| Audio Peak Filter.....                          | 56  |
| Automatic Gain Control.....                     | 57  |
| Automatic Mode Select.....                      | 38  |
| Automatic Repeater Shift (ARS).....             | 93  |
| Available Options.....                          | 6   |
| <b>B</b>                                        |     |
| BAND Button.....                                | 19  |
| Band Stack Operation.....                       | 37  |
| Base Station Wire Stand.....                    | 7   |
| Basic Operation.....                            | 30  |
| Before You Begin.....                           | 7   |
| <b>C</b>                                        |     |
| C4FM Mode (Digital Mode) Operation.....         | 95  |
| Changing the Frequency of the Home Channel..... | 99  |
| Checking a Memory Channel Status.....           | 101 |
| Choosing the Desired Memory Group.....          | 105 |
| CLAR Button.....                                | 21  |
| CLAR (Clarifier) Operation.....                 | 34  |
| Clarifier Operation.....                        | 23  |
| CLAR/VFO-B Knob.....                            | 21  |
| Clock.....                                      | 23  |
| Connection of Antenna and Power Cables.....     | 13  |
| Connection of Headphone.....                    | 14  |
| Connection of Microphone.....                   | 14  |
| Connection of Remote Control Keypad.....        | 14  |

|                                               |    |
|-----------------------------------------------|----|
| Contest Memory Keyer.....                     | 84 |
| Contest Number Programming.....               | 85 |
| CONTOUR Control.....                          | 48 |
| Convenience Features.....                     | 38 |
| Convenient Memory functions.....              | 97 |
| C.S Button.....                               | 20 |
| C.S (Custom Switch).....                      | 37 |
| Current Mode (Modulation Form) Indicator..... | 22 |
| Custom Switch.....                            | 37 |
| CW Convenience Features.....                  | 82 |
| CW Delay Time Setting.....                    | 83 |
| CW Pitch Adjustment.....                      | 83 |
| CW Spotting (Zero-Beating).....               | 82 |

| <b>D</b>                                 |     |
|------------------------------------------|-----|
| DATA (PSK) Operation.....                | 118 |
| DC IN Jack.....                          | 25  |
| Digital Mode Operation.....              | 95  |
| Digital Noise Reduction (DNR).....       | 54  |
| Digital NOTCH Filter (DNF).....          | 54  |
| DIMMER.....                              | 35  |
| Displaying the Position Information..... | 112 |
| DNF.....                                 | 54  |
| DNR.....                                 | 54  |

| <b>E</b>                                        |     |
|-------------------------------------------------|-----|
| Electronic Keyer.....                           | 78  |
| Enhancing Transmit Signal Quality.....          | 63  |
| Entering the Location Information Manually..... | 112 |
| epeater Operation.....                          | 92  |
| Erasing Memory Channel Data.....                | 101 |
| EXT SPKR Jack.....                              | 26  |

| <b>F</b>                                    |     |
|---------------------------------------------|-----|
| FAST Button.....                            | 21  |
| FAST Indicators.....                        | 24  |
| FC-40 External Automatic Antenna Tuner..... | 139 |
| FH-2 Remote Control Switches.....           | 28  |
| F(M-LIST) Button.....                       | 19  |
| FM Mode Operation.....                      | 91  |
| Front Panel Controls & Switches.....        | 18  |
| Full Reset.....                             | 10  |
| Function Menu.....                          | 23  |

| <b>G</b>                            |     |
|-------------------------------------|-----|
| General Description.....            | 1   |
| GM Function.....                    | 113 |
| GND.....                            | 25  |
| GPS/CAT Jack.....                   | 25  |
| GPS Function.....                   | 110 |
| GPS Signal Capturing Indicator..... | 23  |
| Grounding.....                      | 12  |

| <b>H</b>              |    |
|-----------------------|----|
| HI-SWR Indicator..... | 22 |
| Home Channel.....     | 99 |

| <b>I</b>                                                     |     |
|--------------------------------------------------------------|-----|
| Icons.....                                                   | 22  |
| IF Noise Blanker (NB).....                                   | 47  |
| IF NOTCH Filter.....                                         | 53  |
| IF SHIFT Operation.....                                      | 49  |
| Inputting the Call Sign.....                                 | 9   |
| Installation and Interconnections.....                       | 14  |
| Installation of Optional Accessories.....                    | 139 |
| Intercept Point Optimization.....                            | 46  |
| IPO (Intercept Point Optimization).....                      | 46  |
| <b>K</b>                                                     |     |
| Keyboard Frequency Entry.....                                | 42  |
| Keyer Operating Mode.....                                    | 80  |
| Keyer Weight (Dot/Dash) Ratio.....                           | 79  |
| KEY Jack.....                                                | 18  |
| Key, Keyer, and Computer-Driven Keying Interconnections..... | 15  |
| <b>L</b>                                                     |     |
| Labeling Memories.....                                       | 100 |
| LED Indicators.....                                          | 24  |
| LOCK.....                                                    | 35  |
| LOCK Button.....                                             | 21  |
| LOCK Indicators.....                                         | 24  |
| <b>M</b>                                                     |     |
| Main Band RX/TX Indicators.....                              | 24  |
| Main Control Buttons.....                                    | 23  |
| Main Tuning Dial Knob.....                                   | 21  |
| Memory Channel Recall.....                                   | 98  |
| Memory Group Assignment.....                                 | 104 |
| Memory Groups.....                                           | 104 |
| Memory List.....                                             | 23  |
| Memory Mode RX/TX Indicators.....                            | 24  |
| Memory Operation.....                                        | 97  |
| Memory Scanning.....                                         | 108 |
| Memory Storage.....                                          | 98  |
| Memory Tune.....                                             | 102 |
| Menu List.....                                               | 23  |
| Menu Mode.....                                               | 120 |
| Menu Resetting.....                                          | 10  |
| MENU(SETUP) Button.....                                      | 19  |
| Message Memory.....                                          | 84  |
| Message Memory Programming.....                              | 86  |
| Meters.....                                                  | 23  |
| MH-31A8J Microphone Switches.....                            | 27  |
| MH-36E8J Microphone Switches.....                            | 29  |
| MIC Jack.....                                                | 18  |
| MMB-90.....                                                  | 143 |
| MODE Button.....                                             | 19  |
| MONITOR.....                                                 | 72  |
| More Frequency Navigation Techniques.....                    | 42  |
| Mounting Bracket MMB-90.....                                 | 143 |
| MULTI Knob.....                                              | 19  |
| MULTI Knob Operations.....                                   | 22  |

| <b>N</b>                                    |        |
|---------------------------------------------|--------|
| NAR.....                                    | 52     |
| NARROW (NAR).....                           | 52     |
| NB.....                                     | 47     |
| Noise Blanker.....                          | 47     |
| NOTCH Filter.....                           | 53, 54 |
| <b>O</b>                                    |        |
| ON/OFF Switch.....                          | 18     |
| Operating Mode Indicators.....              | 22     |
| Operation Frequency.....                    | 23     |
| Operation on 60-Meter (5 MHz) Band.....     | 33     |
| <b>P</b>                                    |        |
| Parametric Microphone Equalizer.....        | 63     |
| PHONES Jack.....                            | 18     |
| Plug/Connector Pinout Diagrams.....         | 17     |
| PMS (Programmable Memory Scanning).....     | 109    |
| <b>Q</b>                                    |        |
| QMB (Quick Memory Bank).....                | 97     |
| Quick Memory Bank.....                      | 97     |
| <b>R</b>                                    |        |
| RCL/STO Button.....                         | 20     |
| Rear Panel.....                             | 25     |
| Recalling the Home Channel.....             | 99     |
| Receiver Operation.....                     | 44     |
| REM/ALC Jack.....                           | 26     |
| Resetting Memories (Only).....              | 10     |
| Resetting the Microprocessor.....           | 10     |
| Reversing the Keyer Polarity.....           | 81     |
| RF Gain.....                                | 55     |
| RF GAIN Knob.....                           | 21     |
| RTTY/DATA Jack.....                         | 25     |
| RTTY (Radio Teletype) Operation.....        | 116    |
| RX Indicator (Green).....                   | 24     |
| <b>S</b>                                    |        |
| SCOPE.....                                  | 40     |
| Scope/Waterfall.....                        | 23     |
| Setting with the MULTI Knob.....            | 42     |
| Setup for Straight Key.....                 | 76     |
| S-Meter.....                                | 23     |
| Specifications.....                         | 144    |
| Speech Processor.....                       | 66     |
| SPLIT Button.....                           | 21     |
| Split-Frequency Operation.....              | 74     |
| Split Memory.....                           | 103    |
| Split Operation Using the TX Clarifier..... | 73     |
| SSB Mode Transmission.....                  | 59     |
| Standard Memory Operation.....              | 98     |
| Sub Band RX/TX Indicators.....              | 24     |
| Supplied Accessories.....                   | 5      |
| Sweep Mode.....                             | 41     |

## T

|                                                                     |    |
|---------------------------------------------------------------------|----|
| Table of Contents .....                                             | 3  |
| TEXT Memory.....                                                    | 87 |
| TFT Liquid Crystal Display.....                                     | 22 |
| To change the function assigned to the main control<br>button ..... | 23 |
| Toggling to the Digital Communication Mode.....                     | 39 |
| Tone Squelch Operation.....                                         | 94 |
| Tools for Comfortable and Effective Reception .....                 | 56 |
| Transmitter Convenience Features.....                               | 68 |
| TUNE Button.....                                                    | 20 |
| TUN/LIN Jack .....                                                  | 25 |
| TX Indicator (Red).....                                             | 24 |
| TXW Button.....                                                     | 20 |

## U

|                                        |    |
|----------------------------------------|----|
| USB Jack.....                          | 26 |
| Using the Automatic Antenna Tuner..... | 61 |
| Using the Built-in Electronic Key..... | 78 |

## V

|                                                 |     |
|-------------------------------------------------|-----|
| VFO-B Data.....                                 | 23  |
| VFO COLOR.....                                  | 36  |
| VFO Scanning.....                               | 107 |
| VL-1000 Linear Amplifier Interconnections ..... | 16  |
| V/M Button .....                                | 21  |
| Voice Memory.....                               | 68  |
| VOX.....                                        | 70  |

## W

|            |    |
|------------|----|
| WIDTH..... | 50 |
|------------|----|

## Z

|                    |    |
|--------------------|----|
| Zero-Beating ..... | 82 |
|--------------------|----|



# NOTE

This equipment has been tested and found to comply with the limits for a Class B digital device, pursuant to Part 15 of the FCC Rules. These limits are designed to provide reasonable protection against harmful interference in a residential installation. This equipment generates, uses and can radiate radio frequency energy and, if not installed and used in accordance with the instructions, may cause harmful interference to radio communications. However, there is no guarantee that interference will not occur in a particular installation.

If this equipment does cause harmful interference to radio or television reception, which can be determined by turning the equipment off and on, the user is encouraged to try to correct the interference by one or more of the following measures:

- Increase the separation between the equipment and receiver.
- Connect the equipment into an outlet on a circuit different from that to which the receiver is connected.
- Consult the dealer or an experienced radio/TV technician for help.

1. Changes or modifications to this device not expressly approved by YAESU MUSEN could void the user's authorization to operate this device.
2. This device complies with part 15 of the FCC Rules. Operation is subject to the following two conditions; (1) this device may not cause harmful interference, and (2) this device must accept any interference including interference that may cause undesired operation.
3. The scanning receiver in this equipment is incapable of tuning, or readily being altered, by the User to operate within the frequency bands allocated to the Domestic public Cellular Telecommunications Service in Part 22.

This device complies with Industry Canada license-exempt RSS standard(s). Operation is subject to the following two conditions: (1) this device may not cause interference, and (2) this device must accept any interference, including interference that may cause undesired operation of the device.

Le présent appareil est conforme aux CNR d'Industrie Canada applicables aux appareils radio exempts de licence. L'exploitation est autorisée aux deux conditions suivantes : (1) l'appareil ne doit pas produire de brouillage, et (2) l'utilisateur de l'appareil doit accepter tout brouillage radioélectrique subi, même si le brouillage est susceptible d'en compromettre le fonctionnement.

#### DECLARATION BY MANUFACTURER

The scanner receiver is not a digital scanner and is incapable of being converted or modified into a digital scanner receiver by any user.

**WARNING: MODIFICATION OF THIS DEVICE TO RECEIVE CELLULAR RADIOTELEPHONE SERVICE SIGNALS IS PROHIBITED UNDER FCC RULES AND FEDERAL LAW.**

CAN ICES-3 (B) / NMB-3 (B)

### Disposal of your Electronic and Electric Equipment

Products with the symbol (crossed-out wheeled bin) cannot be disposed as household waste. Electronic and Electric Equipment should be recycled at a facility capable of handling these items and their waste by products.

In EU countries, please contact your local equipment supplier representative or service center for information about the waste collection system in your country.



### Attention in case of use

This transceiver works on frequencies which are not generally permitted. As for the actual usage, the user has to possess an amateur radio licence. Usage is allowed only in the frequency bands which are allocated for amateur radios.

| List of national codes |    |    |    |    |    |
|------------------------|----|----|----|----|----|
| AT                     | BE | BG | CY | CZ | DE |
| DK                     | ES | EE | FI | FR | GB |
| GR                     | HR | HU | IE | IT | LT |
| LU                     | LV | MT | NL | PL | PT |
| RO                     | SK | SI | SE | CH | IS |
| LI                     | NO | -  | -  | -  | -  |





Yaesu UK Ltd  
Unit 12, Sun Valley Business Park  
Winnall Close  
Winchester SO23 0LB  
United Kingdom  
Tel: +44 (0)1962 866667  
Fax: +44 (0)1962 856801  
Email: sales@yaesu.co.uk

## Declaration of Conformity

Nr. YUK-DOC-0201-15

We, Yaesu UK Ltd. certify and declare under our sole responsibility that the following equipment complies with the essential requirements of the Directive 1999/5/EC and 2011/65/EU.

|                         |                                                                                         |
|-------------------------|-----------------------------------------------------------------------------------------|
| Type of Equipment       | HF Transceiver                                                                          |
| Brand Name              | YAESU                                                                                   |
| Model Number            | FT-991                                                                                  |
| Manufacturer            | YAESU MUSEN CO. LTD.                                                                    |
| Address of Manufacturer | Tennozu Parkside Building, 2-5-8 Higashi-Shinagawa, Shinagawa-ku, Tokyo, 140-0002 Japan |

### Applicable Standards:

This equipment is tested to and conforms to the essential requirements of directive, as included in following standards:

|                                        |                           |
|----------------------------------------|---------------------------|
| Health<br>1999/5/EC Art. 3 (1) (a)     | EN 62311:2008             |
|                                        |                           |
| Safety<br>1999/5/EC Art. 3 (1) (a)     | EN 60950-1:2006 + A2:2013 |
|                                        |                           |
| EMC<br>1999/5/EC Art. 3 (1) (b)        | EN 301 489-01 V1.9.2      |
|                                        | EN 301 489-15 V1.2.1      |
| Radio Spectrum<br>1999/5/EC Art. 3 (2) | EN 301 783-02 V1.2.1      |
|                                        |                           |
| ROHS2<br>2011/65/EU Art. 7 (b)         | EN 50581:2012             |
|                                        |                           |

The technical documentation as required by the Conformity Assessment procedures is kept at the following address:

Company  
Address  
Technical Construction file

Yaesu UK Ltd  
Unit 12, Sun Valley Business Park, Winnall Close  
Winchester, Hampshire UK SO23 0LB  
Issued by: Yaesu Musen Co. Ltd, Tokyo Japan  
File No: YETA00379  
Drawn up in: Winchester, Hampshire UK  
Date: 01-Feb 2015

Signed for and on behalf of Yaesu UK Ltd



Name and position: PCJ Bigwood  
Technical Sales Manager

# ***YAESU***

---

***The radio***

Copyright 2015  
YAESU MUSEN CO., LTD.  
All rights reserved

No portion of this manual  
may be reproduced without  
the permission of  
YAESU MUSEN CO., LTD.

Printed in Japan

1503-CO

