

FT-10R (VHF) FT-40R (UHF)

Hand-Held Transceivers with Digital Voice Option

Downloaded by
Amateur Radio Directory

www.hamdirectory.info

Important Notice!

FT-10/40 Receive Frequency Range Expansion

Please Note: The normal receive frequency coverage is 140~174 MHz (FT-10) or 420~470 MHz (FT-40). If you reset the transceiver, the frequency range returns to the factory-default limits (144~148 MHz, or 430~450 MHz).

Should this occur, perform the following steps to restore the expanded frequency range:

- Turn off the radio.
- Press down the top **DIAL** knob while simultaneously pressing the side-mounted **LAMP** button as you turn on the radio.

Repeating this procedure **erases all memories**, and returns amateur-only band limits.

Contents

Quick Start	1	DCS (Digital Code Squelch)	29
Description	3	ARTS (<i>Auto Range Transpond System</i>)	30
Using this Manual	5	CW ID (Morse Identifier)	33
Operation	7	DTMF Code Squelch & Paging	34
Basic Operation	8	DTMF Autodial	40
Frequency Selection Modes	9	Digital Voice	42
Tuning	10	Extending Battery Life	45
Direct Keypad Entry	10	Battery Care	48
Tuning Steps	11	Packet Radio	49
Transmitting	12	Cloning	50
Repeater Splits	12	Customizations	51
Automatic Repeater Shift	14	Knob	51
Memory Operation	15	Home/Rev Key	51
Simple Memory Storage	15	Monitor/T. Call Button	52
Recalling Memories	16	Appendix	53
Copying a Memory to a VFO	16	In Case of Problems	53
HOME Channel Memory	16	Resetting the CPU	54
Storing an Independent Tx Frequency	17	Accessories & Options	55
Memory Tuning	17	Keypads	56
Scanning	18	Batteries & Chargers	58
Programmable Subband (PMS) Limits	19	Battery Removal & Replacement	58
Advanced Operation	21	Other Accessories	59
Dual Watch	21	Controls & Connectors	60
Naming Memories	22	Display Indicators	63
Grouping Memories (Banks)	23	Dial Setting Functions	64
Memory Hiding & Unhiding	25	Tone System Tables	66
Memory-Only Mode	26	Specifications	67
Locking the Controls	26	Glossary	68
Tone Systems	27		
CTCSS Operation	27		

Quick Start

These steps are provided to get you on the air right away. If you experience a problem, refer to the indicated page or section for more details.

Note: The smaller inner knob is used in these steps to adjust squelch and repeater settings. These can also be set from the high-end keypads, but we use the knob method here since it applies to all versions.

Changing Settings with the Knob

Use the knob to change most function settings, like this:

- Press it down and hold it in for ½ second, until 2 beeps sound.
- Release the knob, then turn it to select a function.
- Press the knob again, momentarily, to display the current setting.
- Turn the knob to change the setting.
- Press the knob once more momentarily to accept the change.
- Press PTT to return to the operating display.

- Charge the battery pack, or install batteries in the FBA-15 case (page 58).

- Mount the battery pack on the back of the radio: hold it with the rounded top edge 1/3-inch (8 mm) lower than top edge of the radio, press the four tabs on the battery into the slots on the radio, and slide the battery up until it clicks.

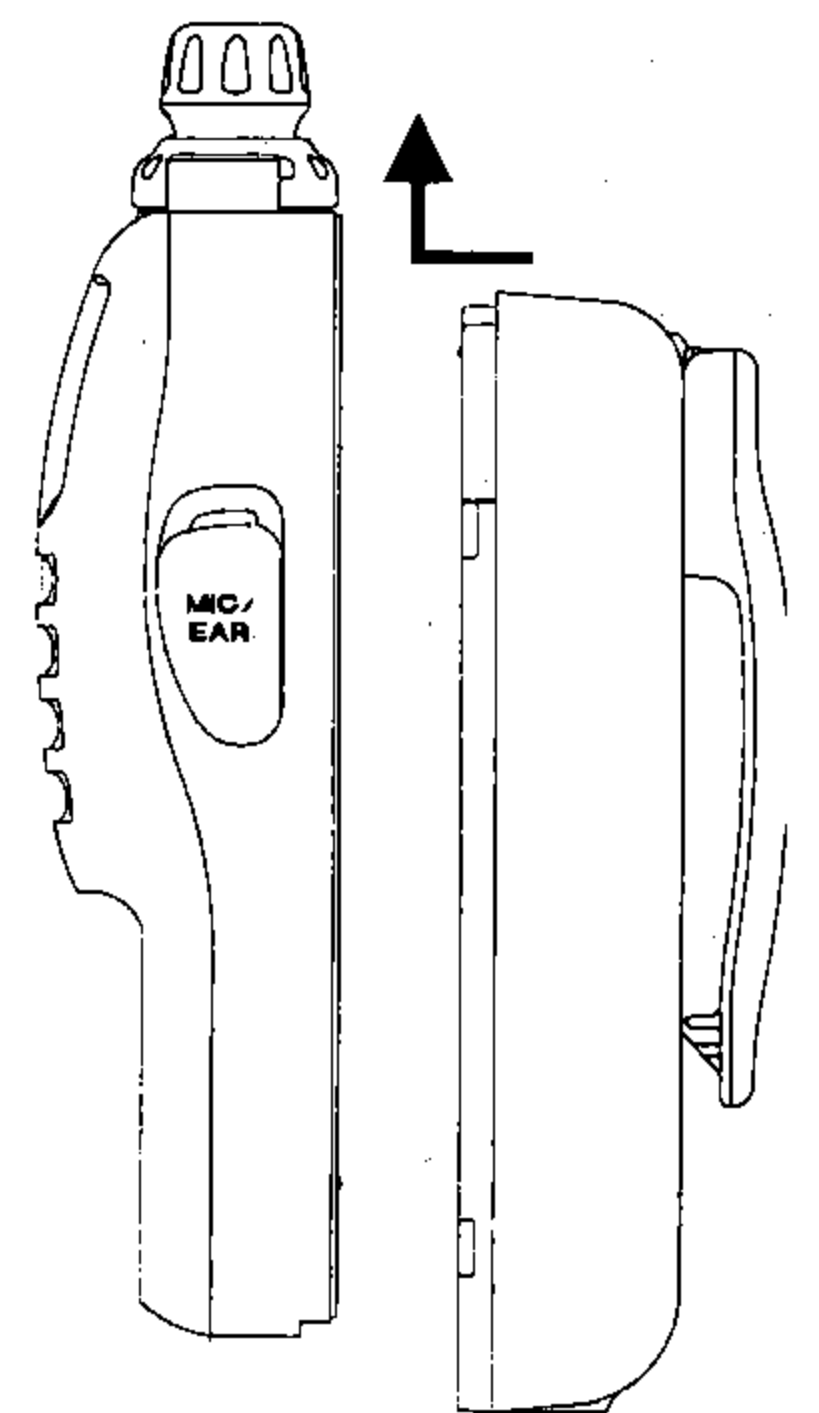

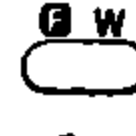
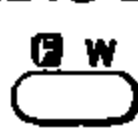
- Screw the antenna onto the top connector.
- Hold the orange PWR button ½ second to turn the radio on. If nothing happens, check the battery.
- Adjust the volume, as necessary, with the outer knob.
- Tune to the desired frequency using the inner knob: press  at the lower right momentarily, and turn the knob to select the MHz range, then wait 5 seconds or press  again and turn the knob to select the frequency.

- To adjust the squelch, hold the knob down for ½ second, then turn it, if necessary, so that **SQ L -01-** is displayed. Press the knob again momentarily, then turn it to set the squelch threshold (0 to 15) so the receiver is silenced. Press the PTT momentarily when done (page 8).

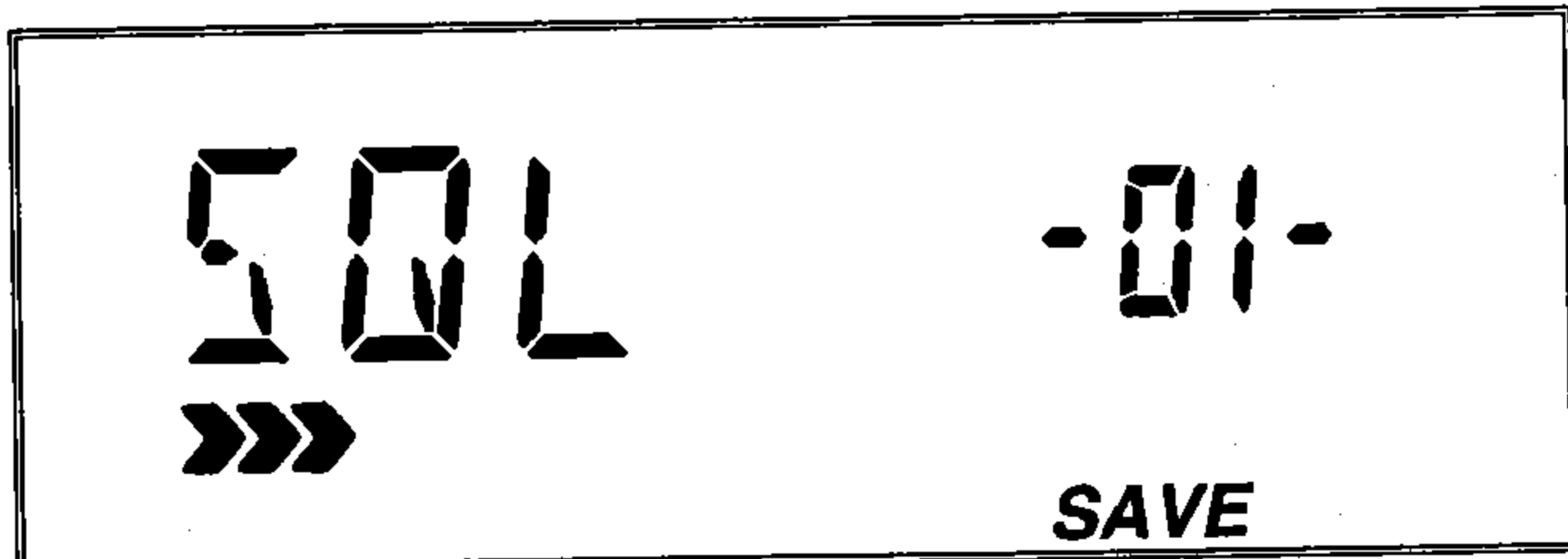

For repeater operation, set the shift direction and offset:

- Hold the knob in for ½ second, then turn it so that **RPT R -07-** is displayed.

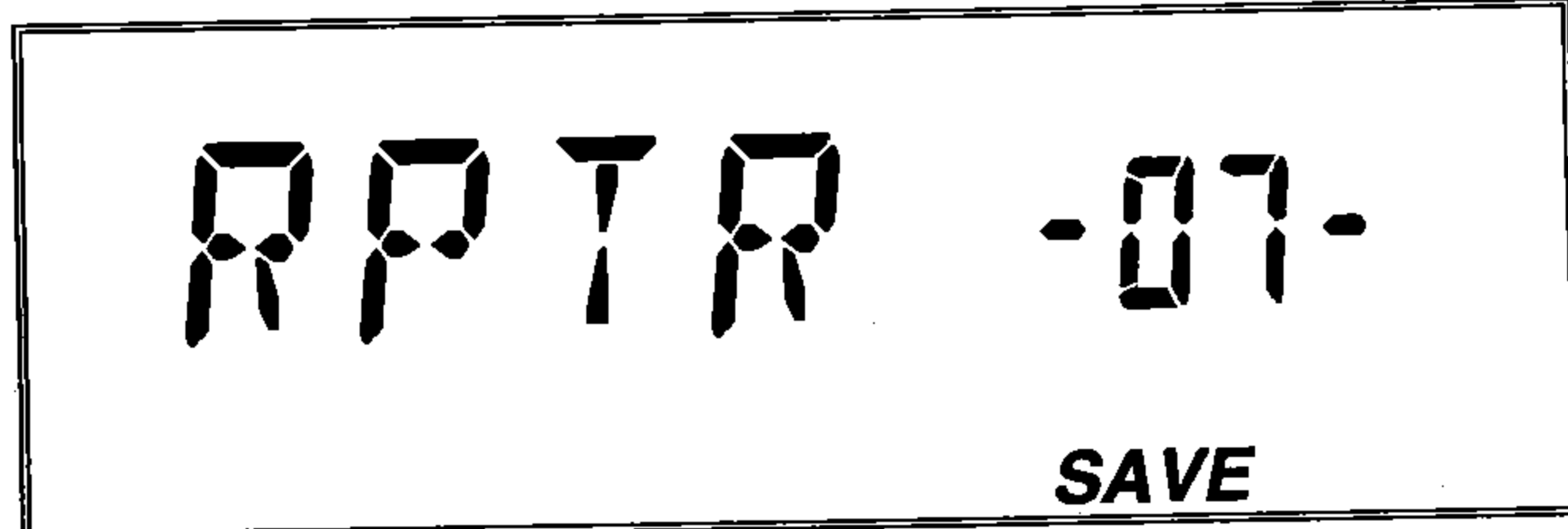

- Press the knob momentarily, and turn it to set the required repeater shift direction (+RPT, SIMP or RPT).
- Press the knob once more momentarily, and then the PTT.
- Repeat the same procedure to display **SHFT -00-**, and select the appropriate offset: 0.50 MHz for VHF, or as required for UHF (usually 5.00, 1.50, or 7.50 MHz). Press the PTT when done.

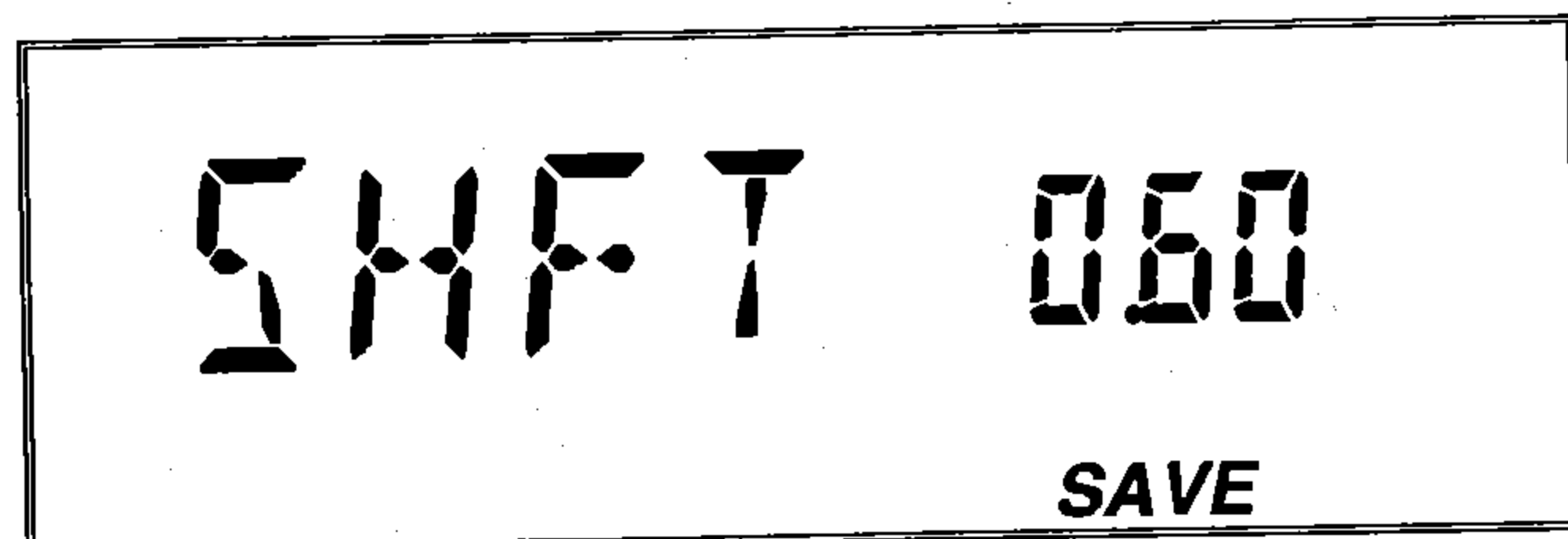

Description

The 2-m FT-10R and 70-cm FT-40R compact FM hand-held transceivers provide up to 5 watts of transmitter output on the VHF and UHF amateur bands. Four different keypads provide a choice of tone systems and digital voice functions, while all versions include Digital Code Squelch (DCS) encoding and decoding, CTCSS encoding, and a wide range of battery preserving features.

The compact "clamshell" design mounts the battery on the rear, for optimum simplicity and portability. A multi-function knob with concentric volume control allows setting most functions, minimizing the need for complex key sequences. The front half of the case is die-cast alloy, while a choice of 3 rechargeable Ni-Cd packs or a dry cell battery case made of thick high-impact polycarbonate plastic can be attached to the rear. Rubber gaskets protect against dust and rain or spray. The LCD (display) has selectable lighting modes, and shows all significant frequency digits and most programmable functions, plus relative signal strength and power output.

Two independent VFOs and up to 99 freely tunable memories (30 memories in A06 and A16

versions) can be grouped in up to nine banks, and are programmable from the knob and 16-button keypads. Memory features include independent tx/rx frequencies or programmable offsets, up to nine pairs of subband limits for band scanning, selectable scan skip for busy channels, scan resume on carrier drop or after 5-second pause, and an instant-recall HOME channel. Memories also store tuning steps, tone selections, and transmit power level. Standard channel steps from 5 to 50 kHz, and 1-MHz steps, are available for tuning. All versions let you assign 4-character names to memory channels.

All versions include a DCS encoder and decoder, and a 39-tone CTCSS (Continuous Tone-Coded Squelch System) encoder. The DCS tone system (and CTCSS decoder provided with the high-end keypads) can be set to sound an alert tone when a selective call opens the squelch. DCS includes the ARTS (Auto Range Transpond System), which polls each station to indicate when they are within or out of range, and with high-end keypads, can automatically ID with your callsign in Morse code every five minutes.

In addition to the 4-step power output selection, unique features to extend battery charge life include Yaesu's ABS (Automatic Battery Saver), which optimizes save duration according to operating history; TX Save, which automatically reduces transmit power during periods of high incoming signal strength; selectable-period APO (Automatic Power Off), to turn off the radio after a period of inactivity; and selectable always-on or 5-second illumination of the display.

In 16-key versions, the keypad serves as a DTMF generator during transmission, and in the high-end versions, up to 10 DTMF memories can store 15 digits each for quick playback of commonly used numbers. Also in the high-end versions, DTMF-based selective calling and private paging capabilities let you select any of 999 three-digit ID codes for your transceiver, and then have it stay quiet until your code is received

(from any standard DTMF-equipped transceiver). Upon receiving the DTMF ID code, you can have a paging beeper sound (1, 3, or 5 times). In the paging mode, your display shows the DTMF ID code of the calling party. Nine 3-digit code memories store your ID plus those of eight other stations or groups you wish to monitor, and an extra code memory always stores the last 3-digit DTMF code heard.

The high-end keypad provides 20 seconds of voice recording from the microphone or receiver, for playback through the speaker or the transmitter. Voice recording can be activated manually or by an incoming signal, and, when used together with DTMF paging, the radio can reply to calls automatically with a pre-stored voice message and CW identifier.

Please read this manual carefully to familiarize yourself with the transceiver's features.

Using this Manual

You can refer to this page and the table of contents as a guide to this manual and the transceiver capabilities. The manual consists of four parts:

Introduction

The Quick Start, and Description sections give you an overview of the transceiver design concepts and features. Reading this part should get you on the air, and give you a sense of what to expect from the radio and the manual.

Operation

This part takes you through every function of the transceiver that concerns operation. It consists of two sections: Basic Operation, covering the standard features in all versions like repeater shifts and memories; and Advanced Operation, which covers dual watch, tone systems and digital voice, some of which are only available in high-end keypads.

Special Features & Applications

This describes battery saving features, using the transceiver for packet radio, and data cloning between two transceivers.

Appendix

This part begins with troubleshooting information, and provides important figures, tables, and other reference material that you will need when learning transceiver functions. It also includes details on installing and using batteries, keypads and other accessories. At the end is a list of specifications, and a glossary of terms.

Note: Where necessary for clarity, features that are applicable only to certain keypads are designated by special markings, as follows:

 = FTT-10/A16S

 = FTT-10/A16D

 = FTT-10/A16

 = FTT-10/A06

If you encounter a term or abbreviation that is unfamiliar, refer to the Glossary at the back of the manual.

Operation

This chapter begins with the most essential operating features, and progresses to more exotic features.

Important Notes on Operation

We use the term 'knob' to refer to the inner DIAL knob on the top of the transceiver. Note that this knob also acts as a dual-action switch when pressed down: pressing it momentarily can do one thing, and holding it down for ½ second does something else. *In no case should you turn the knob while it is pressed.* When turning the knob, be careful not to disturb the outer volume control.

Normal key presses should be very quick — just tap the key. If you hold a key down, even briefly, it can fail to work, or do something unexpected. The instructions specify when a key is to be held down.

To indicate when several keys have to be pressed in sequence, we show an arrow (→) between them. Do not press more than one key at time unless the instructions say so.

One or more beeps indicate key contact has been made (if the key has a function). You can

disable the beeper as described on page 47, but we recommend keeping it enabled while getting to know the key functions, since the pitch and number of beeps can be useful feedback.

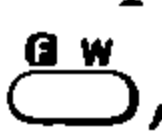
A several-second timer starts when you press , and automatically restarts when you turn the knob. Pressing other keys may *shut off* the timer as the resulting change in operation occurs, or *restart* the timer so you can select various functions.

Also, after changing a setting, you can usually return to the operating frequency display by pressing the PTT button at the top left corner of the radio. It does not transmit unless the operating frequency is displayed.

The 16-key pads generate DTMF tones according to the table on page 66 when you transmit.

While reading about operation, if you are unsure about the location or function of a button or display item, refer to the *Controls and Connectors* and *Display* sections in the Appendix.

If you have trouble getting the transceiver to work as described, see *In Case of Problems*, on page 53.

Basic Operation

First Steps

Before operating the transceiver the first time:

- Charge the battery pack completely (if using a rechargeable pack) as described on page 58. New battery packs are shipped from the factory completely discharged. If using an FBA-15 dry-cell battery case, install alkaline batteries as described on page 58.
- Screw the supplied antenna onto the antenna jack. *Never operate the transceiver without an antenna connected.*
- If you have a speaker/mic, we suggest you not connect it until you are familiar with basic operation.

To turn the transceiver on, hold the orange PWR button for ½ second. If the radio has not been used before, the display should look something like that illustrated to the right (the frequency display is different for different models).



Volume Setting

Turn the outer ring of the knob on the top panel control to adjust the volume. If there is no signal, you can normally override the squelch by

holding the center button (on the left side below the PTT switch), to adjust the volume on background noise.

Squelch Setting

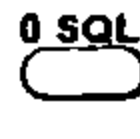
The squelch silences background noise when no signal is present. When a signal opens the squelch, the BUSY/TX indicator on the top of the radio glows green. You can adjust the squelch as described on the *Quick Start* page at the front of the manual.

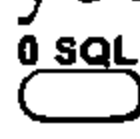
- ◆  The high-end keypads include a  key as a shortcut for squelch adjustment: you can adjust the squelch by pressing  → 

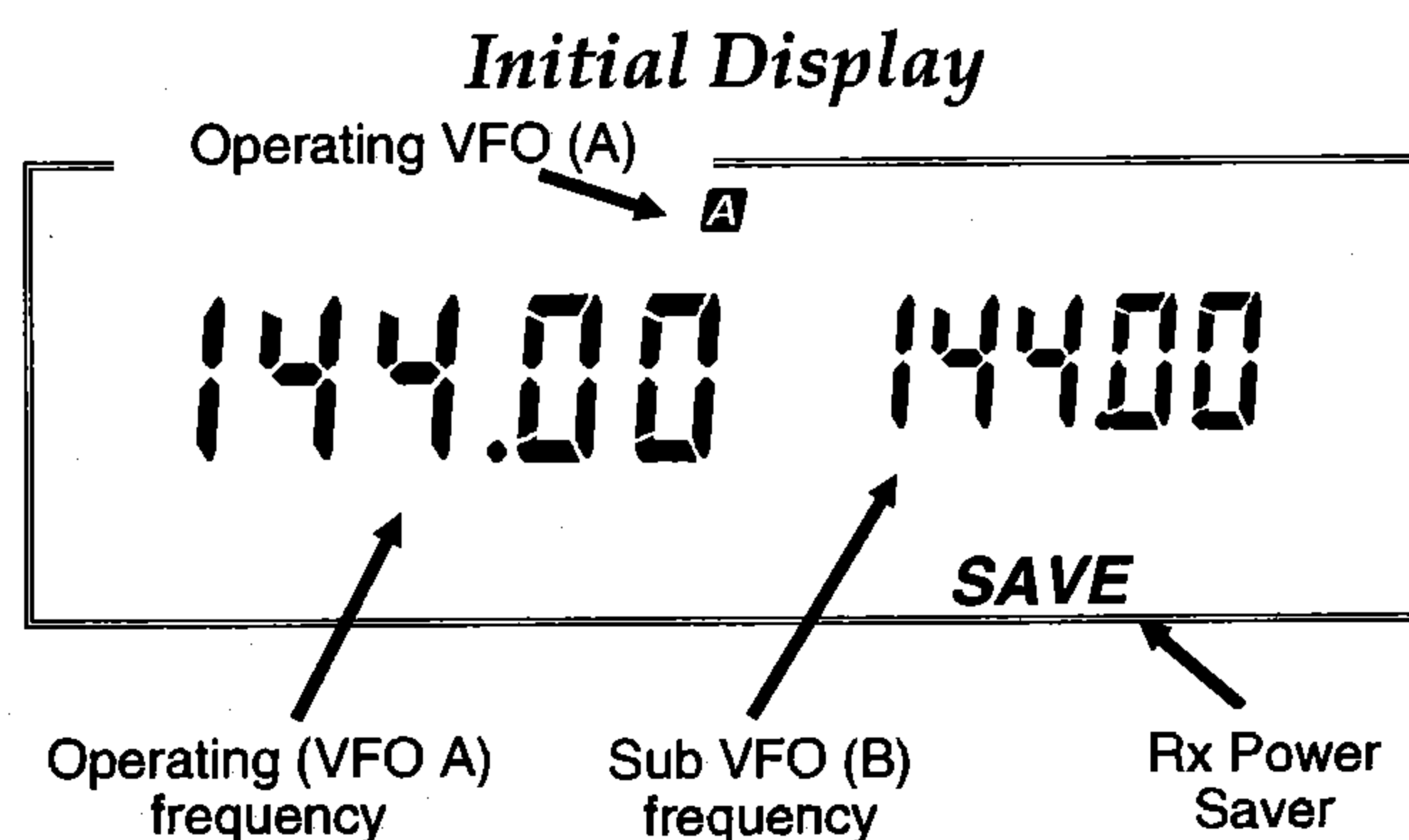

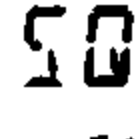



turning the knob (press the PTT or  when done). While setting the squelch,  appears followed by a number (0~15) indicating the squelch level.

To use either method, first set the volume to mid range, then adjust the squelch (when no signal is being received): just to the point where background noise is silenced and the LED is extinguished, (if set higher, sensitivity to weak signals is reduced).

Frequency Selection Modes

You have two main frequency selection modes. These affect the behavior of the knob and keys when tuning or keying in frequencies, scanning coverage, and the right half of the display.

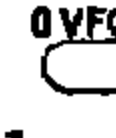
VFO Mode

Use this mode to find a clear or an active channel, when you don't have a specific frequency in mind. The knob tunes the band in the selected step size (or in 1-MHz steps if you press  or  first), and scanning tunes in the selected step size. The transceiver has two independent VFOs, A and B, which you select by pressing your VFO key (, , or , depending on your keypad) when receiving on either VFO. The display shows **A** or **B** near the





top center to indicate which VFO is selected for tuning, displayed in large numbers at the left. The frequency of the other VFO is displayed in small numbers at the right.

Memory Mode

Use this mode to operate on specific channels you have stored in the memories. For example, after storing the frequencies of your local repeaters, you can limit operation to those channels with the memory mode. The knob, keys, and scanning select only stored memories. The FT-10R and FT-40R provide either 30 or 99 memories, each of which stores repeater shift, transmit power level, tone settings, and tuning steps (for the Memory Tune mode), and can also hold a name tag and a separate transmit frequency. Either the operating frequency or the memory name, if assigned, is displayed in large letters at the left, and the memory number is displayed at the right. The memory number consists of two parts: a bank number (1 to 9) and a slot number (01 to 97) or symbol (PL or PU).

Each memory can be used in the *Memory Tune* mode, which works like VFO mode. Special memory mode functions like this are described later, but you should keep these terms in mind.

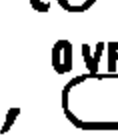
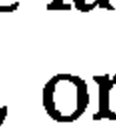
To tell whether the VFO or Memory mode is active, look for **A** or **B** at the top of the display. If either is present, that VFO is active. Otherwise, you are in Memory mode.

The Memory key ( or ) switches from the VFO mode to the last-used memory, and the VFO key (, , or ) switches from the memory mode to the last-used VFO. While in the memory mode, your previous VFO mode selections are preserved.

Tuning

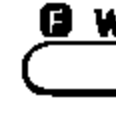



Turn the knob to tune in the selected step size, or press  first to tune in 1-MHz steps. You can select a new frequency from a VFO, or by tuning a memory. For now, use the VFO mode: press your VFO key. You can enter a frequency by turning the knob, or by numeric key entry (on the high-end keypads). See *Locking the Controls* on page 26 if the keys or knob don't work.



Direct Keypad Entry (📞📞)





With the high-end keypads, you can enter a frequency by keying in four or five digits: the last two MHz (10's and 1's) digits, and two or three kHz (100's and 10's) digits. How many digits you need to enter depends on your tuning steps, described next. With 5- and 15-kHz steps,

you have to enter five digits. When you press the first number key, the display clears and only the new digit appears. When you press the last key, the display reverts to normal, showing up to 7 digits of the new operating frequency (if it's valid), or the original frequency (if it was not valid, 3 beeps sound).

Ex: To operate on 146.94 MHz (with the FT-10R):

 Press  →  →  → .

You should see 146.94 displayed. If your channel steps are 5-kHz (the default), you have to enter a trailing zero (). If this frequency is out of band, you heard 3 beeps, and the display returned to its previous frequency (try an in-band frequency). If your set is using 12.5- or 25-kHz steps, *nothing happened* when you pressed the second , since this frequency is not a multiple of these steps. Just press any other number (except ) to get the nearest valid 12.5-kHz channel.

You can enter 12.5-kHz splinter channels this way, but subsequent tuning is still in the selected step size, if it is larger. *Note* - pressing  during frequency entry truncates remaining decimal places to zero, and can be used as a shortcut for keypad entry. For example, to enter 146.00 MHz, simply press  →  → .





Tuning Steps

Default channel (tuning) steps are 5 or 12.5 kHz in the FT-10R, and 25 kHz in the FT-40R. To avoid confusion and interference, you should set your tuning steps to match the standard channel spacing in your region: typically 25 kHz on UHF (and on VHF in Europe), and 15 or 20 kHz on VHF in America. Note that coarser steps tune and scan faster, and that 5- and 15-kHz steps require an extra digit when entered from the keypad (in the FT-10R). Each VFO and memory has its own tuning step setting.

To change step size:

- Press the knob ½ second.
- Turn it to **STEP -09-**.

- Press it again momentarily to display the current step size.
- Turn it to choose the new step size (in kHz).
- Press it again momentarily to accept the new size.
- Press PTT.

♥  The high-end keypads also include a  key, which you can use as a shortcut in place of the above procedure: just press  → , turn the knob for the desired steps, and press the  again to return to the operating display.

Transmitting

Press  so that **LOW** appears below the center of the display. To transmit, wait until the channel is clear (BUSY/TX LED off), then press and hold the PTT while speaking into the microphone (at the right side of the front panel). The BUSY/TX indicator glows red when transmitting, and the bargraph shows relative transmitter power output. Release the PTT to receive.

If you need more power to maintain communications, you can select another power setting as described in the box. However, remember that your batteries last longer and you cause minimum interference by using the lowest level possible.

Note that each VFO and memory retains its own power setting.

Repeater Splits

You have three ways to set up split transmit/receive operation for repeaters: manual, automatic, and independent tx frequency memory. Manual and automatic methods shift the transmit frequency above or below the receive frequency by a programmable offset, stored independently in each memory and VFO. Use the independent transmit frequency method to store odd-step offsets, such as frequencies of repeaters with splits that are not a multiple of 50 kHz. This is described later under *Memory Operation*.

Power Output Selection

You can select the power output level to be activated when low power is enabled:

- Hold the knob down ½ second, then turn it to select **TXPO -02-**.
- Press the knob momentarily, then turn it to select **L1**, **L2**, **L3**, or **H1**.
- Press the knob momentarily, and press the PTT to exit.

Power Level	FNB-41, -42 or 12-V DC	FNB-40 or FNB-49	FBA-15
H1	5.0/5.0*	2.5/2.5	2.0/2.0
L3	2.8/2.5	2.5/2.5	2.0/2.0
L2	1.0/1.0	1.0/1.0	1.0/1.0
L1	0.1/0.1	0.1/0.1	0.1/0.1

*note - values listed are in watts for FT-10R/FT-40R

Setting Standard Repeater Offset

If your transceiver has not been used before, the repeater offset must first be set:

- Hold the knob in for 1/2 second, then turn it so that **SHIFT -00-** is displayed.
- Press the knob momentarily, and turn it to select the appropriate offset: **0.50** MHz for VHF, or as required for UHF (usually **5.00**, **1.50**, or **7.50** MHz).
- Press the knob again momentarily, and the PTT when done.

You probably want to keep the repeater offset programmed to the most commonly used split in your area. If you're not sure what that is, leave it set to 600 kHz for VHF, and ask around for the UHF offset.

Manual Repeater Shift

When repeater shift is active, either **+** or **-** is displayed at the top left. If neither appears when tuned to a repeater output frequency, you can activate the shift manually:

- Hold the knob in for 1/2 second, then turn it so that **RPT -07-** is displayed.
- Press the knob momentarily, and turn it to set repeater shift direction (**+RPT**, **SIMP** or

Tone Burst

If your local repeaters need a 1750-Hz burst tone for access (such as in Europe), you can set the monitor/T. Call button below the PTT so that it sends the tone:

- Hold the knob down 1/2 second.
- Turn it to select **KEY -20-**.
- Press the knob momentarily.
- Turn it to select **M/T** (Monitor/Tone).
- Press the knob momentarily.
- Turn it to select **TCRL** (Tone Call).
- Press the PTT to exit.

You can use the same procedure to change the function of the button back to 'monitor', by selecting **MON** instead of **TCRL**.

RPT). Press the knob again momentarily to accept your change, and then PTT.

☛ The **6 RPT** key on high-end keypads is a shortcut for the above: Press **6 W** → **6 RPT**, turn the knob to select the shift, and press **6 RPT** again.

Note that the offset used will be the "standard repeater offset" selected above.

With repeater split activated, you can temporarily reverse transmit and receive frequencies by pressing **6 W** → **HM RV** (or **6 W** → **HM RV** on the 6-button keypad). Use this to display the transmit frequency without transmitting, and to check a signal's strength on a repeater uplink frequency (to see if you can work them direct). The repeater shift sign blinks while reverse split is selected. Press **6 W** → **HM RV** (or **6 W** → **HM RV**) again to return to the normal shift direction.

Note that each VFO and memory has its own repeater shift settings.

Automatic Repeater Shift

ARS (Automatic Repeater Shift) activates repeater shift whenever you tune to a frequency in a standard repeater subband. With this feature enabled, **+** or **-** at the upper left of the display indicates that repeater shift is active (without

your having to activate repeater shift manually), and closing the PTT changes to the (offset) transmit frequency. The subband range over which ARS operates is determined by the version of your set, as shown below.

ARS is enabled at the factory. To disable it:

- Press the knob down 1/2 second, then turn it to display **ARS -05-**. Now press it again momentarily, and turn it to select **OFF**.
- Press the knob once more to accept your setting, and the PTT to return the display to the operating frequency.

As already mentioned, you can use manual shift at any time to select a new shift state, whether ARS is activated or not. However, if you change frequency with ARS activated, manual repeater shift selections are ignored.

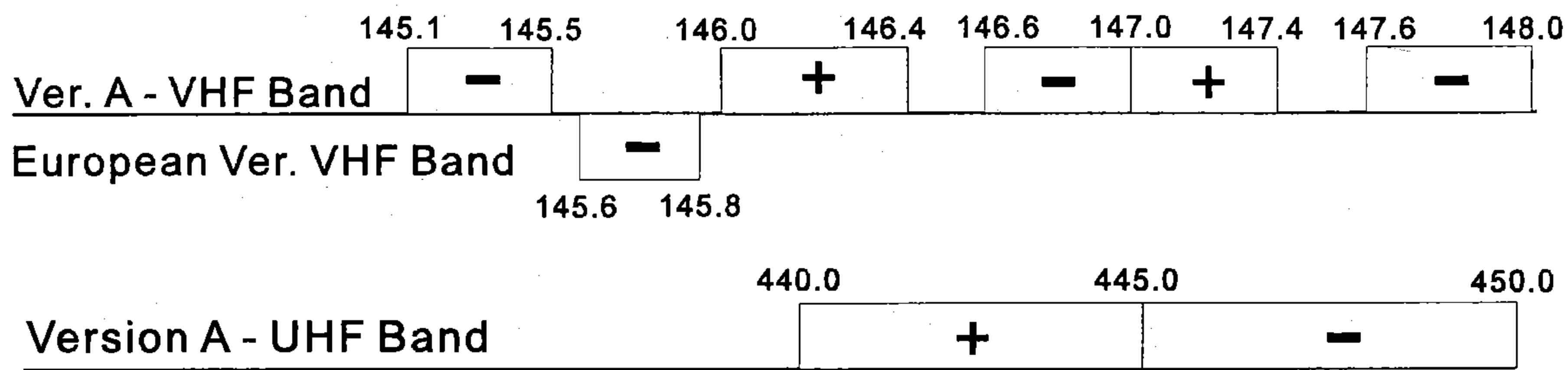

Simple Memory Storage

The FTT-10/A16D and -A16S high-end keypads provide 99 programmable memory channels, and the FTT-10/A16 and -A06 keypads provide 30 channels. These can be partitioned into groups (or banks) as described later, but for now, let's look at how memories are displayed, and the procedures to store and recall data.

When you store a memory, the current tuning step, displayed receive frequency, repeater shift, transmitter power level, DCS, and CTCSS tone settings are copied into a memory slot. The slots are labeled numerically from 1 up to 28 or 97 (for the 30 and 99-channel keypads, respectively), and P_L or P_U , for the lower and upper limits of programmable scanning (PMS, described later).

To store a frequency in memory:

- Select the desired frequency, repeater split (if desired), and power level in the VFO mode as already described.
- Hold G W for ½ second (until a second beep sounds). A bank and slot number (eg., 1-05) appears blinking at the right.

- Within five seconds of releasing G W , turn the knob to select the desired slot for storage. If you select one that was already used, it will be overwritten with new data in the next step.
- Press *MRMW (or MRMW) to store the displayed data into the selected memory slot. The memory number stops blinking for a second, and then disappears as operation continues in the VFO mode.

If you timed out, operation switched to the memory mode. Simply press \#VFO DW (or 0VFO DW or VFO DW) to return to the VFO, and start again.

Example: Store the 146.34/146.94 repeater data in memory slot 5 (with the FT-10R).

- First perform the steps in the example on page 10 to set up the desired frequency and offset on the VFO.
- Hold G W for ½-second to display the memory slot (blinking) at the right, then do the next step within 5 seconds.
- Turn the knob, if necessary, so that 1-05 (the memory number to store) blinks at the right.

- Press *MRMW (or MRMW) again, momentarily. That's it. The VFO data has been stored in bank 1/slot 5, and you are left operating on the VFO.

To confirm this worked, turn the knob to change the VFO frequency (to anything new), then press *MRMW (or MRMW) to change from VFO to memory mode. The bank and slot number (1-05) should appear at the right, and 146.34 (the receive frequency) at the left. You can press $\text{G W} \rightarrow \text{HM RV}$ (or $\text{G W} \rightarrow \text{HM RV}$) to confirm the transmit frequency of 146.34 MHz.

Notice that pressing *MRMW (or MRMW) from the VFO mode always recalls the *last stored or used* memory.

Recalling Memories

In confirming the results of the last example, we used *MRMW to change from the VFO mode to the memory after it was stored. The bank and slot number appear at the right when operating on a memory, unless you assign a name to a memory, or activate Dual Watch (both described later).

After storing several memories, you can select one for operation by turning the knob, or by direct keypad access if you have a high-end keypad. Simply enter the number of the memory

slot you want, followed by *MRMW . If the memory you want is in a different bank, enter the bank number, followed by the slot number (for slots 01 ~ 09, enter a zero between the bank and slot numbers). If you hear three beeps and return to the previous display, the memory you requested is empty. To exit the memories and return to the last-used VFO, press \#VFO DW (or 0VFO DW or VFO DW).

Copying a Memory to a VFO

After storing memories, you may want to copy one to a VFO. You can copy the current memory into the last-used VFO by holding G W for ½ second, and pressing your VFO key.

HOME Channel Memory

Although invisible to the procedures just described, the HOME channel memory can be instantly recalled by the HM RV (or 9HM RV or HM RV) key: **HOME** appears above the frequency at the left. There is a default simplex frequency stored in the HOME channel, but you can reprogram it with any frequency, repeater, power, and tone settings, or even a separate transmit frequency.

To copy the displayed VFO settings into the HOME channel memory, hold G W for ½ second until the right half of the display blinks, then press HM RV (or 9HM RV or HM RV).

Storing an Independent Tx Frequency

All memories can store an independent transmit frequency, for operation on repeaters with non-standard shift. To do this:

- Store the receive frequency using the method already described under *Simple Memory Storage* (any repeater offset will be ignored).
- Tune to the desired transmit frequency.
- Press and hold G W for ½ second to display a slot at the right again.
- Press and *hold* the PTT switch while pressing *MRMW momentarily (this does not key the transmitter). Or course, if you're storing this in the HOME channel, you press 9HMRV when holding the PTT).

When a separate transmit frequency memory is displayed, M and + appear together at the top corner. You can press $\text{G W} \rightarrow \text{9HMRV}$ (or HM RV or HM RV) to display the transmit frequency, and the shift symbols blink. You can also change the repeater shift direction to cancel repeater shift temporarily until you change channels.

After storing a memory with a separate transmit frequency, if you rewrite the receive frequency in that memory, the separate transmit frequency is deleted.

Memory Tuning

While receiving on a memory, you can re-tune it and change other settings (like repeater shift or power output) by first pressing *MRMW (or MRMW). *MT* appears at the left edge of the display, and you can tune in the same ways as described before (including 1-MHz steps). You can store the new frequency and settings in the current or another memory slot. Just hold G W for ½-second, then select the new slot (if desired), and press *MRMW (or MRMW). Operation remains on the new memory as the old memory reverts to its original state.

Once you have re-tuned a memory, if you don't want to save your changes, just press *MRMW (or MRMW) to return to the original memory data.

Scanning

Before scanning, make sure the squelch is set to silence background noise. You can scan either your stored memories (in the current bank), or each frequency on the band at the selected tuning step. To scan only memories, first recall a memory, then hold *MRMW (or MRMW) for ½ second. To scan every step of the band, begin at a VFO (press \#VFODW or OVFODW or VFODW momentarily), then press and hold the same key for ½ second.

The scanner pauses when a signal opens the squelch, and the decimal point in the frequency display at the left blinks. When band scanning, a double beep sounds each time the scanner reaches the band edge, unless you have disabled the beeper ($\text{G W} \rightarrow \text{9BEEP}$ on the high-end keypads). Scanning resumes according to how you set the scan resume mode, described in the box.

You can stop the scanner manually by pressing the PTT to stay on the current frequency, or the *MRMW or \#VFODW keys. *Note* - You can change scan *direction* (downward/upward) by rotating the knob (CCW/CW) while memory or VFO scanning is active.

Memory Skip Scanning

When you have some very busy channels stored in memories, you may wish to skip them

Scan Resume Modes

You can choose how you want scanning to resume after pausing on a signal: either after 5 seconds, or after the signal stops transmitting (carrier drops):

- Press the knob ½ second, then turn it to *RESM -10-*.
- Press it again momentarily to display the current setting (5 or *RR*).
- Turn it to choose the desired setting, and press again momentarily to accept the new setting.
- Press PTT to return to the operating display. Your scan resume setting applies globally: that is, the one setting applies to all scanning.

when scanning, but still have them available for manual selection. You can mark a memory to be skipped by pressing $\text{G W} \rightarrow \text{*MRMW}$ (or $\text{G W} \rightarrow \text{MRMW}$) while receiving on the memory. *SKIP* appears at the lower left.

To cancel scan-skip and allow the memory to be scanned, just repeat the step used to disable it: select the memory manually, and press $\text{G W} \rightarrow \text{*MRMW}$ (or $\text{G W} \rightarrow \text{MRMW}$).

Programmable Subband (PMS) Limits

Besides band and memory scanning, you can set the transceiver to tune or scan within a frequency range of your choice (with the selected channel steps). The limits are stored in two special memory slots labeled P_L and P_U :

- Store the lower edge of the desired scanning range in memory slot P_L , and the upper edge in slot P_U .
- With either memory recalled, press MR MW (or MR MW) to enable memory tuning (*MT* must be blinking at the upper left). Your tuning range is now limited to the programmed subband.
- To scan the subband, hold VFO DW (or VFO DW or VFO DW) for ½ second to start scanning.

If ARS or manual repeater shift is activated, the offset is applied automatically when you transmit (even if the resulting transmit frequency is outside the subband limits).

Note: The frequency resolution of subband limits is 100 kHz, although the channel resolution of the P_L and P_U memories is the selected channel step size. Therefore, the actual limits are the frequencies stored in these memories *rounded down* to the nearest 100 kHz. Since the memories themselves are not limited to a specific fre-

quency, you can still use them for other purposes anywhere within the 100-kHz range above the intended limit.

Example: To limit reception to 145.0 ~ 145.9 MHz (in the FT-10R).

- Tune a VFO to *any channel between 145.000 and 145.095 MHz*.
- Hold B W for ½-second, tune the knob so that the desired PMS memory channel (let's use $1-P_L$ in this example) appears at the right, and then press MR MW (or MR MW). The displayed frequency is now stored to provide a lower subband limit of 145.000 MHz.
- Re-tune the VFO to *any channel between 145.900 and 145.995 MHz*.
- Repeat the second step, selecting $1-P_U$ at the right. This stores the effective upper PMS limit of 145.900 MHz.
- Press MR MW (or MR MW) to change to memory operation, and then MR MW (or MR MW) again to activate the 145.000 ~ 145.900 limits. Hold VFO DW (or VFO DW or VFO DW) for ½ second to start scanning.

Note that with PMS, as with regular band scanning, a double beep sounds each time the scanner reaches the subband edge, unless you have disabled the beeper (page 47).

To release subband limits press MR MW (or MR MW) to return to memory operation, VFO DW (or VFO DW or VFO DW) to return to a VFO, HM RV (or HM RV or HM RV) to switch to the HOME channel.

Once you have stored the memory limits, you can reactivate PMS scanning and tuning just by recalling any PMS memory and pressing MR MW (or MR MW) again. However, you cannot activate the subband if either PMS memory is marked for skip-scanning, or hidden.

If you segment the memories into banks as described later, each bank has its own pair of P_L and P_U slots.

Disabling the Subchannel Display

You can disable the subchannel display, so that the alternate VFO is not displayed at the right when operating on a VFO. By default, the subchannel display is enabled.

- Press the knob down for ½ second, then turn it to display $\text{[U]} -05-$.
- Press the knob momentarily, then turn it to display aFF (or a0 if you want the subchannel display enabled).
- Press the knob down for ½ second, then release it and press the PTT.

When the subchannel display is disabled, the right side of the display shows the bank/slot number (instead of the frequency) of the last-used memory during Dual Watch operation on a VFO.

Other items that appear at the right side, such as memory numbers, frequencies of named memories, tone selections and DTMF Codes are unaffected by whether the subchannel display is enabled or disabled.

Dual Watch

Dual Watch automatically checks for activity on a 'subchannel' memory every five seconds while you are receiving on another frequency. The subchannel frequency is displayed at the right (if the subchannel display is enabled: see the box on the facing page). When the receiver detects a signal on the subchannel, operation automatically shifts to that frequency while the signal is present. If you want to talk on the subchannel, you have to recall it, or press ***MRMW** to quit Dual Watch operation.

To set up Dual Watch:

- Set the squelch, and select the memory channel to watch (if you will be operating on memories, this must be memory slot 1-01).
- Select either the VFO or memory you want for your main operating channel: press your VFO key (***VFO DW**, **OVFO DW** or **VFO DW**) to operate on a VFO, or select the memory you want to operate on.
- Press **GW** → ***VFO DW** (or ***GW** → **OVFO DW** or **GW** → **VFO DW**).

DW appears at the bottom left, with your main channel at the left side and the subchannel at the right. About every five seconds the channels

briefly switch positions as the receiver checks the subchannel.

As long as no signal opens the squelch on the subchannel, you can tune, transmit and receive on the VFO, or select other memories in the same bank. If you hear a station you wish to talk with on the subchannel, press ***MRMW** to cancel Dual Watch operation (or dial memory 1-01 if you are in bank 1), and then the PTT. Otherwise, when a signal appears on the subchannel, two beeps sound, the receiver jumps to the subchannel and the decimal on the display blinks. Checking resumes according to how you set the scan-resume mode: either after five seconds, or after the carrier drops. To cancel Dual Watch manually, press your VFO, MR or HM key.

Note that you can use any memory as a subchannel for Dual Watch when operating on a VFO, but only memory 1-01 when operating on memories. You can use Memory Tune during Dual Watch, if you activate Memory Tune first, although it may be easier to copy the memory into a VFO instead. You cannot, however, switch VFOs or memory banks, or between memory and VFO operation (pressing the necessary buttons cancels Dual Watch).

Naming Memories

You can assign name tags up to 4 characters long to the memories, and have those memories displayed by both name and frequency. Use this to identify channels by the names of friends, locations, ham clubs and repeater callsigns, or by whatever mnemonics you like. You have a choice of 48 different characters for naming, including a space and 11 special symbols:

0	1	2	3	4	5	6	7
8	9	A	B	C	D	E	F
G	H	I	J	K	L	M	N
O	P	Q	R	S	T	U	V
W	X	Y	Z	[]	{	}
~	^	^	^	^	^	^	^

Before naming a memory, you need to store its frequency and other settings as described previously. Then:

- Recall the memory you wish to name.
- Press and hold the knob for ½ second, then turn it to display **NAME -03-**.
- Press the knob momentarily, then turn it so that **00** appears at the right. If this memory has been named previously, that name now appears at the left. Otherwise, " " " " appears.

- Press the knob again momentarily. An underline cursor appears at the leftmost digit location. Now turn the knob to select a character.
- With the desired character displayed, press the knob momentarily. The cursor moves one digit to the right. Turn the knob to select the next character. If you accidentally enter the wrong character, just keep going.
- Repeat the above step until you have entered all the characters you want (up to four). If you want to change any characters, press the knob momentarily to step the cursor through the characters to get to the one to change. Entered characters disappear when the cursor is on them, but reappear when the cursor moves.
- Hold the knob down ½ second to store the name in memory, then press the PTT to return to the operating display: the name appears at the left, and the frequency at the right.

When naming memories, note that blank spaces can be entered in place of characters, and names do not have to begin at the first (left-most) character location.

If you want to suspend the display of memory names, press and hold the knob for ½ second, turn it to display **NAME -03-**, then press it

again momentarily, and turn it so that **FF** appears at the right. Press the PTT to quit.

You can always turn the names back on. They are preserved with the memories.

Grouping Memories (Banks)

Initially, the transceiver is configured with one bank of 30 memory slots. You can program up to nine memory banks to store different groups of memories (as you may want to do if you sometimes move from one area to another), or to store up to nine pairs of subband limits, or even to store the same frequencies with different power levels or tone settings. The memory

grouping features are very flexible, but it takes some time to get familiar with the them.

Important notes on memory bank configuration:

- No matter how you configure memory banks, data that you have stored in memories is never deleted, although reconfiguration might make stored memories temporarily inaccessible.
- Note that the number of memory slots allocated to a bank is not related to the number of memories that you have stored: only the number that you can store in that bank.
- If you allocate only one slot to a bank, it displays as slot 01.

Grouping Memories into Banks (Example for 30-ch Versions)

Memories	1	2	3	4	5	6	7	8	9	10	11	12	13	14	15	16	17	18	19	20	21	22	23	24	25	26	27	28	29	30
Slots for 1-Bank Grouping	1-01 1-02 1-03										1-27 1-28 1-PL 1-PU																			
Slots for 2-Bank Grouping	Bank 1: 1-01 1-02 1-03 1-13 1-PL 1-PU															Bank 2: 2-01 2-02 2-03 2-13 2-PL 2-PU														
Slots for 4-Bank Grouping	Bank 1: 1-01 1-PL 1-PU							Bank 2: 2-01 2-PL 2-PU							Bank 3: 3-01 3-PL 3-PU							Bank 4: 4-01 4-PL 4-PU								



- If you allocate only two slots to a bank, they display as **PL** and **PU** (because of their capability for use as programmable subband limits, described previously).
- If you allocate more than two slots to a bank, the last two display as **PL** and **PU**, and all others are numbered sequentially from 01. For example, if you allocate ten slots to bank 1, they display as 1-01, 1-02 ... 1-08 and then 1-PL and 1-PU.
- If you change the size of a bank (that is, the number of slots allocated to it), the contents of any higher-numbered banks are shifted accordingly. For example, if you have already allocated ten slots to bank 1 and stored data in each, then you reduce bank 1 to five slots, the upper five memories will appear in bank 2, assuming it was allocated at least five slots. If bank 2 had fewer than 5 slots, the remaining slots will be moved to bank 3, and so forth.
- Once you have allocated all available slots, if you have used fewer than nine banks, you still cannot select a new bank: you first have to decrease the slots allocated to the other banks. So, for example, if you are using the 30-memory FTT-10/A16 or -06 keypad, all available slots are allocated to bank 1 by default. You

must decrease the number of slots allocated to bank 1 before you can set up another bank.

To store data in different banks, you first have to allocate some slots to them. Here's an example to allocate five slots to banks 1 and 2:

- Press the knob in for ½ second.
- Turn the knob to display **GRP -19-**, then press it again momentarily to display bank 1's slot allocation.
- Press the knob again to clear bank 1 to zero slots, then turn the knob to allocate five slots (**GRP 1-05**).
- Press the knob again to display bank 2 (it always shows 0 slots at this point), and turn the knob to allocate five slots here (**GRP 2-05**).
- Press the knob again momentarily to display bank 3 with 0 slots, and then press and hold the knob for ½ second to accept your new allocations for all banks. Finally, press the PTT to return to the operating display.



Now, whenever you hold **W** for ½ second to select a slot during memory storage, and turn the knob, you will find slots labeled 1-01, 1-02, 1-03, 1-PL and 1-PU.

To access another bank, just press  momentarily while a  is displayed, and turn the knob. Then, to select a slot within the bank, press  again momentarily and turn the knob. In this example, you can select from the bank 2 slots: 2-01, 2-02, 2-03, 2-PL and 2-PU.

Memory Hiding & Unhiding

You can hide some memories so they cannot be recalled by the knob or keypad. If you store a memory and hide it, the data you stored is still there and can be unhidden, until you overwrite it or reset the CPU. You can also unhide memories that have never been stored, in which case you will find they are set to the bottom edge of the band. You can use this feature to easily check which memories you have not yet stored. You cannot hide bank 1 slot 1 (this memory must always be accessible).

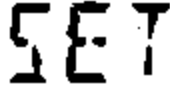
To hide a memory:



- Press and hold the knob for ½-second, then release it, and turn it to display  -04-.
- Press the knob momentarily, then turn it to display the memory slot to hide at the right.  appears at the left if the memory slot is not hidden. If  appears instead, it indi-

cates that the selected slot is already hidden (or has not yet been used).

- Press the knob momentarily, then turn the knob one click, so that  is displayed.
- Hold the knob down for ½ second, then release it, and press the PTT to quit.

If you were previously operating on the memory you just hid, operation shifts to bank 1 slot 1.











To unhide a memory:

- Press and hold the knob for ½-second, then release it, and turn it to display  -04-.
- Press the knob momentarily, then turn it to display the memory slot you want to unhide, at the right.  appears at the left if the memory slot is hidden. If  appears, it indicates that the selected slot is already unhidden.

When you have hidden some memories, be careful not to overwrite them accidentally: you will not be able to recover the previous contents.

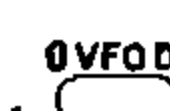
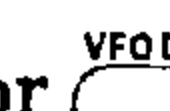

Memory-Only Mode







Use this feature when you need very simple operation on only stored memories, which are displayed as the memory name (if stored) at the left, and the bank & slot number at the right. No frequency is displayed, and only hyphens appear if you haven't assigned a name to a memory. Repeater shift and tone setting indicators are displayed, although they cannot be changed. In fact, *the alternate functions of most keys are disabled, as well as the functions accessed by holding the knob down.* Only these functions are available, as indicated:

- Hi/Low TX Power: 
- Lock:  → 
- Channel Selection: knob or keypad
- Memory Scanning: 
- Reverse Repeater Split: ,  or 
- Dual Watch: ,  or 
- Digital Voice ()





After programming memories, you can toggle memory-only operation on and off by turning the radio off, then holding the PTT and LAMP buttons (top and bottom buttons on the left side) while holding the PWR button for ½ second to turn it on again.

Locking the Controls

The keypad buttons, knob and PTT can each be 'locked' (disabled), to prevent inadvertent transmissions or adjustments. Any of , , or  are displayed at the top right when any of these are locked.

By default, only the keypad locks. To activate or deactivate the lock, press  →  (or  →  or  → , depending on your keypad).



To change the locking scheme to lock the knob or PTT:

- Hold the knob for ½ second, then turn it to display  -15-.
- Press the knob momentarily, and turn it to select the items to lock:
 -  = keypad,
 -  = DIAL (knob),
 -  = PTT button.

These appear in the available combinations as you turn the knob.

- Press the knob again momentarily to accept your setting, and press the PTT to return to the operating display.

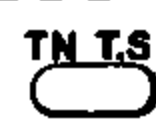
Tone Systems

Subaudible tone systems (CTCSS and DCS) are activated and deactivated by  (or ). These systems may not be usable between stations working through some repeater systems (especially linked repeaters), because the subaudible tones are filtered out by the repeater. However, when both stations access the same repeater, both CTCSS and DCS may be usable by choosing the higher-numbered tones. The ARTS (Auto Range Transpond System) variant of DCS provides automatic polling of a station, with automatic CW IDing in the high-end keypads.

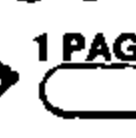



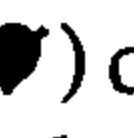
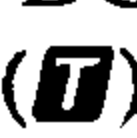

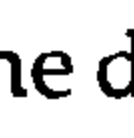

DTMF Code Squelch and Paging systems are activated and deactivated by pressing  → . As these use audible tones, they should work fine through most repeater systems. Answer-Back DTMF Paging allows automatic CW IDing and automatic voice IDing with the high-end keypad.





CTCSS Operation





All versions can access repeaters or other stations that require a CTCSS (continuous, subaudible) tone. The high-end keypads (, ) can also use this to monitor silently for calls on busy channels (all versions can also use DCS for the same purpose). The CTCSS encode () function



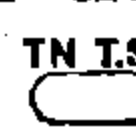

superimposes a subaudible tone (at a frequency too low to be heard) on the transmitted carrier. The decode (, tone squelch) function monitors receiver audio through a narrow filter at the same subaudible frequency, keeping the squelch closed until you receive a matching tone.

To check or set the current CTCSS tone frequency:

- Press  (or ) so that  (CTCSS encoder) appears at the top center of the display. This key cycles through different tone selections, so you may need to press it several times.
- Press  →  (or  → ) to display the current tone frequency, in Hz, at the right.
- To change the selected tone, turn the knob to display the tone frequency you require (the display steps through 39 standard tones, listed in the Appendix).
- Press  (or ) again alone to return to the operating display.

  With CTCSS encoding activated as above, if you have a high-end keypad, you can press  again to activate the tone decoder as well ( displayed at the top center). Now the tone squelch system is activated for both transmit and receive (only incoming signals 'en-

coded' with the matching tone open the squelch; other signals cause your BUSY/TX LED to light and your S-meter to pulse, but you will not hear them). To turn off CTCSS functions, press  or  two or three times, so that neither ,  or  is displayed.

You can store CTCSS tones (and encode/decode states) in each memory in the same manner (and at the same time) as storing channel frequencies. To change the tone or state stored in a memory, just recall it, reset the tone frequency or function, and store the memory again (press and hold  or  for ½-second, release it, and press  or ). If you activate CTCSS on a subband limit memory, it will be active when that memory is used to start PMS operation.

CTCSS Ringer Function

With the high-end keypads, you can enable the Ringer function for tone squelch as described in the box.

CTCSS Tone Scanning

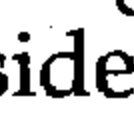
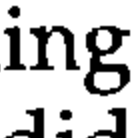

The CTCSS decoder can scan through the EIA tones to determine the CTCSS tone frequency of a signal being received. See the Tone Scanning Box on the next page.

Ringer Function

When using either CTCSS tone squelch (in the high-end keypads) or DCS, the Ringer function displays  below the right side of the display while you are waiting for a call. When someone calls you, your radio rings to get your attention, and  starts blinking so you will know someone called if you didn't hear the ring.

To enable the Ringer function:

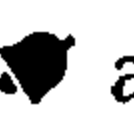
- Hold the knob down for ½ second, then turn it to display **BELL -15-**.
- Press the knob momentarily, then turn it to select **on**.
- Press the knob again, then press the PTT.

Note that  appears only if tone squelch or DCS is activated (by ) , the same icon appears for Paging operation, but this is not affected by the **BELL -15-** setting.

When you press the PTT to answer a call,  disappears as the Ringer is turned off.

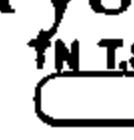
When you finish your conversation, you can press  momentarily to turn the Ringer back on for the next call.

DCS (Digital Code Squelch)

The DCS system, provided in all versions, is similar to CTCSS tone squelch in that it also uses subaudible tones to allow silent monitoring of busy channels, so your squelch opens only for calls directed to you. The Ringer function and Tone Scanning are also available with DCS. However, it offers some very powerful features that can make semi-private operation even more convenient. First the basics:

To use DCS, both stations must be on the same frequency, and have selected the same DCS tone code. DCS tone codes consist of three digits each, and are listed in the Appendix.

Note: Choose the higher-numbered tone codes if you plan to use DCS through a repeater: the lower-numbered DCS tones may not pass through repeater audio filtering. Also note that DCS may not work at all through linked repeater systems.

To check or set the DCS tone code:

- Activate DCS: Press TN.TS (or TN.TS) two or three times momentarily, so that **DCS** appears above the right side of the display.
- Press $\text{BW} \rightarrow \text{TN.TS}$ (or $\text{BW} \rightarrow \text{TN.TS}$) to see the current DCS tone code.

Now only those stations who have also selected the same DCS tone code will open your squelch, and vice-versa. Other signals cause your BUSY/TX LED to light and your S-meter to pulse, but you will not hear them.

DCS Ringer Function

The Ringer Function can be enabled for DCS operation as described in the box on page 28.

DCS Tone Scanning

The DCS decoder can scan through all DCS tone codes to determine the DCS tone code of a signal being received. See the box on the previous page.

Tone Scanning

When using either CTCSS tone squelch (in the high-end keypads) or DCS, you can have the radio scan through the tones or tone codes to determine which one is present on a received signal.

Before tone scanning, either tone squelch or DCS must be activated (press TN.TS as necessary until either **TSQ** or **DCS** is displayed).

- Press $\text{BW} \rightarrow \text{TN.TS}$ to display the CTCSS tone frequency or DCS tone code at the right.
- Press and hold TN.TS for ½ second to start scanning for a matching tone or code.

Scanning slows when a signal is present, and pauses as the tone frequency/code blinks when a match is found. To accept the displayed tone frequency or code for operation and return to the operating display, press TN.TS twice, momentarily.

- To change the selected code, turn the knob until to display the code you require.
- Press TN.TS (or TN.TS) again alone to return to the operating display.

ARTS (Auto Range Transpond System)

ARTS uses the DCS system to allow two radios to automatically poll one another every 25 seconds, and to indicate when they are within range, and when they are not. It works like this:

- Of course both radios must be tuned to the same frequency, and also set to the same DCS tone code (the ringer can be activated or not, as desired).
- Whenever you push the PTT, or about 25 seconds after ARTS is activated, your radio transmits a (subaudible) DCS signal for about 1 second.
- If the other ARTS-equipped radio is in range, it beeps twice and his display shows **RANG** ('range') at the left (or yours does if his radio polls you first).
- Whether you begin a conversation or not, the radios continue polling each other every 25 seconds (and if your CW ID is turned on, your radio IDs in Morse code every 16 pollings). As long as your stations remain within range, the radios beep once each time a poll is received (or each time he presses his PTT).
- If you move out of range for more than about a minute, your radio senses that no signal has

been received, beeps three times, and **RANG** begins flashing.

- If you then move back into range, as soon as he transmits (or his radio polls) your radio beeps twice, and **RANG** stops flashing.

Note: During ARTS operation, your frequency is displayed at the right, but you cannot change it or other settings (except to select high/low transmit power). Also note that radios in ARTS operation do not open the squelch until a signal is received for about one second, so if you talk, you have to remember to pause before speaking after pressing the PTT. Of course, ARTS does not work if the PTT lock is activated.

To use ARTS:

- Activate DCS (press $\overset{TN.TS}{\text{O}}$ or $\overset{TN.TS}{\text{O}}$, repeatedly if necessary, until **DCS** appears above the right side of the display).
- Display the DCS tone code (press $\overset{G.W.}{\text{O}} \rightarrow \overset{TN.TS}{\text{O}}$ (or $\overset{G.W.}{\text{O}} \rightarrow \overset{TN.TS}{\text{O}}$), and set if it necessary to match the other station).
- Press $\overset{G.W.}{\text{O}}$ (or $\overset{G.W.}{\text{O}}$). **R** (receive-only), **T** (transmit-only), **TR** (transceive) or just your operating frequency appears at the left, indicating the current ARTS mode (described at the right). Press $\overset{G.W.}{\text{O}}$ again if you want to

change it (the operating descriptions assume both radios are set to **TR**).

- Press $\overset{TN.TS}{\text{O}}$ or $\overset{TN.TS}{\text{O}}$ alone when done. The display returns to normal, except that now **DCS** is blinking (indicating ARTS is enabled, as opposed to regular DCS operation).
- Finally, to activate ARTS, press $\overset{G.W.}{\text{O}}$ (or $\overset{G.W.}{\text{O}}$), and then press down on the knob and hold it for ½ second. Two beeps sound, and your ARTS mode selection appears at the left, with your operating frequency at the right, and with **DCS** blinking.

To cancel ARTS operation, repeat the above step, or just turn the radio off and back on.

ARTS Modes

The ARTS description above assumes both radios are set to the **TR** ARTS mode. You can also use the **R** mode if you want your radio to listen only and not poll the other station (in which case their radio should be set to the **T** mode). In this case, while your radio will beep and display **RANG** to indicate the state of connection, theirs only shows **T** at the left side. This can be convenient for the transmit-only station since he won't hear the polling beeps (of course he can still hear you when you talk).

Caution

The transmit and transceive modes of ARTS entail transmitting without operator intervention (automatic transmission). Make sure this type of operation is legal in your country before using it, as the radio can transmit without any operator present.

Your ARTS mode selection is retained by the VFOs and can be stored in memories. If you want to use normal DCS operation, you have to cancel the ARTS mode by selecting the operating frequency when the DCS tone number is displayed (by pressing $\overset{G.W.}{\text{O}} \rightarrow \overset{TN.TS}{\text{O}}$ or $\overset{G.W.}{\text{O}} \rightarrow \overset{TN.TS}{\text{O}}$).

ARTS Polling Speed & Beep

You can increase the ARTS polling rate, if you want to have the radio check propagation state more frequently, such as when one or both stations are mobile. You can also disable the single beep that sounds every time a poll signal is received, although you might wish to leave it enabled until familiar with the system (the two beeps at signal acquisition and the three at loss of signal are not affected).

- Hold the knob for ½ second, then turn it to display **ARTS -25-**.
- Press the knob momentarily, and turn it to select **SPEED** (polling speed) or **BEEPER** (ARTS polling beeper).
- Press the knob again momentarily, and turn it to change the setting: 15 or 25 second polling intervals, or beeper on/off.

Hold the knob for ½ second to accept your settings, then press the PTT to return to the operating display.

CW ID (Morse Identifier-all versions)

The CW IDer function causes the radio to send your CW ID about once every 5 minutes during ARTS polling, and in DTMF Paging Answer-Back. To store your callsign and activate the IDer:

- Hold the knob down for ½ second, then turn it to display [**W I**] - 25 - .
- Press the knob momentarily, then turn it if necessary, to display 00 at the right.
- Press the knob again momentarily. The digit location number 1 appears at the left, and there may be a number or letter (the first character of a callsign) in the center.

- Turn the knob to change the character in the center, to be the first letter of your callsign.
- Press the knob momentarily. The digit location number 2 now appears at the left. Again turn the knob to display the second character of your callsign in the center.
- Repeat the above step to finish entering your callsign, then hold the knob down for ½ second to accept your entry, and finally press the PTT to quit.

CW ID Entry

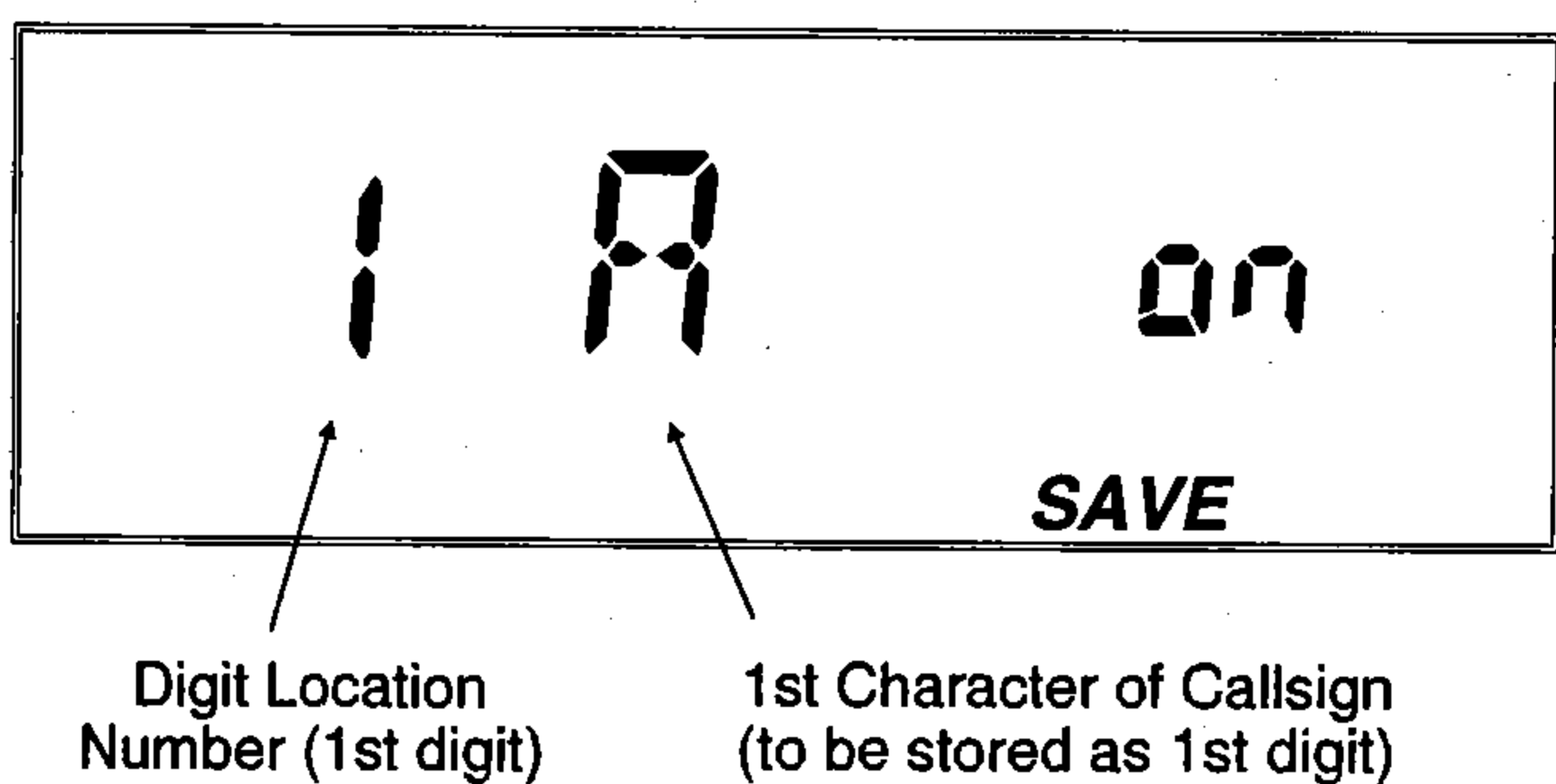

DTMF Code Squelch & Paging (📞📞)

The high-end keypads include a DTMF (Dual-Tone, Multi-Frequency) tone decoder and microprocessor firmware to provide paging and selective calling. This allows you to place a call to a specific station or group, and to receive calls directed only to you or to groups of your choice.

The paging and code squelch systems use 3-digit numeric codes (000 ~ 999), transmitted as audible DTMF tones. There are ten Code Memories numbered 1 ~ 8, C, and P, which store 3-digit DTMF codes (independent of, and unrelated to the channel memories and the VFOs).

Basically, your receiver remains silent until it receives three DTMF tones that match those stored in one of its Code Memories. The squelch then opens so the caller is heard, and in the paging mode, **PAGE** blinks and a paging ringer sounds. When you close the PTT to transmit, the same three pre-stored DTMF tones are transmitted automatically. In the paging mode, three more DTMF digits are sent, representing the 3-digit ID code of the transmitting station.

DTMF paging and code squelch are enabled by pressing **QW** → **1PAGE**. Either **PAGE**, **T.PAGE**, or **CODE** appears at the bottom of the display when DTMF paging, trigger paging, or code squelch is

enabled, respectively. The following descriptions begin with an overview of the basic DTMF selective calling system, followed by details of actual operation and special features.

DTMF Code Squelch (📞📞)

Code squelch is very simple: both you and the other station automatically send the same 3-digit DTMF sequence at the start of every transmission. Your squelch opens only for signals that are prefixed by your 3-digit code, and stays open until a few seconds after the end of their transmission.

For code squelch, you must first store and then manually select one Code Memory holding a 3-digit DTMF code to open your, and the other station's, squelch (as described on the following pages). Also, for code squelch, Code Memories 1 ~ 8 and P always function the same: the distinctions described below for paging do not apply.

DTMF Paging (📞📞)

With DTMF paging you can receive signals that are prefixed with any of up to nine different 3-digit codes, according to the method you choose when programming the Code Memories. When you receive a page, the current Code Memory selection changes automatically, and

the display responds in one of two ways, depending on how you stored the paging code:

Individual Codes

These are unique personal ID codes to identify each station. You store one of these for your Personal ID, in Code Memory P. You can store other Individual Codes of stations you call often in Code Memories 1 ~ 8. When someone transmits your Individual Code, your transceiver automatically selects Code Memory C, and the calling station's Individual Code is read into in that Code Memory so you can see who called.

Group Codes

This type of code identifies a group of stations. You would generally share a Group Code with other club members or friends. When you receive a call with a Group Code, the Code Memory number (1 ~ 8) in which you stored that 3-digit Group Code is selected and displayed automatically, so you can see which group has been called (if you have stored more than one).

Note that for a Group Code, the display does not show the ID and code of the caller, but those of the called group instead. Code Memories 1 ~

8 can be used to store either Individual Codes (for calling purposes only) or Group Codes (for both calling and receiving), as you desire.

With either type of page, the **PAGE** indicator starts blinking when a page is received,  disappears, and the page ringer sounds, if enabled. The blinking indicator lets you know if someone called while your attention was elsewhere.

Remember, with code squelch operation (but not with paging), you can only receive a call on the currently selected Code Memory, and the display does not change when a call is received. So for code squelch, as mentioned before, the Individual/Group distinction does not apply (although you must still store the 3-digit Code Memories).

In either code squelch or paging modes, any DTMF-equipped station can call you. They can use a DTMF keypad to send the three digits if you are in code squelch mode, or seven digits (actually, three digits—'star'—three digits, e.g.: 1 2 3 * 4 5 6) if you are in paging mode.

DTMF Code Monitoring ()

Whenever a 3-digit DTMF code is received while either code squelch or DTMF paging is active, the code is automatically written into Code Memory C. By selecting this Code Mem-

35

ory as described below, you can determine what DTMF code was last heard, whether or not it opened your squelch.

Storing Code Memories ()

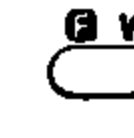
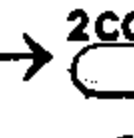
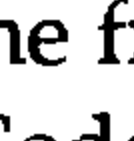

The first thing to do before using paging or code squelch is to store your Personal Code in Code Memory P:

- Press  →  to activate the DTMF Code Memory display. The frequency display is replaced by 3-digit Code (, if not used before) at the left, and a Code Memory number or letter at the right.
- Turn the knob to select Code Memory P, which is for your personal DTMF paging ID Code.
- Use the numeric keys to enter the three digits you want to use for your ID.
- Press the PTT to finish.

Your Personal ID Code is now stored in Code Memory P. You can use the same procedure to store the Codes of other individuals or groups in Code Memories 1 ~ 8, but with an additional feature: generally you store another station's ID Code so you can page them, but do not want to have *your* transceiver ringing every time someone else calls *them*. On the other hand, you store group codes with the intention of receiving any

pages to the group (so you want your squelch to open and the transceiver to ring, if paging). You can prevent your transceiver from ringing using Page Code Inhibit, described next.

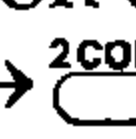
Page Code Inhibit ()

During the Code Memory storage procedure above, when storing Code Memories 1 ~ 8, you have an opportunity to decide whether your transceiver should respond to incoming paging calls on a particular DTMF Code. After pressing  →  to activate Code setting, you can press  to toggle DTMF squelch paging capability on and off. A small underbar appears beneath the Code Memory number when the decoder is enabled to receive paging calls with this Code Memory.

If you are setting a Group Code, you want to have the underbar on, and if setting another station's Individual Code, you want it off. As already mentioned, this distinction does not apply to code-squelch-only (non-paging) operation — the underbar has no effect.

Note that the underbar is displayed permanently on Code Memory P, since this is your own ID (that you will always want to receive when paging is activated). Also, the underbar never

appears on Code Memory C, since this is reserved for the display of incoming codes.

Once you have stored your own ID Code in Code Memory P, you can activate paging or code squelch functions from the frequency display by pressing $\text{CW} \rightarrow \text{PAGE}$. Repeatedly pressing this key cycles through DTMF paging (**PAGE**), trigger paging (**T.PAGE**), code squelch (**CODE**), and no paging (none of these indicators). When any of the systems is active, the Code Memory label and contents are displayed at the right.

DTMF Code Squelch Operation (📞🔇)

As described earlier, with DTMF code squelch activated (**CODE** displayed), your squelch opens only when you receive the 3-digit DTMF code that matches the code memory you have selected. Likewise, each time you press the PTT, the same 3-digit code is automatically transmitted to open the other station's squelch (you can hear it transmitted, but the receiver does not). You have to wait until the tones have been sent before you start talking.

Replying to a DTMF Page, and Resetting

Any DTMF-equipped station can call you by sending your 3-digit code, followed by their 3-digit ID Code. Your transceiver will ring (unless you have turned off the paging ringer, as de-

scribed in the box on the next page), The code of the calling station (now in code memory C) is displayed at the right.

When you press your PTT after receiving a page, your radio sends the other station's ID code, then a DTMF " * " followed by your own 3-digit personal ID code (that is, your Code Memory P) and your CW ID (if enabled) all automatically, and then the radio resets to receive another call.

Unless you are using Trigger Paging (covered next), you may want to switch from paging to code squelch mode once contact is established. You have to press $\text{CW} \rightarrow \text{PAGE} \rightarrow \text{PAGE}$ so that **CODE** appears. Either you or the other station will also have to select Code Memory C, so that you will both be using the same DTMF code (either, but not both, must re-select their Code Memory). With Code Squelch activated in this manner, you will hear three DTMF code digits transmitted when you press your PTT.

When you finish your conversation, if you want to reactivate DTMF Code Paging, press $\text{CW} \rightarrow \text{PAGE} \rightarrow \text{PAGE}$ until **PAGE** is displayed.

DTMF Paging Settings (📞🔇)

Four special settings are available to optimize DTMF Paging: DTMF code sending speed, delay, paging bell, and Answer-Back. These are set as follows:

- Hold the knob down for ½ second, then release and turn it to display **PAGE -27-**.
- Press the knob momentarily to display **SPD** (DTMF code sending speed).
- Press the knob momentarily again to display the current speed setting, and turn it to change the setting: 50 or 100 ms per tone. The 50 ms tones are preferable, but the slower tones may work better under weak signal conditions.
- Press the knob momentarily to accept your setting, then turn it to display **DLAY** (or press PTT to quit).
- Press the knob momentarily again to display the current delay setting: 450 or 750 ms. This is the delay between the moment your press PTT and transmission of the first DTMF code digit. Keep it at 450 ms unless you are working through a repeater that cuts off the first digit.
- Press the knob momentarily to accept your setting, then turn it to display **BELL** (or press PTT to quit).
- Press the knob momentarily again to display the current bell setting: 1, 3 or 5 rings, or OFF. This is the number of times the paging ringer sounds when the squelch opens. Set it to OFF only if you do not want the ringer to sound (these settings do not affect the CTCSS or DCS ringer).
- Press the knob momentarily to accept your setting, then turn it to display **RSBK** (or press PTT to quit).
- Press the knob momentarily again to display the current Answer-Back setting: on or OFF. This feature is described on the next page.
- Press the knob momentarily, then press the PTT to return to the operating display.

If you press the PTT while a setting is displayed, any change to that setting is ignored and you return to the operating display immediately.

Trigger Paging (📞🔊)

This feature overcomes the inconvenience of having to manually switch to and from Code Squelch mode when responding to a page.

To activate Trigger Paging, press **QW** and then **PAGE**, repeatedly if necessary, until **T.PAGE** is displayed at the bottom. When a page is received several things can happen:

- The right side of the display shows Code Memory C (the other station's ID).
- **T.PAGE** starts blinking, and if the paging ringer is enabled, it sounds, and 🔊 disappears.
- If the other station has his CW ID enabled, you hear that, and if his Answer-Back is activated, you hear his recorded voice message.

When he stops transmitting, press your PTT within 3 seconds, wait for your DTMF code to be sent, and begin talking. His DTMF code is sent once more, and then as long as you both respond within 3 seconds of the end of the other's transmission, no further DTMF codes are sent. However, as soon as either station fails to respond within that time, the pager resets to receive a new call (**T.PAGE** stops blinking and 🔊 reappears, if the paging bell is enabled).

If the other station is not using trigger paging, his DTMF pager sounds at each transmission.

Answer-Back Paging (📞🔊)

When you press the PTT to respond to a page, the radio transmits the caller's ID code, followed by a DTMF * and your personal ID code, informing the calling station that their page was received. You may prefer to have the radio 'transpond' to page calls automatically. Use this with Trigger Paging for hands-free automatic paging operation (a received page is automatically answered and the squelch opened for immediate voice communication). You can also have your radio transpond with your CW ID (page 33), or by pre-recorded voice ID if you have the high-end keypad (page 42).

To enable Paging Answer-Back:

- Press and hold the knob for 1/2 second, and then turn it to display **PAGE -27-**.
- Press the knob momentarily, then turn it to display **ANS BK**.
- Press the knob again momentarily, and then turn it to display **ON**.
- Press the knob again momentarily to accept the new setting, and press the PTT to return to the operating display.

To disable Paging Answer-Back, repeat the above steps, selecting **OFF** instead of **ON**.

DTMF Autodial (📞🔊)

The high-end keypads provide ten memories, numbered 0 through 9, for storing DTMF tone sequences of up to 15 digits each. These can be used for remote DTMF control or for telephone numbers for autopatching.

The Autodial mode must be activated to use the DTMF autodial memory features. This mode is toggled on and off by pressing **QW** → **DTMF**. A 📞 is displayed near the lower right when this mode is active.

To store a DTMF memory:

- Press **QW** → **DTMF**, if necessary, to display 📞.

DTMF Memory Display

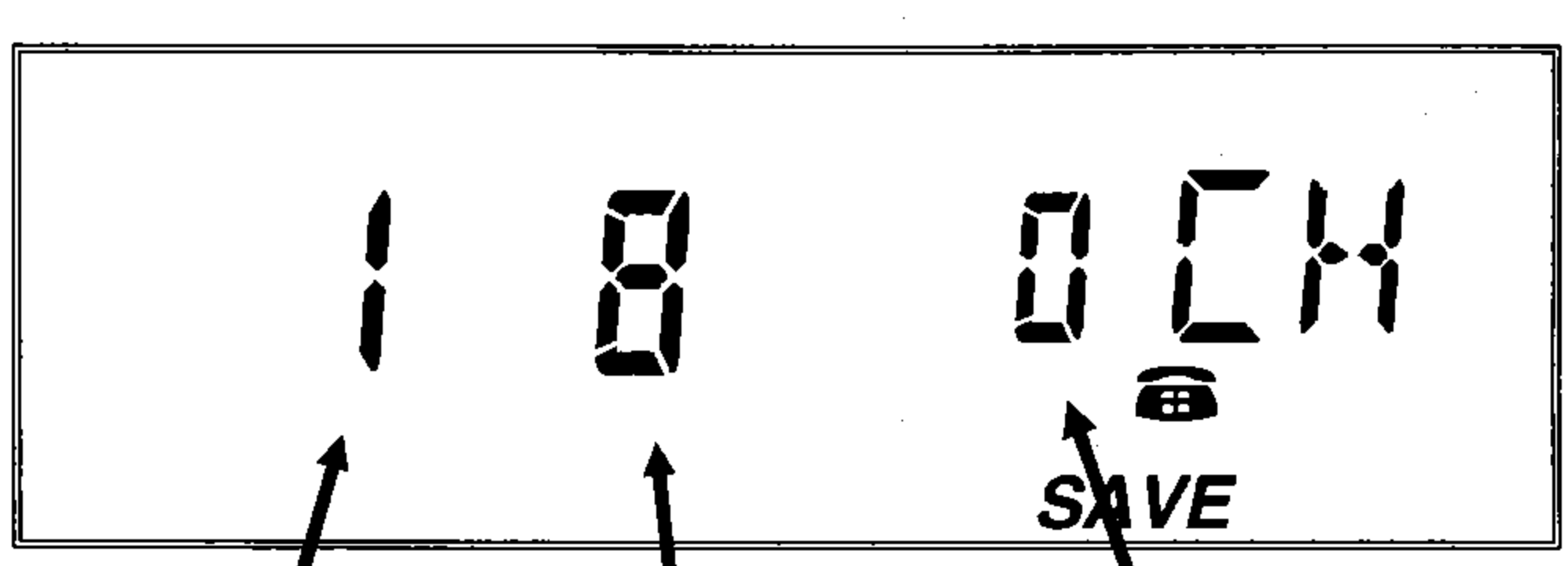

Digit Location (1st digit) 1st Digit of Phone Number (to be stored as 1st digit) Autodial Memory Number

- Press and hold **QW** for 1/2 second (until the second beep sounds), and press a numbered key corresponding to the DTMF autodial memory number you want to store. The right side of the display shows **[H** (or whatever number you pressed).
- Press and hold **QW** again for 1/2 second (the right side of the display blinks), and then key in the phone number you want to store. As you do so, the left side of the display shows the digit location number incrementing automatically as the entered digit is displayed to the right of it.

If you make a mistake, press the PTT switch to cancel your entries, and repeat the last step (all digits must be re-entered). Remember: the **[H** must be blinking before you can enter digits.

- If you entered fewer than 15 digits, press the knob down momentarily to terminate entry (if you entered 15 digits, entry terminates automatically after the last digit, and returns to the operating display: for the next step, you'll have to hold **QW** for 1/2 second and press the DTMF memory number).





- Turn the knob to review your stored number (or press the key corresponding to that memory to replay it), and press another numbered

key to select another DTMF memory to store, if desired, repeating the last two steps.

- Press the knob down momentarily to return to the frequency display.

The non-numeric DTMF tones map to the high-end keypads as follows:

Non-Numeric DTMF Tone Mapping

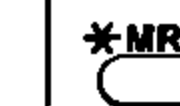
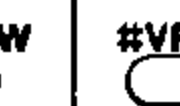
DTMF Tone	A	B	C	D	*	#
Display	R	J	[]	E	F
Key	LWLCK 	TN TS 	HM RV 	G W 	*MRMW 	#VFODW 

Autodialer Playback (📞🔊)

You can manually check the contents of DTMF autodial memories while 📞 is displayed. Also use this to play back stored memories into a telephone.

- Hold  for ½-second, then press any numbered key to display and play that DTMF memory. Turn the knob to review each stored digit.

To play back DTMF autodial memories on the air, first make sure the DTMF memory mode is activated (📞 displayed). Then close the PTT and simply press the number of the autodial memory to transmit. Once the DTMF sequence has begun, you can release the PTT.

Downloaded by
 Amateur Radio Directory

www.hamdirectory.info

Digital Voice 📞

The high-end keypad includes a digital voice recorder that stores one or two messages up to 20 seconds long. You can record messages by the microphone for playback manually or automatically over the air, and you can manually or automatically record received signals.

By default, one message can be recorded, and is displayed as REC and PLY during recording and playback, respectively. Before recording, you may wish to partition the 20-second voice memory into two segments, displayed as REC1 / PLY1 and REC2 / PLY2. The second segment can be up to 10 seconds long, with the first segment using the remainder. Both segments can be used for manual recording and playback, but only the first segment can be used for automatic receive recording, and only the second segment can be used for automatic voice transmission.

To partition the voice memory:

- Hold the knob down for ½ second, then release and turn it to display MTIM -28-.
- Press the knob momentarily and turn it to set the number of seconds to record for REC2 (up to ten seconds). The remaining time (20 minus the selected time) is allocated to REC1.

- Press the knob again momentarily to accept your setting, and then PTT to return to the operating display.

Note: If you record without first partitioning the voice memory, and later partition it, the *second part* of your previous message will be in the first partition (played back as PLY1), and PLY2 will play back the *entire original message, but with the partitions reversed!* To clear this condition, record the second partition (REC2) again.

Mic Recording

To record your voice through the microphone:

- Hold  for ½ second until REC or REC1 appears.
- If you have partitioned the voice memory, turn the knob if you want to record REC2.
- Press the PTT and speak your message into the microphone (no transmission occurs).

During recording, MIC appears at the left, and the number of seconds remaining in the segment counts down at the right. You can release the PTT to stop.

Extending Battery Life

How long NiCd batteries last between charges or replacement depends largely on your operating habits, and how you care for the battery pack. The FT-10R and FT-40R offer a variety of ways to conserve battery power, and extend the life of each charge. Knowing how to use these features can be critical in emergencies.

APO (Automatic Power-Off)

Obviously the best way to save battery life is to turn the set off when not in use. You can activate APO to turn the transceiver off after a half hour, an hour, or 8 hours of key inactivity. APO is disabled by default, but you can activate it as follows:

- Hold the knob for ½ second, and then release and turn it to display **RP** -14-
- Press the knob momentarily, then turn it to select **0.5H**, **1H**, **8H** or **oFF** (APO deactivated).
- Press the knob again momentarily to accept your setting, and press the PTT to return to the operating display.

When the APO timer is active, **P** appears at the lower right corner of the display, and the timer resets every time you press a key or move

the knob. If you don't press any keys for the selected time-out period, and *you are not scanning or using Dual Watch*, **P** begins blinking, and if you have the key beeper activated (page 47), an alert melody plays about a minute before the radio turns itself off. Press a key in that minute if you want the radio to stay on.

Once it turns off, you must switch the radio back on for use. If you need to monitor for a long period, or if using an external DC supply, you can deactivate APO by the same steps above.

Receive Battery Saver

Monitoring with squelch closed requires about one third the power of listening to signals or noise, so you naturally want to keep the squelch closed as much as possible. The receive battery saver system reduces current drain during squelched monitoring by putting the receiver to 'sleep' after the squelch closes, and then waking it up periodically to check for incoming signals. When the Battery Saver is enabled, **SAVE** is displayed near the bottom right, blinking when the saver is functioning.

You can select from ten monitor/sleep ratios, from 1:1 to 1:10, or the ABS (Automatic Battery

Saver) function, which senses channel activity and dynamically selects a ratio to match recent channel activity.

The ABS mode is enabled by default. To check or change the ratio or disable the Battery Saver:

- Hold the knob down for ½ second, then release it and turn it to display **RSR** -12-
- Press the knob momentarily, then turn it to select from the available ratios, **Rb5**, or **oFF**.
- Press the knob again momentarily to accept your selection, then press the PTT to return to the operating display.

Transmit Battery Saver

A good habit is to always use the lowest transmitter power necessary to maintain reliable communications (in fact, it may be the law in your country). As described on page 12, you have a choice of four levels of power output: high, low 1, low 2 and low 3. Activating TX Save can reduce transmitter current drain even further, by reducing power output *when a full-scale signal is sensed on the receive frequency*.

TX Save is disabled by default, but can be turned on as follows:

- Hold the knob down for ½ second, then release it and turn it to display **TSR** -13-

- Press the knob momentarily, then turn it to select **o1** (or **oFF** to deactivate).

- Press the knob again momentarily to accept your selection, then press the PTT to return to the operating display.

Notice that the **SAVE** indicator is displayed during transmission when the TX Save function is activated.

Regardless of whether you use the TX Save feature, notice that the current drain of the **L1** setting is much less than the **H1** setting, so it is good to develop the habit of always using the lowest setting possible, switching to high power only when low power fails to get through. If you live in a location where high power is almost always needed, consider using a higher gain antenna instead of high power (the effect on transmissions is the same, but receive performance improves as well). Make sure any external antenna is designed for 50 ohms impedance at the operating frequency.

Beeper Disable

The keypad beeper draws several milliamperes, so you may want to disable it if you need to conserve power while using the controls a lot. Note, however, that you will lose the audible feedback that indicates key functions and errors. To disable the beeper:

- Hold the knob down for ½ second, then release it and turn it to display **BEEP -11-**.
- Press the knob momentarily, then turn it to select **on** (or **off** to disable).
- Press the knob again momentarily to accept your selection, then press the PTT to return to the operating display.

BUSY/TX LED Disable

The LED draws about 15 milliamperes when the squelch is open, and when transmitting. However, you may not need it: the BUSY function of the LED is duplicated by the  icon at the right side of the display when the squelch is open, and the bargraph always shows the TX power level when transmitting. You can disable the LED to conserve power:

- Hold the knob down for ½ second, then release it and turn it to display **LIT -17-**.

Battery Care

As the battery discharges, the voltage drop (especially when transmitting) increases. When battery voltage drops to around 4.0 volts,  appears blinking at the bottom right of the display, indicating the batteries should be replaced or recharged. As battery voltage drops further, the transceiver shuts off.

Transmit Time-Out Timer

You can avoid embarrassing situations where the transmitter gets locked on, for example, if the radio slips between the car seat with the PTT squeezed. The time-out timer shuts off the transmitter after continuous transmission of 10 minutes.

Press the knob down for ½ second, then turn it to display **TOT -21-**.

Press the knob momentarily, then turn it to display **on** (or **off** if you want the time-out timer disabled).

Press the knob down for ½ second, then release it and press the PTT.

- Press the knob momentarily, then turn it to select **off** (or **on** to enable).

- Press the knob again momentarily to accept your selection, then press the PTT to return to the operating display.

Selective Calling

Obviously, if the channel is quiet, the squelch does not open often, and power drain is minimized (particularly if the Receive Saver is active). Unfortunately, you may not always be able to use quiet frequencies. The CTCSS tone squelch, DCS and DTMF selective calling features can essentially make a quiet channel out of an otherwise busy one. When the decode function of these systems is active, the squelch only opens (and BUSY/TX lights) when a signal has a tone that matches one you have selected. This can extend battery life considerably.

Earphones & Speaker/Mics

Using the lowest possible volume setting minimizes current drain while receiving. You can hold the transceiver up to your ear and reduce the volume to minimum, but it may be more convenient to use an earphone or speaker/mic, and keep the transceiver clipped to your belt, particularly in noisy environments.

If using rechargeable batteries, switch the transceiver off and recharge or replace the battery as soon as  appears. Try to avoid recharging Ni-Cd batteries often with little use between charges, as that can degrade the charge capacity and useful life of the cells. Since it is hard to know exactly when the charge will run out, you may want to carry an extra, fully-charged pack with you to avoid having operation interrupted.

Busy Channel Lock-Out (BCLO)

To avoid causing interference or doubling, you can prevent the transmitter from operating whenever a signal is present:

- Hold the knob down for ½ second, then turn it to display **BCLO -23-**.
- Press the knob momentarily, then turn it to select **on**.
- Press the knob again, then press the PTT.

This setting may cause problems with repeaters that require you to respond before the carrier drops. It does not affect ARTS operation (automatic transmission is automatically inhibited when a carrier is present).

Packet Radio

To use the radio for packet, the receiver battery saver should be disabled (see previous section), since the sleep periods used in power saving can cause packets to be missed.

Connect the MIC/EAR jack to your TNC as shown below. MIC impedance is $2\text{ k}\Omega$, and maximum input is $300\text{ mV}_{\text{rms}}$. EAR impedance is 8 ohms , and maximum output is 2 V_{rms} (w/9.6-V supply).

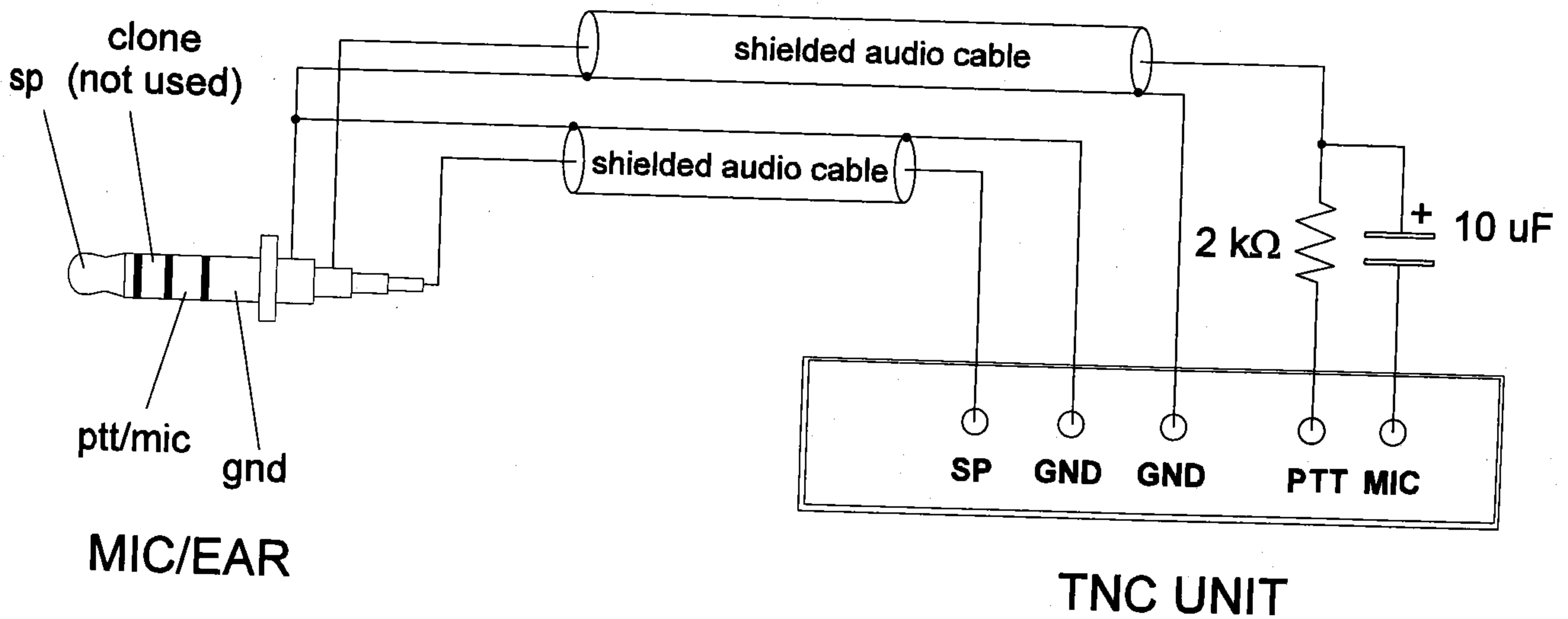

Cloning

You can copy all memories and settings from one radio to another of the same type, as follows:

Connect the MIC/EAR jacks of the two radios together using a cable with a 4-contact plug at each end.

With both radios turned off, turn each one on while holding both the knob down and the PTT pressed. `CLON` appears on both radios.

Press the middle (Monitor/TCall) button on the left side of the destination radio. `LOA` appears.

Press the PTT on the source radio. Now `SEN` appears blinking on this radio, and the display on the destination radio should also start blinking as data is transferred.

If successful, `CLON` reappears on both displays. Otherwise, one of the errors below may appear:

`ERR1` = cable or connection problem.

`ERR2` = compatibility problem: for example, attempting to clone from a 16-key pad to a 6-key pad.

`ERR3` = CPU version mismatch: for example, attempting to clone from a Japanese to a US version.

`ERR4` = low voltage: the EEPROM requires at least 3V to write. Try replacing the battery.

After correcting the problem, if you want to try cloning again, press the PTT to reset the source radio, or turn the destination radio off

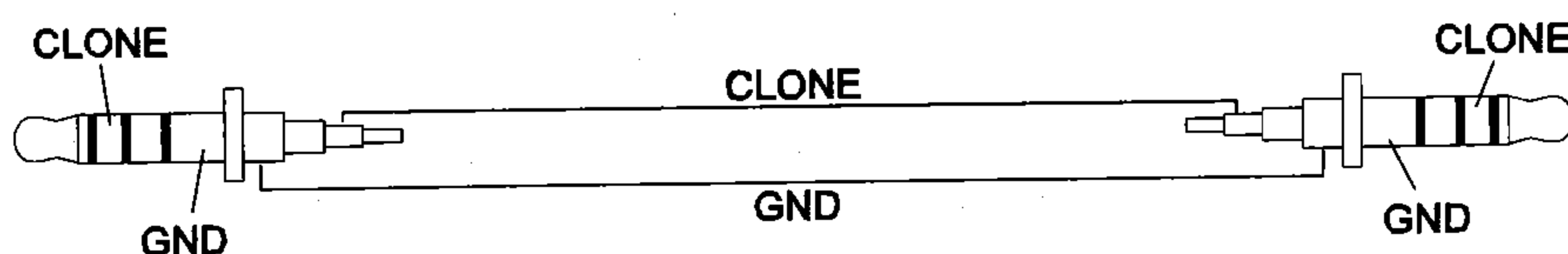

Knob

Holding the knob down for ½ second accesses the function setting menu, beginning with the last one used. However, by default, pressing the knob momentarily from the operating display does nothing. You can modify this so that the momentary - press allows you to instantly display and change one of the following settings:

- Receiver Battery Saving (R^SBA^{II}).
- Automatic Power Off (APO).
- Repeater Shift Direction (RPT^R).
- Tuning Steps (STEP).
- Auto Transmitter Power Saver (T^SBA^{II}).
- Keypad Beeper (BEEP).
- Squelch (SQL).
- Paging/Trigger Paging/Code Squelch (PAGE)*.
- DTMF Code Setting (CODE)*.
- DTMF Autodial Memories (DTMF)*.

* only available in high-end keypads.

To modify the momentary - knob press:

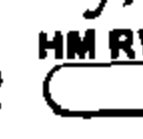
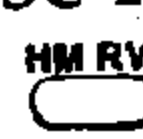
- Press the knob again momentarily, then turn it to select RE^{II} if you want the  key to reverse repeater shift, or to HOME if you want the  key to toggle the HOME channel (default).
- Hold the knob down for ½ second to accept your choice, and press PTT to return to the operating display.





Monitor/T.Call Button

The middle button at the left side below the PTT can be set to either override the squelch, or transmit a 1750-Hz tone burst, as described on page 13.

- Hold the knob down for ½ second, the release it and turn to display KEY -20-.
- Press the knob momentarily (SEL appears).
- Press the knob again momentarily, then turn it to select the function you want quick access to.
- Hold the knob down for ½ second to accept your choice, and press PTT to return to the operating display.

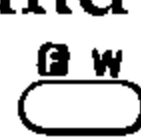
Now you can press the knob momentarily to instantly access the chosen function for setting. You can then turn the knob to change the setting and then press it and the PTT to quit.

Home/Rev Key

By default, pressing this key switches operation to and from the HOME channel, while pressing  →  reverses repeater shift. You can modify this behavior so that pressing the key alone reverses repeater shift, and pressing  →  switches the HOME channel:

- Hold the knob down for ½ second, the release it and turn to display KEY -20-.
- Press the knob momentarily (SEL appears), and turn it to display H/R.

Half Deviation

Transmitted audio is normally limited to ±5 kHz deviation. You can reduce this to ±2.5 kHz (half) deviation if you normally speak very loudly, and want to decrease the possibility of distortion on your transmitted signal.

- Press the knob ½ second.
- Turn it to HDE^{II} -22-.
- Press it again momentarily to display the current setting (OFF or ON).
- Turn it to select ON if you want half deviation.
- Press it again momentarily to accept the new setting.
- Press PTT to return to the operating display.

Note that this setting does not affect battery drain.

Appendix

In Case of Problems

Don't worry if you find operation somewhat complicated at first. There are many more features than the display can indicate at one time, and some keys have more functions than are indicated by their labels. So it is not difficult to get lost, at least until you have had the chance to learn the various functions of the display, knob, and keys. This section provides some tips to help you navigate the various display and key modes if you get stuck.

If the display is blank, make sure you are holding the PWR button for ½ second. If necessary, remove the battery pack and check that the contacts are clean. If all appears to be physically in order, recharge or replace the batteries.

The display tells a lot about the current state of operation. If you are not sure what it is showing, try switching the radio off and back on to recover the operating frequency display. A special case is the Memory-Only Mode, which has to be disabled by turning the radio off, and then holding the PTT and LAMP buttons (top and bottom buttons on the left side) while simultane-

ously holding the PWR button for ½ second to turn it on again.

ously holding the PWR button for ½ second to turn it on again.

Fortunately, the display includes many symbols and function indicators to let you know what is going on as long as power is applied, so it is well worthwhile to study the display diagram later in this chapter carefully. For example, if the frequency display changes unexpectedly when you transmit (or if *ERR* appears), check for **+** or **-** at the top left corner of the display, indicating that the operating frequency, with the selected repeater shift, is out of band.

Attempting an invalid keystroke usually does nothing, and either no beep sounds, or three beeps sound. However, if the keypad is locked, nothing happens when you press a key for even legal commands. Check for **KL** (key lock), **DL** (DIAL lock) or **PL** (PTT lock) at the top

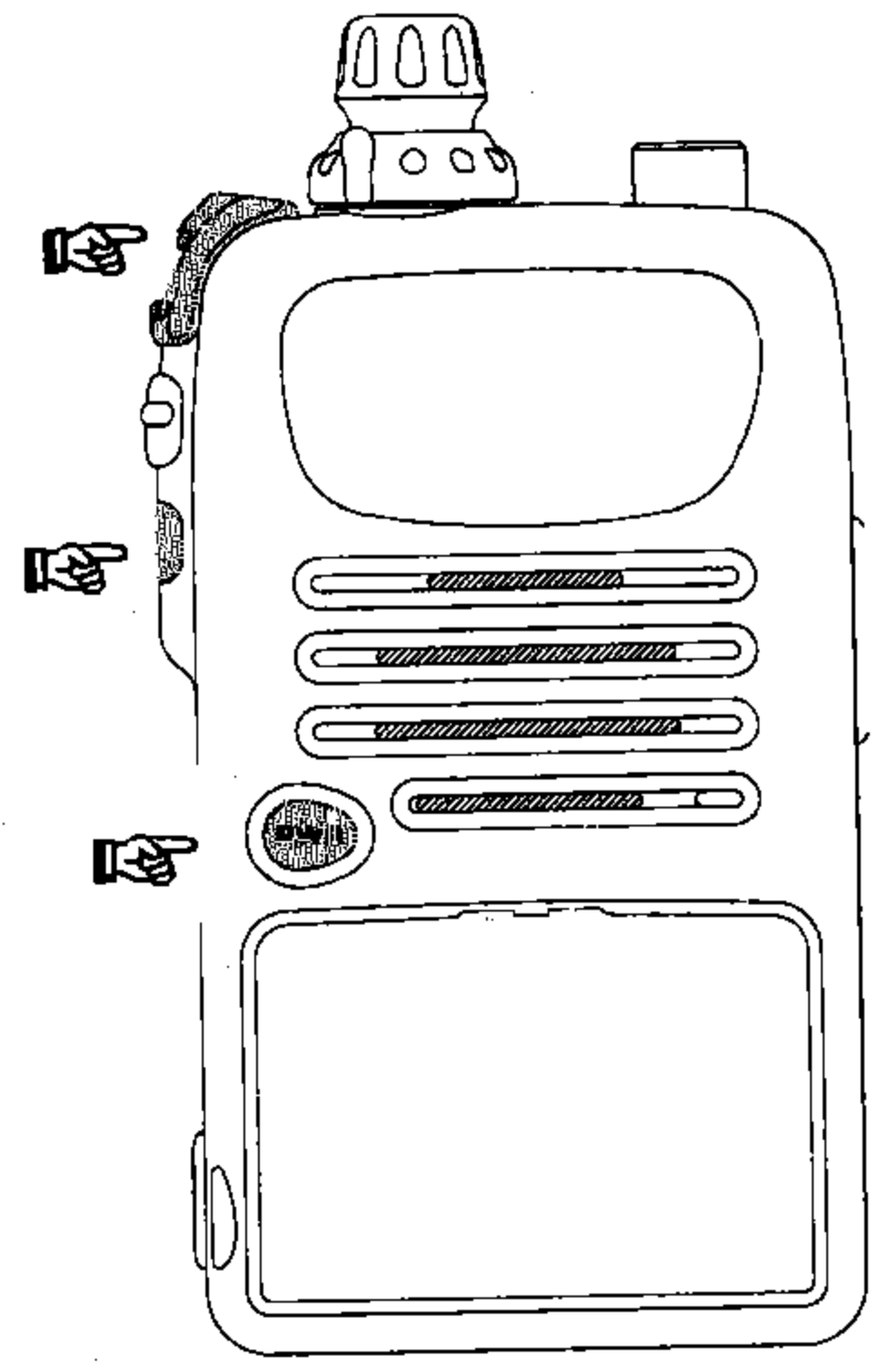

Resetting the CPU

As a last resort, if you are unable to gain control of the transceiver (or if you want to clear all memories and settings to their defaults), press down and hold both the knob and the monitor button (the middle button on the left side) while also holding the PWR button for ½ second to turn the transceiver on. *INIT* displays for a few seconds, and the display on page 8 appears.

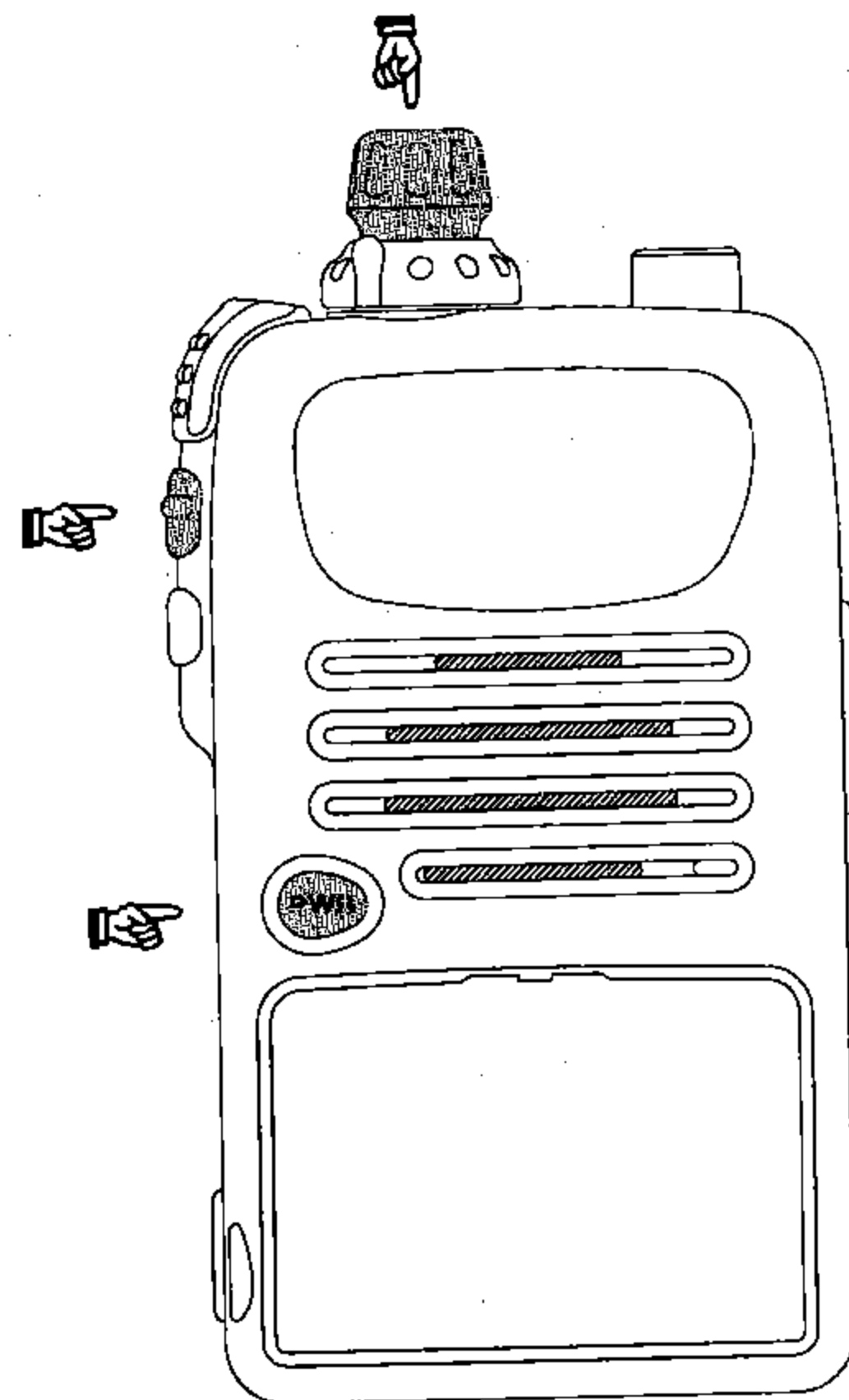

right corner of the display. If you see one of these, press **GW** → **LWLCK** (or **GW** → **LWLCK**).

If you still cannot enter data, check to see if the **BUSY/TX** LED is red, indicating the transmitter is activated. Releasing the PTT should return the set to receive. If not, switch the transceiver off, and then back on.

To avoid confusion resulting from inadvertent control adjustments, set the lock as described on page 26. Remember to set the lock back off when you wish to enter data.

Keypads

- FTT-10/A16S 16-Button Digital Voice Keypad
 FTT-10/A16D 16-Button DTMF Paging Keypad
 FTT-10/A16 16-Button DTMF Keypad
 FTT-10/A06 6-Button Keypad

Rechargeable Ni-Cd Battery Packs

- FNB-40 6.0 V, 650 mAh
 FNB-41 9.6 V, 600 mAh
 FNB-42 9.6 V, 1100 mAh

Ni-Cd Battery Chargers

- NC-50 Dual-Slot Rapid Charger
 CA-14 Charger Sleeve (required w/NC-50)
 NC-60B/C Compact 15-Hour Charger ('B' suffix for 117-V AC, 'C' suffix for 234-V AC)

Other Accessories

- FBA-15 Battery Case for 4 AA-size Dry-Cells
 CN-2 BNC -to- SMA Adapter
 CSC-68 Soft Case for FBA-15, FNB-41
 CSC-69 Soft Case for FNB-40
 CT-30 Microphone Adapter
 E-DC-5B External Power Cable
 MH-34B4B Speaker/Microphone
 PA-17 Battery Cable Extender
 RH-1 Rubber Case Protector
 VC-23 VOX Headset
 YHA-56 VHF Flexible Antenna for FT-10R
 YHA-57 UHF Flexible Antenna for FT-40R

Availability of accessories may vary: some accessories are supplied as standard per local requirements, others may be unavailable in some regions. Check with your Yaesu dealer for changes to the above list.

Keypads

There are four keypads available for the FT-10R and FT-40R, listed with their functions in the table below. See your Yaesu dealer if you want another keypad.

FEATURES	FTT-10/A16S	FTT-10/A16D	FTT-10/A16	FTT-10/A06
Memories	99	99	30	30
DCS & ARTS	○	○	○	○
CTCSS Tone Encoder	○	○	○	○
DTMF Keypad	○	○	○	
Keypad Frequency Entry	○	○		
CW ID	○	○	○	○
CTCSS Tone Squelch	○	○		
Paging & Code Squelch	○	○		
DTMF Autodial Memories	○	○		
Digital Voice	○			

Each keypad kit includes a keypad, rubber gasket, NiCd recycling label and small phillips screwdriver:

- Turn the radio off, and remove the battery.
- Peel off the black NiCd information seal, and loosen (but not completely remove) the two screws on either side of the slot behind the keypad.
- From the rear, carefully press on both screws with both thumbs to eject the keypad slightly, then remove the screws to free the keypad.
- Locate the plastic connector on the radio circuit board, and *gently* pull up on the *hinged* locking strip in front of the ribbon cable to release the cable (take care when doing this).
- Insert the end of the new keypad cable as far as it will go into the connector.
- Press the locking tab back down over the cable.
- Gently but firmly press the new keypad into place on the front of the radio, ensuring an even gasket seal around the keypad periphery (no "pinching").
- Replace the two screws removed from the slot behind the keypad, making sure the keypad and gasket fit evenly, without pinching.
- Affix the new NiCd label and replace the battery.

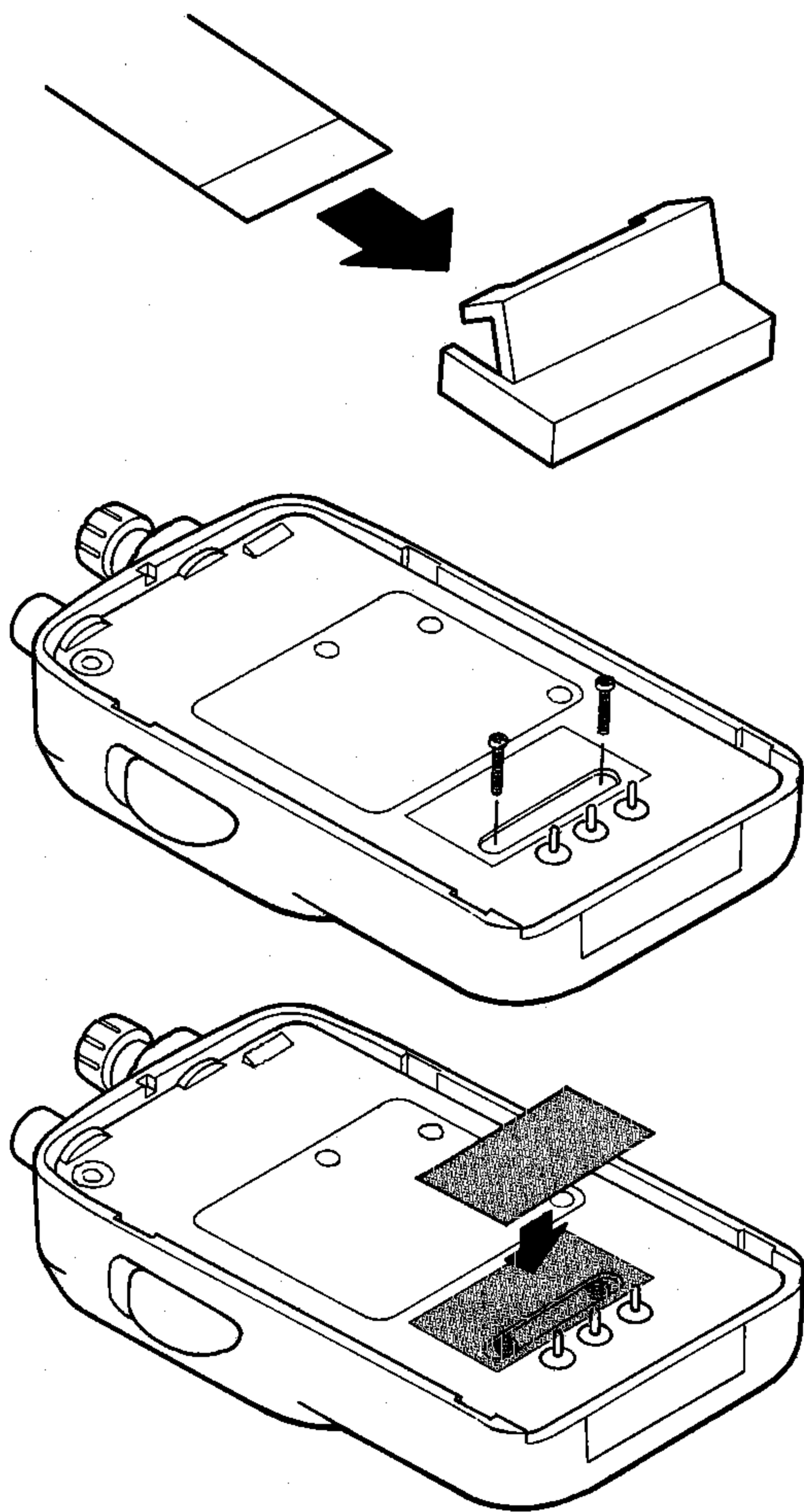
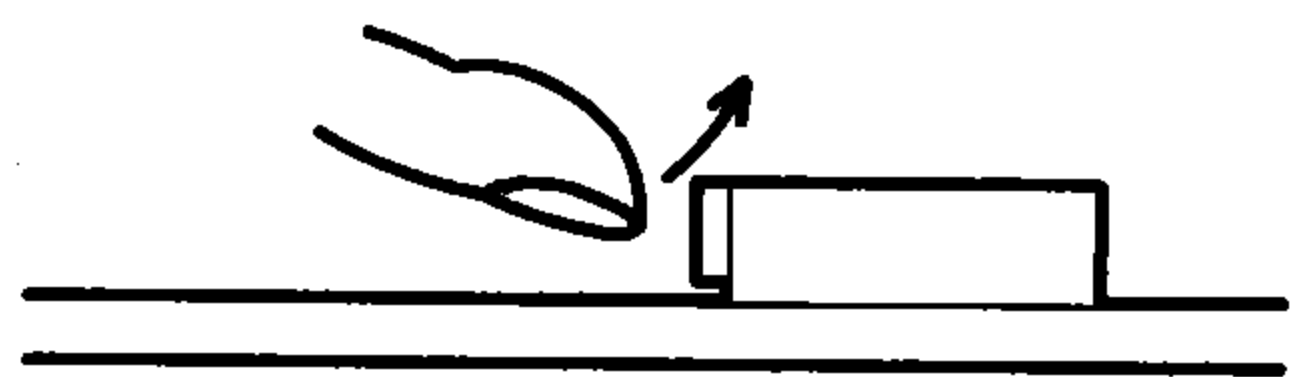
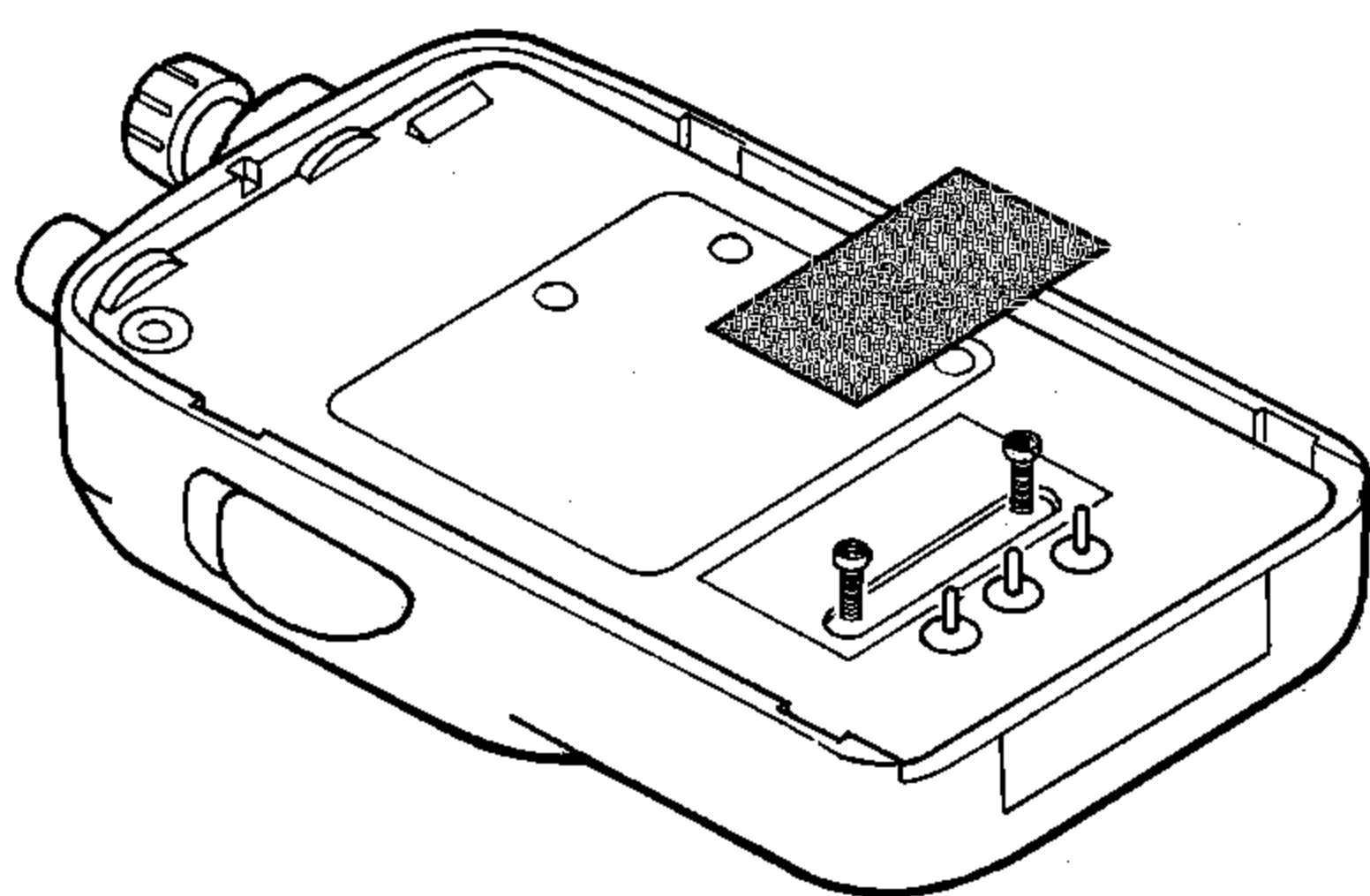

Batteries & Chargers

The FT-10R/-40R require the FNB-41 or FNB-42 9.6-volt rechargeable Ni-Cd battery packs for full 5-watt transmitter power output. However, where slightly lower maximum power output is practical, the 6-volt FNB-40 & -49 Ni-Cd packs offer smaller size and lighter weight. Any Ni-Cd pack should be fully charged before it is used with the transceiver for the first time.

Two types of battery chargers are available: the NC-60 15-hour compact charger and the the NC-50 Rapid Charger (used with CA-14 Charge Adapter). The NC-60 is available with a 'B' suffix for operation from 117-V AC, or with a 'C' suffix for operation from 220 ~ 234-V AC.

NC-50 Dual-Slot Rapid Charger

This AC mains battery charger features rapid and trickle charging modes for all FNB Ni-Cd packs. It requires the CA-14 Charger Sleeve for the FNB-40, -41 and FNB-42, and comes wired for the mains voltage in the area sold.

The rapid mode automatically brings the battery pack up to full charge as fast as safely possible using a peak voltage sensor. A red LED lights during rapid charging, and when the pack approaches full charge, the charger reverts to trickle mode (green LED), to prevent self-dis-

charge. The rapid mode recharges a fully-discharged battery in about one hour.

FBA-15 Dry-Cell Battery Case

The FBA-15 dry-cell battery case uses four 'AA'-size (UM-3) batteries. Maximum power output is about 2 watts. Use alkaline cells for best performance. For ease of battery installation, insert the + end in first, then press the - end so that the battery 'snaps' into place. Note: the lower single battery can be ejected by pulling upward on the white strip.

Caution! The FBA-15 must not be used with rechargeable cells. It lacks the necessary thermal and over-current protection circuits provided in the FNB series Ni-Cd Packs.

One or more of the above battery packs/cases may be supplied with the transceiver. If you need a battery, contact your Yaesu dealer. We do not recommend using any other type of battery, and doing so may affect your warranty.

Battery Removal & Replacement

- Make sure the power is switched off, and remove the protective soft case, if used.
- Hold the radio face down in your left hand, and with your right hand, press the Battery Release button behind the antenna jack while

sliding the battery down 1/3 inch. Then lift the battery away.

To open the FBA-15 battery case, hold it in your right hand, inside up, and slide the release catch upwards while slipping your left index finger under the notch to the left of the release catch to lift the panel. Always replace all four batteries, paying attention to the polarity indicated inside the case.

To replace the battery case panel, align the two notches at the bottom edge first, then press the top edge into the case.

✗ *Do not attempt to open any of the rechargeable Ni-Cd packs, and do not install rechargeable cells in the FBA-15, as they could explode if accidentally short-circuited.*

Alternate Antenna Considerations

While the supplied rubber flex antenna is convenient for short-range operation, the standard SMA jack allows use of a higher gain antenna to extend range in base or mobile operation. Any antenna used should have an impedance close to 50 ohms on the operating band. If a feed line is used, it should be good quality 50-Ω coax.

Other Accessories

MH-34B4B Speaker/Microphone

The Speaker/Mic can increase operating convenience and extend communications range. It includes a 4-contact plug which mates with the MIC/EAR jack on the right side of the transceiver, disabling the internal speaker whenever the plug is inserted. The cable lets you clip the transceiver to your belt, or hold it above obstructions for better performance. Hold the Speaker/Mic close to your ear during reception; or connect an earphone to the plug on the Speaker/Mic, attenuating the audio from its loudspeaker. To transmit, just hold the Speaker/Mic close to your mouth and squeeze the PTT switch on the microphone. A PTT logic circuit in the radio senses which PTT is pressed (transceiver or connected external Speaker/Mic), and selects the correct microphone audio input.

VC-23 VOX Headset

The VC-23 connects to the MIC/EAR jack on the right side of the radio. It consists of a head-band-supported earphone and attached boom microphone, allowing hands-free VOX (voice-actuated transmit) operation with the transceiver. For further details, refer to the VC-23 Operation Manual.

Controls & Connectors

Top & Front Panel

(1) Antenna Jack

This SMA jack accepts the supplied flexible antenna, or another antenna designed to provide 50-Ω impedance on the 2-m (FT-10R) or 70-cm (FT-40R) band.

(2) BUSY/TX Indicator LED

This LED glows red when transmitting, and green when the noise squelch is open (the channel busy) during reception, unless disabled by the **L5T -17-** setting.

(3) DIAL↔VOL Knob

The outer ring knob adjusts receiver volume, and the inner 20-position rotary switch tunes, selects memories and other functions and settings such as tuning steps and paging codes. For some functions you have to press the inner knob downward, either momentarily, or for 1/2 second. However, no functions require the knob to be turned while it is pressed (don't turn it while pressing). Many functions are accessible only by pressing this knob, but the

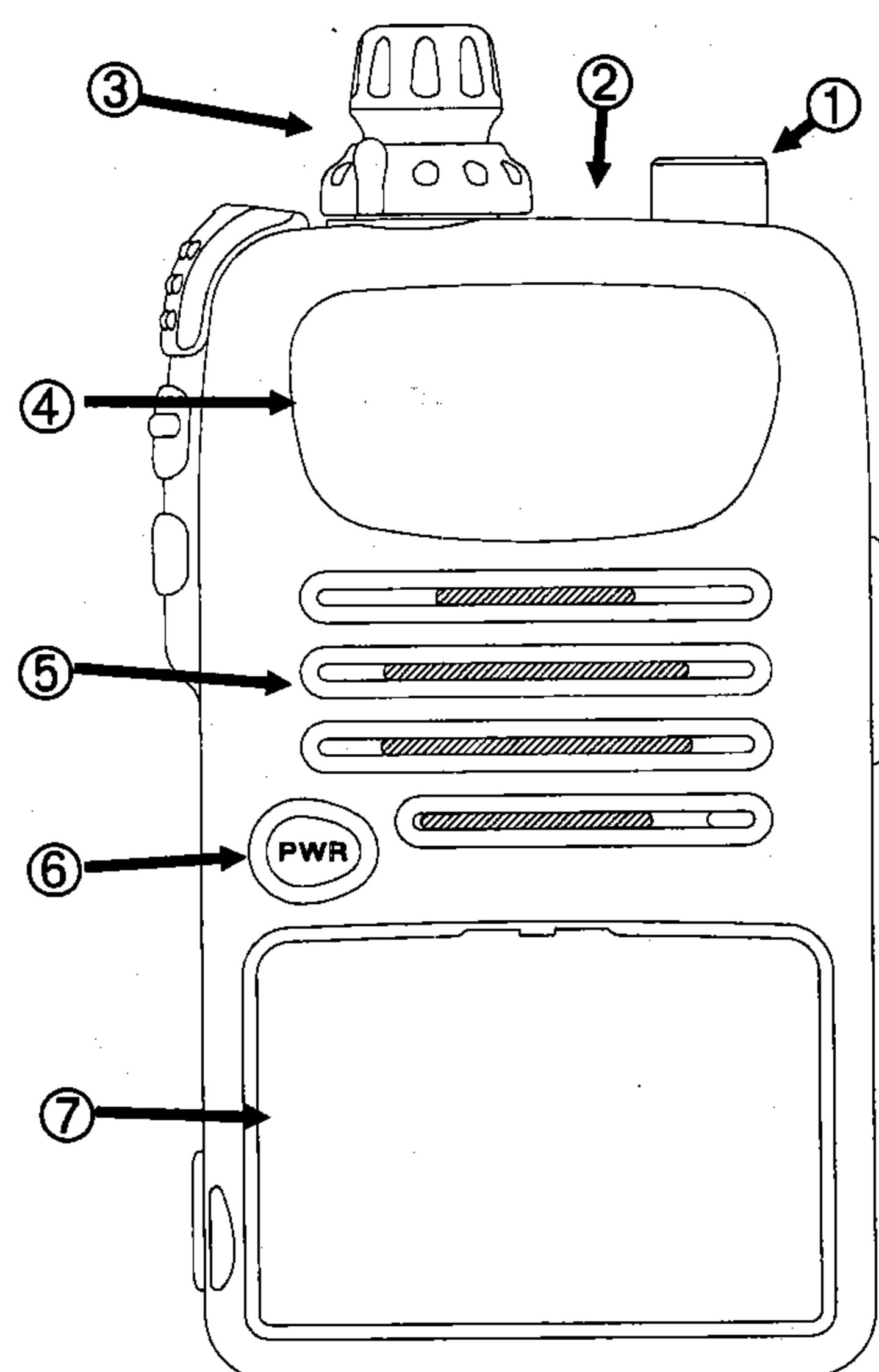

high-end keypads duplicate some functions with key sequences.

(4) LCD Display

The display includes many indicators of different functions, as shown on the page after next.

(5) Loudspeaker & Microphone

The internal loudspeaker and microphone are behind this grill. These are disabled when the MIC/EAR jack is used.

(6) PWR Button

To turn the transceiver on, press and *hold* this orange button for ½ second. Do this again to turn the power off.

(7) Front Panel Keypad

There are four keypads available. See page 56 for details of each.

Sides

(1) PTT Button

The upper PTT (Push-to-Talk) button activates the transmitter. Hold this button while speaking across the front of the radio to transmit.

tion of this button so that it transmits a 1750-Hz tone burst (page 13).

(3) LAMP Button

The (lower) LAMP button illuminates the display when operating in the dark. By default, the lamp lights for 5 seconds, but you can change it so that it lights (for 5 seconds) every time a key is pressed or the knob turned, or so that the LAMP button turns the light on until you press it again. To change the setting:

- Hold the knob down for ½ second, then release it and turn it to select **LAMP - 18**.
- Press the knob momentarily, and turn it to select between **55E** (the default), **KEY** (the keypad and knob activate the lamp for 5 seconds) or **TGL** (the LAMP button toggles the lamp on and off).
- Press the knob again momentarily to accept your setting, then release it and press the PTT.

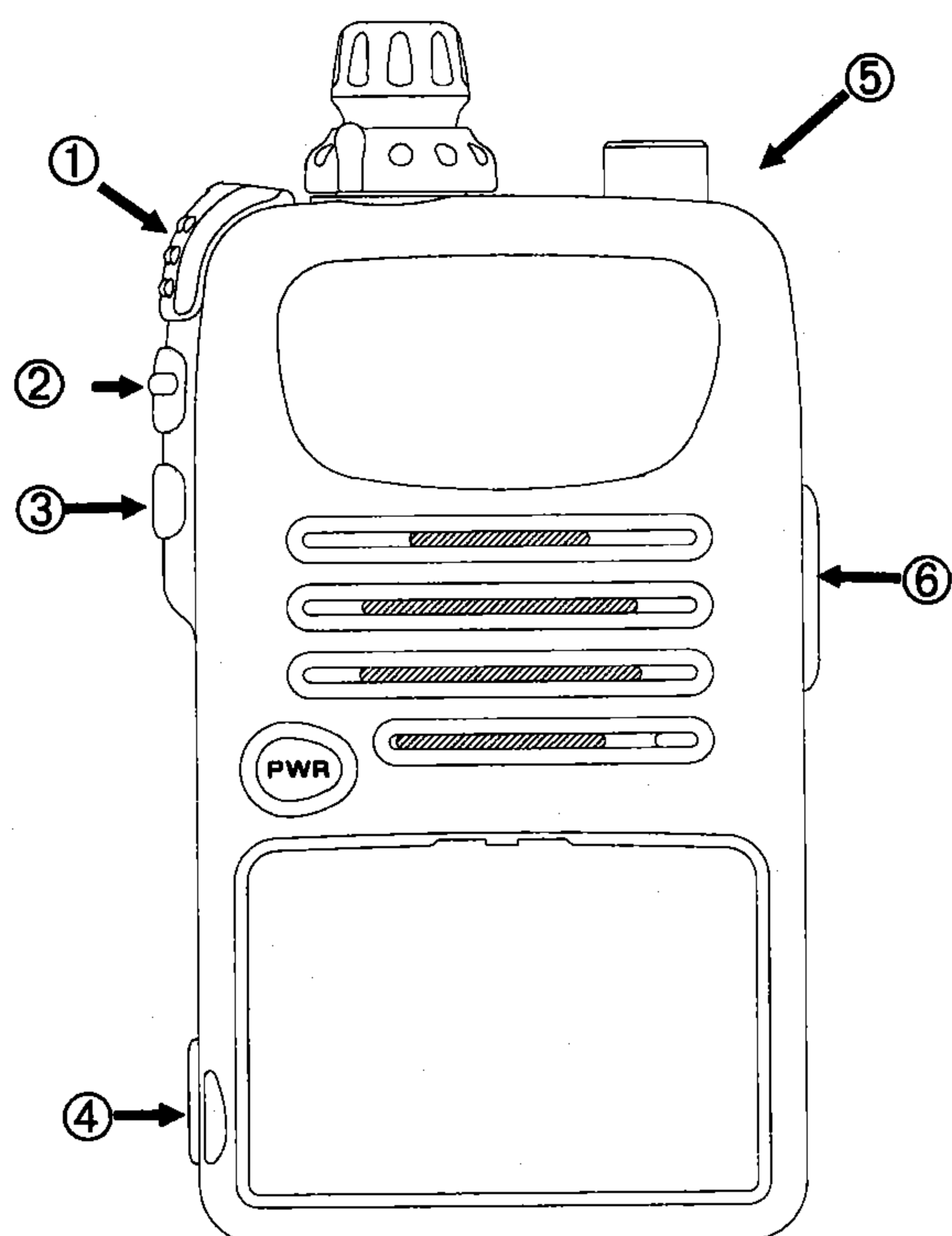

(2) Monitor/T. Call Button

The middle button, by default, acts as a Monitor/Squelch Override. Press this button to override the squelch, either to set the volume, or to temporarily defeat tone squelch so you can hear any signals. You can change the func-

(4) EXT DC Jack

This 4-mm coaxial jack accepts 5 to 13-V DC at 1A, via the E-DC-5B cable, to power the transceiver from an external supply. We recommend using this jack only with the optional cable.

(5) Battery Release Button (on back)

Press this button to release the battery for removal.

(6) MIC/EAR Jack

This 4-conductor, 3.5-mm mini phone jack provides 8-Ω audio output and accepts microphone input (2-kΩ) for using an optional earphone, speaker/mic or packet tnc. The internal loudspeaker and microphone are disabled when this jack is used.

Note: the protective rubber covers over the EXT DC and MIC/EAR jacks must be pressed over them when not in use, to protect the inside of the transceiver from dust and water.

Display Indicators

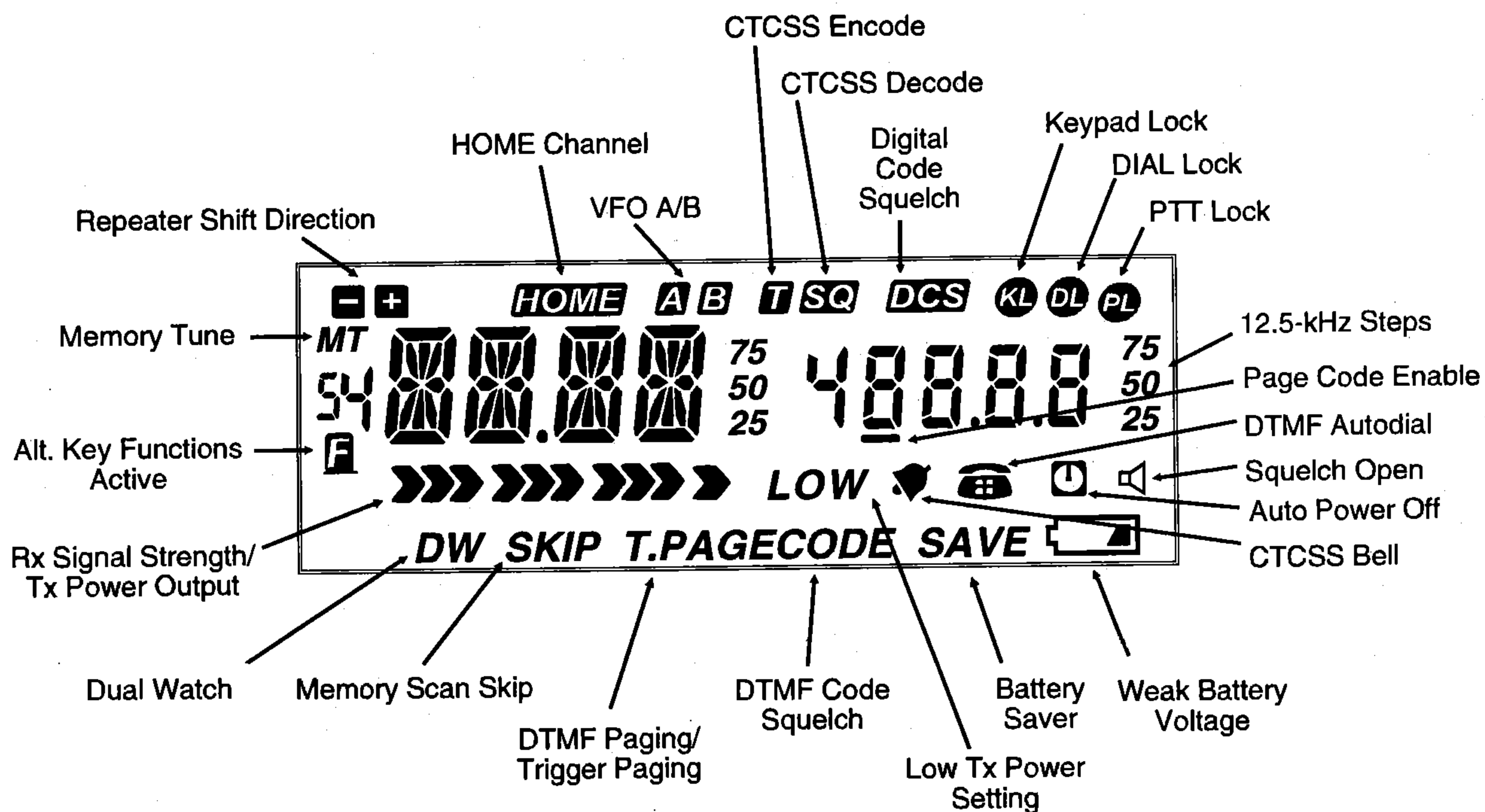

Downloaded by
 Amateur Radio Directory

www.hamdirectory.info

Dial Setting Functions

Display (hold knob)	Description	Selections (after holding knob 1/2 second, press momentarily, then turn)	Comments	Page
SOL -01-	Squelch level	0 ~ 15	default 8	2, 8
TXPO -02-	Tx power output	L1 → L2 → L3 → HI	default Hi	12
NAME -03-	Memory label	NAME off or on (or current name)	press DIAL & turn to enter chr	22
MCLR -04-	Clear memory	SET or CLR (memory bank/slot)	press DIAL to SET or CLR, turn DIAL to change SET/CLR	25
SUB -05-	Sub display	on or off	default on	20
ARS -06-	Auto rpt shift	on or off	default off	14
RPTR -07-	Rptr shift direction	+RPT → SIMP → -RPT	default simplex	13
SHIFT -08-	Repeater offset	0 ~ 9.95 (MHz)	default 0	13
STEP -09-	Channel steps	5.0* → 10.0 → 12.5 → 15.0* → 20.0 → 25.0 → 50.0	default 5 kHz *N/A on FT-40R	11
RESM -10-	Scan resume mode	5 → [Rrr (5-sec pause, or until carrier drop)	default 5	18
BEEP -11-	Keypad beeper	on or off	default on	47
RSBK -12-	Rx battery saver	RbS → 1:1 ~ 1:10 → off	RbS = Automatic battery saver	45
TSBK -13-	Tx battery saver	off or on	default off	46
APD -14-	Auto power off	off → 0.5H → 1H → 8H	default off	45
LOCK -15-	Control lock mode	KL → DL → KL DL → PL → KL PL → DL PL → KL DL PL	sets result of →	26
BELL -16-	CTCSS/DCS ringer	off or on	default off	28
LG7 -17-	BUSY LED	on or off	disable LED to save battery	47
LAMP -18-	Display lamp mode	5SEC (press LAMP button to light for 5 sec.) → KEY (lights 5 sec. when any key pressed) → TGL (LAMP button toggles light on/off)	default 5 sec. PTT and monitor/burst buttons do not affect.	62

Display (hold knob)	Description	Selections (after holding knob 1/2 second, press momentarily, then turn)	Comments	Page
GRP -19-	Memory Bank grouping	GRP 1?? shows no. of memories in bank 1. Press knob to clear to 00, then turn to set new size. Press again for banks 2 ~ 9	Default 30 in bank 1 only. Do not to press knob unless you want to change.	23
KEY -20-	Select function for momentary knob press, and for and button	SEL press knob to select OFF or setting function for momentary knob press. H/R press knob for HOME → RECALL M/T (button below PTT switch) press knob for MON → TCALL	Default function for knob press is OFF. H/R is as labeled on keypad, M/T is monitor (squelch override)	13, 51
TOT -21-	Tx time-out timer	OFF → ON	limits transmit time to 10 min.	48
HDEV -22-	Half deviation	OFF → ON	default off = 5 kHz	52
BCLD -23-	Busy chan. lockout	OFF → ON	Inhibit transmit on busy channel.	48
SFT -24-	Yaesu service	OFF → ON	Keep this OFF.	—
ARTS -25-	Auto Range Transpond System	SPEED 15 → 25 (polling interval, seconds) BEEP OFF → ON (on to beep when polling)	default interval is 25 seconds, with beeper on.	32
CWID -26-	Morse identifier	OFF → ON - press knob to display a digit no. at left. Turn to select a char to send. Repeat for up to 8 digits.	This feature is available in all keypad versions.	33
PAGE -27-	Pager settings	SPEED - 50 → 100 (DTMF digit dial time) DELAY - 450 → 750 (Tx delay after PTT) BELL - OFF → 1-3-5 (default is 3 rings) RSBK - OFF → ON (Answer-Back)	FTT-10/16S keypad only	38, 39
MTIM -28-	Voice memory partition REC2 size	OFF, 1 ~ 10 (seconds. Only 1 segment available if set to OFF: REC)	FTT-10/16S keypad only	42
AMSG -29-	Auto voice reply	OFF → ON (on: if MTIM ≠ off, transmits voice memory partition 2 when page received)	FTT-10/16S keypad only	44

Note: Normally, to exit after setting, hold the knob for 1/2 second to accept changes, then press PTT to return to operating display. To abandon a change, just press the PTT.

Tone System Tables

CTCSS Tone Frequencies (Hz)

67.0	94.8	131.8	186.2
69.3	97.4	136.5	192.8
71.9	100.0	141.3	203.5
74.4	103.5	146.2	210.7
77.0	107.2	151.4	218.1
79.7	110.9	156.7	225.7
82.5	114.8	162.2	233.6
85.4	118.8	167.9	241.8
88.5	123.0	173.8	250.3
91.5	127.3	179.9	—

DTMF Tone Pairs

	1209 Hz	1336 Hz	1477 Hz	1633 Hz
697 Hz	1	2	3	A
770 Hz	4	5	6	B
852 Hz	7	8	9	C
941 Hz	* (E)	0	# (F)	D

DCS Tone Codes (combinations of CTCSS Tones)

023	114	205	306	411	503	606	703
025	115	212	311	412	506	612	712
026	116	223	315	413	516	624	723
031	122	225	325	423	523	627	731
032	125	226	331	431	526	631	732
036	131	243	322	432	532	632	734
043	132	244	343	445	546	654	743
047	134	245	346	446	565	662	754
051	143	246	351	452		664	
053	145	251	356	454			
054	152	252	364	455			
065	155	255	365	462			
071	156	261	371	464			
072	162	263		465			
073	172	265		466			
074	174	266					
		271					
		274					

Note: '*' and '#' are displayed as 'E' and 'F' in Autodialer memories.

General

Frequency range (MHz): 144 ~ 146 or 148 (FT-10R)
430 ~ 440 or 450 (FT-40R)

Channel steps: *5, 10, 12.5, *15, 20, 25 & 50 kHz
* - not available in the FT-40R

Repeater shift: ± 600 kHz FT-10R, ± 5 , ± 7.6 , ± 1.6 MHz FT-40R (programmable in 100-kHz steps)

Emission type: F2, F3

Supply voltage: 3.5 to 12 V DC

Current consumption:

- 150 μ A Auto Power Off
- 13 mA Standby (Saver on)
- 200 mA Receive @ 9.6 V*, w/500 mW AF
- 50 mA Receive @ 9.6 V, (squelched)
- 1.2 A Transmit (5 W) FT-10R,
- 1.5 A Transmit (5 W) FT-40R

Antenna (SMA jack):

- YHA-56 rubber helical FT-10R
- YHA-57 rubber helical FT-40R

Case size (WHD): 57 \times 123 \times 26 mm w/FNB-40

Weight (approx.): 325 grams with FNB-40, antenna, belt clip

Specifications may be subject to change without notice or obligation.

Receiver

Circuit type: Double-conversion superheterodyne

IFs: 17.70 MHz & 455 kHz FT-10R
58.05 MHz & 455 kHz FT-40R

12-dB SINAD Sensitivity: < 0.16 μ V FT-10R
< 0.18 μ V FT-40R

Adjacent channel selectivity: > 70dB (FT-10R)
> 65 dB (FT-40R)

Intermodulation: > 70 dB FT-10R & FT-40R

AF output (@ 9.6 V, 10% THD): 0.5 W @ 8 Ω

Transmitter

Power output (@9.6 V):
approx. 5.0, 2.8, 1 & 0.1 W FT-10R
approx. 5.0, 2.5, 1 & 0.1 W FT-40R

Frequency stability: better than ± 10 ppm (FT-10R),
better than ± 5 ppm (FT-40R)

Modulation system: variable reactance

Maximum deviation: ± 5 kHz

FM Noise (@ 1 kHz): better than -40 dB

Spurious emissions: > 60 dB below carrier

AF distortion (@ 1 kHz): < 5%, w/3.0 kHz deviation (USA version), 3.5 kHz deviation (other)

Microphone type: 2-k Ω condenser

Downloaded by
Amateur Radio Directory

www.hamdirectory.info

Glossary

APO

'Automatic Power-Off' A function that causes the transceiver to turn itself off after a period of inactivity of the transceiver controls (0.5, 1 or 8 hours).

ARS

'Automatic Repeater Shift' A function in some versions that causes the transceiver to automatically activate a standard repeater shift direction and offset amount according to the current operating frequency, based on repeater ranges stored in ROM.

ARTS

'Auto Range Transpond System' A function that uses DCS to allow two radios to poll each other every 15 or 25 seconds, indicating whether they are within range of each other or not.

Autopatch

A radio-to-telephone connection, usually employed as part of a repeater, which allows radios to place telephone calls using DTMF tones. By convention, a DTMF star is required

to access the autopatch (pick up the phone) before dialing, and a DTMF pound is required to hang up.

BCLO

'Busy Channel Lockout' A function that can be enabled to prevent transmission when the channel is busy (when the squelch is open).

BEEP

Sound generated in the radio speaker in response to key presses, scanner cycling at band edges, or ARTS polling. Generally, three beeps indicates an error.

Code Squelch

A selective calling system in which the squelch opens only after receiving three DTMF digits in sequence, which match those displayed at the right side of the LCD.

Carrier (Scan Resume)

This is a setting which affects how the radio behaves when the squelch opens during scanning. By default, the radio resumes scanning after pausing on a signal for 5 seconds, whether or not the squelch closes. By changing the setting

to 'Carrier', scanning remains paused for as long as the squelch is open (the decimal in the frequency display blinks).

CTCSS

'Continuous Tone Coded Squelch System': (also called PL®-tone by Motorola) superimposes a single subaudible tone (one below the normal hearing frequency range) on a transmitted signal, so that a receiver can remain squelched to all signals that do not contain the same tone. There are 38 EIA-standard tones. All versions include a CTCSS generator ('encoder') for transmission, allowing access to repeaters that require such tones. High-end keypads also include a CTCSS decoder to provide 'tone squelch', which lets you monitor a busy channel and hear only signals that include a specific CTCSS tone.

DCS

'Digital Code Squelch': a variation of CTCSS which uses combinations of three subaudible tones, for a total of 105 combinations. DCS is used by the ARTS feature for automatic polling.

DIAL (Knob)

The inner knob on top of the radio. It has three different actions: turning, pressing momentarily, and holding for ½ second.

DTMF

Dual Tone Multi Frequency. A sequential signaling system using 16 pairs of audible tones. Originally developed for TouchTone® telephone dialing, radio systems also use DTMF for repeater control functions (such as autopatching), available with all 16-button keypads. Holding the PTT while pressing a key transmits a DTMF tone pair. The DTMF Code Squelch and Paging features in the high-end keypads also use an automatic DTMF encoder and decoder to transmit and receive 3- or 7-digit DTMF Code sequences.

DTMF Paging

DTMF Paging, provided in the high-end keypads, is a selective calling system in which each station uses 3-digit personal IDs, composed of three DTMF digits, to open their squelch. When someone pages you, they send your ID followed by a DTMF star and their ID. Your squelch opens when your ID is received, and their ID appears at the right side of your display, so you know who called. With the high-

end keypad, you can set your radio to automatically respond to them with your CW ID and even a pre-recorded voice message.

PMS Scanning

Programmable Memorized Subband Scanning: uses special memory slots (labeled L and U) to store low and high frequency limits for scanning. When either of these memories is recalled and scanning started, the radio scans the range between them at the channel step stored in the starting memory.

QSO

A two-way conversation.

Tone Squelch

High-end keypads include a CTCSS decoder which lets you monitor a busy channel and hear

only signals that include a CTCSS tone that you have pre-selected.

TOT

'Time-Out Timer' A function that can be enabled to limit the length of a transmission to 10 minutes.

VOX

'Voice-Actuated Transmit' Allows hands-free operation with the VC-23 headset, by keying the transmitter with only the sound of your voice.

Downloaded by
Amateur Radio Directory

www.hamdirectory.info