

## 2 METER HAND-HELD FM TRANSCEIVER FT-202R

The Yaesu FT-202R hand-held 2 meter FM transceiver provides high performance in a lightweight, completely portable package. Featuring an RF output of 1 watt and a flexible, quick-disconnect antenna, the FT-202R weighs less than a pound (less batteries). As many as 6 crystal-controlled channels may be selected (three are factory-installed) within any two MHz segment of the 2 meter band.

The latest solid state circuitry is used in the FT-202R. Teamed with the convenient carrying case, the FT-202R package assures the operator of many years of stable, trouble-free operation.

Either NiCd or dry cell batteries may be used with the FT-202R. A battery charger is an available option, for charging NiCd batteries after depletion. The battery charger also allows base station input of DC supply voltage, an external speaker, and a PTT switch.

The owner is encouraged to read this manual thoroughly, in order to understand the operation of the FT-202R. Straight-forward performance and quality design will provided you with many years of satisfaction with you new FT-202R from Yaesu.

## SPECIFICATIONS

### GENERAL

**Frequency coverage:**

144 MHz - 148 MHz

**Number of channels:**

6 (3 provided, 3 optional).

**Emission:**

Narrow-band FM (F3).

**Batteries (not furnished):**

AA size, NiCd (8 needed) or dry cells (7 needed).

**Voltage requirements:**

9.6 VDC  $\pm$ 10%, maximum 12 VDC.

**Current consumption:**

Receive 200 mA (30 mA squelched)

Transmit 500 mA.

**Case dimensions:**

69 x 49 x 171 mm.

**Weight (less batteries):**

400 g.

**TRANSMITTER**

**Power output:**

1 watt.

**Modulation type:**

Vector phase modulation.

**Deviation:**

$\pm$ 5 kHz.

**Spurious radiation:**

60 dB down or better.

**Microphone:**

Electrocondenser type, 2000 ohm impedance.

**Tone burst frequency:**

1800 Hz (US) or 1750 Hz (Europe, etc.).

### RECEIVER

**Circuit type:**

Double conversion superheterodyne.

**Intermediate frequencies:**

1st IF = 10.7 MHz.

2nd IF = 455 kHz.

**Sensitivity:**

0.32  $\mu$ V for 20 dB quieting.

**Selectivity:**

60 dB down at  $\pm$ 20 kHz.

**Audio output:**

500 mW @ 10% THD.

### FT-202R MODEL CHART

MODEL	TONE BURST FREQ.	TONE BURST/CALL	CHANNELS INSTALLED	
			CH	TX / RX
A	1800 Hz	0.5 sec. burst	A	146.52/146.52
			B	146.16/146.76
			C	146.34/146.94
B	1750 Hz	0.5 sec. burst	A	145.50/145.50
			B	145.525/145.525
			C	145.55/145.55
C	1750 Hz	Manual length European system	A	145.50/145.50
			B	145.525/145.525
			C	145.55/145.55

## SEMICONDUCTOR COMPLEMENT

### Integrated Circuits

MC-1306	1	MC-3357
MC-14011B	1	

### Field Effect Transistors

3SK51	1	JF1033B
-------	---	---------

### Transistors

2SA695D	1	2SC1311E
2SC710D	3	2SC1923O
2SC730	1	2SC2053
2SC1209D	1	MPSA13

### Silicon Diodes

1S1555	7	MI301
--------	---	-------

### Zener Diodes

WZ050	1	WZ056
-------	---	-------

## ACCESSORIES

- Helical whip antenna
- Dummy Battery
- Vinyl carrying case
- Shoulder strap

## CONTROLS, SWITCHES, AND CONNECTORS

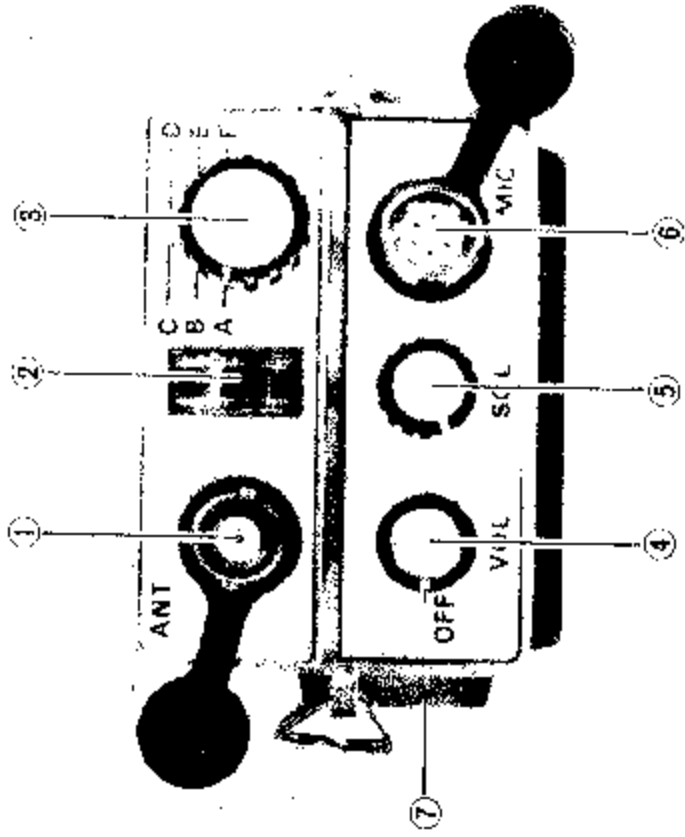

### 1. ANT

The antenna connector is a BNC female jack, for quick connection and removal of the antenna.

### 2. METER

On receive, the meter functions as a relative S-meter. On transmit, the condition of the battery is displayed. When the battery voltage drops below 8 volts, the meter indicator will be in the RED portion, indicating that battery charging or replacement is in order.

### 3. CHANNEL

The six transmit and receive frequencies may be selected via this switch. Three channels are supplied in positions A, B, and C while the remaining three channels are owner-installed options.

## ANTENNA CONSIDERATIONS

The FT-202R comes equipped with a flexible, helically wound antenna, which should be sufficient for local work through repeaters, etc. A different type of antenna may, however, be connected to the top panel BNC connector.

The external antenna should have an impedance of 50 ohms, and should be fed with good-quality coaxial cable. If your existing antenna has a connector which is different from the BNC type, consult your dealer regarding purchase of a suitable adapter.

## EXTERNAL SPEAKER/MICROPHONE (OPTION)

An external speaker and/or microphone may be attached through the top panel miniconnector, per the drawing below. The speaker should have an impedance of 2000 ohms.

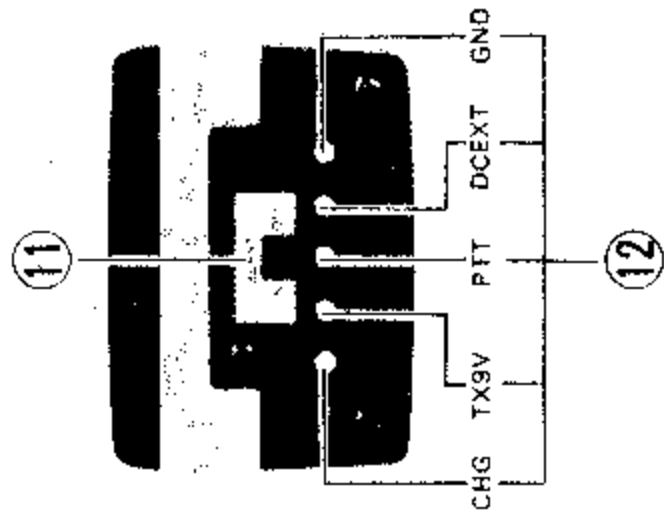

### 11. BURST

This switch activates the automatic tone burst generator.

### 12. ACCESSORY TERMINALS

When the FT-202R is inserted into the optional battery charger, these points provide connection for battery charging, PTT, DC power supply, and TX 9V DC.

in the OFF position while charging.

If the FT-202R is to be stored for an extended period of time without use, please be certain to remove the batteries from the case. NiCd cells should be charged once per month to avoid total depletion and polarity reversal.

Because of the high variation in ratings of alkaline dry cells and other types of dry cell batteries, we cannot estimate battery life when using other than the batteries described above.

When using the Yaesu FP-4 or other type of external supply, the optional battery adapter must be used. This adapter includes a voltage regulator to maintain the supply voltage at a safe level.

Do not exceed 12 volts of supply input at any time.

#### ADDITIONAL CHANNEL INSTALLATION (OPTION)

The FT-202R comes equipped with three channels already installed. The owner may install up to three additional channels with the addition of one transmit and one receive crystal per channel. The crystals for the FT-202R are manufactured to very close tolerances to ensure compatibility with the transmitter oscillator circuits. We recommend that you obtain auxiliary crystals from your dealer, so as to be assured of proper crystal function.

#### CRYSTAL SPECIFICATIONS

	Receive	Transmit
Type	NR-2 (CH. A,B,C) HC-25/U (CH. D,E,F)	NR-2 (CH. A,B,C) HC-25/U (CH. D,E,F)
Frequency (MHz)	$\frac{\text{RX Freq.} - 10.7}{9}$	$\frac{\text{TX Freq.}}{12}$
Tolerance	±20 PPM	±20 PPM
Parallel Capacitance	30 pF	30 pF
Drive level	10 mW	5 mW
Effective Resistance	Less than 20 ohms	Less than 20 ohms

In order to install new channels, the case must first be removed. Proceed as follows:

1. Remove the battery cover. Remove all batteries, and locate the screws A and B in the battery chamber. Refer to Fig. 1.
2. Remove these screws, and CAREFULLY remove the back of the transceiver. This will expose the next set of mounting bolts shown in Fig. 2.

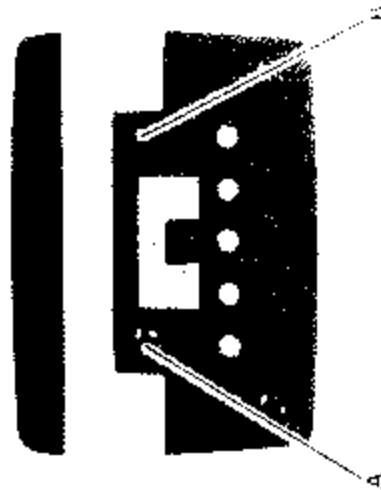

Fig. 1

3. Remove the bolts C and D shown in Fig. 2, and CAREFULLY remove the front panel of the case. The crystal bank will now be easily identified as shown in Fig. 3, 4.

Locate the crystal sockets appropriate for the channel to be installed, and install the crystals, being careful to insert the TX crystal in the TX socket, and the RX crystal in the RX socket.

If it is desired to use a crystal on more than one channel, small parallel jumpers may be installed. For example, if 146.34/146.94 is installed in channel C, and 146.94/146.94 is desired in channel D, jumper the receive crystal in channel C to the channel D RX socket, and install a TX crystal for 146.94. Refer to Fig. 5 for an example of this jumpering technique.

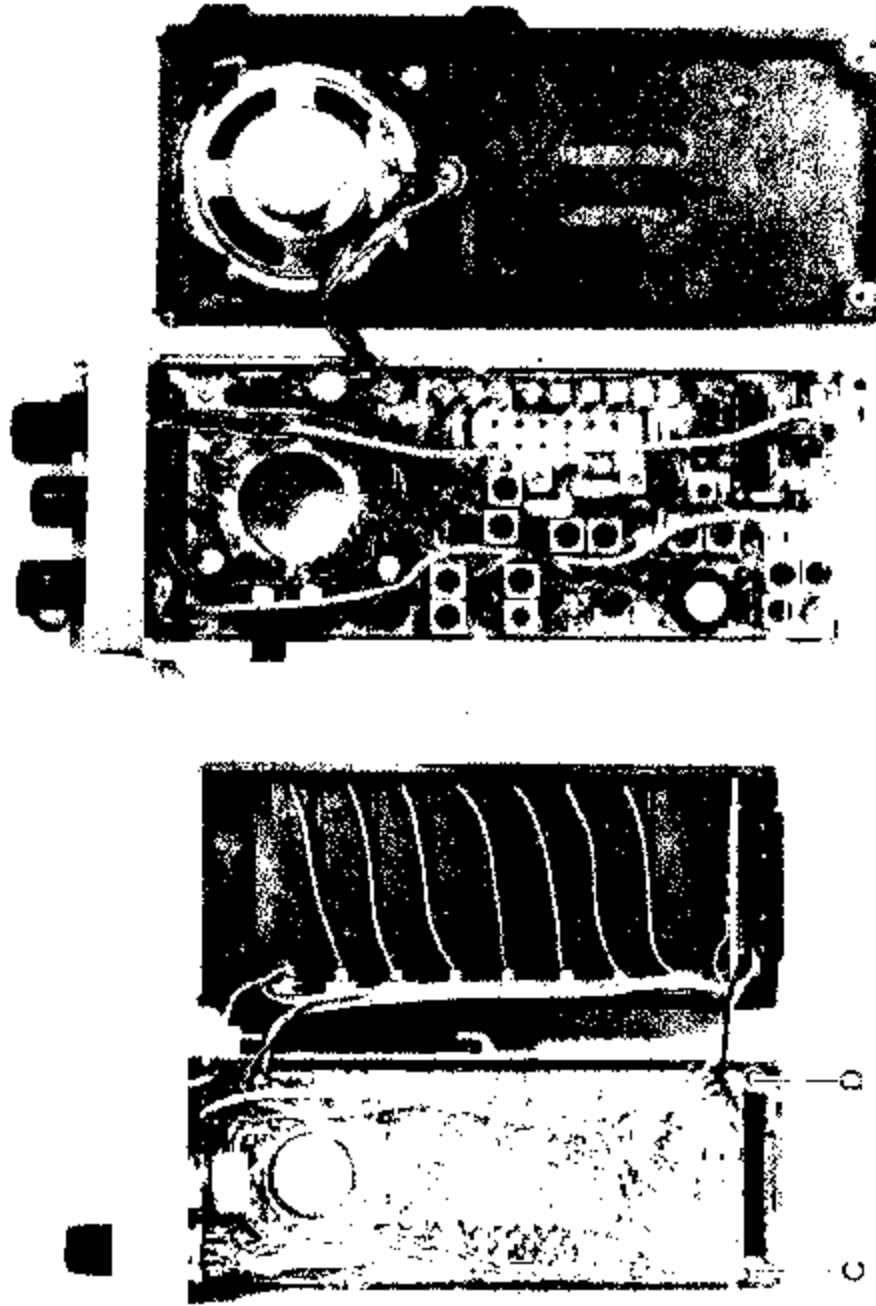

Fig. 2

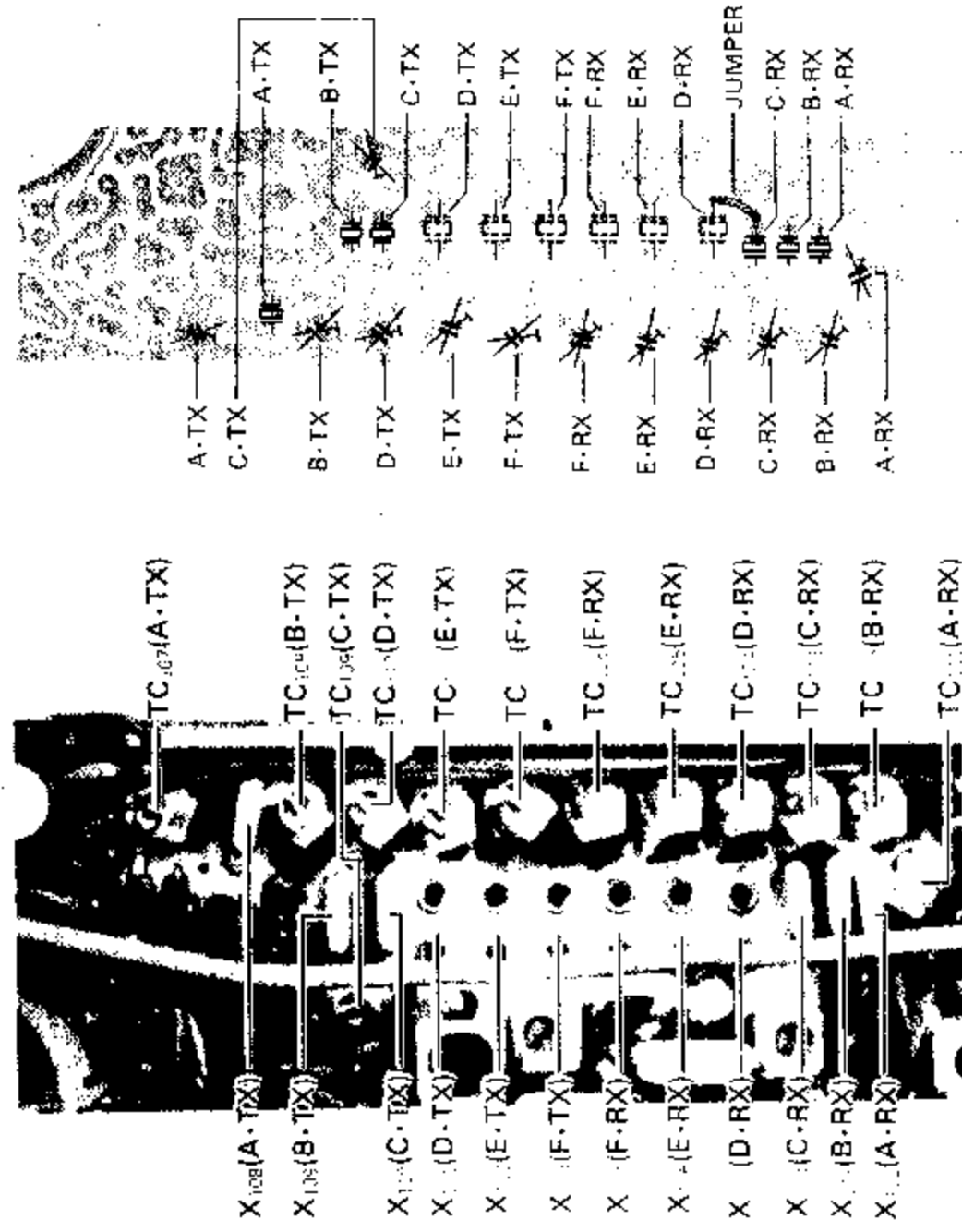

Fig. 3

The final step in channel installation is to zero the crystals on frequency, using the trimmer capacitors for each channel. Refer to the "Maintenance and Alignment" section for this step.

Replace the case carefully, and check to make sure that all channels are functioning properly.

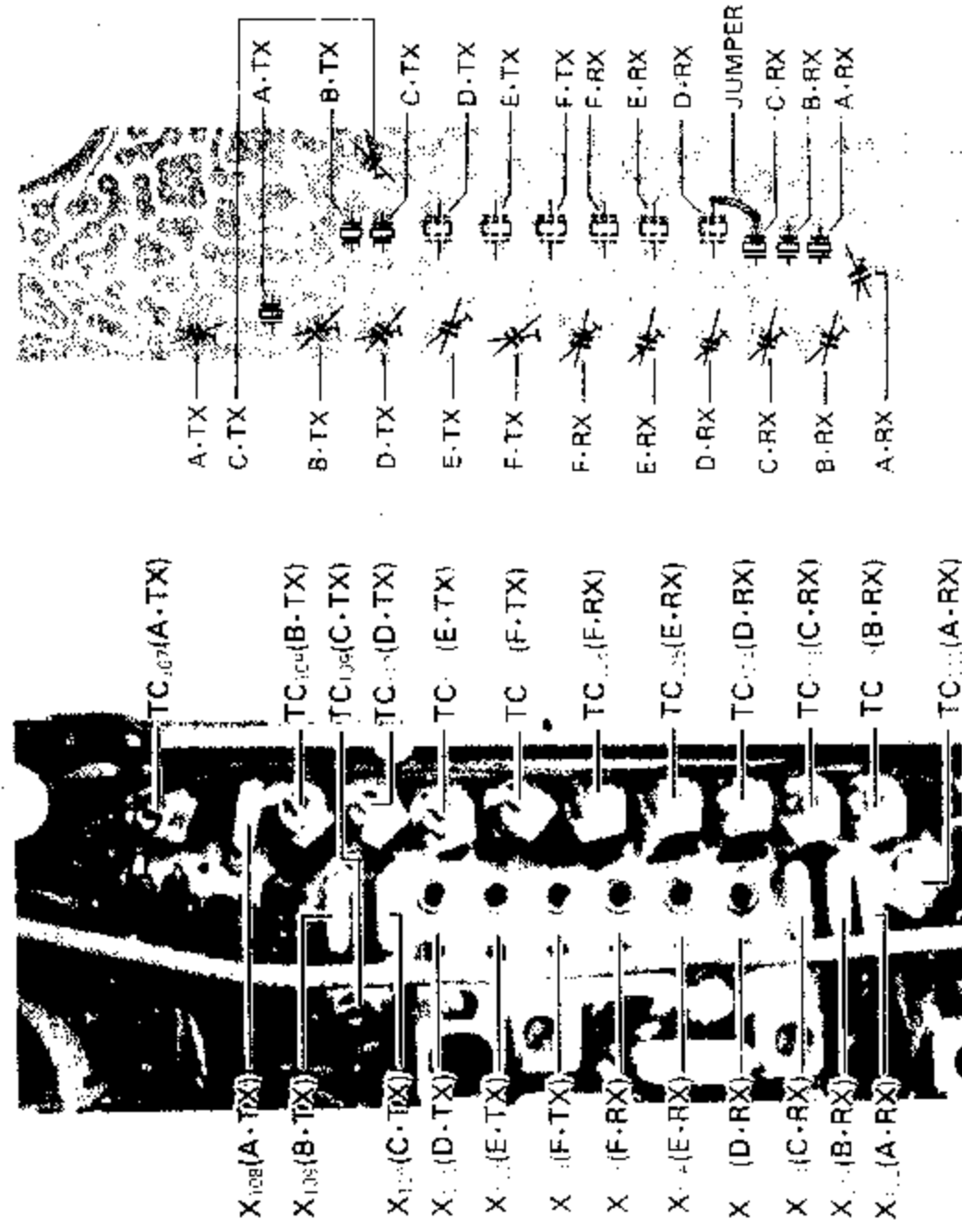

Fig. 4

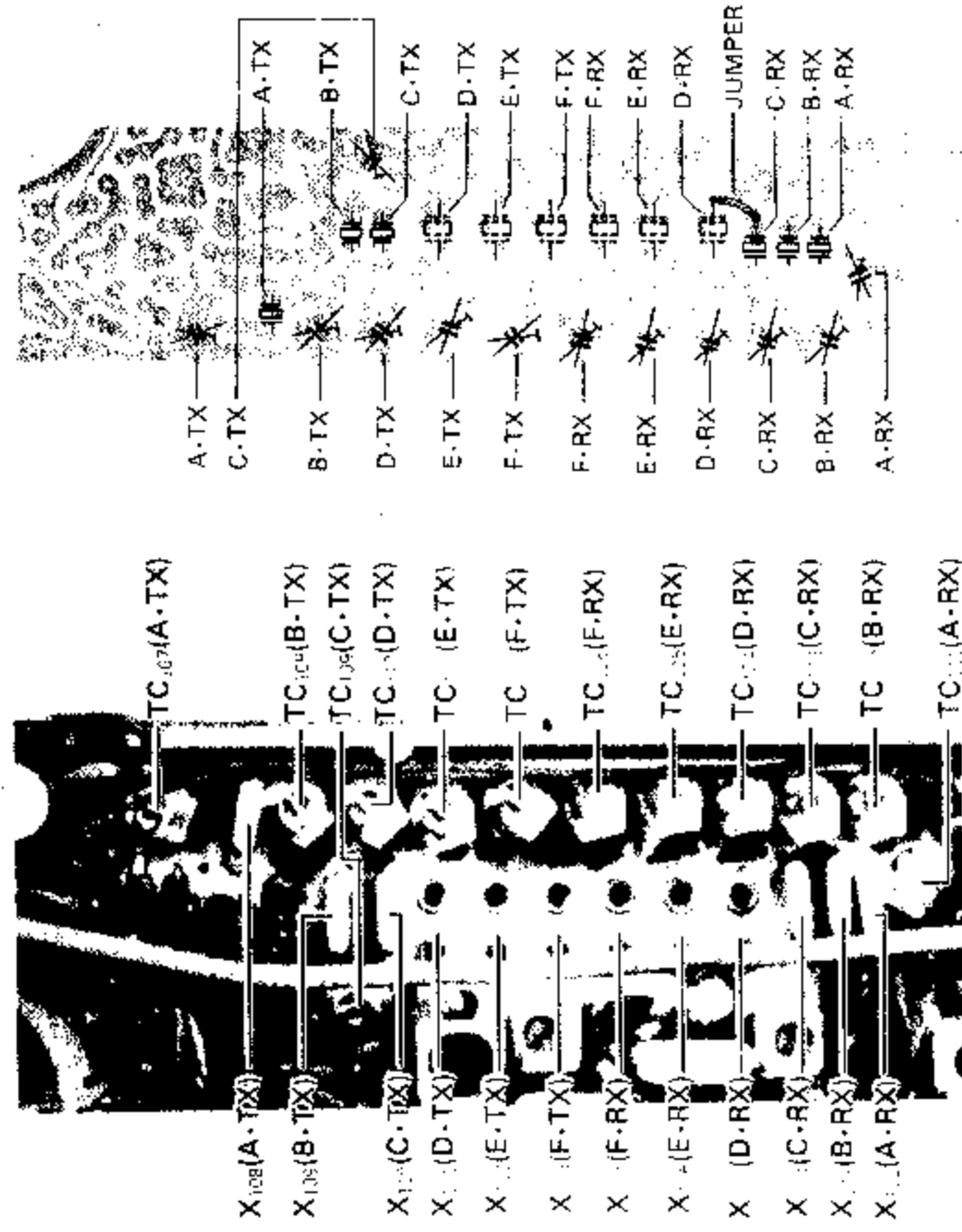

Fig. 5

## THEORY OF OPERATION

Reference to the block diagram will be of considerable help in clarifying the signal path and identifying the functions of the various stages.

The FT-202R utilizes a transmitter strip and a double-conversion receiver strip. The FT-202R is designed for operation from internal dry cell or NiCd batteries.

## RECEIVER

The signal from the antenna is fed through a low-pass filter consisting of  $C_{216}$ ,  $L_{112}$ , and  $C_{215}$ , and diode switch  $D_{101}$  (M1301) to the FET RF amplifier  $Q_{101}$  (3SK51). The amplified 144 - 148 MHz signal is then heterodyned with the local oscillator signal from  $Q_{104}$  (2SC1923) in the mixer  $Q_{102}$  (JF1033), producing a 10.7 MHz first IF signal. The IF signal is passed through crystal filters  $XF_{101}$  and  $XF_{102}$ , which have a 6 dB bandwidth of  $\pm 7.5$  kHz, and fed to IF amplifier  $Q_{103}$  (2SC1923).

The filtered IF signal appears at pin 16 of  $Q_{105}$  (MC3357). Crystal  $X_{101}$  provides a 10.245 MHz oscillation for the second local oscillator, located in  $Q_{105}$ ; this 10.245 MHz signal is heterodyned with the 10.7 MHz first IF signal, producing a 455 kHz second IF which exits  $Q_{105}$  at pin 3. The 455 kHz signal is passed through a ceramic filter,  $CF_{101}$ , which has a 6 dB bandwidth of  $\pm 5.5$  kHz, and fed to second IF amplifier  $Q_{107}$  (2SC1311). The ceramic filter prevents image responses from degrading receiver performance and establishes the working bandwidth for following stages. A portion of the signal

delivered from  $Q_{107}$  is detected by  $D_{104}$  and  $D_{105}$  (both 1S1555) and amplified by  $Q_{108}$  (2SC1311) and passed to the meter for an indication of signal strength.

The second IF signal is passed to pin 5 of  $Q_{105}$  for delivery to the limiter amplifier and discriminator sections of  $Q_{105}$ . The discriminator produces an audio output in response to a corresponding shift in the 455 kHz IF signal.

When no carrier is present in the 455 kHz IF, the high frequency noise at the discriminator output, which is passed through a bandpass filter, is amplified by the noise amplifier in  $Q_{105}$ , detected by  $D_{103}$  (1S1555), and hence a DC voltage is produced. This voltage activates a switch in  $Q_{105}$  which grounds the base of  $Q_{106}$  (MC1306), the audio power amplifier. When a carrier is present in the 455 kHz IF, the noise is removed from the discriminator; the audio amplifier then returns to normal operation.  $VR_1$  sets the squelch threshold sensitivity.

The unswitched audio output from the discriminator is amplified by  $Q_{106}$ , which delivers 500 mW of audio to the speaker.  $VR_2$  is the main volume control for the receiver.

## TRANSMITTER

The transmitter produces a frequency modulated signal. The audio signal from the microphone is amplified by  $Q_{116}$  and  $Q_{117}$  (both 2SC1311) and passed to the instantaneous deviation control (IDC), where both positive and negative peaks are clipped by diodes  $D_{109}$  and  $D_{110}$  (both 1S1555). The output from the IDC is passed to  $VR_{102}$ , which sets the in-

put level for microphone amplifier Q<sub>113</sub> (2SA13). The amplified signal is then passed to the modulator.

A 12 MHz fundamental signal is generated by Q<sub>109</sub> (2SC1311). The exact crystal frequency is determined by

$$\text{Crystal Frequency (MHz)} = \frac{\text{Output Frequency (MHz)}}{12}$$

Trimmer capacitors TC<sub>107</sub> - TC<sub>112</sub> permit each of the individual crystals to be set precisely to the desired frequency. The 12 MHz signal is modulated at Q<sub>110</sub> (2SC1923), where a reactance variation is produced in accordance with the speech input from Q<sub>118</sub>. The output modulation is of a low level, allowing multiplication by a factor of 12 to achieve the final output frequency.

Frequency multipliers Q<sub>111</sub>, Q<sub>112</sub>, and Q<sub>113</sub> (all 2SC710) multiply the frequency to 144 MHz for application to the driver transistor, Q<sub>119</sub> (2SC2053). The output from Q<sub>119</sub> is fed to the final amplifier, Q<sub>120</sub> (2SC730), whose output is passed through the low-pass filter to the antenna.

## CONTROL CIRCUITRY

The PTT switch, in the receive position, causes Q<sub>114</sub> (2SC1209) to conduct, providing V<sub>cc</sub> to be applied to the receiver section. In the TX position of the PTT switch, Q<sub>115</sub> (2SA695D) conducts to apply V<sub>cc</sub> to the transmitter section, while D<sub>107</sub> causes the base of Q<sub>114</sub> to be grounded, thus disabling the receiver.

The microphone is grounded when the PTT switch is released. When an external microphone is used, the internal microphone is not usable.

When the PTT switch is closed, D<sub>106</sub> (1S1555) conducts, placing TX V<sub>cc</sub> at the meter, thus allowing a monitoring of the battery condition.

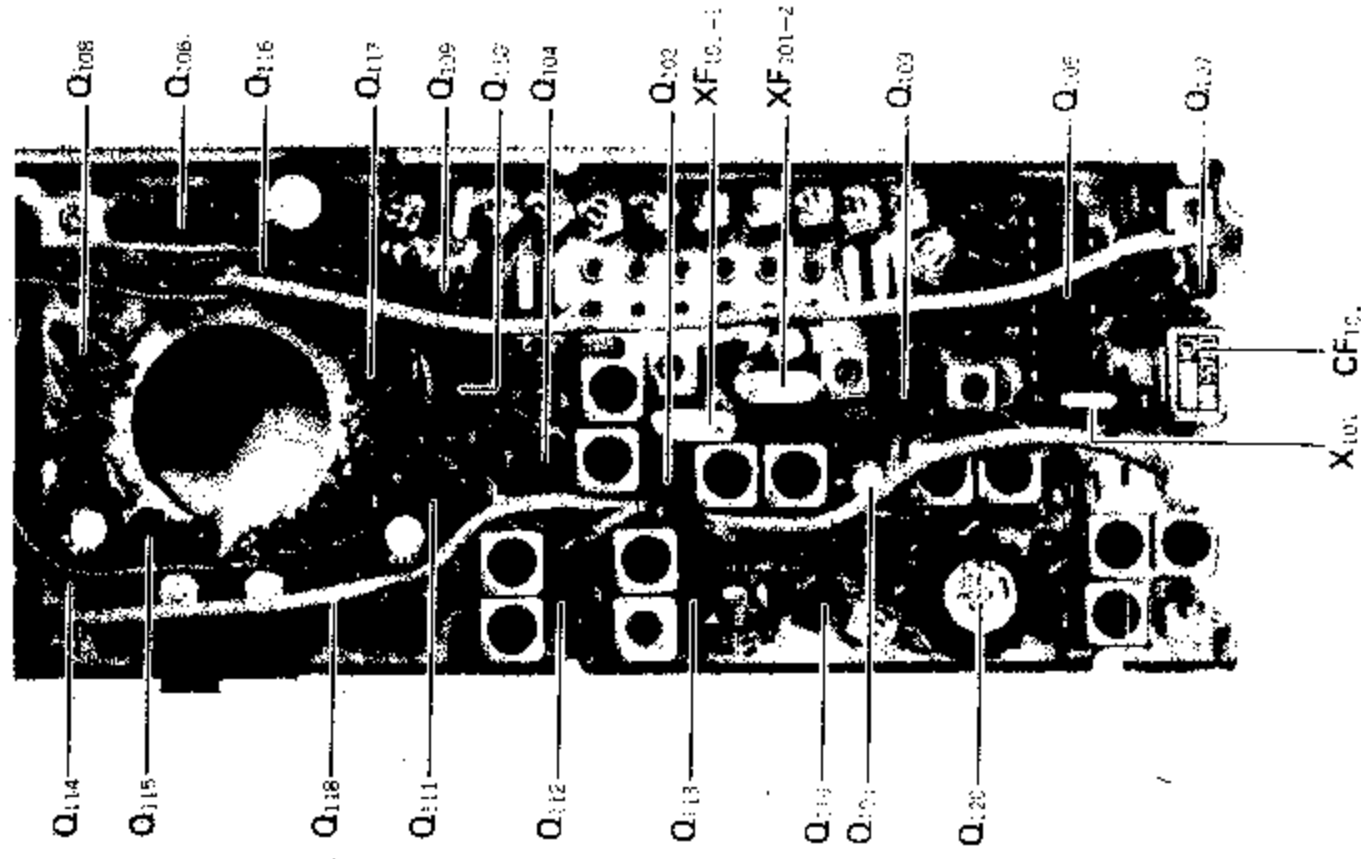



## MAINTENANCE AND ALIGNMENT

The FT-202R has been carefully aligned and tested at the factory prior to shipment. The solid state devices used in the FT-202R should provide many years of trouble-free service, if the transceiver is not abused and if routine maintenance is carried out.

Periodic cleaning of the interior of the transceiver may be required if the unit is used in a dusty environment. A vacuum cleaner may be used to remove loose dirt, while a small brush will help in dislodging caked dirt. The exterior may be wiped with a damp cloth as needed.

Should reduced power output or degraded receiver sensitivity indicate the need for alignment, we recommend that the transceiver be returned to your dealer, as the test equipment and expertise required to align the FT-202R can be obtained there. Any attempt to align this transceiver without the proper equipment may result in degraded performance.

### RECEIVER ALIGNMENT

#### (1) TX Local Oscillator

Connect the RF probe of a VTVM to the source of  $Q_{102}$ . Adjust the cores of  $T_{108}$  and  $T_{109}$  for a maximum indication on the VTVM.

#### (2) Receive Channel Alignment

Connect a frequency counter to the emitter of  $Q_{104}$  through a 10 pF capacitor. Adjust  $TC_{101}$  -  $TC_{106}$  for the precise frequency desired of channels 1 - 6, respectively.

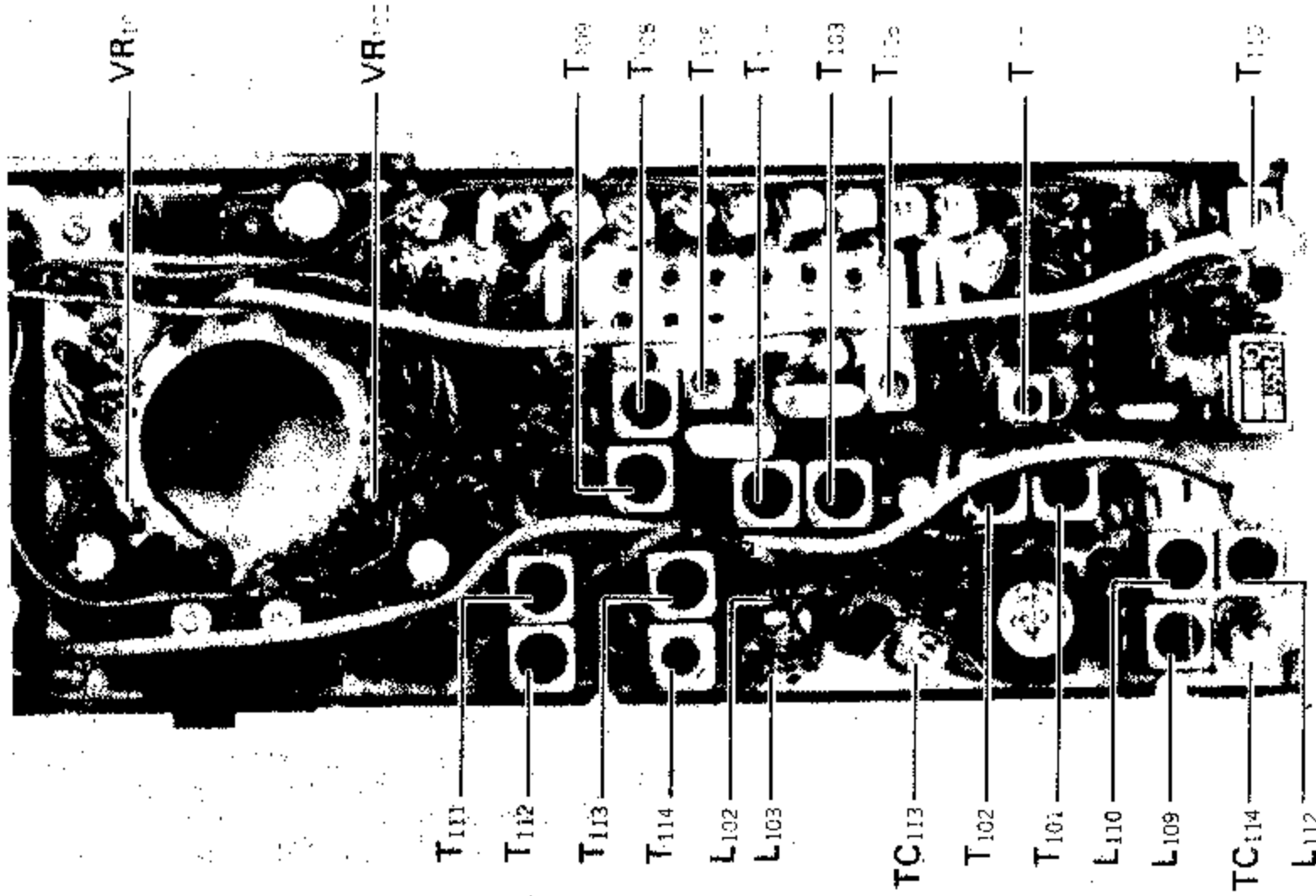

The correct crystal frequency is determined from

$$\text{Crystal Frequency} = \frac{\text{Operating Frequency} \times 10.7}{9} \text{ MHz}$$

### (3) 10.7 MHz IF Transformer Alignment (I)

Connect a sweep generator with a center frequency of 10.7 MHz to the source of  $Q_{102}$ . Connect the diode detector of an oscilloscope to the emitter of  $Q_{107}$ . Adjust  $T_{105}$  and  $T_{106}$  until the pattern shown in Figure 6 is obtained.

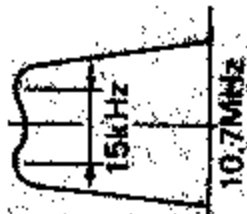

Fig. 6

### (4) RF Amplifier Resonator

Connect a signal generator capable of output at 147 MHz to the antenna jack. Tune its output to the channel nearest to 147 MHz, and tune  $T_{101}$  through  $T_{104}$  for a maximum S-meter reading.

### (5) Discriminator

Adjust  $T_{110}$  while listening to an FM station of known frequency accuracy (such as a repeater). Adjustment should be made to provide the most natural sounding voice on the received frequency.

### (6) 10.7 MHz IF Transformer Alignment (II)

Connect a signal generator capable of output at 147 MHz to the antenna jack. Tune its output to the channel nearest to 147 MHz, and adjust  $T_{107}$  for a maximum S-meter reading.

## TRANSMITTER ALIGNMENT

Connect a dummy load to the antenna receptacle.

### (1) Multiplier Stage Adjustment

- a) Connect a DC voltmeter to the emitter of  $Q_{112}$ . Adjust  $T_{111}$  and  $T_{112}$  for a maximum reading on the voltmeter while transmitting. A nominal value is 1V DC.
- b) Connect a DC voltmeter to the emitter of  $Q_{113}$ . Adjust  $T_{113}$  and  $T_{114}$  for a maximum reading on the voltmeter. A nominal reading is 1.5 V DC.
- c) Connect the RF probe of a VTVM to the base of  $Q_{119}$ . Compress or spread open slightly the turns of  $L_{102}$  and  $L_{103}$  to secure a maximum reading on the VTVM.

### (2) RF Output Peaking

Connect a dummy load/wattmeter to the antenna jack. Adjust  $TC_{113}$  and  $TC_{114}$  for a maximum reading on the wattmeter.

### (3) Deviation Adjustment

Connect a deviation meter to the antenna receptacle, and connect an audio signal generator to the microphone input terminal. Apply a 1 kHz 15 mV signal, and adjust  $VR_{102}$  for a  $\pm 4.7$  kHz deviation indication on the meter.

### (4) TX Frequency Adjustment

Connect a frequency counter through a 10 pF capacitor to the emitter of  $Q_{109}$ . Adjust  $TC_{109}$  -  $TC_{112}$  for a correct frequency reading on the counter.

The crystal frequencies should be determined from:

$$\text{Crystal Frequency} = \frac{\text{Operating Frequency}}{12} \text{ MHz}$$

If a precision VHF frequency counter is available, the frequency may be read directly by coupling loosely to the antenna or dummy load.

#### (5) Battery Check

Connect a DC voltmeter to the + battery terminal on the bottom of the transceiver. In the TX mode, adjust VR<sub>101</sub> so that the meter needle reads exactly at the dividing line between the red and blue areas of the meter scale, for a reading of 8 volts on the DC voltmeter.

#### STONE BURST SETTING

The tone burst length and level are preset at the factory. For setting of the tone frequency, proceed as follows:

Connect a dummy load to the antenna receptacle. Connect a frequency counter between the microphone lead and ground. Press the microphone PTT switch, and adjust VR<sub>301</sub> for a reading of 1800 Hz on the counter. If your local repeaters use a different burst frequency, adjust VR<sub>301</sub> accordingly.

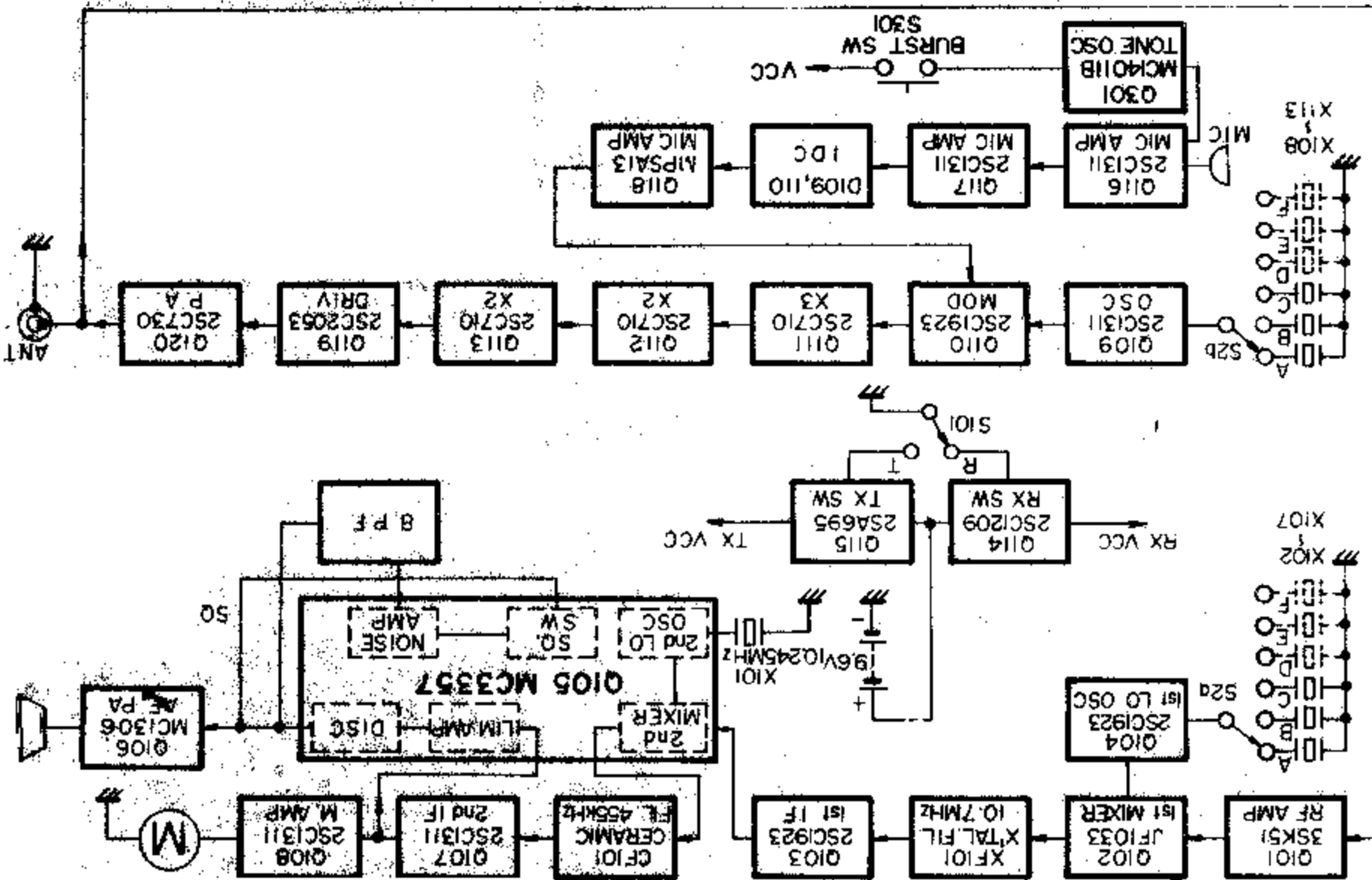

BLOCK DIAGRAM

Downloaded by    
Amateur Radio Directory

# CIRCUIT DIAGRAM

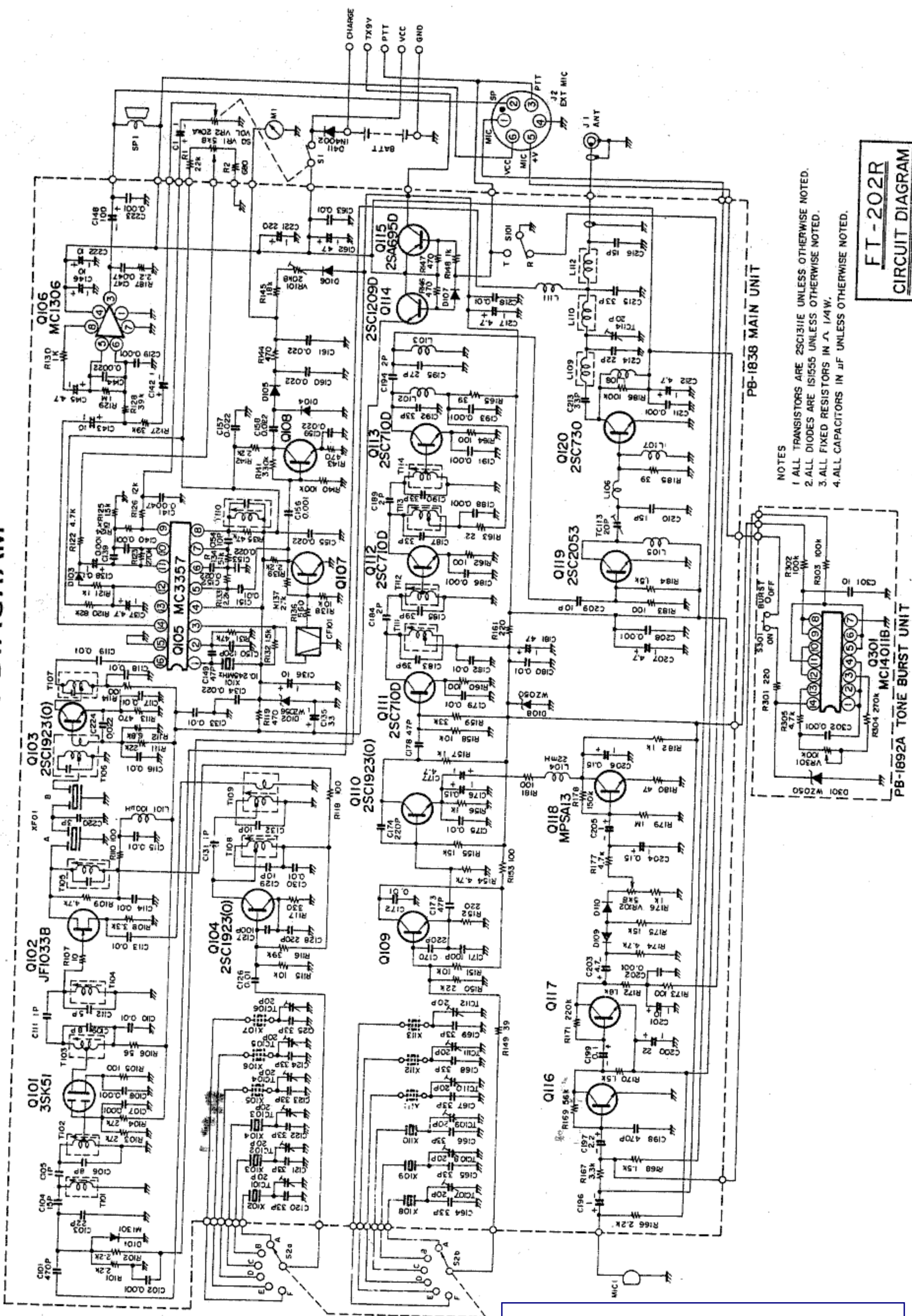

**FT-202R**  
CIRCUIT DIAGRAM

- NOTES
1. ALL TRANSISTORS ARE 2SC131E UNLESS OTHERWISE NOTED.
  2. ALL DIODES ARE 1S155S UNLESS OTHERWISE NOTED.
  3. ALL FIXED RESISTORS IN  $\Omega$  1/4W.
  4. ALL CAPACITORS IN  $\mu$ F UNLESS OTHERWISE NOTED.

Downloaded by   
  
Amateur Radio Directory