

YAESU

144 MHz BAND FM TRANSCEIVER

FT-2600M

OPERATING MANUAL

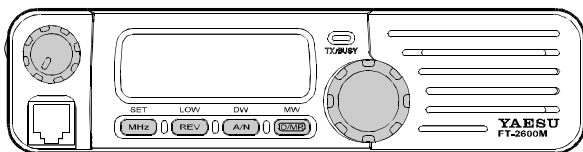

VERTEX STANDARD CO., LTD.

4-8-8 Nakameguro, Meguro-Ku, Tokyo 153-8644, Japan

VERTEX STANDARD

US Headquarters

17210 Edwards Rd., Cerritos, CA 90703, U.S.A.

International Division

8350 N.W. 52nd Terrace, Suite 201, Miami, FL 33166, U.S.A.

YAESU EUROPE B.V.

P.O. Box 75525, 1118 ZN Schiphol, The Netherlands

YAESU UK LTD.

Unit 12, Sun Valley Business Park, Winnall Close
Winchester, Hampshire, SO23 0LB, U.K.

VERTEX STANDARD HK LTD.

Unit 5, 20/F., Seaview Centre, 139-141 Hoi Bun Road,
Kwun Tong, Kowloon, Hong Kong

Contents

General Description	1	DCS Code Inversion	28
Specifications	2	CTCSS Bell Paging	29
Accessories & Options	3	DTMF Autodialer Operation	30
Front Panel Controls and Switches	4	Memory System Operation	32
Microphone Switches	6	Memory Storage	32
Rear Panel Connectors	7	To Append an Alpha-Numeric Label to a Memory:	32
Installation	8	Recalling Memories	33
Preliminary Inspection	8	Memory Recall from MH-36 ₆₆₁ Microphone	33
Installation Tips	8	To Turn on the Alpha-Numeric Memory Name Display:	33
Safety Information	8	Home Channel Memory	34
RF Field Exposure Information	9	Memory Offset Tuning	34
Antenna Considerations	9	Memory-Only Mode	35
Mobile Installation	11	Deleting Memories	35
Base Station Installation	13	Scanning	36
Operation	15	Basic Scanner Operation	36
Basic Operation/Reception	15	Scan-Resume Options	36
Power ON/OFF	15	Memory Skip Scanning (MR Mode)	37
Supply Voltage Display	15	Temporary Memory Skip	37
Adjusting the Volume and Squelch	15	Programmable Band-Scan Limits	38
Lock Feature	16	Smart Search Operation	39
Keypad Beeper	16	Priority Channel Monitoring	40
Display Brightness	17	Priority Revert Mode	41
Tuning: The “Dial” (VFO) Mode	17	ARTS™: Auto Range Transpond System	42
Channel Step Selection	17	ARTS Basic Operation	42
Direct Keypad Frequency Entry (MH-36 ₆₆₁ Microphone)	18	ARTS Modes	43
Transmission	19	CW ID (Morse Identifier) Set up	43
DTMF Keypad	19	Packet Operation	44
1750 Hz Tone Call	19	Miscellaneous Settings	45
Power Output Setting	20	Time-Out Timer	45
PTT Locking	20	Automatic Power-Off	45
Transmitter Thermal Protection Sensor	21	FM Bandwidth & Mic Gain Control	46
Repeater Operation	22	Programmable Microphone Keys (ACC/P1/P2)	47
Repeater Splits	22	Resetting the CPU	48
Tone Squelch Modes	25	Reset all MENU settings:	48
CTCSS (Continuous Tone Coded Squelch System)	25	CPU master reset for all memories and MENU settings:	48
DCS (Digital Code Squelch)	25	Transceiver Cloning	49
CTCSS/DCS Selections using Programmable Microphone Key... ..	27	Menu System	50
CTCSS Tone Search Scanning	27	Menu Selection Summary	50
DCS Tone Search Scanning	28	Menu Selection Details	51

General Description

The FT-2600M is a deluxe, compact FM mobile transceiver providing high power output and outstanding receiver performance for the 144 MHz band. Included in the FT-2600M's feature complement are:

- 60 Watts of power output, with selection of four power levels for every operating situation.
- Expanded receiver coverage: 134-174 MHz.
- Keyboard entry of operating frequencies from the microphone.
- Excellent protection from receiver intermodulation distortion, thanks to Yaesu's renowned Advanced Track Tuning front end.
- Outstanding packet radio capability at 1200 or 9600 bps with easy interface via a dedicated rear-panel jack.
- 175 memories which can store repeater shifts, odd repeater shifts, CTCSS/DCS tones, and 8-character Alpha-Numeric labels for easy channel recognition.
- Built-in CTCSS and DCS Encoder/Decoder circuits.
- The Smart Search™ feature, which automatically sweeps a band and loads active frequencies into dedicated memory banks, is ideal for identifying active repeaters when visiting a city for the first time.
- Yaesu's exclusive ARTS™ (Auto-Range Transponder System), which alerts the operator when an "out-of-range" condition exists with another ARTS™-equipped station. This feature is especially valuable during search-and-rescue operations with hand-held units.
- Extensive MENU system, which allows customization of a number of transceiver performance characteristics.
- The Yaesu-exclusive multi-function LCD display.

Additional features include a transmit Time-Out-Timer (TOT), Automatic Power-Off (APO), Automatic Repeater Shift (ARS), plus provision for reduction of the Tx deviation in areas of high channel congestion. And an all-new S-Meter Squelch circuit allows the owner to set the squelch to open at a programmable setting of the S-Meter, thus reducing guesswork in setting the squelch threshold.

Congratulations on your purchase of the FT-2600M! Whether this is your first rig, or if Yaesu equipment is already the backbone of your station, the Yaesu organization is committed to ensuring your enjoyment of this high-performance transceiver, which should provide you with many years of satisfying operation. Yaesu's dealer network and technical support personnel stand behind every product we sell, and we invite you to contact us should you require technical advice or assistance.

We recommend that you read this manual in its entirety prior to installing the FT-2600M, so that you fully understand the capabilities of your new transceiver.

Specifications

General

Frequency Range:	Tx: 144-146 or 144-148 MHz Rx: 144-146 MHz or 134-174 MHz
Channel Steps:	5/10/12.5/15/20/25/50 kHz
Frequency Stability:	Better than ± 10 ppm (-20° to $+60^{\circ}$ C)
Mode of Emission:	F3 (G3E)
Antenna Impedance:	50 Ω , unbalanced
Supply voltage:	13.8 V DC (± 10 %), negative ground
Current Consumption(typical):	Rx: less than 1 A (max. signal) less than 0.4 A (squelched) Tx: 10 A (60 W)/ 6 A (25 W)/4 A (10 W)/3 A (5 W)
Operating Temperature Range:	-20° to $+60^{\circ}$ C (-4° to $+140^{\circ}$ F)
Case Size (WHD):	160 x 40 x 160 mm (6.3" x 1.6" x 6.3") (W/o knobs/connectors)
Weight:	1.3 kg (2.9 lb.)

Transmitter

Output Power:	60W/25W/10W/5W
Modulation Type:	Variable Reactance
Maximum Deviation:	± 5 kHz / ± 2.5 kHz
Spurious Radiation:	Better than -60 dB
Microphone Impedance:	2 k Ω

Receiver

Circuit Type:	Double-Conversion Superheterodyne
Intermediate Frequencies:	21.7 MHz & 450 kHz
Sensitivity (for 12dB SINAD):	Better than 0.2 μ V @ 15 kHz bandwidth
Selectivity (-6/-60dB):	12 / 30 kHz or 10/24 kHz
IF Rejection:	Better than 70 dB
Image Rejection:	Better than 70 dB
Maximum AF Output:	3.5 W into 4 Ω @10 % THD

Specifications subject to change without notice or obligation.

Specifications guaranteed only within the amateur band.

Frequency range and repeater shift may vary according to local requirements and regulations.

Accessories & Options

ACCESSORIES SUPPLIED WITH FT-2600M

Microphone (see list below)

MMB-73 Mobile Mounting Bracket

DC Power Cord w/Fuse (Part # T9021715)

Spare 15 A Fuse (Part # Q0000081)

OPTIONAL ACCESSORIES

Hand Mic	MH-42_{B6J}
(or)	
DTMF Keypad Mic	MH-36_{B6J}
External Loudspeaker	SP-7
High-Power External Speaker	MLS-100
Compact Power Supply (23 A)	FP-1023A (U.S.A. only)
External AC Power Supply (30 A)	FP-1030A

Availability of accessories may vary. Some accessories are supplied as standard per local requirements, while others may be unavailable in some regions. Consult your Yaesu dealer for details regarding these and any newly-available options. Connection of any non-Yaesu-approved accessory, should it cause damage, may void the Limited Warranty on this apparatus.

Front Panel Controls and Switches

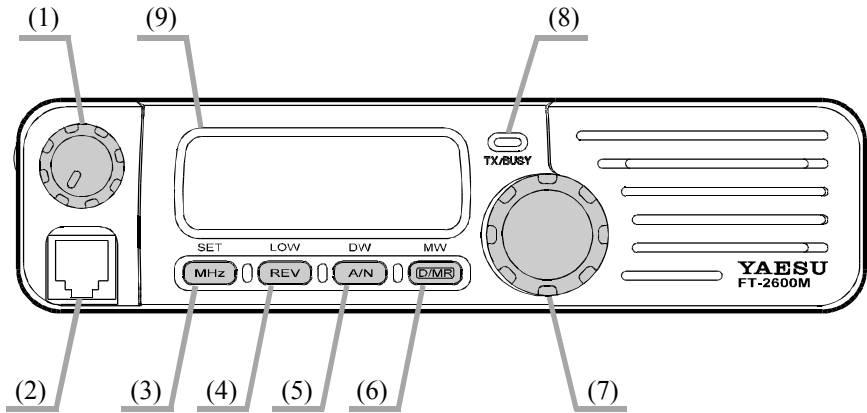

(1) **Power / VOL** Knob

Turn this control clockwise to turn the radio on and to increase the volume. Counterclockwise rotation into the click-stop will turn the radio off.

(2) **Microphone** Jack

This 6-contact modular jack accepts transmit audio, tone call (burst) or Dial / Memory selection, and Scanning control from the microphone.

Pin 1: Sw 2 (Multi-function switching)

Pin 2: Cloning

Pin 3: +9V

Pin 4: GND

Pin 5: Microphone Input

Pin 6: Sw 1 (Multi-function switching)

(3) **MHz (SET)** Key

This button allows tuning in 1-MHz steps (the MHz digits will blink on the display). If receiving on a memory, pressing this button the first time activates the Memory Tune (MT) mode, and pressing it again enables 1-MHz steps.

Press and hold this key for one second to activate the “Set” (MENU) Mode.

(4) **REV (LOW)** Key

During split-frequency operation, such as through a repeater, this button reverses the transmit and receive frequencies.

Press and hold this key for one second to change the transmitter power output level.

The available power levels are:

HIGH (60W) ⇒ **Low1** (25W) ⇒ **Low2** (10W) ⇒ **Low3** (5W) ⇒ **HIGH** (60W). . .

Front Panel Controls and Switches

(5) A/N (DW) Key

While receiving on a memory, pressing this button toggles the display between indication of the frequency and the channel's Alpha/Numeric label.

Press and hold this key for one second to activate the **Dual Watch** feature, described in the Operation chapter ("PRI" will be displayed on the LCD, indicating "Priority Channel" monitoring).

(6) D/MR (MW) Key

This button switches operation between the two main tuning modes: **Dial** and **Memory Recall**.

Press and hold this key for one second to activate the Memory Storage mode.

(7) Main Dial Knob

This 20-position detented rotary switch is used for tuning, memory selection and most function settings. Note that the microphone's **UP/DWN** buttons duplicate the tuning functions of the **Main Dial**.

(8) BUSY/TX Indicator

This lamp glows green (during reception) when the channel is busy, and red during transmission.

(9) Display

The main digits on the display may show operating frequency, memory name, and/or a number of parameters during MENU configuration.

Continuous Tone Coded Squelch System

Digital Code Squelch

Priority Channel

Repeater Shift Direction

Frequency / Message Area

S - and Tx Power Meter

Automatic Range Transponder System

SCAN Active

SKIP Active

LOW Power Selected

Bell Alarm Active

Key Lock Active

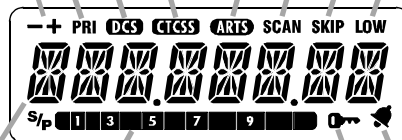

Microphone Switches (MH-36_{B6J})

(10) PTT Switch

Press this switch to transmit, and release it to receive.

(11) KEYPAD

The desired operating frequency may be entered directly from the keypad.

(12) DWN Button

Press this button momentarily to tune downward by one synthesizer step. Hold this button in for one second to start scanning.

(13) UP Button

Press this button momentarily to tune upward by one synthesizer step. Hold this button in for one second to start scanning.

(14) LOCK Switch

Slide this switch upward to lock the microphone's buttons.

(15) LAMP Switch

Slide this switch upward to activate the back-lighting for the microphone's keys.

(16) ACC Button (TSRCH)

This is one of three programmable-function keys (**ACC**, **P1**, and **P2**) which may be used for control of operating functions. The configuration of this key is programmed via the MENU, and the default function is "Tone Search."

(17) P Button (D/MR)

This key allows selection of the **Dial**, **Home Channel**, or **Memory Recall** tuning methods.

(18) P1 Button (SQL OFF)

The default function for this key is "Monitor" (**Squelch Off**).

(19) P2 Button (SSRCH)

The default function for this key is activation of the Smart Search™ feature.

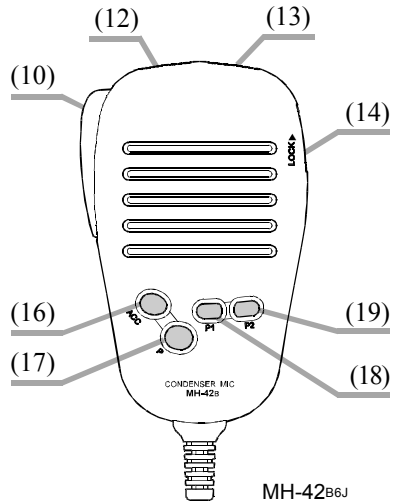
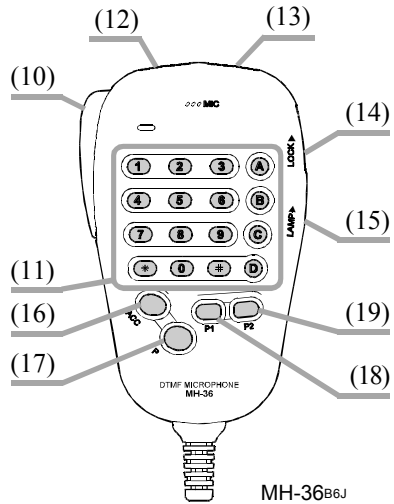

Note: DTMF keys may not be available on some transceiver versions. Microphone appearance may differ slightly from that shown in the drawing.

Rear Panel Connectors

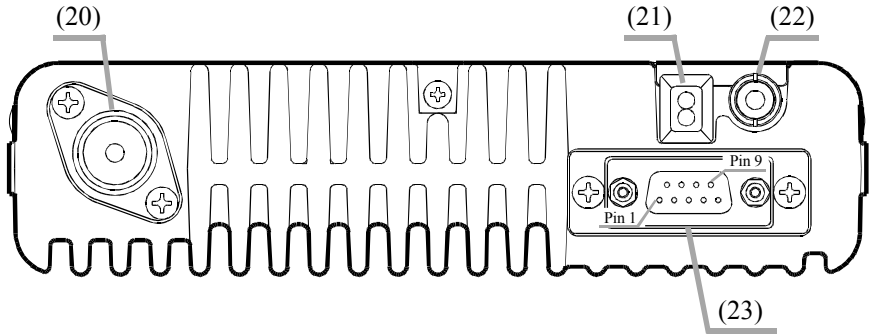

(20) ANT Coaxial Socket

Connect a resonant 144-MHz antenna to this type-M (SO-239) socket using 50-Ω coaxial cable and a type-M (PL-259) plug.

(21) 13.8V DC Cable Pigtail w/Fuse

This is the power supply connection for the transceiver. Use the supplied DC cable to connect this pigtail to the car battery or other DC power supply capable of at least 10 Amperes (continuous duty). Make certain that the red lead connects to the positive side of the supply. The fuse in the DC Cable is rated at 15-A, fast-blow.

(22) EXP SP Jack

This 2-contact 3.5-mm phone jack provides receiver audio output for an optional external speaker. The audio impedance is 4 Ohms, and the level varies according to the setting of the front panel's **VOL** control. Inserting a plug into this jack disables audio from the transceiver's internal speaker.

(23) DSUB 9-Pin Data Connector

External Transmit Audio input, PTT (**P**ush **T**o **T**alk), Squelch, and Receive Audio output signals may be obtained from this connector for use with accessories such as a data transmission/reception modem, etc.

Pin	Label	Notes
1	Squelch Signal Output	Carrier In: Closed (Open Collector) Maximum voltage 16 V, Max. sink current 10 mA
2	Packet Rx Data Output (9600 bps)	Typ. output level 600 mV/10 kΩ
3	Packet Tx Data Input (9600 bps)	Typ. input level 800 mV/600 Ω, Max. input 1.2 V
4	Packet Rx Data Output (1200 bps)	Typ. output level 200 mV/600 Ω
5	Ground	—
6	Not Used	—
7	External PTT Signal Input	GND: TX, Open: RX
8	DC Output	Switched and regulated DC 5.0 V output for supplying power to an accessory. Maximum output current is 50 mA
9	Packet Tx Data Input (1200 bps)	Typ. input level 40 mV/600 Ω

Installation

This chapter describes the installation procedure for integrating the FT-2600M into a typical amateur radio station. It is presumed that you possess technical knowledge and conceptual understanding consistent with your status as a licensed radio amateur. Please take some extra time to make certain that the important safety and technical requirements detailed in this chapter are followed closely.

PRELIMINARY INSPECTION

Inspect the transceiver visually immediately upon opening the packing carton. Confirm that all controls and switches work freely, and inspect the cabinet for any damage. Gently shake the transceiver to verify that no internal components have been shaken loose due to rough handling during shipping.

If any evidence of damage is discovered, document it thoroughly and contact the shipping company (or your local dealer, if the unit was purchased over-the-counter) so as to get instructions regarding the prompt resolution of the damage situation. Be certain to save the shipping carton, especially if there are any punctures or other evidence of damage incurred during shipping; if it is necessary to return the unit for service or replacement, use the original packing materials but put the entire package inside another packing carton, so as to preserve the evidence of shipping damage for insurance purposes.

INSTALLATION TIPS

To ensure long life of the components, be certain to provide adequate ventilation around the cabinet of the FT-2600M.

Do not install the transceiver on top of another heat-generating device (such as a power supply or amplifier), and do not place equipment, books, or papers on top of the FT-2600M. Avoid heating vents and window locations that could expose the transceiver to excessive direct sunlight, especially in hot climates. The FT-2600M should not be used in an environment where the ambient temperature exceeds +60° C (140° F).

SAFETY INFORMATION

The FT-2600M is an electrical apparatus, as well as a generator of RF (Radio Frequency) energy, and you should exercise all safety precautions as are appropriate for this type of device. These safety tips apply to *any* device installed in a well-designed amateur radio station.

- Do not allow unsupervised children to play in the vicinity of your transceiver or antenna installation.
 - Be certain to wrap any wire or cable splices thoroughly with insulating electrical tape, to prevent short circuits.
-

- ❑ Do not route cables or wires through door jambs or other locations where, through wear and tear, they may become frayed and shorted to ground or to each other.
- ❑ Do not stand in front of a directional antenna while you are transmitting into that antenna. Do not install a directional antenna in any location where humans or pets may be walking in the main directional lobe of the antenna's radiation pattern.
- ❑ In mobile installations, it is preferable to mount your antenna on top of the roof of the vehicle, if feasible, so as to utilize the car body as a counterpoise for the antenna and raise the radiation pattern as far away from passengers as possible.
- ❑ During vehicular operation when stopped (in a parking lot, for example), make it a practice to switch to Low power if there are people walking nearby.
- ❑ *Never* wear dual-earmuff headphones while driving a vehicle.

RF FIELD EXPOSURE INFORMATION

This transceiver is capable of power output in excess of 50 Watts, so customers in the United States *may* be required to demonstrate compliance with Federal Communications Commission (FCC) regulations concerning maximum permissible exposure to radio frequency energy. Compliance is based on the actual power output used, feedline loss, antenna type and height, and other factors which can only be evaluated as a system.

Information regarding these regulations may be available from your Dealer, your local radio club, from the FCC directly (press releases and other information can be found on the FCC's site on the World Wide Web at <<http://www.fcc.gov>>), or from the American Radio Relay League, Inc. (225 Main St., Newington CT 06111 or <<http://www.arrl.org>>).

ANTENNA CONSIDERATIONS

The FT-2600M is designed for use with antennas presenting an impedance of near 50 Ω at all operating frequencies. The antenna (or a 50 Ω dummy load) should be connected whenever the transceiver is turned on, to avoid damage that could otherwise result if transmission occurs accidentally without an antenna.

Ensure that your antenna is designed to handle 60 Watts of transmitter power. Some magnetic-mount mobile antennas, designed for use with hand-held transceivers, may not be capable of this power level. Consult the antenna manufacturer's specification sheet for details.

Most all FM work is performed using vertical polarization. When installing a directional antenna such as a Yagi or Quad, be certain to orient it so as to produce vertical polarization, unless you are engaged in a special operating situation where horizontal polarization is used.

Installation

Note that this transceiver is designed with wide frequency coverage in the VHF spectrum. For general listening, you may wish to have a broadband antenna such as a discone available, as a directional antenna such as a Yagi will have degraded performance outside the 2-meter Amateur band.

Excellent reference texts and computer software are available for the design and optimization of VHF antennas. Your dealer should be able to assist you with all aspects of your antenna installation requirements.

Use high-quality 50 Ω coaxial cable for the lead-in to your FT-2600M transceiver. All efforts at providing an efficient antenna system will be wasted if poor quality, lossy coaxial cable is used. Losses in coaxial lines increase as the frequency increases, so an 8-meter-long (25') coaxial line with 0.75 dB of loss at 28 MHz may have a loss of 1.8 dB or more at 146 MHz; choose your coaxial cable carefully based on the installation location (mobile vs. base) and the overall length of the cable required (for *very short* runs of cable in a mobile installation, the smaller, more flexible cable types may be acceptable).

For reference, the chart below shows approximate loss figures for typically-available coaxial cables frequently used in VHF installations.

Loss in dB per 30 m (100 feet) for Selected 50 Ω Coaxial Cables (Assumes 50 Ω Input/Output Terminations)

Cable Type	Loss: 144 MHz
RG-58A	6.5
RG-58 Foam	4.7
RG-8A, RG-213	3.0
RG-8 Foam	2.0
Belden® 9913	1.5
1/2" "Hardline"	1.0
7/8" "Hardline"	0.7

Loss figures are approximate; consult cable manufacturers' catalogs for complete specifications.

In outdoor installations, be certain to weatherproof all connectors thoroughly, as water entering a coaxial cable will cause losses to escalate rapidly, thus diminishing your communications effectiveness. The use of the shortest possible length of the highest quality coaxial cable that fits within your budget will ensure the best performance from your FT-2600M.

MOBILE INSTALLATION

The FT-2600M must only be installed in vehicles having a *negative ground* electrical system. Mount the transceiver where the display, controls, and microphone are easily accessible, using the supplied MMB-73 mounting bracket. The transceiver may be installed in any position, but should not be positioned near a heating vent nor anywhere where it might interfere with driving (either visually or mechanically). Make sure to provide plenty of space at the rear of the transceiver so that air can flow freely through the heatsink. Refer to the diagrams showing proper installation procedures.

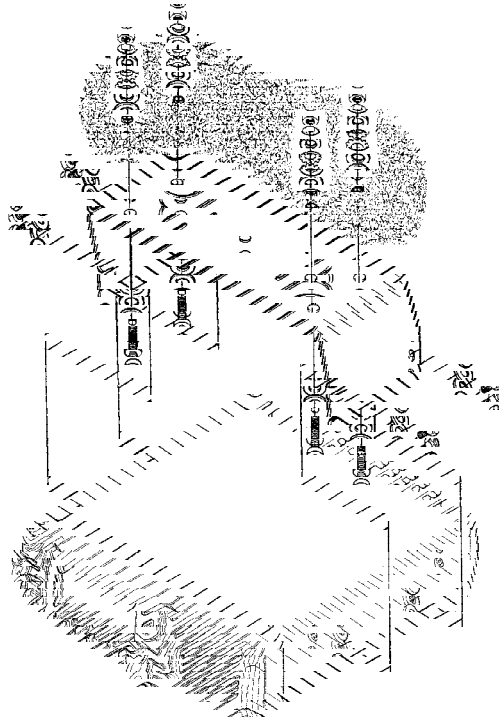

Transceiver Installation

- ❑ Choose a mounting location with sufficient clearance for the transceiver, plus space for ventilation around the heat sink. Using the mounting bracket as a template for the mounting holes, use a 4.8 mm (3/16") bit to drill the mounting holes, and secure the mounting bracket with the supplied screws, washers, and nuts (see diagram).
- ❑ Position the transceiver in the bracket so that the holes in the side are aligned with those in the bracket, and bolt the transceiver into place using the supplied short screws and flat washers.

Installation

Mobile Power Connections

To minimize voltage drop and avoid blowing the vehicle's fuses, connect the supplied DC power cable directly to the battery terminals. *Do not attempt to defeat or bypass the DC cable's fuse—it is there to protect you, your transceiver, and your vehicle's electrical system.*

Warning!

Never apply AC power to the power cable of the FT-2600M, nor DC voltage greater than 15.2 Volts. When replacing the fuse, only use a 15-A fast-blow type. Failure to observe these safety precautions will void the Limited Warranty on this product.

- ❑ Before connecting the transceiver, check the voltage at the battery terminals while revving the engine. If the voltage exceeds 15 Volts, adjust the vehicle's voltage regulator before proceeding with installation.
- ❑ Connect the **RED** power cable lead to the **POSITIVE (+)** battery terminal, and the **BLACK** power cable lead to the **NEGATIVE (-)** terminal. If you need to extend the power cable, use #12 AWG or larger insulated, stranded copper wire. Solder the splice connections carefully, and wrap the connections thoroughly with insulating electrical tape.
- ❑ Before connecting the cable to the transceiver, verify the voltage and polarity of the voltage *at the transceiver end of the DC cable* using a DC voltmeter. Now connect the transceiver to the DC cable.

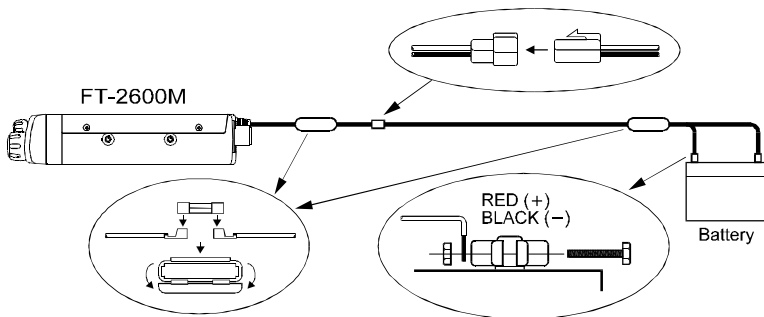

Mobile Speakers

The optional SP-7 External Speaker includes its own swivel-type mounting bracket, and is available from your Yaesu dealer.

Other external speakers may be used with the FT-2600M, if they present the specified 4- Ω impedance and are capable of handling the 3.5 Watts of audio output supplied by the FT-2600M.

BASE STATION INSTALLATION

The FT-2600M is ideal for base station use as well as in mobile installations. The FT-2600M is specifically designed to integrate into your station easily, using the information to follow as a reference.

AC Power Supplies

Operation of the FT-2600M from an AC line *requires* a power source capable of providing at least 10 Amps continuously at 13.8 Volts DC. The FP-1023A, FP-1025A, and FP-1030A AC Power Supplies are available from your Yaesu dealer to satisfy these requirements. Other well-regulated power supplies may be used, as well, if they meet the above voltage and current specifications.

Use the DC power cable supplied with your transceiver for making power connections to the power supply. Connect the **RED** power cable lead to the **POSITIVE (+)** power supply terminal, and connect the **BLACK** power cable lead to the **NEGATIVE (-)** power supply terminal.

Packet Radio Terminal Node Controller (TNC)

The FT-2600M provides a convenient rear-panel **DATA** jack for easy connections to your TNC. This connector is a standard Dsub 9-pin connector, widely available from electronics parts suppliers.

The FT-2600M's **DATA** jack connections are optimized for the data transmission and reception speed in use. In accordance with industry standards, the signal levels, impedances, and bandwidths are significantly different on 9600 bps as opposed to 1200 bps. If your TNC does not provide multiple lines to accommodate such optimization, you may still be able to utilize your TNC, if it is designed for multiple-radio use, by connecting the TNC "Radio 1" port to the 1200 bps lines on the FT-2600M, and the "Radio 2" port to the 9600 bps lines.

The pin connections of the **DATA** connector are shown below.

Pin	Label	Notes
1	Squelch Signal Output	Carrier In: Closed (Open Collector) Maximum voltage 16 V, Max. sink current 10 mA
2	Packet Rx Data Output (9600 bps)	Typ. output level 600 mV/10 k Ω
3	Packet Tx Data Input (9600 bps)	Typ. input level 800 mV/600 Ω , Max. input 1.2 V
4	Packet Rx Data Output (1200 bps)	Typ. output level 200 mV/600 Ω
5	Ground	—
6	Not Used	—
7	External PTT Signal Input	GND: TX, Open: RX
8	DC Output	Switched and regulated DC 5.0 V output for supplying power to an accessory. Maximum output current is 50 mA
9	Packet Tx Data Input (1200 bps)	Typ. input level 40 mV/600 Ω

Installation

Note that 9600 bps packet transmit-deviation adjustment is very critical to successful operation, and can only be accomplished using a calibrated deviation meter (such as that found on an FM Service Monitor used in a communications service center). In most cases, the Packet Data Input level (set via a potentiometer inside the TNC) must be adjusted to provide a deviation of ± 2.75 kHz (± 0.25 kHz). Check with your packet node's sysop if you have any questions about the appropriate deviation level for your network.

The setting of the 1200 bps Packet Data Input level is much less critical, and satisfactory adjustment to the optimum ($\pm 2.5 \sim \pm 3.5$ kHz) deviation can usually be done "by ear" by adjusting the TNC's 1200 bps TX Audio Level potentiometer so that the outgoing packets (as monitored on a separate VHF or UHF receiver) are approximately the same level as (A) the DTMF tones or (B) the 1750 Hz Burst tone produced by the MH-36_{B6J} or MH-42_{B6J} microphone.

Typical connections to a TNC are shown below.

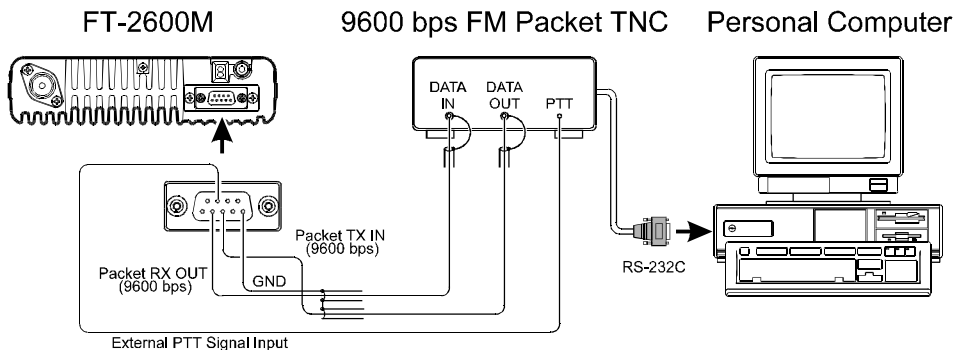
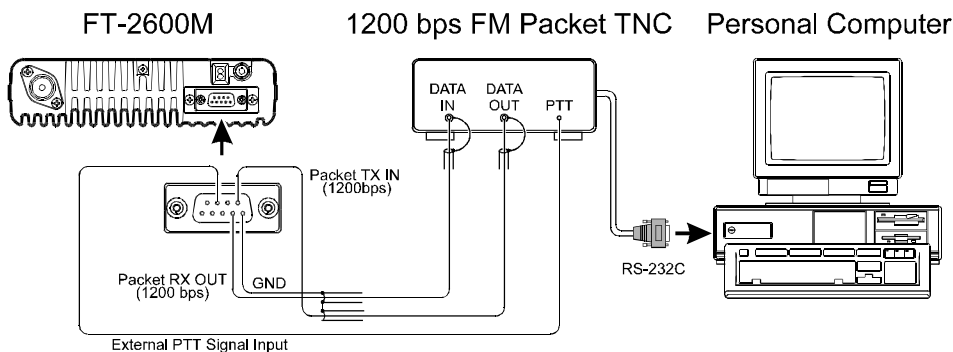

Finally, note that MENU #18 ("PKT") allows you to enable or disable the microphone during packet operation. Normally, the default setting ("Microphone Disabled during Packet TX") is appropriate; when the microprocessor detects PTT input from the Data connector, the microphone will be disabled.

BASIC OPERATION/RECEPTION

POWER ON/OFF

Turn the **Power / VOL** Knob clockwise to turn on the radio.

The start-up channel will be the same one on which you were operating when the radio was last turned off.

SUPPLY VOLTAGE DISPLAY

When you turn on the radio, the current DC supply voltage will be indicated on the display for one second. After this interval, the display will resume its normal indication of the operating frequency.

To view the supply voltage at any time during operation, use the following procedure:

- (1) Press and hold the **[MHz]** key for one second to activate the “Set” (MENU) mode, then rotate the **Main Dial** knob to select “**09 DC IN.**”
- (2) Press the **[MHz]** key momentarily to display the current DC supply voltage on the LCD.
- (3) Press and hold in the **[MHz]** key for one second to exit to normal operation.

ADJUSTING THE VOLUME AND SQUELCH

Rotate the **VOL** control to adjust the receiver volume. Clockwise rotation increases the audio output level.

The Squelch system is designed to keep the receiver quiet until a signal is received. The Squelch should be adjusted to the point where the background noise is just silenced; any “higher” setting will reduce the receiver’s sensitivity to weak signals.

To adjust the setting of the Squelch system:

- (1) Rotate the **Main Dial** to select a clear frequency (where no signals are present).
- (2) Press and hold in the **[MHz]** key for one second, then rotate the **Main Dial** knob to select “**28 SQL.**”
- (3) Press the **[MHz]** key momentarily, then rotate the **Main Dial** knob to select the squelch threshold level (**OFF**, or **1** to **15**). While you are making this adjustment, you will be able to hear the background noise appear when the Squelch setting is too low. The best sensitivity will be realized when the Squelch is set to one number past the point where noise is muted.
- (4) Press and hold in the **[MHz]** key for one second to save the new setting and exit to normal operation.

A special “RF SQUELCH•” feature is provided on this radio. This feature allows you to set the squelch so that only signals exceeding a certain *S-meter level* will open the squelch.

Operation

To set up the RF squelch circuit for operation, use the following procedure:

- (1) Press and hold in the [MHz] key for one second, then rotate the **Main Dial** knob to select “**22 RFSQL**.”
- (2) Press the [MHz] key momentarily, then rotate the **Main Dial** knob to select the desired signal strength level for the squelch threshold (**OFF, S-3, S-5, S-7, S-9, or S-FULL**).
- (3) Press and hold in the [MHz] key for one second to save the new setting and exit to normal operation.

Note: The receiver's squelch will open based on the highest level set by the two squelch systems (Noise Squelch and RF Squelch). For example:

- (1) *If the Noise Squelch (Menu #28) is set so that signals at a level of S-3 will open the squelch, but the RF Squelch (Menu #22) is set to “**S-9**,” the squelch will only open on signals which are S-9 or stronger on the S-meter.*
- (2) *If the RF Squelch is set to “**S-3**,” but the Noise Squelch is set to a high level which will only pass signals which are Full Scale on the S-meter, the squelch will only open on signals which are Full Scale on the S-meter. In this case, the Noise Squelch overrides the action of the RF Squelch.*

LOCK FEATURE

If nothing happens when you press a button ... the panel may be “locked” (this feature is normally used to prevent accidental changes to the settings of controls and switches). To unlock the front panel, use the following procedure:

- (1) Press and hold in the [MHz] key for one second, then rotate the **Main Dial** knob to select “**17 LOCK**.”
- (2) Press the [MHz] key momentarily, then rotate the **Main Dial** knob to change the setting to “**OFF**.”
- (3) Press and hold the [MHz] key for one second to save the new setting and exit to normal operation.
- (4) To re-lock the front panel, select “**ON**” in step (2) above.

KEYPAD BEEPER

A key/button beeper provides useful audible feedback whenever a button is pressed. Each key and button has a different beep pitch, and each function has a unique beep combination.

If you want to turn the beeper off (or back on again):

- (1) Press and hold in the [MHz] key for one second, then rotate the **Main Dial** knob to select “**04 BEEP**.”
- (2) Press the [MHz] key, then rotate the **Main Dial** knob to select the display to “**OFF**.”
- (3) Press and hold the [MHz] key for one second to save the new setting and exit to normal operation.

DISPLAY BRIGHTNESS

The FT-2600M display illumination has been specially engineered to provide high visibility with minimal disruption of your “night vision” while you are driving. The brightness of the display is manually adjustable, using the following procedure:

- (1) Press and hold in the [**MHz**] key for one second, then rotate the **Main Dial** knob to select “**12 DIM R.**”
- (2) Press the [**MHz**] key, then rotate the **Main Dial** knob to select a comfortable brightness level: **D1** , **D2** , **D3** , **D4** , or **OFF** (no illumination).
- (3) Press and hold in the [**MHz**] key for one second to save the new setting and exit to normal operation.

TUNING: THE “DIAL • VFO) MODE

This mode is used for selecting a frequency utilizing the **Main Dial** knob and microphone [**UP**] and [**DWN**] buttons allow the Variable Frequency Oscillator (VFO) to tune in the selected step size. When scanning in the VFO mode, the same steps are used as in manual tuning.

Clockwise rotation of the **Main Dial** knob increases the operating frequency, while counter-clockwise rotation tunes toward a lower frequency.

To move frequency rapidly (in 1 MHz steps), press the [**MHz**] key momentarily, then rotate the **Main Dial** knob. The 1 MHz digit of the frequency display will blink while “1 MHz Tuning” is enabled. When you have selected the desired “1 MHz” frequency digit, press the [**MHz**] key momentarily once more, then resume normal tuning using the **Main Dial** knob.

CHANNEL STEP SELECTION

Tuning steps are factory preset to default increments which are appropriate for the country to which this radio is exported.

To change to another step size, use the following procedure:

- (1) Press and hold the [**MHz**] key for one second, then rotate the **Main Dial** knob to select “**29 STEP.**”
- (2) Press the [**MHz**] key, then rotate the **Main Dial** knob to select the desired step size: **5.0/10.0/12.5/15.0/20.0/25.0/50.0** (kHz).
- (3) Press and hold in the [**MHz**] key for one second to save the new setting and exit to normal operation.

Operation

DIRECT KEYPAD FREQUENCY ENTRY (MH-36_{B6J} MICROPHONE)

The keypad of the MH-36_{B6J} DTMF Microphone may be used for direct entry of the operating frequency. It also may be used for recall of memory channels.

To enter a frequency from the MH-36_{B6J} keypad:

- (1) Press the [D/MR] key, if necessary, to set the transceiver into the VFO mode.
- (2) While receiving on any VFO frequency, enter the digits of the desired frequency.
For example, to enter 146.520 MHz, press [1]⇒[4]⇒[6]⇒[5]⇒[2]⇒[0].
A high-pitched “beep” will confirm each key closure as you enter the digits; the final “beep” will be of longer duration, to confirm that the frequency entry is complete.
- (3) The [#] key may be used to abbreviate the entry procedure. Pressing the [#] key sets the *current digit* and *all following digits* to “0” to complete the entry.
For example, to enter 146.500 MHz, press [1]⇒[4]⇒[6]⇒[5]⇒[#].
To enter 144.000 MHz, press [1]⇒[4]⇒[4]⇒[#].

Recalling memories is equally simple (see page 32 for details on memory operation). You can recall a memory from the MH-36_{B6J} from any operating mode: VFO, HOME, or Memory.

- (1) Press the Channel Number you wish to recall, then press the [*] key. For example, to recall Memory Channel 2, press [2]⇒[*]. To recall Channel number 135, press [1]⇒[3]⇒[5]⇒[*].
- (2) To return to the VFO mode, press the front panel’s [D/MR] key or the microphone’s [P] key twice (the first press recalls the HOME channel memory; see page 34).
- (3) If you are in the Memory Recall mode, you can enter a new operating frequency directly, as described above for VFO operation. However, you will observe that a “T” indicator will appear at the right side of the display; this indicates that you have switched to the “Memory Tune” mode, which is described in detail on page 34.

TRANSMISSION

To transmit, simply close the **PTT** (Push To Talk) switch on the microphone when the frequency is clear. Hold the microphone approximately 25 mm (1") from your mouth, and speak into the microphone in a normal voice level. When your transmission is complete, release the **PTT** switch; the transceiver will revert to the receive mode.

DTMF KEYPAD

The white keys (with numbers, letters, or the */# characters printed on them) on the microphone may be used for manual sending of DTMF tones for autopatch or repeater control use. Just press the **PTT** switch, and hold it in while pressing the desired keys.

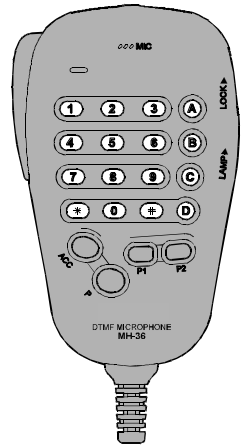

1750 Hz TONE CALL

In the European version, press the [**ACC**] button on the microphone to transmit a 1750 Hz Calling Tone for repeater access.

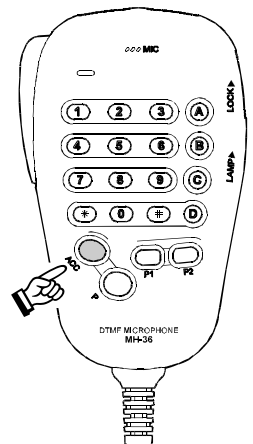

Operation

POWER OUTPUT SETTING

Four power output levels are available on this transceiver: 5 watts (Low 3), 10 watts (Low 2), 25 watts (Low 1) and 60 watts (High).

To change the power level, press and hold the [REV] key to select one of four power setting. These power levels will be stored in memory registers, at the time of memory storage (see page 32 for details on Memory operation).

During transmission, the Bar Graph will deflect in the display, according to the power output selected.

5 watts (Low 3)



10 watts (Low 2)



25 watts (Low 1)



60 watts (High)



PTT LOCKING

The **PTT** circuitry may be locked out, so as to prevent unauthorized (or otherwise undesired) transmission.

To lock out the **PTT** switch and prevent transmission, use the following procedure:

- (1) Press and hold the [MHz] key for one second, then rotate the **Main Dial** knob to select "16 LCKTX."
- (2) Press the [MHz] key, then rotate the **Main Dial** knob to select the display to "ON."
- (3) Press and hold the [MHz] key for one second to save the new setting and exit to normal operation.
- (4) To cancel PTT locking, select "OFF" in step (2) above.

TRANSMITTER THERMAL PROTECTION SENSOR

Although the FT-2600M includes an extensive heat-dissipation system, excessively-long transmissions or restricted ventilation around the transceiver's case may cause the transceiver to overheat. This condition has the potential to cause damage.

Before the heat has built up to a dangerous level, you will be provided early warning by the "TX PRTCT" ("TRANSMITTER PROTECTION") indication on the display. If this is observed, curtail your transmission and allow the transceiver to cool off.

If your operating patterns require very long, continuous transmissions, try one of the "Low Power" modes to reduce the heat generated by the final amplifier stage. You may find that effective communications can still be carried out even at the 5-Watt power level.

Operation

REPEATER OPERATION

The FT-2600M includes a host of convenience features which makes operation on amateur repeaters both efficient and enjoyable.

REPEATER SPLITS

This transceiver offers three methods of setting up split-frequency operation on repeaters:

- [1] Manual selection of preset repeater shifts;
- [2] Automatic Repeater Shift (ARS), providing automatic activation of repeater shifts within designated repeater frequency subbands; and
- [3] Independently stored transmit and receive frequencies (typically not corresponding to established repeater frequency shifts).

[1] Standard Repeater Shifts

The FT-2600M has been shipped ready for use on the repeater shift typically used in your country. For customers in the United States, for example, the standard repeater shift will be 600 kHz, and the direction of the shift will depend on the part of the band in which you are operating.

To activate the standard shift manually:

- (1) Press and hold in the [MHz] key for one second, then rotate the **Main Dial** knob to select “**23 RPTR.**”
- (2) Press the [MHz] key, then rotate the **Main Dial** knob to select the desired shift direction: **ARS** (Automatic Repeater Shift), **SHIFT-**, **SHIFT+**, or **OFF** (Simplex).
- (3) Press and hold in the [MHz] key for one second to save the new setting and exit to normal operation.

With repeater shift activated, you can temporarily reverse the transmit and receive frequencies by pressing the front panel’s [REV] key. Use this feature to display the transmit frequency *without transmitting*, and to check the strength of signals on a repeater uplink frequency (so as to determine whether or not a particular station is within “Simplex” range, for example).

CHANGING THE DEFAULT REPEATER SHIFT

The repeater offset is usually set to 600 kHz from the factory. You can change the offset by using following procedure, if needed:

- (1) Press and hold in the [MHz] key for one second, then rotate the **Main Dial** knob to select “**26 SHIFT.**”
- (2) Press the [MHz] key, then rotate the **Main Dial** knob to set the desired offset. Note that the resolution of the “standard” repeater shift is to the nearest 50 kHz multiple.
- (3) Press and hold in the [MHz] key for one second to save the new setting and exit to normal operation.

Note: Do not use the above procedure if you just want to operate on one “odd split” frequency. Use the “Independent Transmit/Receive Frequency” mode, as described in section [3] on the next page.

[2] Automatic Repeater Shift

The ARS (Automatic Repeater Shift) feature in the FT-2600M allows easy and convenient repeater operation by automatically activating the repeater shift function whenever you tune to a standard repeater sub-band. The ARS function is preset at the factory to conform to the standards for the country to which it is exported.

The ARS function is *enabled* at the factory. To *disable* it:

- (1) Press and hold in the [MHz] key for one second, then rotate the **Main Dial** knob to select “23 RPTR.”
- (2) Press the [MHz] key, then rotate the **Main Dial** knob to change the display to “OFF.”
- (3) Press and hold in the [MHz] key for one second to save the new setting and exit to normal operation.

To enable the ARS function again, select “ARS” in step (2) above.

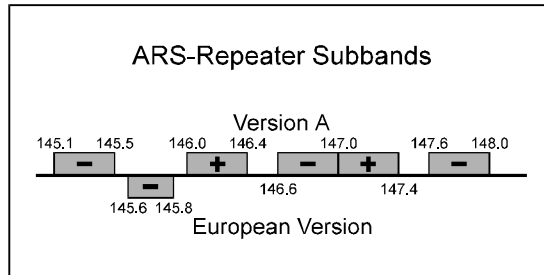

[3] Separate Transmit Frequency Memories

All memory channels can store independent receive and transmit frequencies, to accommodate occasional non-standard offsets with greater frequency resolution than is available using the “standard” shift feature.

Here is the procedure for storing an “odd split” frequency pair into a memory. A full discussion of memory channel storage and recall is found in the next section.

- (1) First store the *receive* (repeater output) frequency. In the VFO mode, tune the transceiver to the desired receive frequency. Now press and hold in the [D/MR] key for one second.
- (2) Within five seconds of pressing the [D/MR] key, use the **Main Dial** knob (or the microphone’s [UP]/[DWN] buttons) to select the memory channel number on which you wish to store the frequency pair. If the memory register already has data stored in it, the display will blink “CHnnnUSD” where “nnn” is the channel number.
- (3) Now press the [D/MR] key for one second to store the receive frequency into the selected memory.

Operation

- (4) Next, store the *transmit* (repeater input) frequency. Since you are still in the VFO mode, tune the transceiver to the desired transmit frequency.
- (5) Now press and hold in the [**D/MR**] key for one second.
- (6) Press and hold the **PTT** switch, then press the [**D/MR**] key for one second while holding in the **PTT** switch. This will not cause transmission, but rather it will instruct the transceiver that you are *programming* a separate transmit *frequency* into memory.

When you have finished the above procedure, press the [**D/MR**] key momentarily. The channel number will flash onto the display momentarily, to be followed by the repeater downlink frequency. If you press the **PTT** switch, you will observe the display changing to indicate the repeater's uplink frequency. Note also that the display shows “-+” in the upper left-hand corner; this indicates that an “odd” (non-standard) shift has been stored on this channel.

TONE SQUELCH MODES

Repeater systems often require an access signal for activation of the repeater. These access tones are often required so as to reduce false activation of the repeater by random noises or other signals on the band. Additionally, these systems can allow silent monitoring of busy channels until a call *directed to your radio* is received, offering less disruption to family activities, etc.

CTCSS (CONTINUOUS TONE CODED SQUELCH SYSTEM)

This system superimposes a continuous, subaudible tone on your transmitted audio. When decoded at the other station, the CTCSS signal triggers their squelch to open and receive your transmission. Some “closed” repeaters use this to limit access, or to prevent signals intended for other repeaters (with the same input frequency) in fringe areas from locking up the repeater. There are 47 selectable CTCSS tones provided in the FT-2600M.

CTCSS T ONE FREQUENCY (Hz)							
67.0	69.3	71.9	74.4	77.0	79.7	82.5	85.4
88.5	91.5	94.8	97.4	100.0	103.5	107.2	110.9
114.8	118.8	123.0	127.3	131.8	136.5	141.3	146.2
151.4	156.7	159.8	162.2	167.9	173.8	179.9	183.5
186.2	189.9	192.8	196.6	199.5	203.5	206.5	210.7
218.1	225.7	229.1	233.6	241.8	250.3	254.1	-

DCS (DIGITAL CODE SQUELCH)

DCS operation modulates a subaudible tone according to a digital protocol (continuous 32-bit synchronous code). DCS is widely used in the commercial (Land-Mobile) industry because of its superior performance; its 104 unique codes offer greater immunity to false decoding than CTCSS, although CTCSS is still more widely used in amateur repeater systems.

To use either CTCSS or DCS, both stations must be on the same frequency, and must have selected the same CTCSS tone or DCS code.

To select and activate CTCSS or DCS operation:

- (1) Press and hold in the [MHz] key for one second, then rotate the **Main Dial** knob to select “**30 TONE**.”
- (2) Press the [MHz] key, then rotate the **Main Dial** knob to select the desired squelch type from the following:
 - “**ENC**” (Encode) appears when the CTCSS tone generator is activated for *transmission* only.
 - “**ENC/ DEC**” (Encode/Decode) appears when the CTCSS Tone Squelch is activated for both TX *and* RX (only signals “Encoded” with the matching tone will open your radio’s squelch).

Operation

- “**DCS**” (digital code squelch) appears when Digital Code Squelch system (TX & RX) is active.
- (3) Press and hold in the [**MHz**] key for one second to save the new setting and exit to normal operation.

Now that you have selected the *Tone Mode* to be used, you need to select the CTCSS tone, or DCS code, that you and the other station have both agreed to use:

- If “**ENC**” or “**ENC/ DEC**” is selected:
 - (1) Press and hold in the [**MHz**] key for one second, then rotate the **Main Dial** knob to select “**31 TONEF**.”
 - (2) Press the [**MHz**] key, then rotate the **Main Dial** knob to choose the desired CTCSS tone.
 - (3) Press and hold in the [**MHz**] key for one second to save the new setting and exit to normal operation.
- If “**DCS**” is selected:
 - (1) Press and hold in the [**MHz**] key for one second, then rotate the **Main Dial** knob to select “**10 DCSN**.”
 - (2) Press the [**MHz**] key, then rotate the **Main Dial** knob to choose the desired DCS code.
 - (3) Press and hold in the [**MHz**] key for one second to save the new setting and exit to normal operation.

CTCSS/DCS settings may be stored in any memory register at the time of frequency programming. To change a memorized tone/code or tone system, just recall the memory channel, reset the tone or function, and store the memory again. If you activate CTCSS/DCS on a PMS memory, it will be active when that memory pair is used to start PMS scanning or tuning.

DCS CODES																				
023	025	026	031	032	036	043	047	051	053	054	065	071	072	073	074	114	115	116	122	125
131	132	134	143	145	152	155	156	162	165	172	174	205	212	223	225	226	243	244	245	246
251	252	255	261	263	265	266	271	274	306	311	315	325	331	332	343	346	351	356	364	365
371	411	412	413	423	431	432	445	446	452	454	455	462	464	465	466	503	506	516	523	526
532	546	565	606	612	624	627	631	632	654	662	664	703	712	723	731	732	734	743	754	-

CTCSS/DCS SELECTIONS USING PROGRAMMABLE MICROPHONE KEY

One of the microphone's "Programmable Keys" (**P1**, **P2**, or **ACC**) may be utilized for comprehensive control over CTCSS and/or DCS operation.

For the discussion below, let us assume that the [**P1**] key has been assigned the "TONE" function, per the instructions on page 53.

- (1) When you have chosen the desired operating frequency, press the [**P1**] key momentarily. The display will indicate "**OFF**" if no CTCSS or DCS code is currently engaged.
- (2) Within three seconds, press the [**P1**] key as many times as required to activate the desired Tone mode. The available options are:

E (CTCSS Encoder)	The current tone will be shown at the right side of the display.
ED (CTCSS Encoder/Decoder)	The current tone will be shown at the right side of the display, and " CTCSS " will appear at the top of the display.
DCS (DCS Encoder/Decoder)	The current DCS Code # will be shown at the right side of the display, and " DCS " will appear at the top of the display.
OFF	No CTCSS/DCS tone or code is active.

- (3) When you have made your selection from the above list, press the microphone's [**UP**] or [**DWN**] key, as many times as required, to select the desired CTCSS Tone Frequency or DCS Code #.

Note: The above procedure may be performed on a VFO frequency, a Memory Channel, or the HOME Channel. Any changes you make will be memorized as a "running change" to the original data, which will be discarded. Therefore, you do not need to *"re-memorize" data if you are modifying CTCSS/DCS information on a memory.*

CTCSS TONE SEARCH SCANNING

In operating situations where you don't know the CTCSS tone being used by another station, you can command the radio to listen to the incoming signal and scan in search of the tone being used.

Before you begin the tone search, please check the (programmable) setting of the microphone's [**ACC**] button (Menu #21); it should be set to "**TSRCH**" for proper operation.

To scan for the CTCSS tone in use:

- (1) Set the radio up for the CTCSS operation.
- (2) Press the [**ACC**] button on the microphone momentarily to start scanning for the incoming CTCSS tone.

Operation

- (3) When the radio detects the correct tone, it will halt on that tone, and audio will be allowed to pass.
- (4) Press and hold in the **[D/MR]** key for one second; the CTCSS tone detected will be stored as the “current” tone, so it may be used for memory storage purposes.
It can be viewed by accessing MENU #31 (**TONEF**).
- (5) Press and hold in the **[MHz]** key for one second to exit to normal operation.

DCS TONE SEARCH SCANNING

In operating situations where you don't know the DCS code being used by another station, you can command the radio to listen to the incoming signal and scan in search of the code being used.

Before you begin the DCS Code search, please check the (programmable) setting of the microphone's **[ACC]** button (Menu #21); it should be set to “**TSRCH**” for proper operation.

To scan for the DCS tone in use:

- (1) Set the radio up for the DCS operation.
- (2) Press the **[ACC]** button on the microphone momentarily to start scanning for the incoming DCS tone.
- (3) When the radio detects the correct code, it halts on that code, and audio is allowed to pass.
- (4) Press and hold in the **[D/MR]** key for one second; the DCS code detected will be stored as the “current” code #, so it may be used for memory storage purposes.
It can be viewed by accessing MENU #10 (**DCSN**).
- (5) Press and hold in the **[MHz]** key for one second to exit to normal operation.

DCS CODE INVERSION

DCS uses a codeword consisting of a 23-bit frame, transmitted (subaudible) at a data rate of 134.4 bps (bit/sec). Occasionally, signal *inversion* can result in the *complement* of a code to be sent or received. This prevents the receiver squelch from opening with DCS enabled, as the decoded bit sequence does not match that selected for operation.

Typical situations that might cause inversion to occur are:

- Connection of an external receiver preamplifier.
- Operating through a repeater.
- Connection of an external linear amplifier.

Note that unexpected code inversion does *not* mean that any of the above listed equipment is defective !

In certain amplifier configurations, the output signal (phase) is inverted from the input. Small signal or power amplifiers having an odd number (1, 3, 5, etc.) of amplification stages may result in inversion of a transmitted or received DCS code.

While under most circumstances this should not occur (amplifier designs and industry

standards take this into account), if you find that your receiver squelch does not open when both you and the other station are using a common DCS code, you or the other station (*but not both*) can try the following:

- (1) Press and hold in the [MHz] key for one second, then rotate the **Main Dial** knob to select “**1 1 DCSNR.**”
- (2) Press the [MHz] key, then rotate the **Main Dial** knob to select one of the following modes:

TRX NOR:	Encoder: Normal	Decoder: Normal
RX REV:	Encoder: Normal	Decoder: Reverse (Inverted)
TX REV:	Encoder: Reverse (Inverted)	Decoder: Normal
TRX REV:	Encoder: Reverse (Inverted)	Decoder: Reverse (Inverted)
- (3) Press and hold in the [MHz] key for one second to save the new setting and exit to normal operation.

Remember to restore the default setting of MENU #11 to “**TRX NOR**” (Encoder; Normal, Decoder; Normal) when done.

CTCSS BELL PAGING

CTCSS Bell Paging adds an alert ringer to CTCSS tone squelch operation, for added convenience. When you receive a call with a matching CTCSS tone, the ringer will sound to alert you to the presence of the incoming call.

- (1) Press and hold in the [MHz] key for one second, then rotate the **Main Dial** knob to select “**05 BELL.**”
- (2) Press the [MHz] key, then rotate the **Main Dial** knob to change the display to “**ON.**”
- (3) To de-activate CTCSS Bell operation, select “**OFF**” in step (2) above.

Calls without a matching CTCSS tone will be ignored during CTCSS Bell operation.

Note that other stations do not need to have the CTCSS Bell function to call you; they can just use standard CTCSS encoding.

When you reply to a CTCSS Bell call, you may want to turn off the Bell function, or else the transceiver will ring every time your squelch opens.

You can store the CTCSS Bell Paging function into a memory, along with the CTCSS tone and encode/decode state.

Operation

DTMF AUTODIALER OPERATION

Eight DTMF Autodialer memories are available on the FT-2600M. These DTMF Autodialer memories can store up to 16 digits of a telephone number for, repeater autopatch or other uses.

To load DTMF Autodialer memories, use following procedure:

- (1) Press and hold in the **[MHz]** key for one second, then rotate the **Main Dial** knob to select “**1 5 DTMFW .**”
- (2) Press the **[MHz]** key, then rotate the **Main Dial** knob to select the DTMF Autodialer memory channel number into which you wish store a telephone number (“**1**” to “**8**”).
- (3) Press the **[D/MR]** key momentarily.
- (4) Rotate the **Main Dial** knob to select the first digit of the telephone number you wish to store.
- (5) When you have selected the correct digit, press the **[D/MR]** key momentarily.
Now rotate the **Main Dial** knob to select the second of the 16 available numbers in the current DTMF Autodialer memory register.
- (6) Repeat this procedure for each digit in the telephone number.
- (7) When entry of all digits is complete, press and hold the the **[D/MR]** key for one second to save the new setting. If you wish to store another DTMF string, rotate the **Main Dial** knob to select another DTMF Memory register, then repeat steps (3) through (6) above.
- (8) When all required DTMF memories are filled to your satisfaction, press and hold in the **[MHz]** key for one second to save the new settings and exit to normal operation.

To *transmit* the memorized telephone number, use the following procedure:

- (1) If you are not working within the MENU system, press and hold in the **[MHz]** key for one second, then rotate the **Main Dial** knob to select “**1 5 DTMFW .**”
- (2) Now press the **[MHz]** key momentarily to enable selection of the Autodialer Memory.
- (3) Rotate the **Main Dial** knob to select the DTMF Autodialer Memory channel to be transmitted.
- (4) Press and hold in the **PTT** switch.
- (5) While still holding the **PTT** switch in, press the **[MHz]** key momentarily to transmit the tone string.

Once you have pressed the **[MHz]** button above step, you can release the **PTT** switch, as Autodialer transmits the whole DTMF string automatically.

The speed at which the DTMF digits are sent can be changed. Two speed levels are available: Low (10 digits per second) and High (20 digits per second: default).

To toggle between Low and High speed, use the following procedure:

- (1) Press and hold in the **[MHz]** key for one second, then rotate the **Main Dial** knob to select “**1 4 DTMFS.**”

- (2) Press the [**MHz**] key, then rotate the **Main Dial** knob to select the desired speed: “**50** ms” (High speed) or “**100** ms” (Low speed).
- (3) Press and hold in the [**MHz**] key for one second to save the new setting and exit to normal operation.

You can also set a longer delay between the time you press the [**MHz**] key (with **PTT** pressed) and the first DTMF digit is sent.

To set a delay time, use the following procedure:

- (1) Press and hold in the [**MHz**] key for one second, then rotate the **Main Dial** knob to select “**13 DTMF D.**”
- (2) Press the [**MHz**] key, then rotate the **Main Dial** knob to select the desired speed (**50 / 250 / 450 / 750 / 1000** ms).
- (3) Press and hold in the [**MHz**] key for one second to save the new setting and exit to the normal operation.

Memory System Operation

MEMORY STORAGE

To store a frequency into memory:

- (1) In the VFO mode, select the desired frequency, repeater shift, CTCSS tone, and TX power level.
- (2) Press and hold in the [D/MR] key for one second. A memory number (or letters and numbers) will appear (blinking) on the display.
- (3) Within five seconds of pressing the [D/MR] key, use the **Main Dial** knob or the microphone's [UP]/[DWN] buttons to select the desired memory for storage (if the channel is already occupied by data stored previously, the **USD** notation will appear to the right of the blinking channel number).

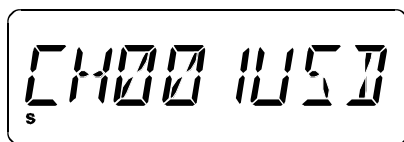

- (4) Press the [D/MR] key again, this time momentarily, to store the displayed data into the selected memory channel slot. The memory label will stop blinking, and the display will now be blank, except for a blinking digit at the left side of the display. If you wish to append a name to the just-memorized channel, move *quickly* to the next step.

Note: If the left digit quits blinking, this indicates that the Alpha-Numeric Storage Timer has expired. The frequency data will not be lost if this happens, however.

TO APPEND AN ALPHA-NUMERIC LABEL TO A MEMORY

- (1) While the right-most digit is still blinking in step (4) above, rotate the **Main Dial** knob to select the first character in the name you wish to store, then press the [D/MR] key to move on to the next character. Letters (both upper and lower case), numbers, and symbols are available for storage.
- (2) Again rotate the **Main Dial** knob to select the desired number, letter, or symbol, then press the [D/MR] key to move on to the next character's slot.
- (3) Repeat step (2) as many times as necessary to complete the name tag for the memory, then press and hold in the [D/MR] key for one second to save the A/N (Alpha-Numeric) name entry and exit to normal operation.

*Note: If you wish to append a label to a memory after the Alpha-Numeric Storage Timer has expired, first recall the memory channel (see below), then press the [MHz] key for one second to enter the MENU mode. Rotate the **Main Dial** to select MENU item #01 (ALPH), then press the [MHz] key momentarily. You will now be ready to begin with step (1) above.*

Memory System Operation

RECALLING MEMORIES

From the VFO mode, momentarily press the [D/MR] key once to activate the “MR” (Memory Recall) mode.

When more than one memory has been stored, use the **Main Dial** knob to select a memory for operation. Alternatively, microphone’s [UP] and [DWN] buttons may be used to step or scan through the available memories. When using the microphone’s buttons, press and immediately release the button to move one step up or down; press and hold the [UP] or [DWN] button for one second to begin memory scanning.

While you are operating in the MR mode, the “M” notation will appear at the right side of the display.

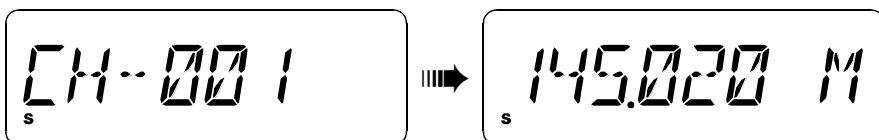

MEMORY RECALL FROM MH-36_{B6J} MICROPHONE

While operating in the VFO, HOME Channel (see below), or Memory Recall mode, the keypad of the MH-36_{B6J} may be used for direct recall of memory channels.

To do this, press the Channel Number you wish to recall, then press the [*] key. For example, to recall Memory Channel 5, press [5]⇒[*]. To recall Channel number 118, press [1]⇒[1]⇒[8]⇒[*].

TO TURN ON THE ALPHA-NUMERIC MEMORY NAME DISPLAY

If you are in the “MR” mode, press the [A/N] key to replace the frequency display with the Alpha-Numeric Label.

Memory System Operation

HOME CHANNEL MEMORY

A convenient one-touch “HOME” channel memory is available to simplify return to your most-often-used frequency. This memory does not appear in the regular memory bank, to simplify operation.

To recall the HOME channel while in the **MR** mode, just press the [**D/MR**] key momentarily. From the **VFO** mode, press [**D/MR**] twice. While you are operating on the HOME channel, an “**H**” will appear at the right side of the display.

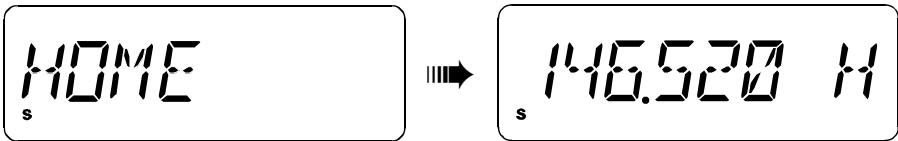

The factory default frequency for the HOME channel is 146.520 MHz. You can re-program the HOME channel in a manner identical to that used for the regular memories:

- (1) From the VFO mode, tune in the frequency you wish to store, and set all repeater shifts and other data just the way you do for “normal” memory channel storage.
- (2) Press and hold the [**D/MR**] key for one second, then rotate the **Main Dial** knob to select “**HOME**.”
- (3) Press the [**D/MR**] key momentarily to store the new HOME channel.
- (4) At this point, the right-most digit will be blinking, as a reminder that you can store an Alpha-Numeric label to the HOME channel. Use the A/N storage procedure described previously.

MEMORY OFFSET TUNING

Once you have recalled a particular memory channel, you may tune off that channel, as though you were in the VFO mode.

- (1) With the FT-2600M in the “**MR**” mode, select the desired memory channel.
- (2) Press the [**MHz**] key momentarily.
- (3) Now rotate the **Main Dial** knob, as desired, to tune to a new frequency. This new frequency may be stored in a new memory register, if you like, using the procedures described earlier.
- (4) If you wish to return to the original memory frequency, press the [**D/MR**] key momentarily. Any offset tuning will be discarded, and the original memory contents will appear on the display.

Memory System Operation

MEMORY-ONLY MODE

Once memory channel programming has been completed, you may place the radio in a “MEMORY-ONLY” mode, whereby VFO and HOME channel operation are impossible. This may be particularly useful during public-service events where a number of operators may be using the radio for first time, and ultimate simplicity of channel selection is desired.

To place the radio into the MEMORY-ONLY mode, turn it off. Now press and hold in the [**D/MR**] key while turning the radio on. The VFO and HOME channel will now be disabled.

To return to normal operation, repeat the above power-on procedure.

DELETING MEMORIES

With 174 total memories available, there frequently are situations where you may desire to delete certain memorized frequencies. The procedure for deleting a channel is quite simple:

- (1) Press and hold in the [**D/MR**] key for one second.
- (2) Rotate the **Main Dial** to select the channel to be deleted. Note that Memory Channel 1 may *not* be deleted, as it is the Priority Channel.
- (3) Press the [**A/N**] button. This will cause the display to shift to Memory Channel 1, and the previously-selected memory will be deleted.

***Important Note:** Once deleted, the channel data cannot be recovered.*

Scanning

The FT-2600M's scanning capability provides the operator with many convenient methods of rapid frequency navigation.

BASIC SCANNER OPERATION

Before activating the scanner, make sure that the Squelch is set to silence the background noise when no signal is present. If noise is being heard, the scanner will not function (because the radio will “think” that it is on a “Busy” channel).

Scanning may be started or stopped using the microphone's [UP] and [DWN] buttons. The following techniques are used during scanning operation:

- (1) Pressing and holding in either the [UP] or [DWN] button for one second in the *VFO mode* will cause upward or downward *band* scanning, respectively, to begin.
- (2) Pressing and holding in either the [UP] or [DWN] button for one second in the *Memory Recall mode* will cause memory channel scanning toward a higher- or lower-numbered *memory channel*, respectively.
- (3) Scanning pauses when a signal opens the squelch, and the decimal point on the display will blink. You can choose one of two scan-resume modes (described later).
- (4) To halt the scan manually, the easiest way is to push the **PTT** switch on the microphone momentarily (no transmission will occur while you are scanning).

The scan may also be halted manually by pressing the microphone's [UP] or [DWN] button, or the [D/MR] key on the front panel of the radio.

SCAN-RESUME OPTIONS

Two scan-resume modes are available on the FT-2600M:

- [1] In the **BUSY** mode, the scanner will remain halted for as long as there is carrier present on the channel; after the carrier drops at the end of the other station's transmission, the scanner will resume.
- [2] In the **TIME** mode, the scanner will halt for five seconds *only*, after which scanning will resume (whether or not the other station is still transmitting).

To change the scan-resume mode:

- (1) Press and hold in the [MHz] key for one second, then rotate the **Main Dial** knob to select “**25 SCAN**.”
 - (2) Press the [MHz] key, then rotate the **Main Dial** knob to select the desired scan-resume mode (**BUSY** or **TIME**).
 - (3) Press and hold in the [MHz] key for one second to save the new setting and exit to normal operation.
-

MEMORY SKIP SCANNING (MR MODE)

When you have some continuously-active channels (like Weather broadcasts) in memories, you may wish to *skip* them for *scanning*, but still have them available for *manual selection*.

To select a memory to be skipped during scanning:

- (1) Recall the memory channel to be skipped. Note that Memory Channel 1 may *not* be skipped, as it is the Priority Channel.
- (2) Press and hold in the [MHz] key for one second, then rotate the **Main Dial** knob to select “**27 SKIP.**”
- (3) Press the [MHz] key, then rotate the **Main Dial** knob to select “**SKIP.**”
- (4) Press and hold in the [MHz] key for one second to save the new setting and exit to normal operation.

To re-enable a “skipped” memory channel, select “**STOP**” in step (3) above.

TEMPORARY MEMORY SKIP

If the scanner repeatedly stops on a channel due to temporary noise or interference, you can temporarily mark it to be skipped. The channel will be skipped until you manually stop the scan (by pressing the PTT switch, for example).

To skip a channel temporarily, press the [MHz] key momentarily while the scanner has stopped on the channel to be skipped. The scanner will instantaneously resume, and that channel will not be scanned during this scanning session. Note that Memory Channel 1 may *not* be skipped, as it is the Priority Channel.

Scanning

PROGRAMMABLE BAND-SCAN LIMITS

Besides band and memory scanning, this radio can be set to tune or scan only the frequencies between user-defined lower and upper limits. For example, you may wish to limit tuning/scanning to 144.5 ~ 148 MHz, to avoid encroachment on the SSB/CW sub-band between 144.0 and 144.5 MHz.

These scanning limits are stored in special “Sub-Band Limit Memories,” labeled **PMS-1 L**, **PMS-1 U**, **PMS-2 L**, and **PMS-2 U**, with “L” and “U” designations representing the Lower and Upper limits, respectively.

To utilize this feature, use the following steps:

- (1) Store the lower edge of the desired scanning/tuning range in memory “**PMS-1 L**,” and the upper edge in memory “**PMS-1 U**” (or, alternatively, in memories “**PMS-2 L**” and “**PMS-2 U**”).
- (2) With any of these memories recalled, press the [**MHz**] key momentarily to activate the Programmable Band-Scan Limits. The “**P**” notation will appear at the right side of the display, reminding you that you are using the Programmable Band Limits.

The frequencies stored in memories “L” and “U” will now serve as tuning and scanning limits, thus creating a tuning sub-band.

To cancel the sub-band limits and return to normal memory operation, press the [**D/MR**] key momentarily.

*Note: If the frequency in memory channel “**PMS-xL**” is equal to or greater than the frequency stored in memory channel “**PMS-xU**,” you can not activate the PMS operation.*

SMART SEARCH OPERATION

The Smart Search feature may be used to load – automatically with no operator intervention – a special bank of up to 50 memory channels (per band) based on activity. Smart Search will sweep either the entire band or the portion of the band within the Programmable Band-Scan Limits, and will load the special memory bank with the frequency and repeater shift data pertaining to those channels on which activity is found (if Automatic Repeater Shift is activated). The channels are loaded in the order in which they are encountered, not according to signal strength or by ascending frequency.

The Smart Search feature is especially useful when visiting a city for the first time, where you may be unfamiliar with the repeater frequencies; Smart Search discovers where the local activity is to be found, and automatically loads those frequencies for you.

Smart Search operation is simple to activate:

- (1) Press the [**P2**] key.*
- (2) The Smart Search process will now cause the radio to scan upward on current band, loading channels on which it encounters a signal strong enough to open the squelch.
- (3) When 50 channels are loaded or scanner is reached band edge, the scanner will stop and the transceiver will revert to the starting frequency.
- (4) To recall the Smart Search Memories just stored, rotate the **Main Dial** knob or press the microphone's [**UP**] or [**DWN**] key.
- (5) If you find particular channels which you wish to store into the “regular” memory system, follow the memory storage procedures described on page 32.
- (6) Press the [**D/MR**] key momentarily to exit the Smart Search mode.

Note that these memories are so-called “soft” memories; they will be lost if you exit the Smart Search mode or initiate a new Smart Search sweep.

- * The (user-programmable) [**P2**] key is set at the factory for Smart Search operation. It may be assigned to one of the other programmable keys, if you like. See page 53.

Scanning

PRIORITY CHANNEL MONITORING

The Priority function allows automatic checking for activity on Memory Channel 001 every five seconds while operating on the VFO or a different memory. When the receiver detects a signal on the “Priority” memory, operation automatically shifts to that channel while the signal is present (plus a few seconds). If you transmit while “paused” on the Priority channel, priority monitoring will cease, and the transceiver will “hold” indefinitely on the Priority channel. Only Channel 001 is available as the “Priority” channel.

To set up for priority monitoring:

- (1) Preset the **SQL** control to silence the background noise on a clear channel, then store the frequency to be the “Priority” channel into Memory Channel 001.
- (2) Press the [**D/MR**] key to operate in the VFO mode. If you are in the memory mode, select the memory on which you wish to operate (other than the Priority channel).
- (3) Press and hold in the [**A/N**] key for one second to initiate priority monitoring. The “**PRI**” (“**P**riority Channel”) notation will appear at the top of the display.

During priority monitoring, the displayed frequency will shift to the priority memory briefly about every five seconds, while the receiver checks for the presence of a signal.

While no signal appears on the Priority memory (causing the squelch to open), you can tune, transmit and receive on the VFO, or select and operate on other memories; however, you cannot scan (except manually, one step at a time, using the microphone’s [**UP**] and [**DWN**] buttons), as the scanning logic circuits are already dedicated to the priority scanning activities.

If a station you wish to talk with appears on the Priority memory, press the **PTT** switch momentarily while receiving their signal (no transmission will occur) to *halt* priority scanning. At this point, the FT-2600M will be shifted to the **MR** mode on Channel 001, and the previous operating status (**VFO**, **MR**, or **HOME**) will be ignored.

Otherwise, if you elect not to call the station appearing on the Priority channel, priority monitoring will pause and the decimal on the display will blink. Priority monitoring will resume based on the setting of the regular scanning-resume mode – either after a 5-second pause, or after the carrier drops out.

To *cancel* priority monitoring, press the [**D/MR**] key momentarily.

The priority function is not disabled by switching the transceiver off. If you were engaged in priority monitoring at the moment you turned the radio off, it will *assume* that you will want to continue priority monitoring during your next operating session, and will come up still in the priority mode when the transceiver is switched back *on*.

PRIORITY REVERT MODE

During Priority channel operation (Dual Watch), a special feature is available which will allow you to move to the Priority Channel instantly, without waiting for activity to appear on the Priority Channel.

When this feature is enabled, and Priority monitoring is engaged, just press the microphone's **PTT** button. Operation will instantly revert to the Priority Channel.

To enable Priority Revert operation:

- (1) Press and hold in the [**MHz**] key for one second, then rotate the **Main Dial** knob to select “**24 RVRT.**”
- (2) Press the [**MHz**] key, then rotate the **Main Dial** knob to select “**ON.**”
- (3) Press and hold in the [**MHz**] key for one second to save the new setting and exit to normal operation.

To disable Priority Revert operation, select “**OFF**” in step (2) above.

ARTS™: Auto Range Transpond System

This system uses DCS signaling to inform you when you and *another ARTS-equipped station* are within communications range. Both stations must first select DCS operation using the same DCS code.

Whenever you press the **PTT**, or every 30 seconds after ARTS is activated, your radio transmits a (subaudible) DCS signal. If the other radio is in range, the beeper (if enabled) will sound, and “ARTSlogo” will flash on the display.

Whether you talk or not, the radios will continue to poll each other every 30 seconds while ARTS is activated. You can also have your radio transmit your callsign via CW every nine minutes, to comply with identification requirements.

If you move out range for more than one minute (two polls), your radio senses that no signal has been received. The beeper will sound, and the “ARTSlogo” will stop flashing. If you move back into range, your radio will again beep, and the “ARTSlogo” will again flash.

During ARTS operation, it is not possible to change the operating frequency or other settings; you must first terminate ARTS to resume normal operation. This is a safety feature to prevent accidental loss of contact due to channel change, etc.

ARTS BASIC OPERATION

Here is how to activate ARTS:

- (1) Press and hold in the [MHz] key for one second, then rotate the **Main Dial** knob to select “**03 ARTS**.”
- (2) Press the [MHz] key, then rotate the **Main Dial** knob to select the ARTS operating mode: “**RX** (receive-only),” “**TX** (transmit-only),” “**TRX** (transceive),” or “**OFF**.” The operating descriptions assume both radios are set to “**TRX**.”
- (3) Press and hold in the [MHz] key for one second to save the entry and exit. The “ARTS” icon will appear in the display. The display will now show “**ARTS**” icon. After two pollings (one minute), if a response is not detected, “**ARTS**” icon will appear continuously; otherwise, “**ARTS**” icon will be flashed as long as both stations remain in range.
- (4) To cancel ARTS operation, select “**OFF**” in step (2) above.

ARTS™: Auto Range Transpond System

ARTS MODES

In the previous ARTS description, both transceivers were set to the “**TRX**” (transceive) mode. There are two other ARTS modes available from MENU #03, as outlined below:

- RX** – Use this mode if you only want your radio to listen, and not poll the other station (in which case their radio should be set to the “TX” mode). Here, your radio will beep and flash “**ARTS**” icon to indicate the state of connection.
- TX** – Likewise, this puts your radio into a *transmit-only* “beacon” mode where you won’t hear the polling beeps (but you can still hear when the other station talks). When activated, you have *no display of whether or not the other station is in range* (“**ARTS**” icon do not appear). You should have your CW IDer enabled when this mode is activated.

CW ID (MORSE IDENTIFIER) SET UP

The ARTS feature includes a CW identifier, as mentioned previously. The FT-2600M can be instructed to send “DE (*your callsign*) K” in Morse code every nine minutes during ARTS operation. The callsign field may contain up to 7 characters.

Here’s how to program the CW IDer:

- (1) Press and hold in the [**MHz**] key for one second, then rotate the **Main Dial** knob to select “**08 CW IDN.**”
- (2) Press the [**MHz**] key. You will notice the first entry’s place blinking. This indicates the CW ID Entry Mode. In this mode, rotate the **Main Dial** knob to select the numbers and letters in the callsign, and press the [**D/MR**] key to move the character’s *entry place* to the right.
- (3) Rotate the **Main Dial** knob to select the first number or letter in the callsign, then press the [**D/MR**] key to move the next character’s place.
- (4) Repeat step (3) as many times as necessary to complete the callsign entry.
- (5) Press and hold in the [**MHz**] key for one second to save the CW IDer entry and exit to normal operation.

To activate the CW IDer:

- (1) Press and hold in the [**MHz**] key for one second, then rotate the **Main Dial** knob to select “**07 CW ID.**”
- (2) Press the [**MHz**] key, then rotate the **Main Dial** knob to change the display to “**ON.**”
- (3) Press and hold in the [**MHz**] key for one second to save the new setting and exit to normal operation.

To disable the CW IDer, select “**OFF**” in step (2) above.

Packet Operation

Once you have connected your TNC and computer according to the instructions on page 13, there normally is no other configuration of the FT-2600M required for successful operation. The transceiver will automatically be configured for the proper baud rate (1200 bps or 9600 bps) depending on the signal path of the data passing via the rear panel's DATA connector.

Normally, the microphone will be cut off during packet transmission, so as to avoid interference to the data stream by voice input. However, this protection feature can be disabled, if you have some reason to want the microphone to be active during packet transmission.

To re-activate the microphone during packet transmission:

- (1) Press and hold in the [MHz] key for one second, then rotate the **Main Dial** knob to select "**18 PCKT.**"
- (2) Press the [MHz] key, then rotate the **Main Dial** knob to select "**MIC ON.**"
- (3) Press and hold in the [MHz] key for one second to save the new setting and exit to normal operation.

To disable the microphone during packet transmission (the typical configuration), select "**MIC OFF**" in step (2) above.

Packet operating procedures are governed by the software used by your computer and TNC. Consult the documentation accompanying the software for details on packet operation.

Miscellaneous Settings

TIME-OUT TIMER

The “Time-Out Timer” (TOT) feature is designed to force the transceiver into the “receive” mode after a preset time period of continuous transmission (the default is 6 minutes). This feature prevents your transceiver from transmitting a “dead carrier” for a long period of time in the event that the microphone **PTT** switch is accidentally locked in the “TX” condition.

The Time-Out Timer’s “switch-to-receive” time may be adjusted, in one minute increments, for any period between 1 and 60 minutes.

To change the default (6 minute) time setting as follows:

- (1) Press and hold in the [**MHz**] key for one second, then rotate the **Main Dial** knob to select “**32 TOT.**”
- (2) Press the [**MHz**] key, then rotate the **Main Dial** knob to select the desired time interval (between **1** and **60** minutes, or **OFF**).
- (3) Press and hold in the [**MHz**] key for one second to save the new setting and exit to normal operation.

AUTOMATIC POWER-OFF

The “Automatic Power-Off” (APO) feature will turn the radio completely *off* after a user-defined period of **PTT** or key/button inactivity. If you do not press any front panel keys or buttons, rotate the **Main Dial** knob, use the microphone’s keys and buttons, or transmit, and so long as the transceiver is not scanning or engaged in priority monitoring, the radio will shut itself off after the specified time period. This feature is useful in minimizing battery drain in a mobile installation if you forget to turn the transceiver off when you leave your vehicle.

To activate the APO feature as follows:

- (1) Press and hold in the [**MHz**] key for one second, then rotate the **Main Dial** knob to select “**02 APO.**”
- (2) Press the [**MHz**] key, then rotate the **Main Dial** knob to select the desired “switch-off” time (between **1** and **12** hours, or **OFF**).
- (3) Press and hold in the [**MHz**] key for one second to save the new setting and exit to normal operation.

Miscellaneous Settings

FM BANDWIDTH & MIC GAIN CONTROL

You can reduce the microphone input level and receiver bandwidth when operating on tightly-clustered frequencies (channel spacing of 12.5- or 15-kHz). This will reduce the transmitter and receiver deviation, thus minimizing interference to other users.

To reduce the microphone input level:

- (1) Press and hold in the [MHz] key for one second, then rotate the **Main Dial** knob to select “**33 W / N.**”
- (2) Press the [MHz] key, then rotate the **Main Dial** knob to change the display to “**NARROW.**”
- (3) Press and hold in the [MHz] key for one second to save the new setting and exit to normal operation.

To restore the normal (higher) microphone input level and normal (15 kHz) receiver bandwidth, select “**WIDE**” in step (2) above.

Miscellaneous Settings

PROGRAMMABLE MICROPHONE KEYS (ACC/P1/P2)

Default FT-2600M key functions have been assigned (at the factory) to the microphone's [P1], [P2], and [ACC] buttons. These may be changed by the user, if you wish to define another function for a particular key or keys.

To change the assignment of a key's function:

- (1) Press and hold in the [MHz] key for one second, then rotate the **Main Dial** knob to the Menu Item # corresponding to the key to be assigned a function (**19 PG P1**, **20 PG P2**, or **21 PG AC**).
- (2) Press the [MHz] key momentarily, then rotate the **Main Dial** knob to select the function you wish to assign to the key or button you selected in the previous step. The available choices are:

SQL OFF	Opens the Squelch to allow un-muted reception.
SSRCH	Initiates Smart Search scanning.
STONE	Selects CTCSS or DCS mode and frequency/code.
TSRCH	Initiates scanning for (unknown) CTCSS/DCS tone or code.
T. BURST	Activates 1750 Hz Tone Burst.
RPTR	Selects Repeater Shift direction.

- (3) Press the [MHz] key momentarily to lock in the new setting.
- (4) Rotate the **Main Dial** knob to select another programmable key or button to modify, if desired, from the remaining MENU items. Follow the procedure outlined above.
- (5) Press and hold in the [MHz] key for one second to save the new setting and exit to normal operation.

Note: The function of the [P] key is fixed on the [D/ MR/ HOME] selection.

Resetting the CPU

RESET ALL MENU SETTINGS

To reset all MENU settings to their factory defaults, press the [REV] key and [D/MR] buttons while turning the transceiver on.

CPU MASTER RESET FOR ALL MEMORIES AND MENU SETTINGS

To perform a CPU master reset for all memories *and* MENU settings, press the [A/N], and [D/MR] keys while turning the transceiver on.

Transceiver Cloning

You can transfer all data stored in one transceiver to another set by utilizing the handy “CLONING” feature. This requires a user-constructed cloning cable which connects the **MIC** jacks on the two transceivers as shown below.

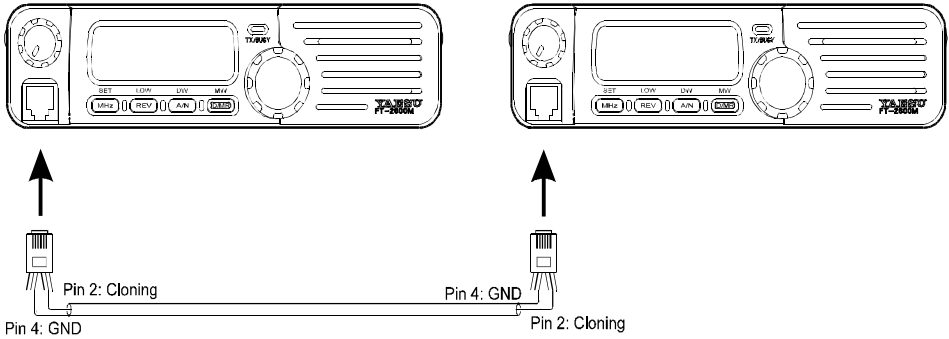

To clone from one transceiver to another, use the following procedure:

- (1) Insert the Clone Cable into the **MIC** jack of each transceiver.
- (2) Turn both transceivers off, then press and hold in the [**A/N**] key on each radio while turning the power on again. The “**CLN**” notation will appear on the display.
- (3) On the “destination” radio, press the [**D/MR**] button.
- (4) Now, on the “source” radio, press the [**MHz**] key.
- (5) If there is a problem during the cloning process, “**CLN ERR**” will be displayed. Check your cable connections and try again.
- (6) If cloning is successful, turn the “destination” radio off. Now turn the “source” radio off.

Remove the clone cable. Channel and operating data for both radios are now identical. They both may be turned on now for normal operation.

Menu System

The FT-2600M's MENU system allows a number of transceiver operating parameters to be custom-configured for your operating requirements.

The MENU is easy to activate and set, using the following procedure:

- ① Press and hold in the [MHz] key for one second.
- ② Rotate the **Main Dial** knob to select the MENU item to be adjusted.
- ③ Press the [MHz] key, then rotate the **Main Dial** knob to adjust the status or value of the MENU item.
- ④ After completing your adjustment, press and hold in the [MHz] key for one second to save the new setting and exit to normal operation.

MENU items are conveniently arranged in alphabetical order.

MENU SELECTION SUMMARY

Item #	Menu Item	Function	Available Values	Default
01	ALPH	Programming an Alpha/Numeric label for a memory	–	–
02	APO	Enable/Disable the Automatic Power Off feature	1 ~ 12 Hours, or OFF	OFF
03	ARTS	Select the ARTS mode	TRX/TX/RX/OFF	OFF
04	BEEP	Enable/Disable the key/button beeper	ON/OFF	ON
05	BELL	Enable/Disable the CTCSS Bell Paging feature	ON/OFF	OFF
06	CHNUM	Enable/Disable the momentary display of the Memory Channel Number	ON/OFF	OFF
07	CWID	Enable/Disable the CW Identifier during ARTS operation	ON/OFF	OFF
08	CWIDN	Program the callsign used by the ARTS CW Identifier	–	YAESU
09	DC IN	Indicate the DC Supply Voltage	–	–
10	DCSN	Setting of the DCS Code #	104 standard DCS codes	023
11	DCSNR	Select "Normal" or "Inverted" DCS coding	TRX NOR/RX REV/TX REV/TRX REV	TRX NOR
12	DIMR	Setting of the front panel display's illumination level	D1/D2/D3/D4/OFF	D1
13	DTMFD	Setting of the DTMF Autodialer Delay Time	50/250/450/750/1000 ms.	450 ms.
14	DTMFS	Setting of the DTMF Autodialer Sending Speed	50/100 ms.	50 ms.
15	DTMFW	Loading of the DTMF Autodialer Memories	–	–
16	LCKTX	Enable/Disable the PTT Lock	ON/OFF	OFF
17	LOCK	Enable/Disable the key/button Lock	ON/OFF	OFF
18	PCKT	Enable/Disable the Microphone during Packet transmission	MIC OFF/MIC ON	MIC OFF
19	PG P1	Programming the function assigned to microphone key P1	SQL OFF/SSRCH/TONE/TSRCH / T-BURST/RPTR	SQL OFF
20	PG P2	Programming the function assigned to microphone key P2	SQL OFF/SSRCH/TONE/TSRCH/T-BURST/RPTR	SSRCH

Menu System

Item #	Menu Item	Function	Available Values	Default
21	PG AC	Programming the function assigned to microphone key ACC	SQL OFF/SSRCH/TONE/TSRCH/T_BURST/RPTR	TSRCH
22	RFSQL	Adjust the RF Squelch threshold level	OFF/S-3/S-5/S-7/S-9/S-FULL	OFF
23	RPTR	Setting of the Repeater Shift Direction	ARS/Shift -/Shift +/OFF	ARS
24	RVRT	Enable/Disable the "Priority Channel Revert" feature	OFF/ON	OFF
25	SCAN	Select the Scan Resume mode	BUSY/TIME	BUSY
26	SHIFT	Set the magnitude of the Repeater Shift	0.00 ~ 99.95 MHz (only ± 4 MHz will work)	600 kHz
27	SKIP	Enable/Disable Skipping of a channel during scanning	SKIP/STOP	STOP
28	SQL	Set the Squelch threshold	OFF/1 ~ 15	8
29	STEP	Setting of the synthesizer steps used in VFO or Memory Tune operation	5/10/12.5/15/20/25/50 kHz per step	5 kHz
30	STONE	Select the CTCSS or DCS mode	OFF, ENC, ENC/DEC, DCS	OFF
31	TONEF	Setting of the CTCSS Tone Frequency	47 standard CTCSS Tones	100.0 Hz
32	TOT	Set the time-out limit for the Time-Out Timer	1 ~ 60 minutes, or OFF	6 minutes
33	W/N	Reduction of the Microphone Gain/Deviation and receiver bandwidth	WIDE/NARROW	WIDE

MENU SELECTION DETAILS

01 ALPH

Function: Programming an Alpha/Numeric label for a memory. See page 32.

02 APO

Function: Enable/Disable the Automatic Power Off feature.

Available Values: 1 ~ 12 Hours, or OFF

Default Setting: OFF

03 ARTS

Function: Select the ARTS mode.

Available Values: TRX/TX/RX/OFF

Default Setting: OFF

04 BEEP

Function: Enable/Disable the key/button beeper.

Available Values: ON/OFF

Default Setting: ON

05 BELL

Function: Enable/Disable the CTCSS Bell Paging feature.

Available Values: ON/OFF

Default Setting: OFF

Menu System

06 CHNUM

Function: Enable/Disable the momentary display of the Memory Channel Number as the **Main Dial** knob is rotated.

Available Values: ON/OFF

Default Setting: OFF

07 CW ID

Function: Enable/Disable the CW Identifier during ARTS operation. The callsign also appears briefly when the radio is turned on.

Available Values: ON/OFF

Default Setting: OFF

08 CW IDN

Function: Program the callsign used by the ARTS CW Identifier.

Default Setting: YAESU

09 DC IN

Function: Indicate the Supply Voltage

10 DCSN

Function: Setting of the DCS Code #.

Available Values: 104 standard DCS codes.

Default Setting: 023

11 DCSNR

Function: Select “Normal” or “Inverted” DCS coding.

Available Values: TRX NOR (Encoder: Normal Decoder: Normal)

RX REV (Encoder: Normal Decoder: Inverted)

TX REV (Encoder: Inverted Decoder: Normal)

TRX REV (Encoder: Inverted Decoder: Inverted)

Default Setting: TRX NOR (Encoder: Normal Decoder: Normal)

12 DIM R

Function: Setting of the front panel display’s illumination level.

Available Values: D1/D2/D3/D4/OFF

Default Setting: D1 (brightest setting)

13 DTM FD

Function: Setting of the DTMF Autodialer Delay Time

Available Values: 50/250/450/750/1000 ms.

Default Setting: 450 ms.

14 DTMFS

Function: Setting of the DTMF Autodialer Sending Speed
Available Values: 50/100 ms.
Default Setting: 50 ms (high speed)

15 DTMFW

Function: Loading of the DTMF Autodialer Memories. See page 30.

16 LCKTX

Function: Enable/Disable the PTT Lock.
Available Values: ON/OFF
Default Setting: OFF

17 LOCK

Function: Enable/Disable the key/button Lock
Available Values: ON/OFF
Default Setting: OFF

18 PCKT

Function: Enable/Disable the Microphone during Packet transmission.
Available Values: MIC ON/MIC OFF
Default Setting: MIC OFF

19 PG P1

Function: Programming the function assigned to microphone key **P1**
Available Values: SQL OFF/SSRCH/TONE/TSRCH/T-BURST/RPTR
Default Setting: SQL OFF (SQUELCH OFF)

20 PG P2

Function: Programming the function assigned to microphone key **P2**
Available Values: SQL OFF/SSRCH/TONE/TSRCH/T-BURST/RPTR
Default Setting: SSRCH (SMART SEARCH)

21 PG AC

Function: Programming the function assigned to microphone key **ACC**
Available Values: SQL OFF/SSRCH/TONE/TSRCH/T-BURST/RPTR
Default Setting: TSRCH (TONE SEARCH)

22 RFSQL

Function: Adjust the RF SQUELCH threshold level.
Available Values: OFF/S-3/S-5/S-7/S-9/S-FULL
Default Setting: OFF

Menu System

23 RPTR

Function: Enable/Disable the Automatic Repeater Shift feature and Setting of the Repeater Shift Direction
Available Values: ARS/SHIFT -/SHIFT +/OFF
Default Setting: ARS

24 RVRT

Function: Enable/Disable the “Priority Channel Revert” feature
Available Values: OFF/ON
Default Setting: OFF

25 SCAN

Function: Select the Scan Resume mode.
Available Values: BUSY/TIME
Default Setting: BUSY

26 SHIFT

Function: Set the magnitude of the Repeater Shift
Available Values: 0.00 ~ 99.95 MHz (only shifts of less than 4 MHz will work)
Default Setting: 600 kHz (depends on transceiver version)

27 SKIP

Function: Enable/Disable Skipping of a channel during scanning.
Available Values: SKIP/STOP
Default Setting: STOP (Stop on busy channel)

28 SQL

Function: Set the SQUELCH threshold
Available Values: OFF/1 ~ 15 (arbitrary scale)
Default Setting: 8

29 STEP

Function: Setting of the synthesizer steps used in VFO/Memory Tune operation.
Available Values: 5/10/12.5/15/20/25/50 kHz per step
Default Setting: 5 kHz (USA version—other countries may be different)

30 TONE

Function: Select the CTCSS or DCS mode.
Available Values: OFF, ENC, ENC/DEC, DCS
Default Setting: OFF

31 TONEF

Function: Setting of the CTCSS Tone Frequency (use MENU #10 FOR DCS)
Available Values: 47 standard CTCSS Tones
Default Setting: 100.0 Hz

32 TOT

Function: Set the time-out limit for the Time-Out Timer
Available Values: 1 ~ 60 minutes, or OFF
Default Setting: 6 minutes

33 W / N

Function: Reduction of the Microphone Gain/Deviation and receiver bandwidth
Available Values: WIDE/NARROW
Default Setting: WIDE (± 5 kHz Deviation, 15 kHz bandwidth)

Menu System

NOTE

This device complies with Part 15 of the FCC rules.
Operation is subject to the condition that this device
does not cause harmful interference.

YAESU

... leading the way.SM

Copyright 2001
VERTEX STANDARD CO., LTD.
All rights reserved.

Printed in Japan

No portion of this manual
may be reproduced
without the permission of
VERTEX STANDARD CO., LTD.



