

YAESU

MICRO COMMANDER

FT-90R

VHF/UHF DUAL BAND FM TRANSCEIVER

Operating Manual

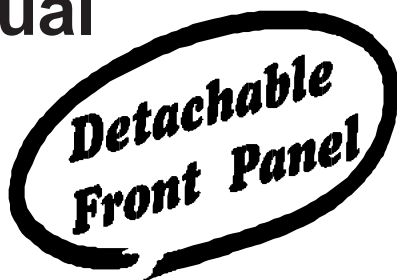

YAESU MUSEN CO., LTD.

1-20-2 Shimomaruko, Ota-Ku, Tokyo 146-8649, Japan

YAESU U.S.A.

17210 Edwards Rd., Cerritos, CA 90703, U.S.A.

YAESU EUROPE B.V.

P.O. Box 75525 1118 ZN, Schiphol, The Netherlands

YAESU UK LTD.

Unit 12, Sun Valley Business Park, Winnall Close
Winchester, Hampshire, SO23 0LB, U.K.

YAESU GERMANY GmbH

Am Kronberger Hang 2, D-65824 Schwalbach, Germany

YAESU HK LTD.

11th Floor Tsim Sha Tsui Centre, 66 Mody Rd.,
Tsim Sha Tsui East, Kowloon, Hong Kong

Contents

Introduction	1	CTCSS (Cotinuuous Tone Coded Squelch System) ...	28
Specifications.....	2	DCS (Digital Code Squelch)	28
Accessories & Options	3	DCS Tone Search Scanning	30
Front Panel Controls & Switches.....	4	CTCSS Bell Paging	30
Right Side Connector	6	1750 Hz Tone Calling (European Versions) ...	30
Rear Panel Connections	7	DTMF Tone Generation.....	31
Microphone Switches	8	DTMF Autodialer Operation	31
Installation	10	MIC Gain Control	32
Preliminary Inspection	10	Memory System Operation	34
Installation Tips	10	Memory Storage	34
Safety Information	11	Recalling Memories	34
Antenna Considerations	12	Direct Keypad Memory Recall	35
Mobile Installation	14	Home Channel Memories	35
Transceiver Installation	14	Programming the Home Channel(s)....	35
Mobile Power Connections.....	15	Naming and Displaying Memories	36
Mobile Speakers	15	Loading a Memory into the VFO .	36
Base Station Installation	16	Memory Only Mode	37
AC Power Supplies	16	Erasing Memories	37
Packet Radio Terminal Node Controller (TNC) ...	16	Scanning Features	38
Operation	18	Scanning Operation	38
Basic Operation/Reception.....	18	Scan-Resume Options	38
Turning the Power On/Off.....	18	Memory Skip Scanning	39
Supply Voltage Display	18	Temporary Memory Skip	39
Adjusting the Volume and Squelch	18	Programmable Band-Scan Limits .	39
RF Squelch.....	18	Smart Search Operation	40
Display Options	19	Priority Channel Monitoring	41
Lock Feature	20	ARTS:Auto Range Transpond System ...	43
Frequency Navigation [“DIAL” (VFO) Mode] ...	20	ARTS Modes	44
Main Dial Tuning	20	CW ID (Morse Identifier) Set up .	44
Direct Keypad Frequency Entry	21	Packet Operation	45
AM Mode Activation	21	Miscellaneous Settings	46
Channel Step Selection	22	Time-Out Timer	46
Key pad Beeper	22	Automatic Power-Off	46
Display Brightness	23	Cooling Fan Control	47
Display Contrast.....	23	Programming the Front Panel/ Microphone Key Functions	47
Transmission	24	DCS Code Inversion	48
Power Output Setting.....	24	Demonstration Mode	49
PTT Locking	24	Programming the DemoMessage	50
Repeater Splits	25	Resetting the CPU	50
Standard Repeater Shift	25	Transceiver Cloning	51
Automatic Repeater Shift	26	Menu System	52
Separate Transmit Frequency Memories ...	27	Menu Selection Details	53
Tone Squelch Systems	28		

Introduction

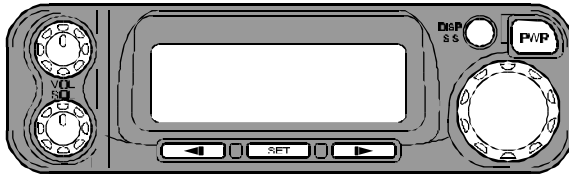

The **FT-90R** is an ultra-compact, high-power dual-band FM mobile transceiver providing high performance on the Amateur 144 MHz and 430 MHz bands.

The **FT-90R** represents an engineering breakthrough in electro-mechanical construction, providing 50 Watts output on 144 MHz and 35 Watts output on 430 MHz from an enclosure measuring only 100 x 30 x 138 mm (3.9" x 1.2" x 5.4") WHD. Despite its incredibly small size, the **FT-90R** is a full-featured rig, providing extended receive coverage, CTCSS and DCS Tone Squelch systems, and Yaesu's exclusive **ARTS™** (Auto-Range Transponder System) and **Smart Search™** features for today's active operator.

We recommend that you read this manual in its entirety, so as to get the most out of your new **FT-90R MICRO MOBILE!**

Specifications

General

Frequency Ranges:	RX: 100~230 MHz, 300~530 MHz, 810~999.975 MHz* TX: 144-146 MHz or 144-148 MHz (144 MHz) 430-440 MHz or 430-450 MHz (430 MHz)
Channel Steps:	5/10/12.5/15/20/25/50 kHz
Emission Type:	F3, F2, F1
Antenna Impedance:	50 Ω , Unbalanced (Antenna Duplexer built-in)
Frequency Stability:	± 5 ppm (-5 $^{\circ}\text{C}$ to $+60$ $^{\circ}\text{C}$)
Operating Temp. Range:	-20 $^{\circ}\text{C}$ to $+60$ $^{\circ}\text{C}$
Supply Voltage:	DC 13.8 V ± 15 %, Negative Ground
Current Consumption (approx):	350 mA (Receive, Squelched) 9.5 A (Tx, 144 MHz) 8.5 A (Tx, 430 MHz)
Case Size:	100(W) x 30(H) x 138(D) mm (w/o knobs)
Weight:	640 g (1.41 lb.)

* Cellular and digital telephone frequencies are blocked and cannot be restored.

Transmitter

RF Power Output:	50/20/10/5 W (144 MHz), 35/20/10/5 W (430 MHz)
Modulation Type:	Variable Reactance
Maximum Deviation:	± 5 kHz
Spurious Emissions:	At least 60 dB below fundamental
Microphone Impedance:	2 k Ω

Receiver

Circuit Type:	Double-Conversion Superheterodyne
Intermediate Frequencies:	45.05 MHz and 455 kHz
Sensitivity:	0.18 μV @ 12 dB SINAD
Selectivity:	12 kHz/24 kHz (-6 dB/ -60 dB)
AF Output:	2 W @ 8 Ω for 10 % THD
AF Output Impedance:	4 Ω – 16 Ω

Specifications are subject to change without notice or obligation.

Specifications guaranteed only within the 2m and 70cm amateur bands.

Frequency range may vary according to local requirements and regulations.

Accessories & Options

SUPPLIED ACCESSORIES

Microphone (See list below)
Mobile Mounting Bracket **MMB-68**
DC Power Cord w/Fuse (Part # **T9021715**)
Spare 15A Fuse

OPTIONAL ACCESSORIES

MH-36_{A6J} DTMF Microphone
MH-42_{A6J} Hand Microphone
YSK-90 Separation Kit
SP-7 External Loudspeaker
MEK-2 Microphone Extension Kit

Availability of accessories may vary. Some accessories are supplied as standard per local requirements, while others may be unavailable in some regions. Consult your Yaesu dealer for details regarding these and any newly available options. Connection of any non- Yaesu-approved accessory, should it cause damage, may void the Limited Warranty on this apparatus.

Front Panel Controls & Switches

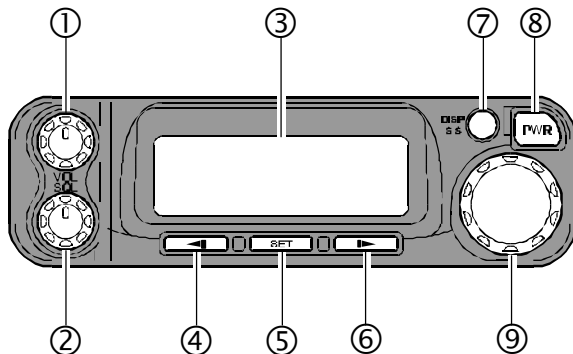

① VOL Knob

This control adjusts the volume level of the receiver's audio. Clockwise rotation increases the volume level.

② SQL Knob

This control sets the threshold level at which received signals (or noise) will open the squelch. It should be advanced clockwise just to the point where the noise is silenced, so as to provide the best sensitivity to weak signals.

③ DISPLAY

The display consists of segmented digits which indicate operating frequency, status of functions, alpha/numeric memory labels, and MENU functions.

④ Key

During split-frequency operation, such as through a repeater, this key reverses the transmit and receive frequencies. The function of this key can also be changed to another function via MENU #22 (see page 56).

⑤ Key

This key selects the **MAIN DIAL's** band of operation: VHF or UHF.

During Memory operation, this key selects display of the *channel frequency* or the *Alpha/Numeric "name"* of the channel.

Press and hold in this key for one second to activate the "Set" (MENU) Mode.

⑥ Key

This key toggles repeater shift: "Automatic Repeater Shift" (ARS), "Plus" shift (+), "Minus" shift (-), or "Simplex." The function of this key can also be changed to another function via MENU #23 (see page 56).

Front Panel Controls & Switches

⑦ **Button**

This button selects the items to be displayed on the bottom line of the LCD:

- Functions of the keys below the display;
- DC Voltage; or
- Frequency Control Mode.

Press and hold in this button for one second to activate the **SMART SEARCH™** feature.

⑧ **PWR Switch**

This is the main “ON/OFF” switch for the transceiver.

⑨ **MAIN DIAL Knob**

This 20-position detented rotary switch is the main tuning dial for the transceiver. It is used for most tuning, memory selection, and function setting tasks on the transceiver.

Right Side Connector

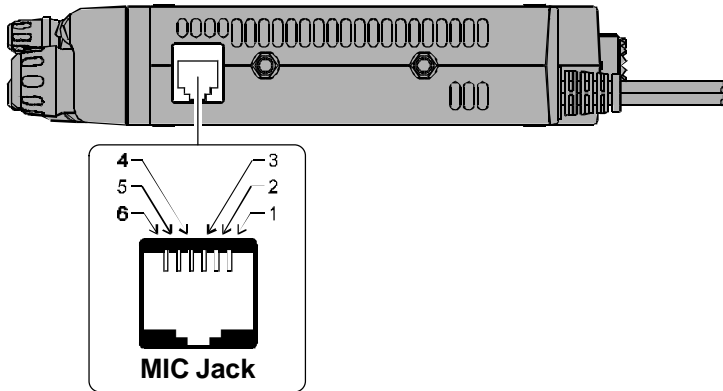

MIC Jack

This 6-pin modular jack accepts transmit audio, and provides 9600 bps data for Packet Operation.

Pin 1: SW 2 (multi-function switching)

Pin 2: 9600 bps Packet Data Output

(Impedance:10 k Ω Maximum Output:500 mV pp)

Pin 3: +9V

Pin 4: GND

Pin 5: Microphone Input

Pin 6: SW 1 (multi-function switching)

Rear Panel Connections

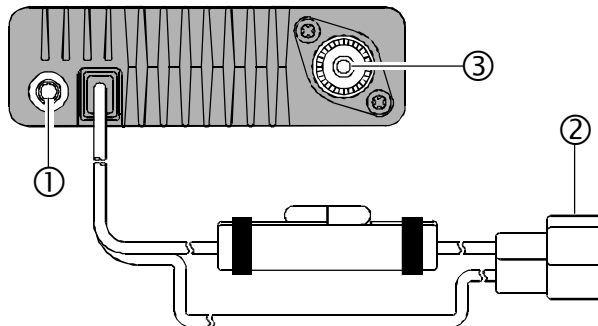

① EXT SP Jack

This 2-conductor, 3.5-mm mini phone jack provides receiver audio output for an optional external speaker. The audio impedance is 8Ω , and the level varies according to the setting of the front panel's **VOL** control. Inserting a plug into this jack disables audio from the transceiver's internal speaker. This jack may also be used as a source of receiver audio during 1200 bps Packet operation.

② 13.8 VDC Cable Pigtail w/Fuse

This is the DC power supply connection for the transceiver.

③ ANTENNA Connector

Connect a dual-band antenna's 50Ω cable to this M-type (SO-239) coaxial connector (European versions are equipped with a Type-N connector). Be certain to use the proper type of plug for connection of the coaxial cable.

Microphone Switches

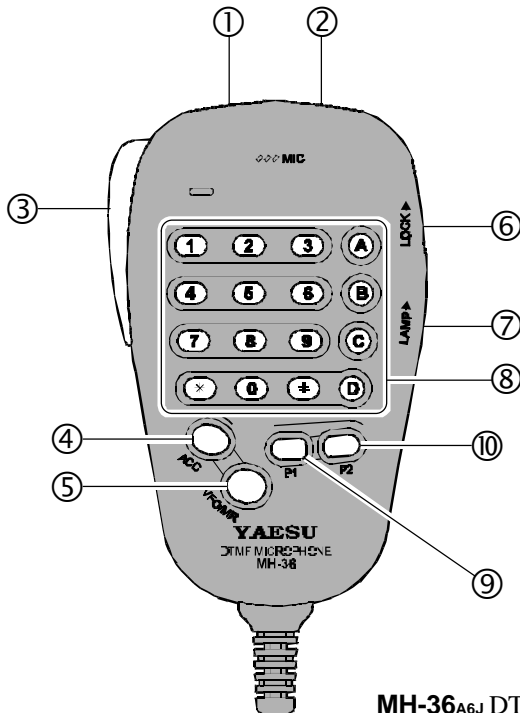

MH-36A6J DTMF Microphone

① **DWN Button**

Press this button to tune toward a lower VFO frequency (or lower Memory Channel number).

Press and hold this button in for one second to start scanning toward a lower VFO frequency (or lower Memory Channel number).

② **UP Button**

Press this button to tune toward a higher VFO frequency (or higher Memory Channel number).

Press and hold this button in for one second to start scanning toward a higher VFO frequency (or higher Memory Channel number).

③ **PTT Switch**

Press this switch to transmit, and release it to receive.

④ **ACC Button**

Press this button to activate the “Priority Channel” monitoring system.

In the European version, press this button to transmit a 1750 Hz Burst Tone for repeater access.

Microphone Switches

⑤ VFO/MR Button

This button switches operation between the VFO and Memory modes.

⑥ LOCK Switch

Slide this switch upward to lock (disable) the microphone's buttons.

⑦ LAMP Switch

Slide this switch upward to activate the keypad's illumination, for easier viewing at night.

⑧ KEYPAD (MH-36A6J only)

These 16 keys generate DTMF tones during transmission.

In the receive mode, these 16 keys can be used for direct frequency entry and/or direct numeric recall of Memory channels.

⑨ P1 Button

This button selects the Tone Squelch type: CTCSS, DCS, BELL, or Off (no tone).

⑩ P2 Button

This key selects the transmitter power output level:

HIGH, **MID1** (Medium 1), **MID2** (Medium 2), or **LOW**.

Note: The functions of the **ACC**, **P1**, and **P2** buttons can be changed via the MENU system. See page 47.

MH-42A6J Hand Microphone

The **MH-42A6J** is similar to the **MH-36A6J**, but the **MH-42A6J** does not include a DTMF keypad.

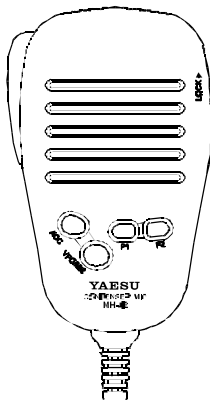

Installation

This chapter describes the installation procedure for integrating the **FT-90R** into a typical amateur radio station. It is presumed that you possess technical knowledge and conceptual understanding consistent with your status as a licensed radio amateur. Please take some extra time to make certain that the important safety and technical requirements detailed in this chapter are followed closely.

Preliminary Inspection

Inspect the transceiver visually immediately upon opening the packing carton. Confirm that all controls and switches work freely, and inspect the cabinet for any damage. Gently shake the transceiver to verify that no internal components have been shaken loose due to rough handling during shipping.

If any evidence of damage is discovered, document it thoroughly and contact the shipping company (or your local dealer, if the unit was purchased over-the-counter) so as to get instructions regarding the prompt resolution of the damage situation. Be certain to save the shipping carton, especially if there are any punctures or other evidence of damage incurred during shipping; if it is necessary to return the unit for service or replacement, use the original packing materials but put the entire package inside another packing carton, so as to preserve the evidence of shipping damage for insurance purposes.

Installation Tips

To ensure long life of the components, be certain to provide adequate ventilation around the cabinet of the **FT-90R**.

Do not install the transceiver on top of another heat-generating device (such as a power supply or amplifier), and do not place equipment, books, or papers on top of the **FT-90R**. Avoid heating vents and window locations that could expose the transceiver to excessive direct sunlight, especially in hot climates. The **FT-90R** should not be used in an environment where the ambient temperature exceeds +60° C (140° F).

Safety Information

The **FT-90R** is an electrical apparatus, as well as a generator of RF (Radio Frequency) energy, and you should exercise all safety precautions as are appropriate for this type of device. These safety tips apply to *any* device installed in a well-designed amateur radio station.

- 0 Do not allow unsupervised children to play in the vicinity of your transceiver or antenna installation.
- 0 Be certain to wrap any wire or cable splices thoroughly with insulating electrical tape, to prevent short circuits.
- 0 Do not route cables or wires through door jambs or other locations where, through wear and tear, they may become frayed and shorted to ground or to each other.
- 0 Do not allow anyone to stand in front of a directional antenna while you are transmitting into that antenna, especially on UHF. Do not install a directional antenna in any location where humans or pets may be walking in the main directional lobe of the antenna's radiation pattern.
- 0 In mobile installations, it is preferable to mount your antenna on top of the roof of the vehicle, if feasible, so as to utilize the car body as a counterpoise for the antenna and raise the radiation pattern as far away from passengers as possible.
- 0 During vehicular operation when stopped (in a parking lot, for example), make it a practice to switch to the "**MID2**" or "**LOW**" power options if there are people walking nearby.

Never wear dual-earmuff headphones while driving a vehicle.

Installation

Antenna Considerations

The **FT-90R** is designed for use with antennas presenting an impedance of near 50 Ω at all operating frequencies. The antenna (or a 50 Ω dummy load) should be connected whenever the transceiver is turned on, to avoid damage that could otherwise result if transmission occurs accidentally without an antenna.

Ensure that your antenna is designed to handle 50 Watts of transmitter power. Some magnetic-mount mobile antennas, designed for use with hand-held transceivers, may not be capable of this power level. Consult the antenna manufacturer's specification sheet for details.

Most all FM work is performed using vertical polarization. When installing a directional antenna such as a Yagi or Quad, be certain to orient it so as to produce vertical polarization, unless you are engaged in a special operating situation where horizontal polarization is used.

Note that this transceiver is designed with wide frequency coverage in the VHF and UHF spectra. For general listening, you may wish to have a broadband antenna such as a discone available, because a directional antenna such as a Yagi will have degraded performance outside the Amateur bands.

Excellent reference texts and computer software are available for the design and optimization of VHF and UHF antennas. Your dealer should be able to assist you with all aspects of your antenna installation requirements.

Use high-quality 50 Ω coaxial cable for the lead-in to your **FT-90R** transceiver. All efforts at providing an efficient antenna system will be wasted if poor quality, lossy coaxial cable is used. Losses in coaxial lines increase as the frequency increases, so an 8-meter-long (25') coaxial line with only ½ dB of loss at 28 MHz may have a loss of 2 dB or more at 440 MHz; choose your coaxial cable carefully based on the installation location (mobile vs. base) and the overall length of the cable required (for *very short* runs of cable in a mobile installation, the smaller, more flexible cable types may be acceptable).

Installation

For reference, the chart below shows approximate loss figures for typically-available coaxial cables frequently used in VHF/UHF installations.

Loss in dB per 30 m (100 feet) for Selected 50Ω Coaxial Cables
(Assumes 50W Input/Output Terminations)

Cable Type	Loss: 144 MHz	Loss: 440 MHz
RG-58A	6.5	13
RG-58 Foam	4.7	8.5
RG-8A/-213	3.0	5.7
RG-8 Foam	2.0	3.7
Belden® 9913	1.5	2.7
1/2" Hardline	1.0	1.8
7/8" Hardline	0.7	1.3

Loss figures are approximate; consult cable manufacturers' catalogs for complete specifications.

In outdoor installations, be certain to weatherproof all connectors thoroughly, as water entering a coaxial cable will cause losses to escalate rapidly, thus diminishing your communications effectiveness. The use of the shortest possible length of the highest quality coaxial cable that fits within your budget will ensure the best performance from your **FT-90R**.

Installation

Mobile Installation

The **FT-90R** must only be installed in vehicles having a *negative ground* electrical system. Mount the transceiver where the display, controls, and microphone are easily accessible, using the supplied MMB-68 mounting bracket. The transceiver may be installed in any position, but should not be positioned near a heating vent nor anywhere where it might interfere with driving (either visually or mechanically). Make sure to provide plenty of space at the rear of the transceiver so that air can flow freely through the heatsink. Refer to the diagrams showing proper installation procedures.

Transceiver Installation

- Choose a mounting location with sufficient clearance for the transceiver, plus space for ventilation around the heat sink.

Using the mounting bracket as a template for the mounting holes, use a 4.8 mm (3/16") bit to drill the mounting holes, and secure the mounting bracket with the supplied screws, washers, and nuts (see diagram).

- Position the transceiver in the bracket so that the holes in the side are aligned with those in the bracket, and bolt the transceiver into place using the supplied short screws and flat washers.

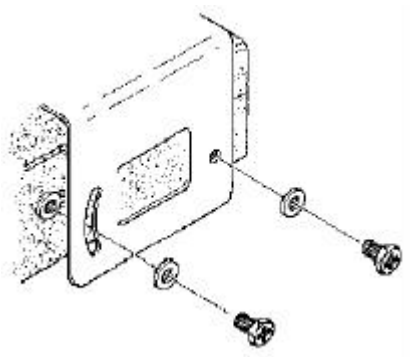
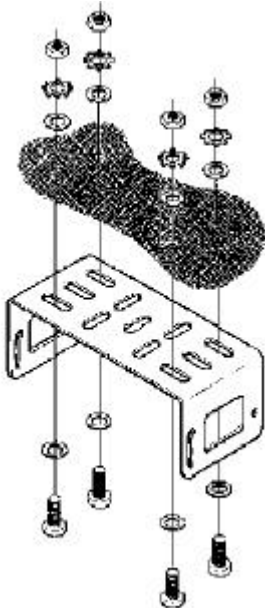

Mobile Power Connections

To minimize voltage drop and avoid blowing the vehicle's fuses, connect the supplied DC power cable directly to the battery terminals. *Do not attempt to defeat or bypass the DC cable's fuse—it is there to protect you, your transceiver, and your vehicle's electrical system.*

Warning!

Never apply AC power to the power cable of the FT-90R, nor DC voltage greater than 15.8 Volts. When replacing the fuse, only use a 15-A fast-blow type. Failure to observe these safety precautions will void the Limited Warranty on this product.

- Before connecting the transceiver, check the voltage at the battery terminals while revving the engine. If the voltage exceeds 15 Volts, adjust the vehicle's voltage regulator before proceeding with installation.
- Connect the **RED** power cable lead to the **POSITIVE (+)** battery terminal, and the **BLACK** power cable lead to the **NEGATIVE (-)** terminal. If you need to extend the power cable, use #12 AWG or larger insulated, stranded copper wire. Solder the splice connections carefully, and wrap the connections thoroughly with insulating electrical tape.
- Before connecting the cable to the transceiver, verify the voltage and polarity of the voltage *at the transceiver end of the DC cable* using a DC voltmeter. Now connect the transceiver to the DC cable.

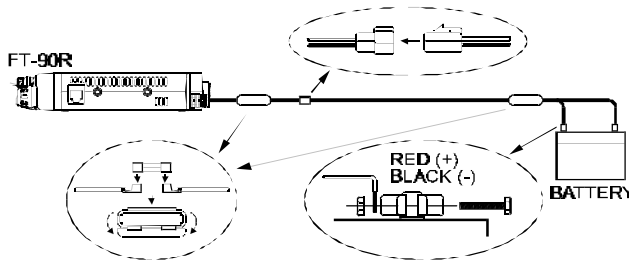

Mobile Speakers

The optional SP-7 or MLS-100 External Speakers include their own swivel-type mounting brackets, and are available from your Yaesu dealer.

Other external speakers may be used with the **FT-90R**, if they present the specified 4-16 Ω impedance and are capable of handling the 2 Watts of audio output supplied by the **FT-90R**.

Installation

Base Station Installation

The **FT-90R** is ideal for base station use as well as in mobile installations. The **FT-90R** is specifically designed to integrate into your station easily, using the information to follow as a reference.

AC Power Supplies

Operation of the **FT-90R** from an AC line *requires* a power source capable of providing at least 10 Amps continuously at 13.8 Volts DC. The FP-1023A, FP-1025A, and FP-1030A AC Power Supplies are available from your Yaesu dealer to satisfy these requirements. Other well-regulated power supplies may be used, as well, if they meet the above voltage and current specifications.

Use the DC power cable supplied with your transceiver for making power connections to the power supply. Connect the **RED** power cable lead to the **POSITIVE (+)** power supply terminal, and connect the **BLACK** power cable lead to the **NEGATIVE (-)** power supply terminal.

Packet Radio Terminal Node Controller (TNC)



The extremely compact size of the **FT-90R** does not allow the inclusion of a dedicated packet interfacing jack. However, all connections required for either 1200 bps or 9600 bps packet operation are provided, either on the front or rear panel.

1200 BPS PACKET SETUP

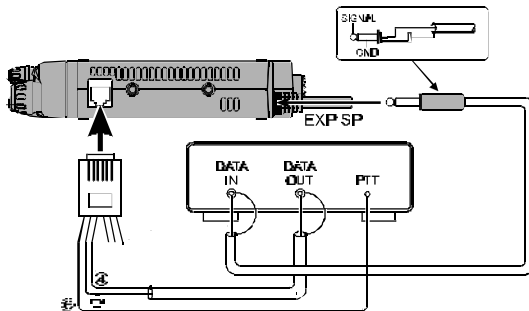
1. Connect the TNC's "Data In" (RX Audio) line to the **EXT SP** jack on the rear panel of the **FT-90R**.
2. Connect the TNC's Ground, "Data Out" (TX Audio), and PTT lines to Pins ④, ⑤, and ⑥ of the right side **MIC** jack (see illustration).







3. Press and hold in the **SET** key for one second to enter the "Set" (MENU) mode.

4. Rotate the **MAIN DIAL** knob to select “2 1 P C K T” on the display; this item allows setting of the Packet baud rate.
5. If “1 2 0 0 b p s” does *not* appear on the display, press the  key once to change the baud rate from 9600 bps to 1200 bps. Note that, if you are storing this channel into a memory, the baud rate will be memorized along with the frequency data.
6. Press and hold in the  key for 1.5 second to save the new setting and exit to normal operation.
7. The RX Audio level sent to the TNC from the radio may be adjusted using the front panel’s **VOL** control. The TX Audio level applied to the **FT-90R** from the TNC should be adjusted at the TNC side.

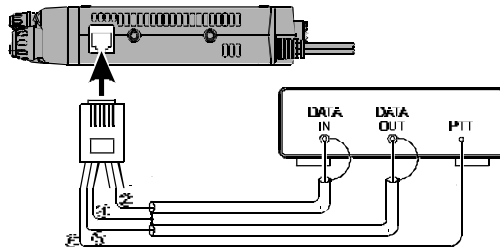
9600 BPS PACKET SETUP

1. Connect the TNC’s “Data In” (RX Audio), Ground, “Data Out” (TX Audio) and PTT lines to Pins ②, ④, ⑤ and ⑥ of the right side **MIC** jack (see illustration).



2. Press and hold in the  key for one second to enter the “Set” (MENU) mode.
3. Rotate the **MAIN DIAL** knob to select “2 1 P C K T” on the display; this item allows setting of the Packet baud rate.
4. If “9 6 0 0 b p s” does *not* appear on the display, press the  key once to change the baud rate from 1200 bps to 9600 bps. Note that, if you are storing this channel into a memory, the baud rate will be memorized along with the frequency data.
5. Press and hold in the  key for 1.5 second to save the new setting and exit to normal operation.
6. The RX Audio level sent to the TNC from the radio is fixed at a level compatible with most all commonly-available TNC’s on the market. The TX Data level applied to the **FT-90R** from the TNC should be adjusted at the TNC side. The output deviation level is critical, and usually should be set to ± 2.75 kHz of deviation (tolerance: ± 0.25 kHz).

Operation

Basic Operation/Reception

Turning the Power On/Off

Press the **PWR** switch momentarily to turn the radio on.
To turn the radio off, press and hold in the **PWR** switch for ½ second.

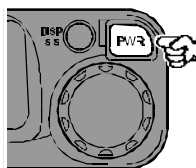

Supply Voltage Display

When you turn on the radio, the current DC supply voltage is indicated on the display for one second. After this interval, the display will resume its normal indication of the operating frequency.

To view the supply voltage at any time during operation, press the **DSP 5.5** button (repeatedly, if necessary) until you see the current DC supply voltage indicated on the display.

1 4 5 0 0 0
1 3 . 8 V

Adjusting the Volume and Squelch

At first, set the **SQL** control fully counter-clockwise. Now you may rotate the **VOL** control clockwise to adjust the receiver volume for a comfortable listening level, using the background noise as a reference.

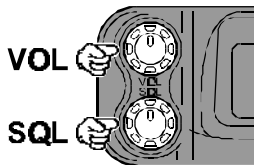

To set the squelch, turn the **SQL** control clockwise a slightly past the point where the background band noise is muted. This is the point of best sensitivity to weak signals, and we recommend that you not rotate the **VOL** control very much past the point where the background noise is just silenced.

RF Squelch

A special “RF SQUELCH” feature is provided on this radio. This feature allows you to set the squelch so that only signals exceeding a prescribed S-meter level will open the squelch.

To set up the RF SQUELCH circuit for operation, use the following procedure:

1. Press and hold the **SET** key for one second, then rotate the **MAIN DIAL** knob to select “27 RfSql.”
2. Press the **▶** key to select the desired signal strength level for the squelch threshold (**S-3**, **S-5**, or **S-FULL**). The default setting is **OFF**.
3. Press and hold in the **SET** key for 1.5 second to save the new setting and exit to normal operation.
4. Finally, carefully advance the **SQL** control to the point where the background band noise is just silenced.



This adjustment can be set independently for each band. See the instructions regarding band change below.



Display Options

The area below the frequency display provides three different information windows:





- **VOLTAGE DISPLAY** Indication of DC supply voltage.
- **CONTROL MODE** Display of the current frequency control mode:
 - V** VFO
 - M** Memory
 - m** Memory Only Mode
 - P** Priority Channel Scanning
 - p** Programmable Memory Scan (Band Limits)
- **KEY FUNCTIONS** Indication of the functions of the keys below the display.

The default values are:

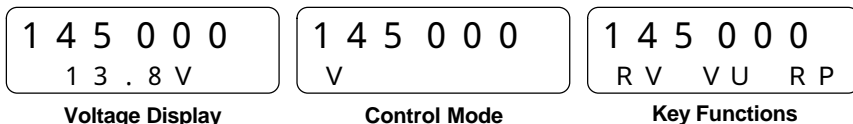
-  **RV** (REVERSE)
-  **VU** (VHF/UHF) in VFO Mode
(FREQUENCY/ALPHA) in Memory Mode
-  **RP** (RPTR)

To change the display mode, just press the  key momentarily. Each press of the  key toggles the display to the next option:



The functions of the  and  keys in the “KEY FUNCTION” mode can be changed using MENU items #22 () and #23 (). See page 56 for details.

Important Note

The operating instructions in this manual are based on the **default** settings of the front panel and microphone keys.



If you move a function to a different key using the MENU, make notes in the manual as to which key has been assigned that function.

Operation

Lock Feature

If nothing happens when you press a button, the panel may be “locked” (this feature is normally used to prevent accidental changes to the settings of controls and switches).

To unlock the front panel, use the following procedure:

1. Press and hold in the  key for one second, then rotate the **MAIN DIAL** knob to select “20LOCK.”
2. Press the  key to change the display to “OFF.”
3. Press and hold in the  key for 1.5 second to save the new setting and exit to normal operation.

To re-lock the front panel, select “ON” in step 2 above.

Changing Bands

Press the  key (momentarily) to change the operating band between VHF and UHF.

Frequency Navigation [“DIAL” (VFO) Mode]

MAIN DIAL Tuning

This mode is used for choosing a frequency within the selected band of operation. In the “VFO” mode, the **MAIN DIAL** knob and microphone [UP] and [DWN] buttons allow the Variable Frequency Oscillator (VFO) to tune in the selected step size (or in 1 or 10 MHz steps). When *scanning* in the VFO mode, the same step sizes are used as in manual tuning.

To select the 1 MHz range in which you wish to operate, *press* the **MAIN DIAL** knob momentarily, then *rotate* the **MAIN DIAL** knob. All three “MHz” digits of the frequency display will blink while “1 MHz Tuning” is enabled. Press the **MAIN DIAL** knob again (momentarily), then rotate the **MAIN DIAL** knob to tune around the selected band in the normal synthesizer steps.

To select the 10 MHz range in which you wish to operate, *press and hold in* the **MAIN DIAL** knob for ½ second, then rotate the **MAIN DIAL** knob. The 10 MHz and 100 MHz digits of the frequency display will blink while “10 MHz Tuning” is enabled. Press and hold in the **MAIN DIAL** knob again (for more than ½ second); you will now be tuning in 1 MHz steps. Press the **MAIN DIAL** knob once more, you may now rotate the **MAIN DIAL** knob to tune around the band in the normal synthesizer steps.

Here's an example of how to make a *major* frequency excursion:

1. First press and hold in the **MAIN DIAL** knob for ½ second. You will observe that the 100 MHz and 10 MHz display digits are blinking, as you have now selected the “10 MHz Step” frequency selection mode.
2. Rotate the **MAIN DIAL** knob to select a 10 MHz multiple nearest the desired operating frequency. Once you have reached the nearest 10 MHz step, press the **MAIN DIAL** knob momentarily to put the transceiver in the “1 MHz step” tuning mode.
3. Now rotate the **MAIN DIAL** knob to select the desired 1 MHz segment, then press the **MAIN DIAL** knob momentarily again. The transceiver will now be ready for tuning the band in its regular tuning steps.

Direct Keypad Frequency Entry (requires MH-36A6J)

The desired operating frequency may be entered directly from the microphone's keypad.

To enter a frequency from the keypad, just press the numbered digits on the keypad in the proper sequence. To round all digits to the *right* of the current digit to “0,” press the [#] key.

Examples:



To enter 146.520 MHz, press      .

To enter 433.000 MHz, press    .

AM Mode Activation

This radio automatically selects the AM mode whenever the (VHF) frequency is set anywhere within the range 110-136 MHz, so as to allow monitoring of aircraft communications in this range.

You may have some reason, however, to want to select the FM mode within this frequency range, or to change it back to AM from the FM mode. If so, use the following procedure:





1. Press and hold in the  key for one second, then rotate the **MAIN DIAL** knob to select “3 8 A M.”
2. Press the  key to select “INHIBIT.” This setting inhibits the activation of the AM mode. The other settings are “A M” (forcing the mode to be “AM”) and “A U T O” (automatic mode selection, per the above description).
3. Press and hold in the  key for 1.5 second to save the new setting and exit to normal operation.

Operation

Channel Step Selection

Tuning steps are factory preset to default increments which are appropriate for the country to which this radio is exported. Different steps may be preset for VHF and UHF, as well, if appropriate for your area. For example, on the U.S. version, the default steps for VHF are 5 kHz, while on UHF the default steps are 25 kHz.



To change to another step size, use the following procedure:

1. First select the operating band (VHF or UHF) on which you wish to modify the tuning steps. Press the  key momentarily to change bands, if needed.
2. Press and hold in the  key for one second, then rotate the **MAIN DIAL** knob to select “32STEP.”
3. Press either the  or  key to select the desired step size. The available steps are 5.0/10.0/12.5/15.0/20.0/25.0/50.0 (kHz/step).
4. Press and hold in the  key for 1.5 second to save the new setting and exit to normal operation.

Keypad Beeper

The key/button beeper provides useful audible feedback whenever a button is pressed. Each key and button has a different beep pitch, and each function has a unique beep combination.

If you want to turn the beeper off (or back on again):





1. Press and hold in the  key for one second, then rotate the **MAIN DIAL** knob to select “06BEEP.”
2. Press the  key to change the display to “OFF.”
3. Press and hold in the  key for 1.5 second to save the new setting and exit to normal operation.

The volume level of the beeper is fixed, and is not affected by the setting of the Volume control.

Display Brightness





The light blue display illumination has been specially engineered to provide high visibility over a wide range of ambient lighting situations.

The brightness of the display is manually adjustable, using the following procedure:

1. Press and hold in the  key for one second, then rotate the **MAIN DIAL** knob to select “10D Dim.”
2. Press either the  or  key to select a comfortable brightness level (d1, d2, d3, d4, or OFF).
3. Press and hold in the  key for 1.5 second to save the new setting and exit to normal operation.

Display Contrast

The contrast of the display is manually adjustable in this radio, as well, using the following procedure:

1. Press and hold in the  key for one second, then rotate the **MAIN DIAL** knob to select “09D Con.”
2. Press either the  or  key to select a comfortable contrast level (0 ~ 12).
3. Press and hold in the  key for 1.5 second to save the new setting and exit to normal operation.

Operation

Transmission

To transmit, simply close the **PTT** (Push To Talk) switch on the microphone when the frequency is clear. Hold the microphone approximately 25 mm (1”) from your mouth, and speak into the microphone in a normal voice level. When your transmission is complete, release the **PTT** switch; the transceiver will revert to the receive mode.

Power Output Setting

Four power output levels are available on this transceiver: 5 watts (**LOW**), 10 watts (**MID 2**), 20 watts (**MID 1**) and 50 watts (**VHF**) or 35 watts (**UHF**) on **HIGH**.



To change the power level, press the front panel’s **[P2]** button on the microphone. Each time you press the **[P2]** button, the new power level will be displayed for a few seconds, then the regular display mode will reappear.

The power level may be stored in a memory register, if desired.

PTT Locking

The **PTT** circuitry may be locked out, so as to prevent unauthorized or otherwise undesired transmission.

To lock out the PTT and prevent transmission as following:

1. Press and hold in the  key for one second, then rotate the **MAIN DIAL** knob to select “**19 LckTx.**”
2. Press the  key to select the desired locking mode:
 - BANDA:** PTT disabled on VHF only;
 - BANDB:** PTT disabled on UHF only; or
 - BOTH:** PTT disabled on both the VHF and UHF bands.
3. Press and hold in the  key for 1.5 second to save the new setting and exit to normal operation.



To cancel the PTT lockout feature, select “**OFF**” in step 2 above.

Repeater Splits

This transceiver offers three methods of setting up split frequency operation on repeaters:

- Manual selection of preset repeater shifts;
- Automatic Repeater Shift (ARS), providing automatic activation of repeater shifts during designated repeater frequency subbands; and
- Independently stored transmit and receive frequencies (typically not corresponding to established repeater frequency shifts).





Standard Repeater Shift

To activate the repeater shift, just press the  key. The available choices will appear in the following order with each press of the  key:

(ARS) “Automatic Repeater Shift” \Rightarrow (-) “Minus” shift \Rightarrow (+) “Plus” shift \Rightarrow (OFF) “Simplex” \Rightarrow (ARS)...

With repeater shift activated, you can temporarily reverse the transmit and receive frequencies by pressing the  key. Use this feature to display the repeater uplink frequency *without transmitting*, and to check the strength of signals on the uplink frequency (so as to determine whether or not a particular station is within “Simplex” range, for example). The “r” icon will appear at the bottom left side of the display while “Reverse” shift is activated.

The default repeater offsets are fixed at 600 kHz on the VHF band and 1.6/5.0/7.6 MHz on the UHF band (depending on your country’s requirements) from the factory. You can change the standard offset, if needed, using the following procedure:

1. Set the transceiver to the band on which you wish to change the standard repeater shift (VHF or UHF).
2. Press and hold in the  key for one second, then rotate the **MAIN DIAL** knob to select “30Shift.”
3. Press either the  or  key to set the desired offset. Note that the resolution of the “standard” repeater shift is to the nearest 50 kHz multiple.
4. Press and hold in the  key for 1.5 second to save the new setting and exit to normal operation.
5. If you wish to change the standard offset on the other band, repeat steps 1 through 4 above.

Operation

Automatic Repeater Shift

The ARS (Automatic Repeater Shift) feature in the **FT-90R** allows easy and convenient repeater operation by automatically activating the repeater shift function whenever you tune to a standard repeater sub-band. The ARS function is preset at the factory to conform to the bandplans for the country to which it is exported.

The ARS function is *enabled* at the factory. To *disable* it:

Press the  key, as many times as necessary, so that “OFF” appears on the display.

To re-enable ARS:

Press the  key, as needed, to set the display to “ARS.”

ARS operation is independent on the VHF and UHF channels. Therefore, you are allowed to have ARS enabled on VHF but *disabled* on UHF, if you like.

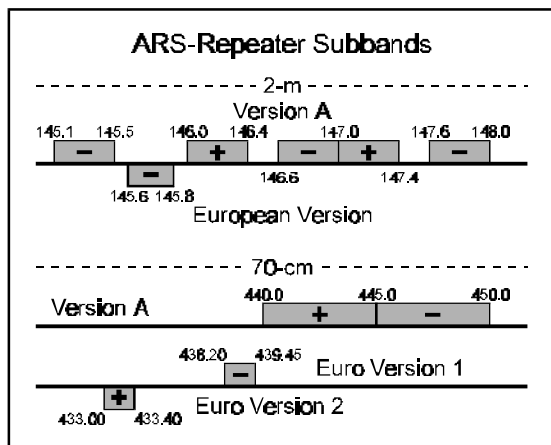

Separate Transmit Frequency Memories

All memory channels can store independent receive and transmit frequencies, to accommodate occasional “odd splits” (non-standard offsets) with greater frequency resolution than is available using the “standard” shift feature.

Memory system operation will be detailed in a later section; here is the procedure for storing and recalling an “odd split” using a Memory channel:

1. First store the *receive* (repeater output) frequency.

In the VFO mode, tune the transceiver to the desired receive frequency. Now press and hold in the [VFO/MR] button on the microphone for one second. Notice that the display is now blinking.

2. Within five seconds of pressing the [VFO/MR] button, use the **MAIN DIAL** knob or microphone’s [UP]/[DWN] buttons to select the desired Memory channel for storage (occupied memory channels will show the currently-memorized frequency, while open channels will be blank).

3. Now press the [VFO/MR] button momentarily to store the receive frequency into the selected memory.

4. Next store the *transmit* (repeater input) frequency.

Since you are still in the VFO mode, tune the transceiver to the desired transmit frequency.

5. Now press and hold the [VFO/MR] button for one second. The display will again blink.

6. Press and hold in the **PTT** switch, and press the [VFO/MR] button momentarily while holding in the **PTT** switch. This will not cause transmission, but rather it will instruct the transceiver that you are *programming* a separate *transmit frequency* into memory.

7. If you tune off the displayed frequency, you can now return to the just-stored Memory channel by pressing the [VFO/MR] button momentarily.

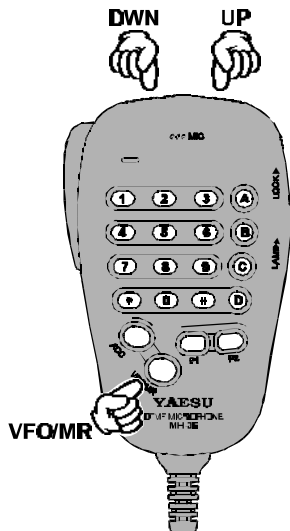

Operation

Tone Squelch Systems

These systems allow silently monitoring until a call directed to you is received, and offer privacy on an otherwise busy channel.

CTCSS (Continuous Tone Coded Squelch System)

This system superimposes a continuous, subaudible (low-frequency) tone on your transmitted audio. When decoded at the other station, this allows their squelch to open so as to receive your transmission. Some “closed” repeaters use this to limit access, or to prevent signals intended for other repeaters (with the same input frequency) in fringe areas from locking up the repeater. There are 47 selectable CTCSS tones.

DCS (Digital Code Squelch)

DCS operation modulates a subaudible tone according to a digital protocol (continuous 32-bit synchronous code). DCS is widely used in the commercial land-mobile industry because of its superior performance, and its 104 unique codes offer greater tone selection than CTCSS.

To use either CTCSS or DCS, both stations must be on the same operating frequency, and must have selected the same CTCSS tone or DCS code.

To select and activate CTCSS or DCS operation:

- Press the [P1] button to select the desired squelch type from the following:
 - “ENC” (Encode) appears when the CTCSS tone generator is activated for *transmission* only.
 - “ENC/DEC” (Encode & Decode) appears when the CTCSS tone squelch is activated for both TX & RX (only signals “encoded” with the matching tone will open the squelch; your radio will remain silent otherwise).
 - “BELL” (CTCSS Bell Paging) appears when CTCSS Bell Paging is activated, as described in detail later.
 - “DCS” (Digital Code Squelch) appears when Digital Code Squelch system (TX & RX) is active.
 - “OFF” (No tone or digital code system activated)
- Wait a few seconds; the display will revert to its normal status, and your new CTCSS or DCS operating mode will be saved.

For the discussion below, let us assume that the **[P1]** key is in its default setting (selection of Tone options). If not, one of the programmable keys must be assigned the “**TONE**” function, per the instructions on pages 47 and 48.

1. When you have chosen the desired operating frequency, press the **[P1]** key momentarily. The display will indicate “**OFF**” if no CTCSS or DCS code is currently engaged.
2. Within three seconds, press the **[P1]** key as many times as required to activate the desired Tone mode. The available options are:

ENC (CTCSS Encoder) The current tone will be shown at the bottom of the display.

ENC/DEC (CTCSS Encoder/Decoder) The current tone will be shown at the bottom of the display.

BELL (CTCSS Bell Paging) The current tone will be shown at the bottom of the display.

DCS (DCS Encoder/Decoder) The current DCS Code # will be shown at the bottom of the display.

OFF No CTCSS/DCS tone or code is active.

3. When you have made your selection from the above list, press the microphone’s **[UP]** or **[DWN]** key, as many times as required, to select the desired CTCSS Tone Frequency or DCS Code #.
4. When you have completed your selections, wait until the “Tone Programming” display disappears; you may now resume normal operation. If you are working on a Memory channel, you should re-memorize the changes you have just made.

Note:



It is not possible to store a different CTCSS tone frequency or DCS code on the uplink and downlink of a repeater.

Operation

DCS Tone Search Scanning

In operating situations where you don't know the DCS code being used by another station, you can command the radio to listen to the incoming signal and scan in search of the DCS code being used.

To scan for the DCS code in use:

1. Set the radio up for the DCS operation.
2. Press and hold in the  key for one second, then rotate the **MAIN DIAL** knob to select "1 3 DCS."
3. Press the  key to start scanning for the incoming DCS tone.

When the radio detects the correct tone, it halts on that tone, and audio is allowed to pass. The tone code will be shown at the lower left side of the display, and you may then set MENU #12 to the same DCS code, if you wish to store the frequency into memory.

Press and hold in the  key for one second to exit to normal operation.

CTCSS Bell Paging

Bell Paging adds an alert ringer to CTCSS tone squelch operation, for added convenience. When you receive a call with a matching CTCSS tone, the ringer sounds to alert you to the presence of the incoming call.

To activate CTCSS Bell operation, press the microphone's **[P1]** button until "BELL" appears on the display.

As before, calls without a matching CTCSS tone will be ignored. Those *with* a matching tone will cause the transceiver to ring as the squelch opens while the caller transmits. Note that other stations do not need to have the *CTCSS Bell* function to call you; they can just use standard CTCSS encoding.

When you reply to a CTCSS Bell call, you may want to turn off the Bell function, or else the transceiver will ring every time your squelch opens.

You can store CTCSS Bell Paging as a "tone mode" in a memory, as you can do with different CTCSS/DCS tone and encode/decode states.

1750 Hz Tone Calling (European Versions)

In the European versions of the **FT-90R**, press the **[ACC]** button on the microphone to transmit a 1750 Hz Burst Tone for repeater access.

If you own a non-European version of the **FT-90R**, but plan on visiting a country which requires a 1750 Hz tone for repeater access, you may use MENU #26 to set up the **ACC** key for 1750 Hz Tone operation. See page 57 for details.













DTMF Tone Generation

The white keys (with numbers, letters, or the */# characters printed on them) on the microphone may be used for manual sending of DTMF tones for autopatch or repeater control use. Just press the **PTT** switch, and hold it in, while pressing the desired keys.





DTMF Autodialer Operation

Eight DTMF Autodialer memories are available on the **FT-90R**. These DTMF Autodialer memories can store up to 16 digits of a telephone number for repeater autopatch or other use.

To load DTMF Autodialer memories, use following procedure:

1. Press and hold in the  key for one second, then rotate the **MAIN DIAL** knob to select “17DTMFw.”
2. Press the  key, as needed, to select the DTMF Autodialer memory channel number into which you wish store a telephone number (“1” to “8”).
3. Press the  key momentarily.
4. Press the  or  key to select the first digit of the telephone number you wish to store.
5. When you have selected the correct digit, press the  key momentarily.
6. Now press the  or  key to select the second of 16 available digits in the current DTMF Autodialer memory. Press the  key (momentarily).
7. Repeat this procedure for each digit in the telephone number.
8. When entry of all digits is complete, press and hold in the  key for one second. This locks the DTMF string into the current register. You may now press the  key momentarily to review your entry for accuracy.
9. Press the  key to select another DTMF Autodialer memory channel, and repeat the process described above, beginning in step 2. When you are done programming all desired DTMF Autodialer memory channels, press and hold in the  key for 1.5 second to exit to normal operation.



To transmit the memorized telephone number, use the following procedure:

1. With the transceiver set to MENU #17 (“DTMFw”), press the  key, as needed, to select the DTMF Autodialer memory channel you wish to send.
If you can't remember what number is stored in a particular memory, just press  momentarily to review the memory's contents.
2. Press and hold in the **PTT** key, then press the  key momentarily while holding in the **PTT** key. The DTMF string will be transmitted automatically.
Once you have pressed the  button in this step, you can release the **PTT** switch, as the Autodialer transmits the entire DTMF string automatically.





Operation

The speed at which the DTMF digits are sent can be changed. Two speed levels are available: Low (10 digits per second) and High (20 digits per second, the default setting).

To toggle between Low and High speed, use the following procedure:

1. Press and hold in the  key for one second, then rotate the **MAIN DIAL** knob to select “1 6 DTMF s .”
2. Press the  key to select the desired speed: “5 0 m s” (High speed) or “1 0 0 m s” (Low speed).
3. Press and hold in the  key for 1.5 second to save the new setting and exit to normal operation.



You can also set a longer delay between the time the  key is pressed and the first DTMF digit is sent. To set the delay time, use the following procedure:

1. Press and hold in the  key for one second, then rotate the **MAIN DIAL** knob to select “1 5 DTMF d .”
2. Press either the  or  key to select the desired speed from the available choices (5 0 / 2 5 0 / 4 5 0 / 7 5 0 / 1 0 0 0 ms).
3. Press and hold in the  key for 1.5 second to save the new setting and exit to normal operation.

MIC Gain Control

You can reduce the microphone input level when operating on tightly-clustered frequencies (channel spacing of 12.5- or 15-kHz). This will reduce the transmitter deviation, thus minimizing interference to other users.

To reduce the microphone input level:

1. Press and hold in the  key for one second, then rotate the **MAIN DIAL** knob to select “3 6 T x N a r .”
2. Press the  key to change the display to “0 N .”
3. Press and hold in the  key for 1.5 second to save the new setting and exit to normal operation.

To restore the microphone input level to the normal setting, select “0 F F” in step 2 above.

Memory System Operation

The **FT-90R** includes a versatile Memory system which makes everyday operation more efficient. The Memory System provides 180 “standard” memories, plus two pairs of band-limiting memories, and a one-touch “HOME” channel for each band.

For ease in recognition of a channel’s function, Alpha-Numeric labels can be appended to the frequency information.

The discussion below presumes that the function of the microphone’s **[VFO/MR]** button is set to the default “**VFO/MR**” configuration. If you have used any of **MENU** items 22~26 to assign the “**VFO/MR**” function to another microphone button or front panel key, use whatever key you have assigned for the “**VFO/MR**” function when the **[VFO/MR]** button is called for in the sections to follow. See page 47 for details on programming the microphone buttons and front panel keys.

Memory Storage

To store a frequency into memory:

1. In the VFO mode, select the desired frequency, repeater shift, CTCSS tone, TX power level, and, if this is a packet channel, the desired baud rate (1200/9600).
2. Press and hold in the **[VFO/MR]** button on the microphone for one second. The display will blink; if a frequency is displayed along with a blinking channel number, this will indicate that the channel already has frequency data stored on it.
3. Within five seconds of pressing the **[VFO/MR]** button, use the **MAIN DIAL** knob or the microphone’s **[UP]/[DWN]** buttons to select the desired memory channel for storage. Look for a channel where no data is currently stored, so as not to over- write channel data you may wish to use.
4. Press the **[VFO/MR]** button again, this time momentarily, to store the displayed data into the selected memory channel slot. The memory label will stop blinking for a second, then will disappear (since you are still operating in the VFO mode).

Recalling Memories

From the VFO mode, momentarily press the **[VFO/MR]** button on the microphone to activate the “Memory” mode.

When more than one memory has been stored, use the **MAIN DIAL** knob to select a memory for operation. Alternatively, microphone’s **[UP]** or **[DWN]** button may be used to stop or scan through the available memories. When using the microphone’s buttons, press and release the button to move one step up or down; press and hold the **[UP]** or **[DWN]** button for one second to begin memory scanning.



Memory System Operation

DIRECT KEYPAD MEMORY RECALL (requires MH-36A6J)

Which begins with “The desired memory channel may be recalled directly from the microphone’s keypad”.

To recall a memory channel from the keypad, just press the digits on the keypad in the proper sequence, followed by the  key.

Examples:

To recall memory channel #5, press  .

To recall memory channel #100, press    .

HOME Channel Memories

Convenient one-touch “HOME” channel memories (one per band) are available to simplify return to your most-often-used frequency. These memories do not appear in the regular memory banks, to simplify operation.

The use of the HOME channel requires that one of the “Programmable” keys must be changed, via the MENU system, for a different function than that assigned at the factory. See page 47 for details. The discussion below will assume that this function has been assigned to the **[P2]** key on the microphone.

To recall the HOME channel on the current band, momentarily press the **[P2]** key (or whichever “Programming key” you may have assigned to the “HOME” channel). The “H” icon will appear at the bottom left corner of the display (while in the “CONTROL MODE” of the display). Another press of the **[P2]** key will recall the HOME channel of the other band. Press **[VFO/MR]** to revert to VFO or Memory operation.

Programming the HOME Channel(s)

The factory default frequencies for the HOME channels are 146.520 MHz (Europe Version: 145.000 MHz) for VHF and 446.000 MHz (Europe Version: d 433.000 MHz) for UHF. You can re-program the HOME channels in a manner identical to that used for the regular memories.

1. From the VFO mode, tune in the frequency you wish to store, and set all repeater shifts and other data just the way you do for “normal” memory channel storage.
2. Press and hold in the **[VFO/MR]** button on the microphone for one second, then press the **[P2]** key momentarily.









Note that there is only one HOME channel for each band.

Memory System Operation



Naming and Displaying Memories

You can append to stored memories an Alpha/Numeric tag (up to seven characters), to provide an easy reminder as to a particular frequency's function.

To name a memory:

1. Recall the memory to be named.
2. Press and hold in the  key for one second, then rotate the **MAIN DIAL** knob to select "02ALPHc."
3. You will notice the first entry position blinking. While it is blinking, press the  key or  key to select the first character of the memory's name, then press the  key to move on to the next character to the right.
4. Press the  key or  key to select the next character, then press the  key to move on to the next character's slot.
5. Repeat steps 3 and 4, as necessary, to complete a name tag for your memory, then press and hold the  key for 1.5 second to save the Alpha/Numeric name and exit to normal operation.

To turn on the memory name display:

1. Press and hold in the  key for one second, then rotate the **MAIN DIAL** knob to select "01ALPH."
2. Press the  key to change the display to "0N."
3. Press and hold in the  key for 1.5 second so that the name just assigned (not the frequency) appears on the LCD.

To restore the frequency display, and hide the Alpha/Numeric label, select "OFF" in step 2 above. Each memory channel may have its Alpha/Numeric On/Off status set independently.

Loading a Memory into the VFO

You can easily select a memory and use that frequency as a starting point for VFO operation.

1. Recall the memory channel of the frequency you wish to copy to the VFO.
2. Press and hold in the **MAIN DIAL** knob for one second. The radio will switch to the VFO mode, and it will be operating on the frequency of the memory channel you just left. You may now tune freely without having affected the original memory contents.

Note that the previous VFO frequency will be overwritten by this action.

Memory System Operation

Memory-Only Mode

Once memory channel programming has been completed, you may place the radio in a “Memory Only” mode, whereby VFO operation is impossible. This may be particularly useful during public-service events where a number of operators may be using the radio for first time, and ultimate simplicity of channel selection is desired.

To place the radio into the Memory Only mode, turn it off. Now press and hold in the **[VFO/MR]** button on the microphone (or whichever key you have assigned for the VFO/MR function) while turning the radio on.

To return to normal operation, repeat the above power-on procedure.

Erasing Memories

With 186 total memories available, there frequently are situations where you may desire to “erase” memories which are no longer needed.

To erase a memory:

1. Recall the memory to be erased. Note that Memory Channel 1 may *not* be deleted, as it is the Priority Channel.
2. Press and hold the **[VFO/MR]** button on the microphone for one second.
3. Press the  button. This will cause the display to shift to Memory Channel “1,” and the previously-selected memory will now be eliminated from the memory bank.

Important Note:

Erased memory channels can not be recovered.

Scanning Features

Scanning Operation

The **FT-90R**'s microprocessor-based scanning feature allows quick scanning of the memory channels, or sweeping of a band, looking for activity.

Before activating the scanner, make sure that the **SQL** control is set to silence the background noise when no signal is present. If the noise is not squelched, the transceiver will “think” that it has found a signal, and will not scan.

Scanning may be started or stopped with the microphone's **[UP]** or **[DWN]** button.

The following techniques are used for scanning:



1. Pressing and holding in either the **[UP]** or **[DWN]** button for one second in the *VFO mode* will cause upward or downward *band* scanning, respectively, to begin.
2. Pressing and holding in either the **[UP]** or **[DWN]** button for one second in the *Memory mode* will cause memory channel scanning toward a higher- or lower-numbered *memory channel*, respectively.
3. Scanning pauses when a signal opens the squelch, and the decimal point on the display will blink. You can choose one of two scan-resume modes (described below).
4. To halt the scan manually, the easiest way is to push the **PTT** switch on the microphone momentarily (no transmission will occur while you are scanning). The scan may also be halted manually by pressing the microphone's **[UP]** or **[DWN]** button, or the microphone's **[VFO/MR]** button.

Scan-Resume Options

Two scan-resume modes are available on the radio:

- In the **BUSY** mode, the scanner will remain stopped for as long as there is carrier present on the channel; after the carrier drops at the end of the other station's transmission, the scanner will resume.
- In the **TIME** mode, the scanner will halt for five seconds *only*, after which scanning will resume (whether or not the other station is still transmission).

To change the scan-resume mode, use the following procedure:



1. Press and hold in the  key for one second, then rotate the **MAIN DIAL** knob to select “**29SCAN**.”
2. Press the  key to select the desired scan-resume mode (**BUSY** or **TIME**).
3. Press and hold in the  key for 1.5 second to save the new setting and exit to normal operation.

Scanning Features

Memory Skip Scanning

When you have some continuously-active channels in memories, you may wish to *skip* them for *scanning*, but still have them available for *manual selection*.

To mark a memory to be skipped during scanning, use the following procedure:

1. Recall the memory channel to be skipped. Note that Memory Channel 1 may *not* be skipped.
2. Press and hold in the  key for one second, then rotate the **MAIN DIAL** knob to select “3 1 SKIP.”
3. Press the  key to select “SKIP.”
4. Press and hold in the  key for 1.5 second to save the new setting and exit to normal operation.

To re-enable a “skipped” memory channel, select “STOP” in step 3 above.

Temporary Memory Skip

If the scanner repeatedly stops on a channel due to temporary noise or interference, you can temporarily mark it to be skipped (except the Memory Channel 1). The channel will be skipped until you manually stop the scan (by pressing the **PTT** switch, for example).

To skip a channel temporarily, press the  key momentarily *while the scanner has stopped on the channel to be skipped*. The scanner will instantaneously resume, and that channel will not be scanned during this scanning session.

Programmable Band-Scan Limits

Besides band and memory scanning, this transceiver can be set to tune or scan only the frequencies between user-defined lower and upper limits. For example, during 2-meter band scanning you may wish to limit tuning/scanning to 144.5 ~ 148 MHz, to avoid encroachment on the SSB/CW sub-band between 144.0 and 144.5 MHz.

These limits are stored in special “Sub-Band Limit Memories” labeled **PMS-1L**, **PMS-1U**, **PMS-2L**, and **PMS-2U**, with “L” and “U” designations representing the Lower and Upper limits, respectively.

To utilize this feature, use the following steps:

1. Store the lower edge of the desired scanning/tuning range in memory “PMS-1L,” and the upper edge in memory “PMS-1U” (or, alternatively, in memories “PMS-2L” and “PMS-2U”).
2. With any of these memories recalled, press the **MAIN DIAL** knob momentarily to

Scanning Features

activate the Programmable Band-Scan Limits. The frequencies stored in memories “L” and “U” will now serve as tuning and scanning limits, thus creating a tuning sub-band. The “p” icon will appear in the bottom left corner of the display in the “CONTROL MODE” of the display.

To cancel the sub-band limits and return to normal memory operation, press the [VFO/MR] button on the microphone momentarily. If you are scanning, or if you want to switch to VFO operation, press the [VFO/MR] button twice from the “limited sub-band” mode of operation.

Once you have stored the “L” and “U” memories, you can re-activate the sub-band limits by simply recalling either memory and pressing the **MAIN DIAL** knob. However, you cannot activate the sub-band limits when either of these memories is marked to be *skipped* during scanning.

If you have stored sub-band limits in both the **PMS-1 L/1 U** and **PMS-2 L/2 U** memory registers, the scanning behaves somewhat differently: the transceiver will scan from the “PMS-1 L” frequency to the “PMS-1 U” frequency, then jump to the “PMS-2 L” frequency and scan to the “PMS-2 U” frequency, after which it will return to the “PMS-1 L” frequency and repeat the process. If you want to have something stored in the “PMS-2 L” and “PMS-2 U” registers, but do not wish to include them in the scanning process, just mark them to be “Skipped” as described previously.

Smart Search Operation

The Smart Search feature may be used to load – automatically with no operator intervention – a special bank of up to 50 memory channels (per band) based on activity. Smart Search will sweep either the entire band or the portion of the band within the Programmable Band-Scan Limits and will load the Smart Search memory bank with the frequency data pertaining to those channels on which activity is found. The channels are loaded in the order in which they are encountered, not according to signal strength or by ascending frequency.

The Smart Search feature is especially useful when visiting a city for the first time, where you may be unfamiliar with the repeater frequencies; Smart Search discovers where the local activity is to be found, and automatically loads those frequencies for you.

Smart Search operation is simple to activate:

1. Press and hold in the  key for one second.
2. The Smart Search process will now cause the radio to scan upward on current band, loading channels on which it encounters a signal strong enough to open the squelch.

Scanning Features

3. When 50 channels are loaded or the scanner reaches the band edge, the scanner will stop and the transceiver will revert to the starting frequency.
4. To recall the Smart Search Memories just stored, rotate the **MAIN DIAL** knob.
5. Press the microphone's **[VFO/MR]** button momentarily to exit the Smart Search mode.

Note that these memories are so-called “soft” memories; they will be lost if you exit Smart Search to a VFO/Memory, or if you initiate a new Smart Search. Smart Search also does not store CTCSS or DCS information; if you cannot access a repeater found during Smart Search, you may need to investigate possible access tones.

Priority Channel Monitoring

In the U.S.A. version, the Priority function allows automatic checking for activity on Memory Channel 1 every five seconds while operating on the VFO or a different memory. When the receiver detects a signal on the designated “Priority” memory (Channel 1), operation automatically shifts to that memory while the signal is present (plus a few seconds). If you transmit while “paused” on the Priority channel, priority monitoring will cease, and the transceiver will “hold” indefinitely on the Priority channel.

The transceiver will *only* check Memory Channel 1 as the Priority channel if you are operating in the memory mode. No other memory may be designated as the Priority channel.

To set up for Priority monitoring:

1. Preset the **SQL** control to silence the background noise on a clear channel, then store the frequency to be the “Priority” channel into *Memory Channel 1*.
2. Press the **[VFO/MR]** button on the microphone to operate in the VFO mode. If you are in the memory mode, select the memory on which you wish to operate (other than the Priority channel).
3. Press the microphone's **[ACC]** button momentarily to start Priority monitoring (a “P” icon will appear at the bottom left-hand corner on the LCD in the “CONTROL MODE” of the display).

During Priority monitoring, the displayed frequency will shift to the Priority memory briefly about every five seconds, while the receiver checks for the presence of a signal.

When no signal appears on the Priority memory (causing the squelch to open), you can tune, transmit and receive on the VFO, or select and operate on other memories; however, you cannot scan (except manually, using the microphone's

Scanning Features

[UP] and [DWN] buttons), as the scanning logic circuits are already dedicated to the priority scanning activities.

If a station you wish to talk with appears on the Priority memory, press the **PTT** switch momentarily while receiving their signal (no transmission will occur) to *halt* Priority scanning. Otherwise, when a signal appears on the Priority channel, Priority monitoring will just pause on that channel, and the decimal on the display will blink. Priority monitoring will resume based on the setting of the regular scanning-resume mode - either after a 5-second pause, or after the carrier drops out.

To cancel Priority monitoring, press the microphone's [ACC] or [VFO/MR] button momentarily.

A few other rules govern priority operation:

- You can not scan operation during priority operation.
- The priority function is not disabled by switching the transceiver off. If you were engaged in priority monitoring at the moment you turned the radio off, it will *assume* that you will want to continue priority monitoring during your next operating session, and will come up still in the priority mode when the transceiver is switched back *on*.

Priority monitoring is also available in the European version, although none of the “Programmable” keys is set up for Priority monitoring as a default setting. The function of one of these keys may easily be set up for Priority monitoring; see the “Programming the Front Panel/Microphone Key Functions” section on page 47 for details.

ARTS: Auto Range Transpond System

This system uses DCS signaling to inform you when you and *another ARTS-equipped station* are within communications range. Both stations must first select DCS operation using the same DCS code.



Whenever you press the **PTT**, or every 30 seconds after ARTS is activated, your radio will transmit a (subaudible) DCS signal. If the other radio is in range, the beeper (if enabled) will sound and “**ARTS IN**” will appear on the display. Whether you talk or not, the radios will continue to poll each other every 30 seconds while ARTS is activated.

You can also have your radio transmit your callsign via CW every nine minutes, to comply with identification requirements.

If you move out range for more than one minute (two polls), your radio will sense that no signal has been received. A beep will sound, and the display will change to “**ARTS OUT**” (out of range). If you move back *into* range, your radio will again beep, and the display will change back to “**ARTS IN**.”

During ARTS operation, the microprocessor makes it impossible to change the operating frequency or other settings; you must first terminate ARTS to resume normal operation. This is a safety feature to prevent accidental loss of contact due to channel change, etc.

Here is how to activate ARTS:

1. Press and hold in the  key for one second, then rotate the **MAIN DIAL** knob to select “**05ARTS**.”
2. Press the  key to select the ARTS operating mode: “**RX**” (receive-only), “**TX**” (transmit-only), “**TRX**” (transceive), or “**OFF**” The operating descriptions assume that both radios are set to “**TRX**.”
3. Press and hold in the  key for 1.5 second to save the entry and exit. The display will now show “**ARTS OUT**.” After two pollings (one minute), if a response is not detected, “**ARTS OUT**” will appear continuously; otherwise “**ARTS IN**” will be displayed as long as both stations remain in range.
4. To cancel ARTS operation, select “**OFF**” in step 2 above.

ARTS: Auto Range Transpond System

ARTS Modes

In the previous ARTS description, both transceivers were set to the “TRX” (transceive) mode. There are two other ARTS modes available via the MENU system, as outlined below:









RX Use this mode if you only want your radio to listen, and not poll the other station (in which case their radio should be set to the “TX” mode). Here, your radio will beep and display “ARTS IN ” or “ARTS OUT” to indicate the state of connection.

TX Likewise, this puts your radio into a *transmit-only* “beacon” mode where you won’t hear the polling beeps (but you can still hear when the other station talks). When activated, you have *no display of whether or not the other station is in range* (“ARTS IN ” and “ARTS OUT” do not appear). You should have your CW IDeR enabled when this mode is activated.



CW ID (Morse Identifier) Set up

The ARTS feature includes a CW identifier, as mentioned previously. The radio can be instructed to send “DE (*your callsign*) K” in Morse code every nine minutes during ARTS operation. The callsign may contain up to 7 characters.

Here’s how to program the CW IDeR:

1. Press and hold in the  key for one second, then rotate the **MAIN DIAL** knob to select “08C WID#.”
2. You will notice the first character’s entry slot blinking. While it is blinking, press the  or  key to select the desired character, then press the  key to move on to the next character to the right.
3. Press the  or  key to select the next number or letter, then press the  key to move on the next character.
4. When the callsign is complete, press and hold in the  key for 1.5 second to save the CW ID entry and exit to normal operation.

To activate the CW IDeR for use during ARTS operation:



1. Press and hold in the  key for one second, then rotate the **MAIN DIAL** knob to select “07C WID.”
2. Press the  key to change the display to “0N.”
3. Press and hold in the  key for 1.5 second to save the new setting and exit to normal operation.

To disable the CW IDeR, select “OFF” in step 2 above.

Packet Operation

Packet operation generally requires only that you connect your TNC per the illustration on page 16, then configure the channel for 1200 bps or 9600 bps using the MENU.

To select the Packet baud rate, use the following procedure:

1. Press and hold in the  key for one second, then rotate the **MAIN DIAL** knob to select “**21PKT.**”
2. Press the  key to select the desired baud rate (**1200bps** or **9600bps**).
3. Press and hold in the  key for 1.5 second to save the new setting and exit to normal operation.

The packet baud rate selection can be set independently for each band (VHF and UHF) during VFO operation. Note also that the packet baud rate may be stored into memory channels, so you won't need to enter the MENU each time you wish to operate in the Packet mode.





Miscellaneous Settings

Time-Out Timer

The “Time-Out Timer” (TOT) feature is designed to force the transceiver into the “receive” mode after a pre-set time period of continuous transmission (the default is 6 minutes). This feature prevents your transceiver from transmitting a “dead carrier” for a long period of time in the event that the microphone **PTT** switch is accidentally locked in the “TX” condition.

The Time-Out Timer’s “switch-to-receive” time may be adjusted, in one minute increments, for any period between 1 and 60 minutes.





To change the default (6 minute) time setting:

1. Press and hold in the  key for one second, then rotate the **MAIN DIAL** knob to select “**3 5 T O T**.”
2. Press either the  or  key to select the desired time interval (between **1** and **60** minutes, or **OFF**).
3. Press and hold in the  key for 1.5 second to save the new setting and exit to normal operation.

Automatic Power-Off

The “Automatic Power-Off” (APO) feature will turn the radio completely *off* after a user-defined period of **PTT** or key/button inactivity. If you do not press any front panel keys or buttons, do not rotate the **MAIN DIAL** knob, do not use the microphone’s keys and buttons, do not transmit, and so long as the transceiver is not scanning or engaged in priority monitoring, the radio will shut itself off after the specified time period. This feature is useful in minimizing battery drain in a mobile installation if you forget to turn the transceiver off when you leave your vehicle.

To activate the APO feature:



1. Press and hold in the  key for one second, then rotate the **MAIN DIAL** knob to select “**0 3 A P O**.”
2. Press either the  or  key to select the desired “switch-off” time (between **1** and **12** hours, or **OFF**).
3. Press and hold in the  key for 1.5 second to save the new setting and exit to normal operation.

Miscellaneous Settings



Cooling Fan Control

The **FT-90R**'s microprocessor will automatically activate the cooling fan during transmitting and for thirty seconds thereafter, or when the chassis temperature rises.



You can change the operating mode of the cooling system, should the ambient temperature in your station require it, using the following procedure:

1. Press and hold in the  key for one second, then rotate the **MAIN DIAL** knob to select "1 8 FAN."
2. Press the  key to change the desired operating mode.
 - AUTO:** The cooling fan rotates at high speed when the chassis temperature rises; the fan rotates at low speed otherwise.
 - TX:** The cooling fan rotates high speed when transmitting, and for 30 seconds thereafter; the fan rotates at low speed otherwise.
 - AUTO/TX:** The cooling fan rotates at high speed when both of the above conditions exist; the fan rotates at low speed otherwise.
 - OFF:** The cooling fan rotates continuously at low speed.
3. Press and hold in the  key for 1.5 second to save the new setting and exit to normal operation.

Programming the Front Panel/Microphone Key Functions

Default **FT-90R** key functions have been assigned (at the factory) to the front panel's  and  keys, as well as the microphone's [P1], [P2], and [ACC] buttons. These may be changed by the user, if you wish to define another function for a particular key or keys.

To change the assignment of a key's function:

1. Press and hold in the  key for one second, then rotate the **MAIN DIAL** knob to the Menu Item # corresponding to the key to be assigned a function (22Pg: ←, 23Pg: →, 24Pg: P1, 25Pg: P2, or 26Pg: AC).
2. Press the  key to select the function you wish to assign to the key or button you selected in the previous step. The available choices are:
 - HOMECH** Switches frequency to the HOME channel.
 - VFO/MR** Switches frequency control between VFO and Memory.
 - STONE** Selects CTCSS or DCS mode and tone/code.
 - PRI** Activates Priority Channel monitoring.

Miscellaneous Settings

SCAN UP Activates Scanning toward higher frequency/memory channel.

SCANDN Activates Scanning toward lower frequency/memory channel.

RPTR Selects Repeater Shift direction.

REVERSE Reverses Repeater Uplink/Downlink frequencies.

T. BURST Activates 1750 Hz Tone Burst.

TX PWR Allows setting of the transmitter power level.

3. Rotate the **MAIN DIAL** knob to select another programmable key or button to modify, if desired, and make your selection from the above list.
4. Press and hold in the  key for 1.5 second to save the new setting and exit to normal operation.

Note:

The function of the [VFO/MR] key is fixed on the [VFO/MR] selection.

DCS Code Inversion

The DCS system was first introduced in the commercial LMR (Land Mobile Radio) service, where it is now in widespread use.

DCS uses a codeword consisting of a 23-bit frame, transmitted (subaudible) at a data rate of 134.4 bps (bit/sec). Occasionally, signal *inversion* can result in the *complement* of a code being sent or received. This prevents the receiver squelch from opening with DCS enabled, as the decoded bit sequence would not match that selected for operation.



Typical situations that might cause inversion to occur are:

- Connection of an external receiver preamplifier.
- Operating through a repeater.
- Connection of an external linear amplifier.

Note that code inversion does *not* mean that any of the above listed equipment is defective! In certain amplifier configurations, the output signal (phase) is inverted from the input. Small signal or power amplifiers having an odd number (1, 3, 5, etc.) of amplification stages may result in inversion of a transmitted or received DCS code.

Miscellaneous Settings

While under most circumstances this should not occur (amplifier designs and industry standards take this into account), if you find that your receiver squelch does not open when both you and the other station are using a common DCS code, you or the other station (*but not both*) can try the following:

1. Press and hold in the  key for one second, then rotate the **MAIN DIAL** knob to select “14DCSnr.”
2. Press the  key to select one of the following modes:

TRX NOR:	Encoder: Normal	Decoder; Normal
RXREV:	Encoder: Normal	Decoder; Reverse (Inverted)
TXREV:	Encoder: Reverse (Inverted)	Decoder; Normal
TRXREV:	Encoder: Reverse (Inverted)	Decoder; Reverse (Inverted)
3. Press and hold in the  key for 1.5 second to save the new setting and exit to normal operation.

Remember to restore the default setting to “TRX NOR” (Encoder Normal; Decoder Normal) when done.

Demonstration Mode

When the **FT-90R** is first turned on, the supplied DC voltage is displayed below the field which shows the operating frequency. The **FT-90R** also provides an alternative opening display option, called the “Demonstration” mode. This is a two-line scrolling message which might, for example feature your callsign on the top line and your name on the next line.





If your transceiver currently displays the DC voltage below the frequency, you can activate the Demonstration mode by pressing and holding in the  button while turning the transceiver on. The display will then indicate the demonstration comments until you activate some function on the radio (rotate the **MAIN DIAL** knob, etc.)

Press and hold in the  button return, while turning the **FT-90R** on, to return to the normal opening display.

Miscellaneous Settings





Programming the Demo Message

You also can change the Demonstration mode message, if desired, using the following procedure:

1. Press and hold in the  key while turning the transceiver on; you will notice the first character of the *upper* message area blinking.
2. While this character is blinking, rotate the **MAIN DIAL** knob to select the first character of the top message, then press the  key to move on to the next character to the right.
3. Rotate the **MAIN DIAL** knob to select the next character, then press the  key to move on to the next character's entry location.
4. Repeat steps 2 and 3, as necessary, to complete the upper message (up to 50 characters).
5. Now press the  key momentarily; you will now observe the first character of the *lower* message area blinking.
6. Repeat steps 2 and 3 again to set the *lower* message (up to 50 characters).
7. Press the  key to save the new messages and exit.

Resetting the CPU

If you encounter erratic operating results, or wish to clear all transceiver settings so as to start with the factory defaults, resetting the microprocessor provides a quick method of “starting over” with original factory settings.

- To reset all MENU settings to their factory defaults, press and hold in the  key *and* the  button while turning the transceiver on. This procedure does not alter or erase any channel memories you may have stored.
- To perform a CPU *master reset* for all memories and MENU settings, press and hold in the  key, the  key, and the  button while turning the transceiver on.

Transceiver Cloning

You can transfer all data stored in one **FT-90R** to another **FT-90R** by utilizing the handy “Cloning” feature. This requires a user-constructed Cloning cable which connects the **MIC** jacks on the two transceivers, as shown below.

To clone from one transceiver to another, use the following procedure:



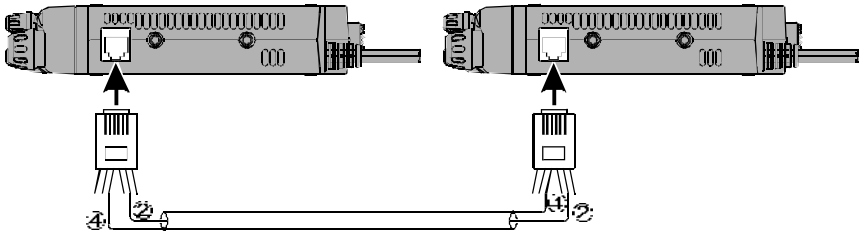

1. Insert the Clone Cable into the **MIC** jack of each transceiver.
2. Turn both transceivers off, then press and hold in the microphone’s **[ACC]** button (on each radio) while turning the power on again. The “**CLONE**” indication will appear on the display.
3. On the “destination” radio, press the **DSP** button. The “**R**” indicator will appear at the bottom left corner on the display (in the Frequency Control display mode).
4. Now, on the “source” radio, press the **SET** key. The “**T**” indicator will appear in the bottom left corner on the display, and the cloning data transfer will immediately begin.
5. If there is a problem during the cloning process, “**Error**” will be displayed. Check your cable connections, and try again.
6. If cloning was successful, turn the “destination” radio off. Now turn the “source” radio off.
7. Remove the Clone Cable. Channel and operating data for both radios are now identical. They both may be turned on now for normal operation.



Menu System

The **FT-90R**'s MENU system allows a number of transceiver operating parameters to be custom-configured for your operating requirements.



The MENU is easy to activate and set, using the following procedure:

1. Press and hold in the  key for one second.
2. Rotate the **MAIN DIAL** knob to select the MENU item to be adjusted.
3. Press the  or  key, as instructed in the sections to follow, to adjust the status or value of the MENU item. In many cases, the LCD field just above the  key will show a “▼” icon, indicating that the key below it is the one which should be pressed to toggle the available selections.
4. After completing your adjustment, press and hold in the  key for 1.5 second to save the new setting and exit to normal operation.

MENU items are conveniently arranged in alphabetical order.

Menu Item	Function	Available Values	Default
01ALPH	Enable/disable the Alpha-Numeric display	ON/OFF	OFF
02ALPHc	Store Alpha-Numeric "Tags"	-----	-----
03APO	Set the Automatic Power-Off time	OFF/1~12	OFF
04	Not Used	-----	-----
05ARTS	Select the ARTS mode	OFF/RX/TX/TRX	OFF
06BEEP	Enable/disable the key-button beeper	ON/OFF	ON
07CWID	Enable/disable the CW IDer during ARTS operation	ON/OFF	ON
08CWID#	Programming the CW IDer	-----	-----
09D Con	Setting the front panel display's contrast level	0~12	6
10D Dim	Setting the front panel display's illumination level	OFF/d1/d2/d3/d4	d1
11DC IN	Indication of the Supply Voltage	-----	-----
12DCS#	Setting the DCS code	104 standard DCS codes	023
13DCS	Activate the DCS Code Search Scanner	-----	-----
14DCSnr	Select "Normal" or "Inverted" DCS code	TRX NOR/RX REV TX REV/TRX REV	TRX NOR
15DTMFd	Setting the DTMF Autodialer delay time	50/250/450/ 750/1000	450
16DTMFs	Setting the DTMF Autodialer sending speed	50/100	50
17DTMFW	Programming the DTMF Autodialer	-----	-----
18FAN	Set the cooling fan function	OFF, AUTO, TX AUTO/TX	AUTO/TX
19LckTX	Enable/disable the PTT lock	OFF/ BAND A/BAND B	OFF

Menu System

Menu Item	Function	Available Values	Default
20LOCK	Enable/disable the key-button lock	ON/OFF	OFF
21PCKT	Set the transceiver's circuitry for the Packet baud rate to be used	1200/9600	1200
22Pg:	Programming the  key assignment	TONE PRI SCAN UP SCAN DN RPTR REVERSE T.BURST TX PWR HOME CH VFO/MR	REVERSE
23Pg:	Programming the  key assignment		RPTR
24Pg:P1	Programming the [P1] key assignment		TONE
25Pg:P2	Programming the [P2] key assignment		TX PWR
26Pg:AC	Programming the [ACC] key assignment		PRI
27RfSql	Adjust the RF SQL threshold level	S-3/S-5/S-FULL/ OFF	OFF
28RPTR	Setting the Repeater Shift Direction	ARS/Shift -/ Shift +/OFF	ARS
29SCAN	Select the Scan-Resume mode	BUSY/TIME	BUSY
30Shift	Set the magnitude of the Repeater Shift	0.00-99.95	
31SKIP	Enable/disable skipping of a memory during scanning	SKIP/STOP	STOP
32STEP	Setting the synthesizer steps	5.0/10.0/12.5/15.0/ 20.0/25.0/50.0	
33TONE	Select the CTCSS/DCS Operation Mode	ENC, ENC/DEC BELL, DCS, OFF	OFF
34TONEf	Setting the CTCSS Tone Frequency	39 standard CTCSS Tones	100.0
35TOT	Set the Time-Out Timer	OFF/1~60	6
36TxNar	Reducing the MIC Gain	ON/OFF	OFF
37TxPwr	Set the Tx Output Power	HIGH/MID1/ MID2/LOW	HIGH
38AM	Select the Receiving mode	AUTO/AM/INHIBIT	AUTO

Depends on transceiver version.

Menu Selection Details

01ALPH

Function: Enable/disable the Alpha Numeric display.

Available Values: ON/OFF

Default Setting: OFF

Note:

Setting can be set independently on each Memory channel.

02ALPHc

Function: Programming an Alpha/Numeric memory.

See page 36 for details.

Menu System

03APO

Function: Enable/disable the Automatic Power Off feature.

Available Values: 1 ~ 12 hours, or OFF

Default Setting: OFF

04 (Not Used)

05ARTS

Function: Select the ARTS mode.

Available Values: OFF/RX/TX/TRX

Default Setting: OFF

06BEEP

Function: Enable/disable the key/button beeper.

Available Values: ON/OFF

Default Setting: ON

07CWID

Function: Enable/disable the CW IDer during ARTS operation.

Available Values: ON/OFF

Default Setting: OFF

08CWID#

Function: Programming a callsign into the CW IDer. See page 44.

09D Con

Function: Setting the front panel display's contrast level.

Available Values: 0~12

Default Setting: 6

10D Dim

Function: Setting the front panel display's illumination level.

Available Values: d1/d2/d3/d4/OFF

Default Setting: d1

11DC IN

Function: Indication of the Supply Voltage.

12DCS#

Function: Setting the DCS code #.

Available Values: 104 standard DCS codes

Default Setting: 023

13DCS

Function: Activate the DCS Code Search Scanner.

14DCSnr

Function:Select “Normal” or “Inverted” DCS code.

Available Values:

TRX NOR (Encoder: Normal / Decoder: Normal)

RX REV (Encoder: Normal / Decoder: Reverse (Inverted))

TX REV (Encoder: Reverse (Inverted) / Decoder: Normal)

TRX REV (Encoder: Reverse (Inverted) / Decoder: Reverse (Inverted))

Default Setting: TRX NOR: (Encoder: Normal / Decoder: Normal)

15DTMFd

Function: Setting the DTMF Autodialer delay time.

Available Values: 50/250/450/750/1000 ms

Default Setting: 450 ms

16DTMFs

Function: Setting the DTMF Autodialer sending speed.

Available Values: 50/100 ms

Default Setting: 50 ms (High speed)

17DTMFw

Function: Loading the DTMF Autodialer memory. See page 31.

18FAN

Function: Set the cooling fan function.

Available Values: AUTO/TX, AUTO, TX, OFF

AUTO : The cooling fan rotates at high speed when the chassis temperature rises; the fan rotates at low speed otherwise.

TX : The cooling fan rotates high speed when transmitting, and for 30 seconds thereafter; the fan rotates at low speed otherwise.

AUTO/TX : The cooling fan rotates at high speed when both of the above conditions exist; the fan rotates at low speed otherwise.

OFF : The cooling fan rotates continuously at low speed.

Default Setting: AUTO/TX

Menu System

19LckTX

Function: Enable/disable the PTT lock.

Available Values: BAND A/BAND B/BOTH/OFF

Default Setting: OFF

Note:

“BAND A” is VHF, “BAND B” is UHF.

20LOCK

Function: Enable/disable the key/button lock.

Available Values: ON/OFF

Default Setting: OFF

21PCKT

Function: Set the transceiver’s circuitry for the Packet baud rate to be used.

Available Values: 1200/9600 bps

Default Setting: 1200 bps

22Pg:←

Function: Programming the  key assignment.

Available Values: TONE, PRI, SCAN UP, SCAN DWN, RPTR, REVERSE,
TX PWR, HOME CH, VFO/MR, T.BURST

Default Setting: REVERSE

23Pg:→

Function: Programming the  key assignment.

Available Values: TONE, PRI, SCAN UP, SCAN DWN, RPTR, REVERSE,
TX PWR, HOME CH, VFO/MR, T.BURST

Default Setting: RPTR

24Pg:P1

Function: Programming the [P1] button assignment.

Available Values: TONE, PRI, SCAN UP, SCAN DWN, RPTR, REVERSE,
TX PWR, HOME CH, VFO/MR, T.BURST

Default Setting: TONE

25Pg:P2

Function: Programming the [P2] button assignment.

Available Values: TONE, PRI, SCAN UP, SCAN DWN, RPTR, REVERSE,
TX PWR, HOME CH, VFO/MR, T.BURST

Default Setting: TX PWR

26Pg:AC

Function: Programming the [ACC] button assignment.

Available Values: TONE, PRI, SCAN UP, SCAN DWN, RPTR, REVERSE,
TX PWR, HOME CH, VFO/MR, T.BURST

Default Setting: PRI

27RfSql

Function: Adjust the RF SQL threshold level.

Available Values: S-3/S-5/S-FULL/OFF

Default Setting: OFF

28RPTR

Function: Setting the Repeater Shift Direction.

Available Values: ARS/Shift -/Shift +/OFF (Simplex)

Default Setting: ARS (Automatic Repeater Shift)

29SCAN

Function: Select the Scan-Resume mode.

Available Values: BUSY/TIME

Default Setting: BUSY

Note:

“TIME” is a five-second delay, after which scanning will resume.

30Shift

Function: Set the magnitude of the Repeater Shift.

Available Values: 0.00MHz ~ 99.95 MHz (50 kHz steps)

Default Setting: Depends on transceiver version (U.S.A., European, etc.).

Note:

Different shifts will appear, depending on the band you currently are on.

31SKIP

Function: Enable/disable skipping of a memory during scanning.

Available Values: SKIP/STOP

Default Setting: STOP (Scanner stops when the channel is busy)

32STEP

Function: Setting the synthesizer steps.

Available Values: 5.0/10.0/12.5/15.0/20.0/25.0/50.0 kHz

Default Setting: Depends on the transceiver version (U.S.A., European, etc.).

Menu System

33TONE

Function: Select the CTCSS/DCS Operation Mode.

Available Values: ENC, ENC/DEC, BELL, DCS, OFF

Default Setting: OFF

34TONEf

Function: Setting the CTCSS Tone Frequency.

Available Values: 39 standard CTCSS Tones

Default Setting: 100.0 Hz

35TOT

Function: Set the Time-Out Timer.

Available Values: 1 ~ 60 minutes or OFF

Default Setting: 6 minutes

36TxNar

Function: Reducing the MIC Gain.

Available Values: ON/OFF

Default Setting: OFF (Normal Deviation)

37TxPwr

Function: Set the Tx Output Power

Available Values: HIGH/MID1/MID2/LOW

Default Setting: HIGH

38AM

Function: Select the receiving mode.

Available Values: AUTO/ AM/INHIBIT

Default Setting: AUTO (AM in Aeronautical Bands, FM elsewhere)

Note:

The “Inhibit” option locks reception in the FM mode

Notes

This device complies with Part 15 of the FCC rules.
Operation is subject to the condition that this device
does not cause harmful interference.

YAESU

...leading the way.SM

Copyright 1999
Yaesu Musen Co., Ltd.
All rights reserved.

No portion of this manual
may be reproduced
without the permission of
Yaesu Musen Co., Ltd.

Printed in Japan