

YAESU
The radio

FTM-7250DR

FTM-7250DE

Advance Manual

VHF/UHF DIGITAL/ANALOG TRANSCEIVER
C4FM/FM



Contents

Basic Operation	2
Microphone Gain Setting.....	2
RF Squelch	2
Advanced Operation	3
Programming the Key Assignments	3
CTCSS Operation	4
Tone Search.....	5
DCS Operation.....	6
DCS Search	7
Split Tone Operation.....	8
EPCS (Enhanced Paging & Code Squelch) Operation.....	9
Storing CTCSS Tone Pairs for EPCS Operation	9
Activating the Enhanced Paging & Code Squelch System.....	10
DTMF Operation	11
Transmitting a DTMF code manually	11
Registering a DTMF code.....	12
Transmitting the registered DTMF code	13
Setting DTMF Autodialer sending Speed.....	13
Setting DTMF Autodialer TX delay time.....	14
Checking the Repeater Uplink (Input) Frequency.....	14
Memory Operation.....	15
Split Memory	15
Moving Memory Data to the VFO.....	15
Memory Only Mode.....	15
Naming a Memory Channel	16
Scanning	17
Scan Resume Options	17
Memory Skip Scanning	18
Preferential Memory Scan.....	19
Programmable Memory Scan (PMS).....	20
Registering to the programmable memory channels.....	20
Scanning the programmable memory channels	21
Band Edge Beeper.....	21
Priority Channel Scanning (Dual Watch).....	22
Priority Revert Mode	22
GM Function.....	23
GM Alert Beep.....	23
GM Polling Interval.....	23
Clone.....	24
Setup (Menu) Mode	25
Menu Selection Details	28

Basic Operation

Microphone Gain Setting

The microphone gain has been programmed at the factory to a level that should be satisfactory for the supplied MH-48A6JA Microphone. If an after-market microphone is used, you may wish to set a different Mic Gain level.

1. Press and hold the **[MHz(SETUP)]** key to enter the Set mode.
2. Rotate the **DIAL** knob to select "**MIC GAIN 25**".
3. Press the **[MHz(SETUP)]** key, then rotate the **DIAL** knob to select the desired microphone gain level (LEVEL 1 - LEVEL 9).

Default: LEVEL 5

4. Press and hold the **[MHz(SETUP)]** key to save the new setting and exit to normal operation.

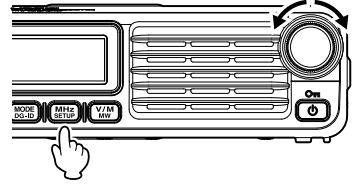

RF Squelch

A special RF Squelch feature is provided on this radio, which allows setting the squelch so that only signals exceeding a pre-set S-meter level will open the squelch.

Use the following procedure to set up the RF squelch circuit for operation:

1. Press and hold the **[MHz(SETUP)]** key to enter the Set mode.
2. Rotate the **DIAL** knob to select "**RF SQL 34**".
3. Press the **[MHz(SETUP)]** key, then rotate the **DIAL** knob to select the desired signal strength level for the squelch threshold (S1 - S8 or OFF).

Default: OFF

4. Press and hold the **[MHz(SETUP)]** key to save the new setting and exit to normal operation.

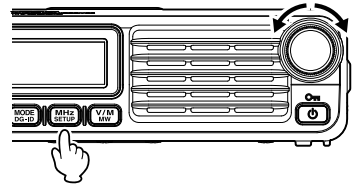

Advanced Operation

Programming the Key Assignments

Default FTM-7250DR/DE key functions have been assigned to the Microphone [P3]/[P4] keys at the factory. The user may change these key function assignments, if quick access to another function is desired.

To change the assignments for the programmable keys:

1. Press and hold the [MHz(SETUP)] key, then rotate the **DIAL** knob to select the Menu Item to configure the desired microphone button: (“**PRG P3 31**” or “**PRG P4 32**”).
2. Press the [MHz(SETUP)] key, then rotate the **DIAL** knob to select the function you wish to assign to the key you selected in the previous step.

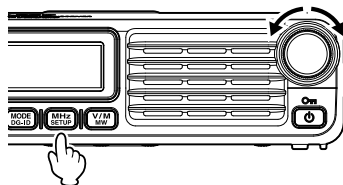

The available program functions differ slightly for each of the four keys, the choices include:

- SQL OFF:** Open the Squelch to allow un-muted reception.
- HOME:** Recall the home channel.
- WX CH:** Activates the WX function (USA Version only).
- CD SRCH:** Engages the Tone or DCS Search Scanning feature.
- SCAN:** Engages the Scan operation.
- T CALL:** Activates 1750 Hz Tone Burst.
- TX POWER:** Set the transmission power level.
- MODE:** Change the communication mode (Digital/Analog).
- GM:** Activates the GM (Group Monitor) function.
- WIRES-X:** Activates the WIRES-X function.
- REV:** Reverses the transmit and receive frequencies while working through a repeater.
- DW:** Engages Dual Watch feature.

Alternatively, one of the Set Menu items previously assigned may be set. To assign another desired Set Mode item to a programmable key, see the description in the box shown below (except Set mode items #31 and #32).

3. Press and hold the [MHz(SETUP)] key to exit to normal operation.

You may assign Set Mode items to the Microphone [P3]/[P4] buttons.

1. Press and hold the [MHz(SETUP)] key to enter the Set mode.
2. Rotate the **DIAL** knob to select the Set Mode Item that you wish to assign to the key as a Menu short cut.
3. Press and hold the Microphone's [P3] or [P4] key to assign the Set Mode Item to that button.
4. Now you can recall this preferred Set Mode Item by simply pressing the Microphone button momentarily.

Advanced Operation

Selecting the Squelch Type in the Analog FM Mode

1. Press and hold the **[MHz(SETUP)]** key to enter the Set mode.
2. Rotate the **DIAL** knob to select “**SQL TYPE 44**”.
3. Press the **[MHz(SETUP)]** key, then rotate the **DIAL** knob to select the squelch type.



Tone squelch (CTCSS), DCS and the New PAGER (EPCS) functions do not operate in the C4FM digital mode. Press the **[MODE(DG-ID)]** key to switch the communication mode to AMS (Auto Mode Select function) or analog (FM) mode.

Squelch type	Icon indication	Description
OFF	-	Deactivates the tone squelch function and DCS function OFF, then returns to the normal squelch operation in the Analog FM mode.
TONE	T (appears)	Analog FM Transmissions contain the CTCSS tone. Receives as a normal squelch operation.
TSQL	T SQ (appears)	Activates the CTCSS tone squelch function on Analog FM receive.
DCS	DCS (appears)	Activates the Digital Code Squelch (DCS) function. The DCS code may be selected from 104 codes (from 023 to 754).
RV TONE	T SQ (blinks)	Activates the reverse tone function. Used to monitor communications based on the squelch control system. When a signal contains the designated tone, the squelch is not opened, and when the tone signal disappears, the squelch opens and communication starts.
PAGER	P (appears)	Activates a new two-tone CTCSS pager function. When communicating with FTM-7250DR/DE transceivers among friends, specify personal codes (each code is composed of two tones) so that you can call only specific stations.
D CODE*	DCS (blinks)	Transmits the signal containing the DCS CODE. Receives as a normal squelch operation.
T DCS*	T (blinks) DCS (appears)	Sends a tone signal when transmitting, and receives the only signal matches the DCS code when receiving.
D TONE*	T SQ (appears) DCS (blinks)	Sends the DCS CODE when transmitting, and receives only signals that contain a matching tone signal when receiving.

*: Turning the Set Mode “**SQL EXP 43**” to ON, “**D CODE**”, “**T DCS**” and “**D TONE**” setting values are activated.

4. Press and hold the **[MHz(SETUP)]** key to save the new setting and exit to normal operation.

- The squelch type may be set for each frequency band (BAND).
- The CTCSS and DCS squelch settings are also active during scanning. If scanning is performed with the CTCSS and DCS squelch function activated, scanning stops only when a signal containing the specified CTCSS tone or DCS code is received.
- Pressing the programmable key on the MH-48A6JA Microphone that is assigned “SQL OFF” allows signals that do not contain a tone or DCS code, and signals with different tones, DCS codes, digital mode signals to all be heard.
- Set Mode “**DCS INV 11**” (see page 29) allows to receive the DCS code of the inverted phase.



Advanced Operation

CTCSS Operation

This radio is equipped with the CTCSS (Continuous Tone-coded Squelch System) that allows audio to be heard only when receiving signals containing a tone corresponding to the tone squelch menu setting. By matching the CTCSS tone with the partner station in advance, quiet standby monitoring is possible.

Note: CTCSS does not function in digital mode. To transmit a signal using a CTCSS code, use the **[MODE(DG-ID)]** key to switch the communication mode to AMS (Auto Mode Select function) or analog (FM) mode.

1. Press and hold the **[MHz(SETUP)]** key to enter the Set mode.
2. Rotate the **DIAL** knob to select “SQL TYPE 44”.

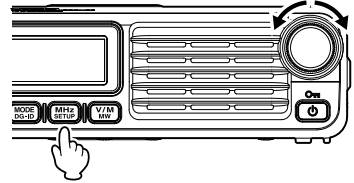

3. Press the **[MHz(SETUP)]** key, then rotate the **DIAL** knob to select “TSQ”.
4. Press and hold the **[MHz(SETUP)]** key to save the new setting and exit to normal operation.

“T SQ” is displayed on the screen. Now the squelch opens only when receiving tone signals of the set frequency.

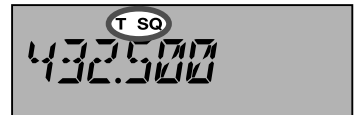
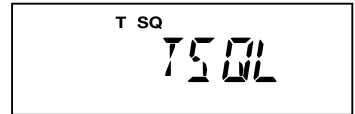
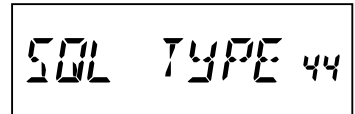

Note: From the Setup Menu, you can change the CTCSS setting.

TONE FRQ 47 ➡ The tone frequency can be selected from 50 frequencies.

BELL 7 ➡ A bell tone (beep) may be set to sound when signals containing a corresponding CTCSS tone are received.

Advanced Operation

Tone Search

When the CTCSS tone being transmitted by another station is not known, you can tune the radio to the incoming signal and activate tone scan to search for and identify the tone being used.

To scan for the tone in use:

1. Set the transceiver up for CTCSS operation (see page 5 for details.).

“**T SQ**” will appear on the display.

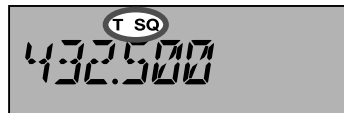

2. Press the Programmable key on the MH-48A6JA Microphone that is assigned “CD SRCH” (see page 3) to start scanning for the incoming CTCSS code.
3. When the radio detects the correct tone, scanning will halt on that tone, and audio will be allowed to pass.
4. Press the assigned Programmable key of the Microphone to lock in that tone and exit to normal operation.

Note: You may listen to the (muted) signals from the other stations during Tone Scanning when Set Mode Item “**TS MUTE 49**” is set to “OFF”. See page 39 for details. You can also change the Tone Search scanning speed, using Set Mode Item “**TS SPEED 50**” See page 39 for details.

Advanced Operation

DCS Operation

This radio is equipped with a DCS (Digital Coded Squelch) function that allows audio to be heard only when signals containing the corresponding DCS code are received. By matching the DCS code with the partner stations beforehand, a quiet receive standby is possible..

Note: DCS does not function in digital mode. To transmit a signal with a DCS code, use the **[MODE(DG-ID)]** key to switch the communication mode to AMS (Auto Mode Select function) or analog (FM) mode.

1. Press and hold the **[MHz(SETUP)]** key to enter the Set mode.
2. Rotate the **DIAL** knob to select “SQL TYPE 44”.

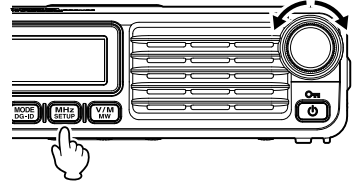

3. Press the **[MHz(SETUP)]** key, then rotate the **DIAL** knob to select “DCS”.
4. Press and hold the **[MHz(SETUP)]** key to save the new setting and exit to normal operation.

“DCS” is displayed on the screen. The squelch opens only when receiving a signal containing the corresponding DCS code..

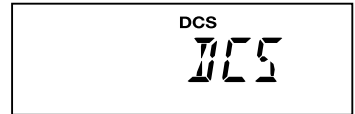
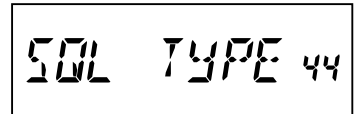

Note: From the Setup Menu, you can change the DCS setting.

DCS CODE 10 ➡ The DCS code can be selected from 104 codes.

BELL 7 ➡ A bell tone (beep) may be set to sound when signals containing a corresponding DCS code are received.

Advanced Operation

DCS Search

When the DCS code being transmitted by another station is not known, you can tune the radio to the incoming signal and activate DCS code scan to search for and identify the DCS code being used.

To scan for the DCS in use:

1. Set the transceiver up for DCS operation.

“DCS” will appear on the display.



2. Press the Programmable key on the MH-48A6JA Microphone that is assigned “CD SRCH” (see page 3) to start scanning for the incoming DCS code.
3. When the radio detects the correct code, scanning will halt on that code, and audio will be allowed to pass.
4. Press the assigned Programmable key of the Microphone to lock in that tone and exit to normal operation.

Note: You may listen to the (muted) signals from the other stations during DCS Scanning when Set Mode Item “**TS MUTE 49**” is set to “OFF”. See page 39 for details. You can also change the DCS Search scanning speed, using Set Mode Item “**TS SPEED 50**” See page 39 for details.

Advanced Operation

Split Tone Operation

The FTM-7250DR/DE can be configured to operate in a “Split Tone” system via the Setup menu, to facilitate operation on repeaters using a mix of both CTCSS and DCS control.

1. Press and hold the [MHz(SETUP)] key to enter the Set mode.
2. Rotate the **DIAL** knob to select “SQL EXP 43”.
3. Press the [MHz(SETUP)] key, then rotate the **DIAL** knob to select “ON”.

Default: OFF

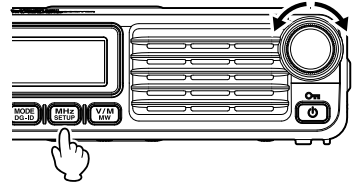

SQL EXP 43

4. Press the [MHz(SETUP)] key momentarily, then rotate the **DIAL** knob to select “SQL TYPE 44”.
5. Press the [MHz(SETUP)] key, and then rotate the **DIAL** knob to select the following parameters.

SQL TYPE 44

D CODE: DCS Encode only (the “DCS” icon will blink during operation)

DCS
D CODE

T DCS: Encodes a CTCSS Tone and Decodes a DCS code (the “T” icon will blink and the “DCS” icon will appear during operation)

T DCS
T DCS

D TONE: Encodes a DCS code and Decodes a CTCSS Tone (the “T SQ” icon will appear and “DCS” icons will blink during operation)

T SQ DCS
D TONE

6. Press and hold the [MHz(SETUP)] key to save the new setting and exit to normal operation.

Advanced Operation

EPCS (Enhanced Paging & Code Squelch) Operation

The FTM-7250DR/DE includes an Enhanced CTCSS tone encoder/decoder and a dedicated microprocessor providing paging and selective calling features. This allows placing a call to a specific station (Paging), and choosing to receive calls directed only to you (Code Squelch).

The paging and code squelch systems use two pairs of (alternately switched) CTCSS tones, which are stored in the pager memories. Basically, your receiver remains silent until it receives the CTCSS tone pair that matches those stored in the Receiving Pager Memory. The squelch then opens so the caller is heard, and the paging ringer immediately sounds, if activated. When you close the PTT switch to transmit, the CTCSS tone pair that is stored in the Transmitting Pager Memory will be transmitted automatically.

On the paged radio, the squelch will close automatically after the incoming page ends.

Storing CTCSS Tone Pairs for EPCS Operation

1. Press and hold the **[MHz(SETUP)]** key to enter the Set mode.
2. Rotate the **DIAL** knob to select “**PAG CD-R 29**” for the Receiving CTCSS Tone Pair or “**PAG CD-T 30**” for the Transmitting CTCSS Tone Pair.

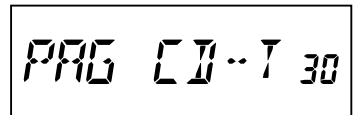
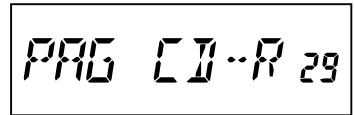
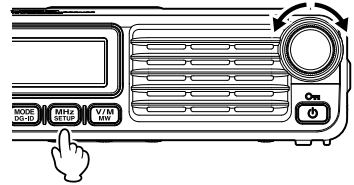

3. Press the **[MHz(SETUP)]** key momentarily to enable adjustment of this Set Mode Item.
4. Rotate the **DIAL** knob to set the CTCSS Tone number, which corresponds to the first tone of the CTCSS Tone Pair.
5. Press the **[BAND(SQL)]** or **[V/M(MW)]** key, then rotate the **DIAL** knob to set the CTCSS Tone number, which corresponds to the second tone of the CTCSS Tone Pair.
6. Press and hold the **[MHz(SETUP)]** key to lock in that tone and exit to normal operation.



Note: The FTM-7250DR/DE does not recognize the order of the 1st tone and the 2nd tone. In other words, for example, the FTM-7250DR/DE considers both CTCSS pairs “05, 47” and “47, 05” to be identical.

Advanced Operation

Activating the Enhanced Paging & Code Squelch System

1. Press and hold the [MHz(SETUP)] key to enter the Set mode.
2. Rotate the **DIAL** knob to select “SQL TYPE 44”.

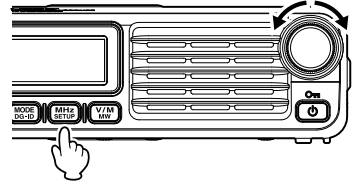

SQL TYPE 44

3. Press the [MHz(SETUP)] key, and then rotate the **DIAL** knob to select “PAGER”.

Default: OFF

PAGER

4. Press and hold the [MHz(SETUP)] key to save the new setting and exit to normal operation.
5. To disable the Enhanced Paging & Code Squelch, just repeat the above procedure, rotating the **DIAL** knob to select “OFF” in step 3 above.

When the Enhanced Paging & Code Squelch feature is activated, the “P” notation will appear on the right of the frequency display.

432.500 P

Notification of a Call from a Remote Station by the Bell Function

The Bell may be set to sound an Alert when a call from another station containing a corresponding tone, DCS or pager code is received. “🔔” icon on the LCD blinks to provide a later notice of the call from the other station.

1. Press and hold the [MHz(SETUP)] key to enter the Set mode.
2. Rotate the **DIAL** knob to select “BELL 7”.
2. Press the [MHz(SETUP)] key.

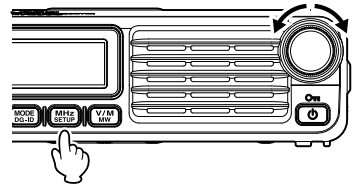

BELL 7

Advanced Operation

3. Rotate the **DIAL** knob to select the desired number of times (1-20 times or continuous) the Bell rings.



3 TIMES

Default: OFF

- ▣ OFF ▣ 1 TIME ▣ 2 TIMES ▣ 20 TIMES ▣ CONTINUE (continuous) ▣
4. Press and hold the **[MHz(SETUP)]** key to save the new setting and exit to normal operation.

Advanced Operation

DTMF Operation

DTMF tones (Dual Tone Multi Frequencies) are the tones you hear when dialing from a telephone keypad. The FTM-7250DR/DE transceiver can transmit the DTMF codes by using the keys on the microphone or recalling registered number strings from memories. The maximum of 16-digit DTMF codes can be registered in up to 10 memory channels. It is convenient to register telephone patch numbers, and network linking sequences to the DTMF memory channels.

Note: The two combined frequencies of the DTMF tone transmitted for each key are indicated in the following table:

	1209 Hz	1336 Hz	1477 Hz	1633 Hz
697 Hz	1	2	3	A
770 Hz	4	5	6	B
852 Hz	7	8	9	C
941 Hz	*	0	#	D

Transmitting a DTMF code manually

You can generate DTMF tones during transmission manually.

1. Press and hold the **[MHz(SETUP)]** key to enter the Set mode.
2. Rotate the **DIAL** knob to select “DT AUTO 16”.

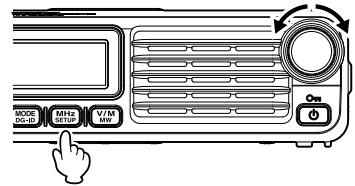

3. Press the **[MHz(SETUP)]** key momentarily, and then rotate the **DIAL** knob to select “MANUAL”.

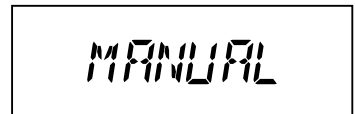

4. Press and hold the **[MHz(SETUP)]** key to save the new setting and exit to normal operation.
5. While pressing and holding **PTT**, press the desired DTMF characters ([0] to [9], [*], [#], or [A] to [D]), sequentially on the microphone keypad.
- 6 Release **PTT**.

While transmitting the DTMF code, transmission status is sustained even when **PTT** is released.

Advanced Operation

Registering a DTMF code

1. Press and hold the [MHz(SETUP)] key to enter the Set mode.
2. Rotate the **DIAL** knob to select “DT SET 18”.

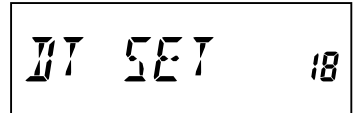
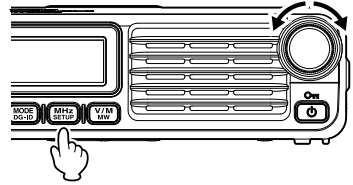

3. Press the [MHz(SETUP)] key momentarily, then rotate the **DIAL** knob to select the desired memory channel (C0 to C9) to register the DTMF code.
4. Press the [V/M(MW)] key momentarily, then rotate the **DIAL** knob to select the first digit of the DTMF code.

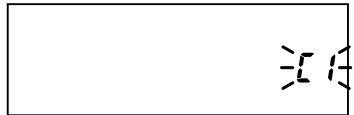

Note: You can also use the keypad on the microphone to input the DTMF code.

5. When you have selected the correct digit, press the [V/M(MW)] key momentarily. Now, rotate the **DIAL** knob to select the second of 16 available numbers in the current DTMF Autodialer memory register.



6. Repeat this procedure for each digit in the DTMF code.

Note: ○ To make a correction, press the [BAND(SQL)] key to back-space the cursor, then re-enter the correct number.

○ Press and hold the [GM(AMS)] key to delete all data after the cursor that may have been previously stored.

7. When entry of all digits is complete, press and hold the [MHz(SETUP)] key to set the DTMF code and exit to normal operation.

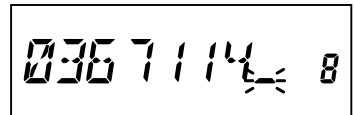

Advanced Operation

Transmitting the registered DTMF code

1. Press and hold the [MHz(SETUP)] key to enter the Set mode.
2. Rotate the **DIAL** knob to select “DT AUTO 16”.

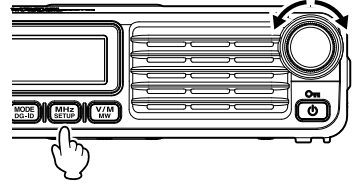

DT AUTO 16

3. Press the [MHz(SETUP)] key momentarily, and then rotate the **DIAL** knob to select “AUTO”.

AUTO 

4. Press and hold the [MHz(SETUP)] key to save the new setting and exit to normal operation.

Note: While the DTMF Autodialer is activated, the  icon will appear on the LCD.

432.500 

5. In the Autodialer mode, which you just engaged, first press the **PTT** switch, then press the microphone numeric key ([0] through [9]) corresponding to the DTMF memory string you wish to send. Once the string begins, you may release the **PTT** switch, as the transmitter will be held “on the air” until the DTMF string is completed.

To disable the Autodialer function mode, select “MANUAL” in step 3 above.

Setting DTMF Autodialer sending Speed

The speed at which the DTMF digits are sent can be changed.

1. Press and hold the [MHz(SETUP)] key to enter the Set mode.
2. Rotate the **DIAL** knob to select “DT SPEED 19”.
3. Press the [MHz(SETUP)] key momentarily, and then rotate the **DIAL** knob to select the desired speed (“50 MS”: High speed or “100 MS”: Low speed).
4. Press and hold the [MHz(SETUP)] key to save the new setting and exit to normal operation.

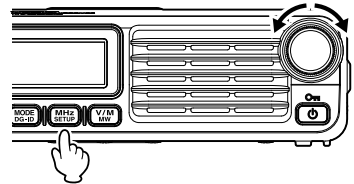

DT SPEED 19

50 MS

Advanced Operation

Setting DTMF Autodialer TX delay time

A longer delay may be set between the time the transmitter is keyed and the first DTMF digit is sent:

1. Press and hold the **[MHz(SETUP)]** key to enter the Set mode.
2. Rotate the **DIAL** knob to select “DT DELAY 17”.
3. Press the **[MHz(SETUP)]** key momentarily, and then rotate the **DIAL** knob to select the desired delay time (50 MS / 250 MS / 450 MS / 750 MS / 1000 MS).

Default: 450 MS

4. Press and hold the **[MHz(SETUP)]** key to save the new setting and exit to normal operation.

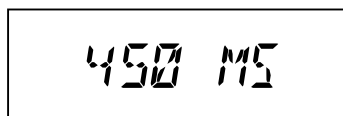
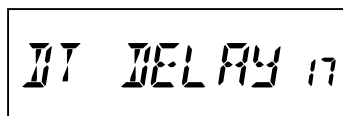
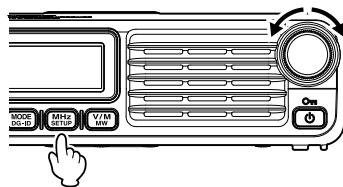

Checking the Repeater Uplink (Input) Frequency

It is often helpful to be able to check the uplink (input) frequency of a repeater, to see if the calling station is within direct (“Simplex”) range.

Note: This function can only be used through the programmable keys [P1] to [P4] on the microphone.

Refer to the “Programming the Key Assignments” on page page 3.

To do this (Example: When “REV” is assigned to **[P4]**):

1. Press the Microphone **[P4]** key.
You’ll notice that the display has shifted to the repeater uplink frequency.

While listening on the repeater input frequency using the **[P4]** key, the repeater offset icon will blink.

2. Press the **[P4]** key again to cause operation to revert to normal monitoring of the repeater downlink (output) frequency.



Memory Operation

Split Memory

A separate transmit frequency may be registered to a memory channel to which a receive frequency has already been registered.

1. In the VFO mode, select the transmit frequency to be registered.
2. Press and hold the [V/M(MW)] key.
A memory number will appear in the bottom right corner of the display.
3. Rotate the **DIAL** knob (if necessary) to select the memory channel to which the transmit frequency is to be registered.
4. Press and hold the **PTT**, and press the [V/M(MW)] key momentarily while holding in the **PTT**. This will not cause transmission, but rather it will instruct the transceiver to program the separate *transmit* frequency into memory.

Whenever a memory which contains independently stored transmit and receive frequencies is recalled, the “- +” indication will appear in the display.



Moving Memory Data to the VFO

The data stored on a memory channel can easily be moved to the VFO.

1. Select the memory channel containing the frequency data to be moved to the VFO.
2. Press and hold the [V/M(MW)] key, and then press the [MHz(SETUP)] key. The “VFO WRT?” will appear on the display.



3. Press the [V/M(MW)] key, the data will now have been copied to the VFO, although the original memory contents will remain intact on the previously-stored channel.

Note: If a split Frequency Memory channel was transferred, the TX frequency will be ignored (The transceiver will be set up for Simplex operation on the Receive frequency.)

Memory Only Mode

When memory channel programming has been completed, you may place the radio in a “Memory Only” mode, whereby VFO operation is impossible. This may be particularly useful during public-service events where a number of operators may be using the radio for first time, and ultimate simplicity of channel selection is desired.

To place the radio into the Memory Only mode, turn the transceiver OFF. Now press and hold the [V/M(MW)] key while turning the transceiver ON. The VFO and Home Channel will now be disabled.

To return to normal operation, repeat the above power-on procedure.

Memory Operation

Naming a Memory Channel

You may wish to append an alphanumeric “Tag” (label) to each memory, to aid in recollection of the channel’s use (such as club name, etc.).

1. Recall the memory channel on which you wish to append a label.
2. Press and hold the **[MHz(SETUP)]** key to enter the Set mode.
3. Rotate the **DIAL** knob to select “MEM NAME 26”.
4. Press the **[MHz(SETUP)]** key momentarily to enable programming of the nametag.
5. Use the numeric keypad or **DIAL** knob to input the characters.

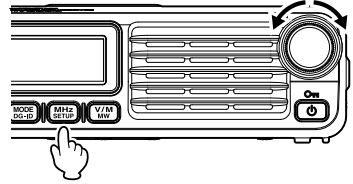

Press the **[V/M(MW)]** key to move to the next character.

- Inputting characters

Example quickly Pressing the **[2]** key, each time switches the following characters:

a → b → c → A → B → C → a →

Example Rotating the **DIAL** switches the following characters.

••• ↔ A - Z ↔ (symbol) ↔ a - z ↔ (symbol) ↔
↔ 0 - 9 ↔ (symbol) ↔ •••

- Moving the cursor, deleting the input character
[V/M(MW)] key: Moves the cursor to the right
[BAND (SQL)] key: Moves the cursor to the left

Pressing and holding the **[GM (AMS)]** key: Erases all characters after the cursor

6. Repeat step 5 to program the remaining letters, numbers, or symbols of the desired label. A total of 8 characters may be used in the creation of a label.
7. When you have programmed a label that is under 8 characters, press the **[MHz(SETUP)]** key to confirm the label.
8. When you have completed the creation of the label, then press and hold the **[V/M(MW)]** key to save the label and exit.

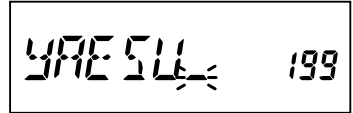
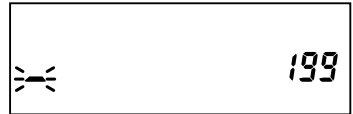

While operating in the Memory Recall mode, press the **[MHz(SETUP)]** key to toggle the display between indication of the frequency, and indication of the Alpha/Numeric label.



Scanning

Scan Resume Options

Select one of the three receiving operations to be performed after the scanning stops.

- (1) Restart scanning after receiving the frequency for the set amount of time. Select from 2.0 to 10.0 seconds (0.5 step).
- (2) Continue receiving the frequency until the signal disappears, and then restart scanning 2 seconds after the signal disappears (BUSY).
- (3) Stop scanning and receive that frequency (HOLD).

1. Press and hold the **[MHz(SETUP)]** key to enter the Set mode.
2. Rotate the **DIAL** knob to select "**SCAN RSM 39**".
3. Press the **[MHz(SETUP)]** key, then rotate the **DIAL** knob to select the desired scan-resume mode.

Default: 5.0 SEC

4. Press and hold the **[MHz(SETUP)]** key to save the new setting and exit to normal operation.

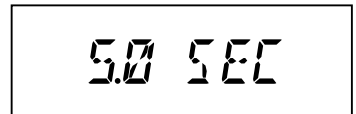
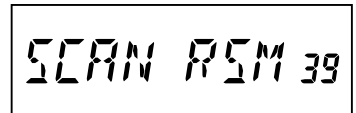
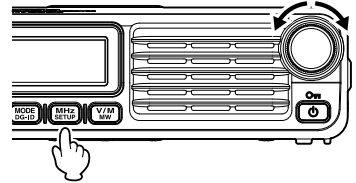

Scanning

Memory Skip Scanning

When some memory channels are continuously active, you may wish to *skip* them during *scanning*, but still have them available for *manual selection*.

To mask a memory to be skipped (only) during scanning, use the following procedure:

1. Set the radio to the Memory Recall mode by pressing the **[V/M(MW)]** key repeatedly, as necessary, until **"MR"** and a channel number appear on the right side of the display.
2. Rotate the **DIAL** knob to select the Memory Channel to be skipped during scanning.
3. Press and hold the **[MHz(SETUP)]** key, then rotate the **DIAL** knob to select **"SCAN SKP 40"**.

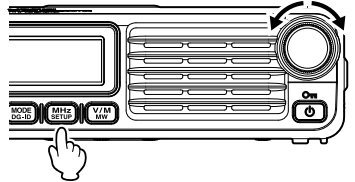
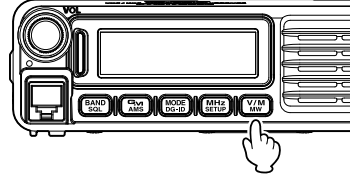

SCAN SKP 40

4. Press the **[MHz(SETUP)]** key, then rotate the **DIAL** knob to select **"SKIP"**. The current Memory Channel will now be ignored during scanning.

SKIP*

5. Press and hold the **[MHz(SETUP)]** key to save the new setting and exit to normal operation.

A blinking **"▶"** icon will appear when you recall the "skipped" memory channel manually.

To reinstate a channel into the scanning loop, select **"OFF"** in step 4 above, after first recalling the currently blocked channel (the "Skipped" channel is accessible via manual channel selection methods using the **DIAL** knob in the Memory mode, whether or not it is locked out of the scanning loop).

432.500 MR 199

Scanning

Preferential Memory Scan

The FTM-7250DR/DE also allows setting up a “Preferential Scan List” of channels, which you can “flag” within the memory system. The flagged channels are designated by an “▶” icon when they are selected, one by one, for the Preferential Scan List.

When memory scanning is initiated beginning on a channel with the “▶” *icon appended*, only those channels bearing the “▶” icon will be scanned. If scanning is initiated on a channel which does not have the “▶” icon appended, all channels including those with the “▶” icon appended will be scanned.

Here is the procedure for setting up and using the Preferential Scan List:

1. Set the radio to the Memory Recall mode by pressing the **[V/M(MW)]** key repeatedly, as necessary, until “MR” and a channel number appear on the right side of the display.
2. Rotate the **DIAL** knob to select the Memory Channel that you wish to add to the preferential Scan List.
3. Press and hold the **[MHz(SETUP)]** key, then rotate the **DIAL** knob to select “SCAN SKP 40”.

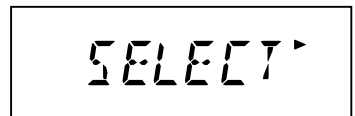
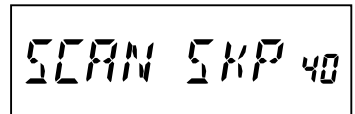
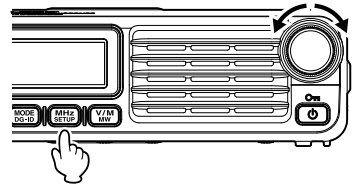
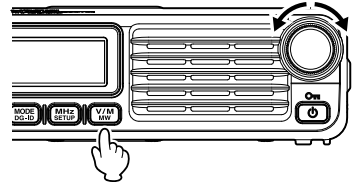

4. Press the **[MHz(SETUP)]** key, and then rotate the **DIAL** knob to select “SELECT”.
5. Press and hold the **[MHz(SETUP)]** key to save the new setting and exit to normal operation.

To initiate Preferential Memory Scanning:

1. Set the radio to the Memory Recall mode by pressing the **[V/M(MW)]** key repeatedly, if necessary.
2. Rotate the **DIAL** knob to select any memory channel which has an “▶” icon appended to the channel number.
3. Press and hold in either the microphone **[UP]** or **[DWN]** button to initiate Preferential Memory Scanning. Only the channels which have a “▶” icon appended to the channel number will be scanned.



Scanning

Programmable Memory Scan (PMS)

The FTM-7250DR/DE can be set to tune or scan only the frequencies between user-defined lower and band limits.

Example: Set up a PMS channel by registering a lower frequency of 432.500 MHz, and an upper frequency of 432.800 MHz to the L1/U1 memory channels.

Registering to the programmable memory channels

1. In the VFO mode, select the desired lower-limit scan frequency (432.500 MHz).
2. Press and hold the [V/M(MW)] key.
A memory number will appear in the bottom right corner of the display.
3. Rotate the **DIAL** knob to select "L1".

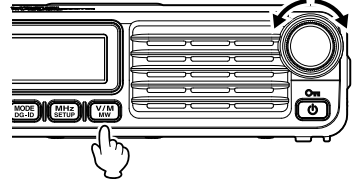

Note: While operating in the Memory Storage mode, the keypad of the MH-48A6JA Microphone may be used to enter the memory channel number directly.

To do this, enter the desired Channel Number (see table below) on the keypad.

To enter Memory Channel "L1", press [2] ➡ [0] ➡ [1]

To enter Memory Channel "U0", press [2] ➡ [2] ➡ [0]

L1	201	L3	205	L5	209	L7	213	L9	217
U1	202	U3	206	U5	210	U7	214	U9	218
L2	203	L4	207	L6	211	L8	215	L0	219
U2	204	U4	208	U6	212	U8	216	U0	220

4. Press the [V/M(MW)] key again, momentarily, to store the displayed data into the memory channel (L1).
5. Select the desired upper-limit scanning frequency (432.800 MHz).
6. Rotate the **DIAL** knob to select "U1".
7. Press the [V/M(MW)] key again, momentarily, to store the displayed data into the memory channel (U1).



Scanning

Scanning the programmable memory channels

1. Press the **[V/M(MW)]** key to enter memory mode.
2. Turn the **DIAL** knob, or use the microphone keypad, to recall the upper or lower frequency PMS memory channel (L_n or U_n).
3. Press the **[#]** key on the MH-48A6JA Microphone.
“P1” appear on the right side of the display.
4. Press and hold **[UP]** or **[DWN]** on the microphone.
Programmable memory scanning will begin.

Note: To stop programmable memory scanning, press **PTT** on the microphone (this does not cancel PMS mode).

To cancel PMS mode, when programmable memory scanning stops, press the **[#]** key on the MH-48A6JA Microphone.

Band Edge Beeper

The FTM-7250DR/DE will automatically “beep” when the receive band edge is encountered during scanning (either in standard VFO scanning or during PMS operation). Additionally, the band edge beep feature may be enabled to sound when the band edge frequency is reached while tuning the VFO, using the **DIAL** knob.

The procedure to enable the Band-Edge Beeper (during manual tuning) is:

1. Press and hold the **[MHz(SETUP)]** key, then rotate the **DIAL** knob to select “**BEP EDGE 4**”.
2. Press the **[MHz(SETUP)]** key, and then rotate the **DIAL** knob to set this Menu item to “**ON**”.
3. Press and hold the **[MHz(SETUP)]** key to save the new setting and exit to normal operation.

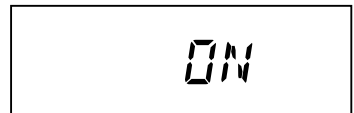
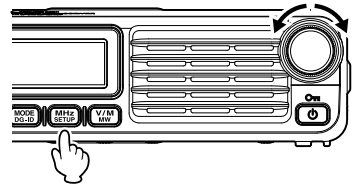

Priority Channel Scanning (Dual Watch)

The FTM-7250DR/DE's scanning features include a two-channel scanning capability which allows operating on a VFO, Memory channel, or Home channel, while periodically checking a user-defined Memory Channel for activity. If a station received on the Memory Channel is strong enough to open the Squelch, the scanner will pause on that station in accordance with the Scan-Resume mode setting of Menu item "**SCAN RSM 39**" See page 19.

Here is the procedure for activating Priority Channel Dual Watch operation:

1. Set the transceiver to the Memory Recall mode by pressing the [V/M(MW)] key repeatedly, if necessary.
2. Press and hold the [V/M(MW)] key, then select the memory channel you wish to be the "Priority" channel.
3. Press the [MODE(DG-ID)] key momentarily. The "PRI CH?" will appear on the display.
4. Press the [MODE(DG-ID)] key momentarily.

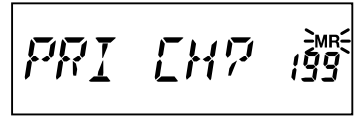

Note: The "P" icon will appear to the memory channel number for one second, indicating it is the Priority channel while recalling the channel.

5. Now set the FTM-7250DR/DE for operation on another memory channel, Home channel, or on a VFO frequency.
6. Press the programmable key on the MH-48A6JA Microphone that is assigned "DW" (see page 3). The display will remain on the VFO, the selected memory channel, or the Home channel, but every five seconds the FTM-7250DR/DE will check the Priority Channel for activity.

Note: During Dual Watch operation, the decimal points of the frequency display blink.

7. To cancel Dual Watch operation, press the programmable key on the MH-48A6JA Microphone that is assigned "DW".

Priority Revert Mode

During Priority channel operation (Dual Watch), a special feature is available which will allow you to move to the Priority Channel instantly, without waiting for activity to appear on the Priority Channel.

When this feature is enabled, and priority monitoring is engaged, just press the microphone PTT switch. Operation will instantly revert to the Priority Channel.

1. Press and hold the [MHz(SETUP)] key, then rotate the DIAL knob to select "DW RVRT 20".
2. Press the [MHz(SETUP)] key, and then rotate the DIAL knob to set this Menu item to "ON".
3. Press and hold the [MHz(SETUP)] key to save the new setting and exit to normal operation.

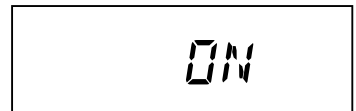
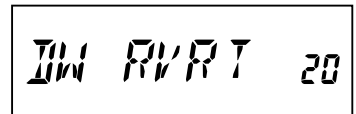

To disable Priority Revert operation, select "OFF" in step 2 above.

GM Function

About the GM(Group Monitor) feature

The GM (Group Monitor) function automatically checks to find if there are any stations with the GM function in operation with the same DG-ID number within communication range. Setting the receive DG-ID number to "00" will check for all the C4FM digital stations In/Out of range.

- Note:**
- Activating the GM (Group Monitor) function, the Digital C4FM mode is changed.
 - For communicating in the Analog FM mode, Set the GM function OFF.
 - The other member stations must also turn the GM (Group Monitor) function ON.

When the GM (Group Monitor) is activated, the following information screens are automatically switched.

GM information screen

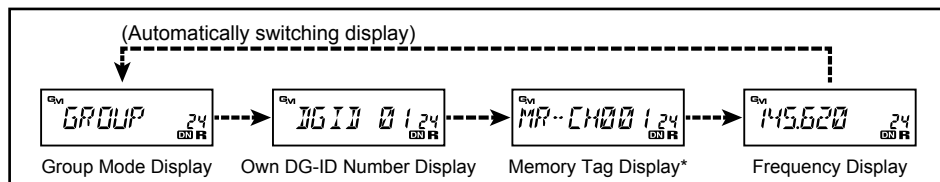

*: Memory tag display is displayed in the case of the memory channel or the home channel setting the memory tag.

In / Out Display

- When another station with the same DG-ID number is within the communication range, a beep sounds and the "R" is displayed, and the lower portions of the Mode/Status indicator light blue.
- When all the members are out of the communication range, "R" (blinks) is displayed and the Mode/Status indicator light is off.
- When a signal from another member station is received, the call sign of the other station is displayed on the LCD for about 10 seconds.

Note: When the DG-ID transmit and receive are set to "00" in the factory default setting, all stations In/Out of range may be received and are displayed, but the other stations that set their receive DG-ID number to other than "00" may not be receiving your signals.

GM Function

Displaying the information of the other station received by GM (Group Monitor) function

- When receiving the signals with the same DG-ID number, press the [MODE(DG-ID)] key to reveal the other station information:
 - Depending on the model, the information such as the call sign of the other station, latitude, longitude and so on may be displayed.
 - When receiving the signals of multiple stations, press the [MODE(DG-ID)] key to display the call sign of the other station, and then rotate the **DIAL** knob to select the other stations to be displayed on the LCD.
 - Up to 24 stations may be displayed in order of their reception.

Note:

- The FTM-7250DR/DE may not send its own location information because the FTM-7250DR/DE is not equipped with the GPS function.
- The position information is displayed only when the latitude and longitude information is included in the signal of the other station.
- The transceivers that may transmit position information with the GM function are as follows: (As of Mar. 2018).
FTM-400XD/FTM-400D series, FTM-100D series, FT2D, FT1XD, FT1D, FT-991A/FT-991*

(*: Latitude and longitude setting must be entered manually, or an external GPS device must be connected.).

GM information screen

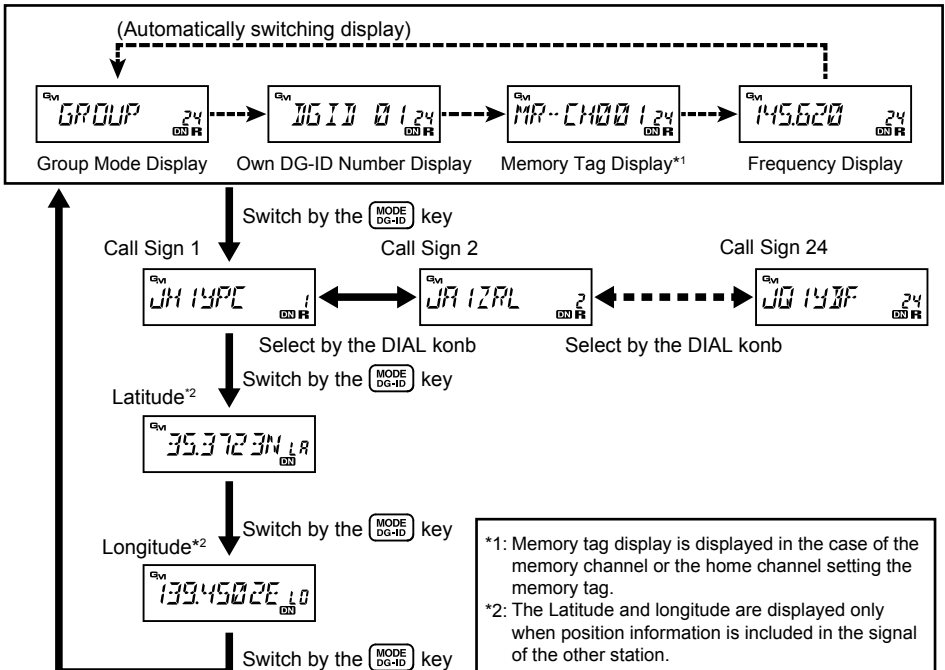

GM Function

GM Alert Beep

To alert you to the current status of GM operation, the GM (Group Monitor) feature allows two kinds of alert beeps (with the additional option of turning them off). Depending on your location and the potential annoyance associated with frequent beeps, you may choose the Beep mode which best suits your needs.

1. Press and hold the **[MHz(SETUP)]** key, then rotate the **DIAL** knob to select “GM RINGR 21”.
2. Press the **[MHz(SETUP)]** key, and then rotate the **DIAL** knob to select one of the following parameters.

IN RANGE: Beeps sound only when the radio first detects that a station is within range.

ALWAYS: Beeps sound every time a polling transmission is received from another station.

OFF: No alert beeps sound.

Default: IN RANGE

3. Press and hold the **[MHz(SETUP)]** key to save the new setting and exit to normal operation.

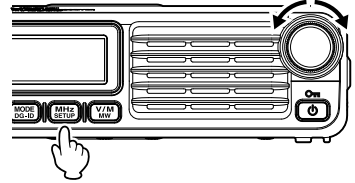

GM Polling Interval

The GM (Group Monitor) feature may be programmed to poll normal time (default value) or long time. To change the polling interval:

1. Press and hold the **[MHz(SETUP)]** key, then rotate the **DIAL** knob to select “GM INTVL 22”.
2. Press the **[MHz(SETUP)]** key, then rotate the **DIAL** knob to select the desired polling interval (NORMAL or LONG).

Default: NORMAL

3. Press and hold the **[MHz(SETUP)]** key to save the new setting and exit to normal operation.

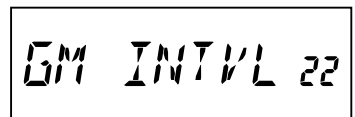
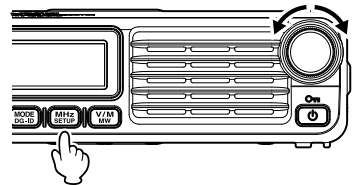

Clone

The FTM-7250DR/DE includes a convenient “Clone” feature, which allows the memory and configuration data from one transceiver to be transferred to another FTM-7250DR/DE.

This can be particularly useful when configuring a number of transceivers for a public service operation.

Here is the procedure for cloning data from one radio to another:

1. Turn both radios OFF.
2. Connect the user-constructed cloning cable between the MIC jacks of the two radios.
3. Press and hold the **[MHz(SETUP)]** key while turning the radios ON. Do this for both radios (the order of switch-on does not matter). “CLONE” will appear on the displays of both radios when the Clone mode is successfully activated in this step.
4. On the Destination radio; press the **[MHz(SETUP)]** key (“-- --WAIT-- --” will appear on the display).
5. On the Source radio; press the **[GM(AMS)]** key (“-- --TX-- --” will appear on the Source radio, and the data from this radio will be transferred to the destination radio.
6. If there is a problem during the cloning process, “ERROR” will be displayed. Check your cable connections and battery voltage, and try again.
7. If the data transfer is successful, “CLONE” will appear on the Source radio display. The destination radio, to which the data is copied, will restart automatically.
8. Turn both radios off and disconnect the cloning cable.

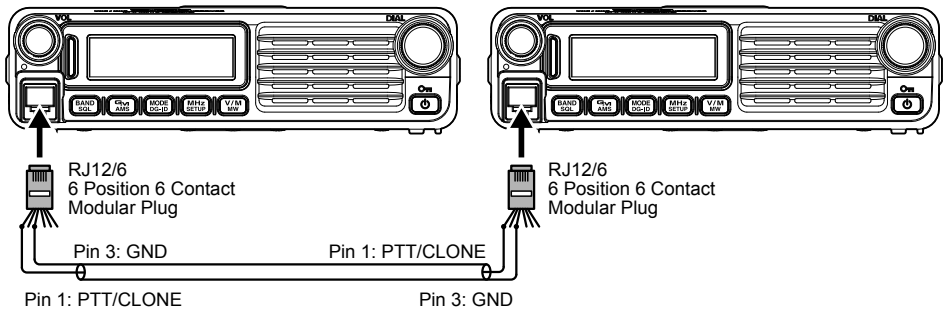
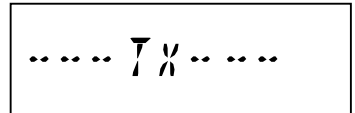
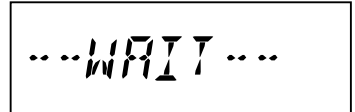
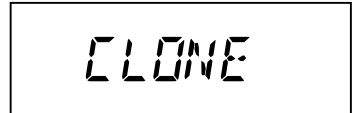
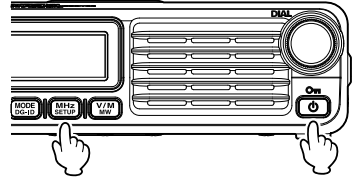

Setup (Menu) Mode

The FTM-7250DR/DE Setup (Menu) mode, already described in parts of many previous chapters, is easy to activate and setup. The Menus may be used to configure many of transceiver parameters, some of which have not been detailed previously. Use the following procedure to activate the Setup (Menu) mode:

1. Press and hold the **[MHz(SETUP)]** key to enter the Setup menu.
2. Rotate the **DIAL** knob to select the Menu Item to be adjusted.
3. Press the **[MHz(SETUP)]** key momentarily to enable adjustment of the selected Menu item, and then rotate the **DIAL** knob to perform the actual adjustment.
4. After completing the selection and adjustment, press and hold the **[MHz(SETUP)]** key to exit the Setup menu and resume normal operation.

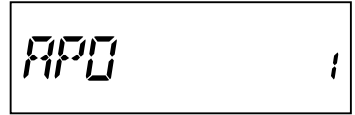
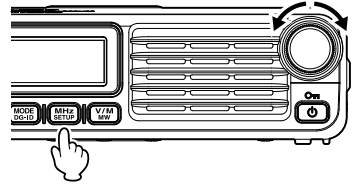

	Menu Item	Function	Available Values	Default
1	APO	Enables/Disables the Automatic Power Off feature.	0.5H to 12H (0.5H step)/OFF	OFF
2	BCLO	Enables/Disables the Busy Channel Lock-Out feature.	ON/OFF	OFF
3	BEP KEY	Enables/Disables the key beeper.	KEY+SCAN/KEY/OFF	KEY+SCAN
4	BEP EDGE	Enables/Disable the Band-edge beeper while scanning.	ON/OFF	OFF
5	BEP LVL	Sets the beep level	HIGH/LOW	HIGH
6	BEP STBY	Enables/Disable the Standby beep	ON/OFF	ON
7	BELL	Selects the CTCSS/DCS/EPCS Bell Ringer repetitions.	1 to 20/CONTINUE/OFF	OFF
8	CLK TYPE	Shifting of the CPU clock frequency.	A/B	A
9	DC VOLT	Indicates the DC Supply Voltage.	---	---
10	DCS CODE	Setting of the DCS code.	104 standard DCS codes	023
11	DCS INV	Select a combination of DCS inversion codes in terms of communication direction.	NORMAL/INVERT/BOTH	NORMAL
12	DIG AMS	Sets the transmission mode	TXMANUAL/TX FMFIX/TX DIGTL/AUTO	AUTO
13	DIG VW	Turn the VW mode selection ON or OFF.	ON/OFF	OFF
14	DI POPUP	Sets the information pop-up time	2/4/6/8/10/20/30/60/CONTINUE/OFF	10 SEC
15	DPID LST	DP-ID list (Display/Register/Clear)	(Registered DP-ID)	---
16	DT AUTO	Enables/Disables the DTMF Autodialer feature.	MANUAL/AUTO	MANUAL
17	DT DELAY	Setting of the DTMF Autodialer TX Delay Time.	50/250/450/750/1000	450 MS

Setup (Menu) Mode

Menu Item		Function	Available Values	Default
18	DT SET	Loading of the DTMF Autodialer Memories.	---	---
19	DT SPEED	Setting of the DTMF Autodialer Sending Speed.	50/100	50 MS
20	DW RVRT	Enables/Disables the "Priority Channel Revert" feature.	ON/OFF	OFF
21	GM RINGR	Enables/Disables the alert sound when detecting stations within communication range	IN RANGE/ALWAYS/OFF	IN RANGE
22	GM INTVL	Selects the automatic sending interval.	NORMAL/LONG	NORMAL
23	LCD DMMR	Setting of the front panel display illumination level.	LEVEL 1/2/3/4	LEVEL 4
24	LOCK	Selects the Control Locking Lockout combination.	KEY + D I A L / P T T / KEY+PTT/DIAL+PTT/ ALL/KEY/DIAL	KEY+DIAL
25	MIC GAIN	Adjust the microphone gain level.	LEVEL 1 to 9	LEVEL 5
26	MEM NAME	Programming an Alpha/Numeric label for a Memory Channel.	---	---
27	MW MODE	Selects the method of selecting of channels for Memory Storage.	NEXT CH/LOWER CH	NEXT CH
28	OPEN MSG	Selects the Opening Message that appears when the radio is powered ON.	OFF/DC/MESSAGE	MESSAGE
29	PAG CD-R	Setting the Receiver Pager Code for the Enhanced CTCSS Paging & Code Squelch function.	---	05 47
30	PAG CD-T	Setting the Transmitting Pager Code for the Enhanced CTCSS Paging & Code Squelch function.	---	05 47
31	PRG P3	Programming the function assigned to Microphone [P3] key.	SQL OFF HOME WX CH ^{×2} CD SRCH SCAN T CALL TX POWER	WIRES-X
32	PRG P4	Programming the function assigned to Microphone [P4] key.	MODE GM WIRES-X REV DW Setup Menu Item #1 to 57 (except 31 and 32)	×1
33	RADIO ID	Displays the transceiver IDs	××××× (uneditable)	---
34	RF SQL	Adjusts the RF Squelch threshold level.	OFF/S1 to S8	OFF
35	RPT ARS	Activates/Deactivates the Automatic Repeater Shift feature.	ON/OFF	ON
36	RPT FREQ	Sets the magnitude of the Repeater Shift.	0.00 - 150.00 (MHz)	×1
37	RPT SFT	Sets the Repeater Shift direction.	-RPT/+RPT/SIMPLEX	+RPT

Setup (Menu) Mode

Menu Item		Function	Available Values	Default
38	RX MODE	Select the receive mode.	AUTO/FM/AM	AUTO
39	SCAN RSM	Selects the Scan Resume mode.	BUSY/HOLD/2-10 (SEC)	5.0 SEC
40	SCAN SKP	Selects the Memory Scan mode.	OFF/SKIP/SELECT	OFF
41	SCNW MEM	Set the memory scan frequency range.	ALL/BAND	ALL
42	SCNW VFO	Set the VFO scan frequency range.	ALL/BAND	BAND
43	SQL EXP	Enables/Disables the split CTCSS/DCS coding.	ON/OFF	OFF
44	SQL TYPE	Selects the Tone Encoder and/or Decoder mode.	TONE/TSQL/DCS/ RV TONE/PAGER/OFF	OFF
45	STEP	Sets the frequency synthesizer steps.	AUTO/5/6.25/10/12.5/15 /20/25/50/100 (kHz)	AUTO
46	TEMP	Indicates the final transistor & heatsink temperature.	---	---
47	TONE FRQ	Setting of the CTCSS Tone Frequency.	67.0 to 254.1 (Hz)	100.0 HZ
48	TOT	Sets the Time-Out Timer.	0.5 to 10.0 (MIN)/OFF	3.0 MIN
49	TS MUTE	Enables/Disables the receiver audio output while the Tone Search or DCS Search Scanner is activated.	ON/OFF	ON
50	TS SPEED	Selects the Tone Search or DCS Search Scanner speed.	FAST/SLOW	FAST
51	VER DISP	Displays the transceiver software version	CPU x.xx DSP x.xx	---
52	VFO MODE	Set the frequency setting range in the VFO mode by DIAL knob.	ALL/BAND	BAND
53 ^{※2}	WX ALERT	Enables/Disables the Weather Alert feature.	ON/OFF	OFF
54 ^{※2}	WX VOL	Selects the audio output level of the Weather Alert.	NOR VOL/MAX VOL	NOR VOL
55 ^{※2} (53)	W/N DEV	Reduction of the Microphone Gain/Deviation and receiver bandwidth.	WIDE/NARROW	WIDE
56 ^{※2} (54)	W-DGID	Setting of the WIRES-X DG-ID	AUTO/DGID01 - 99	AUTO
57 ^{※2} (55)	MY CALL	Sets your station call sign	-----	---

※1: Depends on the transceiver version.

※2: USA version.

Menu Selection Details

1 APO

Function: Enables/Disables the Automatic Power Off feature.

Available Values: 0.5 H to 12.0 H (0.5 H/step) / OFF

Default: OFF

2 BCLO

Function: Enables/Disables the Busy Channel Lock-Out feature.

Available Values: ON / OFF

Default: OFF

3 BEP KEY

Function: Enables/Disables the key beeper.

Available Values: KEY+SCAN / KEY / OFF

Default: KEY+SCAN

KEY+SCAN: The beeper sounds when any key is pressed, or when the scanner stops.

KEY: The beeper sounds when any key is pressed.

OFF: Beeper is disabled.

4 BEP EDGE

Function: Enables/Disable the Band-edge beeper while scanning.

Available Values: ON / OFF

Default: OFF

5 BEP LVL

Function: Sets the Beep volume

Available Values: High / Low

Default: High

6 BEP STBY

Function: Enables/Disable the Standby beep.

Available Values: ON / OFF

Default: ON

ON: Emits a beep when the partner station completes a transmission.

OFF: Does not emit a beep when the partner station completes a transmission.

7 BELL

Function: Selects the CTCSS/DCS/EPCS Bell Ringer repetitions.

Available Values: 1 TIME to 20 TIMES / CONTINUE (Continuous ringing) / OFF

Default: OFF

8 CLK TYPE

Function: Shifting of the CPU clock frequency.

Available Values: A / B

Default: A

This function is only used to move a spurious response "birdie", should it fall on a desired frequency. Select "A" for the normal operation.

Menu Selection Details

9 DC VOLT

Function: Indicates the DC Supply Voltage.

10 DCS CODE

Function: Setting of the DCS code.

Available Values: 104 standard DCS codes

Default: 023

DCS CODE															
023	025	026	031	032	036	043	047	051	053	054	065	071	072	073	
074	114	115	116	122	125	131	132	134	143	145	152	155	156	162	
165	172	174	205	212	223	225	226	243	244	245	246	251	252	255	
261	263	265	266	271	274	306	311	315	325	331	332	343	346	351	
356	364	365	371	411	412	413	423	431	432	445	446	452	454	455	
462	464	465	466	503	506	516	523	526	532	546	565	606	612	624	
627	631	632	654	662	664	703	712	723	731	732	734	743	754	-	

11 DCS INV

Function: Select a combination of DCS inversion codes in terms of communication direction.

Available Values: NORMAL / INVERT / BOTH

Default: NORMAL

NORMAL: Homeomorphic

INVERT: Inverted Phase

BOTH: Both Phase

12 DIG AMS

Function: Select the transmission mode when using the AMS function.

Available Values: TXMANUAL / TX FMFIX / TX DIGTL / AUTO

Default: AUTO

TXMANUAL: Automatically selects between the digital or analog mode according to the received signal. Additionally, briefly pressing [PTT] on the microphone switches between digital mode and analog mode.

TX FMFIX: Automatically selects between the digital or analog mode according to the received signal. Always switches to FM mode for transmission.

TX DIGTL: Automatically selects between the digital or analog mode according to the received signal. Always switches to DN mode for transmission.

AUTO: Automatically selects between the digital or analog mode according to the received signal. Briefly pressing [PTT] on the microphone does not change the mode.

13 DIG VW

Function: Enables/Disables the digital voice FR (VW) mode selection.

When pressing the [MODE(DG-ID)] key, set whether the digital voice FR (VW) mode may be selected or not.

Available Values: OFF / ON

Default: OFF

Menu Selection Details

14 DI POPUP

Function: Sets the information pop-up time.

Available Values: 2 SEC / 4 SEC / 6 SEC / 8 SEC / 10 SEC / 20 SEC / 30 SEC / 60 SEC
/ CONTINUE / OFF

Default: 10 SEC

15 DPID LST

Function: Registers the DP-ID of the other transceiver.

16 DT AUTO

Function: Enables/Disables the DTMF Autodialer feature.

Available Values: MANUAL / AUTO

Default: MANUAL

17 DT DELAY

Function: Setting of the DTMF Autodialer's TX Delay Time.

Available Values: 50 / 250 / 450 / 750 / 1000 ms

Default: 450 ms

18 DT SET

Function: Loading of the DTMF Autodialer Memories.

See page 14 for details.

19 DT SPEED

Function: Setting of the DTMF Autodialer Sending Speed.

Available Values: 50 (high speed) / 100 (low speed) ms

Default: 50 ms

20 DW RVRT

Function: Enables/disables the "Priority Channel Revert" feature.

Available Values: ON / OFF

Default: OFF

See page 24 for details.

21 GM RINGR

Function: Enables/Disables the alert sound when detecting stations within communication range.

Available Values: IN RANGE / ALWAYS / OFF

Default: IN RANGE

IN RANGE: Beeps sound only when the radio first detects a station within range.

ALWAYS: Beeps sound every time a polling transmission is received from the other station.

OFF: No alert beeps sound.

Menu Selection Details

22 GM INTVL

Function: Selects the automatic GM beacon interval.

Available Values: NORMAL / LONG

Default: NORMAL

23 LCD DMMR

Function: Setting of the front panel display's illumination level.

Available Values: LEVEL 1 - LEVEL 4

Default: LEVEL 4

24 LOCK

Function: Selects the Control Locking Lockout combination.

Available Values: KEY+DIAL / PTT / KEY+PTT / DIAL+PTT / ALL / KEY / DIAL

Default: KEY+DIAL

25 MIC GAIN

Function: Adjust the microphone gain level.

Available Values: LEVEL 1 - LEVEL 9

Default: LEVEL 5

26 MEM NAME

Function: Programming an Alpha/Numeric label for a Memory Channel.

See page 18 for details.

27 MW MODE

Function: Selects the method of selecting of channels for Memory Storage.

Available Values: NEXT CH / LOWER CH

Default: NEXT CH

NEXT CH: Stores the data into the memory channel which is next-highest from the ***last-recalled*** memory channel.

LOWER CH: Stores the data into the lowest-available "free" channel.

28 OPEN MSG

Function: Selects the Opening Message that appears when the radio is powered ON.

Available Values: DC / MESSAGE / OFF

Default: MESSAGE

DC: DC supply voltage

MESSAGE: Set by user. See below.

OFF: No Opening Message

Here's how to program the Opening Message:

1. Set this Set Mode Item to "MESSAGE".
2. Press the **[V/M(MW)]** key momentarily to enable programming of the opening message. You will notice the first character entry's location blinking.
3. Rotate the **DIAL** knob to select the first letter/number of the message, and then press the **[V/M(MW)]** key momentarily to move to the next character.

Menu Selection Details

4. Repeat the previous step as necessary to complete the message (up to 8 characters).
5. To correct a mistake, press the **[BAND(SQL)]** key to backspace the cursor; now re-enter the correct letter/number.
6. When the desired opening message is completed, press the **[MHz(SETUP)]** key momentarily to confirm the message, then press and hold the **[MHz(SETUP)]** key to save the settings and exit to normal operation.

29 PAG CD-R

Function: Setting the Receiver Pager Code for the Enhanced CTCSS Paging & Code Squelch function

See page 10 for details.

30 PAG CD-T

Function: Setting the Transmitting Pager Code for the Enhanced CTCSS Paging & Code Squelch function.

See page 10 for details.

31 PRG P3

Function: Programming the function assigned to Microphone **[P3]** key.

Available Values: SQL OFF / HOME / WX CH* / CD SRCH / SCAN / T CALL / TX POWER / MODE / GM / WIRES-X / REV / DW or one of the all Set mode items (except Set mode items #31 and #32).

Default: WIRES-X

*: USA version only

32 PRG P4

Function: Programming the function assigned to Microphone **[P4]** key.

Available Values: SQL OFF / HOME / WX CH* / CD SRCH / SCAN / T CALL / TX POWER / MODE / GM / WIRES-X / REV / DW or one of the all Set mode items (except Set mode items #31 and #32).

Default: Depends on the transceiver version.

*: USA version only

33 RADIO ID

Function: Displays the transceiver IDs.

RADIO ID is a 5-digit code consisting of alphanumeric characters that is written into the transceiver during factory production.

The RADIO ID cannot be edited.

34 RF SQL

Function: Adjusts the RF Squelch threshold level.

Available Values: S1 - S8 / OFF

Default: OFF

Menu Selection Details

35 RPT ARS

Function: Activates/Deactivates the Automatic Repeater Shift feature..

Available Values: ON / OFF

Default: ON

36 RPT FREQ

Function: Sets the magnitude of the Repeater Shift.

Available Values: 0.00 - 150.00 MHz

Default: Depends on the transceiver version.

37 RPT SFT

Function: Sets the Repeater Shift direction.

Available Values: -RPT / +RPT / SIMPLEX

Default: SIMPLEX

38 RX MODE

Function: Set the band receiving mode. Each band receive mode may be set.

Available Values: AUTO / FM / AM

Default: AUTO

AUTO: The receive mode (FM mode or AM mode) is automatically selected according to the frequency band in use.

FM: The selected frequency band is set to FM mode.

AM: The selected frequency band is set to AM mode.

39 SCAN RSM

Function: Selects the Scan Resume mode.

Available Values: BUSY / HOLD / 2.0 SEC - 10.0 SEC (0.5 SEC step)

Default: 5.0 SEC

BUSY: The scanner will hold until the signal disappears, then will resume when the carrier drops.

HOLD: The scanner will stop when a signal is received, and will not restart.

2.0 SEC - 10.0 SEC: The scanner will hold for the selected resume time, then resume scanning, whether or not the other station is still transmitting.

40 SCAN SKP

Function: Selects the Memory Scan mode.

Available Values: SKIP/SELECT/OFF

Default: OFF

SKIP: The scanner will "skip" the flagged channels during scanning.

SELECT: The scanner will only scan channels that are flagged (Preferential Scan List).

OFF: All memory channels will be scanned (the "flag" will be ignored).

Menu Selection Details

41 SCNW MEM

Function: Set the memory scan frequency range. Set the frequency band range while scanning in the memory mode.

Available Values: ALL / BAND

Default: ALL

ALL: All the memory channels are scanned without regard to the band of the registered frequency of the memory channels.

BAND: Only memory channels with frequencies registered to the same band as the channel on which scan is started are scanned.

42 SCNW VFO

Function: Set the VFO scan frequency range. Sets VFO scanning action, when the scanning reaches the end of a frequency band.

Available Values: ALL / BAND

Default: BAND

ALL: When scanning reaches the band edge, scanning continues into the next frequency band.

BAND: When scanning reaches the band edge, scanning repeats within the same frequency band.

43 SQL EXP

Function: Enables/Disables the split CTCSS/DCS coding.

Available Values: ON / OFF

Default: OFF

When this Set Mode Item is set to "ON", the following additional parameters are available after the "PAGER" parameter when configuring Set Mode Item "44 SQL TYPE":

D CODE: DCS Encode only.

T DCS: Encodes a CTCSS tone and Decodes a DCS code.

D TONE: Encodes a DCS code and Decodes a CTCSS tone.

44 SQL TYPE

Function: Selects the Tone Encoder and/or Decoder mode.

Available Values: TONE / TSQL / DCS / RV TONE / PAGER / OFF

Default: OFF

TONE: CTCSS Encoder

TSQL: CTCSS Encoder/Decoder

DCS: Digital Coded Encoder/Decoder

RV TONE: Reverse CTCSS Decoder (Mutes receiver when matching tone is received)

PAGER: Enhanced Paging & Code Squelch

Note: See also Set Mode Item "39 SQL EXP" regarding additional selections available during "Split Tone" operation.

Menu Selection Details

45 STEP

Function: Sets the frequency synthesizer steps.

Available Values: AUTO / 5 / 6.25 / 8.33* / 10 / 12.5 / 15 / 20 / 25 / 50 / 100 (kHz)

Default: AUTO

*: AIR Band

46 TEMP

Function: Indicates the final transistor & heatsink temperature.

47 TONE FRQ

Function: Setting of the CTCSS Tone Frequency.

Available Values: 50 standard CTCSS tones

Default: 100.0 Hz

CTCSS TONE FREQUENCY (Hz)							
67.0	69.3	71.9	74.4	77.0	79.7	82.5	85.4
88.5	91.5	94.8	97.4	100.0	103.5	107.2	110.9
114.8	118.8	123.0	127.3	131.8	136.5	141.3	146.2
151.4	156.7	159.8	162.2	165.5	167.9	171.3	173.8
177.3	179.9	183.5	186.2	189.9	192.8	196.6	199.5
203.5	206.5	210.7	218.1	225.7	229.1	233.6	241.8
250.3	254.1	-	-	-	-	-	-

48 TOT

Function: Sets the Time-Out Timer.

Available Values: 0.5 MIN - 10.0 MIN (0.5 MIN step) / OFF

Default: 3.0 MIN

The time-out timer shuts off the transmitter after continuous transmission of the programmed time.

49 TS MUTE

Function: Enables/Disables the receiver audio output while the Tone Search or DCS Search Scanner is activated.

Available Values: ON / OFF

Default: ON

50 TS SPEED

Function: Selects the Tone Search or DCS Search Scanner speed.

Available Values: FAST / SLOW

Default: FAST

51 VER DISP

Function: Displays the transceiver software version.

Available Values: CPU / DSP

Menu Selection Details

52 VFO MODE

Function: Set the frequency setting range in the VFO mode by DIAL knob.

Available Values: ALL / BAND

Default: BAND

ALL: Tuning continues to the next band when reaching the end of a band.

BAND: Tuning continues to the other end of the current band when reaching the end of the band. When changing the band, press the [**BAND(SQL)**] key.

53* WX ALERT (USA version only)

Function: Set the weather Alert Feature, used for notifying storms and hurricanes, ON or OFF.

Available Values: ON / OFF

Default: OFF

54* WX VOL (USA version only)

Function: Selects the audio output level of the Weather Alert.

Available Values: NOR VOL / MAX VOL

Default: NOR VOL

55* (53) W/N DEV

Function: Reduction of the Microphone Gain/Deviation and receiver bandwidth.

Available Values: WIDE / NARROW

Default: WIDE

56* (54) W-DGID

Function: Sets the WIRES-X DG-ID number.

Available Values: AUTO/DGID01-99

Default: AUTO

AUTO: Only open nodes, set to the DG-ID number "00" may be connected.

DGID01 - 99: Only nodes matching the set DG-ID number may be connected.

57* (55) MY CALL

Function: Sets your station call sign.

Here's how to input the call sign:

1. Press the [**MHz(SETUP)**] key momentarily.
The currently registered call sign ID is shown.
2. Rotate the **DIAL** knob to select the first letter/number of the call sign, then press the [**V/M(MW)**] key momentarily to save the first letter/number and move on to the next character.
3. Repeat the previous step as necessary to complete the call sign (up to 10 characters).
4. To make a correction, press the [**BAND(SQL)**] key to backspace the cursor; now re-enter the correct letter/number.
5. When the desired call sign is entered, press and hold the [**MHz(SETUP)**] key to save the settings and exit to normal operation.



Copyright 2018
YAESU MUSEN CO., LTD.
All rights reserved.

No portion of this manual may be
reproduced without the permission of
YAESU MUSEN CO., LTD.

YAESU MUSEN CO., LTD.

Tennozu Parkside Building
2-5-8 Higashi-Shinagawa, Shinagawa-ku, Tokyo 140-0002 Japan

YAESU USA

6125 Phyllis Drive, Cypress, CA 90630, U.S.A.

YAESU UK

Unit 12, Sun Valley Business Park, Winnall Close
Winchester, Hampshire, SO23 0LB, U.K.