

| CHAPTER 1 | | PAGE |
|-------------------------------|--------------------------------------|------|
| SPECIFICATIONS | | |
| 1.0 | General | 2 |
| 1.1 | Transmitter | 2 |
| 1.2 | Receiver | 2 |
| | | |
| CHAPTER 2 | | |
| INTRODUCTION | | |
| 2.0 | Introduction | 3 |
| 2.1 | Features | 3 |
| | | |
| CHAPTER 3 | | |
| OPERATION | | |
| 3.0 | Introduction | 4 |
| 3.1 | Control & Connections | 4 |
| 3.2 | Microphone | 8 |
| 3.3 | Operation | 8 |
| | | |
| CHAPTER 4 | | |
| PROGRAMMING | | |
| 4.0 | Introduction | 11 |
| 4.1 | Frequency Selection | 11 |
| 4.2 | Frequency Scanning | 11 |
| 4.3 | Offset Frequency Operation | 13 |
| | | |
| CHAPTER 5 | | |
| CIRCUIT DESCRIPTION | | |
| 5.0 | Introduction | 14 |
| 5.1 | PLL Circuit | 14 |
| 5.2 | Receiver Circuit | 14 |
| 5.3 | Transmitter Modulation Circuit | 14 |
| 5.4 | Transmitter Amplifier Circuit | 14 |
| | | |
| CHAPTER 6 | | |
| ALIGNMENT | | |
| 6.0 | Required Test Equipment | 18 |
| 6.1 | Alignment Procedures | 18 |
| | | |
| CHAPTER 7 | | |
| MAINTENANCE | | |
| 7.0 | Precautions | 22 |
| 7.1 | Periodic Inspection | 22 |
| 7.2 | Fuse Replacement | 22 |
| | | |
| CHAPTER 8 | | |
| DIAGRAMS AND PART LIST | | |
| 8.0 | PCB Layout & Part List | 23 |

2.0 INTRODUCTION

The Ranger RCI-2950 DX / RCI-2970 DX is a solid-state, fully synthesized Amateur 10 and 12 meter dual band mobile transceiver with full band coverage from 28.0000 MHz to 29.6999 MHz and 24.8900 MHz to 24.9900 MHz and all mode operation, including: AM, FM, USB, LSB, CW and PA modes. The 10 most commonly used frequencies can be pre-programmed by the user for easy channel access.

2.1 RCI-2950 DX / RCI-2970 DX FEATURES

- 25 Watts PEP of Output Power (RCI-2950 DX)
- 150 Watts PEP of Output Power (RCI-2970 DX)
- Full Band Coverage
- All Mode Operation
- Brightness Control
- CTCSS Encoder/Decoder (Optional)
- Repeater/Offset Switch
- Programmable Frequencies
- Built-in Dual VFO
- RIT (RX Incremental Tuning)
- Squelch
- Noise Blanker
- RF Gain Control
- RF Power Output Selector
- External Speaker Connection
- PA Mode
- LCD Display
- Multi-Function LCD Meter

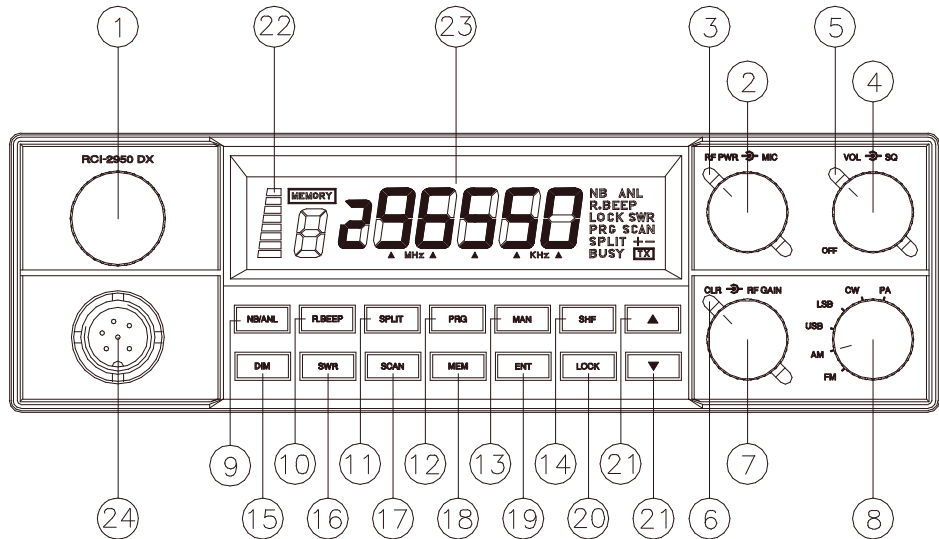

Figure 3-1 Front Panel

3.0 INTRODUCTION

This section explains the basic operating procedures for the RCI-2950 DX / RCI-2970 DX Amateur 10 and 12 meter dual band mobile transceiver.

3.1 CONTROL AND CONNECTIONS

3.1.1 FRONT PANEL

Refer to the above Figure 3-1 for the location of the following controls.

1. FREQUENCY SELECTOR

This control is used to select a desired transmit and receive frequency.

2. RF POWER CONTROL

This control allows the user to adjust RF power output.

3. MIC GAIN CONTROL

Adjusts the microphone gain in the transmit and PA modes. This controls the gain to the extent that full talk power is available several inches away from the microphone. In the Public Address (PA) mode, the control functions as the volume control.

4. ON/OFF VOLUME CONTROL

This knob controls the volume and the power to the radio. To turn the radio on, rotate knob clockwise. Turning the knob further will increase the volume of the receiver.

5. SQUELCH CONTROL

This switch is used to eliminate background noise being heard through the receiver which can be disturbing when no transmissions are being received. To use this feature, turn the switch fully counterclockwise and then turn clockwise slowly until the background noise is just eliminate. Further clockwise rotation will increase the threshold level, which a signal must overcome in order to be heard. Only strong signals will be heard at a maximum clockwise setting.

6. RF GAIN CONTROL

This control is used to reduce the gain of the RF amplifier under strong signal conditions.

7. CLARIFIER CONTROL

Allows tuning of the receive frequency above or below the assigned frequency by up to 500 Hz. Although this control is intended primarily to tune in SSB/CW signals, it may be used to optimize AM/FM signals.

8. MODE (FM/AM/USB/LSB/CW/PA) SWITCH

This switch allows you to select one of the following operating modes: FM/AM/USB/LSB/CW/PA.

9. NB/ANL BUTTON (NB/ANL)

In the NB/ANL position, the RF Noise Blanker and Automatic Noise Limiter in the audio circuits are also activated. The Noise Blanker is very effective in eliminating repetitive impulse noise such as ignition interference.

10. ROGER BEEP BUTTON (R.BEEP)

In the Roger Beep position, the radio transmits an audio tone at the end of your transmission to indicate that transmission has ended. As a courtesy to others, use the Roger Beep only when necessary.

11. SPLIT BUTTON (SPLIT)

This control activates the offset frequency function. It causes the transmit frequency to be offset either above or below the receive frequency by a user programmable amount to allow operation of an FM Repeater.

12. PROGRAM BUTTON (PRG)

This button is used to program operating or scanning frequencies into memory. See the OPERATION section of the manual for further details.

13. MANUAL BUTTON (MAN)

This is used to return the unit to manual mode.

14. SHIFT BUTTON (SHF)

This is used to select 100 Hz, 1 KHz, 10 KHz, 100 KHz or 1 MHz frequency steps.

15. DIM BUTTON (DIM)

This button adjusts the display backlighting in four different steps to best match the ambient light.

16. SWR BUTTON (SWR)

This control is used to check SWR.

17. SCAN BUTTON (SCAN)

This is used to scan frequencies in each band segment. The OPERATION segment of this manual provides detailed information on using the SCAN control.

18. MEMORY BUTTON (MEM)

This button is used to program memory channels. Detailed information on how to use this control is provided in the OPERATION section of this manual.

19. ENTER BUTTON (ENT)

This is used to program frequencies in memory. See the OPERATION section of this manual for more information on using this control.

20. LOCK BUTTON (LOCK)

This button is used to lock a selected frequency. Press it to activate the switch. In this position, it disables the Frequency Selector Control, up/down buttons on the front control panel and remote up/down buttons on the microphone. Reprising the switch will unlock the frequency.

21. UP/DOWN SELECTOR (st)

These buttons are used in conjunction with the shift key to move the frequency upward or downward to select a desired frequency.

22. METER

This meter indicates received signal strength, transmitter RF output power and SWR level.

23. LCD DISPLAY

The LCD displays the frequency selected, functions and memory channel.

24. MIC JACK

Accepts 6 pin female connector with a type Philmore T616C or Calrad 30445 style connector.

3.1.2 REAR PANEL

Figure 3-2 represents the location of the following connections:

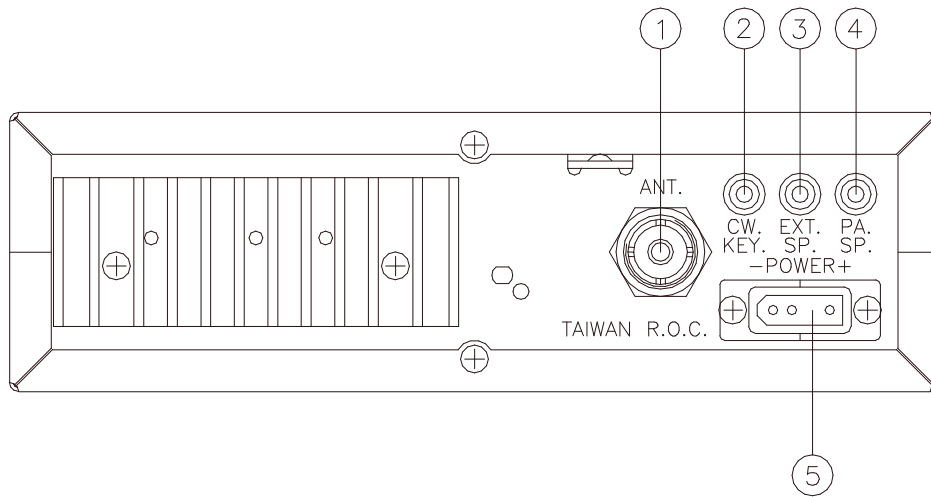

Figure 3-2 Rear Panel

1. ANTENNA

This jack accepts 50 ohms coaxial cable with a PL-259 type plug.

2. CW KEY

This jack is for Morse code operation. To operate, connect a CW key to this jack and place the MODE switch in the CW position.

3. EXT. SP.

This jack accepts 4 to 8 ohms, 5 watts external speaker. When the external speaker is connected to this jack, the built-in speaker will be disabled.

4. PA. SP.

This jack is for PA operation. Before operating, you must first connect a PA speaker (8 ohms, 5 W) to this jack.

5. POWER

This connector accepts 13.8V DC power cable with built-in fuse. The power cord provided with the radio has a black and red wire. The black goes to negative and the red goes to positive.

3.2 MICROPHONE

1. PTT SWITCH

The receiver and transmitter are controlled by the push-to-talk switch on the microphone. Press the switch and the transmitter is activated, release switch to receive. When transmitting, hold the microphone two inches from the mouth and speak clearly in a normal voice.

2. REMOTE UP/DOWN SWITCH

An operating frequency can be incremented or decremented simply by pushing either of these buttons.

3.3 OPERATION

3.3.1 CHANNEL SELECTION

Frequency selection for the RCI-2950 DX / RCI-2970 DX is simple. Select a desired operating frequency by rotating the Frequency Selector, or using the (σ) Up and (τ) Down buttons on the front panel or the microphone. Press the LOCK button to lock into the selected frequency. This will disable the Frequency Selector and the up/down buttons on the front panel and the microphone. Repeating the LOCK button unlocks the frequency. Use the SHF button to step frequency in either 100 Hz, 1 KHz, 10 KHz, 100 KHz or 1 MHz increment when you select a band segment. The frequency step is indicated by a small triangle directly under the corresponding digit on the frequency display.

3.3.2 MODE SELECTION

To select an operating mode on your RCI-2950 DX / RCI-2970 DX, simply rotate the MODE selector and place it in the desired operating mode position.

FM/AM/USB or LSB modes are for your voice communications. In the CW position, you can transmit CW if you have connected an external key to the accessory jack provided on the back of the radio. In the PA position, the transceiver can be used as a Public Address system. Before operating in PA mode, you must first connect a PA speaker (8 ohms, 5 Watts) to the jack located on the rear panel.

3.3.3 RF POWER CONTROL

This feature allows the adjustment of the RF output power continuously for the RCI-2950 DX (AM 1W to 10W; SSB: 10W to 25W), and (AM: 8W to 50W; SSB: 18W to 100W) for the RCI-2970 DX.

3.3.4 RECEIVE SCANNING

Receive scanning allows you to find active frequencies in the entire band segment. To begin scanning, slowly turn the Squelch control clockwise until the receiver noise disappears. Press the Scan button. The unit should start scanning from the lower to the higher frequencies. Pressing the Scan button again will change the direction of scanning. Each time you press the Scan button, "SCAN+" or "SCAN-" will be displayed on the LCD display. The radio will stop on any active frequency for the entire duration of the transmission. When the transmission stops, the RCI-2950 DX / RCI-2970 DX will wait approximately 2 seconds before it resumes scanning. If you want to deactivate Scan mode while it is scanning, press the MAN (manual) button or turn the Squelch control counterclockwise until you hear the receiver noise. The Manual button will disable Scan function.

3.3.5 SPLIT FUNCTION

This function enables you to offset the transmit and receive frequencies for FM repeater operation. The transmitter frequency can offset either higher or lower than the receive frequency. To split frequencies, press the **MAN** button and the Split button to select either +/- split frequency. If the + split is selected, the transmit frequency will be higher than the receive frequency. If - split is selected, the transmit frequency will be lower than the receive frequency.

3.3.6 MEMORY FUNCTION

The RCI-2950 DX / RCI-2970 DX can store up to 10 most frequently used frequencies (from 0 to 9). To program a frequency into memory, follow the procedure described below:

- (1) Press the **MAN** button.
- (2) Press the **PRG** button.
- (3) Press the **MEM** button (“MEMORY” and “0” should appear on the left-hand side of the **LCD** display). Pressing the **MEM** button will advance the channel number from “0” to “9”.
- (4) Select the desired frequency you wish to store in memory.
- (5) Press the **ENT** button.
- (6) Repeat the same procedure to program other memory channels.

3.3.7 MEMORY CHANNEL SCANNING

You can scan and select any of these 10 preset frequencies by following the procedure described below:

- (1) Press the **MAN** button.
- (2) Press the **MEM** button.
- (3) Slowly turn the Squelch knob clockwise until the receiver noise disappears.
- (4) Press the Scan button. The unit will scan from lower to higher frequencies. When you press the button again, it will scan from higher to lower frequencies.
- (5) To stop scanning a certain channel, press the **MAN** button, or turn the Squelch knob counterclockwise until you hear the receiver noise.

3.3.8 METER

The meter built into your RCI-2950 DX / RCI-2970 DX on the left hand side of the **LCD** display provides the following information:

1. S/RF METER

In transmit mode, it provides a visual indication of transmit output power and received signal strength on the receive mode.

2. SWR METER

In order to achieve maximum radiated power, it is important that your antenna be in good condition, properly adjusted and matched to your transceiver. The built-in SWR (Standing Wave Ratio) meter allows you to measure your antenna condition. To operate this function, connect your antenna to the transceiver antenna connector, set the mode switch to AM and adjust the MIC GAIN to minimum. Select a frequency near the middle of the band you plan to use most. Activate the SWR function and press the PTT button on the microphone. A bar on the meter is an indication of the antenna matching. If there is no bar, it indicates that your antenna system is perfectly matched. The fewer bars, the better matched. If several bars appear, your antenna needs adjusting.

3.3.9 CTCSS - OPTIONAL

The RCI-2950 DX / RCI-2970 DX can operate with CTCSS frequencies for accessing repeaters, with an optional CTCSS (Continuous Tone Coded Squelch System) encoding device installed.

3.3.10 PROCEDURE TO RECEIVE

- (1) Be sure that power source, microphone and antenna are connected to the proper connectors before going to the next step.
- (2) Turn unit on by running **VOL** knob clockwise on transceiver.
- (3) Set the **VOL** to a comfortable listening level.
- (4) Set the **MODE** switch to the desired mode.
- (5) Listen to the background noise from the speaker. Turn the **SQ** knob slowly clockwise until the noise just disappears. The **SQ** is now properly adjusted. The receiver will remain quiet until a signal is actually received. Do not advance the control too far or some of weaker signals will not be heard.
- (6) Set the **CHANNEL** selector switch to the desired channel.
- (7) Set the **RF GAIN** control fully clockwise for maximum receive gain.
- (8) Adjust the **CLARIFIER** control to clarify the SSB signals or to optimize AM/FM signals.

3.3.11 PROCEDURE TO TRANSMIT

- (1) Select the desired channel of transmission
- (2) Set the **MIC GAIN** control fully clockwise.
- (3) If the channel is clear, depress the push-to-talk switch on the microphone and speak in a normal voice.

4.0 INTRODUCTION

This section explains the basic programming procedures for the RCI-2950 DX / RCI-2970 DX Amateur 10 and 12 meter dual band mobile transceiver.

4.1 FREQUENCY SELECTION

Frequency selection in the RCI-2950 DX / RCI-2970 DX can be accomplished using anyone of the three following methods:

- (1) The first method of frequency selection is through the use of the **SHF** (Shift) key and the (σ) Up and (τ) Down arrows. To accomplish this, press the **SHF** button until the cursor arrow is positioned under the digit of the frequency that is to be changed, then use the (σ) Up arrow to increase the number. If a decrease in frequency is desired, press the (τ) Down arrow. Perform the steps described above for each digit of the frequency until the desired frequency is displayed in the LCD display window.
- (2) The second method of frequency selection is accomplished using the **SHF** button and the frequency select knob located above the microphone jack. Use the **SHF** button in the manner described above to select the digit to be changed. Proceed to rotate the frequency select knob clockwise to increase the frequency. Rotate the frequency select knob counterclockwise to decrease the frequency.
- (3) The third method of selecting the operating frequency of the radio is through the use of the **SHF** button and the Channel (σ) Up and (τ) Down buttons located on the microphone. Frequency selection by this method is accomplished in the same manner as with the (σ) Up and (τ) Down arrows on the keypad. The only difference is that the Channel Up and Down buttons on the microphone are used.

4.2 FREQUENCY SCANNING

Frequency scanning can be achieved using one of two methods: the first method involves the scanning of pre-programmed memory channels. The second method permits the user to scan all frequencies between a pre-set upper and lower scan limit.

4.2.1 ALL FREQUENCY SCANNING

To allow all Frequency Scanning, one must first program the upper and lower scanning limits. The scan limits are simply the highest and lowest frequencies that will be scanned. To program these limits, perform the following steps:

- (1) Press the **PRG** (Program) key.
- (2) Press the **SCAN** key (“**PRG SCAN+**” should appear in the lower right corner of the display window).
- (3) Using the **SHF** key and the (σ) Up and (τ) Down arrows, select the upper scan limit, then press **ENT**.

(4) Press the **SCAN** key again (“**SCAN-**” should appear in the display window).

(5) Using the **SHF** key and (σ) Up and (τ) Down arrows, select the lower scan limit, then press **ENT**.

The upper and lower scan limits have now been programmed. To activate the scan feature, return the radio to manual operation and press the **SCAN** button. If the display shows “**SCAN+**”, the radio will scan from the lower limit to the upper limit. If “**SCAN-**” is displayed, the unit will scan from the upper limit to the lower limit. To change from **SCAN+** to **SCAN-** or vice versa, press **SCAN**.

NOTE

When programmed, the upper and lower scan limits will also act as the upper and lower operating limits of the radio. The radio now cannot be programmed to operate above or below the scan limits.

4.2.2 MEMORY SCANNING

The RCI-2950 DX / RCI-2970 DX has 10 non-volatile (i.e. memory resident) memory locations which can be programmed with any available frequency within the operating band of the radio. The scan function of the unit can be programmed to scan these memory channels. The radio will then scan only those memory channels which have been programmed. The first step in utilizing the memory scan function is to program the desired frequencies into the radio memory. This can be accomplished by performing the following steps:

(1) With the radio operating in the manual mode, press the **PRG** (Program) key.

(2) Press the **MEM** (Memory) key. “**PRG**” should be displayed in the lower right-hand corner of the LCD display window. In the upper left portion of the display, “**MEMORY**” should be displayed. Directly below **MEMORY**, a number between 0 and 9 will be displayed. This number represents the memory location currently being displayed. Pressing the **MEM** key will increase the memory counter to the next memory location and the contents of that memory location will be displayed.

(3) Using the **SHF** key and the (σ) Up and (τ) Down arrows, enter the frequency to be stored in the memory location displayed. After the desired frequency has been entered, press **ENT**.

(4) Repeat steps (2) and (3) for all the memory locations to be programmed.

(5) After all desired memory locations have been programmed with frequencies, return the unit to the manual mode of operation by pressing the **MAN** key.

(6) To initiate memory scanning, press **MEM** and then press **SCAN**. As previously discussed, the display will show “**SCAN+**” or “**SCAN-**” to indicate whether the radio is scanning from the lowest or the highest memory location or vice versa.

(7) To return the radio to normal (non-scanning) operation, press the **MAN** key.

4.3 OFFSET FREQUENCY OPERATION

The RCI-2950 DX / RCI-2970 DX has an offset or split frequency feature that will permit the radio to be operated in a half-duplex mode. This will allow the user to talk on FM repeaters operating in the 10 and 12 Meter bands.

NOTE

The FM repeaters may require a subaudible (CTCSS) tone be transmitted to gain access to the repeater. The RCI-2950/2970 DX is not factory equipped with a CTCSS encoder/decoder.

The split frequency function offsets the transmitter frequency either above or below the receive frequency by a user programmable amount. In the following example, programming of a 100 KHz offset will be described. Before attempting to program the offset frequency, ensure that the radio is operating in the manual mode by pressing the **MAN** key.

- (1) Press the **PRG** (Program) key.
- (2) Press the **SPLIT** key. The LCD display window will display “00000” with “PRG” and “SPLIT” being displayed in the lower left-hand corner.
- (3) Using the **SHF** key and the (σ) Up and (τ) Down arrows as described earlier, program the display to read “010000”.
- (4) Press **ENT**. A 100 KHz offset has now been programmed into the radio.
- (5) Return the radio to manual operation by pressing the **MAN** key.
- (6) Using the **SHF** key and the (σ) Up and (τ) Down arrows as described previously, set the radio for the desired receive frequency.
- (7) Press **SPLIT**. In the lower right corner of the display, either “SPLIT+” or “SPLIT-” will be displayed. If **SPLIT+** is displayed, the transmitter will be offset 100 KHz above the receive frequency when keyed. If **SPLIT-** is displayed, the transmitter will be offset 100 KHz below the receive frequency.

NOTE

When the transmitter is keyed, the frequency display will change to show the frequency being transmitted.

- (8) To return the radio to simplex operation (i.e., same transmit and receive frequency), press the **MAN** key.

5.0 INTRODUCTION

This section explains the technical theory of operation for the RCI-2950 DX / RCI-2970 DX mobile transceiver.

5.1 PLL CIRCUIT

The Phase Lock Loop (PLL) circuit is responsible for developing the receiver's first local oscillator signal and the transmitter's exciter signal. The PLL circuit consists primarily of IC2, IC3, Q29, Q32, Q33, Q34, Q36, Q37, Q38 and L16. The PLL circuit is programmed by the rotary channel switch GPS-0688. The switch allows IC (U601) on CPU P.C.B to communicate the correct binary data information to the programmable divider inside of IC2. IC2 then controls the VCO (Voltage Controlled Oscillator) to oscillate on the correct frequency. This signal is fed either into the receiver's first mixer (for receive operation) or the transmitter's mixer (for transmit operation).

5.2 RECEIVER CIRCUIT

The incoming receives signal come into the radio via the antenna and into the front-end pre-amp consisting of Q19. The RF signal is fed into the mixer circuit of the Q20 and Q21. The signal is then filtered by L8, L9 and L10 then into the AM/FM IF section of the receiver (depending on the mode of operation). The signal is then detected by either the AM detector FM detector and then fed to the audio amplifier section of the receiver and finally out to the speaker.

5.3 TRANSMITTER MODULATION CIRCUIT

- (1) The transmitter modulation circuit modulates the low-level RF signal from the PLL exciter circuit with the user's audio voice signal from the microphone. The audio from the microphone is then amplified and fed into the balanced modulator circuit.
- (2) If the transceiver is in the AM mode, the AF power amplifier modulates the last RF amplifier which produces a true amplitude modulated RF signal.
- (3) If the transceiver is in the FM mode, the audio signal is not mixed with 10.6975MHz oscillator but instead phase modulates the basic exciter signal from the PLL circuit in the TX mixer.
- (4) If the transceiver is in the SSB mode, the audio signal is mixed with 10.6975MHz oscillator in IC5.

5.4 TRANSMITTER AMPLIFIER CIRCUIT

The transmitter takes the basic exciter signal from the TX mixer and amplifies it through a series of amplifiers consisting of Q64, Q63, Q62, Q61, Q60 and the EPA010010A amplifier (only for RCI-2970 DX) where it is sent out to the antenna connector.

RCI-2970DX BLOCK DIAGRAM

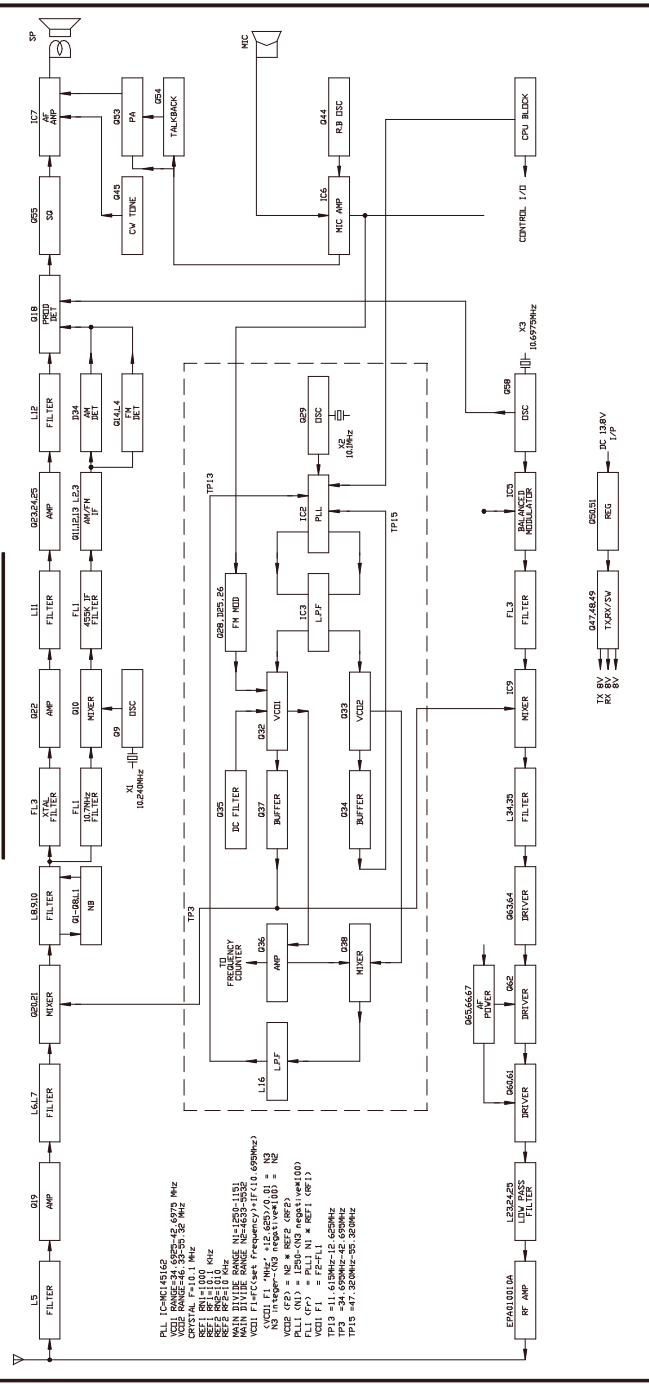

RCI-2950 DX / RCI-2970 DX CPU CIRCUIT DIAGRAM

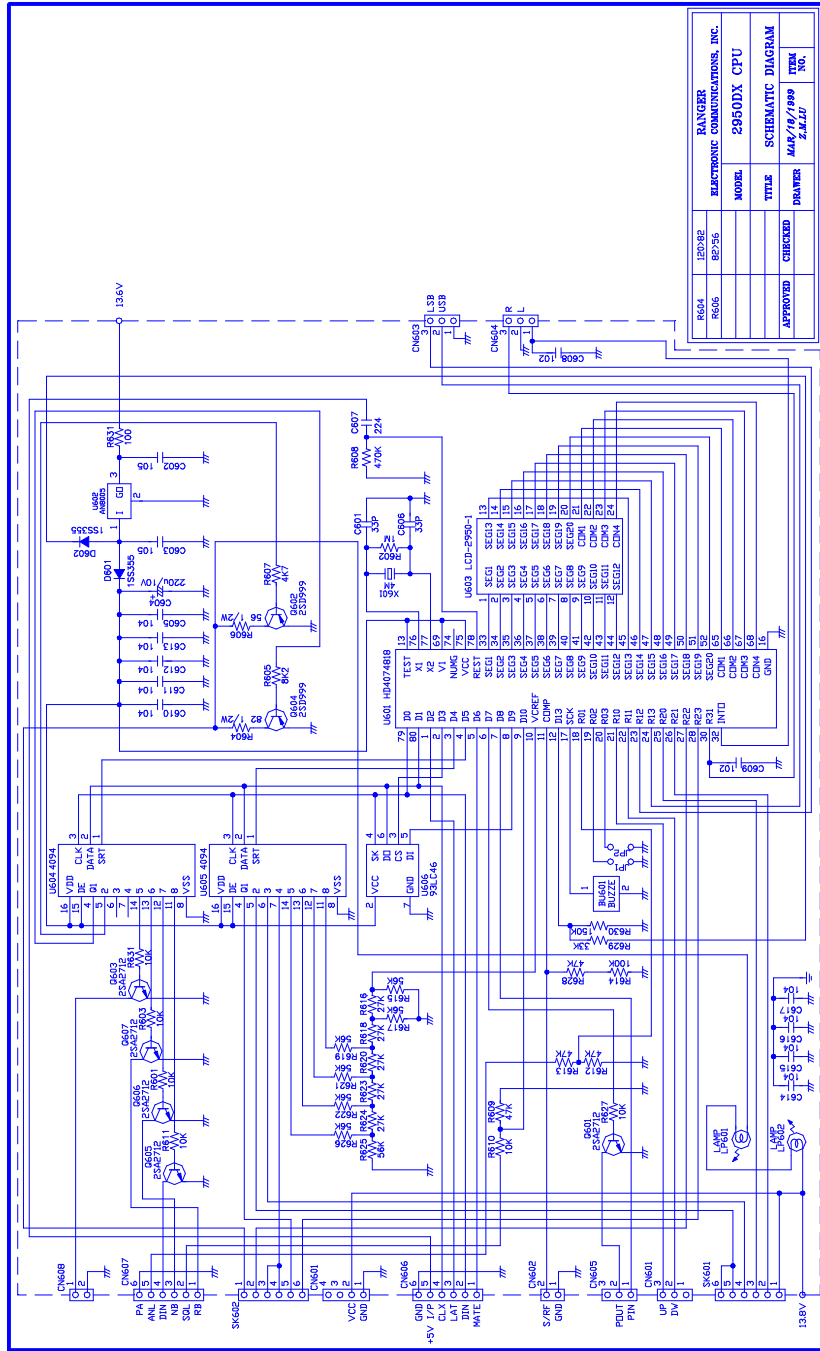

| | | | |
|-------------|--|------|-------|
| DESIGNED BY | RD/82 | DATE | 12/82 |
| CHECKED BY | BP/36 | DATE | 1/83 |
| APPROVED BY | | DATE | |
| COMPANY | RANGER ELECTRONIC COMMUNICATIONS, INC. | | |
| MODEL | 2950DX CPU | | |
| TITLE | SCHEMATIC DIAGRAM | | |
| DRAWN | MAK/70/7899 | TRN | |
| | 24240 | | |

6.0 REQUIRED TEST EQUIPMENT

- | | |
|----------------------------------|---------------------------------|
| ① DC Power Supply (13.8VDC, 20A) | ⑥ Frequency Counter (100 MHz) |
| ② RF Wattmeter (100W) | ⑦ RF Signal Generator (100 MHz) |
| ③ Multimeter | ⑧ Automatic Distortion Meter |
| ④ Automatic Modulation Meter | ⑨ Oscilloscope (50 MHz) |
| ⑤ Audio Signal Generator | ⑩ Sinad Meter |

6.1 ALIGNMENT PROCEDURES

This transceiver has been aligned at the factory and does not require any adjustments at installation. The required test equipment listed are used for the test setup or alignment shown in Figure 6-1 Transmitter Test Setup and Figure 6-2 Receiver Test Setup. These test setups are used in part or total during the following adjustments and refer to Page 44 for adjustment location.

6.1.1 PLL ALIGNMENT

| ITEM | U.U.T. SETTING | ADJUST POINT | MEASUREMENT |
|----------------------|---|--------------|-------------------------------------|
| PLL 2 VCO Voltage | Set radio to 24.890 MHz, AM RX mode. Frequency setting at 29.699 MHz. Connect Multimeter to TP10. | L14 | 1.0 VDC ± 0.1 ≤ 4.5 VDC |
| PLL 1 VCO Voltage | Set radio to 24.890 MHz, AM RX mode. Frequency setting at 32.000 MHz. Connect Multimeter to TP11. | L13 | 1.0 VDC ± 0.1 ≤ 6.5 VDC |
| AM Frequency | Set radio to AM RX mode. Set Clarifier Control to 12 o'clock. Connect Frequency Counter to TP16. | VC2 | 10.1000 MHz ± 10 Hz |
| TX Frequency | Set radio to AM TX mode. Connect Frequency Counter to TP16. | VR8 | 10.1000 MHz ± 10 Hz |
| VCO Output | Set radio to 28.000 MHz, AM RX mode. Connect Oscilloscope to TP3. | L17 | Maximum Output 38.6950 MHz @ TP3 |
| AM OSC | Set radio to AM TX mode. Mod off. Connect Frequency Counter to TP5. | L18 | 10.6950 MHz ± 10 Hz |
| USB OSC | Set radio to USB TX mode. Mod off. Short TP6 to ground. Connect Frequency Counter to TP5. | L20 | 10.6975 MHz ± 10 Hz |
| LSB OSC | Set radio to LSB TX mode. Mod off. Connect Frequency Counter to TP5. | L19 | 10.6925 MHz ± 10 Hz |

6.1.2 TRANSMITTER ALIGNMENT

RCI-2970DX LEVELS ARE SHOWN IN [].

| ITEM | U.U.T. SETTING | ADJUST POINT | MEASUREMENT |
|--------------------------------|---|--|--|
| TX Power | Set radio to 28.000 MHz, AM TX mode. Modulation off. Set radio to 28.000 MHz, USB TX mode. AF signal 30mV, 1 KHz to microphone. Connect Oscilloscope to TP17. Set RF PWR Fully Clockwise. Set Clarifier Control to 12 o'clock. Set radio to 24.890 MHz & 29.699 MHz. | L18,L37,L35, L34 L35,L34 | Maximum Output. Maximum Output and Balance. |
| AM APC | Set radio to AM TX mode. Connect Multimeter to TP8 | VR15 | 6 VDC |
| SSB APC | Set radio to USB TX mode. Connect Multimeter to TP8 | VR18 | 12.5 VDC |
| BIAS Current | Set radio to USB TX mode. Modulation off. Connect current meter to TP7(+) and TP9(-) Connect current meter to TP7(+) and TP8(-) | VR13 VR12 + VR11 | 10 mA (50 mA + 50 mA) = 100 mA |
| AM TX Power | Set radio to 28.000 MHz, AM TX mode. Modulation off. Connect "short PCB" to TP7 and TP9. Set RF PWR Fully Counter Clockwise. Connect RF Power Meter to antenna jack. | VR15 VR19 | 10W [50W] 1W [8W] |
| RF Power Meter | Set radio to 28.000 MHz, AM TX mode. Set RF Power Fully Clockwise. | VR10 | Level Meter Indicator |
| SSB ALC | Set radio to USB TX mode. AF signal 30 mV, 1 KHz to microphone. | VR14 | 25W [150W, PEP] |
| SSB Carrier Balance | Set radio to USB TX mode. AF signal 30 mV, 1 KHz to microphone. Connect Oscilloscope to antenna jack. | VR7 | Spurious Emission to minimum. |
| CW TX | Set radio to 28.000 MHz, CW TX mode. Plug in CW Key. Disconnect the Mic Jack. Connect AC Voltmeter to EXT SP. | VR9 | 200mV (Sine Wave) |
| AM Modulation FM Modulation | Set radio to 28.000 MHz, AM TX mode. Set radio to 28.000 MHz, FM TX mode. AF signal 30 mV, 1 KHz to microphone. Set Mic Gain Fully Clockwise. | VR17 | 90% 4 KHz |

6.1.3 RECEIVER ALIGNMENT

| ITEM | SETTINGS | ADJUST POINT | MEASUREMENT |
|-----------------------------|--|--|---|
| AM Sensitivity | Set radio to 28.000 MHz, AM RX mode. Set Clarifier Control to 12 o'clock. Set RF Gain Fully Clockwise. Set SQ Fully Counter Clockwise. Set NB/ANL/OFF switch to OFF position. Set VOL Control at 2 o'clock. Connect RF SG to antenna jack Frequency 28.000 MHz, 1uV. Mod 30%. Set radio to 24.890 MHz, AM RX mode. RF SG setting 24.890 MHz. Set radio to 29.699 MHz, AM RX mode. RF SG setting 29.699 MHz. | L5,6,7,8,9,10 ,2,3 L5,L6, L7 | Audio Output > 2V S/N > 10 dB Balance between 24.890 and 29.699 MHz |
| USB Sensitivity | Set radio to USB RX mode. Set VOL Control Fully Clockwise. RF SG setting 28.001 MHz, 0.5uV. Mod off. | L11, L12 | Audio Output > 2V S/N > 10 dB |
| LSB Sensitivity | Set radio to LSB RX mode. Set VOL Control Fully Clockwise. RF SG setting 27.999 MHz, 0.5uV. Mod off. | L11, L12 | Audio Output > 2V S/N > 10 dB |
| FM Distortion | Set radio to 28.000 MHz, FM RX mode. Set MODE switch to FM mode. RF SG setting 28.000 MHz, 1mV. Mod 3KHz. | L4 | Audio Output > 3V Distortion < 10% |
| NB Adjust | Set radio to 28.000 MHz, AM RX mode. RF SG setting 28.000 MHz, 100uV. Mod off. Set NB/ANL/OFF switch to NB/ANL position. Connect Voltmeter to TP1. | L1 | DC Voltage to max. > 2V |
| AM Squelch | Set radio to 28.000 MHz, AM RX mode. Set SQ Control Fully Clockwise. RF SG setting 28.000 MHz, 1mV. Mod 30%. | VR4 Slowly | Adjust very slowly until squelch just open. |
| SSB Squelch | Set radio to USB RX mode. Set SQ Control Fully Clockwise. RF SG setting 28.001 MHz, 1mV. Mod off. | VR3 Slowly | Adjust very slowly until squelch just open. |
| AM S/Rf Meter AM S-Meter | Set radio to 28.000 MHz, AM RX mode. RF SG setting 28.000 MHz, 100uV. Mod 30%. | VR1 | "6 bar" on the Level Meter Indicator. |
| SSB S-Meter | Set radio to USB RX mode. RF SG setting 28.001 MHz, 100uV. Mod off. | VR2 | "6 bar" on the Level Meter Indicator. |

Figure 6-1 Transmitter test setup

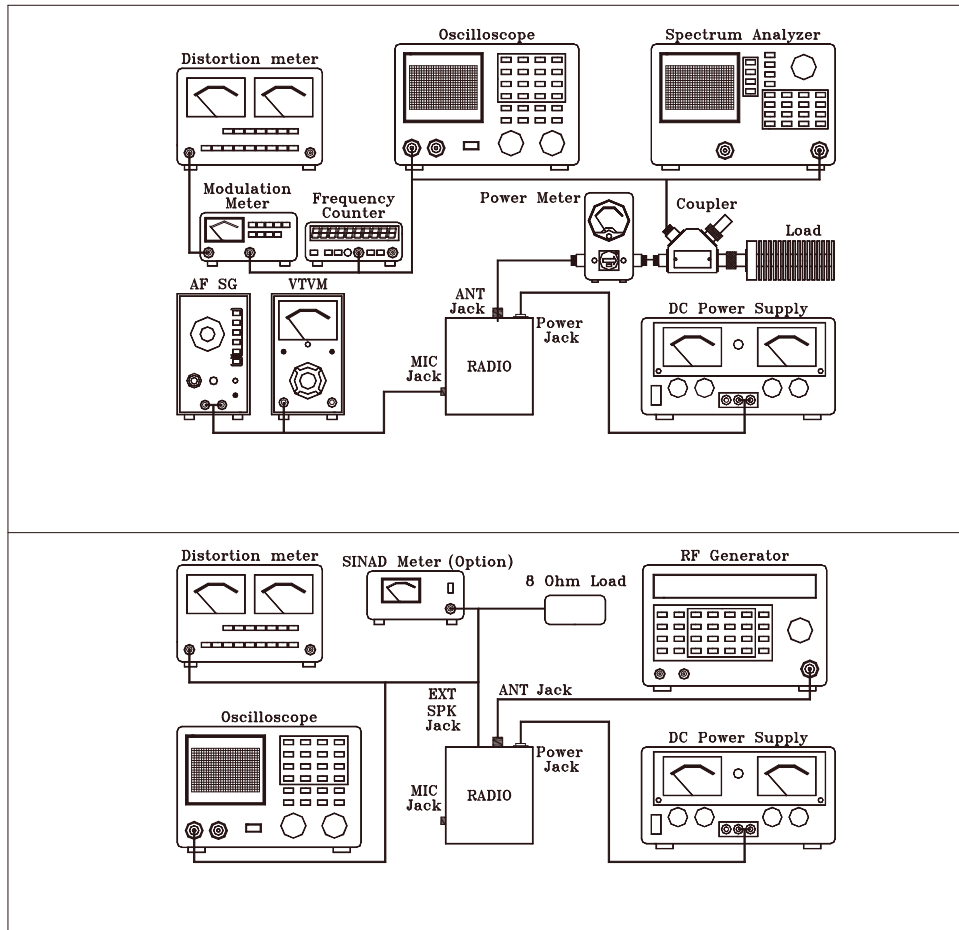

Figure 6-2 Receiver test setup

7.0 PRECAUTIONS

The inherent quality of the solid-state components used in this transceiver will provide many years of continuous use. Taking the following precautions will prevent damage to the transceiver.

- (1) Never key the transmitter unless an antenna or suitable dummy load is connected to the antenna receptacle.
- (2) Ensure that the input voltage does not exceed 16 VDC or fall below 11 VDC.
- (3) During alignment, do not transmit for more than 10 seconds at a time. Transmitting over long periods can cause heat built-up and cause transmitter damage.

7.1 PERIODIC INSPECTION

This unit is aligned at the factory to deliver maximum performance. However, continued performance cannot be expected without periodic inspection and maintenance. Important points to be checked regularly are as follows;

| Check Item | Action |
|----------------------------------|--|
| Whip antenna (option) | If cracked or broken, replace it. |
| Coaxial cable | If sheath is cracked, seal with vinyl tape. If immersed with water, install new coaxial cable. |
| Coaxial & power plug connections | If loosened, reconnect. If corroded, clean contacts. |
| Battery connection | If corroded, clean power terminals. |
| Ground terminal | If corroded, clean terminal. |

7.2 FUSE REPLACEMENT

To protect the equipment from serious damage, a fuse is provided on the power supply lines. The fuse protect against overvoltage / reverse polarity or internal fault of the equipment. If the fuse has blown, first find out the cause of the trouble before replacing it. A fuse rated for more than 7A for RCI-2950 DX and 20A for RCI-2970 DX should not be used, since it may permanently damage the equipment. Damage due to overfusing is not covered by the warranty.

8.0 GENERAL

Information on most electrical and mechanical parts is included in the parts list. The reference designators are in alphanumeric order.

8.1 ORDERING REPLACEMENT PARTS

Parts orders should be referred to the parts department at:

- Ranger Communications, Inc.
401 W. 35TH ST.
NATIONAL CITY, CA 91950-7909

Tel: (619) 426-6440

Fax: (619) 426-3788

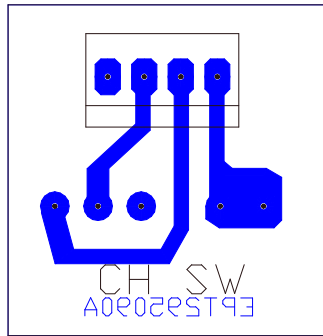

PART LIST:

RCI-2950 DX / RCI-2970 DX CH SW P.C.B

| ITEM | REFERENCE NUMBER | RANGER PART NUMBER | DESCRIPTION |
|------|----------------------------------|--------------------|-----------------|
| 1 | | EPT295090A | CH SW P.C.B |
| 2 | PCB CONN/S 3PIN (COPPER SIDE) | CC0501037L | 0.01μF 50WV |
| 3 | CH SW P.C.B | EWRT32051S | ROTARY SW |
| 4 | CH SW P.C.B | EX07N41216 | PCB CONN/S 3PIN |

REMARK:

COPPER SIDE (BLUE)

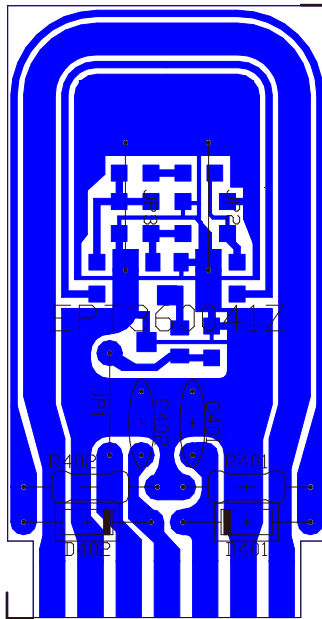

PART LIST:

RCI-2950 DX SWR P.C.B

| ITEM | REFERENCE NUMBER | RANGER PART NUMBER | DESCRIPTION |
|------|------------------|--------------------|-------------------|
| 1 | | EPT360041Z | SWR P.C.B |
| 2 | R402 | RCP141014Z | 100 OHM 1/4W |
| 3 | R401 | RCP141214Z | 120 OHM 1/4W |
| 4 | C401,C402 | CC0501037L | 0.01 μ F 50WV |
| 5 | D401,D402 | ED1N00060P | DIODE 1N60P |
| 6 | JP2,JP3 | WX01070710 | JUMPER WIRE |

REMARK:

COPPER SIDE (BLUE)

| ITEM | REFERENCE NUMBER | RANGER PART NUMBER | DESCRIPTION |
|------|--|--------------------|------------------|
| 12 | C902,C903 | CC0503915L | 390PF 50WV |
| 13 | C906,C926,C932,C934, C937 | CC0501037L | 0.01μF 50WV |
| 14 | C905,C920,C921,C923x2 C924x2,C925,C935,C939 ,C941,T901-T902x2, C927,C928,C930,C931, C933,C940,C929 | CC0501047L | 0.1μF 50WV |
| 15 | C901 | CC0508204A | 82PF 50WV |
| 16 | C918 | CD3006804Z | 68PF 300WV |
| 17 | C916 | CD3001514Z | 150PF 300WV |
| 18 | C917 | CD5001018Z | 100PF 500WV |
| 19 | C908,C910,C936 | CD3001814Z | 180PF 300WV |
| 20 | C945 | CD5005614Z | 560PF 500WV |
| 21 | C909 | CD5008214Z | 820PF 500WV |
| 22 | C919 | CX0071037Z | HV DISC/C 0.01Uf |
| 23 | C922 | CE0162277Z | 220μF 16WV |
| 24 | C938 | CE0352277Z | 220μF 16WV |
| 25 | TR903 | T2SD02531Z | TR 2SD2531 |
| 26 | TR901,TR902 | T2SC02290Z | TR 2SC2290 |
| 27 | D903,D904 | ED1N04148Z | DIODE 1N4148 |
| 28 | D901,D902 | ED1N04001Z | DIODE 1N4001 |
| 29 | L903,L904 | ECSPG18069 | SPRING COIL |
| 30 | L901 | ECBAD18553 | BEAD COIL |
| 31 | T901 | ECRFZ10096 | RF COIL |
| 32 | T902 | ECRFZ10097 | RF COIL |
| 33 | R901 | RE10200046 | S/F/R IK OHM |
| 34 | J901,J902 | EX07N41226 | PCB CONN/S 2PIN |
| 35 | RL901 | EX05N40825 | RELAY |
| 36 | J903,J904 | GZZZ50062Z | V TYPE JACK |
| 37 | J905,J906 | GZZZ50011Z | C PIN |

REMARK:

TOP: COMPONENT SIDE (WHITE)

BOTTOM: COPPER SIDE (WHITE)

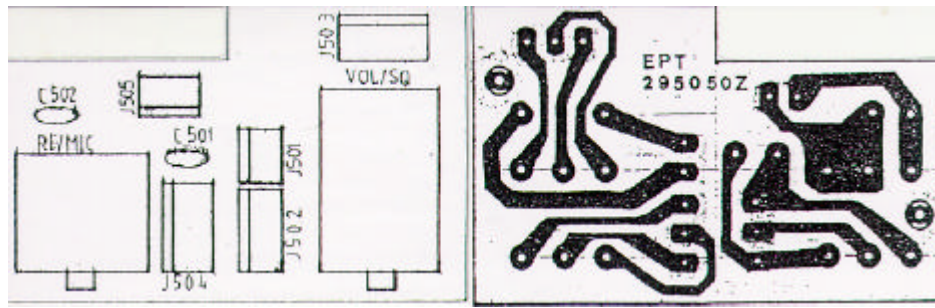

PART LIST:

RCI-2950 DX / RCI-2970 DX VR P.C.B (A)

| ITEM | REFERENCE NUMBER | RANGER PART NUMBER | DESCRIPTION |
|------|------------------|--------------------|--------------------|
| 1 | | EPT295050Z | VR P.C.B (A) |
| 2 | C501,C505 | CC0501027L | 0.001 μ F 50WV |
| 3 | RF/MIC | RV10203451 | VR 1KA-5KB |
| 4 | VOL/SQ | RV50303453 | VR 50KB-50KA |
| 5 | J501,J505 | EX07N41226 | PCB CONN/S 2PIN |
| 6 | J502-J504 | EX07N41216 | PCB CONN/S 3PIN |

REMARK:

LEFT: COMPONENT SIDE

RIGHT: COPPER SIDE (BLUE)

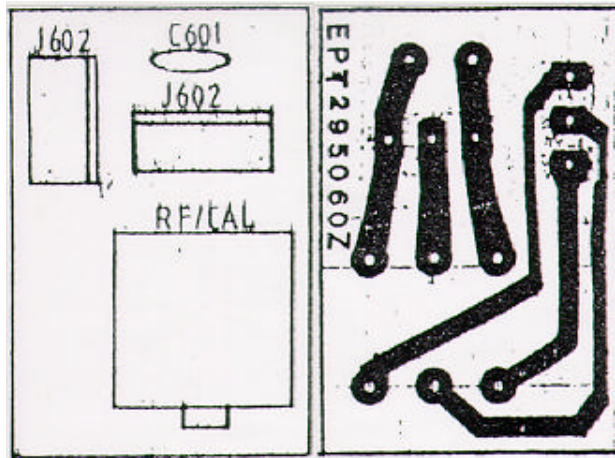

PART LIST:

RCI-2950 DX / RCI-2970 DX VR P.C.B (B)

| ITEM | REFERENCE NUMBER | RANGER PART NUMBER | DESCRIPTION |
|------|------------------|--------------------|--------------------|
| 1 | | EPT295060Z | VR P.C.B (B) |
| 2 | C601 | CC0501027L | 0.001 μ F 50WV |
| 3 | RF/CAL | RV10203456 | VR 1KB-20KB |
| 4 | J601,J602 | EX07N41216 | PCB CONN/S 3PIN |

REMARK:

LEFT: COMPONENT SIDE

RIGHT: COPPER SIDE (BLUE)

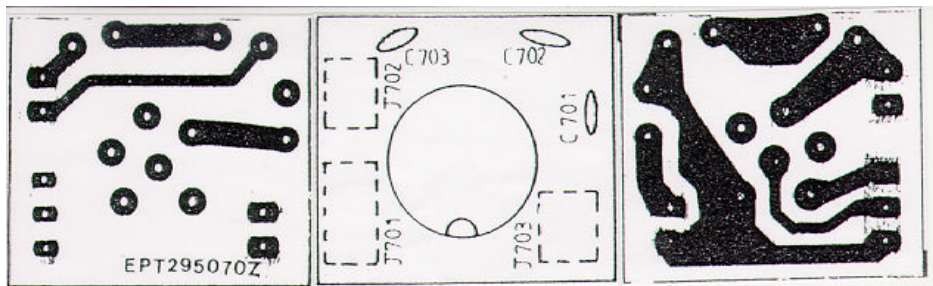

PART LIST:

RCI-2950 DX / RCI-2970 DX MIC P.C.B

| ITEM | REFERENCE NUMBER | RANGER PART NUMBER | DESCRIPTION |
|------|------------------|--------------------|--------------------|
| 1 | | EPT295070Z | MIC P.C.B |
| 2 | C701-C703 | CCM501025T | 0.001 μ F 50WV |
| 3 | J702,J703 | EX07N48152 | PCB CONN/S 2PIN |
| 4 | J701 | EX07N48244 | PCB CONN/S 3PIN |
| 5 | MIC P.C.B | EX06N41111 | MIC JACK |

REMARK:

LEFT: COMPONENT SIDE (BLUE)

MIDDLE: COMPONENT SIDE

RIGHT: COPPER SIDE (BLUE)

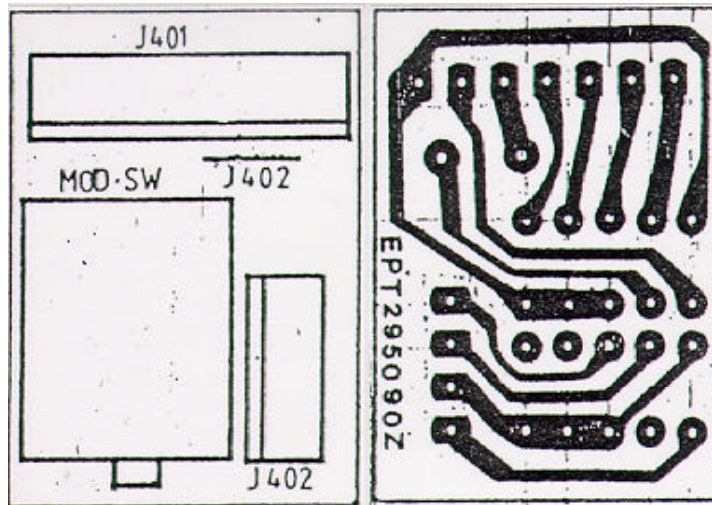

PART LIST:

RCI-2950 DX / RCI-2970 DX BAND P.C.B

| ITEM | REFERENCE NUMBER | RANGER PART NUMBER | DESCRIPTION |
|------|------------------|--------------------|-----------------|
| 1 | | EPT295090Z | BAND P.C.B |
| 2 | BAND P.C.B | EWRT32053S | ROTARY SW |
| 3 | J402 | EX07N41216 | PCB CONN/S 3PIN |
| 4 | J401 | EX07N41261 | PCB CONN/S 7PIN |
| 5 | J403 | WX01070706 | JUMPER WIRE |

REMARK:

LEFT: COMPONENT SIDE

RIGHT: COPPER SIDE (BLUE)

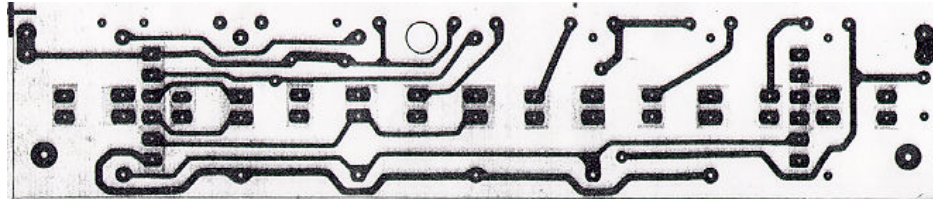
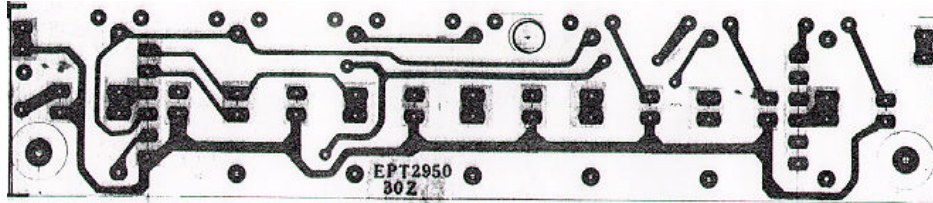
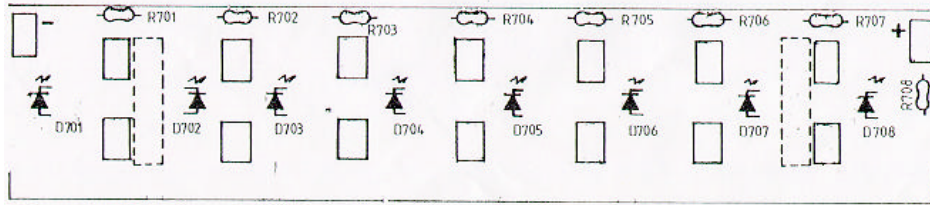

PART LIST:

RCI-2950 DX / RCI-2970 DX KEY SW P.C.B

| ITEM | REFERENCE NUMBER | RANGER PART NUMBER | DESCRIPTION |
|------|---------------------|--------------------|-----------------|
| 1 | | EPT295031Z | KEY SW P.C.B |
| 2 | R701-R708 | RCP161524Z | 1.5K OHM 1/16W |
| 3 | KEY SW P.C.B x 14pc | EWPS33042X | TACT SW |
| 4 | D701-D708 | EX01N40064 | LED (WHITE) |
| 5 | KEY SW P.C.B x 2pc | EX07N48441 | PCB CONN/S 6PIN |

REMARK:

TOP: COMPONENT SIDE

MIDDLE: COPPER SIDE (BLUE)

BOTTOM: COMPONENT SIDE (BLUE)

PART LIST:

RCI-2950 DX / RCI-2970 DX CPU P.C.B

| ITEM | REFERENCE NUMBER | RANGER PART NUMBER | DESCRIPTION |
|------|--|-----------------------|----------------------|
| 1 | | EPT295042Z | CPU P.C.B |
| 2 | C604 | CE0102277Z | 220 μ F 10WV |
| 3 | R606 | RCU128204Z | 82 OHM 2W |
| 4 | R604 | RCU121214Z | 120 OHM 2W |
| 5 | DISPLAY | EX03N40460 | LCD DISPLAY |
| 6 | X601 | EX14N46510 | CERAMIC RESONATOR |
| 7 | BZ601 | EX14N46511 | BUZZER |
| 8 | CN602,CN608 | EX07N41226 | PCB CONN/S 2PIN |
| 9 | CN603-CN605,CN610 | EX07N41216 | PCB CONN/S 3PIN |
| 10 | CN601 | EX07N41250 | PCB CONN/S 4PIN |
| 11 | CN606,CN607 | EX07N41266 | PCB CONN/S 6PIN |
| 12 | JP601,JP602 | EX07N48440 | PCB CONN/H 4PIN |
| 13 | SHORT2 | EX07N48151 | PCB CONN/H SHORT PIN |
| 14 | SK601,SK602 | EX07N48772 | PCB CONN/H 6PIN |
| 15 | CPU P.C.B | EX01N40119 | LED BACK LIGHT |
| 16 | C606 | CK1560AB4A | 56PF 50WV |
| 17 | C601 | CK1330AB4A | 33PF 50WV |
| 18 | C607 | CK1224AB7R | 0.22 μ F 50WV |
| 19 | C608,C609 | CK1102AB7L | 0.001 μ F 50WV |
| 20 | C610-C617,C605 | CK1104AB7L | 0.1 μ F 50WV |
| 21 | C602,C603 | CK5105AB7R | 1 μ F 50WV |
| 22 | COPPER SIDE | RCY011014Z | 100 OHM 0.1W |
| 23 | R607 | RCY014724Z | 4.7K OHM 0.1W |
| 24 | R605 | RCY018224Z | 8.2K OHM 0.1W |
| 25 | R610,R601,R603,R611, R627,R631 | RCY011034Z | 10K OHM 0.1W |
| 26 | R616,R618,R620,R623, R624 | RCY012734Z | 27K OHM 0.1W |
| 27 | R629 | RCY013334Z | 33K OHM 0.1W |
| 28 | R609,R612,R613,R628 | RCY014734Z | 47K OHM 0.1W |
| 29 | R615,R617,R619,R621, R622,R625,R626 | RCY015634Z | 56K OHM 0.1W |
| 30 | R614 | RCY011044Z | 100K OHM 0.1W |
| 31 | R630 | RCY011544Z | 150K OHM 0.1W |
| 32 | R608 | RCY014744Z | 470K OHM 0.1W |
| 33 | R602 | RCY011054Z | 1M OHM 0.1W |
| 34 | U601 | YNRG6950SP | IC HD404818G07FS |
| 35 | U602 | YNMA08005M | IC AN8005M-E2 |
| 36 | U604,U605 | YNR004094B | IC BU4094BF |
| 37 | U606 | YNEX93L46P | IC P93L46 |
| 38 | Q602,Q604 | TY2SD0999Z | TR 2SD999 |
| 39 | Q601,Q603,Q605-Q607 | TY2SC2712G | TR 2SC2712GR |
| 40 | D601,D602 | EDSS00355Y | DIODE ISS355 |

REMARK:

TOP: COMPONENT SIDE

MIDDLE: COMPONENT SIDE (BLUE)

BOTTOM: COPPER SIDE (BLUE)

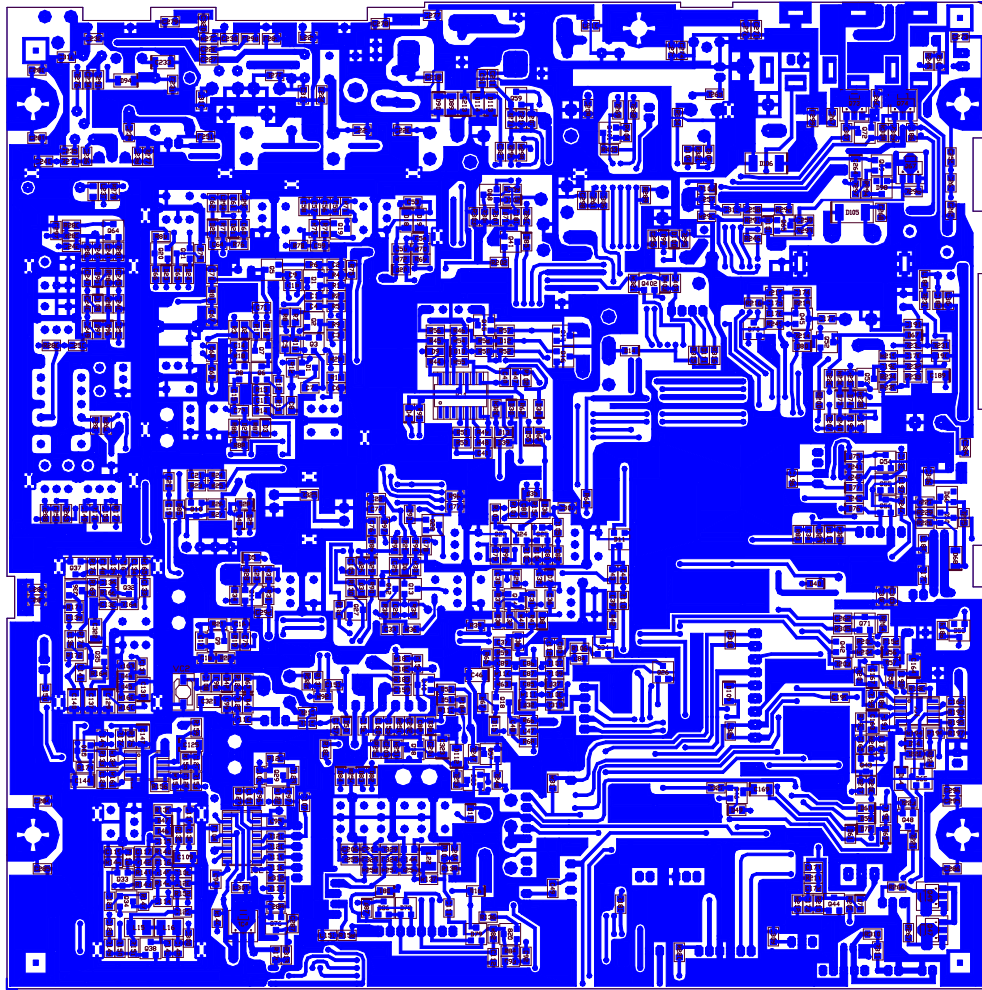

RCI-2950 DX / RCI-2970 DX MAIN PCB.

REMARK:
SMD COMPONENT SIDE (BLUE)

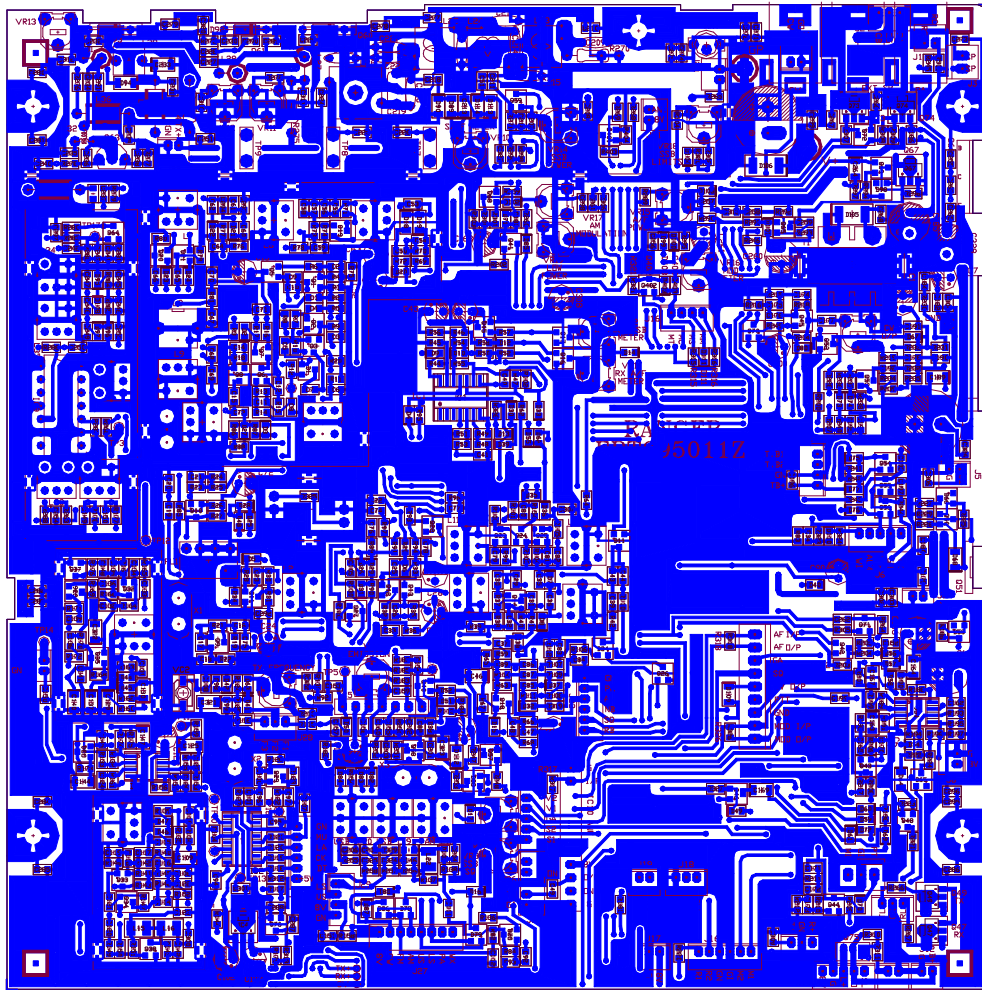

RCI-2950 DX / RCI-2970 DX MAIN PCB

REMARK:
COMPONENT SIDE (BLUE)

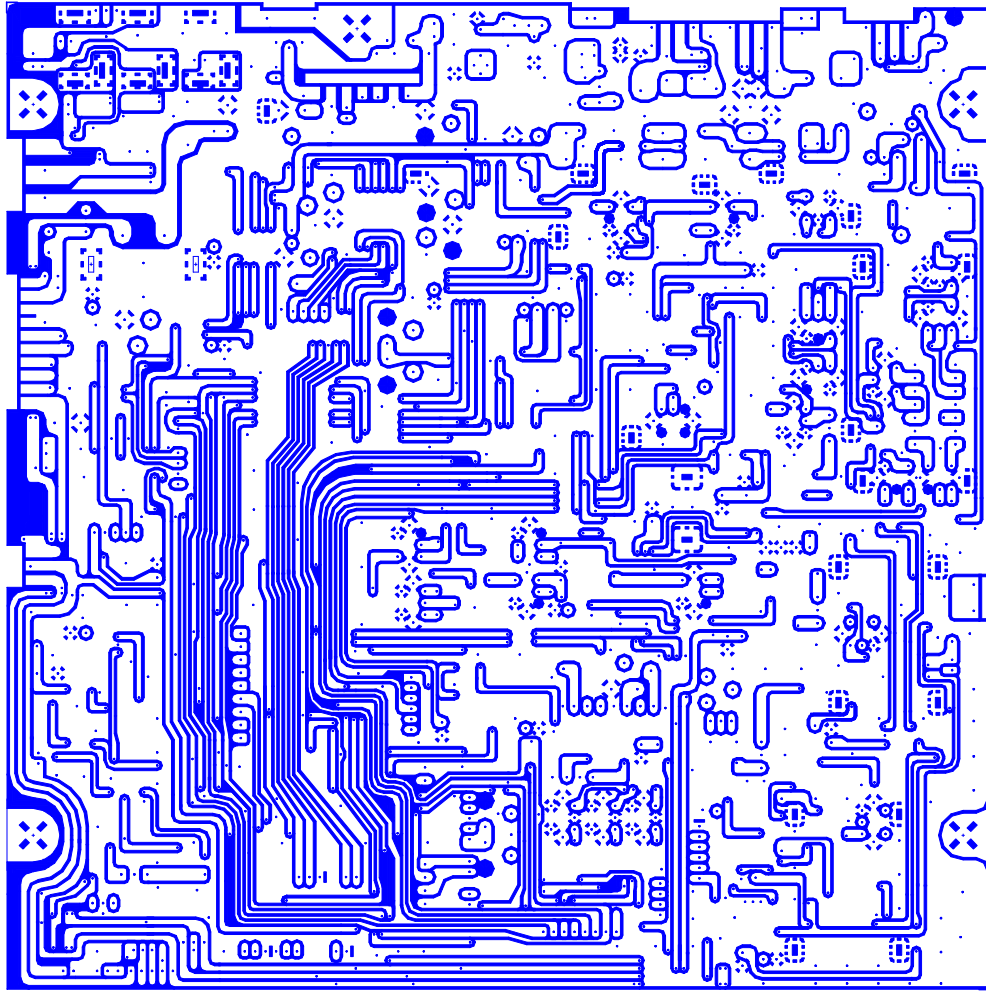

RCI-2950 DX / RCI-2970 DX MAIN PCB

REMARK:
COPPER SIDE (WHITE)

PART LIST
RCI-2950 DX MAIN PCB

| REFERENCE NUMBER | RANGER PART NO. | DESCRIPTION |
|---|-----------------|-------------|
| | EPT695010Z | MAIN P.C.B |
| R315, 317, 318, 321, 328 | RCY010004Z | 0Ω 0.1W |
| R277 | RCY014794Z | 4.7Ω 0.1W |
| R179 | RCY011004Z | 10Ω 0.1W |
| R272, 273 | RCY012204Z | 22Ω 0.1W |
| R246 | RCY013304Z | 33Ω 0.1W |
| R293 | RCY011504Z | 15Ω 0.1W |
| R115, 226, 281 | RCY014704Z | 47Ω 0.1W |
| R227, 231 | RCY015604Z | 56Ω 0.1W |
| R11, 105 | RCY016804Z | 68Ω 0.1W |
| R3, 5, 8, 32, 36, 78, 81, 97, 144, 145, 172, 177, 182, 186, 286, 289, 143, 154, 158 | RCY011014Z | 100Ω 0.1W |
| R35, 104, 276, 280, 136, 253 | RCY011514Z | 150Ω 0.1W |
| R23 | RCY011814Z | 180Ω 0.1W |
| R166, 171, 190, 130 | RCY012214Z | 220Ω 0.1W |
| R33, 103 | RCY012714Z | 270Ω 0.1W |
| R6, 10, 16, 279, 282, 306 | RCY013314Z | 330Ω 0.1W |
| R148, 170, 202, 250, 259, 304, 24, 262, 404 | RCY014714Z | 470Ω 0.1W |
| R146, 167, 263, 292 | RCY015614Z | 560Ω 0.1W |
| R4, 50, 90, 96, 224 | RCY016814Z | 680Ω 0.1W |
| R74 | RCY018214Z | 820Ω 0.1W |
| R19, 22, 64, 67, 71, 75, 82, 101, 117, 122, 127, 149, 150, 152, 174, 178, 192, 199, 207, 213, 225, 233, 244, 249, 255, 257, 258, 266, 267, 268, 269, 271, 287, 294, 297, 307, 308, 322, 326, 116, 134, 329, 96, D99 | RCY011024Z | 1KΩ 0.1W |
| R91, 205 | RCY011224Z | 1.2KΩ 0.1W |
| R56, 89, 100, 220, 221, 237, 260, 278, 283, 299, 79, 80 | RCY011524Z | 1.5KΩ 0.1W |
| R235, 247 | RCY011824Z | 1.8KΩ 0.1W |
| R27, 30, 70, 73, 95, 209, 214, 254, 288, 302, 310, 311, 320, 403 | RCY012224Z | 2.2KΩ 0.1W |
| R9, 25, 31 | RCY012724Z | 2.7KΩ 0.1W |
| R18, 28, 66, 113, 184, 204, 230, 298, 305 | RCY013324Z | 3.3KΩ 0.1W |
| R52, 58 | RCY013924Z | 3.9KΩ 0.1W |
| R29, 38, 86, 206, 211, 212, 215, 216, 256, 261, 277, 327, 72, 139, 104, 141, 142, 159, 162, 163 | RCY014724Z | 4.7KΩ 0.1W |
| R67, 94, 201, 290, 291 | RCY015624Z | 5.6KΩ 0.1W |
| R14, 42, 43, 69, 85 | RCY016824Z | 6.8KΩ 0.1W |
| R92, 300 | RCY018224Z | 8.2KΩ 0.1W |
| R1, 13, 17, 39, 40, 41, 57, 65, 68, 88, 118-121, 123, 126, 157, 164, 165, 168, 173, 187, 188, 194, 217, 223, 228, 137, 239, 240-243, 153, 248, 251, 252, 296, 301, 309, 313, 20, 83, 124, 128, 131, 265, 323, 324, 160, 135, 330, 138 | RCY011034Z | 10KΩ 0.1W |
| R191 | RCY011234Z | 12KΩ 0.1W |
| R193 | RCY011534Z | 15KΩ 0.1W |
| R93, 110, 222, 236, 155 | RCY012234Z | 22KΩ 0.1W |
| R2, 264 | RCY013334Z | 33KΩ 0.1W |

| | | |
|---|------------|--------------|
| R46 | RCY013934Z | 39KΩ 0.1W |
| R7, 34, 62, 63, 99, 132, 175, 198, 229, 234, 319, 200 | RCY014734Z | 47KΩ 0.1W |
| R45 | RCY018234Z | 82KΩ 0.1W |
| R12, 44, 48, 49, 51, 53, 76, 77, 106, 109, 114, 169, 176, 195, 197, 232, 238, 284, 285, 295, 303, 312, 125, 156 | RCY011044Z | 100KΩ 0.1W |
| R183 | RCY011844Z | 180KΩ 0.1W |
| R21, 47, 59, 84, 147, 151, 210, 218, 111 | RCY012244Z | 220KΩ 0.1W |
| R54, 55, 183, 185, 189 | RCY012744Z | 270KΩ 0.1W |
| R15, 37, 196, 219 | RCY014744Z | 470KΩ 0.1W |
| R102 | RCY018244Z | 820KΩ 0.1W |
| R108, 161, 133 | RCY011054Z | 1MΩ 0.1W |
| R208 | RCY011554Z | 1.5MΩ 0.1W |
| C236, 248, 249, 61 | CK1010AB1A | 1PF 50WV |
| C208, 211, 218 | CK1030AB1A | 3PF 50WV |
| C68, 69, 88, 95, 121, 253, 86 | CK1050AB1A | 5PF 50WV |
| C108 | CK1080AB2A | 8PF 50WV |
| C1, 57, 108, 142, 148, 155, 247 | CK1100AB2A | 10PF 50WV |
| C98, 117 | CK1150AB4A | 15PF 50WV |
| C51 | CK1180AB4A | 18PF 50WV |
| C150, 133 | CK1220AB4A | 22PF 50WV |
| C44 | CK1270AB4A | 27PF 50WV |
| C19, 30, 120, 136, 89 | CK1330AB4A | 33PF 50WV |
| C243, 300 | CK1470AB4A | 47PF 50WV |
| C115 | CK1680AB4A | 68PF 50WV |
| C8 | CK1820AB4A | 82PF 50WV |
| C4, 79, 114, 139, 160, 212, 301, COPPER SIDE | CK1101AB5A | 100PF 50WV |
| C143 | CK1121AB5A | 120PF 50WV |
| C101 | CK1151AB5A | 150PF 50WV |
| C242 | CK1181AB5A | 180PF 50WV |
| C35, 237, 131 | CK1221AB5A | 220PF 50WV |
| C39 | CK1271AB5A | 270PF 50WV |
| C11, 14 | CK1331AB5A | 330PF 50WV |
| C227 | CK1391AB5A | 390PF 50WV |
| C60, 62 | CK1471AB5A | 470PF 50WV |
| C29 | CK1561AB5A | 560PF 50WV |
| C206 | CK1390AB4D | 39PF 50WV |
| C291 | CK1100AB2G | 10PF 50WV |
| C119 | CK1330AB4G | 33PF 50WV |
| C18, 118, 135 | CK1680AB4G | 68PF 50WV |
| C134 | CK1101AB5G | 100PF 50WV |
| C202, 205 | CK1151AB5G | 150PF 50WV |
| C17 | CK1271AB5G | 270PF 50WV |
| C203 | CK1331AB5G | 330PF 50V |
| C20, 100 | CK1391AB5G | 390PF 50V |
| C227, 228, 289, 290 | CK1561AB5G | 560PF 50WV |
| C256 | CK1103AB7A | 0.01μF 50WV |
| C48, 64, 85, 104, 124, 288, 182, 210, 229, 230, 231, 239, 245, 246, 257, 287, 304, 326, 112, 122, 146, 152, 225, 271, 275, 278, 282, 285, 285, 286, 295, 302, 156, 279, 280, 111, 307, 309, 310, 311, 312, 313, 320 | CK2104AB7R | 0.1μF 25WV |
| C2, 3, 6, 9, 15, 21, 22, 25, 33, 34, 37, 59, 65-67, 73, 76, 87, 92, 96, 97, 105, 106, 324, 116, 123, 132, 141, 70, 325, 145, 149, 153, 158, 159, 175, 176, 177, 193, 196, 197, 201, 207, 224, 226, 232, 234, 235, 238, 240, 250, 251, 254, 255, 268, 292, 297-299, 303, 190, 281, 38, 82, 99, 71, 403 | CK1103AB6U | 0.01μF 50WV |
| C7, 31, 36, 55, 58, 83, 93, 107, 267, 138, 150, 178, 181, 191, 192, 204, 259, 265, 266 | CK1102AB7L | 0.001μF 50WV |

| | | |
|------------------------------|------------|-------------|
| J16-50Z(J504)-60Z(J601) | EX07N49044 | WIRE CONN/H |
| J28-60Z(J602) | EX07N49108 | WIRE CONN/H |
| J12-42Z(J601) | EX07N49109 | WIRE CONN/H |
| J10-42Z(CN605)-70Z(J702/703) | EX07N49110 | WIRE CONN/H |
| J27-90Z(J401) | EX07N49115 | WIRE CONN/H |
| C259,260 | CC0501036S | 0.01μF 50WV |
| DCx2 | CC0501037L | 0.01μF 50WV |
| IC7 | ENTA07222A | IC TA7222AP |
| Q66 | T2SB00754Y | TR 2SB754Y |
| Q62 | T2SC02166C | TR 2SC2166C |
| Q60,61 | T2SC02312C | TR 2SC2312C |
| Q51 | T2SA01869Z | TR 2SA1869 |

RCI-2950 DX MISC. PART

| REFERENCE NUMBER | RANGER PART NO. | DESCRIPTION |
|----------------------------|-----------------|------------------|
| - | ES200820MC | SPEAKER |
| C259,260 | CC0201036S | C/C 0.01UF |
| - | EX02N40210 | FUSE 16V 7A |
| - | WA0012185A | DC CORD |
| - | EX06N41036 | TERMINAL |
| - | EX04N40620 | MIC ASSY |
| - | PT29500100 | FRONY PANEL |
| - | PT2950031A | REFRACTOR |
| - | PT2950051B | PLATE |
| BAND | PT2950051B | KNOB (VR) |
| UO DOWN | PT2950060B | KNOB(SW) |
| VR | PT2950071B | INNER KNOB |
| VR | PT2950080B | OUTER KNOB |
| - | PT2950090A | LCD WINDOW |
| - | PT2950100A | SH. PLATE |
| - | MT2970020A | BOTTOM |
| - | MT2950031A | HOUSING |
| - | MT2950011P | TOP HOUSING |
| - | MT2950011P | FRONT |
| - | MT2950011P | CHASSIS |
| UP DOWN | MT3600080T | D SPRING A |
| VR | MT3600090T | D SPRING B |
| VR | MT3600100T | D SPRING D |
| SP | MT2970050X | - |
| - | ML1200110X | SET PLATE |
| - | BT6300041A | MIC PLATE |
| - | QT2950010A | RUBBER KEY |
| - | GZZZ50000Z | CLAMP |
| - | XZZZ90232Z | METER STOPPER |
| BEEP | XZZZ90206Z | SPONGE |
| - | XZZZ90342Z | NYLON SPACERS |
| - | XZZZ90098Z | SOLDER PLATE |
| - | XZZZ90005Z | FOAM |
| - | LZZZ062052A | REG. CARD |
| - | LZZZ62068Z | SERV. CARD |
| - | LZZZ61472Z | WARRANTY LABEL |
| - | LZZZ61351Z | ATTACH LABEL |
| - | LZZZ61515Z | CAU. LABEL |
| - | LZZZ61516Z | CAU. LABEL |
| - | LZZZ61528A | WARRANTY LABEL |
| - | LZZZ61529A | WARRANTY LABEL |
| - | LZZZ61538A | WARRANTY LABEL |
| FRONT PANEL | JS033006MN | SET SCREW |
| SET CHASSIS, LCD & CPU PCB | JS053006MN | SET SCREW |
| MAIN PCB | JS053006TN | SET SCREW |
| SPEAKER | JS053008MN | SET SCREW |
| - | JS053010MN | SET SCREW |
| - | JS055006MN | SET SCREW |
| - | JS013006MN | SET SCREW |
| POWER PCB | JS052606MN | SET SCREW |
| SHIELD COVER | JS013004MN | SET SCREW |
| - | JS015010WH | SET SCREW |
| - | JS013508TH | SET SCREW |
| - | JW315510CN | OUT-TOOTH WASHER |
| - | JW324008CN | IN-TOOTH WASHER |
| - | XZZZ90188Z | FIBER WASHER |

PART LIST
RCI-2970 DX MAIN PCB

| REFERENCE NUMBER | RANGER PART NO. | DESCRIPTION |
|---|-----------------|-------------|
| | EPT695010Z | MAIN P.C.B |
| R315, 317, 318, 321, 328 | RCY010004Z | 0Ω 0.1W |
| R179 | RCY011004Z | 10Ω 0.1W |
| R272, 273 | RCY012204Z | 22Ω 0.1W |
| R246 | RCY013304Z | 33Ω 0.1W |
| R293 | RCY011504Z | 15Ω 0.1W |
| R115, 226, 281 | RCY014704Z | 47Ω 0.1W |
| R227, 231 | RCY015604Z | 56Ω 0.1W |
| R11, 105 | RCY016804Z | 68Ω 0.1W |
| R3, 5, 8, 32, 36, 78, 81, 97, 144, 145, 172, 177, 182, 186, 286, 289, 143, 154, 158 | RCY011014Z | 100Ω 0.1W |
| R35, 104, 276, 280, 136, 253 | RCY011514Z | 150Ω 0.1W |
| R23 | RCY011814Z | 180Ω 0.1W |
| R166, 171, 190, 130 | RCY012214Z | 220Ω 0.1W |
| R33, 103 | RCY012714Z | 270Ω 0.1W |
| R6, 10, 16, 279, 282, 306 | RCY013314Z | 330Ω 0.1W |
| R148, 170, 202, 250, 259, 304, 24, 262, 404 | RCY014714Z | 470Ω 0.1W |
| R146, 167, 263, 292 | RCY015614Z | 560Ω 0.1W |
| R4, 50, 90, 96, 224 | RCY016814Z | 680Ω 0.1W |
| R74 | RCY018214Z | 820Ω 0.1W |
| R19, 22, 64, 67, 71, 75, 82, 101, 117, 122, 127, 149, 150, 152, 174, 178, 192, 199, 207, 213, 225, 233, 244, 249, 255, 257, 258, 266, 267, 268, 269, 271, 287, 294, 297, 307, 308, 322, 326, 116, 134, 329, 96, D99 | RCY011024Z | 1KΩ 0.1W |
| R91, 205 | RCY011224Z | 1.2KΩ 0.1W |
| R56, 89, 100, 220, 221, 260, 278, 283, 299, 79, 80 | RCY011524Z | 1.5KΩ 0.1W |
| R235, 247 | RCY011824Z | 1.8KΩ 0.1W |
| R27, 30, 70, 73, 95, 209, 214, 254, 288, 302, 310, 311, 320, 403 | RCY012224Z | 2.2KΩ 0.1W |
| R9, 25, 31 | RCY012724Z | 2.7KΩ 0.1W |
| R18, 28, 66, 113, 184, 204, 230, 298, 305 | RCY013324Z | 3.3KΩ 0.1W |
| R52, 58 | RCY013924Z | 3.9KΩ 0.1W |
| R29, 38, 86, 206, 211, 212, 215, 216, 256, 261, 327, 139, 104, 141, 14, 2, 159, 162, 163 | RCY014724Z | 4.7KΩ 0.1W |
| R67, 94, 201, 290, 291 | RCY015624Z | 5.6KΩ 0.1W |
| R14, 42, 43, 69, 85 | RCY016824Z | 6.8KΩ 0.1W |
| R92, 300 | RCY018224Z | 8.2KΩ 0.1W |
| R1, 13, 17, 39, 40, 41, 57, 65, 68, 88, 118-121, 123, 126, 157, 164, 165, 168, 173, 187, 188, 194, 217, 223, 228, 137, 239, 240-243, 153, 248, 251, 252, 296, 301, 309, 313, 20, 83, 124, 128, 131, 265, 323, 324, 160, 135, 330, 138, C403 | RCY011034Z | 10KΩ 0.1W |
| R191, 138 | RCY011234Z | 12KΩ 0.1W |
| R193 | RCY011534Z | 15KΩ 0.1W |
| R93, 110, 222, 236, 155 | RCY012234Z | 22KΩ 0.1W |
| R2, 264 | RCY013334Z | 33KΩ 0.1W |
| R46 | RCY013934Z | 39KΩ 0.1W |

| | | |
|---|------------|--------------|
| R7, 34, 62, 63, 99, 132, 175, 198, 229, 234, 319, 200 | RCY014734Z | 47KΩ 0.1W |
| R26, 107, 112, 181 | RCY016834Z | 68KΩ 0.1W |
| R45 | RCY018234Z | 82KΩ 0.1W |
| R12, 44, 48, 49, 51, 53, 76, 77, 106, 109, 114, 169, 176, 195, 197, 232, 238, 284, 285, 303, 312, 125, 156 | RCY011044Z | 100KΩ 0.1W |
| R21, 47, 59, 84, 147, 151, 210, 218, 111 | RCY012244Z | 220KΩ 0.1W |
| R54, 55, 185, 189 | RCY012744Z | 270KΩ 0.1W |
| R15, 37, 196, 219 | RCY014744Z | 470KΩ 0.1W |
| R102 | RCY018244Z | 820KΩ 0.1W |
| R108, 161, 133 | RCY011054Z | 1MΩ 0.1W |
| R208 | RCY011554Z | 1.5MΩ 0.1W |
| C236, 248, 249, 61 | CK1010AB1A | 1PF 50WV |
| C208, 218 | CK1030AB1A | 3PF 50WV |
| C68, 69, 88, 95, 121, 253, 86 | CK1050AB1A | 5PF 50WV |
| C108 | CK1080AB2A | 8PF 50WV |
| C1, 57, 142, 148, 155, 247 | CK1100AB2A | 10PF 50WV |
| C98, 117 | CK1150AB4A | 15PF 50WV |
| C51 | CK1180AB4A | 18PF 50WV |
| C150, 133 | CK1220AB4A | 22PF 50WV |
| C44 | CK1270AB4A | 27PF 50WV |
| C19, 30, 120, 136, 89 | CK1330AB4A | 33PF 50WV |
| C243, 300 | CK1470AB4A | 47PF 50WV |
| C212 | CK1560AB4A | 56PF 50WV |
| C115 | CK1680AB4A | 68PF 50WV |
| C8 | CK1820AB4A | 82PF 50WV |
| C4, 79, 114, 139, 160, 301, COPPER SIDE | CK1101AB5A | 100PF 50WV |
| C143 | CK1121AB5A | 120PF 50WV |
| C101 | CK1151AB5A | 150PF 50WV |
| C242 | CK1181AB5A | 180PF 50WV |
| C35, 237, 131 | CK1221AB5A | 220PF 50WV |
| C39 | CK1271AB5A | 270PF 50WV |
| C11, 14 | CK1331AB5A | 330PF 50WV |
| C60, 62, 228 | CK1471AB5A | 470PF 50WV |
| C29 | CK1561AB5A | 560PF 50WV |
| C206 | CK1390AB4D | 39PF 50WV |
| C291 | CK1100AB2G | 10PF 50WV |
| C119 | CK1330AB4G | 33PF 50WV |
| C18, 118, 135 | CK1680AB4G | 68PF 50WV |
| C134 | CK1101AB5G | 100PF 50WV |
| C202, 205 | CK1151AB5G | 150PF 50WV |
| C17 | CK1271AB5G | 270PF 50WV |
| C203 | CK1331AB5G | 330PF 50WV |
| C20, 100 | CK1391AB5G | 390PF 50WV |
| C227, 228, 289, 290, C256 | CK1561AB5G | 560PF 50WV |
| C48, 64, 85, 104, 124, 288, 182, 210, 229, 230, 231, 239, 245, 246, 257, 287, 326, 112, 122, 146, 152, 225, 304, 271, 275, 278, 282, 285, 285, 286, 295, 302, 156, 279, 280, 111, 307, 309, 310, 311, 312, 313, 320, 263 | CK1103AB6U | 0.01μF 50WV |
| C2, 3, 6, 9, 15, 21, 22, 25, 33, 34, 37, 59, 65-67, 73, 76, 87, 92, 96, 97, 105, 106, 324, 116, 123, 132, 141, 70, 325, 145, 149, 153, 158, 159, 175, 176, 177, 193, 196, 197, 201, 207, 224, 226, 232, 234, 235, 238, 240, 250, 251, 254, 255, 268, 292, 297-299, 303, 190, 281, 38, 82, 99, 71, 403 | CK2104AB7R | 0.1μF 25WV |
| C7, 31, 36, 55, 58, 83, 93, 107, 267, 138, 150, 178, 181, 191, 192, 204, 259, 265, 266 | CK1102AB7L | 0.001μF 50WV |

| | | |
|------------------------------|------------|-------------|
| J16-50Z(J504)-60Z(J601) | EX07N49044 | WIRE CONN/H |
| J28-60Z(J602) | EX07N49108 | WIRE CONN/H |
| J12-42Z(J601) | EX07N49109 | WIRE CONN/H |
| J10-42Z(CN605)-70Z(J702/703) | EX07N49110 | WIRE CONN/H |
| J27-90Z(J401) | EX07N49115 | WIRE CONN/H |
| C259,260 | CC0501036S | 0.01μF 50WV |
| DCx2 | CC0501037L | 0.01μF 50WV |
| IC7 | ENTA07222A | IC TA7222AP |
| Q66 | T2SB00754Y | TR 2SB754Y |
| Q62 | T2SC02166C | TR 2SC2166C |
| Q60 | T2SC02312C | TR 2SC2312C |
| Q51 | T2SA01869Z | TR 2SA1869 |
| Q60,62 | EDMV00001Y | DIODE MV-1Y |

RCI-2970 DX MISC. PART

| REFERENCE NUMBER | RANGER PART NO. | DESCRIPTION |
|----------------------------|-----------------|------------------|
| - | ES200820MC | SPEAKER |
| C259,260 | CC0201036S | C/C 0.01UF |
| - | EX02N40210 | FUSE 16V 7A |
| - | WA0012185A | DC CORD |
| - | EX06N41036 | TERMINAL CONN |
| - | EX04N40620 | MIC ASSY |
| - | PT29500100 | FRONY PANEL |
| - | PT2950031A | REFRACTOR PLATE |
| BAND | PT2950051B | KNOB (VR) |
| UO DOWN | PT2950060B | KNOB(SW) |
| VR | PT2950071B | INNER KNOB |
| VR | PT2950080B | OUTER KNOB |
| - | PT2950090A | LCD WINDOW |
| - | PT2950100A | SH. PLATE |
| - | MT2970020A | BOTTOM HOUSING |
| - | MT2950031A | TOP HOUSING |
| - | MT2950011P | FRONT CHASSIS |
| UP DOWN | MT3600080T | D SPRING A |
| VR | MT3600090T | D SPRING B |
| VR | MT3600100T | D SPRING D |
| SP | MT2970050X | - |
| - | ML1200110X | SET PLATE |
| - | BT6300041A | MIC PLATE |
| - | QT2950010A | RUBBER KEY |
| - | GZZZ50000Z | CLAMP |
| BEEP | XZZZ90232Z | METER STOPPER |
| - | XZZZ90206Z | SPONGE |
| - | XZZZ90342Z | NYLON SPACERS |
| - | XZZZ90098Z | SOLDER PLATE |
| - | XZZZ90005Z | FOAM |
| - | LZZZ062052A | REG. CARD |
| - | LZZZ62068Z | SERV. CARD |
| - | LZZZ61472Z | WARRANTY LABEL |
| - | LZZZ61351Z | ATTACH LABEL |
| - | LZZZ61515Z | CAU. LABEL |
| - | LZZZ61516Z | CAU. LABEL |
| - | LZZZ61528A | WARRANTY LABEL |
| - | LZZZ61529A | WARRANTY LABEL |
| - | LZZZ61538A | LABEL |
| FRONT PANEL | JS033006MN | SET SCREW |
| SET CHASSIS, LCD & CPU PCB | JS053006MN | SET SCREW |
| MAIN PCB | JS053006TN | SET SCREW |
| SPEAKER | JS053008MN | SET SCREW |
| - | JS053010MN | SET SCREW |
| - | JS055006MN | SET SCREW |
| - | JS013006MN | SET SCREW |
| POWER PCB | JS052606MN | SET SCREW |
| SHIELD COVER | JS013004MN | SET SCREW |
| - | JS015010WH | SET SCREW |
| - | JS013508TH | SET SCREW |
| - | JW315510CN | OUT-TOOTH WASHER |
| - | JW324008CN | IN-TOOTH WASHER |
| - | XZZZ90188Z | FIBER WASHER |

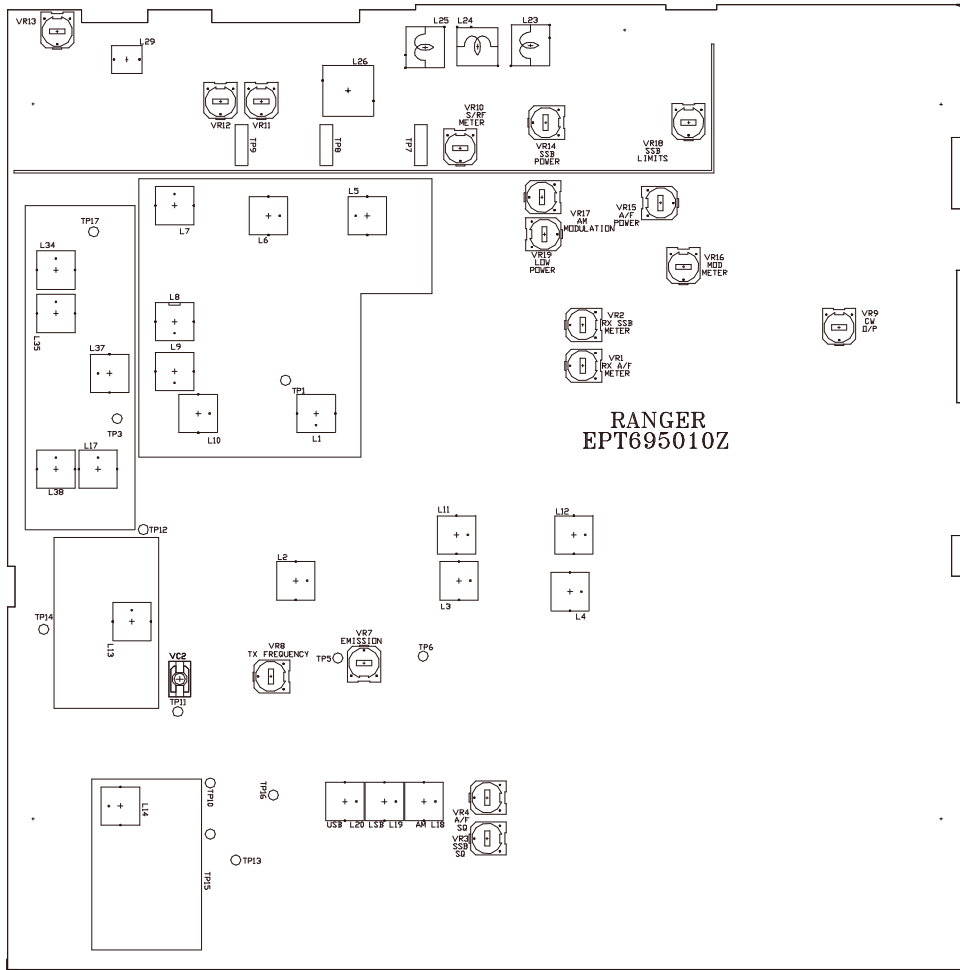

Figure 6-3 Main PCB Adjustment Location