

1. SPECIFICATIONS

Type:	Two channel audio power amplifier
Gain:	26 dB (each channel)
Continuous Average Power Output	75 watts per channel at 8 ohms 100 watts per channel at 4 ohms 180 watts at Bridged mono at 8 ohms.
Frequency Response:	Plus/Minus 0.5dB 20Hz-20kHz
Distortion:	No more than 0.25% THD or IM, 0.01W to rated power, 20Hz to 20kHz (typically 0.02%)
Hum and Noise:	101dB below rated output (unweighted 20KHz bandwidth)
Input Sensitivity:	1.6V RMS for rated output
Input Impedance:	15K ohms, nominal
Input Connector:	(2) ¼-inch phone jacks and XLR jacks. (unbalanced and balanced)
Output Connectors:	Dual 5-way binding posts
Controls & Indicators:	(Front Panel) AC main power switch, Power-on LED indicator, Signal on LED indicator Clip LED indicator × 2pcs Channel One and Two level controls Monitor jacks 2 pcs
Power:	110-120VAC/60Hz } switchable 220-240VAC/50Hz } 30W (idle), 300W (maximum)
Dimensions:	1-3/4''H (4.4cm) 19''W (48.3cm) 11.9'' (30.2cm) behind panel 13'' (32.5cm) overall
Weight:	16.2 lbs (7.3 kg)

2. OPERATING THE AB 200

-FRONT PANEL-

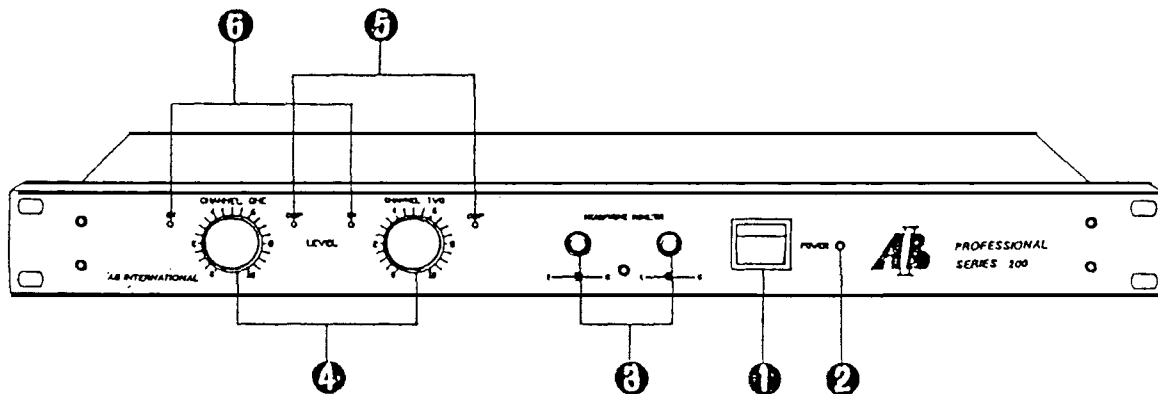

-REAR PANEL-

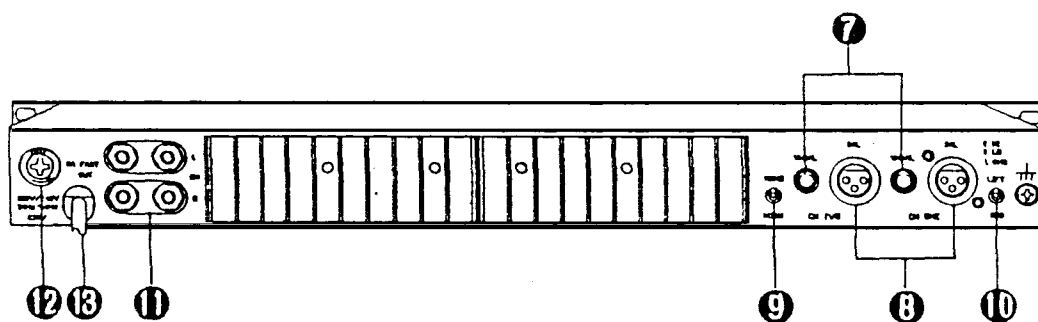

- | | |
|---------------------------------------|-------------------------------|
| FRONT: 1. POWER SWITCH | 2. POWER INDICATING LED |
| 3. HEADPHONE MONITOR JACKS | 4. LEVEL CONTROLS |
| 5. CLIP INDICATORS | 6. ON INDICATORS |
| REAR: 7. UNBALANCED INPUT CONNECTIONS | 8. BALANCED INPUT CONNECTIONS |
| 9. NORM/MONO SELECTOR SWITCH | 10. GROUND/LIFT SWITCH |
| 11. OUTPUT CONNECTIONS | |

4. ADJUSTMENT AND TEST POINT LOCATIONS

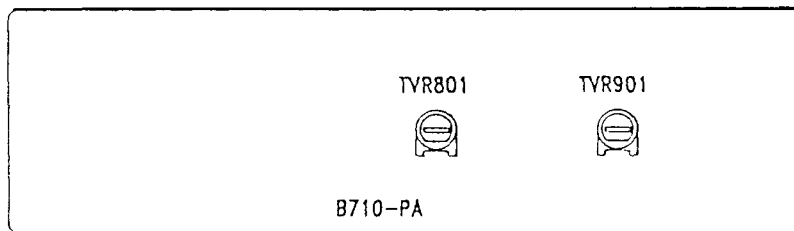

INITIAL SETTINGS:
LEVEL CONTROL: MINIMUM

ITEM	MEASURING POINT	ADJ.POINT	MEASURE
IDEL CURRENT ADJ.	R827,828	TVR801	6-10mV
IDEL CURRENT ADJ.	R927,928	TVR901	6-10mV
CENTER VOLT.CHECK	CH 1 OUTPUT TO GND	-	<30mV
CENTER VOLT.CHECK	CH 2 OUTPUT TO GND	-	<30mV

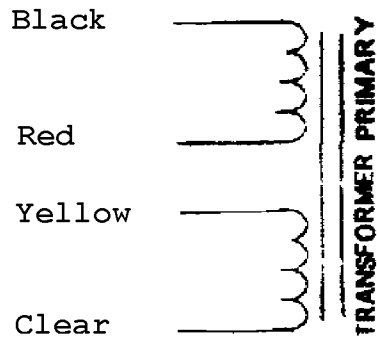

Original Xfmr Color Code

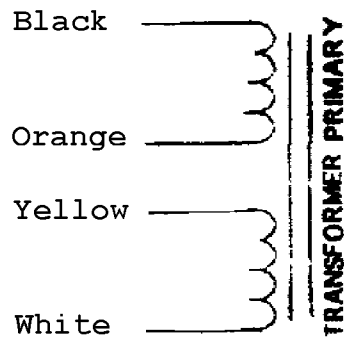

Replacement Xfrm Color Code PN 750-518B

Like colors exchange for like colors for example:

Black on the new xfmr takes the place of Black on the old xfmr.

Yellow is the same.

Orange on the new xfmr takes the place of the red on the old xfmr.

White on the new xfmr takes the place of the clear on the old xfmr.

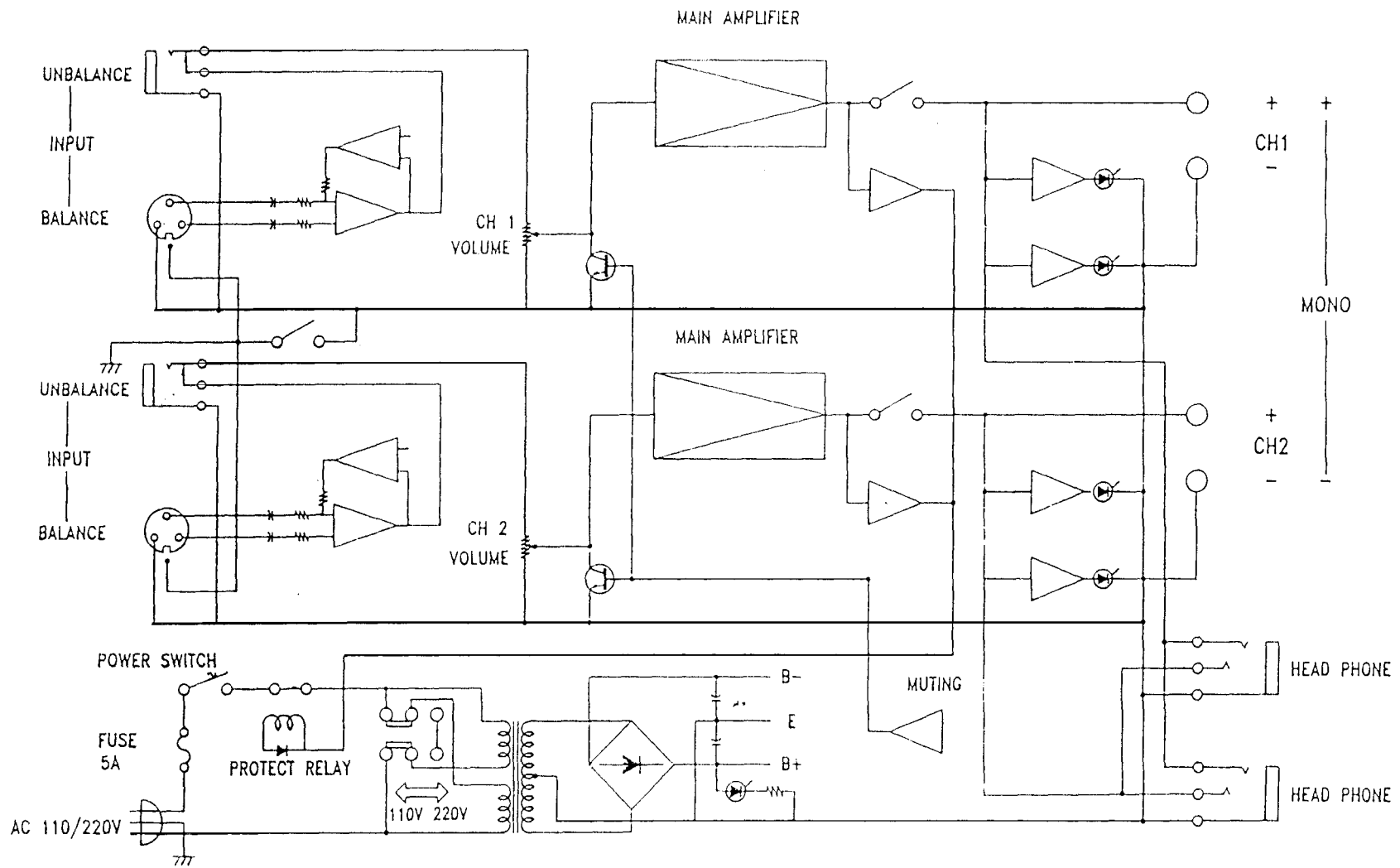

5. BLOCK DIAGRAM

8. PARTS LIST

AB-200

REF. NO.	DESCRIPTION	Q'TY	REMARK
1.	FRONT PANEL L-311	1	
2.	MAIN CHASSIS C-1418	1	
3.	REAR PANEL C-1417	1	
4.	UPPER COVER C-1415	1	
5.	PHONE HOLDER C-1432	1	
6.	CAPACITOR HOLDER C-1433A	1	
7.	HEAT SINK H-190	2	
8.	SPEAKER TERMINAL HT-2874	2	
9.	AC CORD 3P VDE (EUR)	1	
	AC CORD 3P SVT (USA)	1	
10.	BUSHING 6W-2	1	
11.	FUSE 5 ϕ x20x2.5A (EUR)	1	
	FUSE 6.3 ϕ x31.7x5A (USA)	1	
12.	FUSE HOLDER R3-22B (EUR)	1	
	FUSE HOLDER R3-22A (USA)	1	
13.	CONNECTOR E-D331 (BLACK)	1	
14.	CONNECTOR E-D337 (RED , WHITE)	1	
15.	POWER SW 1804 112119015	1	
16.	WIRE CONNECTOR S-1	2	
17.	TOROID TRANSFORMER RH51834S2ABD	1	
18.	LED 2 ϕ L-211D RED	3	
19.	LED 2 ϕ L-211GD GREEN	2	
20.	CABLE TIE 90MM	13	
21.	FOOT CUSHION 18 ϕ x 10MM	4	
22.	KNOB KB-252 23.8 ϕ	2	
23.	RUBBER WASHER D-070	3	
24.	STYROFORM PF-107	1	
25.	STYROFORM PF-104	1	
26.	OWNER'S MANUAL	1	
27.	INSIDE CARTON	1	
28.	OUTSIDE CARTON	1	
29.	SCREW CRIS 3x6 (Y)	2	FOR E/C
30.	SCREW CRIS 3x6 (B)	3	FOR PCB.
31.	SCREW CRMS 3x6 (B)	4	SW , XLR
32.	SCREW CRMS 3x6 (W)	1	
33.	SCREW CRMS 4x12 (B)	4	HEAT SINK
34.	SCREW CRWMS 4x8 (B)	4	FOOT CUSTION
35.	SCREW CRWMS 4x8 (W)	1	GROUND
36.	FLAT & HEXAGON SCREW SCREW MS 4x10 (B)	5	FRONT PANEL
37.	NUT WITH GEAR 3 ϕ (Y)	3	SW , GROUND
38.	GEAR WASHER 3 ϕ (W)	2	GROUND
39.	GEAR WAHER 4 ϕ	1	GROUND

P.C. BOARD B710-PA

REF.NO.	DESCRIPTION	Q'TY	REMARKS
	TEMPERATURE SW T95AR1U1	2	
	TEMPERATURE SW HOLDER C-1307	2	
	TAGGER SW A1M4-T05	1	
	TAGGER SW A2M4-T05	1	
	PHONE JACK HTJ064-03L1	2	
	XLR PLUG 4-24027	2	
	XLR HOLDER C-1419	1	
	PLASTIC SCREW 1/8x9 (B)	4	XLR
	CABLE TIE 1 ϕ 100MM	1	
	CABLE TIE 5.8 ϕ 38MM	1	
	HEAT SINK H-198	4	
	HEAT SINK HOLDER (SMALL) H-154	4	
	L TYPE HEAT SINK H-189	1	
	SCREW CRTS 3x6 (Y)	4	
	SCREW CRTS 3x6 (Y)	2	
	SCREW CRTS 3x8 (Y)	2	
	SCREW CRMS 3x8 (Y)	4	
	SCREW CRMS 3x14 (W)	8	
	COIL 15Tx10 ϕ x1 ϕ	2	
	WAFER 5045-3	4	
	WAFER 5273-2	1	
	WAFER 5273-3	1	
	PIN 1.2x1.2x19	4	
	SPRING WASHER 3 ϕ (Y)	12	
	NUT WITH GEAR 3 ϕ (Y)	8	

-CARBON RESISTORS T TYPE-

ALL RESISTORS ARE RATED $\pm 5\%$ TOLERANCE AND 1/4W

R817, R917	200 ohm
R816, R916	560 ohm
R819, R919	820 ohm
R810, R910	2K2 ohm
R934	4K7 ohm

-CARBON RESISTORS T TYPE-

ALL RESISTORS ARE RATED $\pm 5\%$ TOLERANCE AND 1/3W

R921, R924, R821, R824, R835, R935	100 ohm
R808, R908	150 ohm
R812, R912	750 ohm
R822, R823, R922, R923	1K ohm
R832, R932	3K9 ohm
R806, R807, R834, R906, R907	10K ohm
R809, R909, R818, R918	15K ohm
R801, R901	22K ohm
R802, R803, R902, R903	100K ohm
R804, R805, R904, R905	220K ohm

-CARBON RESISTORS T TYPE-

ALL RESISTORS ARE RATED $\pm 5\%$ TOLERANCE AND 1/2W

R815, R820, R825, R826	47 ohm
R920, R915, R925, R926	47 ohm
R813, R913	220 ohm
R831, R931	4K7 ohm

P.C. BOARD B711-CA, PR, LED, PS

REF. NO.	DESCRIPTION	Q'TY	REMARKS
	VR R-10A50K41PC	2	
	PHONE JACK JY-6304-02-030	2	
	AC SELECTOR SW T-8716	1	
	PRESS TERMINAL FDN1-205	4	
	LED 2 ϕ L-212D	1	
	CONNECT HOLDER C-1430	4	
	GEAR WASHER 5.3x10.2x0.5	2	WITH E/C
	SCREW CRMS 4.5x10 (Y)	2	WITH E/C
	PLASTIC WIRE #22 1015 BROWN 140MM	1	
	PLASTIC WIRE #22 1015 WHITE 140MM	1	
	PIN 1x1x19	2	
	REPAY MEI DC24V	1	

-CARBON RESISTORS T TYPE-

ALL RESISTORS ARE RATED $\pm 5\%$ TOLERANCE AND 1/4W

R302, R402	200 ohm
R005, R305, R307, R405, R407	3K9 ohm
R301, R401	6K8 ohm
R004, R008, R009	22K ohm
R304, R404	33K ohm
R308, R408, R311, R411	56K ohm
R303, R403	100K ohm
R309, R312, R409, R412	150K ohm
R006	220K ohm
R306, R406	1M ohm

-CARBON RESISTORS T TYPE-

ALL RESISTORS ARE RATED $\pm 5\%$ TOLERANCE

R010	1K ohm	1/2W
R310, R313, R410, R413	5K6 ohm	1/2W

-METAL RESISTORS T TYPE-

ALL RESISTORS ARE RATED $\pm 2\%$ TOLERANCE AND 1W

R314, R414	100 ohm
R001, R002	1K8 ohm
R003	3K9 ohm

-CAPACTIORS-

C007, C008	0.005/500V	CERAMIC	
C304, C404	0.1K/50V K	MYLAR	
C301, C401	6.8u/50V	ELEC.	NP
C005	47u/50V	ELEC.	
C003, C004	470u/16V	ELEC.	
C006	470u/50V	ELEC.	

-TRAS ISTOR-

Q001, Q301, Q302, Q401, Q402	2SA970	
Q303, Q304, Q403, Q404	2SC2240	
T301, Q302, Q401, Q402	MA97A6	TRIAC
Q002, Q003	2SC3327	

D011,D009,D301,D401
D005,D008
D012
D013
D010,D014

-DIODE-
IN4148
6.8V/0.5W ZENER
26V/0.5W ZENER
KB-265
IN4002 RECTIFIER

J007,J012,J013,J014,J015
J010A
J005A
J016A
J001A,J003A
J009A,J006A
J004A

-CONNECT-
E-D311
E-D335
E-D336
E-D225
E-D333
E-D332
E-D338

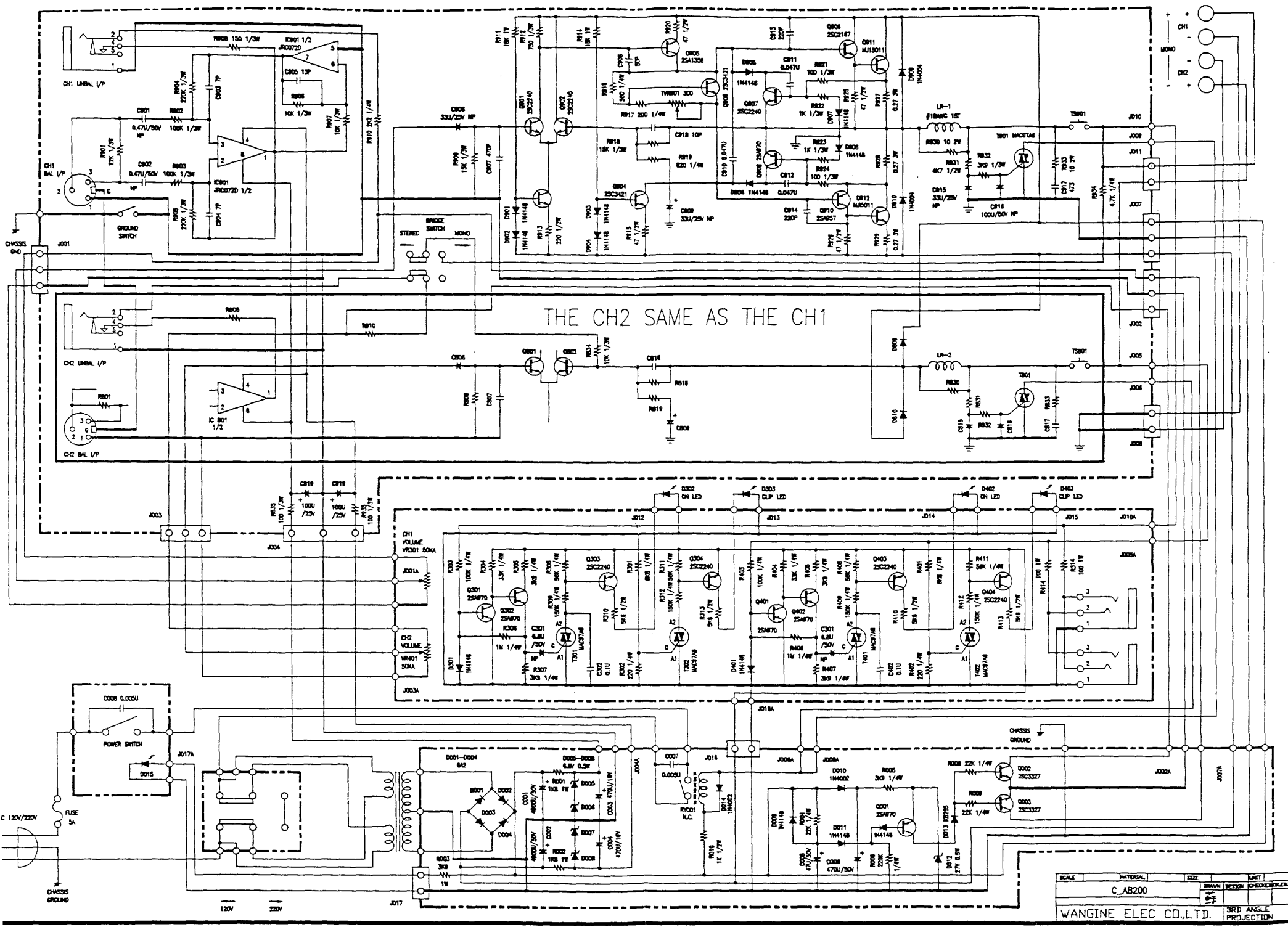

THE CH2 SAME AS THE CH1

SCALE	INTERNAL	SIZE	SHEET
C_AB200		BRN	REC'D
WANGINE ELEC. CO., LTD.		3RD ANGLE PROJECTION	

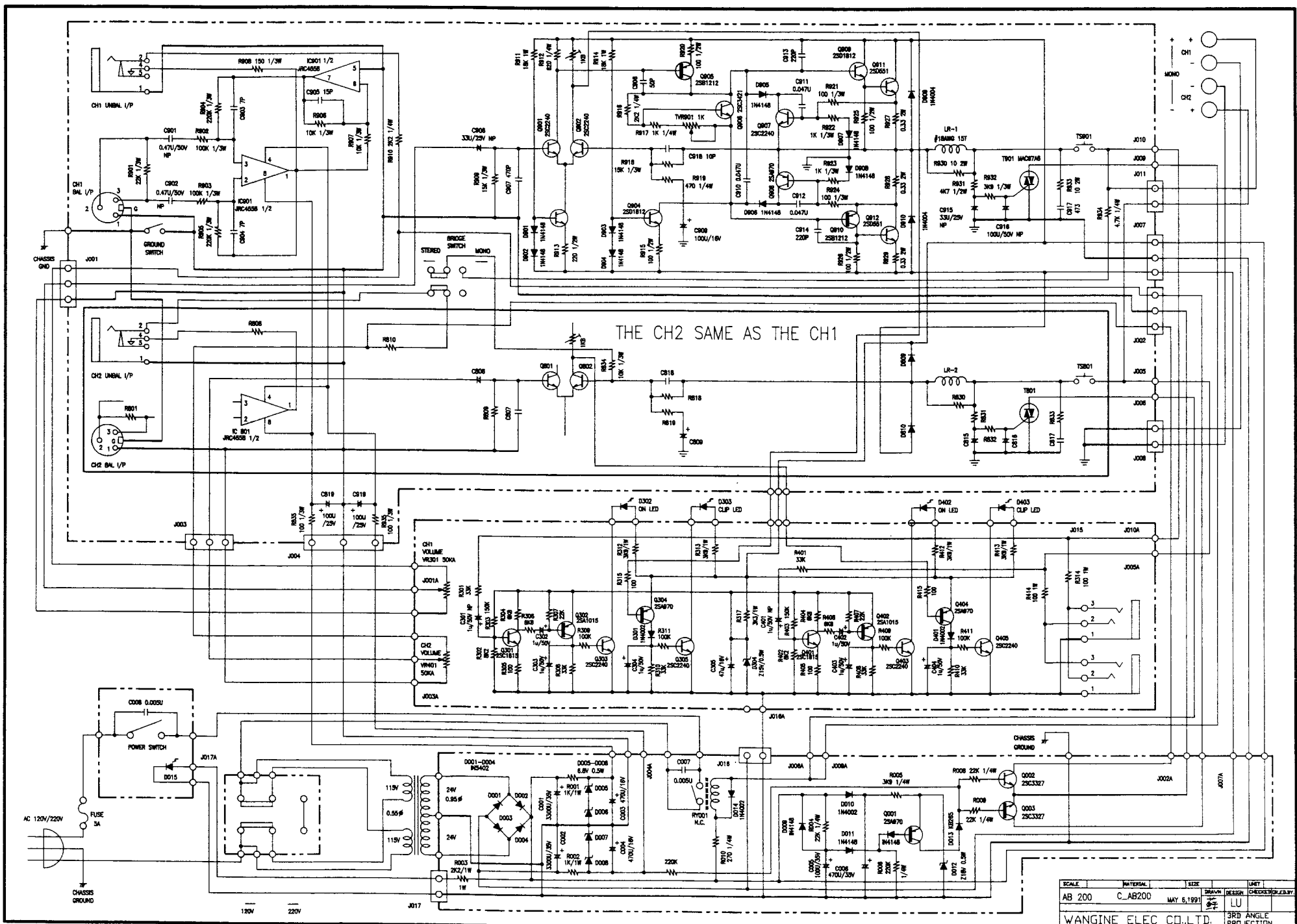

SCALE	MATERIAL	SIZE	DRAWN	DESIGN	UNIT	CHECKED	FOR
AB 200	C.AB200	MAY 5, 1991	LU	LU			
WANGINE ELEC. CO., LTD.							3RD ANGLE PROJECTION

GROUND SWITCH

BRIDGE SWITCH

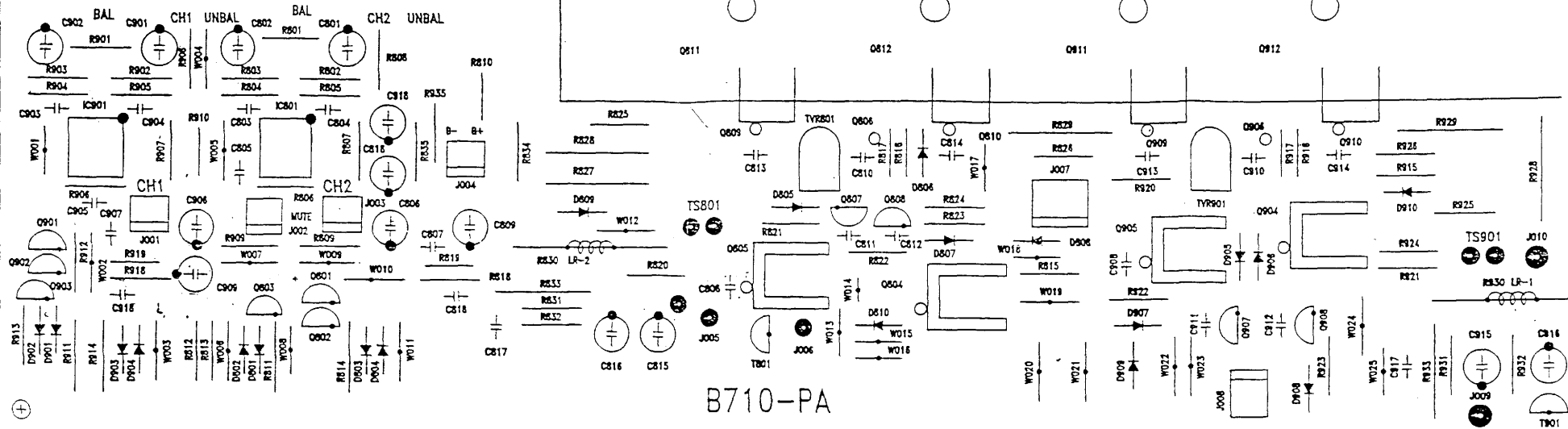

B710-PA

PCB B710-PA

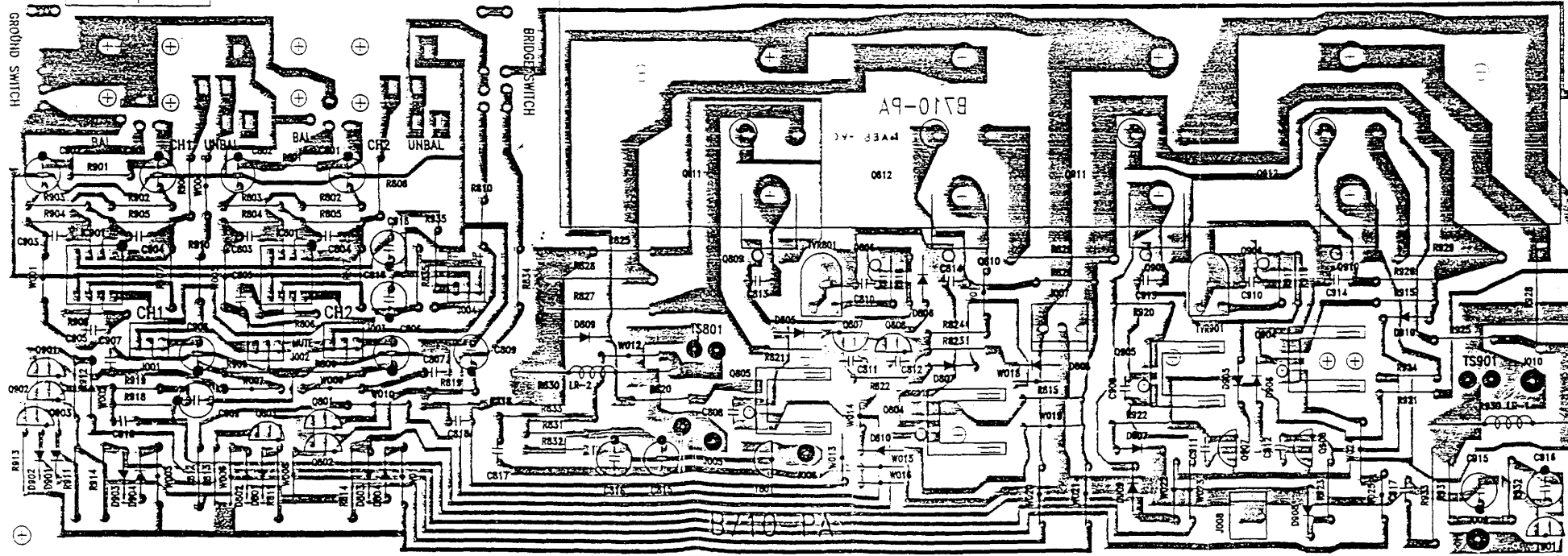

B710-PA

