

QUARTET

INTRODUCTION

The ARP Quartet is a compact, preset/variable synthesizer with four selectable voices—polyphonic brass, string, organ and piano. While the voices alone are realistic, combination of voices simultaneously chosen do not always maintain their individuality. The new sounds which appear add greatly to the flexibility of the Quartet.

Most of the circuitry in the Quartet is fairly simple. For that reason, the circuit descriptions have been kept succinct, dwelling only on areas that may prove new or confusing.

SCHEMATIC TERMINOLOGY

In the Quartet schematics, a Boolean mnemonic code is employed to identify logic control lines running between circuit boards. For example, where a Brass voice control line was identified, it was represented as mnemonic \boxed{B} . Everywhere a mnemonic \boxed{B} is shown it indicates a physical connection to all the other identical symbols. A connection is indicated only if the contents are identical in the different flags. That is, the symbol \boxed{B} is NOT connected to the symbol $\boxed{B \cdot TR}$.

In addition, the flags give an indication of the expected logic levels that will appear on that line. On the line bearing this flag, $\boxed{SO \cdot S}$, a logic 0 will appear whenever String voice AND Solo have been selected. (A plus sign indicates an OR function. An elevated decimal indicates an AND function.) Even the complex flag $\boxed{VB \cdot (B+SO \cdot S)}$ translates to "A Logic 1 will appear when the Vibrato switch and either Brass or the combination of the Solo and String switches are closed."

Using the Boolean mnemonic code makes it possible to follow control lines through the combinational logic to see how they are "assembled" for different voices. Let's take the example where, by design, the vibrato circuit is enabled when Brass or Solo Strings is selected.

The flag for Solo Strings is $\boxed{SO \cdot S}$, indicating a Logic 1 will appear if both String voice AND Solo switch have been selected.

The flag for Brass is \boxed{B} .

With the use of an OR gate, a new flag is created, $\boxed{B + SO \cdot S}$, indicating a Logic 1 will appear if Brass is selected OR String voice AND Solo switch are both selected. This new line is used to enable the vibrato circuit.

MNEMONIC CODE TABLE

Push Switches

Piano=P
Brass=B
Strings=S
Organ=O

Tab Switches

Trombone=TB
Trumpet=TR
Cello=C
Violin=V
Percussion=PZ
Solo=SO
Organ=OR
Celeste=CS
Piano=PI
Honky Tonk=H
Vibrato=VB

NOTE: Flags shown on the schematics are present when only one push switch is selected at a time. Troubleshooting should be done on one voice at a time.

The connector numbers also help in tracing paths through the Quartet. Connections are shown in this format:

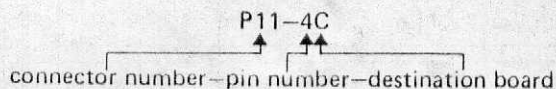

P11-4 will be connected to J11-4 on Board C.

For those who are unfamiliar with European schematics, grounds are shown as a connection to a single horizontal bar. A 5.6K resistor will be written as 5K6. Some capacitors are listed in NANOfarads. An 4n7 capacitor translates to a .0047 microfarad capacitor.

CIRCUIT DESCRIPTION

Board C

The ARP Quartet uses a master oscillator and top octave divider to generate the pitches for the 49 note keyboard. Located on Board C, the master oscillator sends a 2001MHz signal to an MK50242 divider. This generates the twelve pitches of the highest octave, which are routed to their respective TDA1008 programmable gated dividers, one for each note of the octave. Depending on the gate selected by the key contact, different levels of division (octaves) are

selected and sent to another set of internal dividers to be converted to separate 2', 4', 8', and 16' pitches of that note. In addition, the keying envelope is used to control the voltage level of the signals being fed to the final divider stage. This results in a very flexible keyboard gating system for convincing polyphonic voices. The 2', 8', and 16' pitches leave Board C and are sent to Board F.

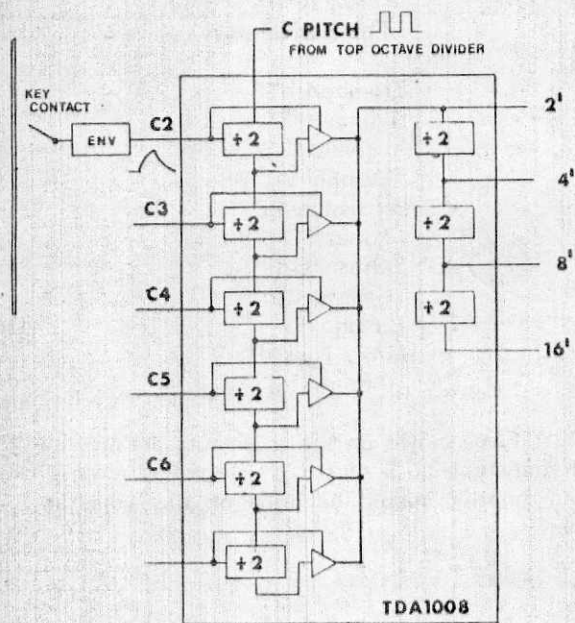

Board F

On Board F, ICf3 is a two pole VCF for the Brass voices. The String voices are sent to the three delay lines. Signals are shifted and clocked through the TDA1022 "bucket brigades" by their respective low and high frequency oscillators. Honky Tonk and Celeste voices are also routed to the delay lines but one delay line is disabled for these voices by the flag at J10-4B.

The strings squelch circuit shuts off the string signal when the input level to the delay lines is low enough to cause noise problems.

All the signals are sent to the Mix Preamp and then to the Output Stage (Tf10).

Board B

Logic levels to control channeling of the signals to the proper circuits, along with envelopes to control the Brass VCF and the delayed vibrato, and the Keyboard Gate signal for the keyboard buss rod are all generated on Board B.

Boards A, D, E

The Power Supply (Board A) and the Controls Switch Board (Boards D and E) are self explanatory.

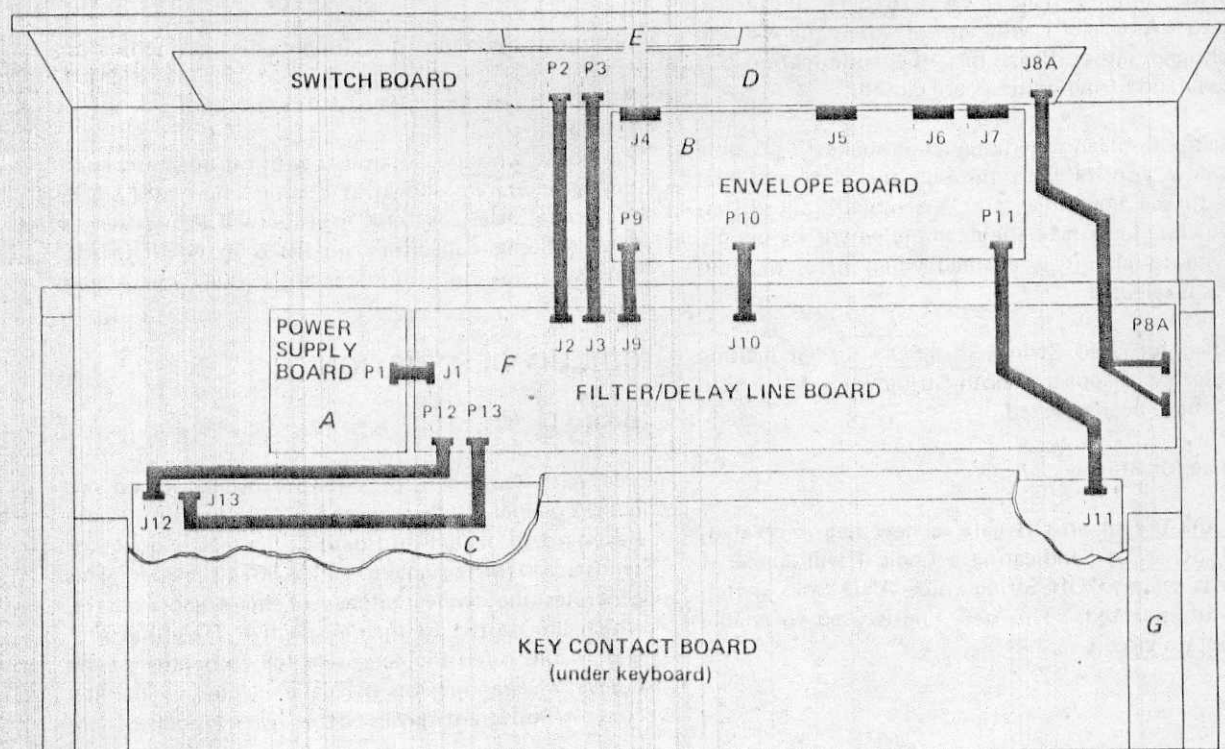

ARP INSTRUMENTS, INC.
SCHEMATIC, BOARD B
QUARTET

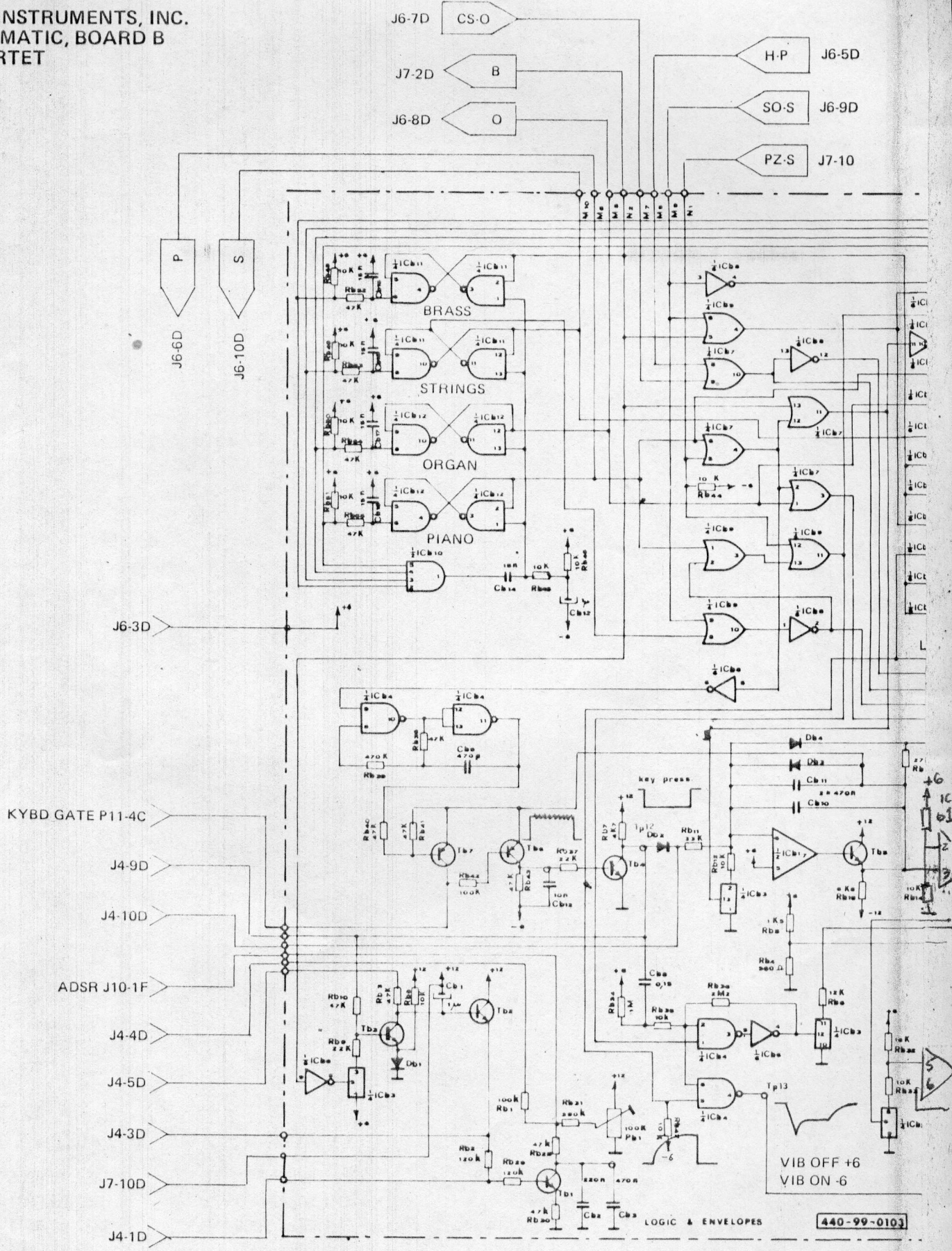

LOGIC & ENVELOPES

440-99-0103

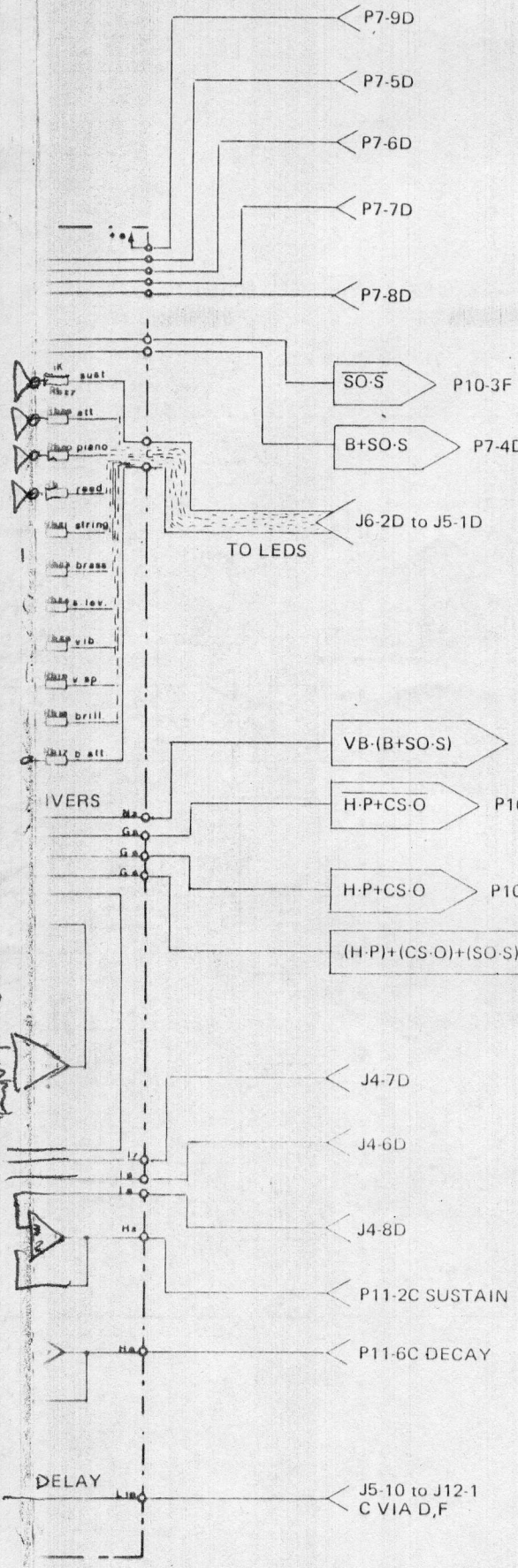

NOTES:

- All diodes are 1N 4148;
- All the logic signals are: 0 = -6V; 1 = +6V;
- All switches shown in off position;
- All resistors 1/4W unless otherwise indicated
- All electrolytic capacitors 16 V DC unless otherwise indicated.

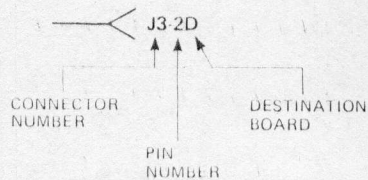

TOP VIEW
ALL TRANSISTORS

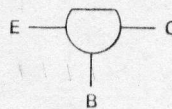

POSITION	TYPE	ARP PART NO.
ICb1-2	1458	367.99.7004
ICb3	4016	367.99.6004
ICb4-11-12	4011	367.99.6002
ICb5-6	4049	367.99.6012
ICb7-9	4071	367.99.6022
ICb8	4069	367.99.6005
ICb10	4082	367.99.6023
Tb1.5	BC 173	364.99.0003
Tb6-7	BC 416	364.99.0004

ARP INSTRUMENTS, INC.
SCHEMATIC, BOARD C
QUARTET

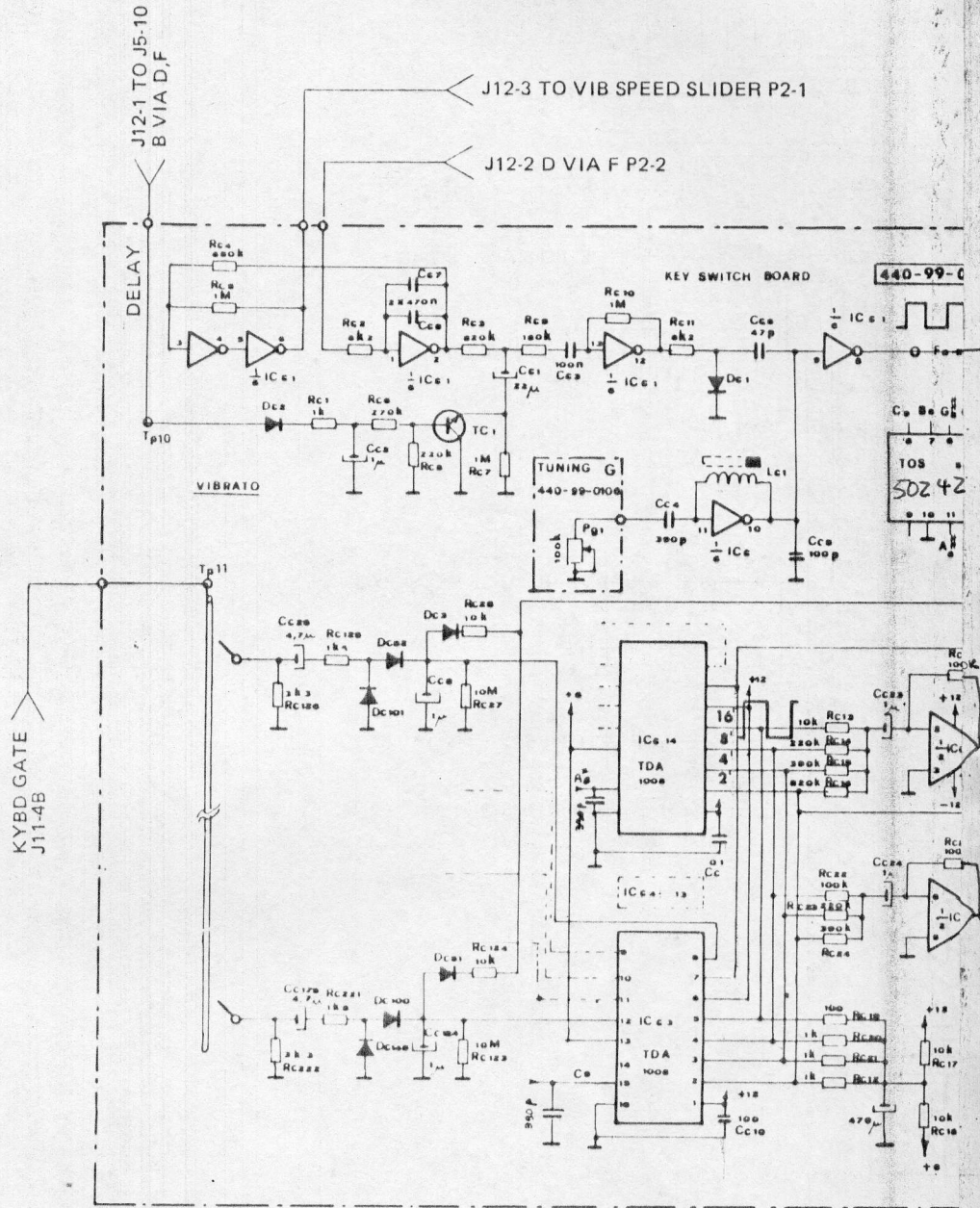

NOTES:

- All diodes are 1N 4148;
- All the logic signals are: 0 = -6V; 1 = +6V;
- All switches shown in off position;
- All resistors 1/4W unless otherwise indicated
- All electrolytic capacitors 16 V DC unless otherwise indicated.

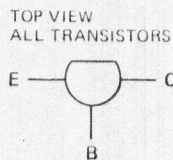
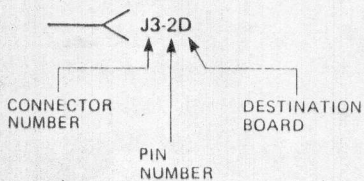

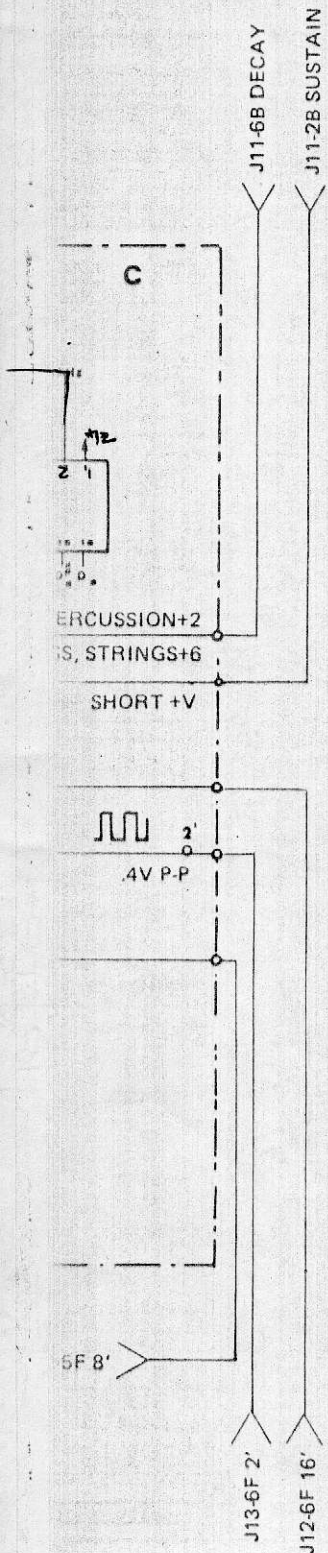

POSITION

ICc1
 ICc2
 ICc3 - 14
 ICc15
 Tc1

TYPE

4069
 50242
 TDA 1008
 1458
 BC173 selected

ARP PART NO.

367.99.6005
 367.99.5001
 367.99.5011
 367.99.7004
 364.99.0007

ARP INSTRUMENTS, INC. SCHEMATIC, BOARD A QUARTET

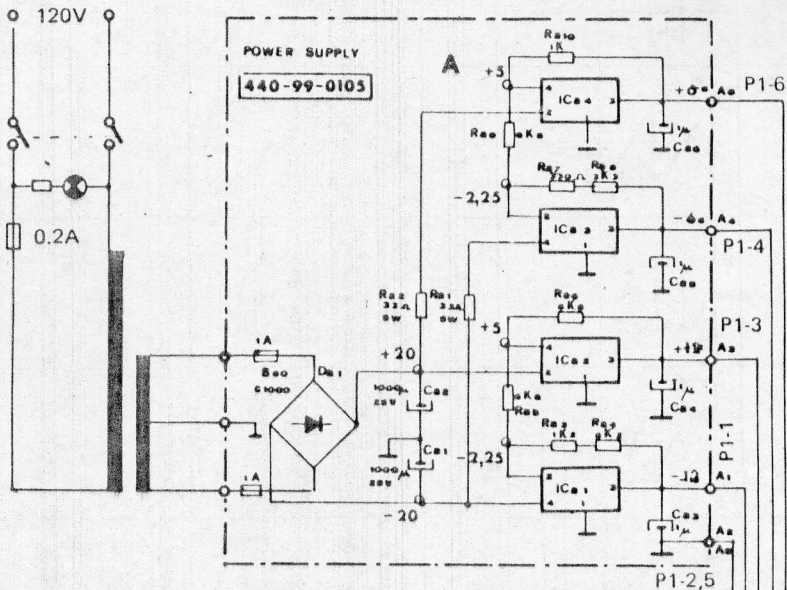

TOP VIEW
ALL TRANSISTORS

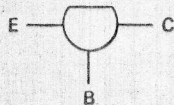

NOTES:

- All diodes are 1N 4148;
- All the logic signals are: 0 = -6V; 1 = +6V;
- All switches shown in off position;
- All resistors 1/4W unless otherwise indicated
- All electrolytic capacitors 16 V DC unless otherwise indicated.

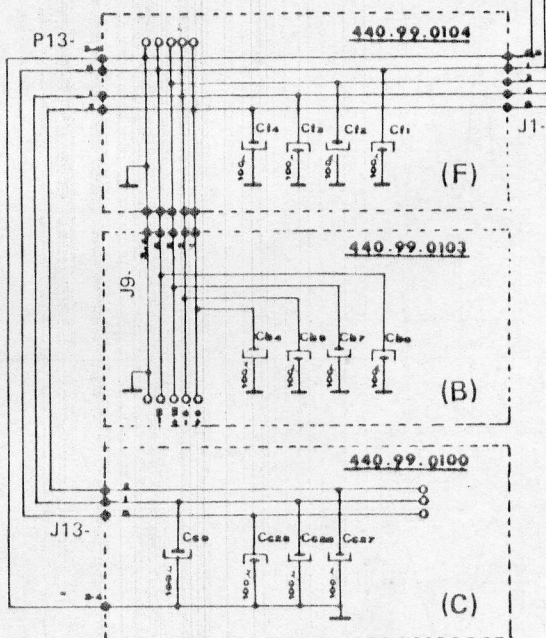
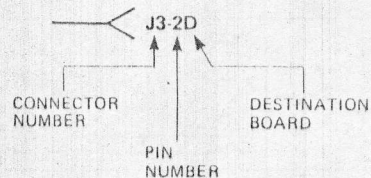

POSITION

TYPE

ARP PART NO.

ICa1-3

uA 79 MG

367.99.8003

ICa2-4

uA 78 MG

367.99.8002

TEST POINTS

TP	INSTRUMENT INSERTED	CONDITION	WAVEFORMS
01	Trombone	- Brilliance max - Mute off - $f = 440$ Hz	
01	Trumpet	Brilliance max Mute off - $f = 880$ Hz	
X1	Cello	- Percuss. off - $f = 440$ Hz	
X1	Violin	Percuss. off $f = 880$ Hz	
01	ORGAN	Attack min. $f = 880$ Hz	
X1	CELESTE	Attack min. $f = 880$ Hz	
01	Piano	Sustain max $f = 440$ Hz	
X1	Honky Tonk	Sustain max $f = 440$ Hz	
Tp1	Violin or Cello		
Tp2	Violin or Cello		
Tp1	Honky Tonk or CELESTE		
Tp2	Honky Tonk or CELESTE		

TP	INSTRUMENT INSERTED	CONDITION	WAVEFORMS
Tp3			
Tp4		Tp1 To ground	
Tp5		Tp2 To ground	
Tp6		Tp3 To ground	
Tp7	Violin	Perc off	
Tp8		Solo off	
Tp9		$f = 440$ Hz	
Tp10	Trumpet	- Vibrato on - Any Key pressed	
Tp11	Piano		
Tp11	Violin	- Attack min - Any key, pressed	
Tp12	Trumpet		
Tp13	Trumpet	- Brass Attack 1/2 - Brilliance max - Mute off	
Tp14	Trumpet	- Brass Attack 1/2 - Brilliance max - Mute off	
ADJUST			
Tp1	CELESTE		Adjust P11 for $V_1 = 2 V_{pp}$
Tp14	Trumpet		Adjust P11 for $V_2 = -7V$
Fo	Set ext Tuning 1/2		Pitch the coil Lc1 for fo = 2,001 MHz

**ARP INSTRUMENTS, INC.
SCHEMATICS, BOARDS D & E
QUARTET**

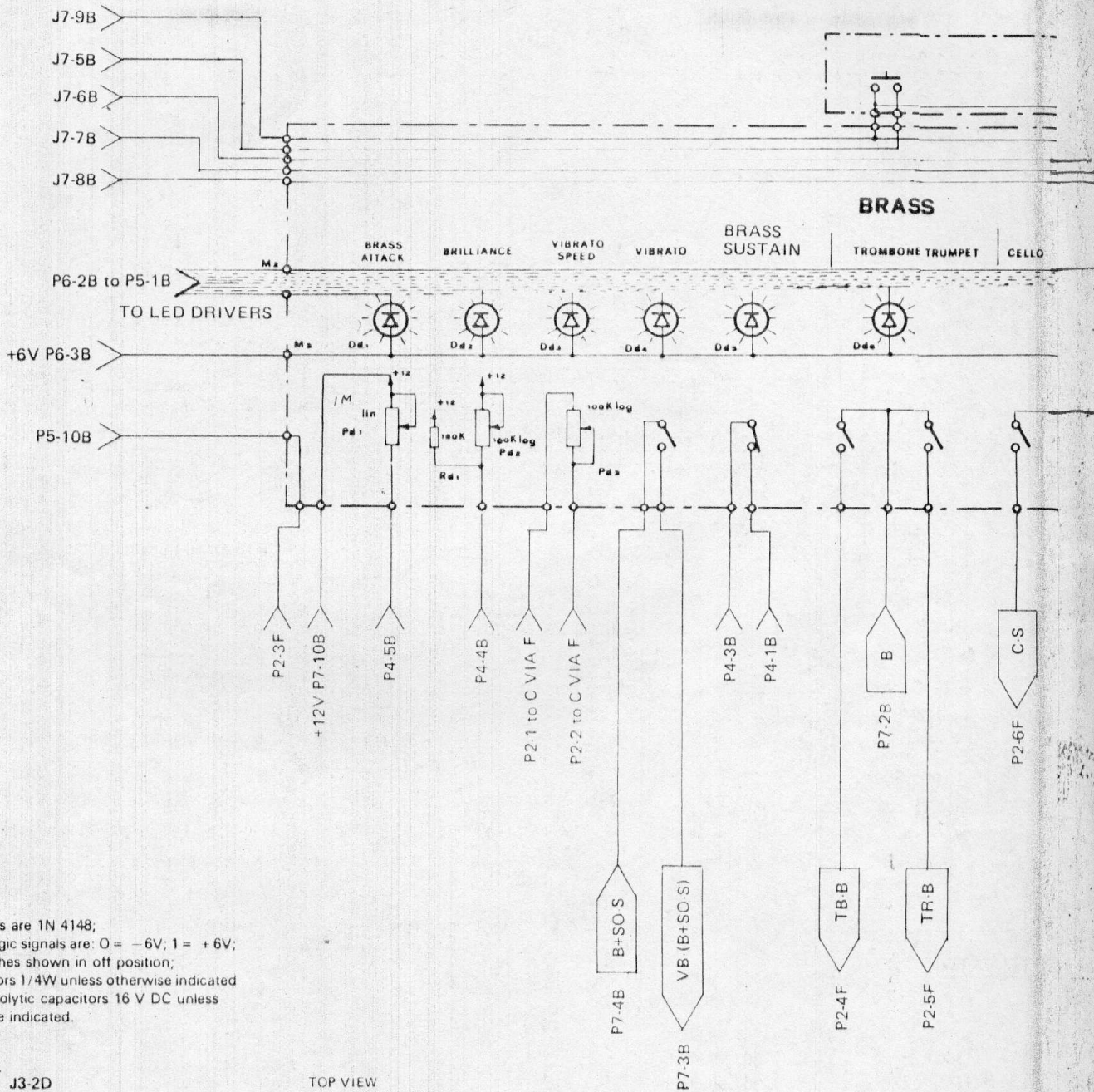

NOTES:

- All diodes are 1N 4148;
- All the logic signals are: 0 = -6V; 1 = +6V;
- All switches shown in off position;
- All resistors 1/4W unless otherwise indicated
- All electrolytic capacitors 16 V DC unless otherwise indicated.

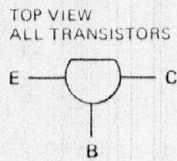
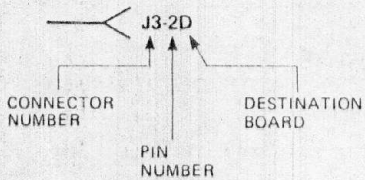

PRESETS-SWITCHBOARD

440-99-0102

E

CONTROLS SWITCH BOARD

440-99-0101

D

STRINGS

ORGAN

PIANO

PERCUSSION

SOLO

ORGAN CELESTE

PIANO

HONKY TONK

ATTACK

SUSTAIN

VOLUME



D4a

D4b

D410

D411

D412

Rel
1K

S

P6-9B
P3-2F
SO-S

O

P6-8B
P6-7B
P3-4F
OR-O
CS-O

P1-P

P6-5B
P3-6F
H-P

P6-6B
P

1M
P4a

10K log
P4a

10K log
P4a

P4-10B

P4-9B

P4-7B

P4-6B

P4-5B

P8-10F

P8-5F

P8-6F

P8-1

SUSTAIN
FOOTSWITCH



Handwritten: P3-1F

J10-6B

(H-P)+(CS-O)

J10-5B

(H-P)+(CS-O)

J2-3D

J2-1D

J2-2D

J3-4D

CS-O

J3-1D

V-S

J2-6D

C-S

J3-6D

H-P

P12-1C

P12-2C

P12-3C

J10-1B

ADSR

J2-4D

TB-B

J2-5D

TR-B

P12-6C

P13-6C

P12-5C

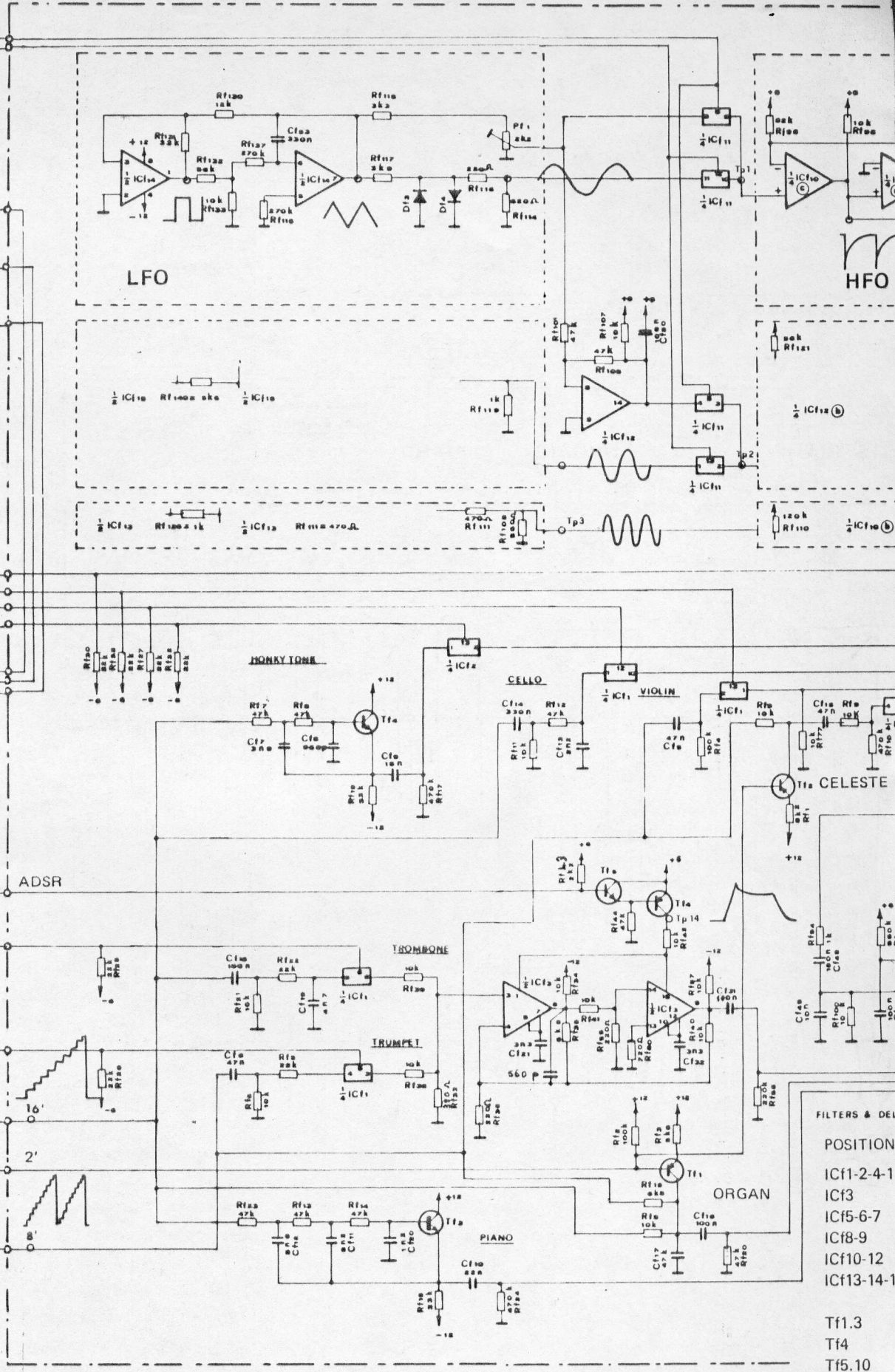

- FILTERS & DELAY POSITION
- IC1-2-4-11
 - IC3
 - IC5-6-7
 - IC8-9
 - IC10-12
 - IC13-14-15

- Tf1.3
- Tf4
- Tf5.10

ARP INSTRUMENTS, INC. SCHEMATIC, BOARD F QUARTET

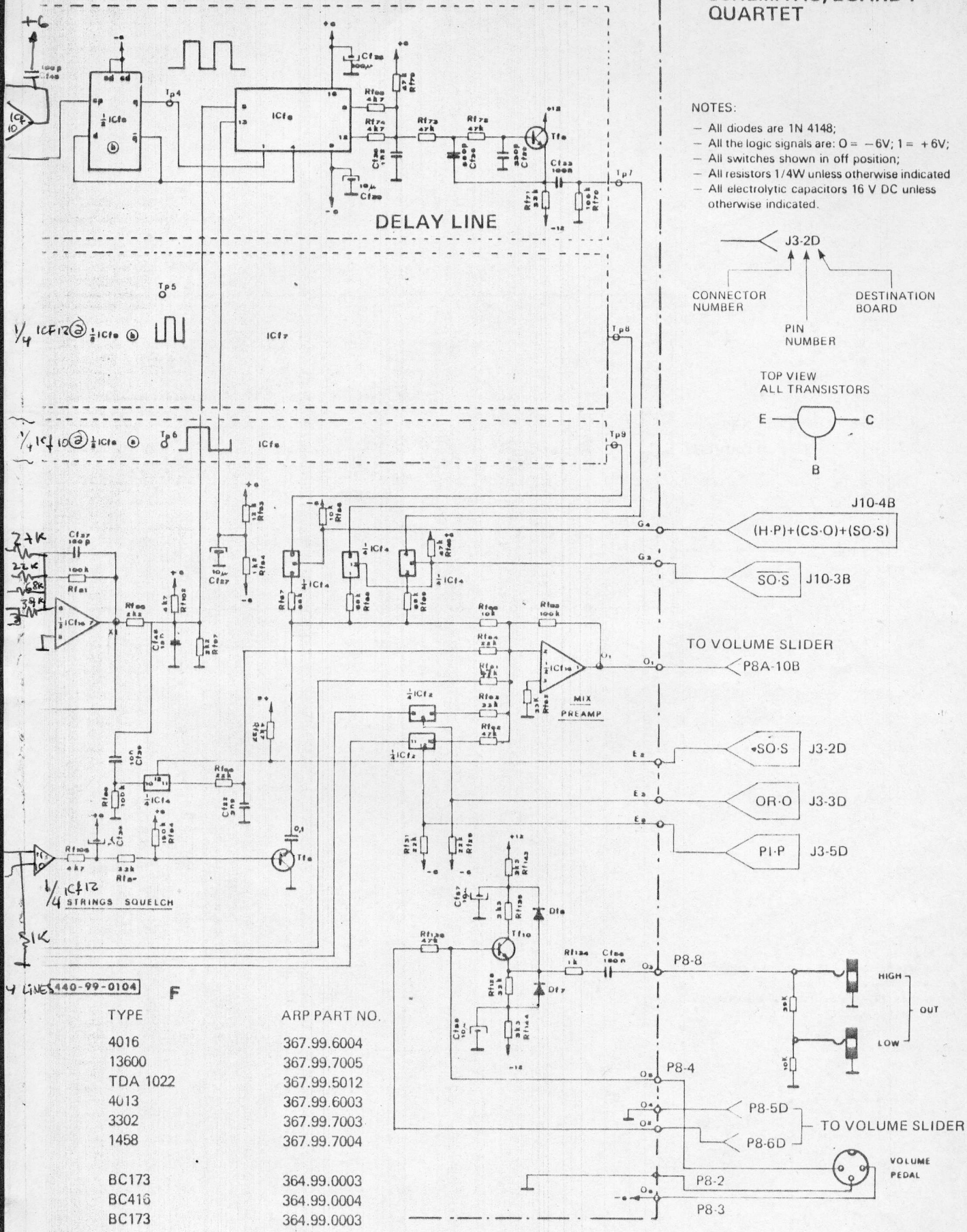

NOTES:

- All diodes are 1N 4148;
- All the logic signals are: 0 = -6V; 1 = +6V;
- All switches shown in off position;
- All resistors 1/4W unless otherwise indicated
- All electrolytic capacitors 16 V DC unless otherwise indicated.

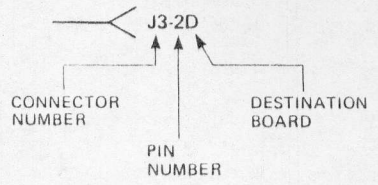

TOP VIEW
ALL TRANSISTORS

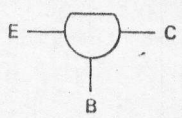

4 LINES 440-99-0104 F

TYPE	ARP PART NO.
4016	367.99.6004
13600	367.99.7005
TDA 1022	367.99.5012
4013	367.99.6003
3302	367.99.7003
1458	367.99.7004
BC173	364.99.0003
BC416	364.99.0004
BC173	364.99.0003

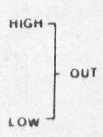

TO VOLUME SLIDER

VOLUME PEDAL

ARP INSTRUMENTS, INC.
ASSEMBLY, BOARDS B, D, & E
QUARTET

CONTROLS SWITCHBOARD **D**

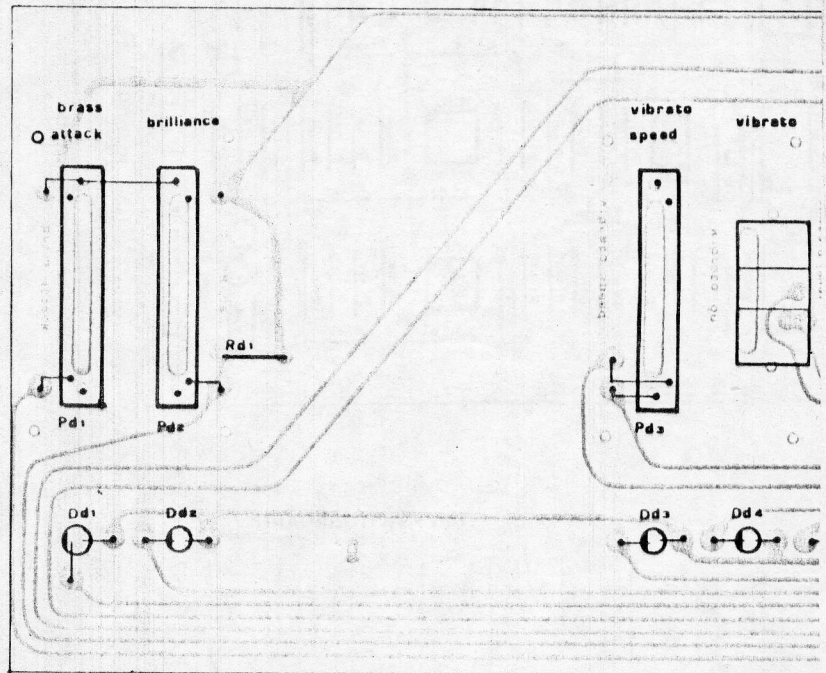

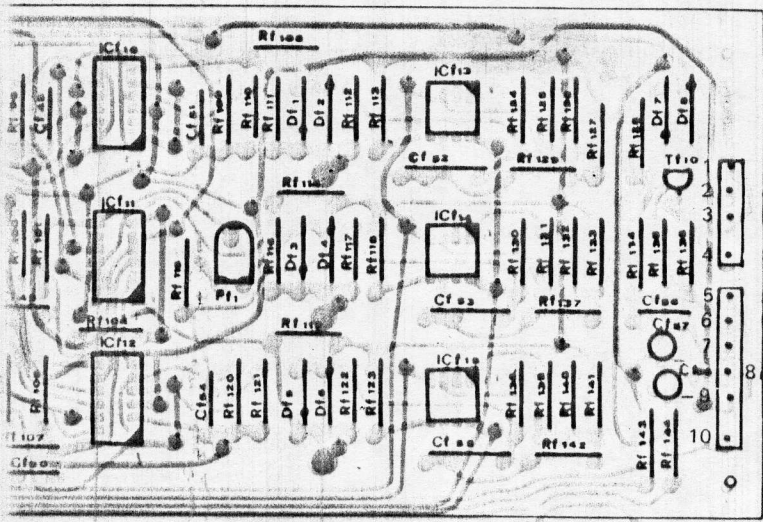

P8

KEYSWITCHBOARD (C)

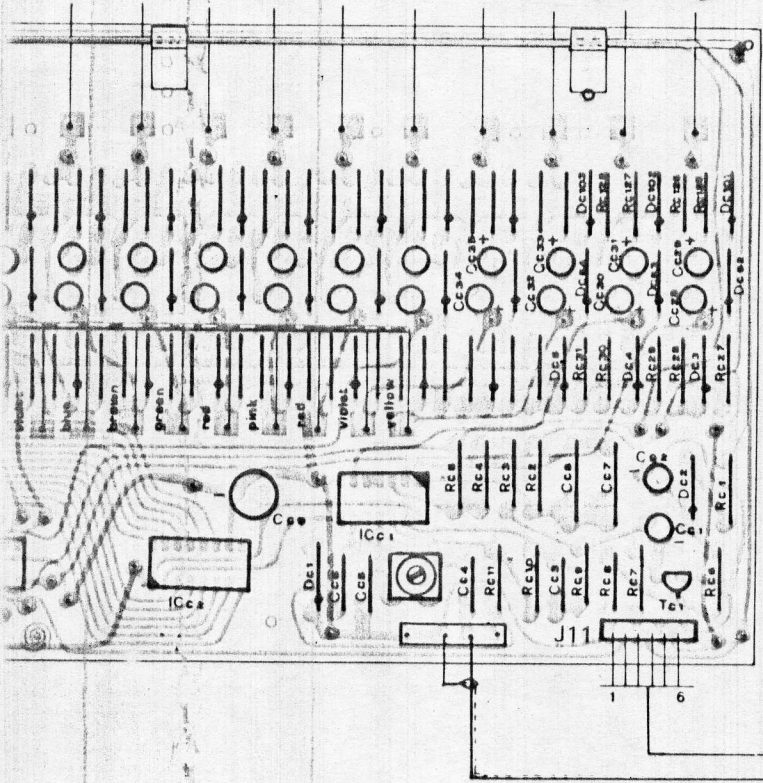

TUNING (G)

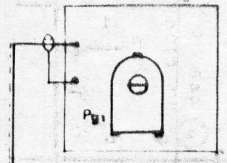

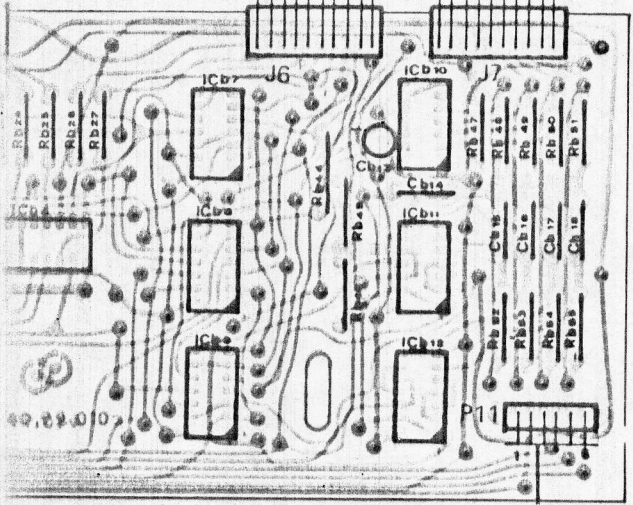
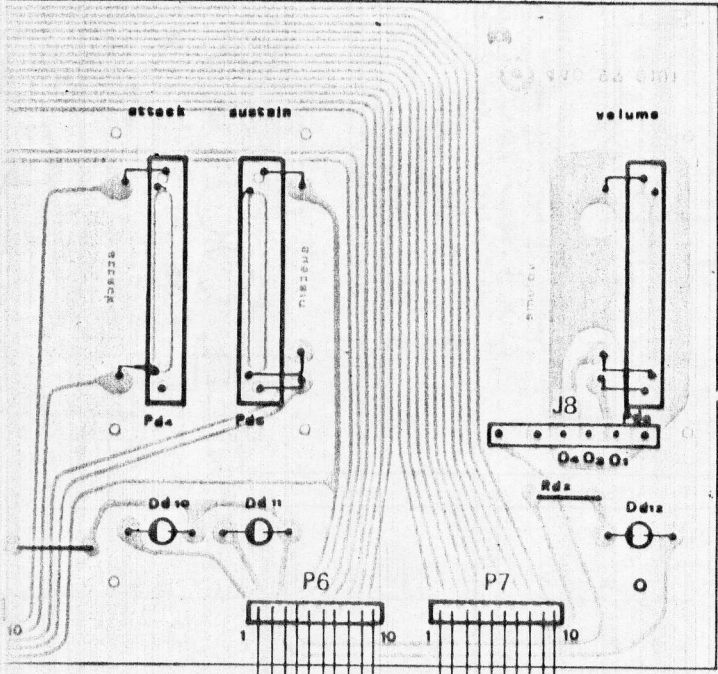

LOGIC
ENVELOPES

(B)

POWER SUPPLY **A**

FILTERS, DELAY-LINES **(1)**

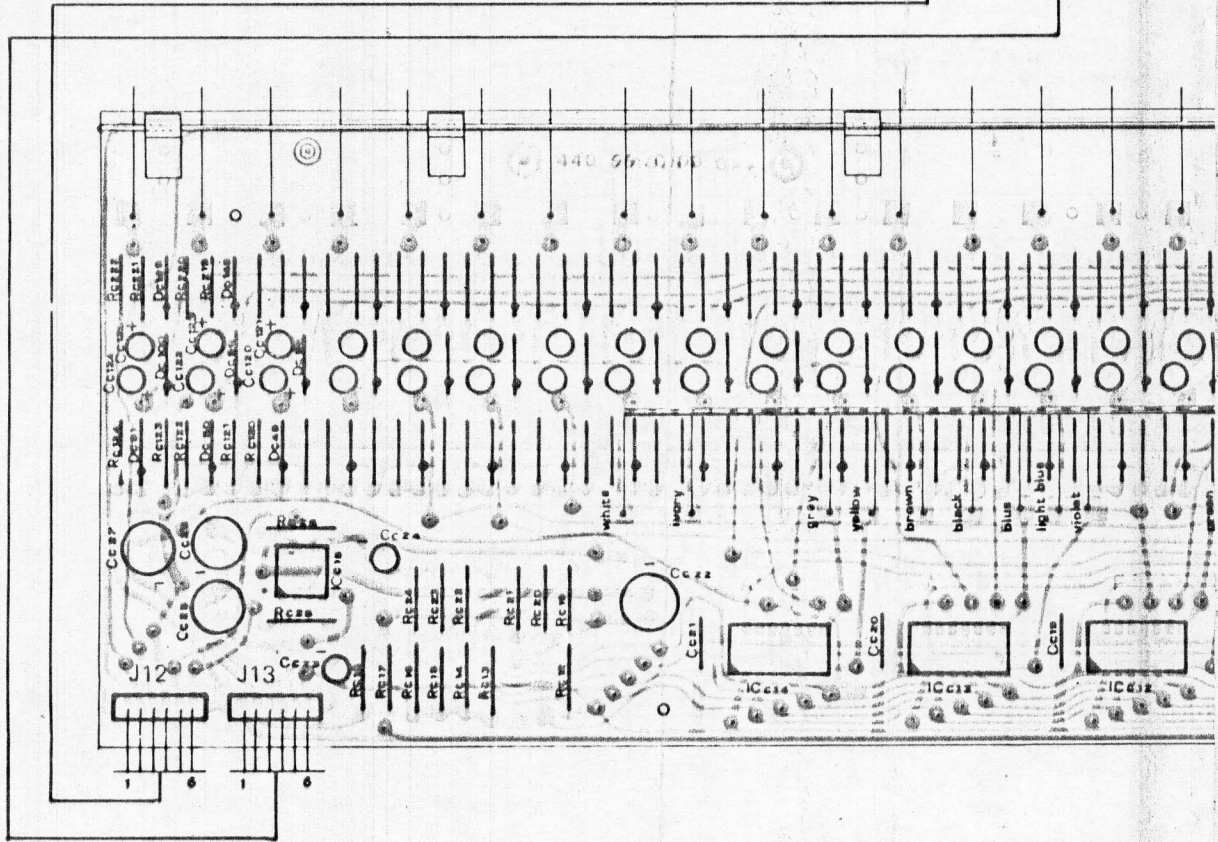
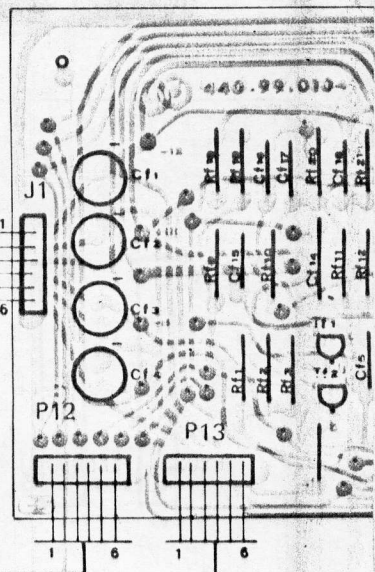
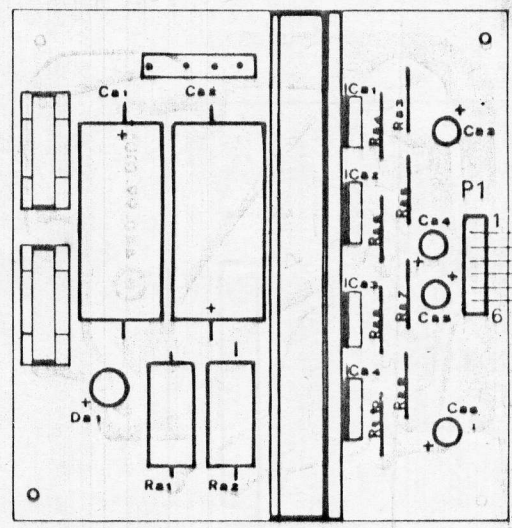

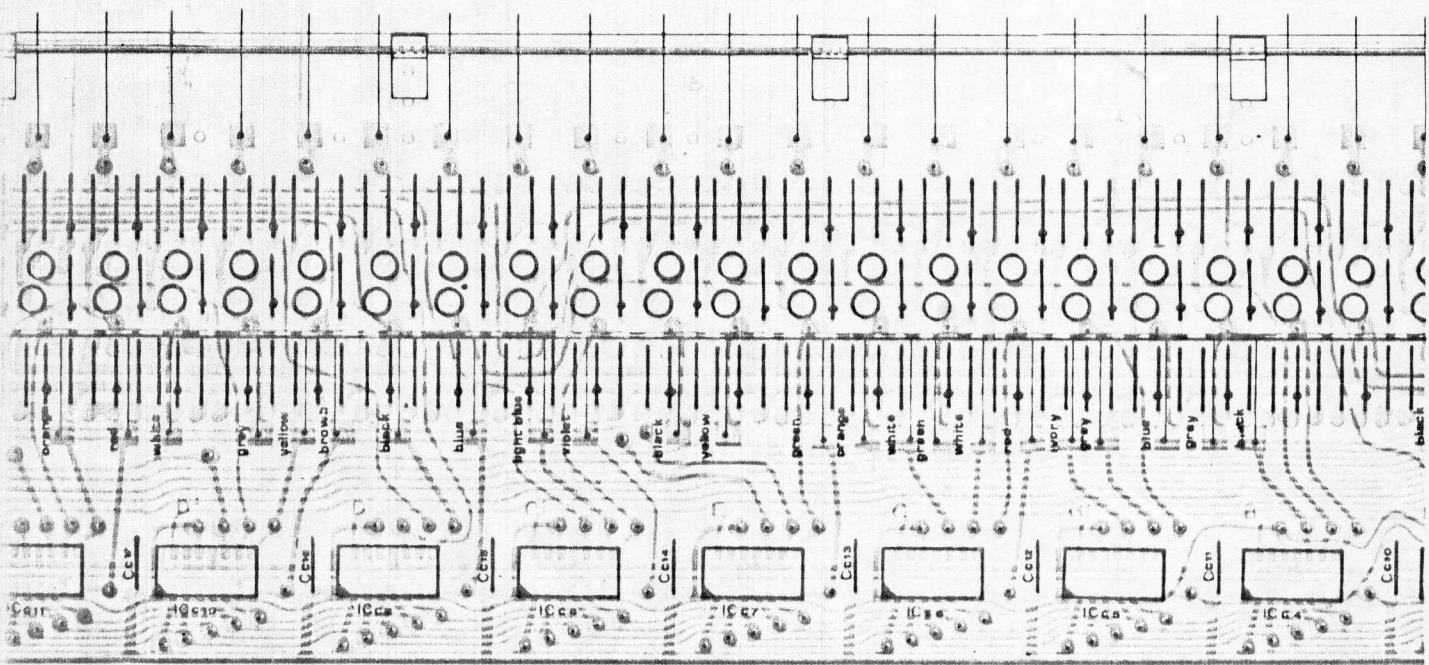
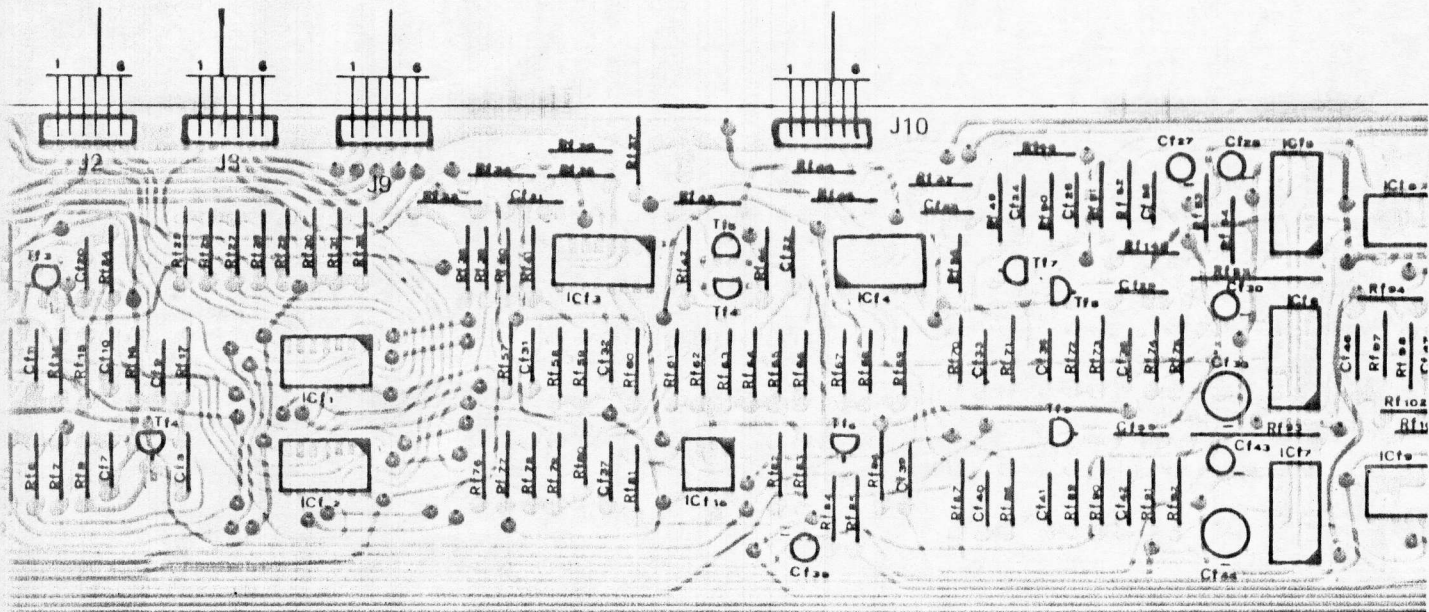

PRESETS SWITCHBOARD

(E)

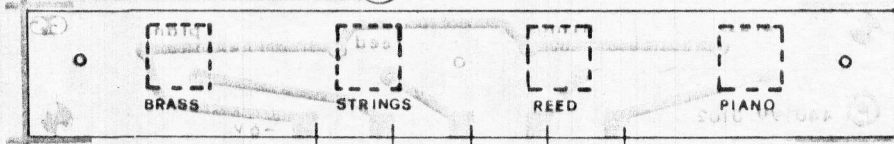

trombone trumpet

cello violin percussion solo

ORGAN CELESTE

piano honky tonk

