

# SERVICE MANUAL

# ADCOM<sup>®</sup>

# POWER AMPLIFIER

# GFA-565

## TABLE OF CONTENTS

Introduction .....	1
Service Parts List .....	3
Audio Input/Driver PCB .....	10
AC Input/Bias Time Delay PCB .....	10
Left Output PCBs.....	11
Right Output PCBs .....	12
Filter Capacitor PCBs .....	13
Options PCBs .....	13
Performance Data.....	14
Specifications .....	16
Schematic Diagram .....	18

**ADCOM<sup>®</sup>**

**TECHNICAL SERVICE DEPARTMENT**

**11 ELKINS ROAD**

**EAST BRUNSWICK, NJ 08816**

**TELEPHONE (908) 390-1130**

**FAX (908) 390-9152**



# INTRODUCTION

This service manual is intended to assist trained and qualified technical personnel in verifying the performance of, adjusting, and repairing the ADCOM GFA-565 power amplifier. The procedures described here are not intended for persons unfamiliar with the appropriate safety and test procedures.

## **WARNING**

THERE ARE POTENTIALLY LETHAL VOLTAGES WITHIN THE GFA-565 AMPLIFIER WHICH WILL BE ACCESSIBLE ONCE ITS TOP COVER IS REMOVED. **DO NOT ATTEMPT FAMILIARIZATION, INSPECTION OR ANY PROCEDURE WHATSOEVER UNLESS YOU HAVE DISCONNECTED THE GFA-565 FROM THE WALL AC OUTLET OR OTHER SOURCE OF AC POWER AND THE POWER-SUPPLY CAPACITORS ARE COMPLETELY DISCHARGED.** PLEASE TAKE NOTE THAT THE POWER-SUPPLY CAPACITORS TAKE AS LONG AS 5 MINUTES TO DISCHARGE. THESE INSTRUCTIONS ARE PROVIDED FOR USE ONLY BY COMPETENT TECHNICAL PERSONNEL. **DO NOT UNDERTAKE ANY SERVICE PROCEDURES IN THE GFA-565 UNLESS YOU ARE TECHNICALLY QUALIFIED TO DO SO.**

## CIRCUIT DESCRIPTION

The ADCOM GFA-565 is a monaural power amplifier rated at <0.02% THD from 20Hz to 20kHz with 300 watts into 8 ohms, 450 watts into 4 ohms, and 850 watts into 2 ohms. The output stage is capable of greater than 60 amps into low-impedance loads. The amplifier employs a discrete dual-differential cascode Class-A front-end followed by a dual cascode Class-A voltage gain stage which amplifies the input signal to the voltage required at the output of the amplifier. This high-voltage signal drives the high-current triple-Darlington-follower output stage which amplifies the current by a factor of about 50,000.

Referring to the accompanying schematic, the input signal passes through network C101, C102, R102, and R103 which provides a 3dB bandwidth of 0.7Hz to 700kHz to the input of the amplifier. C101 is an extremely high quality capacitor and serves to protect the amplifier and the speakers connected to it from DC faults at the output of the preamplifier. **WE DO NOT RECOMMEND THAT C101 BE SHORTED OUT.** Q101, Q103, Q105, and Q107 form one differential/cascode input stage and Q102, Q104, Q106, and Q108 form the other. R108, R109, R112, and R113 provide local feedback to control the input-stage open-loop gain. Open-loop gain is defined by R106, R110, and C103 on one side, and R107, R111, and C104 on the other. The next voltage-gain stage consists of Q109 and Q111 on one side and Q110 and Q112 on the other. DC bias is set by R125, D103 through D108, R131, R132, and R126. Open-loop gain is defined by R125, R126, R133, and R134, with R135 through R138, C110, and C111 providing high-frequency compensation.

Feedback is provided from the output to the bases of Q105 and Q106 by the network R119, R120, and C105. C105 provides a high-frequency rolloff above 80kHz. D101, D102, D109 through D112, Q113, Q114, R122 through R124, and C106 provide an anti-saturation feedback path to the input stage. For example, when the cascode voltage gain stage approaches saturation to the positive supply, D101 begins to conduct, turning Q113 on. Current flows through D803, the INSTANTANEOUS DISTORTION ALERT LED, through D112 and R123. When the error voltage across D109/D110 becomes great enough, D109 begins to conduct, forcing the input stage to reduce the drive to the voltage-gain stage.

The input stage is biased by R144 through R154, Q115 through Q119, Q501, D113 through D115, and D804. Q501 is turned on by the amplifier bias delay circuitry on the AC input power supply board. A current of about 2mA flows through the thermal breakers on the heatsinks and into the emitter of Q119. If the heatsinks overheat, the breakers open and the current flows through D804, the THERMAL PROTECTION LED, instead. When Q119 is carrying the current, D115 is biased at 2.5V. This creates about 1.8V across R149, Q118 then sources about 3mA through D114, which develops about 2.2V across it. About 1.6V is developed across R144 and R146. Q117 conducts about 1.3mA through D113 and Q115 conducts about 3mA to the PNP differential input stage. D113 develops about 2.2V across it, causing about 1.6V across R145. Q116 conducts about 3mA to the NPN differential input stage. If the negative 80V supply fails or its fuse opens, Q119 turns off, turning off all the amplifier bias circuitry. If the positive 80V supply fails or its fuse opens, again Q119 turns off and the bias circuitry is disabled. Using LEDs for the bias circuitry causes rough temperature compensation of the amplifier Class-A DC bias current.

Any DC imbalance in the amplifier is corrected by R117, R118, C107, C108, and IC101. Any DC error at the amplifier output is servoed back through IC101 to adjust the DC current through the input transistors. DC bias is nominally 1.5mA through Q101, Q102, Q105, and Q106. IC101 can modify this by up to 0.3mA to bring the amplifier into balance.

The bias network of R139 through R143, Q201 and Q301 forms a temperature-compensated DC-bias voltage to the input of the triple-Darlington-follower output stage. Mid- and high-frequency bypassing is provided by C109.

R158 and C111 provide a load for the amplifier at high frequencies, stabilizing the amplifier under varying load conditions. D201 and D301 provide a high-current return to the power supply for backlash current from the load.

The output stage consists of two sets of 10 parallel transistors operated as emitter followers, driven by another pair of emitter followers. This configuration minimizes distortion caused by varying load impedances. The output transistors have 0.33-ohm ballast resistors for current sharing and bias stability.

The AC input power supply board includes a power-on delay relay to reduce the turn-on current surge in the AC power line, jumpers to set the supply voltage range, and an amplifier bias delay.

## CAUTION

**DO NOT** use any type of variable AC supply, such as a variac, to slowly turn on the GFA-565 without first shorting R506 (4.7 ohm/20 watt). R506 is an integral part of the turn-on, inrush-suppression circuit and failure to comply will **burn out** R506.

## TEST PROCEDURES

All tests are performed with a 120V, low-distortion (less than 2% THD), AC-power source, 8-ohm resistive load (except slew rate), and a signal source of not more than 600 ohms.

Tests are performed after warming up the amplifier at 100 watts into an 8-ohm load for at least 10 minutes.

All grounds during testing are referred to the ground of the black output terminal.

80kHz low-pass filter is employed during THD distortion measurements.

Signal-to-noise measurements are "A" weighted.

Damping factor is measured by comparing the 20-watt-output voltage with and without an 8-ohm load.

Slew rate is measured with an inductive load, and is derived with a dual-time-based oscilloscope reading the slope of a full-power (135V peak-to-peak) 5kHz square wave. To avoid damaging output network R158 and C121, **DO NOT OPERATE THE AMPLIFIER AT FULL-POWER SINE WAVE ABOVE 22kHz OR FULL-POWER (135V PEAK-TO-PEAK) SQUARE WAVE ABOVE 5kHz.**

## IMPORTANT

BEFORE PROCEEDING WITH ADJUSTMENTS, MAKE SURE AMPLIFIER IS AT ROOM TEMPERATURE.

## BIAS ALIGNMENT

1. With set-up as per the first paragraph of TEST PROCEDURES and with **NO SIGNAL IN**, set bias control (R143) to midpoint.
2. Connect a millivolt meter across TP201 and TP301.
3. Turn amplifier on and allow a 3 to 5 minute settling period.
4. Adjust BIAS control to obtain either a + or - 24mV ( $\pm 1$ mV) indication on the millivolt meter.
5. To check for proper bias setting, remove millivolt meter and apply input signal to obtain 100 watts into 8 ohms for 10 minutes with cover on.
6. Remove input signal and connect the millivolt meter as in Step 2. Let amplifier idle until bias stabilizes and readjust to 24mV ( $\pm 1$ mV).

# ADCOM GFA-565 SERVICE PARTS LIST

## 1. AUDIO INPUT/DRIVER PCB ASSEMBLY

### INTEGRATED CIRCUITS:

IC101 ADCOM 2A

### TRANSISTORS:

Q104, Q108, Q115, Q117	2SA1376 (K)	
Q111	2SA1210	
Q109	2SA1015	
Q113, Q119	2SA970	
Q103, Q107, Q116, Q118	2SC3478 (K)	
Q112	2SC2912	
Q114	2SC2240	
Q110	2SC1815	
Q101, Q105	MPS-A13	} ——— ADCOM MATCHED PAIRS
Q102, Q106	MPS-A63	

### DIODES, ZENER:

D116, D117, D118, D119	ADCOM J2
D115	ADCOM J6

### DIODES:

D101, D102	1SS82
D103, D104, D109, D110, D111, D112	1SS178

### DIODES, VARISTOR:

D107, D108	KB262
D105, D106	KB362

### LEDs:

D113, D114	SLP246B
------------	---------

### CAPACITORS, ELECTROLYTIC:

C114, C115	100V/100uF
C109, C118, C119	25V/220uF

### CAPACITORS, FILM:

C103, C104	50V/3900pF	PANASONIC ECQB1H332JF
C107, C108, C120	50V/0.1uF	PANASONIC ECQV1H104J2
C121	100V/0.047uF	UMS
C112, C113, C116, C117	100V/1uF	PANASONIC ECQE1105KF
C101	100V/4.7uF	ROEDERSTEIN MKC1862
		ELECTRONIC CONCEPTS
		5MC22B505K

### CAPACITORS, MICA:

C105, C106	100V/82pF	Z-05
C102, C110, C111	100V/220pF	Z-08

### RESISTORS, VARIABLE:

R143	41-7122-0	PK502H101H0
------	-----------	-------------

### RESISTORS, CEMENTED WIRE-WOUND:

R158	3W/6.8ohms	RGCW3
------	------------	-------

### RESISTORS, OXIDE METAL-FILM, 5%:

R155, R156	27kohms	RS1/2FS
R151, 152	39kohms	RS1/2FS

**RESISTORS, METAL-FILM, 1%:**

R110, R111, R137, R138	1/4W/10ohms	RN14K2E
R108, R109, R112, R113	1/4W/33.2ohms	RN14K2E
R125, R126	1/4W/49.9ohms	RN14K2E
R141	1/4W/82.5ohms	RN14K2E
R142	1/4W/147ohms	RN14K2E
R139	1/4W/280ohms	RN14K2E
R140	1/4W/365ohms	RN14K2E
R114, R145	1/4W/499ohms	RN14K2E
R149	1/4W/825ohms	RN14K2E
R103, R106, R107, R116, R119, R122, R127, R128	1/4W/1kohms	RN14K2E
R146, R153, R154	1/4W/1.21kohms	RN14K2E
R147, R148, R150	1/4W/4.75kohms	RN14K2E
R123	1/4W/6.81kohms	RN14K2E
R120, R124, R129, R130, R133, R134	1/4W/22.1kohms	RN14K2E
R104, R105, R114, R115	1/4W/33.2kohms	RN14K2E
R131, R132	1/4W/39.2kohms	RN14K2E
R102	1/4W/49.9kohms	RN14K2E
R101, R117, R118	1/4W/1Mohms	RN14K2E

**RESISTORS, FUSIBLE, 5%:**

R121, R157	1/4W/10ohms	RFC1/4
R135, R136	1/4W/82ohms	RFC1/4

**THERMOSTAT:**

S101, S102	△ 81-7014	UP62, 85°C
------------	-----------	------------

**2. LEFT OUTPUT PCB ASSEMBLIES****TRANSISTORS:**

Q201	2SA1376 (K)
Q202	2SC3298B
Q203	2SC3907
Q204 THROUGH Q213	2SD424

**DIODES:**

D201	EGP50D
------	--------

**CAPACITORS, FILM:**

C201	50V/0.1uF	PANASONIC ECQV1H104J2
C202	50V/1uF	PANASONIC ECQV1F105J2

**CAPACITORS, ELECTROLYTIC:**

C203	100V/47uF	PANASONIC ECEA2AGE470
------	-----------	-----------------------

**RESISTORS, FUSIBLE, 5%:**

R203, R205, R207, R209, R211, R213, R215, R217, R219, R221	1/4W/10ohms	RFC1/4
--	-------------	--------

**RESISTORS, OXIDE METAL-FILM, 5%:**

R201	1/2W/68ohms	RS1/2FS
R202	1/2W/7.5ohms	RS1/2FS
R223	1/2W/750ohms	RS1/2FS

**RESISTORS, CEMENTED WIRE-WOUND:**

R204, R206, R208, R210, R212, R214, R216, R218, R220, R222	5W/0.33ohms	RGC5T
--	-------------	-------

### 3. RIGHT OUTPUT PCB ASSEMBLIES

#### TRANSISTORS:

Q301	2SC3478 (K)
Q302	2SA1306B
Q303	2SA1516
Q304 THROUGH Q313	2SB554

#### DIODES:

D301	EGP50D
------	--------

#### CAPACITORS, ELECTROLYTIC:

C302	100V/47 $\mu$ F	PANASONIC ECEA2AGE470
------	-----------------	-----------------------

#### CAPACITORS, FILM:

C301	50V/0.1 $\mu$ F	PANASONIC ECQV1H104J2
------	-----------------	-----------------------

#### RESISTORS, FUSIBLE, 5%:

R303, R305, R307, R309, R311, R313, R315, R317, R319, R321	1/4W/10ohms	RFC1/4
--	-------------	--------

#### RESISTORS, OXIDE METAL-FILM, 5%:

R301	1/2W/68ohms	RS1/2FS
R302	1/2W/7.5ohms	RS1/2FS

#### RESISTORS, CEMENTED WIRE-WOUND:

R304, R306, R308, R310, R312, R314, R316, R318, R320, R322	5W/0.33ohms	RCG5T
--	-------------	-------

#### THERMISTOR:

TH301	TD5-C310 DA
-------	-------------

### 4. FILTER CAPACITOR PCB ASSEMBLIES

#### RESISTORS, OXIDE METAL-FILM, 5%:

R801, R802	2W/8.2kohms	RS2FB
R803	1/2W/100ohms	RS1/2FS

#### CAPACITORS, FILM:

C803, C804	100V/0.1 $\mu$ F	UMS
C805	100V/1 $\mu$ F	PANASONIC ECQE1105KF

### 5. AC INPUT/BIAS TIME-DELAY

#### RELAY:

RY501	$\Delta$ 81-629-0	125V/30A/24VDC
-------	-------------------	----------------

#### TRANSISTORS:

Q501	2SA1015
Q502	2SC1815

#### DIODES:

D501, D502	$\Delta$ IN4004
D503	ISS178

**DIODES, ZENER:**

D504 ADCOM J2

**PHOTO COUPLER:**PC501  $\Delta$  PS2505-1**CAPACITORS, ELECTROLYTIC:**C502  $\Delta$  100V/1uF  
C501  $\Delta$  50V/220uF  
C504 25V/220uF**CAPACITORS, SPARK-KILLER:**C503  $\Delta$  400V/0.01uF PANASONIC ECKDNS103ZV**RESISTORS, CEMENTED WIRE-WOUND:**R506  $\Delta$  20W/4.7ohms CR20P  
R502  $\Delta$  10W/680ohms CR10P**RESISTORS, CARBON-FILM, 5%:**R507 1/4W/1.8kohms  
R501 1/4W/3.3kohms  
R505 1/4W/5.1kohms  
R504 1/4W/10kohms  
R508 1/4W/47kohms  
R503 1/4W/68kohms**6. CHASSIS-MOUNTED COMPONENTS****AC POWER SWITCH:**S701  $\Delta$  12005C BLACK,CARLING  
RGSCC-711-R-B-B-O  
 $\Delta$  12005CW WHITE,CARLING  
RGSCC-711-R-W-W-O**POWER TRANSFORMER:**T801  $\Delta$  ADCOM 23-2043-0-0**CAPACITORS, ELECTROLYTIC:**C801, C802  $\Delta$  ADCOM 100V/35,000uF**SILICON RECTIFIER:**D801  $\Delta$  400V/35A KBPC3504P**RCA JACK:**

J705 ADCOM VTW-J5MI

**SPEAKER TERMINALS:**J701, J703 ADCOM R33729 RED  
J702, J704 ADCOM B33729 BLACK**FUSE HOLDERS:**

FH801, FH802, FH803 FH052

**FUSES:**FU802, FU803\*  $\Delta$  ABC-12/250V BUSSMAN  
3AG314012/250V LITTELFUSE  
SOC  
FU801\*  $\Delta$  ABC-15/250V BUSSMAN  
3AG314015/250V LITTELFUSE  
SOC  
CES6-15A/125V



## 7. FRONT PANEL ASSEMBLY

### FRONT PANEL:

63-6305-0	BLACK
63-6305-1	WHITE

### LEDs:

D802	LTL2201	RED, POWER INDICATOR
D804	LTL2201	RED, THERMAL PROTECTION
D803	LTL2251	YELLOW, INSTANTANEOUS DISTORTION ALERT

## 8. PACKING AND ACCESSORIES

CARTON	94-2042-0-3	FOUR PIECES
STYROFOAM FILLER	94-1116-0-0	TWO PIECES
STYROFOAM PADS	94-1121-0-0	

## 9A. POWER SUPPLY PCB ASSEMBLY FOR OPTIONAL FAN MOTOR, ISSUE "A"

### INTEGRATED CIRCUITS:

IC601	NJM78M24FA
-------	------------

### TRANSISTORS:

Q603	2SA1469
Q601, Q602	2SC945

### DIODES:

D601	1SS178
D602	DBA10B

### CAPACITORS, ELECTROLYTIC:

C603	35V/1000uF
C601	25V/100uF
C602	25V/47uF

### RESISTORS, CARBON-FILM, 5%:

R603	1/4W/1kohms
R604	1/4W/2.4kohms
R607	1/4W/7.5kohms
R602	1/4W/10kohms
R601, R605	1/4W/24kohms
R606	1/4W/160kohms

## 9B. POWER SUPPLY PCB ASSEMBLY FOR OPTIONAL FAN MOTOR, ISSUE "B"

### INTEGRATED CIRCUITS:

IC601	NJM4558
IC602	NJM78M24FA

### TRANSISTORS:

Q601	2SA1469R
------	----------

### DIODES:

D601	1SS178
D602	DBA10B

**CAPACITORS, ELECTROLYTIC:**

C601	50V/10uF
C602	35V/1000uF

**RESISTORS, CARBON-FILM, 5%:**

R601, 604	1/4W/7.5kohms
R602	1/4W/9.1kohms
R603, R605, R606	1/4W/24kohms
R607	1/4W/150kohms
R608	1/4W/10kohms
R609	1/4W/1kohms

**10. OPTIONAL BALANCED INPUT  
PCB ASSEMBLY****XLR INPUT JACK:**

J808	NC3FP-1-B	NEUTRIK
------	-----------	---------

**INTEGRATED CIRCUITS:**

IC701, IC702	ADCOM 6A
--------------	----------

**TRANSISTORS:**

Q701	2SD414
Q702	2SB548

**DIODES:**

D702, D704	IN4002
------------	--------

**DIODES, ZENER:**

D701, D703	6ZA18Z
------------	--------

**CAPACITORS, ELECTROLYTIC:**

C707, C710	25V/56uF
C708, C711	25V/470uF

**CAPACITORS, MICA:**

C701	100V/47pF
C702	100V/12pF
C703, C705	100V/15pF

**CAPACITORS, CERAMIC:**

C706, C709	50V/0.01uF
------------	------------

**CAPACITORS, VARIABLE:**

C704	2pF to 7pF	36-133
------	------------	--------

**RESISTORS, METAL-FILM, 1%:**

R702	1/4W/45.3ohms	RN14K2E
R704	1/4W/7.5kohms	RN14K2E
R705	1/4W/13.3kohms	RN14K2E
R706	1/4W/4.99kohms	RN14K2E

**RESISTORS, OXIDE METAL-FILM, 5%:**

R708, R710	2W/2.7kohms	RS2FS
R709, R711	2W/16kohms	RS2FS

**RESISTORS, ARRAY:**

R701	20kohms x 8	BECKMAN 698-3-R20K
------	-------------	--------------------

**RESISTORS, VARIABLE:**

R703	100ohms	41-7123
------	---------	---------

**SWITCHES:**

S701	SRBM 14	81-197
------	---------	--------

\* The fuses listed, and their time-current blowing points, have been carefully selected and thoroughly tested to deliver optimal performance while still accomplishing their protective functions. Replace these fuses, individually, only with the specific types listed. **DO NOT USE ANY SUBSTITUTE FUSES WITH DIFFERENT RATINGS, TIME-CURRENT CURVES OR VALUES.** Failure to comply may cause serious damage to the amplifier circuits and **MAY CREATE A FIRE HAZARD.**

△ **Because of fire, shock and/or other hazards, parts identified by, and listed with, this sign MUST** be replaced with the **IDENTICAL FACTORY PART** listed in the SERVICE PARTS LIST. No substitutions with other "equivalent" parts can be made.

AUDIO INPUT/DRIVER PCB ASSEMBLY

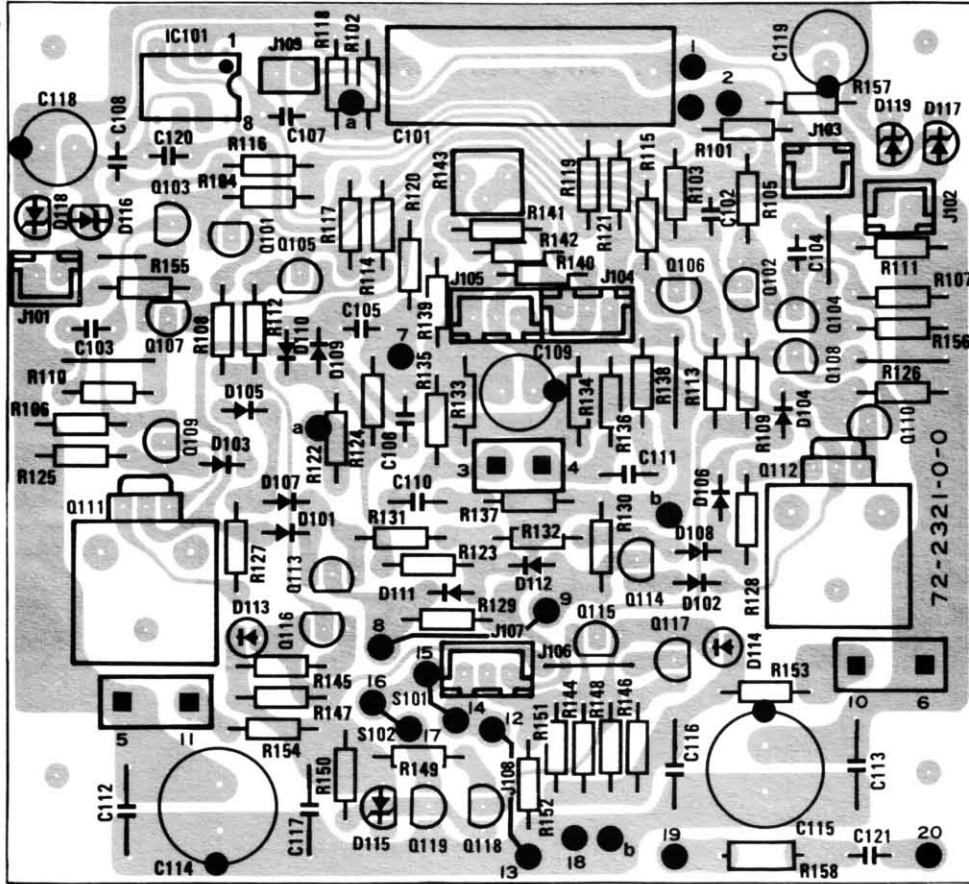

AC INPUT/BIAS TIME DELAY PCB

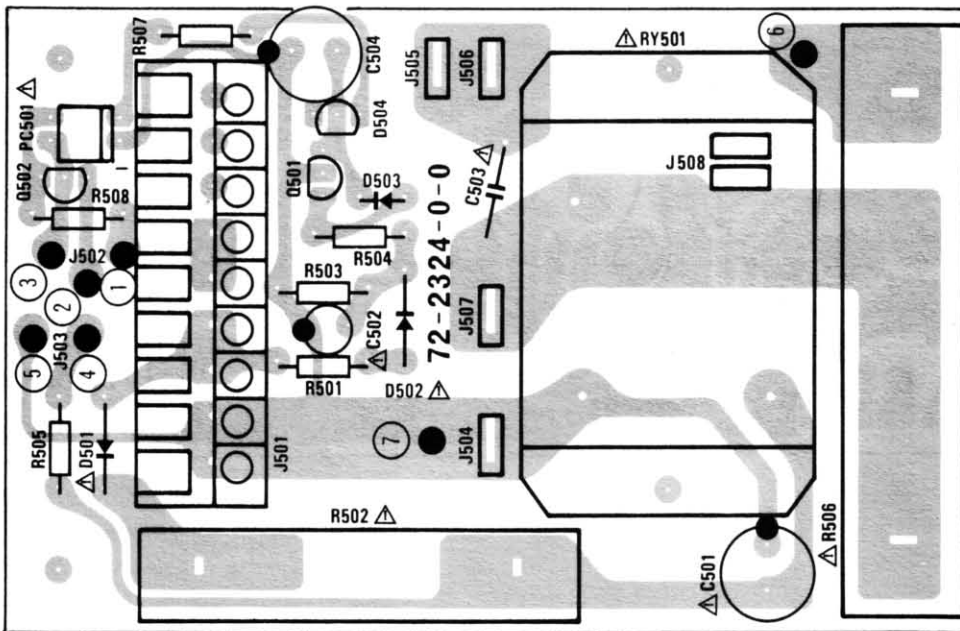

# LEFT OUTPUT PCB ASSEMBLIES

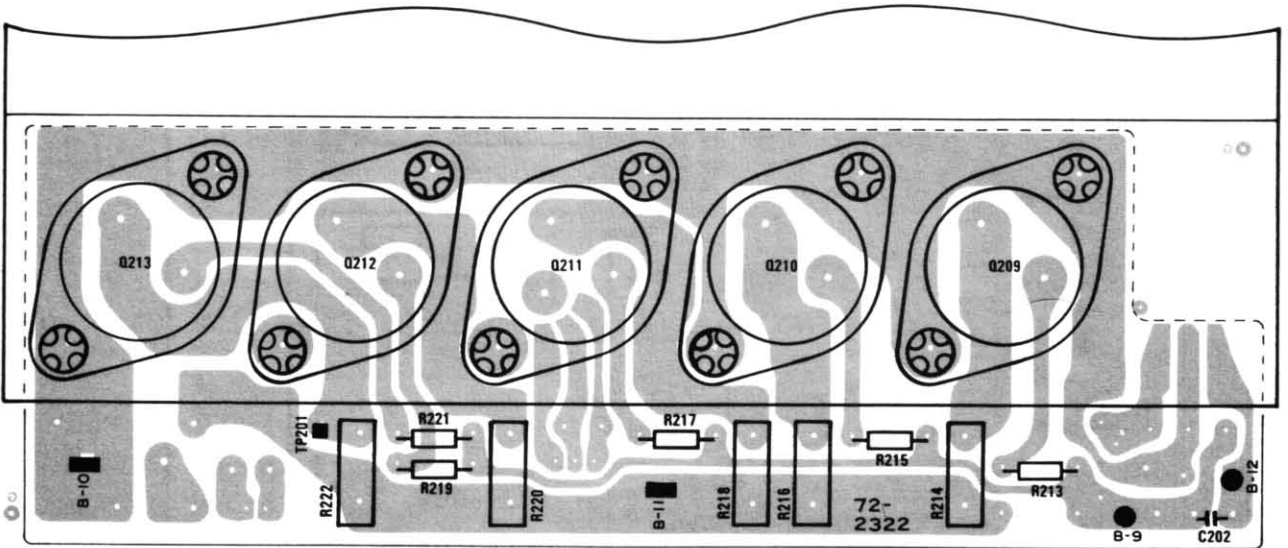
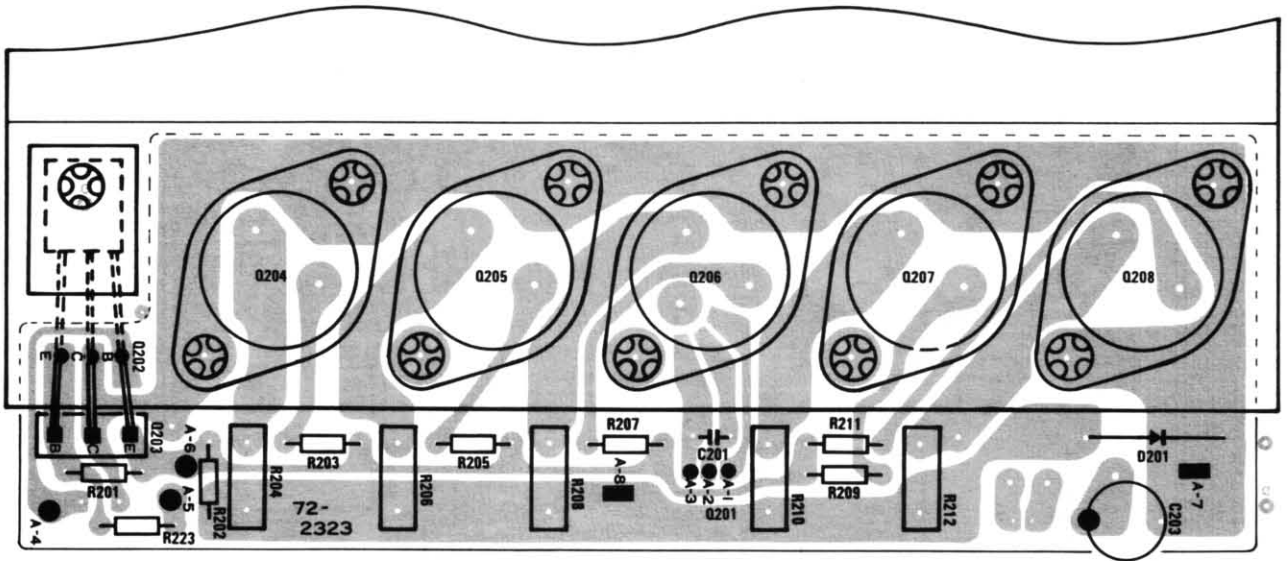

# RIGHT OUTPUT PCB ASSEMBLIES

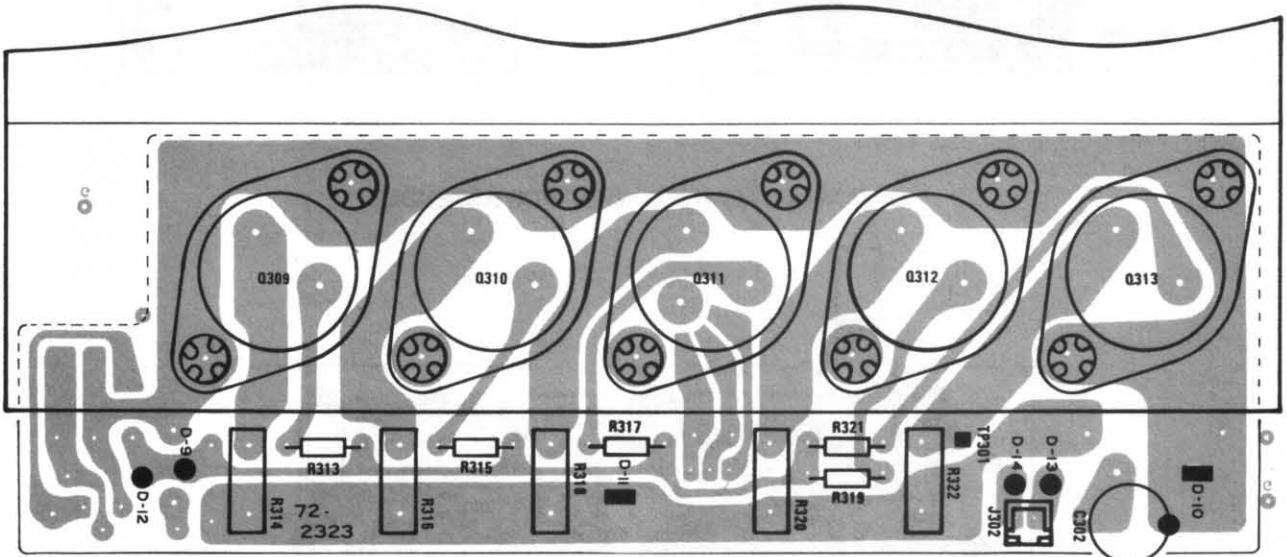
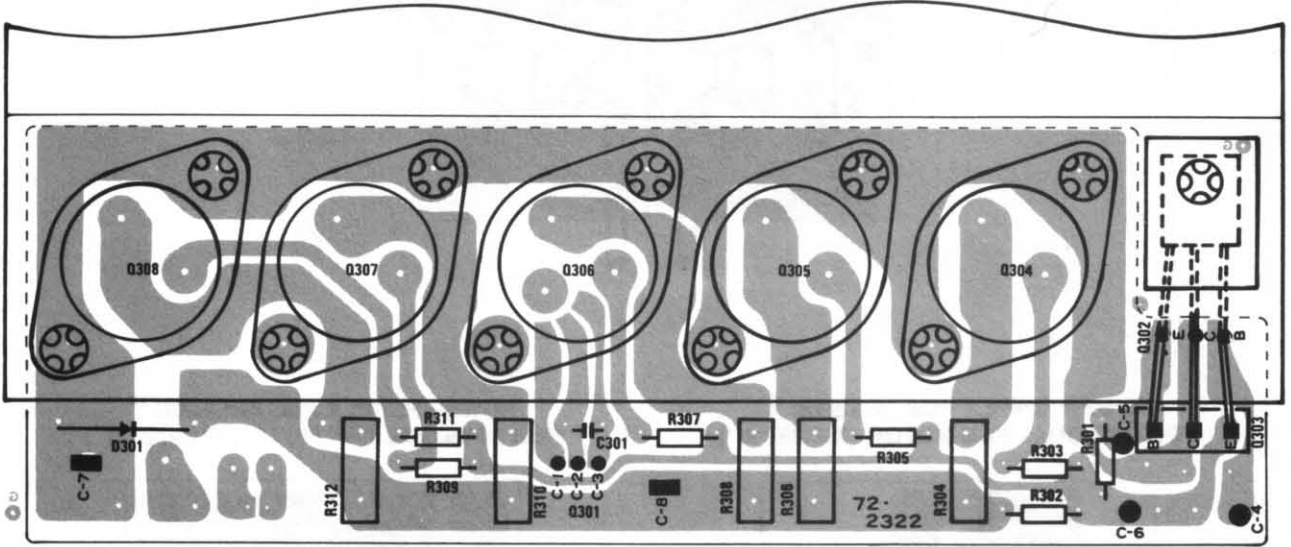

**FILTER CAPACITOR PCB ASSEMBLIES**

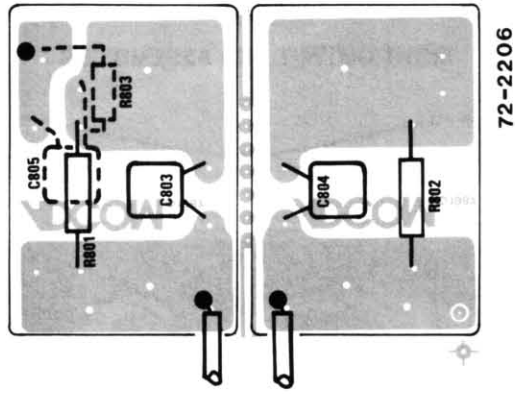

**POWER SUPPLY PCB ASSEMBLY FOR OPTIONAL FAN MOTOR (ISSUE "A")**

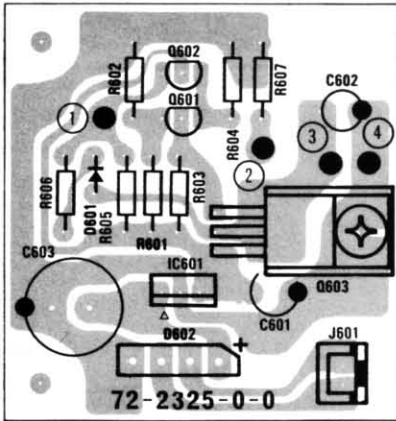

**POWER SUPPLY PCB ASSEMBLY FOR OPTIONAL FAN MOTOR (ISSUE "B")**

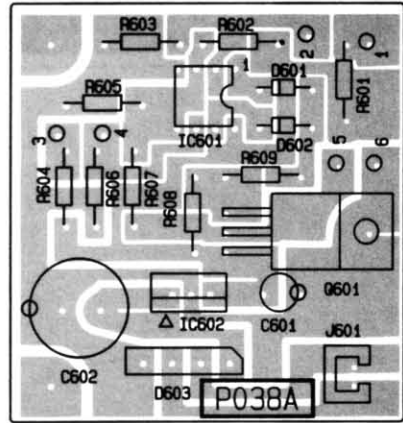

**OPTIONAL BALANCED INPUT PCB ASSEMBLY**

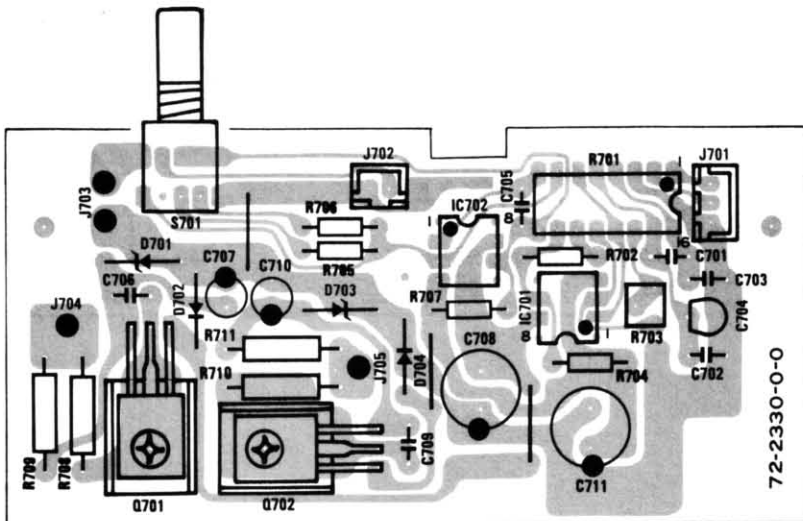

# GFA-565 TYPICAL PERFORMANCE DATA

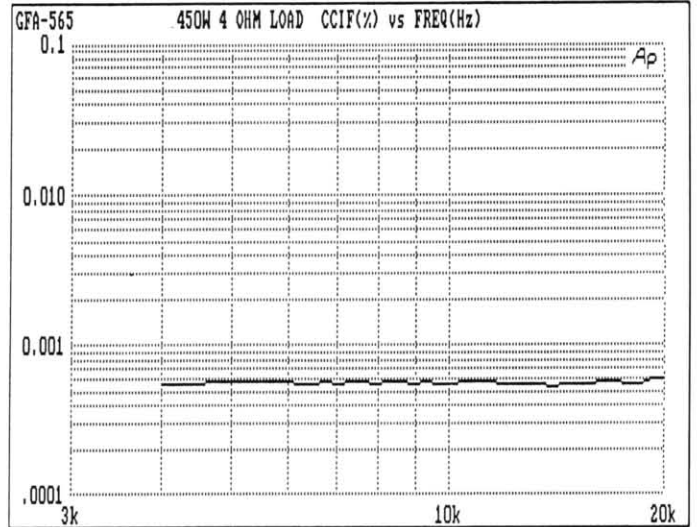
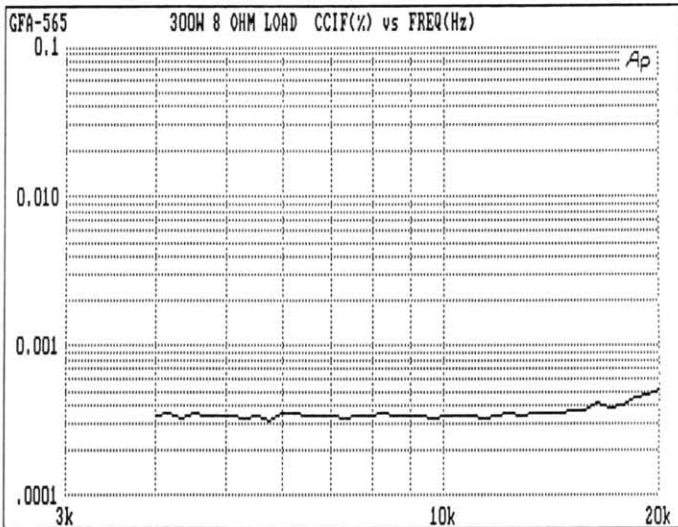
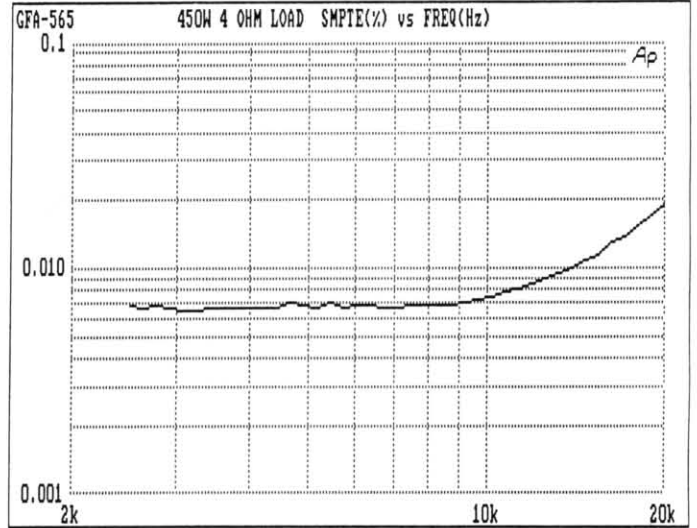
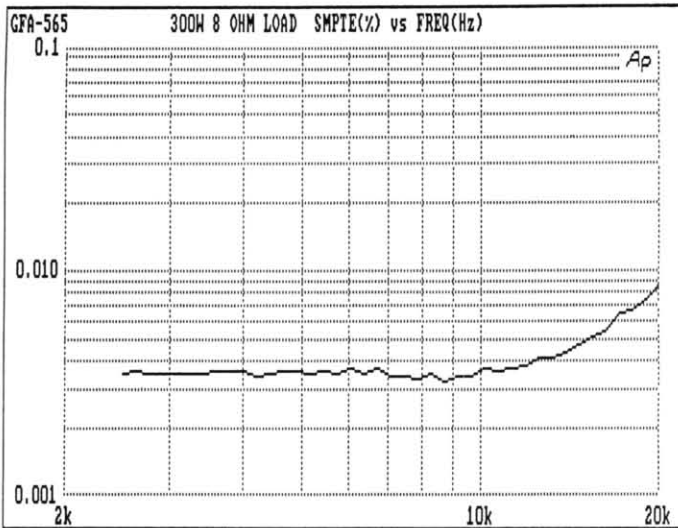
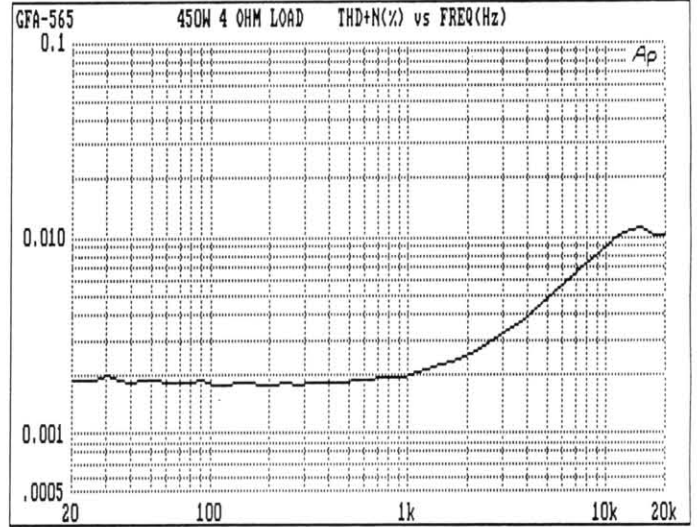
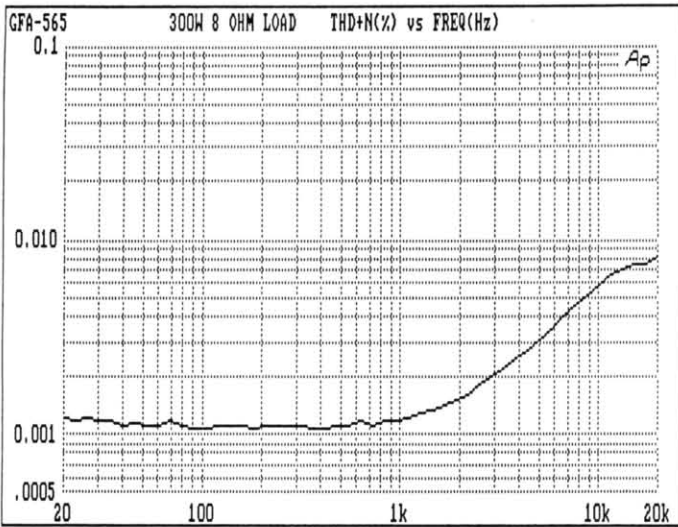



# GFA-565 TYPICAL PERFORMANCE DATA

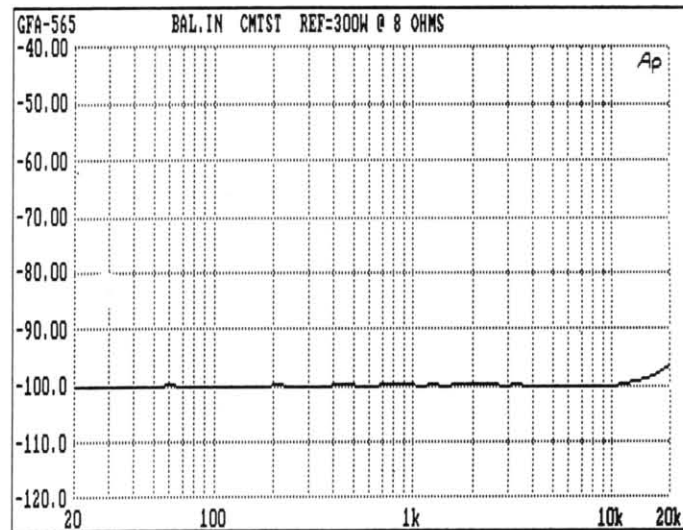
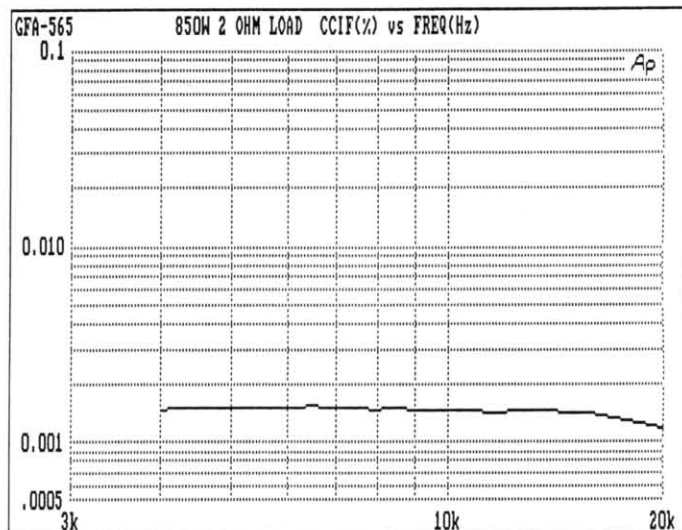
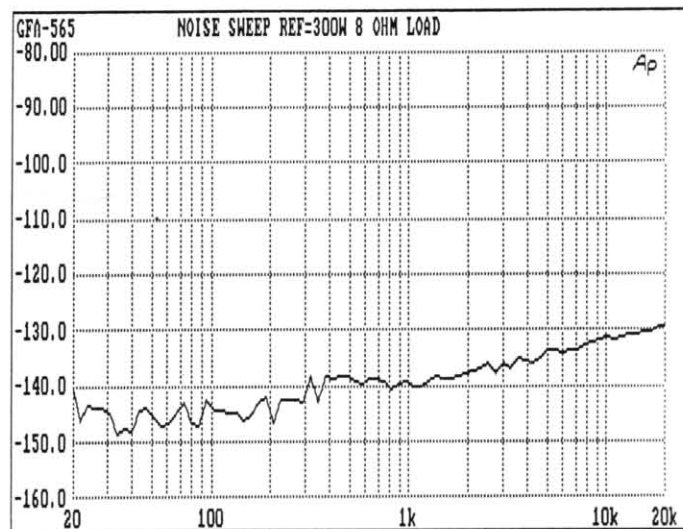
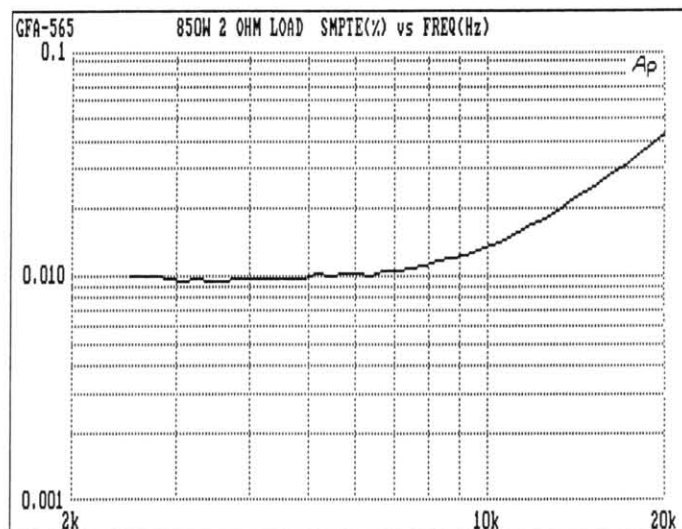
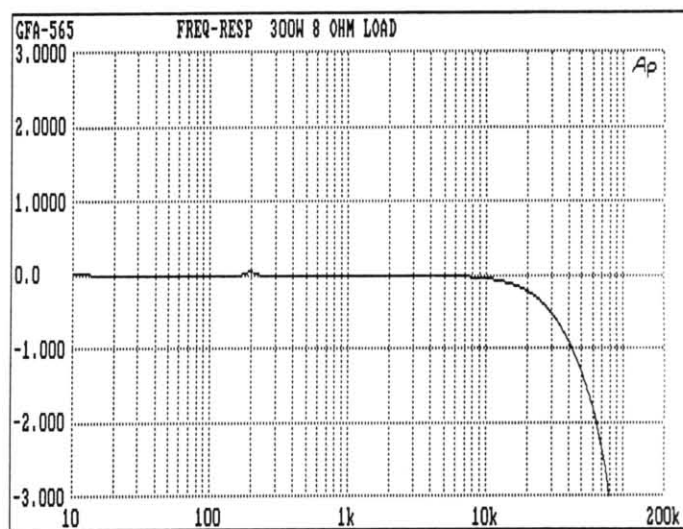
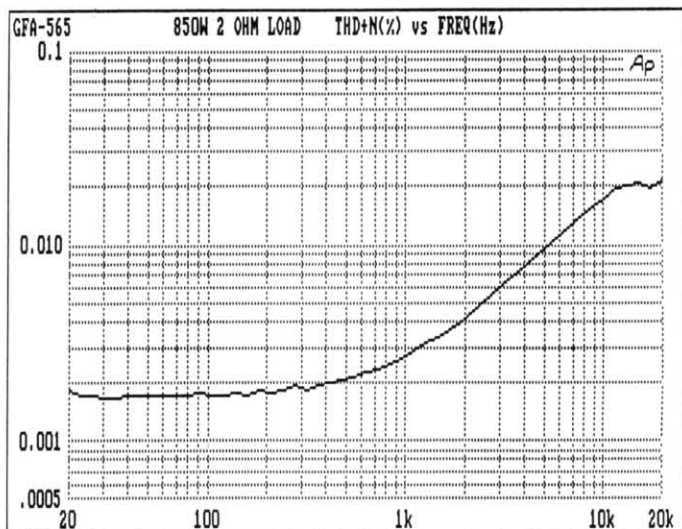

# GFA-565 SPECIFICATIONS

## Power Rating (To FTC Requirements)

- 300 watts continuous average power into 8 ohms, any frequency between 20Hz and 20kHz, @ less than 0.02% THD.
  - 450 watts continuous average power into 4 ohms, any frequency between 20Hz and 20kHz, @ less than 0.02% THD.
  - 850 watts continuous average power into 2 ohms, any frequency between 20Hz and 20kHz, @ less than 0.02% THD. \*
- \* With fan option installed.

## IM Distortion (SMPTE)

- 1 watt to 300 watts into 8 Ohms ..... 0.005%
- 1 watt to 450 watts into 4 Ohms ..... 0.007%
- 1 watt to 850 watts into 2 Ohms ..... 0.009%

## IM Distortion (CCIF, Any Combination from 4kHz to 20kHz)

- 300 watts into 8 Ohms ..... 0.002%
- 350 watts into 4 ohms ..... 0.003%
- 850 watts into 2 ohms ..... 0.004%

## THD + Noise @ 300 Watts into 8 Ohms

- 20Hz ..... 0.002%
- 1kHz ..... 0.002%
- 10kHz ..... 0.004%
- 20kHz ..... 0.010%

## THD + Noise @ 450 Watts into 4 Ohms

- 20Hz ..... 0.003%
- 1kHz ..... 0.003%
- 10kHz ..... 0.007%
- 20kHz ..... 0.015%

## THD + Noise @ 850 Watts into 2 Ohms

- 20Hz ..... 0.003%
- 1kHz ..... 0.003%
- 10kHz ..... 0.009%
- 20kHz ..... 0.018%

## Frequency Response @ 1 Watt into 8 Ohms

- 10Hz to 20kHz ..... +0, -0.5dB

Power Bandwidth (-3dB) ..... 0.7Hz to 80kHz

Dynamic Headroom into 4 Ohms ..... 1.6dB

## Signal-to-Noise Ratio, "A" Weighted

- 300 watts into 8 Ohms ..... >115dB

Gain ..... 27dB

Input Impedance ..... 50,000 ohms

## Input Sensitivity

- 300 watts into 8 Ohms ..... 2.15V rms
- 1 watt into 8 Ohms ..... 130mV rms

## Damping Factor

- 20Hz to 20kHz ..... >1000

## Rise Time

- 5kHz, 120V peak-to-peak square wave, 20% to 80% ..... 2.9us

Semiconductor Complement ..... 47 transistors, 6 zener diodes,  
17 diodes, 1 IC, 1 diode bridge

Power Consumption (Continuous)	
Quiescent .....	84VA
Maximum .....	1800VA
300 watts into 8 Ohms .....	420VA
450 watts into 4 Ohms .....	700VA
850 watts into 2 Ohms .....	1330VA

## BALANCED INPUT OPTION

Frequency Response, 10Hz to 40kHz .....	+0, -0.5dB
THD + Noise @ 2V Out, 20Hz to 20kHz .....	0.005%
IM Distortion (SMPTE) @ 2V Out .....	0.002%
IM Distortion (CCIF, Any Combination from 4kHz to 20kHz) @ 2V out .....	0.005%
Common-Mode Rejection, 10Hz to 20kHz .....	>85dB
Input Impedance (Bridging, DC to 20kHz) .....	>100,000 ohms
Input, Non-Inverting, Positive-Going, XLR .....	PIN 3
Input Sensitivity (Selectable, 0dBm, +8dBm, +14dBm)	
300 watts into 8 ohms (0dBm position) .....	+8.8dBm(2.15V)
1 watt into 8 ohms (0dBm position) .....	-15.5dBm(130mV)
300 watts into 8 ohms (+8dBm position) .....	+16.8dBm(5.23V)
1 watt into 8 ohms (+8dBm position) .....	-7.5dBm(327mV)
300 watts into 8 ohms (+14dBm position) .....	+22.8dBm(10.7V)
1 watt into 8 ohms (+14dBm position) .....	-1.5dBm(650mV)

## GENERAL

Power (available in 220V or 240V on special order) .....	120VAC/50-60Hz
Chassis Dimensions .....	8"(203mm) x 17"(432mm) x 12-3/16"(310mm)
Maximum Dimensions .....	8-3/8"(213mm) x 17"(432mm) x 12-3/16"(310mm)
Weight .....	41 lbs.(18.7kg)
Weight,Packed .....	45 lbs.(20.5kg)

**ADCOM**

11 Elkins Road  
 East Brunswick, NJ 08816  
 Telephone (908) 390-1130  
 Fax (908) 390-9152





Faint, illegible text, possibly bleed-through from the reverse side of the page.

**ADCOM®**

11 Elkins Road  
East Brunswick, NJ 08816 U.S.A.  
Telephone (908) 390-1130  
Fax (908) 390-9152

Printed in U.S.A.