

SERVICE MANUAL

ADCOM®

POWER AMPLIFIER

GFA-585

TABLE OF CONTENTS

Introduction	1
Test Procedures	2
Service Parts List	3
Typical Performance Data.....	9
Specifications	11
Audio Input/Driver PCBs	12
AC Input/Bias Time Delay PCB	13
Filter Capacitor PCBs	13
Optional Fan Motor PCB	13
Output PCBs	14
Schematic Diagram	15

ADCOM®

TECHNICAL SERVICE DEPARTMENT

11 ELKINS ROAD

EAST BRUNSWICK, NJ 08816

TELEPHONE (908) 390-1130

FAX (908) 390-9152

INTRODUCTION

This service manual is intended to assist trained and qualified technical personnel in verifying the performance of, adjusting, and repairing the ADCOM GFA-585 power amplifier. The procedures described here are not intended for persons unfamiliar with the appropriate safety and test procedures.

WARNING

THERE ARE POTENTIALLY LETHAL VOLTAGES WITHIN THE GFA-585 AMPLIFIER WHICH WILL BE ACCESSIBLE ONCE ITS TOP COVER IS REMOVED. **DO NOT ATTEMPT FAMILIARIZATION WITH, INSPECTION OF, OR ANY PROCEDURE WHATSOEVER UNLESS YOU HAVE DISCONNECTED THE GFA-585 FROM THE WALL AC OUTLET OR OTHER SOURCE OF AC POWER AND THE POWER SUPPLY CAPACITORS ARE COMPLETELY DISCHARGED.** PLEASE TAKE NOTE THAT THE POWER SUPPLY CAPACITORS TAKE AS LONG AS 5 MINUTES TO DISCHARGE. THESE INSTRUCTIONS ARE PROVIDED FOR USE ONLY BY COMPETENT TECHNICAL PERSONNEL. **DO NOT UNDERTAKE ANY SERVICE PROCEDURES IN THE GFA-585 UNLESS YOU ARE TECHNICALLY QUALIFIED TO DO SO.**

CIRCUIT DESCRIPTION

The ADCOM GFA-585 is a stereo power amplifier rated at 0.02% THD from 20Hz to 20kHz with 250 watts into 8 ohms, and 400 watts into 4 ohms. The output stage is capable of greater than 60 amps into low-impedance loads. The amplifier employs a discrete dual-differential cascode Class-A front-end followed by a dual-cascode Class-A voltage-gain stage which amplify the input signal to the voltage required at the output of the amplifier. This high-voltage signal drives the high-current triple-Darlington-follower output stage which amplifies the current by a factor of about 50,000.

Referring to the accompanying schematic, the input signal passes through network C101, C102, R102, and R103 which provide a 3dB bandwidth of 0.7Hz to 700kHz to the input of the amplifier. C101 is an extremely high quality capacitor and serves to protect the amplifier and the speakers connected to it from DC faults at the output of the preamplifier. **WE DO NOT RECOMMEND THAT C101 BE SHORTED OUT.** Q101, Q102, Q103, and Q104 form one differential/cascode input stage and Q109, Q110, Q111, and Q112 form the other. R106, R108, R141, and R144 provide local feedback to control the input-stage open-loop gain. Open-loop gain is defined by R105, R107, and C103 on one side, and R142, R143, and C117 on the other. The next voltage-gain stage consists of Q105 and Q106 on one side and Q118 and Q119 on the other. DC bias is set by R118, D105, D106, D108, D110, D118, D119, R123, R130, and R210. Open-loop gain is defined by R118, R124, R131, and R210, with R120, R135, R313, R413, C301, and C403 providing high-frequency compensation.

Feedback is provided from the output to the bases of Q104 and Q112 by the network R112, R114, and C106. C106 provides a high-frequency rolloff above 80kHz. D101 through D104, D107, D109, D120, D121, Q107, Q108, R113, R115, R117, R128, R129 and C107 provide an anti-saturation feedback path to the input stage. For example, when the cascode voltage-gain stage approaches saturation to the positive supply, D107 begins to conduct, turning Q107 on. Current flows through D802, the INSTANTANEOUS DISTORTION ALERT LED, through D104 and R117. When the error voltage across D101/D102 becomes great enough, D101 begins to conduct, forcing the input stage to reduce the drive to the voltage-gain stage.

The input stage is biased by R146 through R149, R201 through R207, Q113 through Q117, Q502, D115 through D117, and D801. Q502 is turned on by the amplifier bias-delay circuitry on the power supply board. A current of about 2mA flows through the thermal breakers on the heatsinks and into the emitter of Q117 and Q167 (on the other channel). If the heatsinks overheat, the breakers open and the current flows through D801, the THERMAL PROTECTION LED instead. When Q117 is carrying the current, D117 is biased at 2.5V. This creates about 1.8V across R202. Q116 then sources about 2mA to D115, which develops about 2.2V across it. About 1.6V is developed across R146 and R148. Q115 conducts about 1.3mA to D116 and Q113 conducts about 3mA to the PNP differential input stage. D116 develops about 2.2V across it, causing about 1.6V across R147. Q114 conducts about 3mA to the NPN differential input stage. If the negative 80V supply fails or its fuse opens, Q117 turns off, turning off all the amplifier bias circuitry. If the positive 80V supply fails or its fuse opens, again Q117 turns off and the bias circuitry is disabled. Using LEDs for the bias circuitry causes rough temperature compensation of the amplifier Class-A DC-bias current.

Any DC imbalance in the amplifier is corrected by R110, R111, C104, C105, and IC101. Any DC error at the amplifier output is servoed back through IC101 to adjust the DC current through the input transistors. DC bias is nominally 1.5mA through Q103, Q104, Q109, and Q112. IC101 can modify this by up to 0.3mA to bring the amplifier into balance.

The bias network of R122, R125, R126, R127, R132, Q120, and Q401 form a temperature-compensated DC-bias voltage to the input of the triple-Darlington-follower output stage. Mid- and high-frequency bypassing is provided by C111.

R134 and C113 provide a load for the amplifier at high frequencies, stabilizing the amplifier under varying load conditions. D301 and D401 provide a high current return to the power supply for backlash current from the load.

The output stage consists of two sets of 5 parallel transistors operated as emitter followers, driven by another pair of emitter followers. This configuration minimizes distortion caused by varying load impedances. The output transistors have 0.33-ohm ballast resistors to ensure current sharing and bias stability.

The AC-input power supply board includes a power-on delay relay to reduce the turn-on current surge in the AC power line, jumpers to set the supply voltage range, and an amplifier bias delay.

CAUTION

DO NOT use any type of variable AC supply, such as a variac, to slowly turn on the GFA-585 without first shorting R506 (4.7 ohm/20 watt). R506 is an integral part of the turn-on, inrush-suppression circuit and failure to comply will burn out R506.

TEST PROCEDURES

All tests are performed with a 120V, low-distortion (less than 2%), AC-power source, 8-ohm resistive load (except slew rate), and a signal source of not more than 600 ohms.

Tests are performed after warming up the amplifier at 83 watts into an 8-ohm load for at least 10 minutes.

All grounds during testing are referred to the ground of the black output terminals, **EXCEPT FOR RCA INPUT-JACK GROUNDS AND ANY SIGNAL-GENERATOR GROUND. DO NOT CONNECT RCA INPUT-JACK GROUNDS TO BLACK OUTPUT-TERMINAL BINDING POSTS, DAMAGE TO THE GROUNDING SYSTEM OF THE AMPLIFIER MAY RESULT.**

80kHz low-pass filter is employed during THD distortion measurements.

Signal-to-noise measurements are "A" weighted.

Damping factor is measured by comparing the 20-watt-output voltage with and without an 8-ohm load.

Slew rate is measured with an inductive load, and is derived with a dual-time-based oscilloscope reading the slope of a full-power (120V peak-to-peak) 5kHz square wave. To avoid damaging output networks R134/C113 and R184/C163 **DO NOT OPERATE THE AMPLIFIER AT FULL-POWER, SINE-WAVE ABOVE 22kHz OR FULL-POWER (120V PEAK-TO-PEAK) SQUARE WAVE ABOVE 5kHz.**

IMPORTANT

BEFORE PROCEEDING WITH ADJUSTMENTS, MAKE SURE AMPLIFIER IS AT ROOM TEMPERATURE.

BIAS ALIGNMENT

1. With set-up as per the first paragraph of TEST PROCEDURES and with NO SIGNAL IN, set bias controls (R125, R175) to midpoint.
2. Connect a millivolt meter across TP301 and TP401.
3. Turn amplifier on and allow a 3 to 5 minute settling period.
4. Adjust BIAS control R125 to obtain either a + or - 24mV (± 1 mV) indication on the millivolt meter.
5. Connect a millivolt meter across TP351 and TP451.
6. Adjust BIAS control R175 to obtain either a + or - 24mV (± 1 mV) indication on the millivolt meter.
7. To check for proper bias setting, remove millivolt meter and apply input signal to obtain 83 watts into 8 ohms for 10 minutes with the amplifier's cover on.
8. Remove input signal and connect the millivolt meter as in step 2 and step 5. Let amplifier idle until bias stabilizes and readjust to 24mV (± 1 mV).

ADCOM GFA-585 SERVICE PARTS LIST

1. LEFT CHANNEL AUDIO INPUT/DRIVER PCB ASSEMBLY

INTEGRATED CIRCUITS:

IC101 ADCOM 2A

TRANSISTORS:

Q103, Q104	MPS-A13	—	ADCOM MATCHED PAIRS
Q109, Q112	MPS-A63		
Q101, Q102, Q114, Q116	2SC3478		
Q105	2SA1015		
Q106	2SA1210		
Q107, Q117	2SA970		
Q108	2SC2240		
Q110, Q111, Q113, Q115, Q120	2SA1376		
Q118	2SC2912		
Q119	2SC1815		

DIODES, ZENER:

D111, D112, D113, D114 ADCOM J2
D117 ADCOM J6

DIODES:

D101, D102, D103, D104,	—	1SS178
D105, D118, D120, D121		
D107, D109		1SS82

DIODES, VARISTOR:

D106, D119 KB362
D108, D110 KB262

LEDs:

D115, D116 SLP246B

CAPACITORS, ELECTROLYTIC:

C109, C121 100V/100uF
C111, C114, C115 25V/220uF

CAPACITORS, FILM:

C103, C117	50V/3900pF	PANASONIC ECQB1H332JF
C104, C105, C116	50V/0.1uF	PANASONIC ECQV1H104J2
C108, C118, C119, C120	100V/1uF	PANASONIC ECQE1105KF
C113	100V/0.047uF	UMS
C101	100V/4.7uF	ROEDERSTEIN MKC1862 ELECTRONIC CONCEPTS 5MC22B505K

CAPACITORS, MICA:

C102 100V/220pF Z-08
C106, C107 100V/82pF Z-05

RESISTORS, VARIABLE:

R125 41-7122-0 PK502H101V0

RESISTORS, CEMENTED WIRE-WOUND:

R134 3W/6.8 ohms RGCW3

RESISTORS, OXIDE METAL-FILM, 5%:

R137, R138 1/2W/27 kohms RS1/2FS
R204, R205 1/2W/39 kohms RS1/2FS

RESISTORS, METAL-FILM, 1%:

R107, R143	1/4W/10 ohms	RN14K2E
R106, R108, R141, R144	1/4W/33.2 ohms	RN14K2E
R118, R210	1/4W/49.9 ohms	RN14K2E
R127	1/4W/82.5 ohms	RN14K2E
R126	1/4W/147 ohms	RN14K2E
R207	1/4W/220 ohms	RN14K2E
R132	1/4W/280 ohms	RN14K2E

R122	1/4W/365 ohms	RN14K2E
R146, R147	1/4W/499 ohms	RN14K2E
R202	1/4W/825 ohms	RN14K2E
R103, R105, R114, R115, R119, R140, R142, R209	1/4W/1 kohms	RN14K2E
R148, R206, R208	1/4W/1.21 kohms	RN14K2E
R149, R201, R203	1/4W/4.75 kohms	RN14K2E
R117	1/4W/6.81 kohms	RN14K2E
R112, R113, R124, R128, R129, R131	1/4W/22.1 kohms	RN14K2E
R104, R109, R139, R145	1/4W/33.2 kohms	RN14K2E
R123, R130	1/4W/39.2 kohms	RN14K2E
R102	1/4W/49.9 kohms	RN14K2E
R101, R110, R111	1/4W/1 Mohms	RN14K2E

RESISTORS, FUSIBLE, 5%:

R116, R136	1/4W/10 ohms	RFC1/4
R120, R135	1/4W/82 ohms	RFC1/4

THERMOSTAT:

S101	△ 81-7014-0	UP62, 85° C
------	-------------	-------------

2. RIGHT CHANNEL AUDIO INPUT/DRIVER PCB ASSEMBLY

INTEGRATED CIRCUITS:

IC151	ADCOM 2A
-------	----------

TRANSISTORS:

Q153, Q154	MPS-A13	ADCOM MATCHED PAIRS
Q159, Q162	MPS-A63	
Q151, Q152, Q164, Q166	2SC3478	
Q155	2SA1015	
Q156	2SA1210	
Q157, Q167	2SA970	
Q158	2SC2240	
Q160, Q161, Q163, Q165, Q170	2SA1376	
Q168	2SC2912	
Q169	2SC1815	

DIODES, ZENER:

D161, D162, D163, D164	ADCOM J2
D167	ADCOM J6

DIODES:

D151, D152, D153, D154, D155, D168, D170, D171	1SS178
D157, D159	1SS82

DIODES, VARISTOR:

D156, D169	KB362
D158, D160	KB262

LEDs:

D165, D166	SLP246B
------------	---------

CAPACITORS, ELECTROLYTIC:

C159, C171	100V/100uF
C161, C164, C165	25V/220uF

CAPACITORS, FILM:

C153, C167	50V/3900pF	PANASONIC ECQB1H332JF
C154, C155, C166	50V/0.1uF	PANASONIC ECQV1H104J2
C158, C168, C169, C170	100V/1uF	PANASONIC ECQE1105KF
C163	100V/0.047uF	UMS
C151	100V/4.7uF	ROEDERSTEIN MKC1862 ELECTRONIC CONCEPTS 5MC22B505K

CAPACITORS, MICA:		
C152	100V/220pF	Z-08
C156, C157	100V/82pF	Z-05
RESISTORS, VARIABLE:		
R175	41-7122-0	PK502H101V0
RESISTORS, CEMENTED WIRE-WOUND:		
R184	3W/6.8 ohms	RGCW3
RESISTORS, OXIDE METAL-FILM, 5%:		
R187, R188	½W/27 kohms	RS½FS
R204, R205	½W/39 kohms	RS½FS
RESISTORS, METAL-FILM, 1%:		
R157, R193	¼W/10 ohms	RN14K2E
R156, R158, R191, R194	¼W/33.2 ohms	RN14K2E
R168, R260	¼W/49.9 ohms	RN14K2E
R177	¼W/82.5 ohms	RN14K2E
R176	¼W/147 ohms	RN14K2E
R257	¼W/220 ohms	RN14K2E
R182	¼W/280 ohms	RN14K2E
R172	¼W/365 ohms	RN14K2E
R196, R197	¼W/499 ohms	RN14K2E
R252	¼W/825 ohms	RN14K2E
R153, R155, R164, R165, R169, R190, R192, R259	¼W/1 kohms	RN14K2E
R198, R256, R258	¼W/1.21 kohms	RN14K2E
R199, R251, R253	¼W/4.75 kohms	RN14K2E
R167	¼W/6.81 kohms	RN14K2E
R162, R163, R174, R178, R179, R181	¼W/22.1 kohms	RN14K2E
R154, R159, R189, R195	¼W/33.2 kohms	RN14K2E
R173, R180	¼W/39.2 kohms	RN14K2E
R152	¼W/49.9 kohms	RN14K2E
R151, R160, R161	¼W/1 Mohms	RN14K2E
RESISTORS, FUSIBLE, 5%:		
R166, R186	¼W/10 ohms	RFC¼
R170, R185	¼W/82 ohms	RFC¼
THERMOSTAT:		
S151	△ 81-7014-0	UP62, 85° C

3. LEFT CHANNEL OUTPUT PCB ASSEMBLIES

TRANSISTORS:		
Q301	2SC3298B	
Q302	2SC3907	
Q303 THROUGH Q307	2SD424	
Q401	2SC3478	
Q402	2SA1306B	
Q403	2SA1516	
Q404 THROUGH Q408	2SB554	
DIODES:		
D301, D401	EGP50D	
CAPACITORS, ELECTROLYTIC:		
C302, C402	160V/47uF	PANASONIC ECEA2CGE470
CAPACITORS, FILM:		
C401	50V/0.1uF	PANASONIC ECQV1H104J2
C301, C403	100V/220pF	Z-08
RESISTORS, FUSIBLE, 5%:		
R303, R305, R307, R309, R311, R403, R405, R407, R409, R411	¼W/10 ohms	RC¼

RESISTOR, OXIDE METAL-FILM, 5%:

R302, R402	1/2W/7.5 ohms	RS1/2FS
R301, R401	1/2W/68 ohms	RS1/2FS
R314	1/2W/750 ohms	RS1/2FS

RESISTORS, METAL-FILM, 1%:

R313, R413	1/4W/10 ohms	RN14K2E
------------	--------------	---------

RESISTORS, CEMENTED WIRE-WOUND:

R304, R306, R308, R310, R312, R404, R406, R408, R410, R412	 5W/0.33 ohms	RGC5T
---	--	-------

THERMISTOR:

TH301	TD5-C310DA
-------	------------

4. RIGHT CHANNEL OUTPUT PCB ASSEMBLIES**TRANSISTORS:**

Q351	2SC3298B
Q352	2SC3907
Q353 THROUGH Q357	2SD424
Q451	2SC3478
Q452	2SA1306B
Q453	2SA1516
Q454 THROUGH Q458	2SB554

DIODES

D351, D451	EGP50D
------------	--------

CAPACITORS, ELECTROLYTIC:

C352, C452	160V/47uF	PANASONIC ECEA2CGE470
------------	-----------	-----------------------

CAPACITORS, FILM:

C451	50V/0.1uF	PANASONIC ECQV1H104J2
C351, C453	100V/220pF	Z-08

RESISTORS, FUSIBLE, 5%:

R353, R355, R357, R359, R361, R453, R455, R457, R459, R461	 1/4W/10 ohms	RC1/4
---	--	-------

RESISTOR, OXIDE METAL-FILM, 5%:

R352, R452	1/2W/7.5 ohms	RS1/2FS
R351, R451	1/2W/68 ohms	RS1/2FS
R364	1/2W/750 ohms	RS1/2FS

RESISTORS, METAL-FILM, 1%:

R363, R463	1/4W/10 ohms	RN14K2E
------------	--------------	---------

RESISTORS, CEMENTED WIRE-WOUND:

R354, R356, R358, R360, R362, R454, R456, R458, R460, R462	 5W/0.33 ohms	RGC5T
---	--	-------

THERMISTOR:

TH351	TD5-C310DA
-------	------------

5. FILTER CAPACITOR PCB ASSEMBLIES**RESISTORS, OXIDE METAL-FILM, 5%:**

R803	1/2W/100 ohms	RS1/2FS
R801, R802	2W/8.2 kohms	RS2FB

CAPACITORS, FILM:

C803, C804	100V/0.1uF	UMS
C805	100V/1uF	PANASONIC ECQE1105KF

6. AC INPUT/TIME-DELAY PCB ASSEMBLY

RELAY:		
RY501	△ 81-629-0	125V/30A/24VDC
TRANSISTORS:		
Q501	2SA1015	
Q502	2SC1815	
DIODES:		
D501, D502	△ 1N4004	
D503	1SS178	
DIODES, ZENER:		
D504	ADCOM J2	
PHOTO COUPLER:		
PC501	△ PS2505-1	
CAPACITORS, ELECTROLYTIC:		
C502	△ 100V/1uF	
C501	△ 50V/220uF	
C504	25V/220uF	
CAPACITORS, SPARK-KILLER:		
C503	△ 400V/0.01uF	PANASONIC ECKDNS103ZV
RESISTORS, CEMENTED WIRE-WOUND:		
R506	△ 20W/4.7 ohms	CR20P
R502	△ 10W/680 ohms	CR10P
RESISTORS, CARBON-FILM, 5%:		
R506	1/4W/1.8 kohms	
R501	1/4W/3.3 kohms	
R505	1/4W/5.1 kohms	
R504	1/4W/10 kohms	
R508	1/4W/47 kohms	
R503	1/4W/68 kohms	

7. CHASSIS-MOUNTED COMPONENTS

AC POWER SWITCH:		
S802	△ 81-321-0	BLACK, CARLING RGSCC-711-R-B-B-O
	△ 81-321-1	WHITE, CARLING RGSCC-711-R-W-W-O
POWER TRANSFORMER:		
T801	△ 23-2046-0	ADCOM
CAPACITORS, ELECTROLYTIC:		
C801, C802, C851, C852	△ 100V/18,000uF	ADCOM
SILICON RECTIFIERS:		
D803, D853	△ 400V/25A	KBPC2504P
RCA JACKS:		
J801, J851	VTW-J5MI	ADCOM
SPEAKER TERMINALS:		
J804, J806	B33729	BLACK, ADCOM
J803, J805	R33729	RED, ADCOM
FUSE HOLDERS:		
FH801	FH052	
FH802, FH803, 	FH032	
FH852, FH853		

FUSES:

FU801 (120V) *	△ ABC-15/250V 3AB314015/250V CES14-15A/250V	BUSSMAN LITTELFUSE SOC
FU801 (220V/240V) *	△ AGC-8/250V 3AG312008/250V CES14-8A/250V	BUSSMAN LITTELFUSE SOC
FU802, FU803, FU852, FU853 *	△ ABC-10/250V 3AB314010/250V CES6-10A/125V 3AB 10A/125V	BUSSMAN LITTELFUSE SOC BEL

FRONT PANEL:

63-6308-0	BLACK
63-6308-1	WHITE

LEDs:

D801	LTL2201	RED, THERMAL PROTECTION
D804	LTL2201	RED, POWER INDICATOR
D802, D852	LTL2251	YELLOW, INSTANTANEOUS DISTORTION ALERT

8. PACKING AND ACCESSORIES

CARTON	94-2061-0	
STYROFOAM FILLER	94-1116-0	FOUR PIECES
STYROFOAM PADS	94-1121-0	TWO PIECES

**9. POWER-SUPPLY PCB ASSEMBLY FOR
OPTIONAL FAN MOTOR, ISSUE "B"****INTEGRATED CIRCUITS:**

IC601	NJM4558
IC602	NJM78M24FA

TRANSISTORS:

Q601	2SA1469R
------	----------

DIODES:

D601	1SS178
D602	DBA10B

CAPACITORS, ELECTROLYTIC:

C601	50V/10uF
C602	35V/1000uF

RESISTORS, 5%, CARBON-FILM:

R601, R604	1/4W/7.5 kohms
R602	1/4W/9.1 kohms
R603, R605, R606	1/4W/24 kohms
R607	1/4W/150 kohms
R608	1/4W/10 kohms
R609	1/4W/1 kohms

* The fuses listed, and their time-current blowing points, have been carefully selected and thoroughly tested to deliver optimal performance while still accomplishing their protective functions. Replace these fuses, individually, only with the specific types listed. **DO NOT USE ANY SUBSTITUTE FUSES WITH DIFFERENT RATINGS, TIME-CURRENT CURVES OR VALUES.** These may cause serious damage to the amplifier circuits and **MAY CREATE A FIRE HAZARD.**

△ **Because of fire, shock and/or other hazards, parts identified by, and listed with, this sign MUST be replaced with the IDENTICAL FACTORY PART listed in the SERVICE PARTS LIST.** No substitutions with other "equivalent" parts can be made.

GFA-585 TYPICAL PERFORMANCE DATA

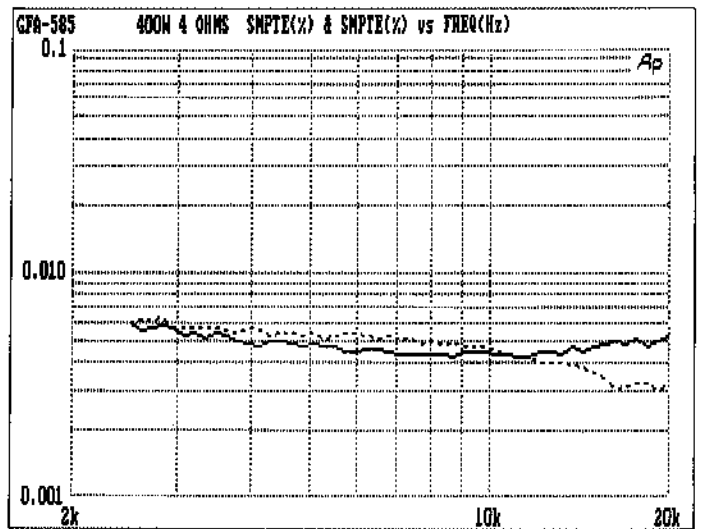
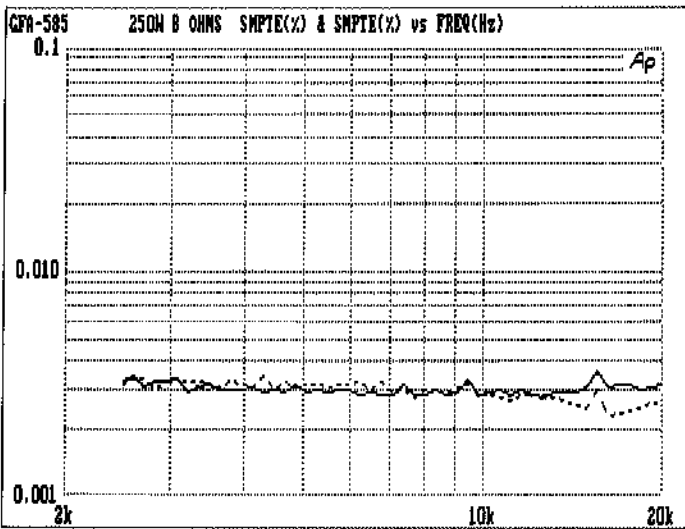
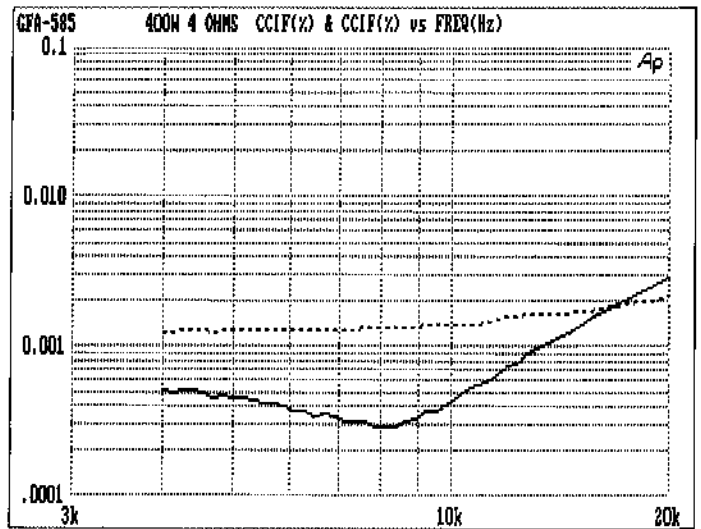
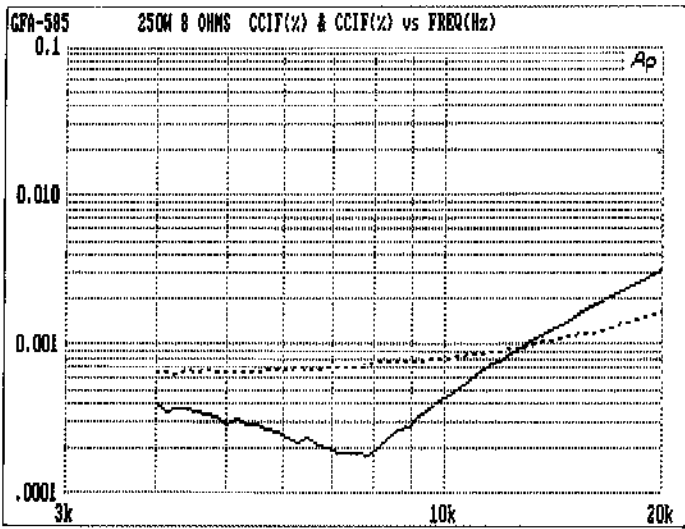
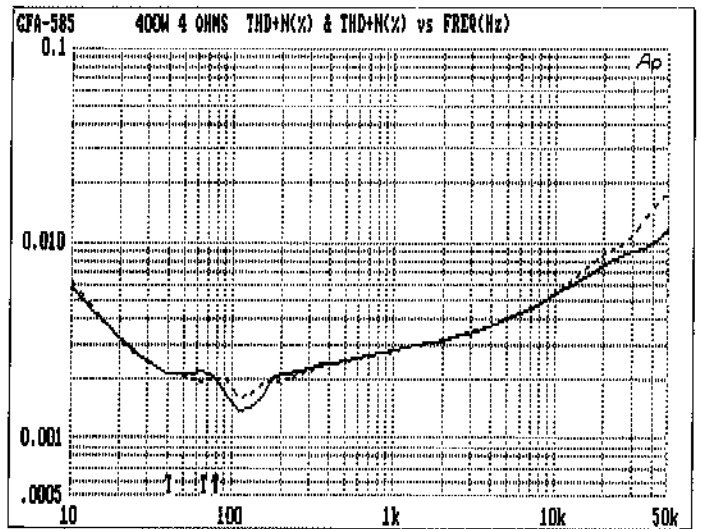
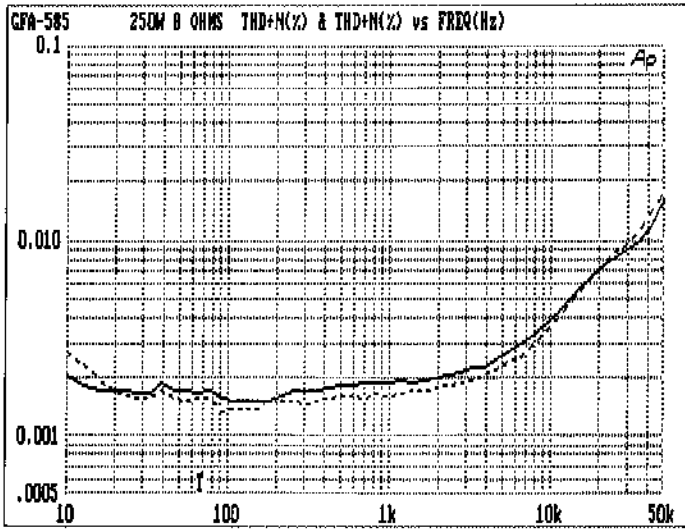

GFA-585 TYPICAL PERFORMANCE DATA

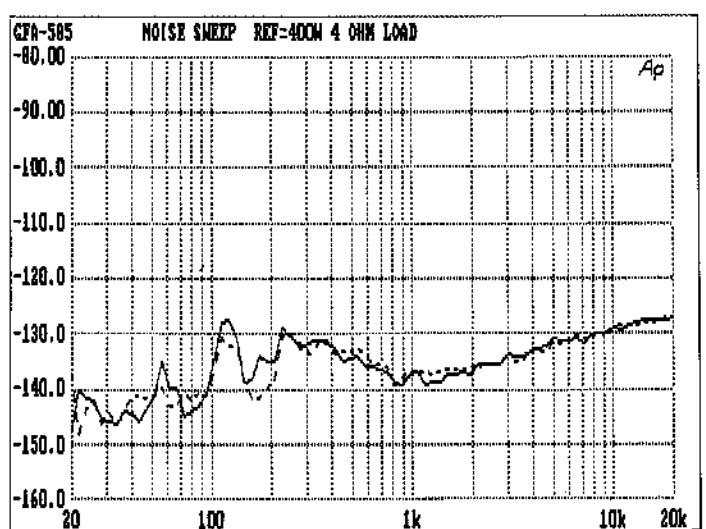
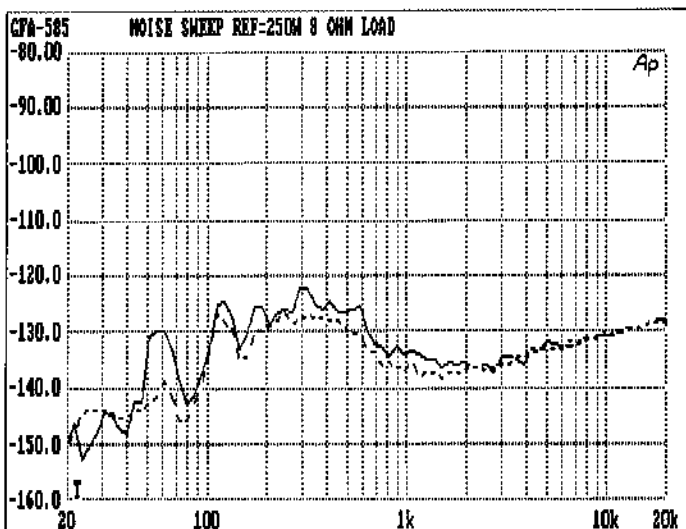
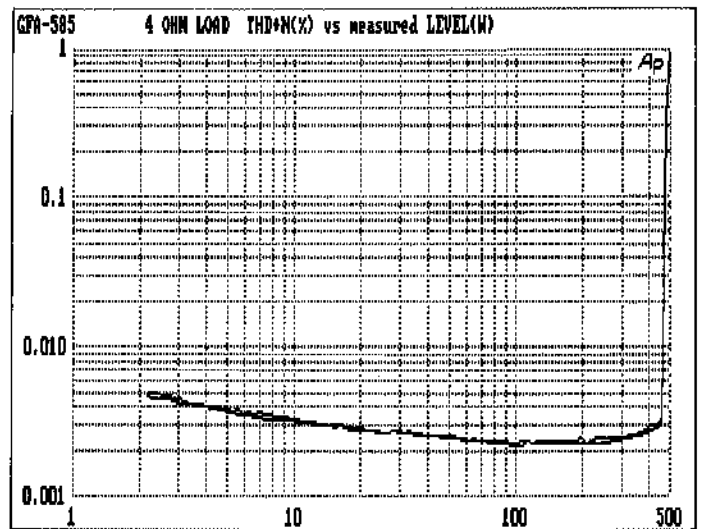
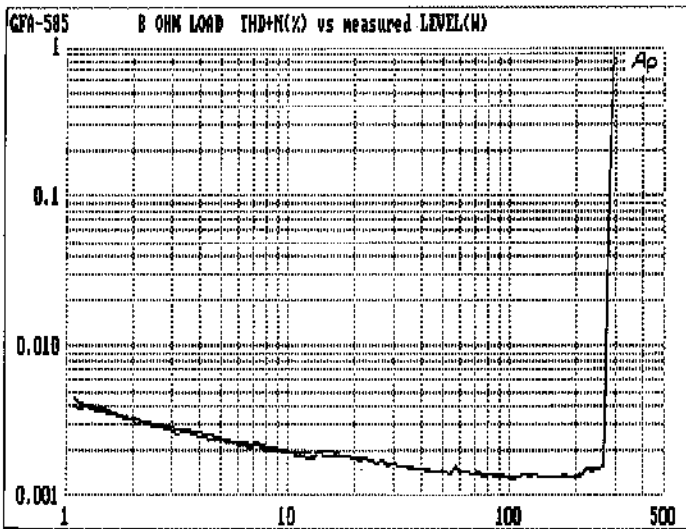
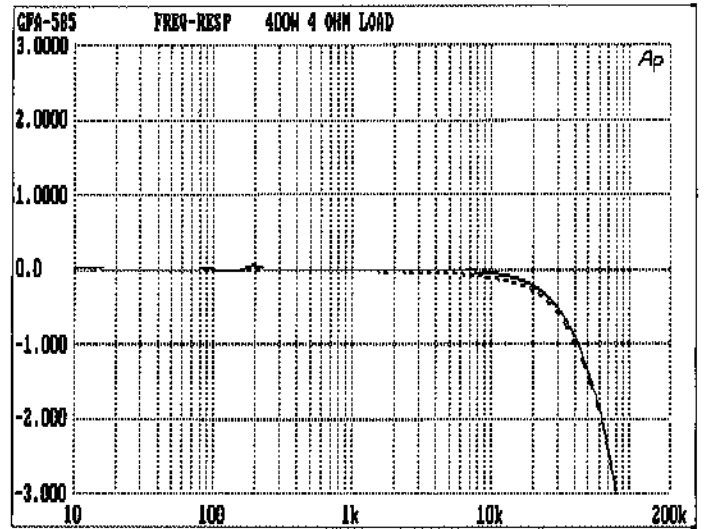
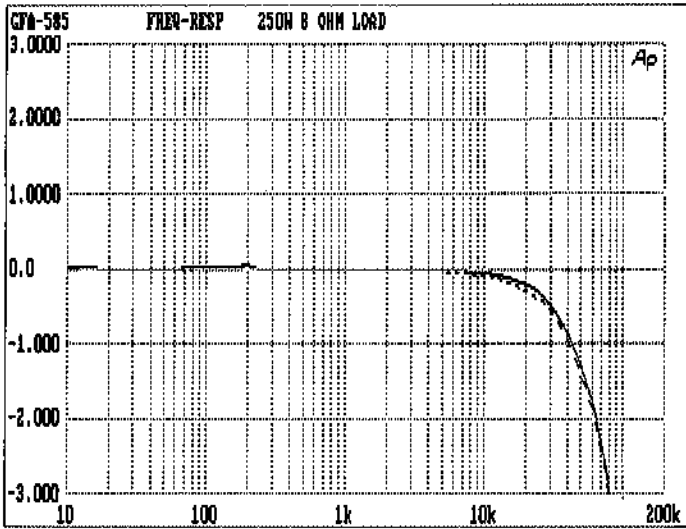

GFA-585 SPECIFICATIONS

Power Rating (To FTC Requirements)

250 watts continuous average power into 8 ohms at any frequency between 20Hz and 20kHz with both channels driven at less than 0.02% THD.
 400 watts continuous average power into 4 ohms at any frequency between 20Hz and 20kHz with both channels driven at less than 0.02% THD.*

* With fan option installed.

IM Distortion (SMPTE)

1 watt to 250 watts into 8 Ohms $\leq 0.005\%$
 1 watt to 400 watts into 4 Ohms $\leq 0.005\%$

IM Distortion (CCIF, Any Combination from 4kHz to 20kHz)

250 watts into 8 Ohms $\leq 0.002\%$
 400 watts into 4 Ohms $\leq 0.003\%$

THD + Noise at 250 Watts into 8 Ohms

20Hz 0.002%
 1kHz 0.002%
 10kHz 0.004%
 20kHz 0.010%

THD + Noise at 400 Watts into 4 Ohms

20Hz 0.003%
 1kHz 0.003%
 10kHz 0.007%
 20kHz 0.015%

Frequency Response @ 1 Watt into 8 Ohms

10Hz to 20kHz +0, -0.5dB

Power Bandwidth (-3dB) 0.7Hz to 80kHz

Dynamic Headroom into 4 Ohms 2.1dB

Signal-to-Noise Ratio, "A" Weighted

250 watts into 8 Ohms $\geq 110\text{dB}$

Gain 27dB

Input Impedance 50,000 ohms

Input Sensitivity

250 watts into 8 Ohms 2V rms
 1 watt into 8 Ohms 130mV rms

Damping Factor 20Hz to 20kHz ≥ 600

Rise Time

5kHz, 120V peak-to-peak square wave, 20% to 80% 2.9us

Semiconductor Complement 72 transistors, 11 zener diodes,
 31 diodes, 2 ICs, 2 diode bridges

Power Consumption (Continuous, Both Channels Driven)

Quiescent 90VA
 Maximum 1800VA
 250 watts into 8 Ohms 750VA
 400 watts into 4 Ohms 1300VA

GENERAL

Power (available in 220V or 240V on special order) 120VAC/50-60Hz

Chassis Dimensions 8"(203mm) x 17"(432mm) x 12³/₁₆"(310mm)

Maximum Dimensions 8³/₈"(213mm) x 17"(432mm) x 12³/₁₆"(310mm)

Weight 45 lbs. (20.5kg)

Weight, Packed 49 lbs. (22.5kg)

**GFA-585
RIGHT CHANNEL AUDIO INPUT/DRIVER PCB ASSEMBLY**

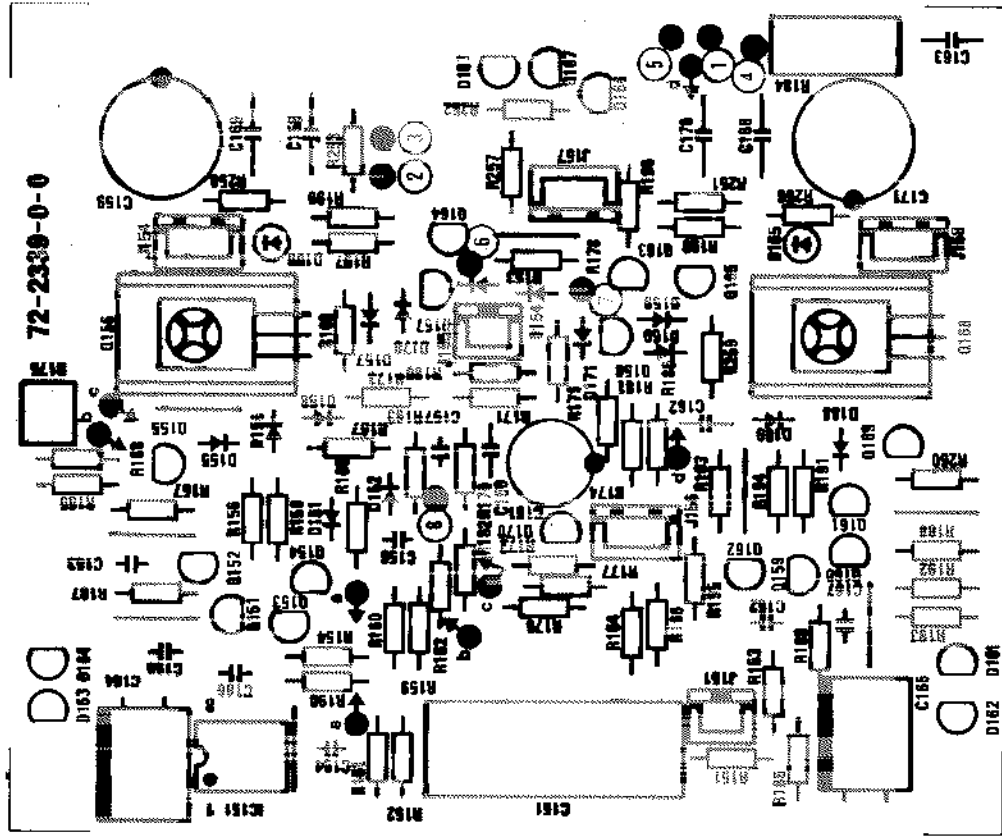

**GFA-585
LEFT CHANNEL AUDIO INPUT/DRIVER PCB ASSEMBLY**

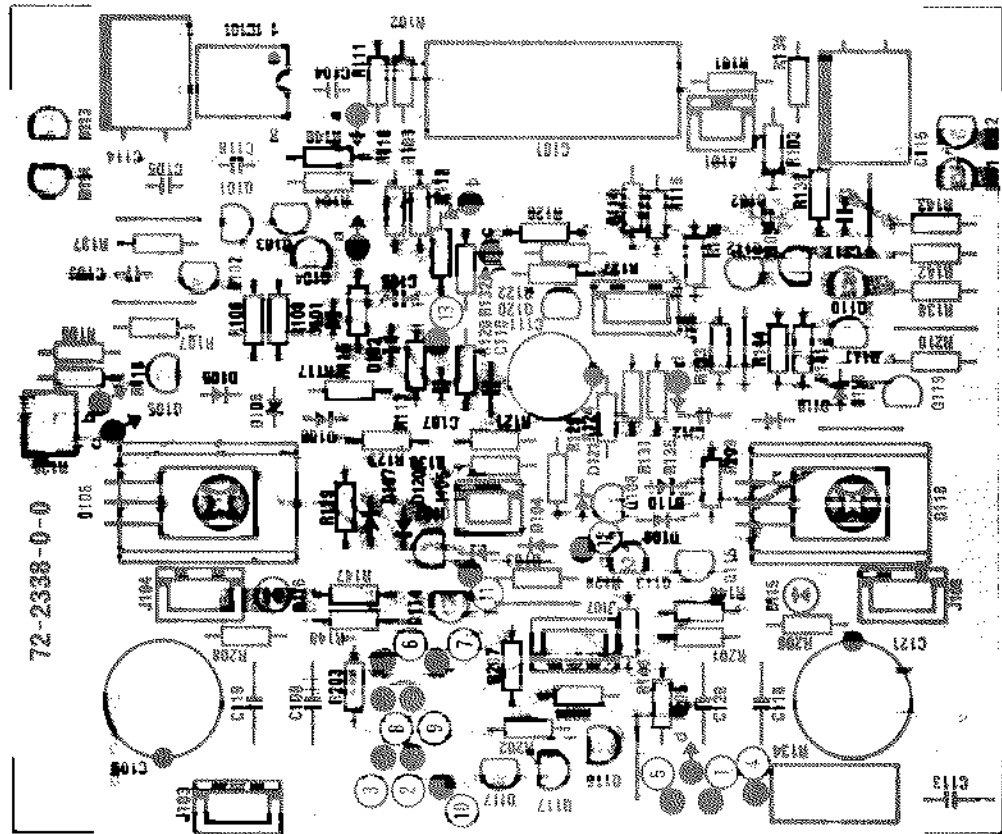

GFA-585 AC INPUT/BIAS TIME DELAY PCB

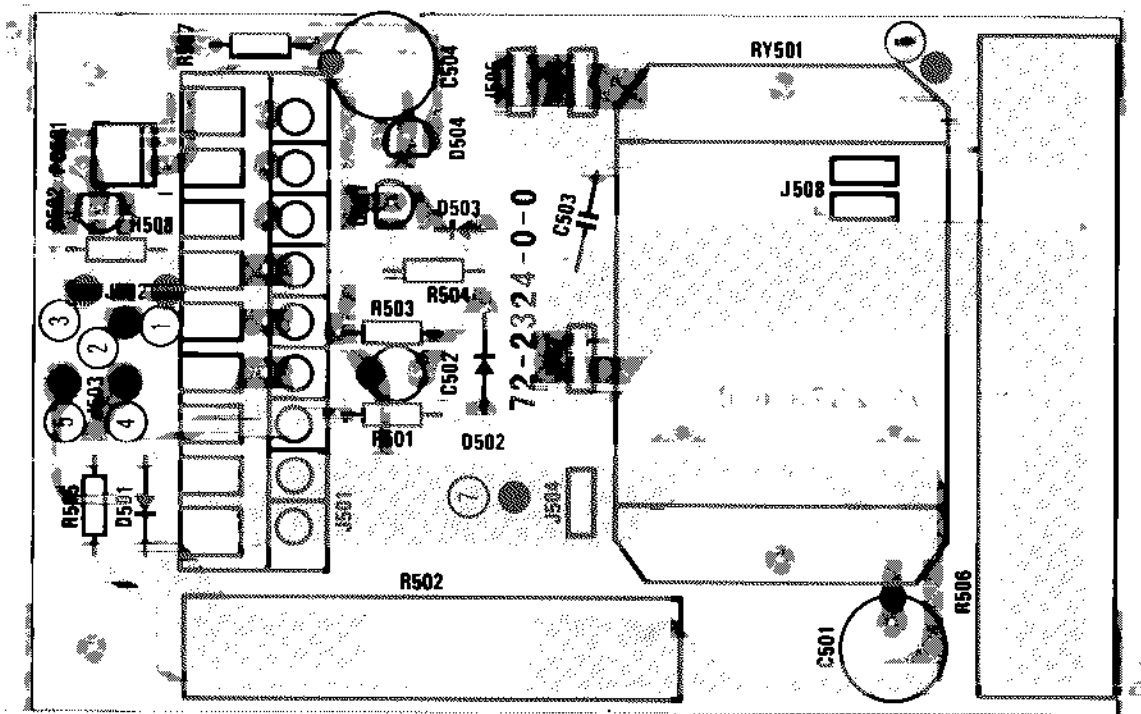

GFA-585 FILTER CAPACITOR PCB ASSEMBLIES

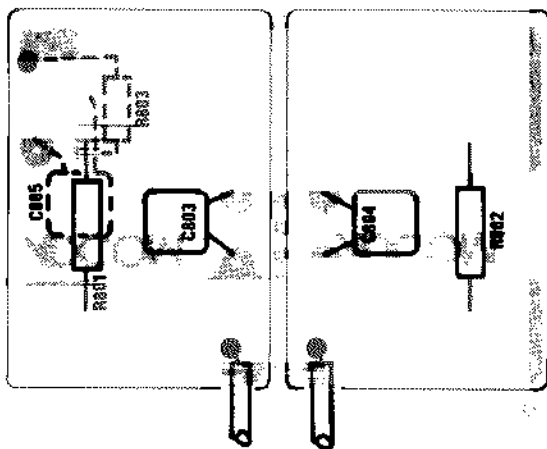

GFA 585 POWER SUPPLY PCB ASSEMBLY FOR OPTIONAL FAN MOTOR, ISSUE "B"

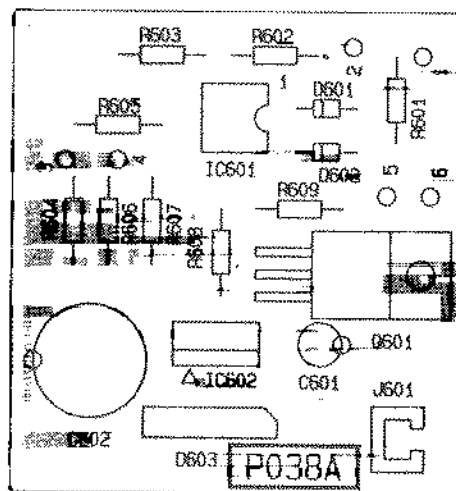

GFA-585 RIGHT/LEFT NPN OUTPUT PCB

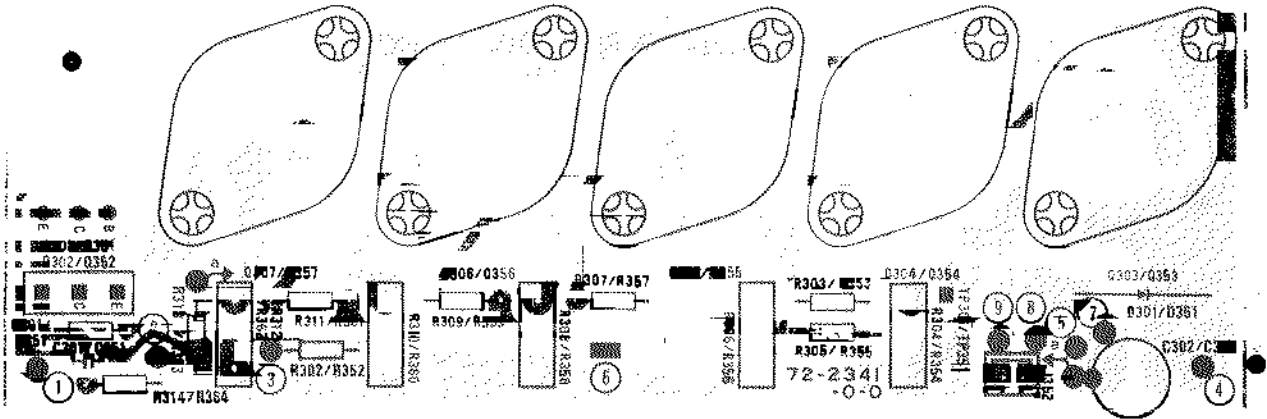

GFA-585 RIGHT/LEFT PNP OUTPUT PCB

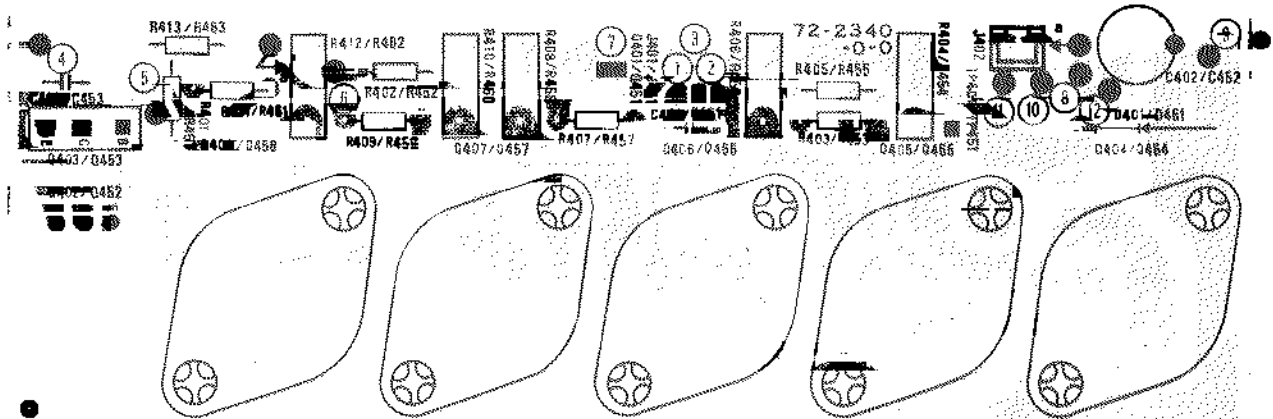

GFA-585 OPTIONAL FAN MOTOR, ISSUE "B"

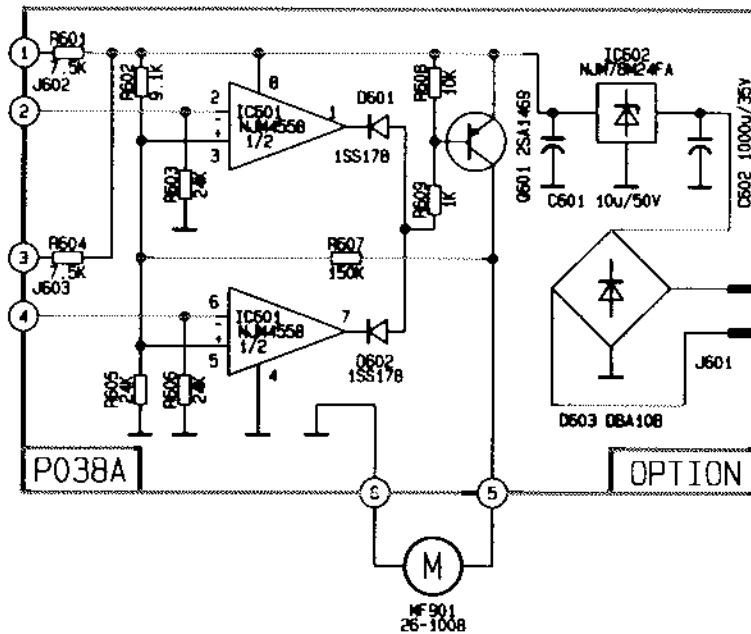

SCHEMATIC DIAGRAM GFA-585

15

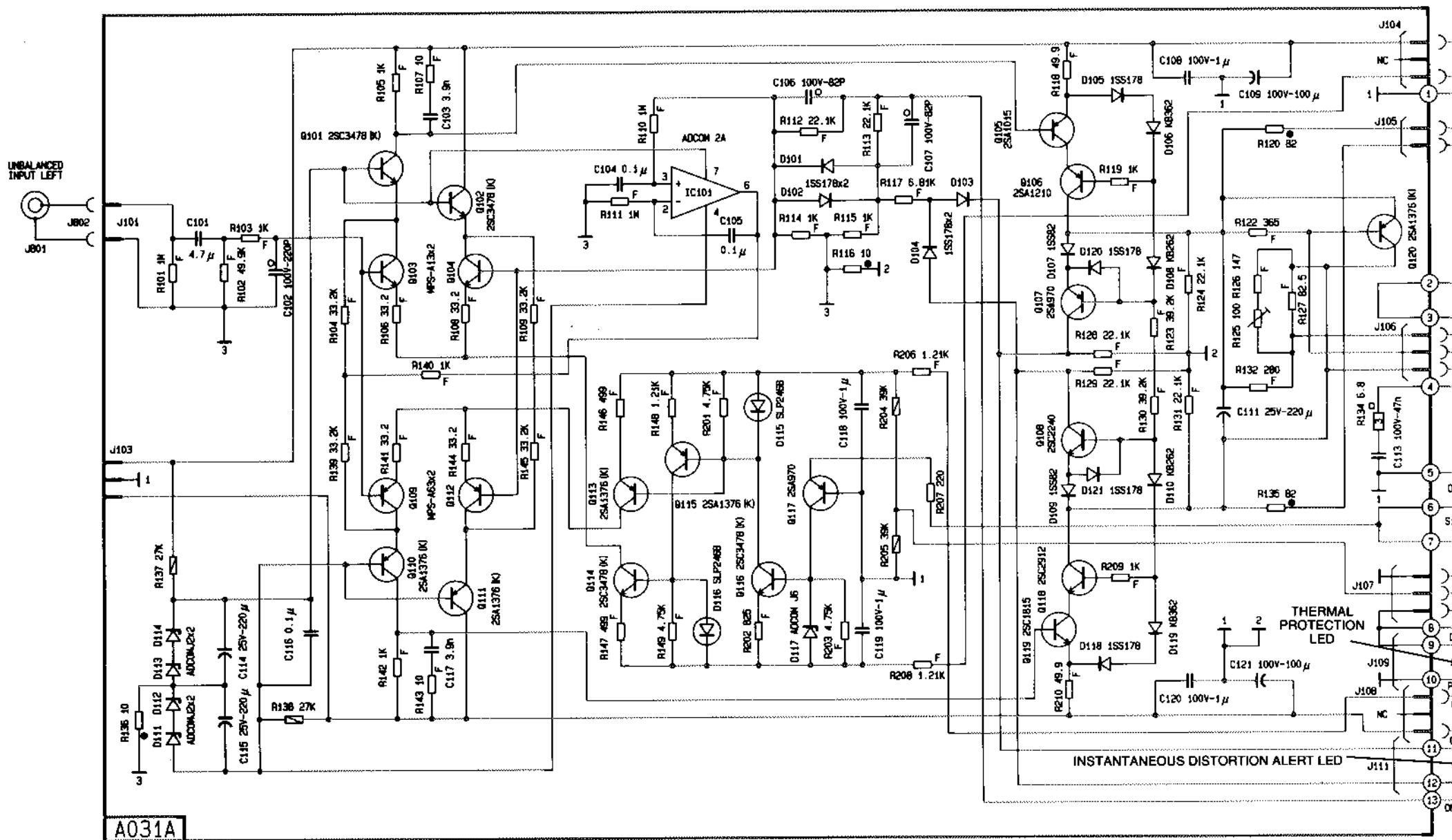

NOTE: ADCOM RESERVES THE RIGHT TO MODIFY CIRCUITRY AND/OR CHANGE COMPONENTS TO UPGRADE PRODUCT WITHOUT PRIOR NOTICE OR INCURRING ANY LIABILITY

NOTE 1, FUSES

	220V	240V
BUSSMAN	AGC-8/250V	AGC-8/250V
LITTELFUSE	3AG312008/250V	3AG312008/250V
BEL	NONE	NONE
SOC	CES14-8A/250V	CES14-8A/250V

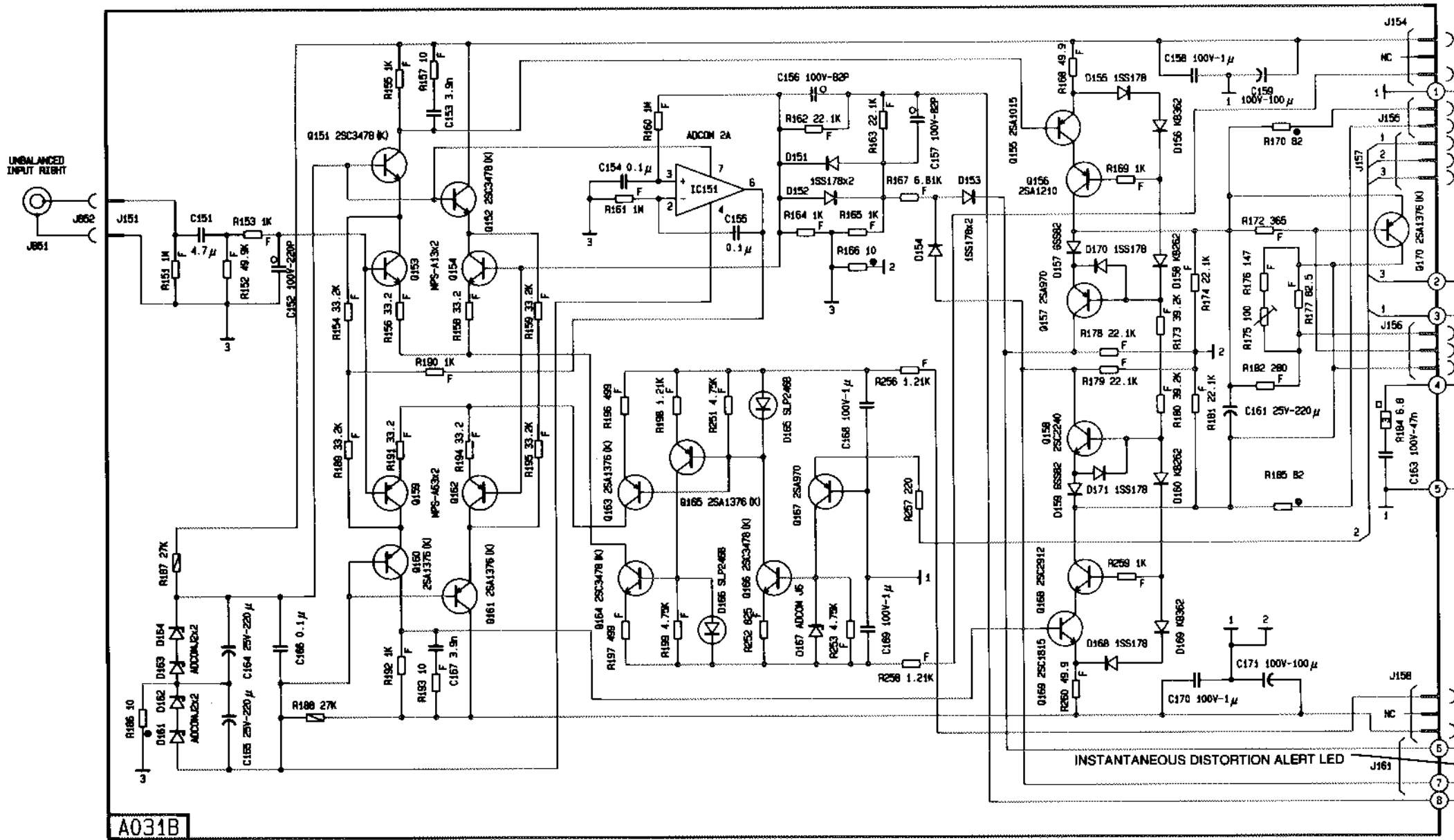

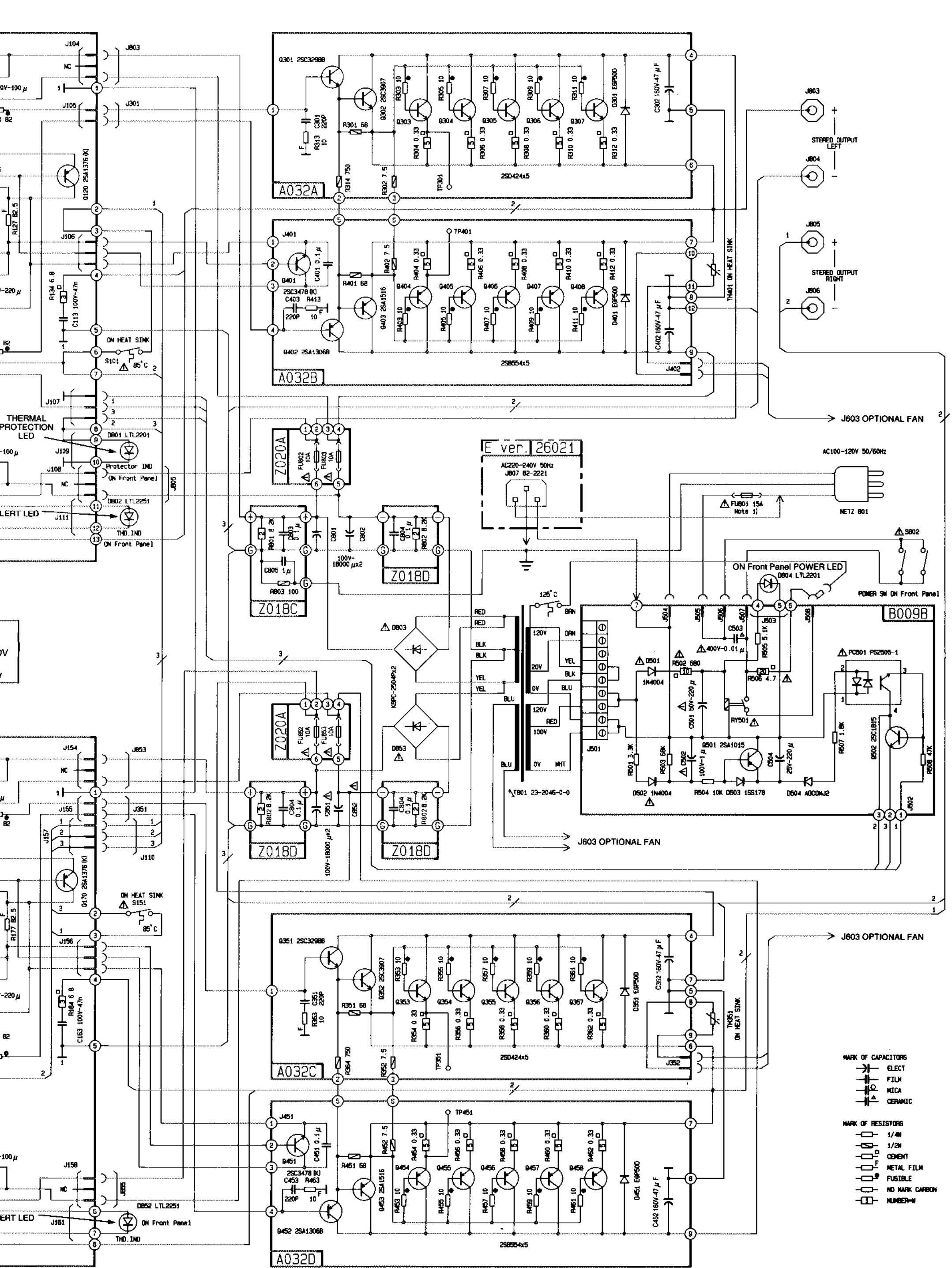

MARK OF CAPACITORS
 ELECT
 FILM
 MICA
 CERAMIC

MARK OF RESISTORS
 1/4W
 1/2W
 CEMENT
 METAL FILM
 FUSIBLE
 NO MARK CARBON
 NUMBER-W