



icon
SERIES



SERVICE MANUAL

Publication: AP3319

CONTENTS

Introduction, Service and Technical Support.....	3
The icon series & Options.....	4
Specifications and Connections.....	5
Opening up the DL1000 console.....	6
Opening up the DP1000 console.....	7
Removing the DL1000 Power Supply circuit board assembly.....	8
Removing the DL1000 MIDI circuit board assembly.....	9
Removing the DP1000 Amplifier circuit board assembly.....	10
Removing the DP1000 Amplifier circuit board assembly continued.....	11
Removing the DP1000 Transformer and Transformer Mains wiring.....	12
Removing the DP1000 MIDI circuit board assembly.....	13
Removing the CPU circuit board assembly.....	14
Removing the LCD module.....	15
Removing the Audio circuit board assembly.....	16
Removing the Fader, Keypad circuit board assembly and Rubber Keypad.....	17
Ordering an icon console, options, manuals and support documentation.....	18
Ordering an Assembly.....	19
Ordering a Spares Kit.....	20-22
DL1000 Front & Rear Panel drawings.....	23
DP1000 Front & Rear Panel drawings.....	24
icon Block Diagram.....	25
DL1000 Power Supply Circuit Board component Ident.....	AG3446
DL1000 Power Supply Circuit Diagram.....	C3446
icon MIDI Circuit Board component Ident.....	AG3280
icon MIDI Circuit Diagram.....	C3280
DP1000 Amplifier Circuit Board component Ident.....	AG3297
DP1000 Amplifier Circuit Diagram Pages 1 to 3.....	C3297
icon CPU Circuit Board component Ident.....	AG3292
icon CPU Circuit Diagram Pages 1 to 7.....	C3292
icon Audio Circuit Board component Ident.....	AG3293
icon Audio Circuit Diagram Pages 1 to 4.....	C3293
icon Fader Circuit Board component Ident.....	AG3279
icon Fader Circuit Diagram.....	C3279
icon Keypad Circuit Board component Ident.....	AG3278
icon Keypad Circuit Diagram Pages 1 to 2.....	C3278
DL1000 Mains Circuit Board component Ident.....	AG3298
DL1000 Mains Circuit Diagram.....	C3298

**SCHEMATICS PUBLISHED
SEPARATELY**

**PSU SCHEMATICS ONLY
SHOWN IN
SERVICE /DISTRIBUTOR
VERSION**

Warning to the Service Engineer

Allen & Heath warns that any unauthorised changes or modifications to the **icon** unit may invalidate the legal compliance of the unit and could void the user's authority to operate the equipment.

icon Service Manual AP3319 Issue 1. Copyright © 1999 Allen & Heath. All rights reserved.

MANUFACTURED IN ENGLAND BY:

ALLEN & HEATH
 Kernick Industrial Estate
 Penryn, Cornwall, TR10 9LU. UK
<http://www.allen-heath.com>

ALLEN & HEATH AGENT:



Introduction

The information presented in this section of the manual is intended for competent technical personnel to carry out service and product support for the **icon** series. We assume that the reader is familiar with the related electronic theory and audio terminology, and is able to carry out basic servicing, fault-finding and repair of digital audio equipment of this type. Service personnel should also be familiar with audio systems, mains earthing and power requirements, as well as handling precautions.

For information on the installation, operation and application of the icon series please refer to the User Guide.

Whilst we believe the information in this manual to be reliable we do not assume responsibility for inaccuracies. We also reserve the right to make changes in the interest of further product development.

Service and Technical Support

Under normal operating conditions the **icon** does not require user maintenance or internal calibration. Any service work required should be carried out by qualified technical personnel only.

We are able to offer further product support through our world-wide distribution network. To help us provide an efficient service please quote the unit serial number, the date and place of purchase in any communication regarding this product.

SAFETY WARNING!

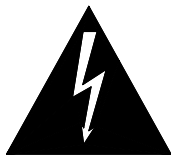

Mains electricity is dangerous and can kill. Mains voltage is present within the console power supply unit.

The internal power supply unit contains no serviceable components and must be replaced as a complete unit if a failure occurs.

Do not remove the power supply cover with mains electricity connected. To ensure your safety, mains earth is connected to the chassis through the power lead. Do not remove this mains earth connection.

To avoid the risk of fire, replace the mains fuse only with the correct value and type as indicated on the power supply unit.



WARNING: There is danger of explosion if the battery is incorrectly replaced.

Replace the battery with an Allen & Heath recommended part. Using a different battery, recharging or disassembling the battery may present a danger due to fire or explosion.

Dispose of used batteries promptly according to the manufacturer's instructions. Keep all batteries away from children.



IMPORTANT STATIC ELECTRICITY PRECAUTIONS

Many of the components in the icon are extremely sensitive to static electricity. The following procedures reduce the possibility of damaging components:

- 1) Before handling any components or touching anything inside the unit, discharge your body's static electric charge by touching a grounded (earthed) surface. Wear a grounding wrist strap if one is available.**
- 2) Do not remove parts from their antistatic containers or bags until you are ready to install them. When removing circuit boards (PCBs) or ICs from a unit, immediately place them in an antistatic bag.**
- 3) When handling PCBs, hold them by their edges and avoid touching the circuitry.**
- 4) Do not slide PCBs or ICs over any surface.**
- 5) Avoid having plastic, vinyl and foam in your work area.**
- 6) Limiting your movements during service work reduces static electricity.**

The ICON Series

Powered and Un-Powered Digital Live Consoles

- DL1000 10 Input Un-Powered Digital Live Mixing Console
- DP1000 10 Input Powered Digital Live Mixing Console

Options

- DL1000-RK 19" Rack Mount Kit for both DL1000 and DP1000 consoles
- AP3521 Icon Carry bag

Flightcasing the console

If the console is to be regularly moved we recommend that it is installed in a foam-lined flightcase. At all times avoid applying excessive force to any knobs or connectors. Do not obstruct the ventilation slots or position the icon where the air-flow required for ventilation is impeded.

Dimensions for flightcasing the console are shown below: (All dimensions in mm)

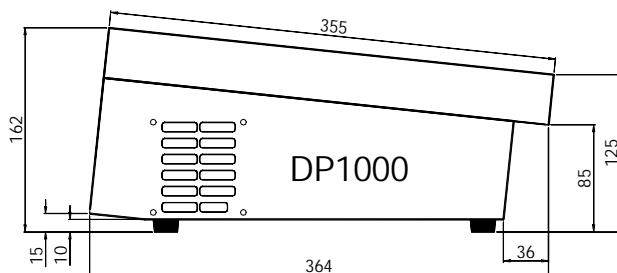
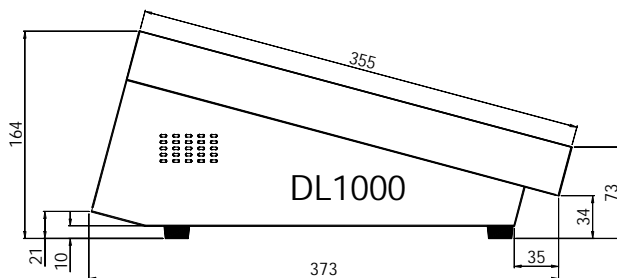
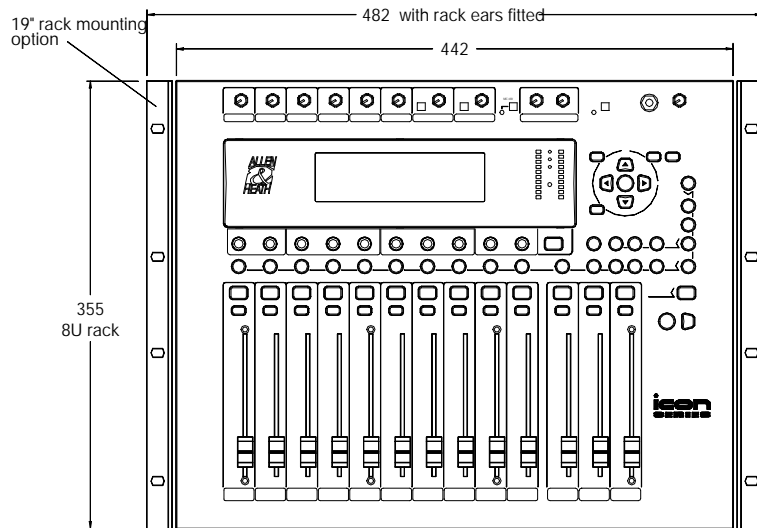

DIMENSIONS

Unpacked

..... Width
 DL1000 442 (17")
 DP1000 442 (17")

..... Depth
 DL1000 373 (15")
 DP1000 364 (14")

..... Height
 DL1000 164 (6")
 DP1000 162 (6")

..... Weight (kg)
 DL1000 9 (20lbs)
 DP1000 18 (40lbs)

Packed

..... Width
 DL1000 550 (22")
 DP1000 550 (22")

..... Depth
 DL1000 505 (20")
 DP1000 505 (20")

..... Height
 DL1000 300 (12")
 DP1000 300 (12")

..... Weight (kg)
 DL1000 11 (24lbs)
 DP1000 20 (44lbs)

Specifications

0 dBu = 0.775 Volts rms 0 dBV = 1 Volt rms

HEADROOM: +18dBu
MAX OUTPUT: JACK +18dBu 2kohm max load
LR (DL1000 ONLY) +22dBu 2kohm max load
PHONO +10dBu 2kohm max load
METERS: A, B..... peak reading 10 segment LED
FREQUENCY RESPONSE referred to 1kHz @ 0dBu:
 Any input to any output 20Hz to 20kHz +0/-1dB
DISTORTION: THD+Noise @ +14dBu 1kHz
 Input to Output..... <0.008%
CMRR Common Mode Rejection @ 1kHz
 Mic (+40dB)..... >80dB

CROSSTALK: Referred to driven channel @ 1kHz
 Inter channel < -90dB
NOISE: Measured rms 22Hz to 22kHz
 Mic input EIN (150 ohm source)..... < -127dB
POWER SUPPLY: 100 to 240V AC @ 50/60Hz
 Internal, autosensing AC mains input (DL1000)
 Internal, linear regulated AC mains input (DP1000)
 Power consumption:.....35W max (DL1000)
1000W max (DP1000)
 Mains Fuse rating 100-240VAC: T500mA 20mm (DL1000)
 Mains Fuse rating 100-120VAC:T10A 20mm (DP1000)
 Mains Fuse rating 220-240VAC:T5A 20mm (DP1000)

Connections

INPUTS:
 Mic in..... XLRpin 2 hot, 3 cold, balanced 2k ohmvariable -55 to -8dBu
 Line in TRS jacktip hot, ring cold, balanced >30k ohmsvariable -31 to +16dBu
 Stereo Ch Mic in..... XLRpin 2 hot, 3 cold balanced 2k ohmvariable -55 to -8dBu
 Stereo Ch Line in..... TRS jacktip hot, ring cold, balanced >30k ohmsvariable -31 to +16dBu
 Stereo Ch Phono in RCA PHONOunbalanced >30k ohmsvariable -31 to +16dBu

OUTPUTS:
 Aux and foldback out TRS jack.....tip hot, ring cold, impedance balanced..... <75 ohm 0dBu
 A+B Slave out..... TRS jack.....tip hot, ring cold, impedance balanced..... <75 ohm 0dBu
 L&R out..... TRS jack.....tip hot, ring cold, impedance balanced..... <75 ohm 0dBu
or RCA PHONO..... unbalanced 600 ohm -10dBV
 Mono out..... TRS jack.....tip hot, ring cold, impedance balanced..... <75 ohm 0dBu
 A&B out (DL1000 only) ..XLRpin 2 hot, 3 cold, balanced <75 ohm 0dBu
 Phones out TRS jack.....tip left, ring rightfor stereo headphones 30 to 600 Ohms

Opening up the DL1000 Console

Before beginning any service work, remove all power to the unit and disconnect any signal cables where necessary. Adopt static electricity working procedures when carrying out service work. Ensure adequate lighting and use the correct tools.

- 1) Remove all 12 screws fixing the top panel onto the base retaining the 3 shake-proof washers from the rear screws.
- 2) Carefully lift the top panel away from the base as the top panel is connected via IDC harnesses.
- 3) Remove the 2 IDC Harnesses from the MIDI and Power Supply PCB respectively (see fig.1)

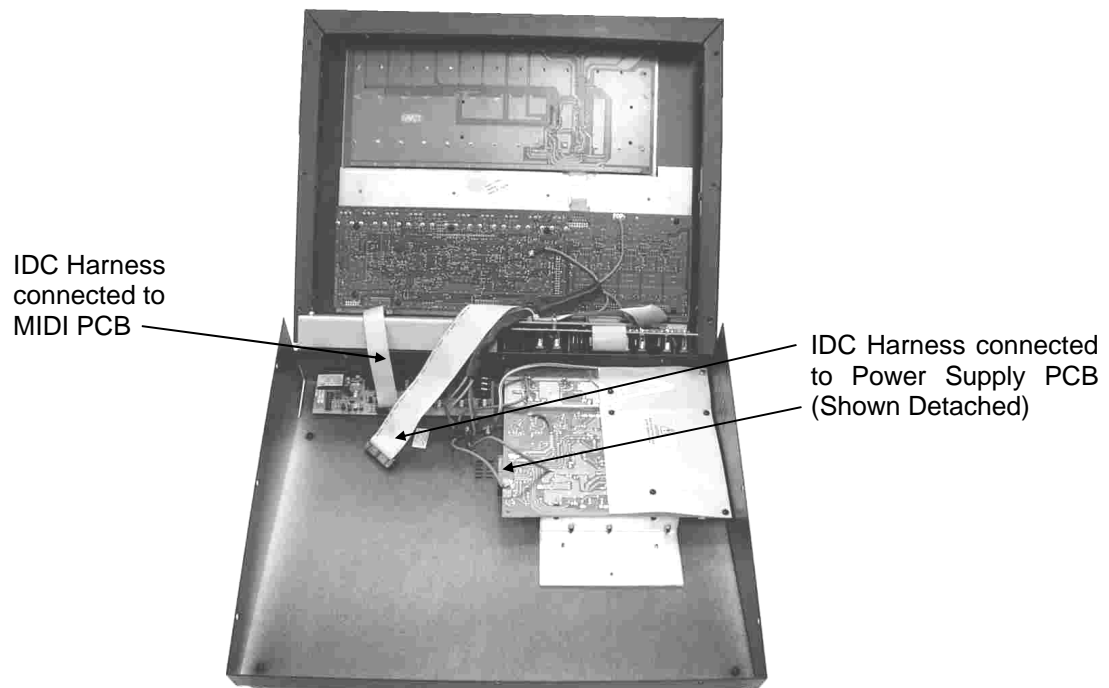

fig.1

- 4) Remove the M3 nylock nut and earth wires (see fig.2)
- 5) Detach the front panel from the base.

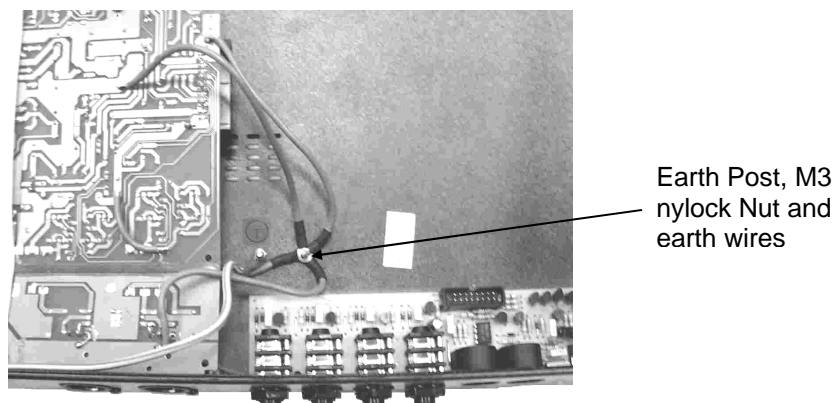

fig.2

Note: When Audio testing the unit make sure that the front panel and base are fixed with a chassis screw at the rear of the console.

Opening up the DP1000 Console

Before beginning any service work, remove all power to the unit and disconnect any signal cables where necessary. Adopt static electricity working procedures when carrying out service work. Ensure adequate lighting and use the correct tools.

- 1) Remove all 12 screws fixing the top panel onto the base retaining the 3 shakeproof washers from the rear screws.
- 2) Carefully lift the top panel away from the base as the top panel is connected via IDC harnesses.
- 3) Remove the 2 IDC Harnesses from the MIDI and Amplifier PCB respectively (see fig. 3)
- 4) Remove the M3 nylock nut and earth wires (see fig.3)
- 5) Detach the front panel from the base.

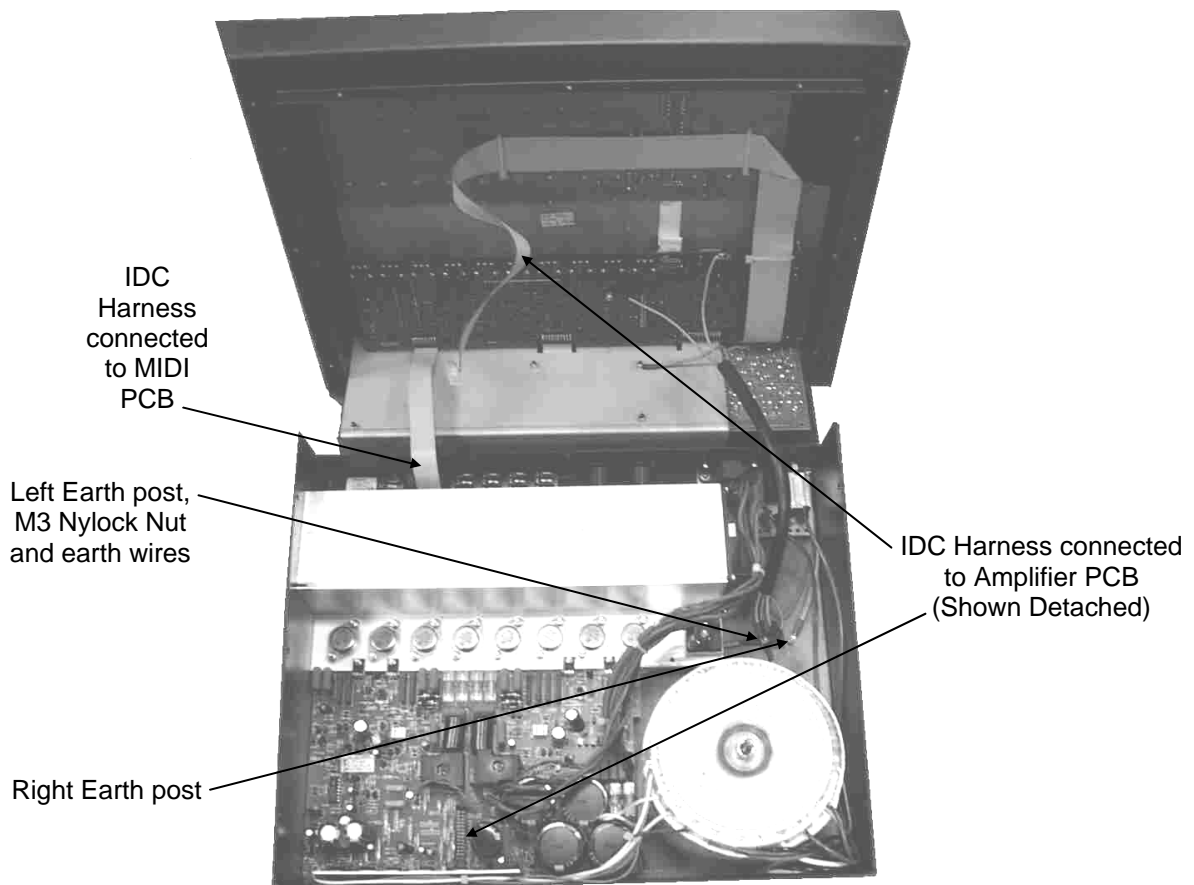

fig.3

Note: When Audio testing the unit make sure that the front panel and base are fixed with a chassis screw at the rear of the console.

Removing the MIDI PCB (DL1000)

Before beginning any service work, remove all power to the unit and disconnect any signal cables where necessary. Adopt static electricity working procedures when carrying out service work. Ensure adequate lighting and use the correct tools. Access to the MIDI circuit board can only be achieved once the console has been opened (see 'Opening up the DL1000 console').

- 1) Remove the 4 plastic jack sockets from the rear of the console (see fig.5)
- 2) Remove the 2 RS232 nuts (see fig.5)

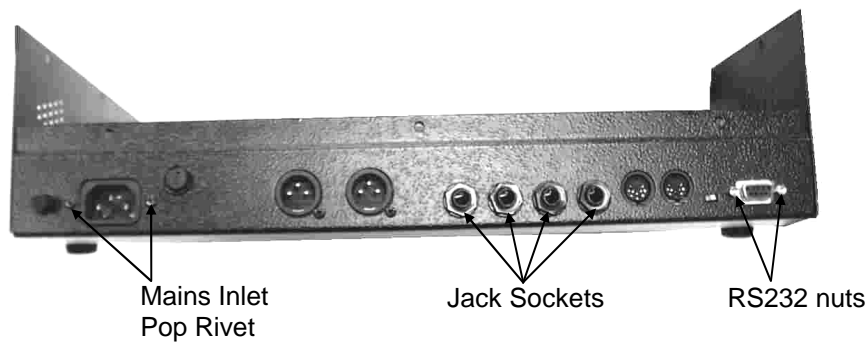

fig.5

- 3) Remove the connecting earth wire to the MIDI circuit board from the earth post (see fig.6)

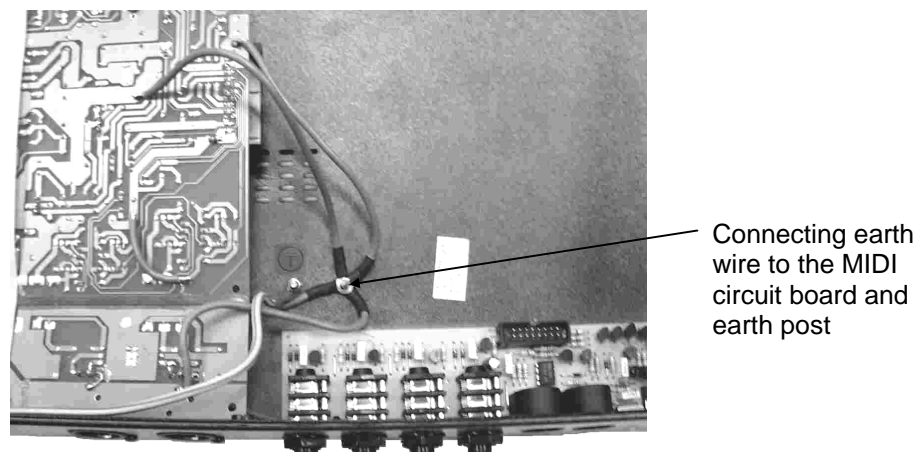

fig.6

- 4) The MIDI circuit board assembly can now be removed from the console.

When all service work is complete, remove all debris such as solder, component legs and wire clippings from inside the unit and check your work carefully before re-assembly. To refit the MIDI circuit board assembly, follow the above procedure in reverse order. Make sure the Earth wire is connected to the earth post. Test for correct operation.

Removing The Amplifier PCB (DP1000)

Before beginning any service work, remove all power to the unit and disconnect any signal cables where necessary. Adopt static electricity working procedures when carrying out service work. Ensure adequate lighting and use the correct tools. Access to the Amplifier circuit board can only be achieved once the console has been opened (see 'Opening up the DP1000 console').

- 1) Turn the base onto its side (supporting if necessary) to reveal underside. Referring to fig.7 remove the 5 screws from the base.

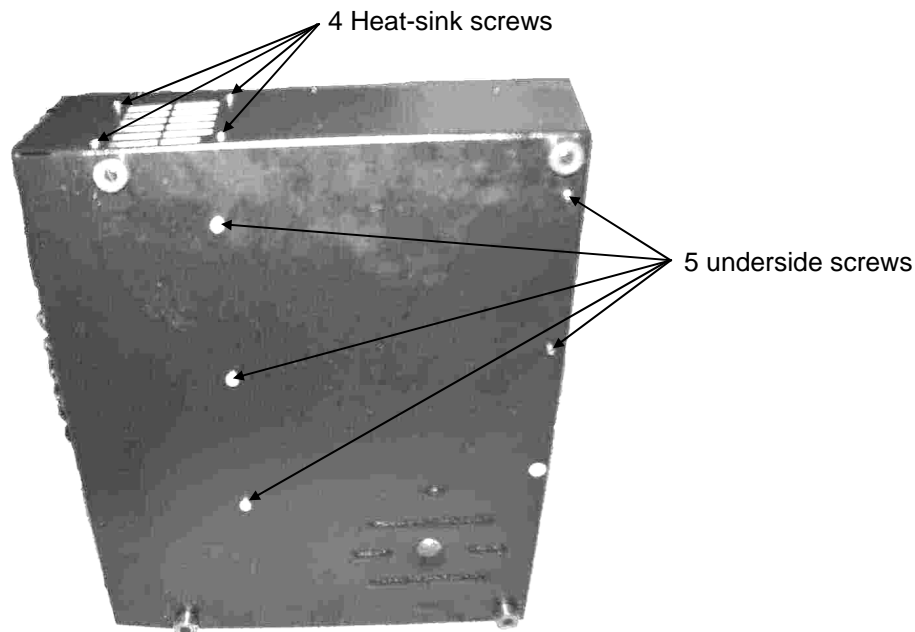

fig.7

- 2) Place the unit so that it is upright again. Referring to fig.7 remove the 4 heat-sink screws from the side of the console.
- 3) Using Long-nose pliers, squeeze the joining pillar in the Amplifier PCB (see fig.8) to release it from the PCB.

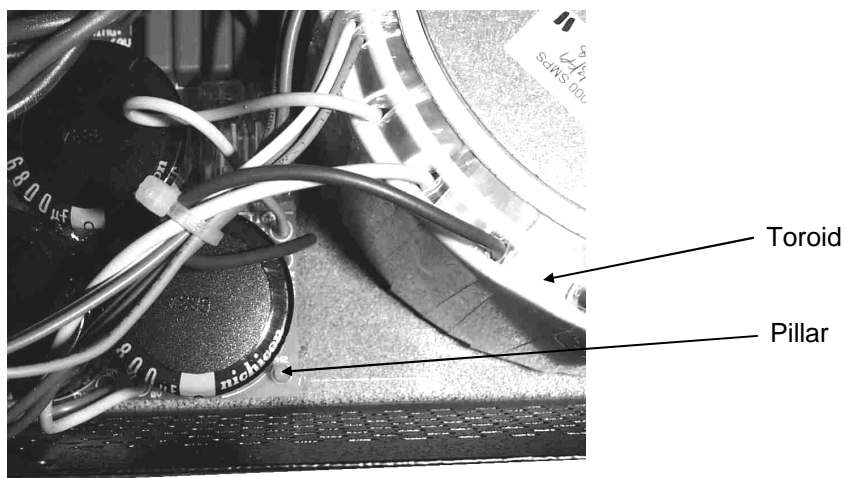

fig.8

Continued on next page.

Removing The Amplifier PCB (DP1000) cont.

- 4) Remove the plastic snap-in rivets from the rear Speakon® connectors (see fig.9)

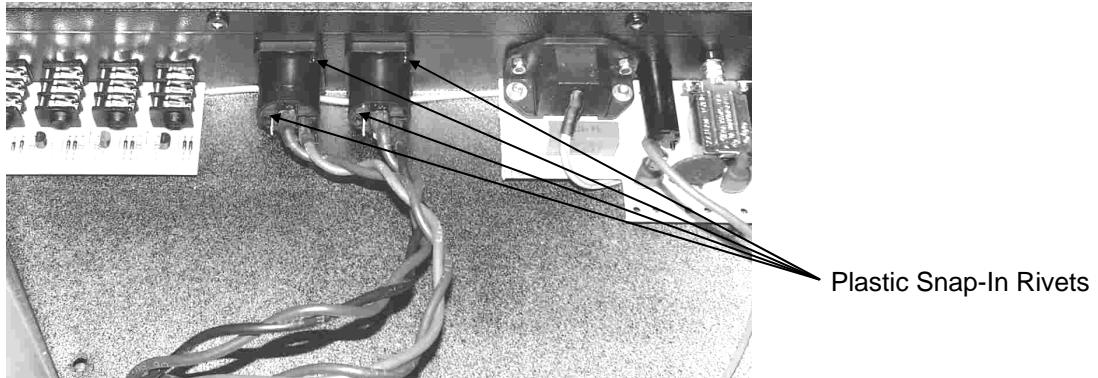

fig.9

- 5) The Amplifier circuit board assembly and connecting Heat-sink can now be removed from the console, but remains attached to the transformer and earth post.
- 6) If replacing the Amplifier circuit board assembly then de-solder the transformer wires and green earth wire from the left earth post (see fig.3) at the PCB.

When all service work is complete, remove all debris such as solder, component legs and wire clippings from inside the unit and check your work carefully before re-assembly. To refit the Amplifier circuit board assembly, follow the above procedure in reverse order. Make sure all harnesses are aligned and plugged on. Test for correct operation.

Torque measurement for power components

When replacing any of the 8 power transistors seated on the heat-sink, it is necessary to tighten the fixing nuts using a torque wrench to **1N/m (one Newton metre)**.

Removing the MIDI PCB (DP1000)

Before beginning any service work, remove all power to the unit and disconnect any signal cables where necessary. Adopt static electricity working procedures when carrying out service work. Ensure adequate lighting and use the correct tools. Access to the MIDI circuit board can only be achieved once the Amplifier circuit board assembly is removed (see 'Removing the Amplifier Circuit Board Assembly').

- 1) Remove the 4 plastic jack sockets from the rear of the console (see fig.12)
- 2) Remove the 2 RS232 nuts (see fig.12)

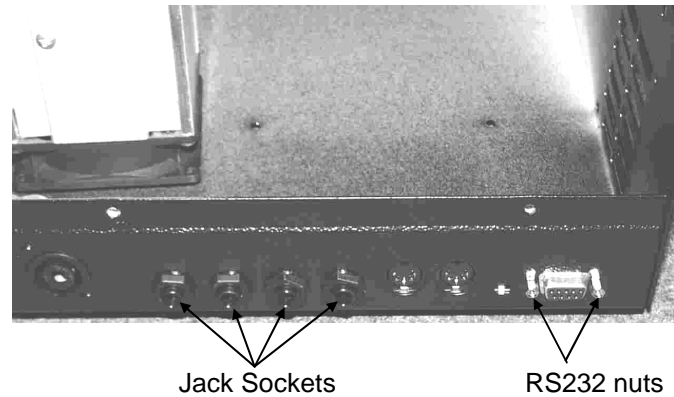

fig.12

- 3) Remove the connecting earth wire to the MIDI circuit board from the left earth post (see fig.3)
- 4) The MIDI circuit board assembly can now be removed from the console.

When all service work is complete, remove all debris such as solder, component legs and wire clippings from inside the unit and check your work carefully before re-assembly. To refit the MIDI circuit board assembly, follow the above procedure in reverse order. Make sure the Earth wire is connected to the earth post. Test for correct operation.

Removing the CPU PCB

Before beginning any service work, remove all power to the unit and disconnect any signal cables where necessary. Adopt static electricity working procedures when carrying out service work. Ensure adequate lighting and use the correct tools. Access to the CPU circuit board can only be achieved once the console has been opened (see 'Opening up the DL/DP1000 console')

- 1) Remove the 10 rotary encoder knob caps (see fig.13)

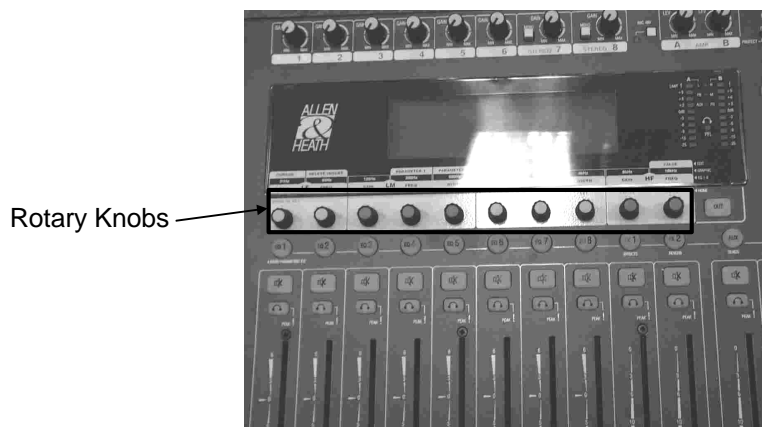

fig.13

- 2) Remove the 4 nuts from the Audio Shield (see fig.14), retaining the crinkle washer. Remove Audio shield.
- 3) Remove the 7 screws from the CPU circuit board (see fig.14)
- 4) Remove the 2 connecting IDC Harnesses from the CPU circuit board and cut the connecting cable tie (see fig.14)

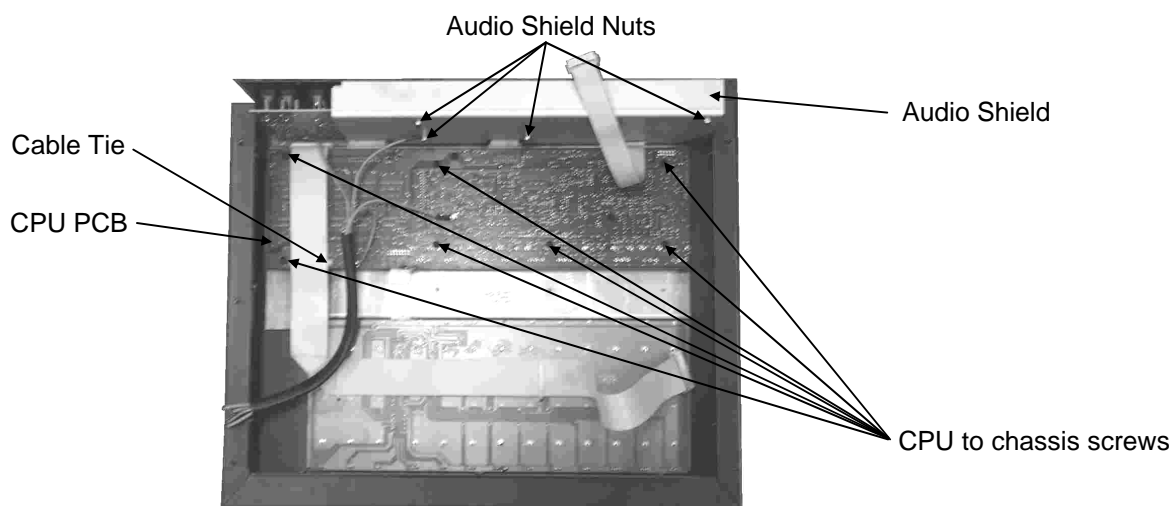

fig.14

- 5) Detach all other cables and harnesses from the CPU circuit board (note: the CPU to Fader IDC is siliconed on at the CPU circuit board, the silicone bond will have to be broken to release the CPU to Fader IDC)
- 6) The CPU circuit board assembly can now be removed from the console.

When all service work is complete, remove all debris such as solder, component legs and wire clippings from inside the unit and check your work carefully before re-assembly. To refit the CPU circuit board assembly, follow the above procedure in reverse order. Make sure all harnesses are aligned and plugged on. Test for correct operation.

Removing the LCD Module

Before beginning any service work, remove all power to the unit and disconnect any signal cables where necessary. Adopt static electricity working procedures when carrying out service work. Ensure adequate lighting and use the correct tools. Access to the LCD module can only be achieved once the CPU circuit board has been removed (see 'Removing the CPU PCB')

- 1) Remove the 3 screws attaching the CPU PCB onto the LCD module (see fig.15)

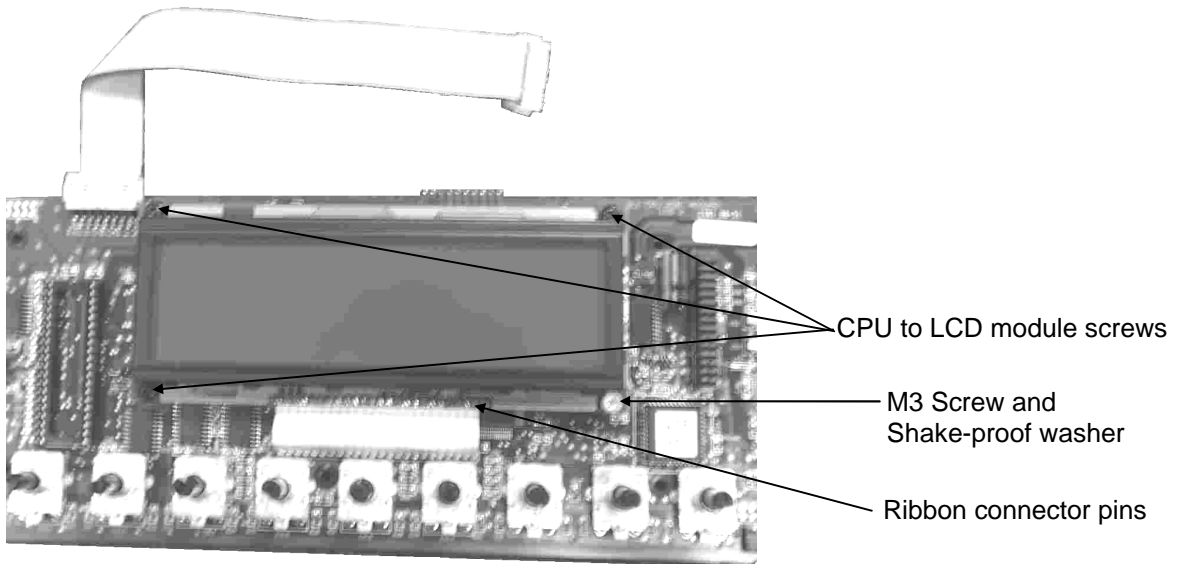

fig.15

- 2) Flip the CPU circuit board over and remove the M3 nylock nut, earth wire and then remove the M3 half-nut (see fig.16)

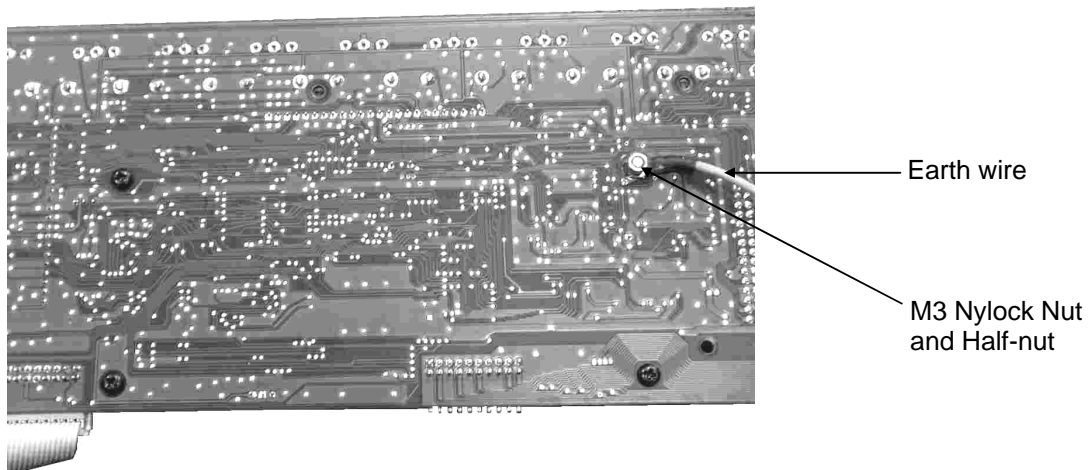

fig.16

- 3) Carefully de-solder the ribbon connector pins (see fig.15) and remove ribbon connector from the LCD module.
- 4) Retain the M3x25 screw with shake-proof washer and pillar once removed (see fig.15)
- 5) The LCD module can now be removed from the CPU circuit board assembly.

To refit the LCD module, follow the above procedure in reverse order. Make sure all harnesses are aligned and plugged on. Test for correct operation.

Removing the Audio PCB

Before beginning any service work, remove all power to the unit and disconnect any signal cables where necessary. Adopt static electricity working procedures when carrying out service work. Ensure adequate lighting and use the correct tools. Access to the Audio PCB can only be achieved once the console has been opened (see 'Opening up the DL/DP1000 console')

- 1) Remove the 4 nuts from the Audio Shield (see fig.17), retaining the crinkle washer. Remove Audio shield.

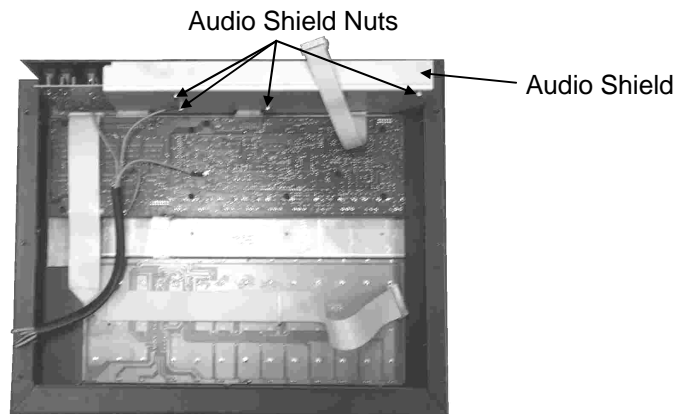

fig.17

- 2) Detach all harnesses from the Audio circuit board.
- 3) Remove the plastic jack sockets, XLR and Phono screws from the rear panel (see fig.18)



fig.18

- 4) Working from the top of the console remove the 11 knob caps. Once the knob caps have been removed then remove the pot nuts (see fig.19).

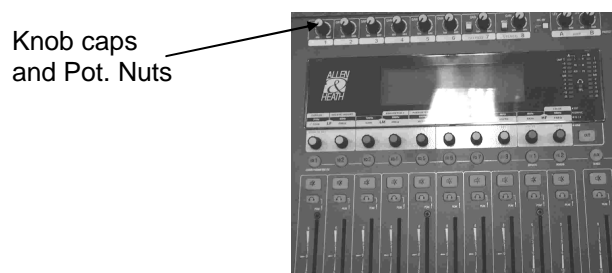

fig.19

- 5) The Audio PCB can now be removed from the console.

When all service work is complete, remove all debris such as solder, component legs and wire clippings from inside the unit and check your work carefully before re-assembly. To refit the Audio circuit board assembly, follow the above procedure in reverse order. Make sure all harnesses are aligned and plugged on. Test for correct operation.

Removing the Fader, Keypad PCB & Rubber Keypad

Before beginning any service work, remove all power to the unit and disconnect any signal cables where necessary. Adopt static electricity working procedures when carrying out service work. Ensure adequate lighting and use the correct tools. Access to the Fader PCB, Keypad PCB and Rubber Keypad can only be achieved once the CPU circuit board has been removed (see 'Removing the CPU PCB')

- 1) Remove all front panel gain pot. and fader knobs.
- 2) Remove the 8 fader screws from the front panel. Remove the Fader PCB.
- 3) Remove the 11 potentiometer nuts from the front panel.
- 4) Remove the plastic jack sockets from the rear panel by turning them 45deg anti-clockwise and then pull off by hand.
- 5) Remove the 11 screws from the rear panel. Remove the Audio PCB from the console.
- 6) Remove the 3 screws from the Keypad Bracket (see fig.20)

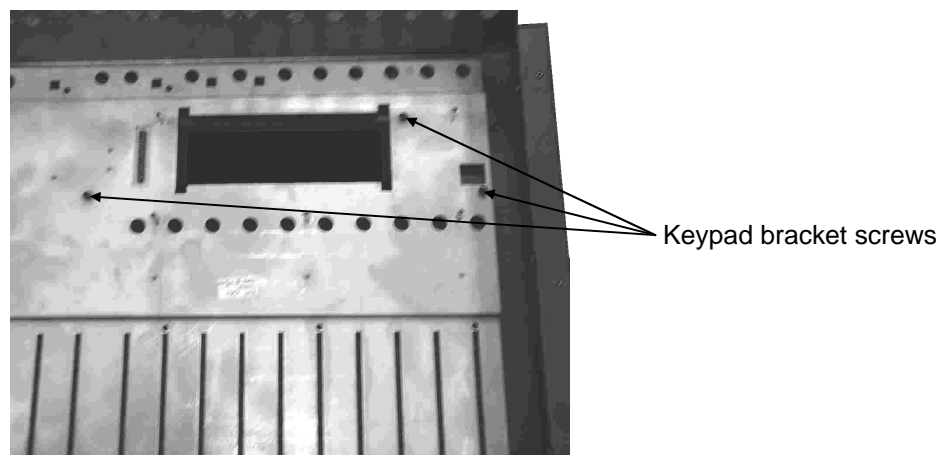

fig.20

- 7) Remove the Keypad bracket, the Keypad PCB then the Keypad.
(**Note:** We recommend the Rubber Keypad is replaced when the Keypad PCB is replaced).

When all service work is complete, remove all debris such as solder, component legs and wire clippings from inside the unit and check your work carefully before re-assembly. To refit the Keypad circuit board assembly and/or Rubber Keypad, follow the above procedure in reverse order. Make sure all harnesses are aligned and plugged on. Test for correct operation.

Ordering an Icon Console

To order a new console please specify the model number and AC mains voltage required.

MODEL	DESCRIPTION	ORDER CODE
<i>DL1000</i>	Unpowered icon Digital Mixing Console	DL1000/volts
<i>DP1000</i>	Powered icon Digital Mixing Console	DP1000/volts

Ordering an Option

To order an option please specify the serial number of the console that is to have the option fitted.

MODEL	DESCRIPTION	ORDER CODE
<i>DL1000-RK</i>	19" Rack Mounting Kit for DL1000 & DP1000 Consoles	DL1000-RK
<i>Carry Bag</i>	Polyester Icon Carry Bag	AP3521

Manuals and Support Documentation

DESCRIPTION	ORDER CODE
icon User Guide	AP3299
icon Service Manual	AP3319
icon Brochure	AP3531
icon Rack Ears Fitting Instructions	AP3577

Service Tools

The tools required to service the **icon** are standard to an electronic service workshop and are easily obtainable. The following items are necessary for disassembly and service access:

1-point Crosshead screwdriver (M3, 4AB)
2-point Crosshead screwdriver (M4, 6AB)
5mm AF Nutdriver (RS232 nuts)
5.5mm AF Nutdriver (audio shield nuts)
11mm AF Nutdriver (potentiometer nuts)
12mm AF Nutdriver (jack sockets)
15mm AF Nutdriver (slimline jack sockets and Toroid Transformer bolt)
Long-nose Pliers

Ordering an Assembly

The following assemblies are supplied fully tested. Please quote the description and order code for the part required.

Printed Circuit Board (PCB) Assemblies:

Audio PCB assembly	002-379
Keypad PCB assembly	002-380
Fader PCB assembly	002-381
MIDI PCB assembly	002-382
Mains PCB assembly (DP1000 only)	002-384
Amplifier/Heat-sink PCB assembly (DP1000 only)	002-385
CPU/LCD PCB assembly	002-386
PSU PCB assembly	002-445

IDC connector harnesses:

DL/DP1000	16 way MIDI harness	AL3340
DL/DP1000	20 way Audio harness	AL3341
DL/DP1000	26 way Audio harness	AL3342
DL/DP1000	26 way Switch Mode PSU harness	AL3586

Ordering a Spares Kit

It is recommended that the spares kit order code **002-303** is held and maintained by the service agent to enable in-field service repairs to the **icon** independent of the ALLEN & HEATH factory. Commonly available items such as resistors, capacitors, tools and soldering equipment are not included. The contents of the kit are listed below and are supplied in a cabinet of drawers. Individual spares parts may be ordered. Please quote the description and order code for the part required.

DESCRIPTION	ORDER CODE	QTY
-------------	------------	-----

Fixings:

Screw 4AB x 5/16 Pan Pozi Black	AB0057	2
Screw 6AB x 3/8 Pan Pozi Black	AB0062	3
Screw 8AB x 3/8 Pan Pozi Zinc	AB0065	3
Screw M3 x 6mm TT Pan Pozi Black	AB0071	5
Screw M3 x 6mm Pan Pozi Black	AB0072	5
Screw M3 x 8mm Pan Pozi Black	AB0073	10
Screw M3 x 10mm Pan Pozi Black	AB0076	5
Screw M3 x 16mm Pan Pozi Black	AB0079	3
Screw M3 x 20mm CSK Pozi Zinc	AB0080	2
Half Nut M3	AB0094	3
Nylock Nut M3	AB0102	10
Shakeproof Washer M3	AB0244	10
Screw 4AB x 1/4 Pan Pozi Plated	AB0252	2
Nylock Nut M5	AB0270	1
Shakeproof Washer M4	AB0289	5
Screw M4 x 8mm Pan Pozi Black	AB0332	10
Screw 4 x 5/16 Poly Pan Pozi Black	AB2810	10
Screw M3 x 5mm CSK Pozi Black	AB2811	10
Nylon Spacer M3 x 9mm	AB3500	2
Screw M5 x 25mm Pan Pozi Zinc	AB3516	1
Washer 1/8"	AB3541	2
Pillar Hex Brass M3 x 5mm	AB3558	4
Screw M3.5 x 8mm TT Pan Pozi Black	AB3595	4
Screw M8 x 90mm Cup Square Hex	AB8136	1
Nylock Nut M8	AB8137	1
Nylock Nut 6-32 Zinc	AB8168	10
Fastfoot	AK8132	10

Knobs and Caps:

Button 5mm Square Grey	AJ2052	5
Button Round Black	AJ2887	2
Knob Soft Touch Dark Blue & Black	AJ3310	10
Knob Soft Touch Light Blue & Black	AJ3311	10
Knob Soft Touch Light Blue & Black 11mm D2	AJ3314	15
Fader Knob 11mm Light Blue+Black Line	AJ3316	15
Button 5mm Square Red	AJ3488	5

Amplifier PCB:

Insulating Kit TO220 Self Adhesive No Holes	AA3514	5
Insulating Kit TO220 Self Adhesive	AA3515	4
Insulating Kit T03 High Eff	AA8173	8
Preset Resistor 500R Ceramic Horizontal	AC8157	2
IC Regulator 7915	AE0048	1
Transistor BC637 NPN TO92H	AE0068	2
IC LM339N Comparator	AE0071	1
Zener Diode BZX79C 12V 400mW	AE0232	2
Bridge Rectifier 35A 600V	AE0239	1
Bridge Rectifier 6A In-Line	AE0351	1

Zener Diode 47V 500mW	AE2999	1
Transistor TIP122	AE3215	1
Thermistor 100K	AE3499	1
Transistor MPSA92 PNP	AE8119	15
Transistor MJ15024 NPN	AE8129	4
Transistor MJ15025 PNP	AE8130	4
Transistor MPSA42 NPN	AE8138	15
Transistor 2SC2240BL NPN	AE8152	2
Transistor MJE340 NPN	AE8155	2
Transistor MJE350 PNP	AE8156	2
Fuse 6.3A Anti-Surge 20mm	AL0395	5
Fuse 1A Anti-Surge TE5	AL3529	3
Fuse 2A Anti-Surge TE5	AL3530	3
Fuse 16A Anti-Surge 20mm	AL8154	5
Fan 80x80x25 12V DC	AM3517	1
Inductor Amplifier O/P	AM8146	2

CPU PCB:

IC MPU H8/3003	AE3005	-
IC CS4222 20-Bit Codec	AE3006	-
Crystal 14MHz	AE3007	1
IC Regulator 3.3V Zetex	AE3040	2
IC SRAM 64Kx16 15ns 3.3V Low Power	AE3043	-
IC SRAM 32Kx8 70ns 5V Low Power	AE3044	-
IC DS1233-5 TO92 Power Reset	AE3066	1
LCD Module DL1000	AE3132	-
IC DSP 56303 PV80	AE3196	-
IC CPLD XC9572PLCC44C-15	AE3326	1
IC XTAL OSC 11.2896MHz 100ppm	AE3336	1
IC Flash 256Kx16 70ns	AE3454	-
Transistor Mosfet BSS138	AE3498	1
Encoder EC16B	AI3309	10
Battery 2.4V 70mAh NICAD	AP3334	1

Fader PCB:

IC CMOS 4052B	AE0139	4
Fader 10K Linear Slimline 100mm	AI3313	15

MIDI PCB:

IC 6N136 Opto-Isolator	AE0222	2
IC RS232 HIN202CP	AE2742	2
DIN Socket Female 5way 180deg PCB	AL0095	2
Jack Socket Small	AL2048	4
Switch Slide MINI SPDT PCB	AL3081	1

Audio PCB:

LED 3mm T1 Green	AE0085	2
LED 3mm T1 Red	AE0086	2
Transistor 2SB737 PNP	AE8069	10
Pot 20KK (203K 11mm wide)	AI8003	2
Pot 20KK x 2 (203K 14mm wide)	AI8007	1
Pot 5K (502RD 11mm wide)	AI8111	5
Pot 5KRD x 2 (502RD 14mm wide)	AI8174	2
Jack Socket Headphone	AL0328	1
XLR 3 Pin Female Vertical PCB	AL2410	3
Phono Socket Dual Vertical PCB 24mm	AL3443	1
Switch 2PCO Latching 90deg	AL8065	3
Jack Socket Vertical PCB + nut	AL8114	10

Faders, Potentiometers, Switches and Connectors:

Jumper Socket 2way	AL0334	1
Molex 0.1" Male 15 x 2 pin straight	AL3583	1
Speakon Connector NL4MP Chassis	AL8126	2
Jack Nut Slimline Plastic	AL8133	4
Fuse Clip Schurter	AL8134	5
Fuse Cover Schurter	AL8139	2

Common Semiconductors:

Transistor BC549 NPN	AE0020	15
IC TL072 Op-Amp	AE0046	4
IC Regulator 7815	AE0047	2
Transistor BC556B PNP	AE3001	5

Power Supply:

IC 4N35 Opto-Isolator (DL1000)	AE0266	-
IC Regulator 7805	AE0308	4
IC Comparator LM393N (DL1000)	AE2818	-
Diode BYV27-400 2A 400V (DL1000)	AE3469	-
Diode BYV26E 1A 1000V (DL1000)	AE3470	-
Diode P6KE200A (DL1000)	AE3471	-
Transistor Mosfet STP4NA80FI (DL1000)	AE3472	-
IC SMPS UC3842AN (DL1000)	AE3473	-
IC TL431 Voltage Reference (DL1000)	AE3475	-
Bridge Rectifier 2KBP06M (DL1000)	AE3477	-
Inrush Supressor 20R (DL1000)	AE3478	-
IC Regulator 7812 (DL1000)	AE3588	-
IC Regulator 7912 (DL1000)	AE3589	-
Inrush Supressor (DP1000)	AE8143	1
Mains Lead IEC-2pin Euro	AH0205	-
Mains Lead IEC-3pin UK	AH0206	-
Mains Lead IEC-3pin US (C33)	AH0323	-
Mains Fuse 20mm 5A A/Surge (DP1000)	AL2270	10
XLR 3 Pin Male 90deg PCB (DL1000)	AL2413	1
Fuse Holder 20mm PCB (DL1000)	AL3178	-
Mains Switch 10A PCB	AL3338	1
Fuse Holder 10A 20mm PCB (DP1000)	AL3447	1
Mains Fuse 20mm 10A A/Surge (DP1000)	AL3455	10
IEC Mains Inlet Filter PCB 3 Pin (DL1000)	AL3458	-
Mains Fuse 20mm 500mA A/Surge (DL1000)	AL3534	10
Inductor 150uH 280mA (DL1000)	AM2970	-
Transformer DP1000 Toroid	AM3084	-
Inductor 4.7uH 600mA (DL1000)	AM3467	-
Transformer DL1000 Switch Mode	AM3476	-

Miscellaneous:

icon Packing Assembly	002-374	-
Insulating Kit TO220	AA0693	2
Rubber Keymat	AA3259	-
Flex cable 12way 90mm	AH2228	2

DL1000

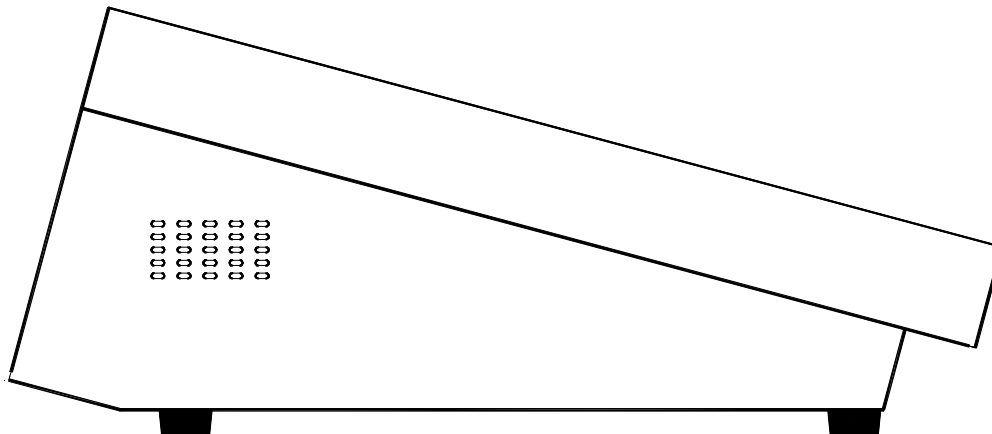
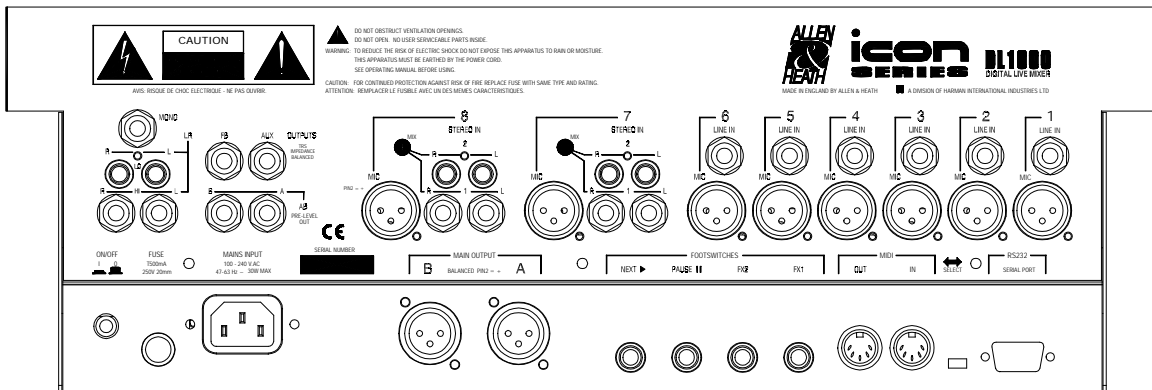
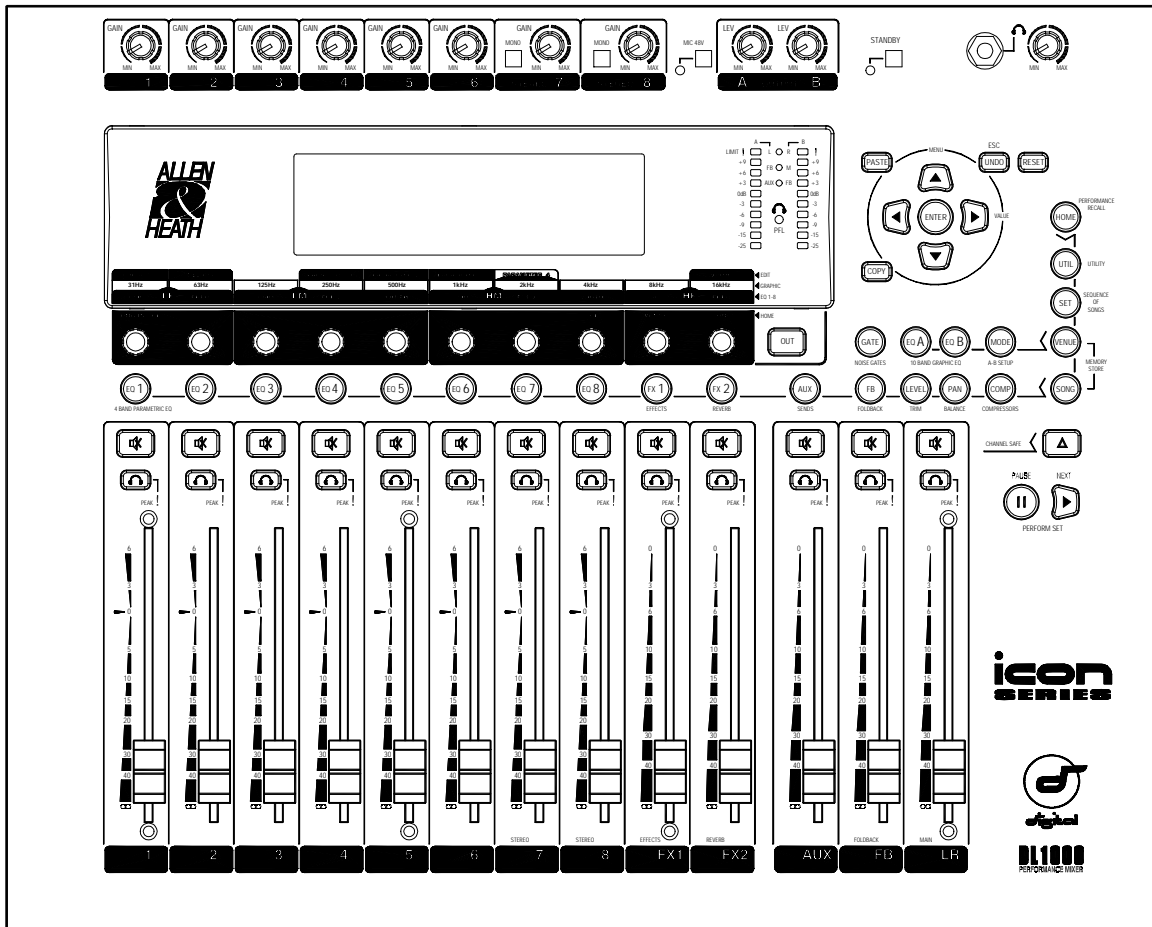

DP1000

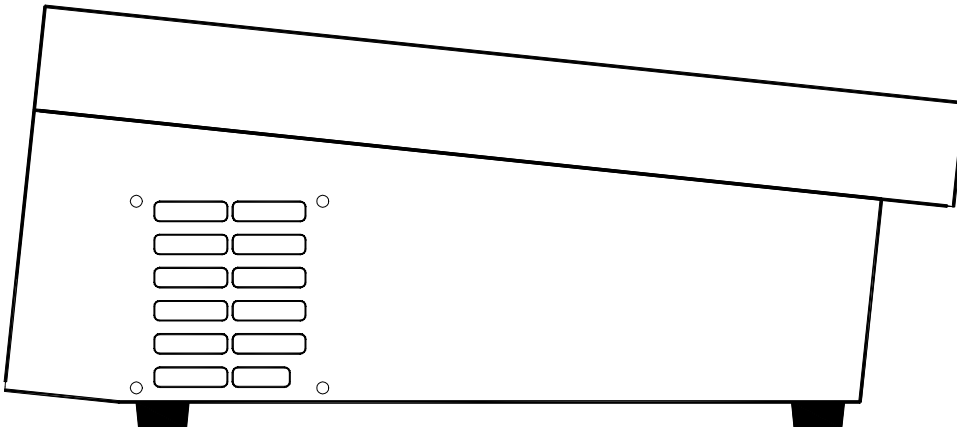
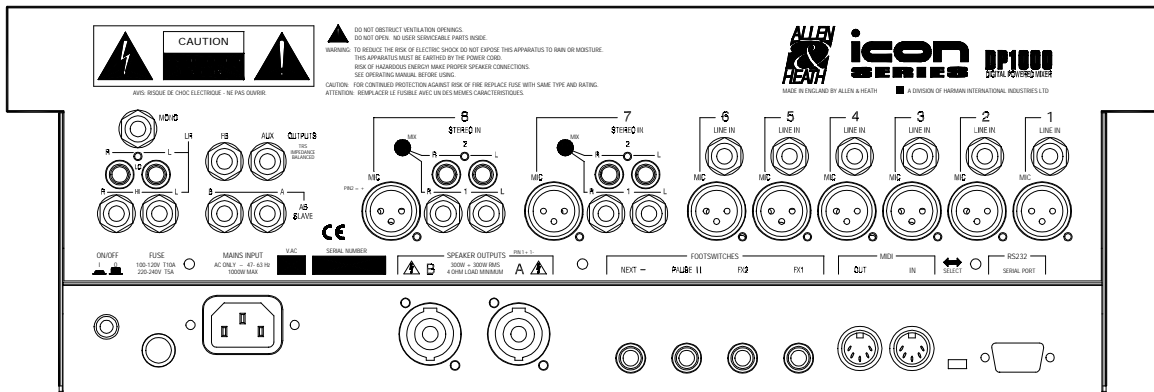
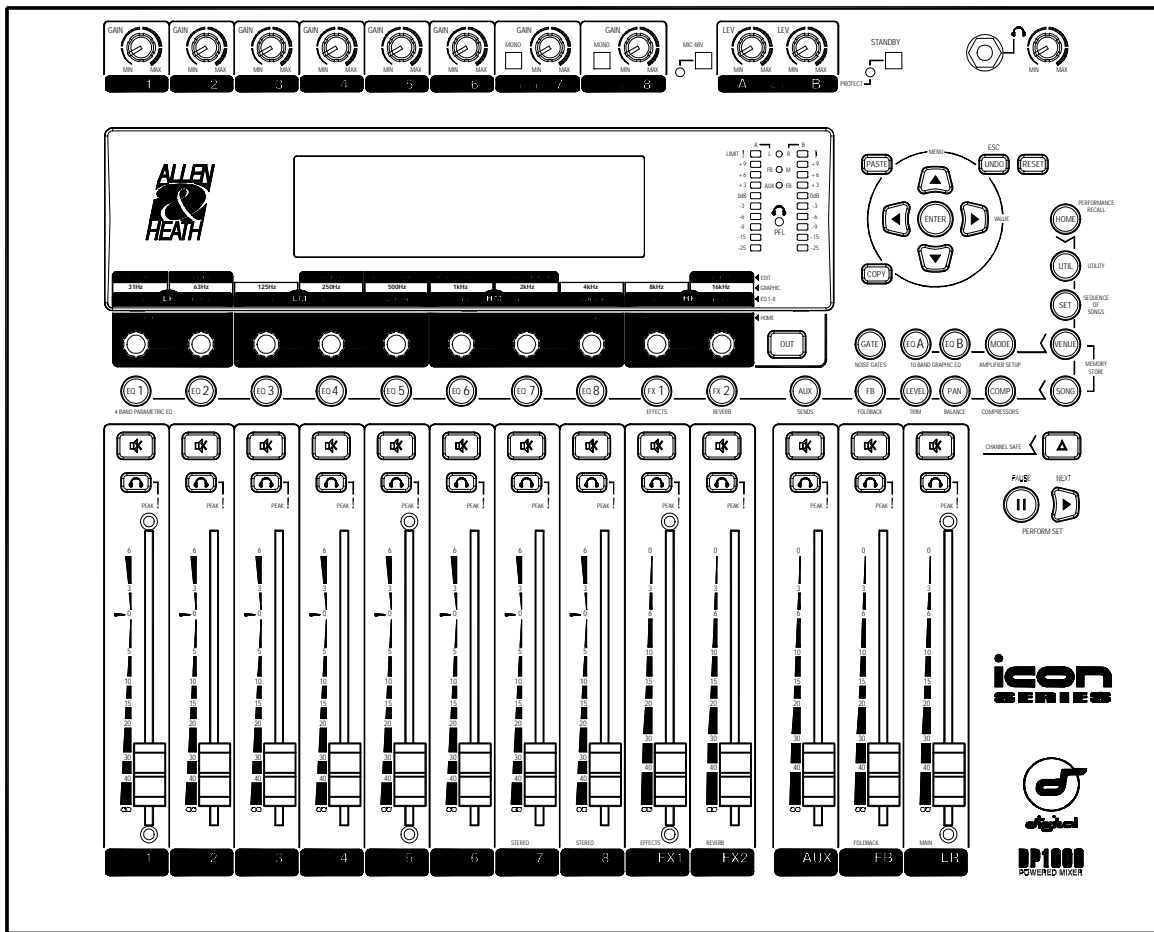

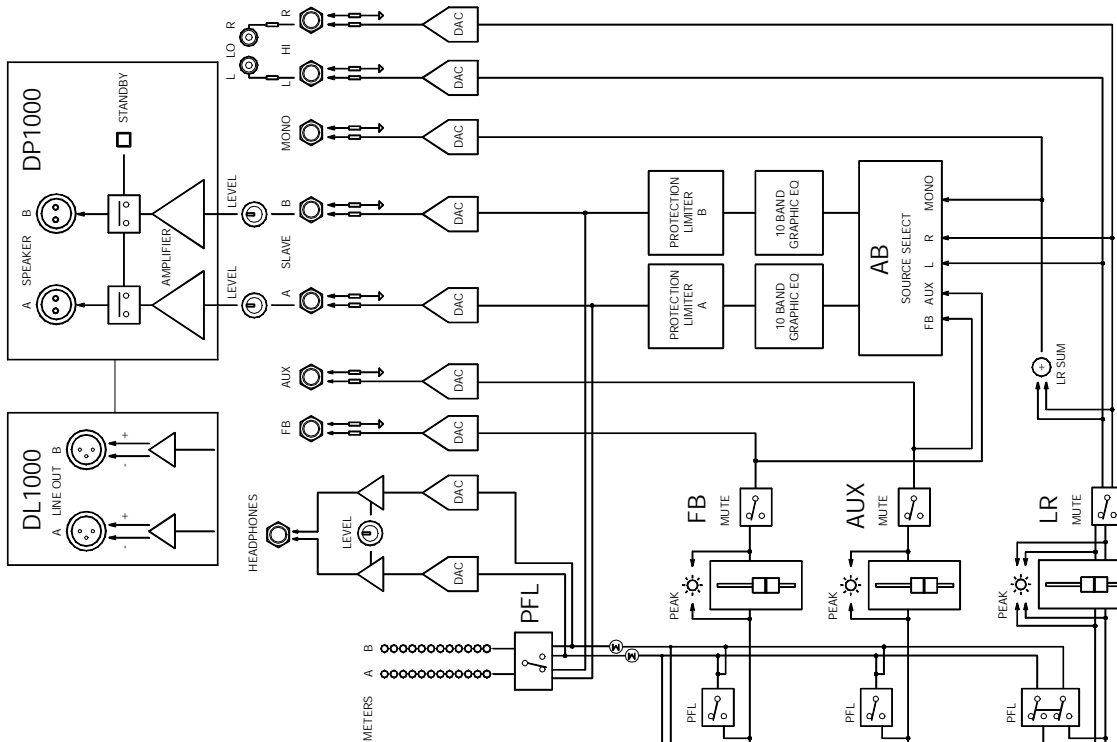
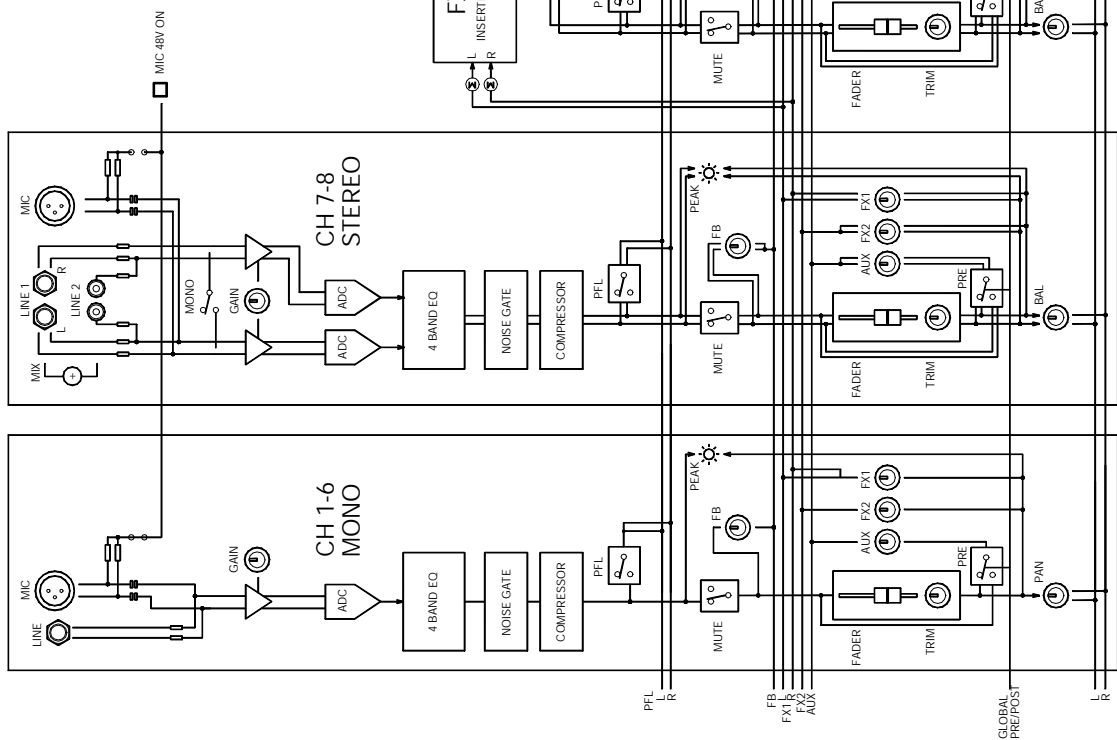

ALLEN & HEATH
icon
SERIES

BLOCK DIAGRAM