

Service *Manual*

MODEL: ALTO LINK



www.altomobile.com

Version 1.0

CONTENTS

- 1. Introduction.....2
- 2. Specification.....3
- 3. Block Diagram.....4
- 4. Schematic Diagram.....5
- 5. Wiring Diagram.....8
- 6. PCB Layout.....9
- 7. Test Procedure.....10
- 8. Exploded Views & Mechanical Parts List.....15
- 9. BOM.....18

1. Introduction

The ▲ALTO LINK is in fact the good solutions for many problems of large scale sound reinforcement systems and PA applications, and it can be used as a splitter or a mixer.

For splitter application, just apply the main signal input from the MAIN IN sockets, and select the SPLITTER mode for each individual channel, then six mono outputs can be gotten. By depressing the MAIN MIX button, two further outputs can be provided.

For mixer application, select the MIXER mode for individual channel, and feed the input signal from the mono input, then six input signals can be mixed together, and output from the MAIN OUT. By depressing the MAIN MIX button, two further inputs can be provided.

Features:

- 1 rack size
- SPLIT / MIX switch for each mono channel
- 2 input, 6+2 outputs splitter
- 8 Balance / Pan control for each channel
- Main input and output level control
- MAIN LINK function allows to route the MAIN IN signal to MAIN OUT, vice versa
- Level meters for each stage
- XLR balanced connectors for 4 mono channels, and TRS type for another 2 mono channels
- Dual voltage unit for global operation

2. Specification

AUDIO INPUTS	Connectors	XLR and 1/4" TRS
	Type	RF filtered, servo-balanced input
	Impedance	50 kOhms balanced, 25 kOhms unbalanced
	Nominal operating level	-10 dBV to +4 dBu
	Max. input level	+21 dBu balanced and unbalanced
	CMRR	Typ. 40 dB, > 55 dB @ 1 kHz
AUDIO OUTPUTS	Connectors	XLR and 1/4" TRS
	Type	Electronically servo-balanced output stage
	Impedance	60 Ohms balanced, 30 Ohms unbalanced
	Max. output level	+22 dBu balanced and unbalanced
SYSTEM SPECIFICATIONS	Frequency response	5 Hz to 200 kHz, +/- 3 dB
	S/N ratio	>95 dBu, unweighted, 22 Hz to 22 kHz
	THD	0.002 % typ. @ +4 dBu, 1kHz, gain 1
POWER SUPPLY	USA/Canada	120V ~, 60 Hz
	U.K./Australia	240V ~, 50 Hz
	Europe	230V ~, 50 Hz
		General Export Model 100-120V ~, 200-240V ~, 50 - 60 Hz
	Power Consumption	max. 15 Watts
	Fuse	95 - 120 V ~: T 315 mA H
		210 - 240 V ~: T 200 mA H
Mains Connection	Standard IEC receptacle	
PHYSICAL WEIGHT	Dimensions (H*W*D)	483(W)*217(D)* 44(H)mm (19"*8.54"*1.7")
	Net Weight	3 kg(6.4lb)
	Shipping Weight	3.8 kg

3. Block Diagram

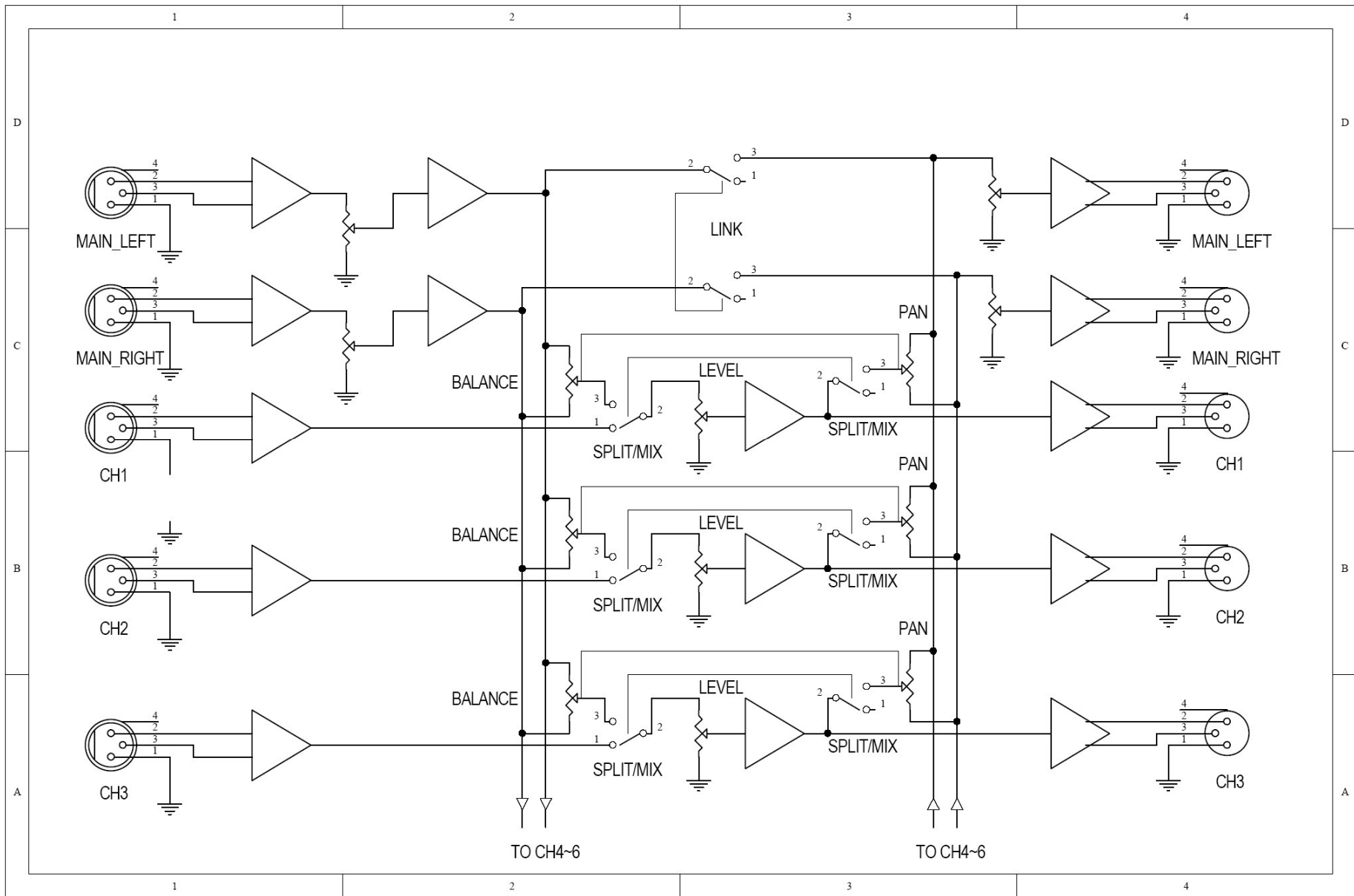

4. Schematic Diagram

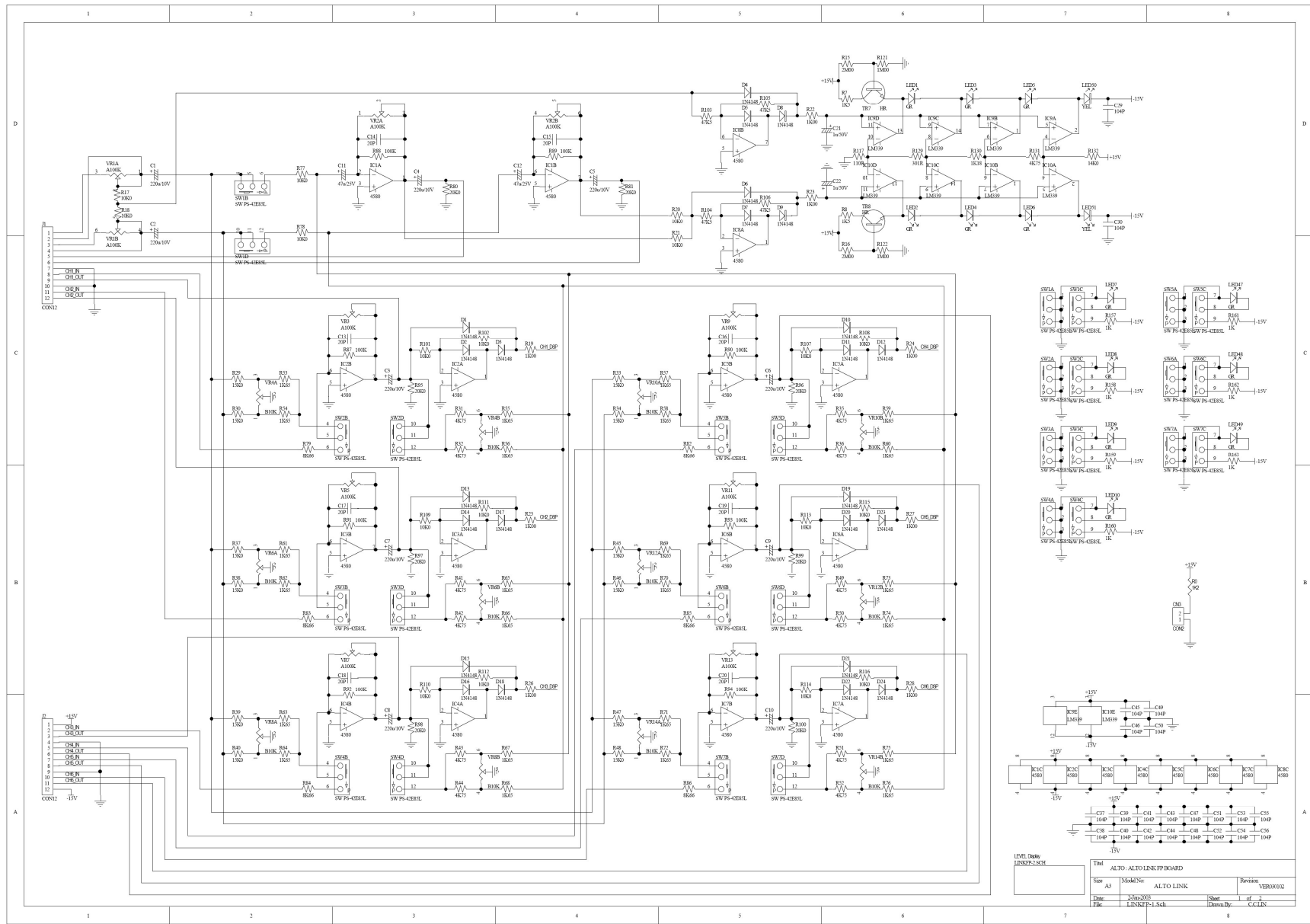

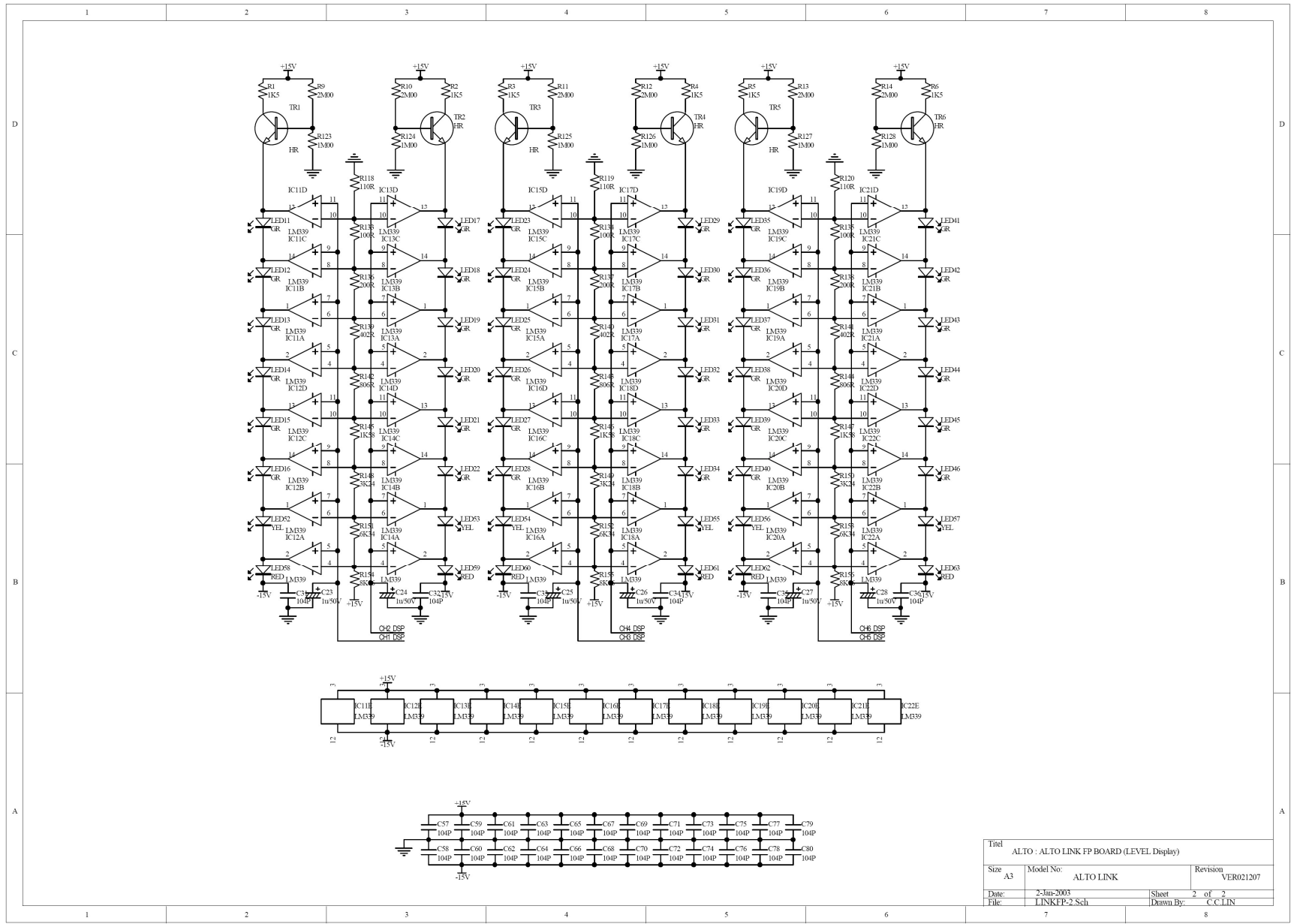

Title ALTO : ALTO LINK FP BOARD (LEVEL Display)			
Size A3	Model No: ALTO LINK	Revision VER021207	
Date: 2-Jan-2003	Sheet 2 of 2	Drawn By: C C LIN	
File: LINKFP2.Sch			

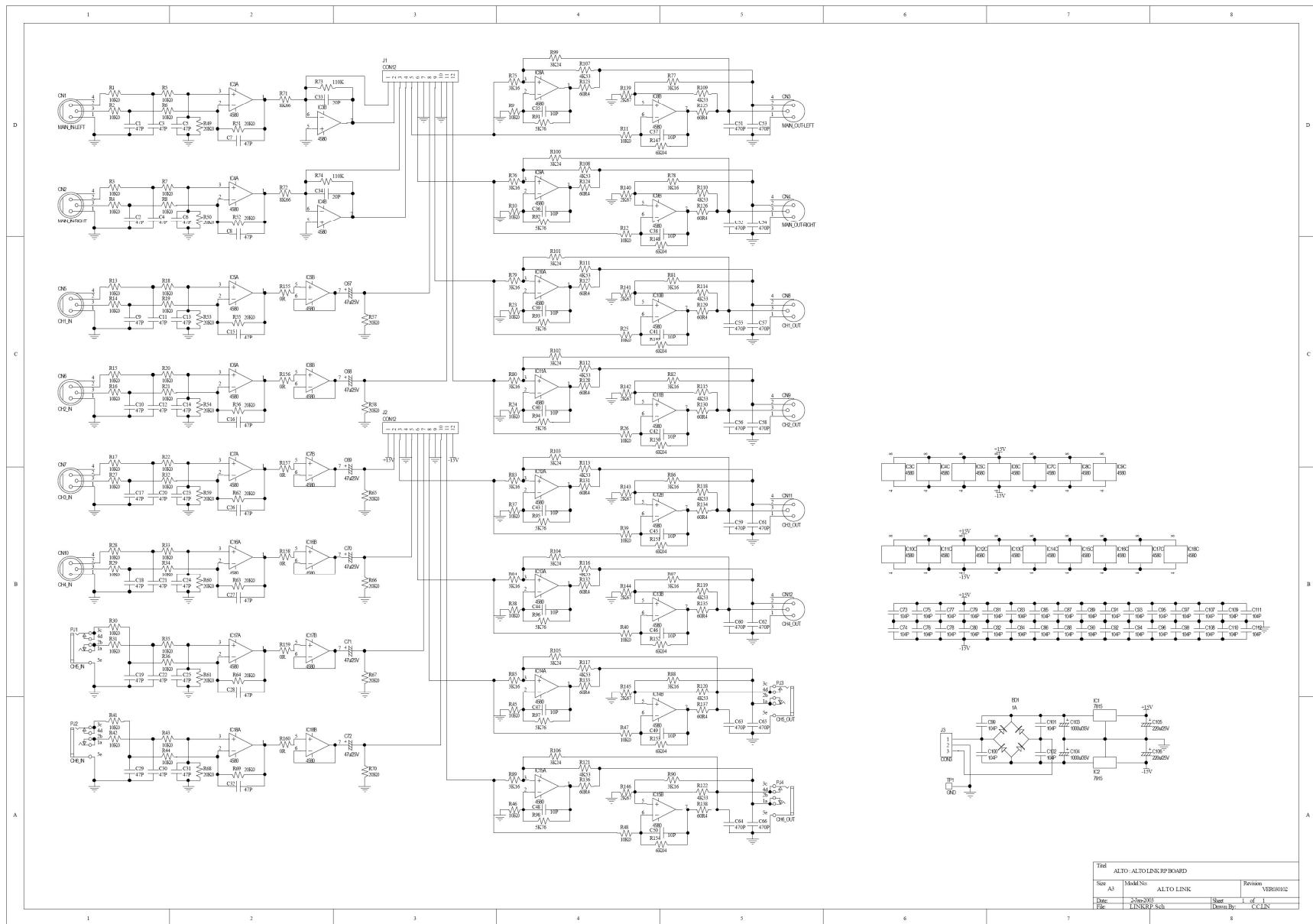

File	ALTO-ALTO-LINK-RPI-BOARD	Revision	000002
Size	A1	Model No.	ALTO-LINK
Date	24/07/2013	Sheet	1 of 1
File	LINK-RPI-Sch	Drawn by:	C.C.LIN

5. Wiring Diagram

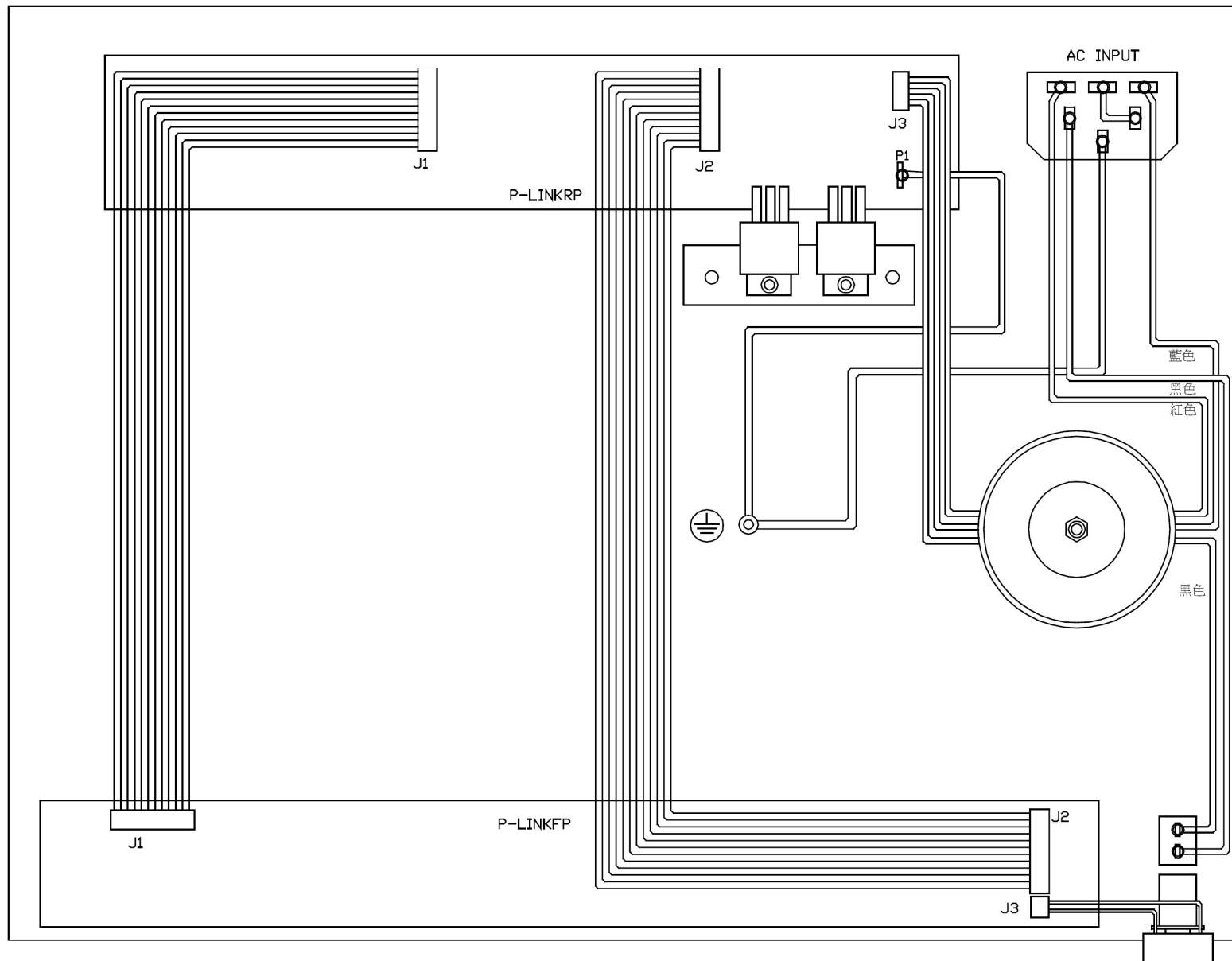

6. PCB Layout

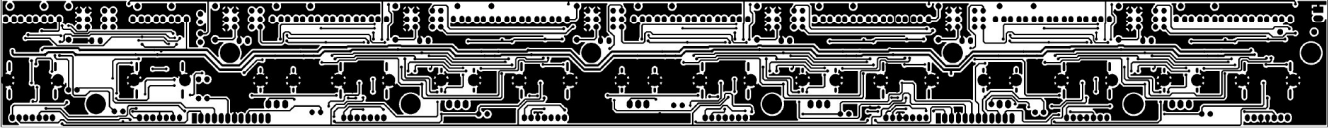

LINKFP Top Layer

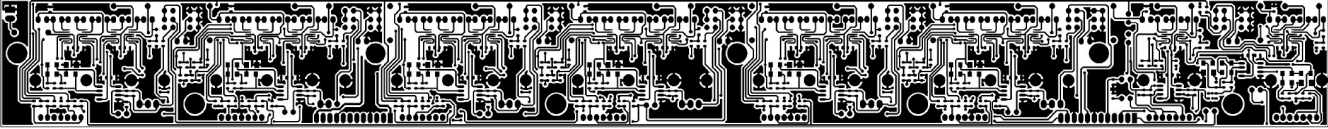

LINKFP Bottom Layer

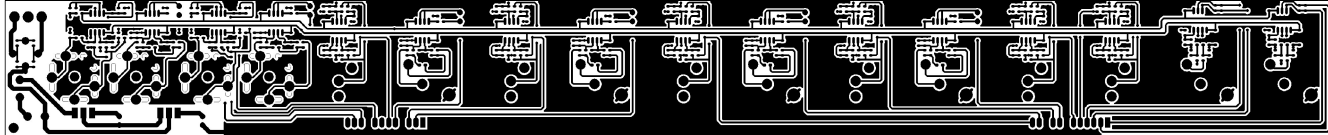

LINKRP Top Layer

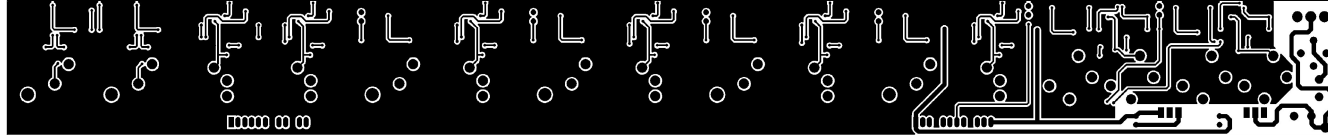

LINKRP Bottom Layer

7. Test Procedure

1) Test Equipment:

1. Dual-track oscilloscope
2. AP (Audio Precision)

2) Test Procedure

Setup

1. Select proper AC input voltage
2. Connect AP output signal to the input of ALTO LINK MAIN IN.
3. Connect ALTO LINK OUT to the input of AP.

Adjustment

1. Release all buttons, then press MAIN LINK button down.
2. Adjust the level of CH1~CH5 and MAIN INPUT at +15 position.
3. Turn BALANCE/PAN to zero.
4. The output shall be +14dBm \pm 1dBm, THD<0.03, shown as following figure.

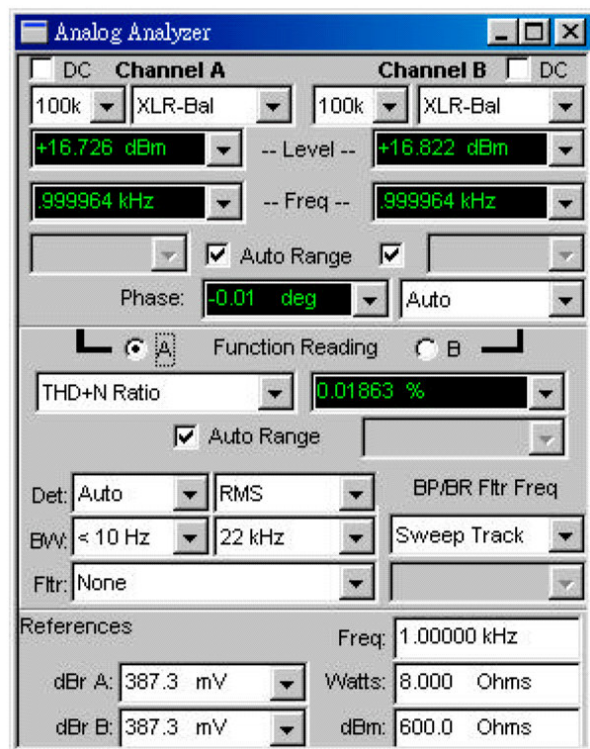
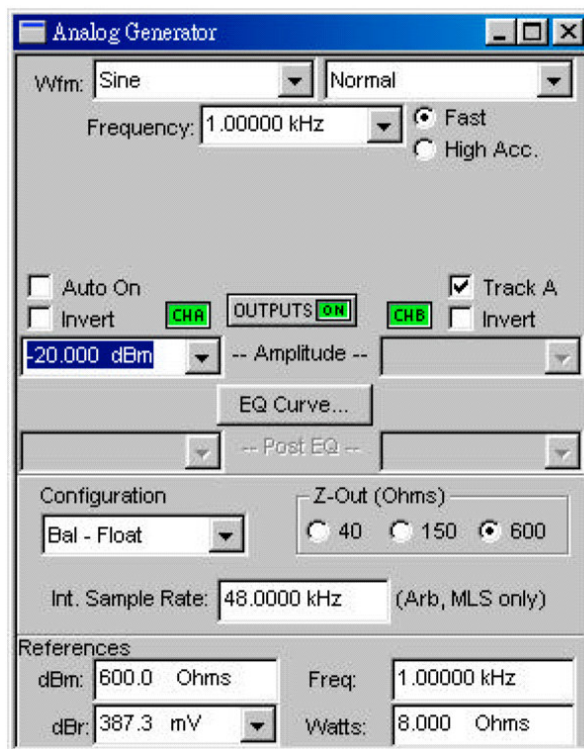

5. Measure the frequency response as following figure.

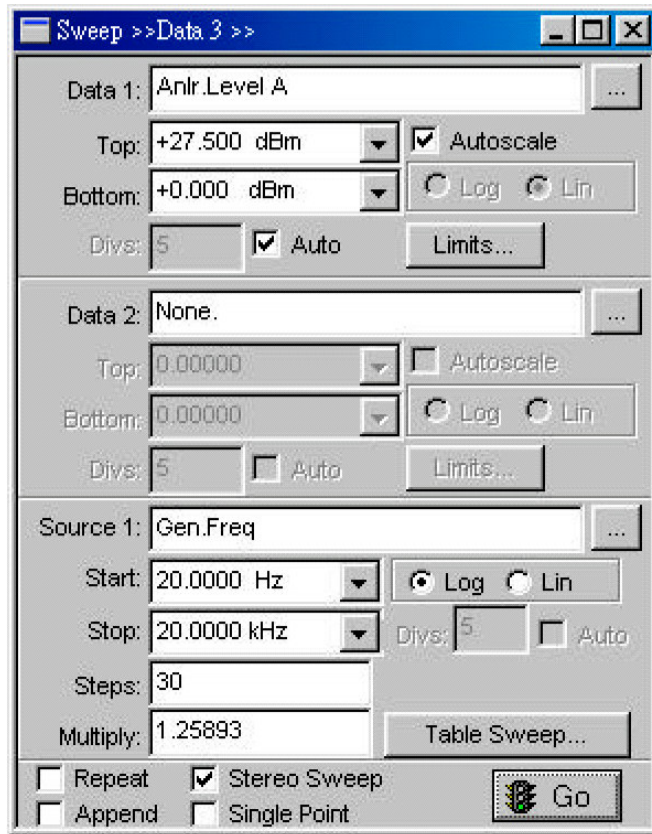

Audio Precision

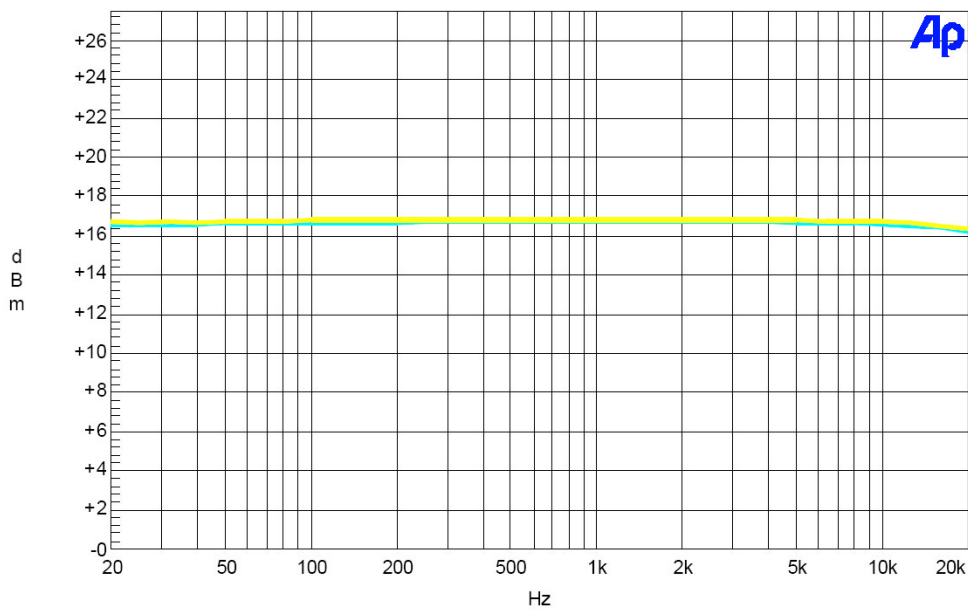

Sweep	Trace	Color	Line Style	Thick	Data	Axis	Comment
1	1	Cyan	Solid	3	Anlr.Level A	Left	
1	2	Yellow	Solid	3	Anlr.Level B	Left	

HPA4.at2

6. Connect the outputs of CH1 and CH2 to the inputs of AP, repeat steps 4~5.
7. Connect the outputs of CH3 and CH4 to the inputs of AP, repeat steps 4~5.
8. Connect the outputs of CH3 and CH4 to the inputs of AP, repeat steps 4~5. (Using balanced Ø6.3 stereo wire to connect)
9. All output level indicators shall be lit, the INPUT LEVEL indicates -12dBm.
10. Adjust output of AP at 0dBm, all INPUT LEVEL LEDs shall be lit.
11. Connect the output signal of AP to CH1 input of ALTO LINK.
12. Connect MAIN OUT to the input of AP.
13. Keep all buttons down, then release MAIN LINK button.
14. The output shall be +16dBm \pm 1dBm, THD<0.03, shown as following figure.

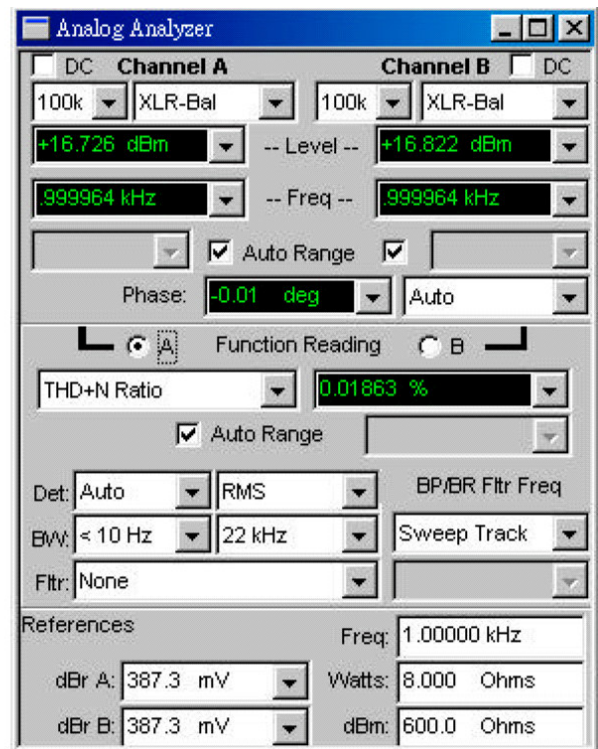
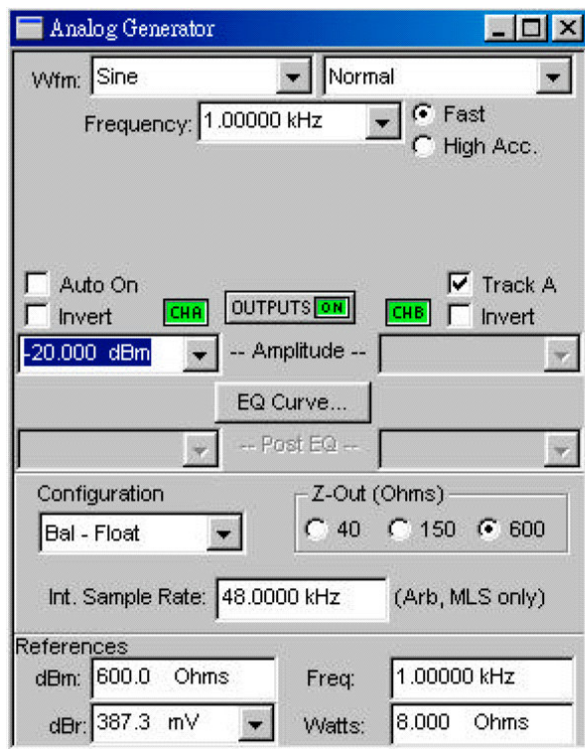

15. Test frequency response as following figure.

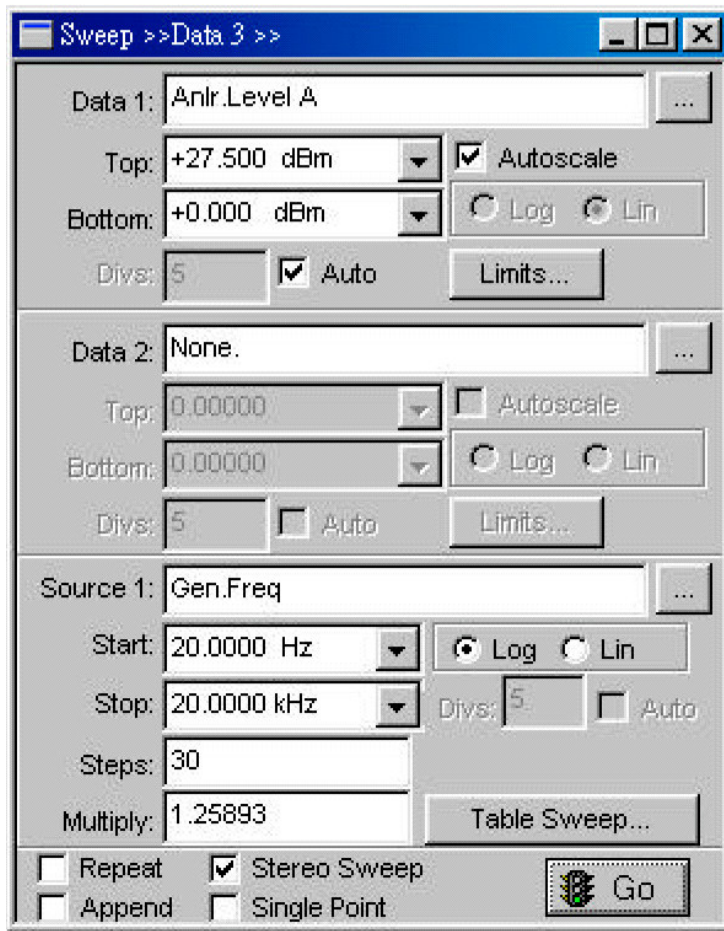

Audio Precision

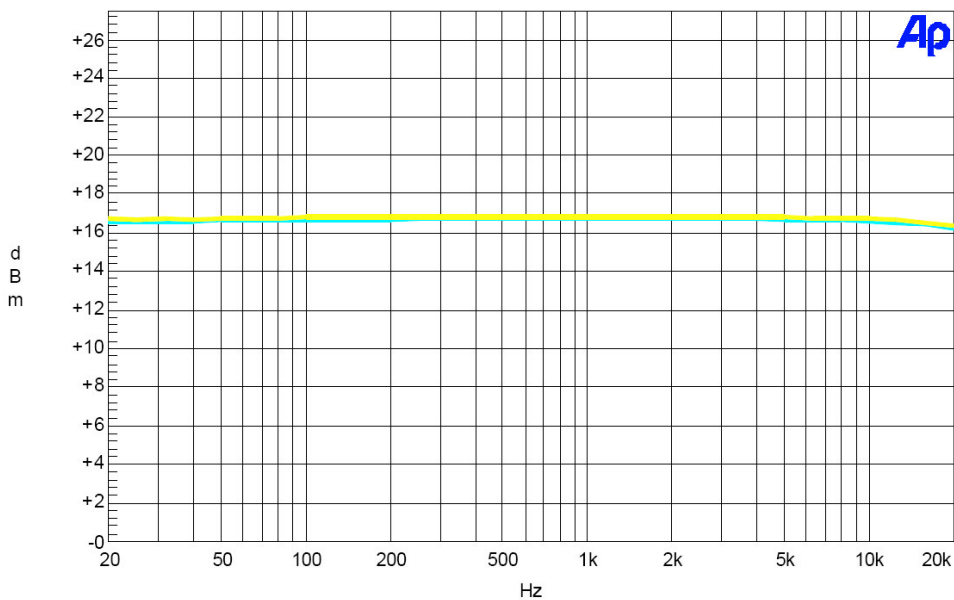

Sweep	Trace	Color	Line Style	Thick	Data	Axis	Comment
1	1	Cyan	Solid	3	Anlr.Level A	Left	
1	2	Yellow	Solid	3	Anlr.Level B	Left	

HPA4.at2

16. Connect the output signal of AP to the CH2 input of ALTO LINK, then repeat steps 14-15.
17. Connect the output signal of AP to the CH3 input of ALTO LINK, then repeat steps 14-15.
18. Connect the output signal of AP to the CH4 input of ALTO LINK, then repeat steps 14-15.
19. Connect the output signal of AP to the CH5 input of ALTO LINK, then repeat steps 14-15.
20. Connect the output signal of AP to the CH6 input of ALTO LINK, then repeat steps 14-15.
21. Test finished.

8. Exploded Views & Mechanical Parts List

SEKURU

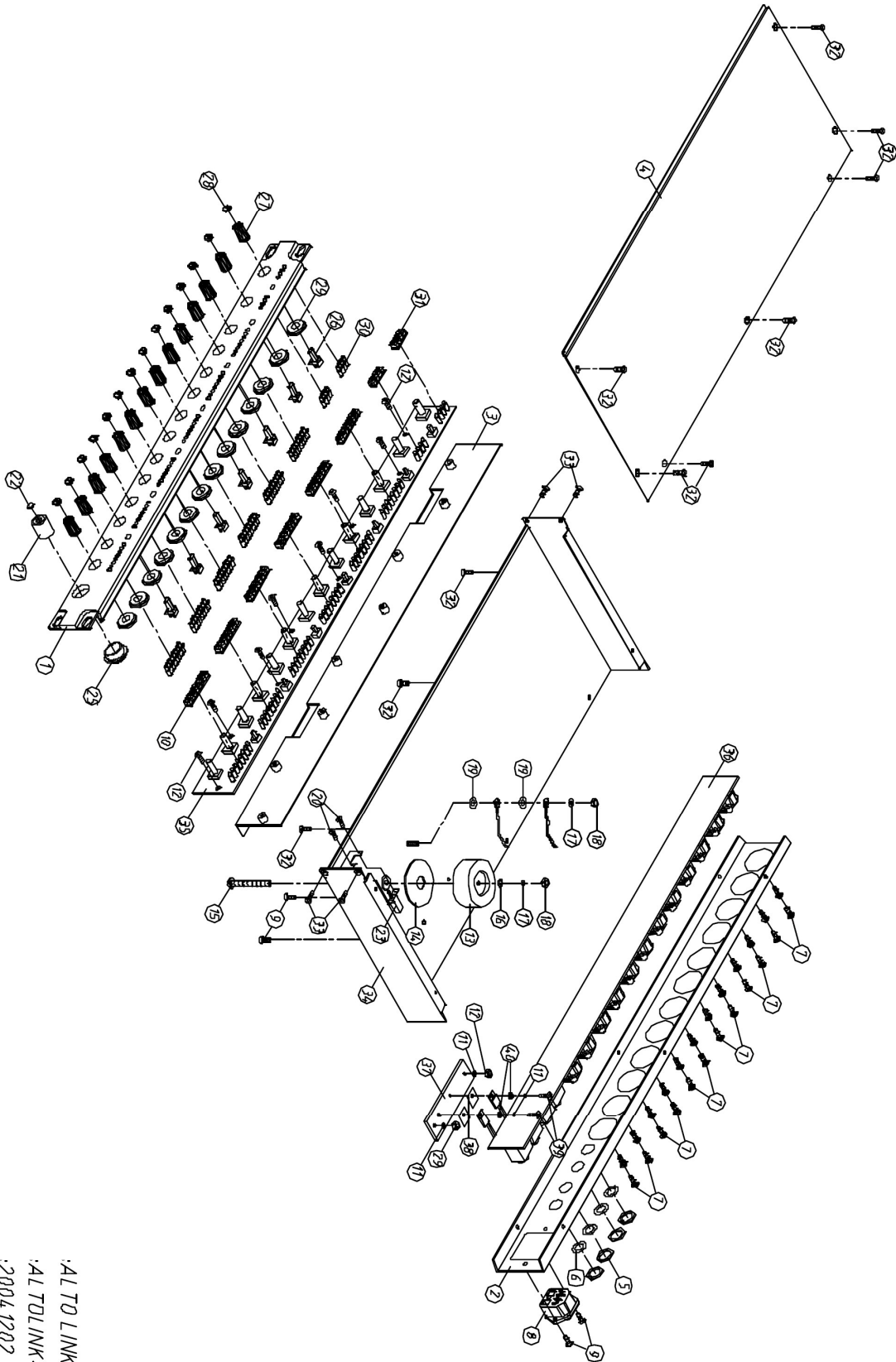

ALTO LINK
AL TDLINK-00
2004.12.02

Mechanical Parts List for ALTO LINK

No.	Item Number	Description	Specification	Quantify
1	MA03872	panel	ALTO LINK	1
2	MB02553	Rear panel	ALTO LINK	1
3	MI01632	Front panel	ALTO LINK	1
4	MC00209	Upper cover	CLE2.0	1
5	ME00060	Nut of MIC socket	Hexagon JY-6351G-02-250	4
6	MF00061	Washer of MIC socket	Round JY-6351G-02-250	4
7	MG00061	Black plated screw	M3*10	24
8	HC00015	AC holder	(S)315-B	1
9	MG00042	Black plated screw	M3*10	4
10	MF00023	Color washer	$\varphi 3^* \varphi 10^*1t$	2
11	MF00037	Spring washer	$\varphi 3^* \varphi 5^*1t$	4
12	ME00015	Color nut	3mm	2
13	TD00118	Loop transformer	PT-CLE4.0(include FUSE102°C)	1
14	NI00443	Rubber ring	$\varphi 20^* \varphi 60^*2tB$	1
15	MG00111	Color screw	M4*30	1
16	MF00019	Color washer	$\varphi 4^* \varphi 12^*1t$	1
17	MF00038	Spring washer	$\varphi 4^* \varphi 7^*1t$	2
18	ME00016	Color nut	4mm	2
19	MF00048	Outer-tooth washer	$\varphi 4^* \varphi 8^*0.5t$	2
20	MG00041	Black plated screw	M3*6	10
21	NI00308	Power switch	$\varphi 15^*17$	1

22	NI01159	Cap of power switch	φ 6*2.5 YELLOW C	1
23	HI00023	Power switch	SDDL B 1007U	1
24	SA00065	LED	Green (LG2043)	1
25	NI02085	Fixing sleeve of power switch	φ 22*9.69 072C blue	1
26	NI01156	Transparent button	φ 3*W6*18.3	7
27	NI00362	Plastic knob	(COOL GRAY 8C/white)	14
28	NI00896	Cap of knob	φ 8.5*4 blue 072C	14
29	NI02408	Fixing slice	φ 15*2.7mm white CONTROL30	14
30	NI01178	Light-guide post	φ 3.1*85	4
31	NI01876	Separation of LED Socket	7.6*4.5*184(41hole a row)	2
32	MG00025	Black plated screw	M3*6	13
33	MG00045	Black plated screw	M3*7	4
34	MB00522	Chassis	CLE2.0_V1.6	1
35	HK02403	K-PC board	P-LINKFP-DIP	1
36	HK02405	K-PC board	P-LINKRP-DIP	1
37	MJ00123	Heat sink	65*18*4 SCX-P234	1
38	NC00005	Silicon insulator	TO-220 square	2
39	MG00162	Nickel screw	M3*8	2
40	NI02249	Insulation bean	TW-1(TO-220)	2

9. BOM

ALTO LINK Parts List

No.	Part No.	Description	Specification	Remark
1	MA03872	panel	ALTO LINK	
2	MA03871	panel	ALTO LINK	
3	MA03870	panel	ALTO LINK	
4	MA03933	panel	ALTO LINK	
5	MI01279	panel	44.2*17.5*483	
6	MB02553	rear board	ALTO LINK	
7	MB02551	rear board	ALTO LINK	
8	MB02550	rear board	ALTO LINK	
9	MJ00058	iron board	1*2135*1220 20.45kg	
10	MI01632	front board	ALTO LINK	
11	MJ00058	iron board	1*2135*1220 20.45kg	
12	ME00035	iron pillar	hexagon6.35*M3*6	
13	MC00209	top cover	CLE2.0	
14	MC00207	top cover	CLE2.0	
15	MC00208	top cover	CLE2.0	
16	MJ00059	iron board	1.2*2135*1220 24.54kg	
17	ME00060	nut	JY-6351G-02-250	
18	MF00061	washer	JY-6351G-02-250	
19	MG00061	screw	M3*10	
20	HD00006	glass tube fuse	315mA 250V ϕ 5.2*20mm CSA/S/UL/VDE	
21	HC00015	AC socket	(S)315-B (AC select)	
22	MG00042	screw	M3*10	
23	MF00023	washer	ϕ 3* ϕ 10*1t	
24	MF00037	washer	ϕ 3* ϕ 5*1t	
25	ME00015	nut	3m/m	
26	TD00118	transformer	PT-CLE4.0	
27	NI00443	rubber coil	ϕ 20* ϕ 60*2tB	
28	MG00111	screw	pill 4*30	
29	MF00019	washer	ϕ 4* ϕ 12*1t	
30	MF00038	washer	ϕ 4* ϕ 7*1t	
31	ME00016	nut	4m/m	
32	MF00048	washer	ϕ 4* ϕ 8*0.5t	
33	MG00041	screw	M3*6	
34	NI00308	power switch button	ϕ 15*17	
35	NI01159	power switch button cap	ϕ 6*2.5 YELLOW C	

ALTO LINK Parts List

No.	Part No.	Description	Specification	Remark
36	HI00023	power switch	SDDLB 1007U	
37	SA00065	L.E.D	LG2043 green	
38	HA01388	row-wire connector wiring	2P 100	
39	NI02085	power switch sleeve	φ 22*9.69	
40	HA01333	single terminal wiring CF:W76	150mm UL1015 18AWG green/yellow	
41	HA01798	Wire	250 black	
42	HA01835	P.V.C single wave wired UL1617	80 brown	
43	NI00240	sleeve	φ 2.5*10mm	
44	NI00239	sleeve	φ 2.5*1000mm	
45	NI00252	sleeve	φ 4*20mm	
46	NI00248	sleeve	φ 4*1000mm	
47	NI01156	button	φ 3*W6*18.3	
48	NI00362	knob	(COOL GRAY 8C/white)	
49	NI00896	knob cover	φ 8.5*4 072C	
50	NI02408	bracket	φ 15*2.7mm 白 CONTROL30	
51	NI01178	LED lens	φ 3.1*85	
52	NI01876	LED spacer support	7.6*4.5*184	
53	MG00025	screw	M3*6	
54	MG00045	screw	M3*7	
55	NI00218	cable tie-black	ALT-102SB	
56	HA00841	power cord(America 3P)	LT-202+18A*3C(SVT) 6FT+LT-501	
57	NI00501	foot cushion	12.7*9*3t(SF-004)	
58	NA00137	clip-chain bag	5*7	
59	NA00123	PE bag	0.04t*580*300mm	
60	HJ00006	desiccant	30g	
61	NF01178	instruction	ALTO LINK ALTO_V1.1	
62	NH00149	paper	889*640mm	
63	NF00061	assurance card	ALTO	
64	NB02163	barrier	X23,34,40	
65	NB02164	barrier	X23,34,40	
66	NB02071	color box	ALTO LINK ALTO_V1.0	
67	NE06158	label	ALTO-LINK	
68	NH00012	bond paper	0.04*1M	
69	NI00014	membrane	0.035*1M	
70	NE05004	label	ALTO	

ALTO LINK Parts List

No.	Part No.	Description	Specification	Remark
71	MB00522	bottom board	CLE2.0_V1.6	
72	MB00520	bottom board	CLE2.0	
73	MB00521	bottom board	CLE2.0_V1.6	
74	MJ00059	iron board	1.2*2135*1220 24.54kg	
75	ME00001	screw pillar	M4*10*0.7PH	
76	MI01357	fixed board	CLE2.0	
77	MJ00063	Zn-plated board	1.2*2135*1220 24.54kg	
78	HK02403	PC board	P-LINKFP-DIP	
79	HK02402	PC board	P-LINKFP-SMD	
80	HB00863	PCB	LINKFP(1*4)_VER030219	
81	RD00275	SMD precise resistor 1/10W	110Ω ±1% 0603	R117,R118,R119,R120
82	RD00278	SMD precise resistor 1/10W	301Ω ±1% 0603	R129,R133,R134,R135
83	RD00282	SMD precise resistor 1/10W	1.00KΩ ±1% 0603	R19,R22,R23,R24,R25,R26,R27,R28
84	RD00405	SMD precise resistor 1/10W	1.18KΩ ±1% 0603	R130,R136,R137,R138
85	RD00425	SMD precise resistor 1/10W	1.65KΩ ±1% 0603	R53,R54,R55,R56,R57,R58,R59,R60,R61,R62,R63,R64,R65,R66,R67,R68,R69,R70,R71,R72,R73,R74,R75,R76
86	RD00386	SMD precise resistor 1/10W	4.75KΩ ±1% 0603	R31,R32,R35,R36,R41,R42,R43,R44,R49,R50,R51,R52,R131,R139,R140,R141
87	RD00328	SMD precise resistor 1/10W	8.66KΩ ±1% 0603	R79,R82,R83,R84,R85,R86
88	RD00214	SMD precise resistor 1/10W	10.0KΩ ±1% 0603	R17,R18,R20,R21,R77,R78,R80,R81,R101,R102,R107,R108,R109,R110,R111,R112,R113,R114,R115,R116
89	RD00217	SMD precise resistor 1/10W	14.0KΩ ±1% 0603	R132,R142,R143,R144
90	RD00218	SMD precise resistor 1/10W	15.0KΩ ±1% 0603	R29,R30,R33,R34,R37,R38,R39,R40,R45,R46,R47,R48
91	RD00219	SMD precise resistor 1/10W	20.0KΩ ±1% 0603	R95,R96,R97,R98,R99,R100
92	RD00290	SMD precise resistor 1/10W	47.5KΩ ±1% 0603	R103,R104,R105,R106
93	RD00224	SMD precise resistor 1/10W	100KΩ ±1% 0603	R87,R88,R89,R90,R91,R92,R93,R94
94	RD00292	SMD precise resistor 1/10W	1.00MΩ ±1% 0603	R121,R122,R123,R124,R125,R126,R127,R128
95	RD00319	SMD precise resistor 1/10W	2.00MΩ ±1% 0603	R9,R10,R11,R12,R13,R14,R15,R16
96	CI00109	SMD ceramic capacitor 0603	20PF/50v NPO ±5%	C13,C14,C15,C16,C17,C18,C19,C20
97	CI00075	SMD ceramic capacitor 0603	0.1uF/50V Y5V +80,-20%	C29,C30,C31,C32,C34,C35,C36,C37,C38,C39,C40,C41,C42,C43,C44,C45,C46,C47,C48,C49,C50,C51,C52,C53,C54,C55,C56,C57,C58,C59,C60,C61,C62,C63,C64,C65,C66,C67,C68,C69,C70,C71,C72,C73,C74,C75,C76,C77,C78,C79,C33,C80
98	CI00030	SMD ceramic capacitor 0805	1uF/16V Y5V-0805(2012)	C21,C22,C23,C24,C25,C26,C27,C28
99	SE00011	SMD rectifier diode	RLS4148 0.5A (LL-34)	D1,D2,D3,D4,D5,D6,D7,D8,D9,D10,D11,D12,D13,D14,D15,D16,D17,D18,D19,D20,D21,D22,D23,D24
100	SF00004	SMD transistor	2SA1036K(SOT-23)/(R)	TR1,TR2,TR3,TR4,TR5,TR6,TR7,TR8
101	SG00122	SMD integrated circuit	NJM4580M-TE3	IC1,IC2,IC3,IC4,IC5,IC6,IC7,IC8
102	SG00116	SMD integrated circuit	BA1033FV E2	IC9,IC10,IC11,IC13,IC15,IC17,IC19,IC21
103	RD00059	SMD fixed resistor 1/10W	0.0Ω ±5% 0603	R145,R146,R147,R148,R149,R150,R151,R152,R153,R154,R155,R156
104	RA00212	fixed resistor 1/4W	1.0KΩ M type	R157,R158,R159,R160,R161,R162,R163
105	RA00215	fixed resistor 1/4W	1.2KΩ M type	R0

ALTO LINK Parts List

No.	Part No.	Description	Specification	Remark
106	RA00219	fixed resistor 1/4W	1.8K Ω M type	R1,R2,R3,R4,R5,R6,R7,R8
107	CB00054	electrolytic capacitor	220uF/10V ϕ 5*11mm	C1,C2,C3,C4,C5,C6,7,C8,C9,C10
108	CB00039	electrolytic capacitor	47uF/25V ϕ 5*11mm	C11,C12
109	RC00203	potentiometer	A100K Ω L:35 R1411GOA-V1A104FN00-00	VR1,VR2
110	RC00230	potentiometer	A100K Ω R0911NOB-V1-A104FN00-00	VR3,VR5,VR7,VR9,VR11,VR13
111	RC00205	potentiometer	B10K Ω L:35 R1411GOA-V1B103FN00-00	VR4,VR6,VR8,VR10,VR12,VR14
112	SA00071	L.E.D	ϕ 3 green LVG2340/A	LED1,LED2,LED3,LED4,LED5,LED6,LED7,LED8,LED9,LED10,LED11,LED12,LED13,LED17,LED18,LED19,LED23,LED24,LED25,LED29,LED30,LED31,LED35,LED36,LED37,LED41,LED42,LED43,LED47,LED48,LED49
113	SA00072	L.E.D	ϕ 3 red LI2340/A	LED14,LED20,LED26,LED32,LED38,LED44,LED50,LED51
114	HI00163	push-button switch	2 stage 12P PS-42E85	SW1,SW2,SW3,SW4,SW5,SW6,SW7
115	HC00076	row-wire header(male)	2P 2.5mm 180°	CN3
116	HC00261	row-wire header(male)	12P 2.0mm 180°	J1,J2
117	NI01772	LED spacer support	LEDS-7 7mm	
118	HA01931	jumper wire	16mm	LED58,LED59,LED60,LED61,LED62,LED63
119	HA02249	wire	ϕ 0.6	
120	HK02405	PC board	P-LINKRP-DIP	
121	HK02404	PC board	P-LINKRP-SMD	
122	HB00864	PCB	LINKRP(1*4)_VER030102	
123	RD00059	SMD fixed resistor 1/10W	0.0 Ω \pm 5% 0603	R155,R156,R157,R158,R159,R160
124	RD00297	SMD precise resistor 1/10W	60.4 Ω \pm 1% 0603	R123,R124,R125,R126,R127,R128,R129,R130,R131,R132,R133,R134,R135,R136,R137,R138
125	RD00271	SMD precise resistor 1/10W	2.67K Ω \pm 1% 0603	R139,R140,R141,R142,R143,R144,R145,R146
126	RD00363	SMD precise resistor 1/10W	3.16K Ω \pm 1% 0603	R75,R76,R77,R78,R79,R80,R81,R82,R83,R84,R85,R86,R87,R88,R89,R90
127	RD00285	SMD precise resistor 1/10W	3.24K Ω \pm 1% 0603	R99,R100,R101,R102,R103,R104,R105,R106
128	RD00286	SMD precise resistor 1/10W	4.53K Ω \pm 1% 0603	R107,R108,R109,R110,R111,R112,R113,R114,R115,R116,R117,R118,R119,R120,R121,
129	RD00299	SMD precise resistor 1/10W	5.76K Ω \pm 1% 0603	R91,R92,R93,R94,R95,R96,R97,R98
130	RD00300	SMD precise resistor 1/10W	6.04K Ω \pm 1% 0603	R147,R148,R149,R150,R151,R152,R153,R154
131	RD00328	SMD precise resistor 1/10W	8.66K Ω \pm 1% 0603	R71,R72
132	RD00214	SMD precise resistor 1/10W	10.0K Ω \pm 1% 0603	R1,R2,R3,R4,R5,R6,R7,R8,R9,R10,R11,R12,R13,R14,R15,R16,R17,R18,R19,R20,R21,R22,R23,R24,R25,R26,R27,R28,R29,R30,R31,R32,R33,R34,R35,R36,R37,R38,R39,R40,R41,R42,R43,R44,R45,R46,R47,R48
133	RD00219	SMD precise resistor 1/10W	20.0K Ω \pm 1% 0603	R49,R50,R51,R52,R53,R54,R55,R56,R57,R58,R59,R60,R61,R62,R63,R64,R65,R66,R67,R68,R69,R70
134	RD00224	SMD precise resistor 1/10W	100K Ω \pm 1% 0603	R73,R74
135	CI00047	SMD ceramic capacitor 0603	10PF/50V NPO \pm 5%	C35,C36,C37,C38,C39,C40,C41,C42,C43,C44,C45,C46,C47,C48,C49,C50
136	CI00109	SMD ceramic capacitor 0603	20PF/50v NPO \pm 5%	C33,C34
137	CI00055	SMD ceramic capacitor 0603	47PF/50V NPO \pm 5%	C1,C2,C3,C4,C5,C6,C7,C8,C9,C10,C11,C12,C13,C14,C15,C16,C17,C18,C19,C20,C21,C22,C23,C24,C25,C26,C27,C28,C29,C30,C31,C32
138	CI00063	SMD ceramic capacitor 0603	470PF/50V NPO \pm 5%	C51,C52,C53,C54,C55,C56,C57,C58,C59,C60,C61,C62,C63,C64,C65,C66
139	CI00075	SMD ceramic capacitor 0603	0.1uF/50V Y5V +80,-20%	C73,C74,C75,C76,C77,C78,C79,C80,C81,C82,C83,C84,C85,C86,C87,C88,C89,C90,C91,C92,C93,C94,C95,C96,C97,C98,C99,C100,C101,C102,C107,C108,C109,C110,C111,C112
140	SG00122	SMD integrated circuit	NJM4580M-TE3	IC3,IC4,IC5,IC6,IC7,IC8,IC9,IC10,IC11,IC12,IC13,IC14,IC15,IC16,IC17,IC18

ALTO LINK Parts List

No.	Part No.	Description	Specification	Remark
141	CB00039	electrolytic capacitor	47uF/25V ϕ 5*11mm	C67,C68,C69,C70,C71,C72
142	CB00056	electrolytic capacitor	220uF/25V ϕ 8*11mm	C105,C106
143	CB00134	electrolytic capacitor	1000uF/35V 105°C SH ϕ 12*21mm	C104,C103
144	SA00001	bridge rectifier	1A/400V RB154	BD1
145	HC00126	XLR MIC jack	JY-5042-030G female plug 180°	CN1,CN2,CN5,CN6,CN7,CN10
146	HC00392	XLR MIC jack	JY-5030-030G 180°	CN3,CN4,CN8,CN9,CN11,CN12
147	HC00125	MIC jack	JY-6351G-02-250	PJ1,PJ2,PJ3,PJ4
148	HA02078	wire	12P(male)-12P(female) 220	J1,J2
149	HC00172	row-wire header(male)	3P 3.96mm 180°	J3
150	NB02088	box	(1H) ALTO 19"	
151	NE02717	label	MADE IN CHINA	
152	NH00038	paper	0.115*1M	
153	NI00028	membrane	0.110*1M	
154	SD00077	integrated circuit	L7815CV(TO-220)(ST)	
155	SD00079	integrated circuit	L7915CV(TO-220)(ST)	
156	MJ00123	heat-sink(white)	65*18*4 SCX-P234	
157	MJ00115	heat-sink	CLE2.0 4*80.5*18_V1.1	
158	NC00005	silicone insulator	TO-220 square type	
159	MG00162	screw	M3*8	
160	NI02249	insulate bean	TW-1(TO-220)	
161	HA02190	wire	150mm	
162	AD00012	twin adhesive	90*120mm_V1.0	
163	NA00279	clip-chain bag	0.04t*100*150mm_V1.0	