

# *Owner's Guide*

*for the*



*Ampeg*

## *B2/B2R*

### *Bass Amplifier*



Made in the U.S.A. by



*Ampeg*



**TABLE OF CONTENTS**

Introduction ..... 2  
 Features ..... 2  
 Important Safeguards and Precautions ..... 3  
 The Front Panel Controls and Their Use ..... 4  
 The Rear Panel ..... 5  
 Some Suggested Settings ..... 6  
 Rack Mounting (B2R only) ..... 6  
 Troubleshooting ..... 7  
 System Block Diagram ..... 7  
 Technical Specifications ..... back cover

**An introduction To Your New Ampeg B2/B2R Bass Amplifier**

**Thank you** for making one of the best choices you will ever make for your musical career – choosing one of the finest bass amplifiers available, the Ampeg B2/B2R.

Whether you've purchased the portable B2 combo system or the two-space rack-mountable B2R head version, your new B2/B2R bass amplifier provides many outstanding features. Three hundred and fifty watts of pure bass energy, total tone control and rugged construction make each one a true performer's bass amp.

**Features**







In the world of high performance bass amps, Ampeg's SVT amplifiers stand alone. In true Ampeg tradition, the B2/B2R offers you more power, performance and flexibility than any other bass amplifier in its class. The outstanding features of your new amplifier, features which set it apart from the competition, are listed below.

- **9-BAND GRAPHIC EQ:** Use as a "second channel" for bass solos, or to shape your sound to your own exacting standards.
- **BALANCED LINE OUTPUT:** XLR with independent level switch (20dB pad). Patch into house consoles, mixing boards, or external power amplifiers.
- **EFFECTS LOOP:** For increased intensity and quieter operation of external effects.
- **POWER AMP IN and PREAMP OUT:** Allows direct access into the power amp and a signal tap from the preamp section for even greater versatility.
- **MUSICIAN MADE IN THE U.S.A.**

## Important Safeguards and Precautions

All Ampeg products are designed for continuous, safe operation, as long as common sense is used and steps are taken to help avoid certain problems. Abiding by the following rules can help prevent damage to your amplifier, yourself and others.

- The amplifier is equipped with a three-pronged AC power cord. To reduce the risk of electrical shock, **NEVER** remove or otherwise attempt to defeat the ground pin of the power cord.
- Connect the amplifier **ONLY** to a properly grounded AC outlet of the proper voltage for your amp.
- Avoid sudden temperature extremes, rain and moisture. Also, avoid sudden and intense impact. (If the unit has been subjected to any of the preceding abuses, have it looked at by an authorized service center.)
- **NEVER** set the amplifier on a support that might give out under its weight.
- Whenever using tall or stacked speaker cabinets, use them **ONLY** on a level surface. **NEVER** set tall or stacked cabinets on a surface with more than a five degree incline since tipping or falling could occur, possibly causing serious injuries.
- Always keep the total speaker impedance at or above the rated load.
- Unplug the amplifier before cleaning it. **NEVER** spray liquid cleaners onto the amplifier. Wipe it with a slightly dampened, lint-free cloth to remove dirt and film.
- Don't use the amplifier if it has sustained damage to the chassis, controls, or power cord. Refer the unit to an authorized service center for inspection.
- Amplifiers capable of producing high volume levels are also capable of inflicting permanent hearing loss or damage, if the exposure to such levels is prolonged. Such damage is progressive and irreversible!

 <div style="display: inline-block; text-align: center;"> <p><b>CAUTION</b></p> <p>RISK OF ELECTRIC SHOCK DO NOT OPEN</p> </div> 	 <div style="display: inline-block; text-align: center;"> <p><b>ATTENTION</b></p> <p>RISQUE D'ELECTROCUTION NE PAS OUVRIR</p> </div> 	 <div style="display: inline-block; text-align: center;"> <p><b>VORSICHT</b></p> <p>ELEKTRISCHE SCHLAGEGFAHR NICHT OFFENEN</p> </div> 
<p>CAUTION: TO REDUCE THE RISK OF ELECTRIC SHOCK, DO NOT REMOVE COVER. NO USER-SERVICEABLE PARTS INSIDE. REFER SERVICING TO QUALIFIED SERVICE PERSONNEL.</p>	<p>ATTENTION: POUR REDUIRE D'ELECTROCUTION NE PAS ENLEVER LE COUVERCLE. AUCUNE PIECE INTERNE N'EST REPARABLE PAR L'UTILISATEUR. POUR TOUTE REPARATION, S'ADRESSER A UN TECHNICIEN QUALIFIE.</p>	<p>VORSICHT: ZUR MINIMIERUNG ELEKTRISCHER SCHLAGEGFAHR NICHT DEN DECKEL ABNEHMEN. INTERNE TEILE KÖNNEN NICHT VOM BENUTZER GEWARTET WERDEN. DIE WARTUNG IS QUALIFIZIERTEM WARTUNGSPERSONAL ZU ÜBERLASSEN.</p>

THIS EQUIPMENT HAS BEEN DESIGNED AND ENGINEERED TO PROVIDE SAFE AND RELIABLE OPERATION. IN ORDER TO PROLONG THE LIFE OF THE UNIT AND PREVENT ACCIDENTAL DAMAGES OR INJURY, PLEASE FOLLOW THESE PRECAUTIONARY GUIDELINES:

**WARNING:** TO REDUCE THE RISK OF ELECTRIC SHOCK, DO NOT OPEN CHASSIS; DO NOT DEFEAT OR REMOVE THE GROUND PIN OF THE POWER CORD; CONNECT ONLY TO A PROPERLY GROUNDED AC POWER OUTLET.



**CAUTION:** TO REDUCE THE RISK OF FIRE OR ELECTRIC SHOCK, DO NOT EXPOSE THIS EQUIPMENT TO RAIN OR MOISTURE.

**CAUTION:** NO USER-SERVICEABLE PARTS INSIDE. REFER SERVICING TO QUALIFIED SERVICE PERSONNEL.

**CAUTION:** OUR AMPLIFIERS ARE CAPABLE OF PRODUCING HIGH SOUND PRESSURE LEVELS. CONTINUED EXPOSURE TO HIGH SOUND PRESSURE LEVELS CAN CAUSE PERMANENT HEARING IMPAIRMENT OR LOSS. USER CAUTION IS ADVISED AND EAR PROTECTION IS RECOMMENDED IF UNIT IS OPERATED AT HIGH VOLUME. The chart below shows the U.S. Government Occupational Safety and Health Administration (OSHA) regulations which were in effect at the time of this publication for permissible noise exposure, per 29CFR1910, Table G-16.

SOUND LEVEL dBA SLOW RESPONSE	DURATION PER DAY IN HOURS	SOUND LEVEL dBA SLOW RESPONSE	DURATION PER DAY IN HOURS
90	8	102	1-1/2
92	6	105	1
95	4	110	1/2
97	3	115	1/4 or less
100	2		

According to OSHA, any exposure in excess of those listed above could result in some hearing loss.

<p>EXPLANATION OF GRAPHICAL SYMBOLS:</p>	 = "DANGEROUS VOLTAGE" "DANGER HAUTE TENSION" "GEFAHRLICHE SPANNUNG"	 = "IT IS NECESSARY FOR THE USER TO REFER TO THE INSTRUCTION MANUAL" "REFERREZ-VOUS AU MANUAL D'UTILISATION" "UNBEDINGT IN DER BEDIENUNGSANLEITUNG NACHSCHLAGEN"
--	---	---



## The Front Panel Controls and Their Use

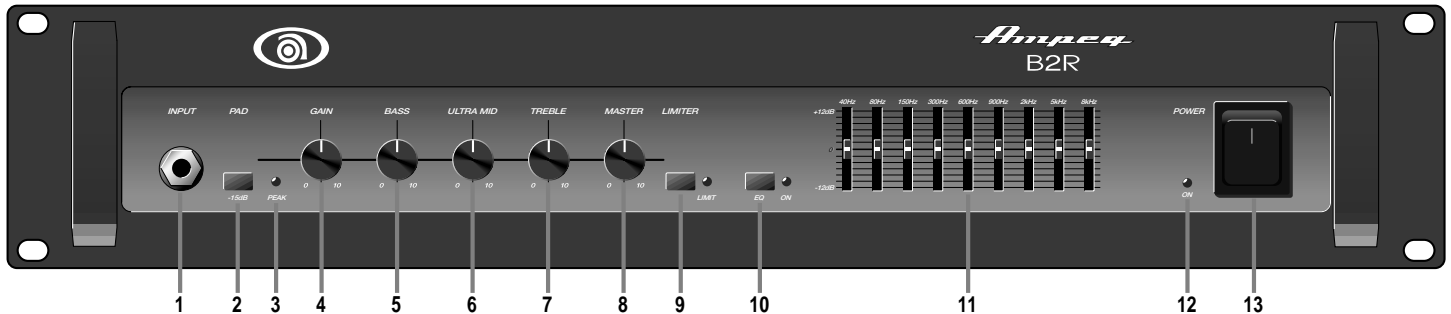

**1. 0dB (INPUT):** The signal output from an instrument (active or passive) or a line level signal may be connected here by means of a shielded instrument cable.

**2. 15dB PAD:** This switch, when depressed, attenuates the input signal by 15dB. Attenuation allows the Gain control (#4) to be used over a larger portion of its range. If clipping is indicated with the Gain control near minimum, attenuation is needed.

**3. PEAK LED:** This LED flashes when the signal level into the preamp approaches clipping. Adjust the Gain control (#4) until a strong signal from your instrument causes this LED to flicker.

**NOTE:** If the LED flashes frequently with the gain at a low setting, use the 15dB Pad (#2) to attenuate the input signal and readjust the Gain.

**4. GAIN:** This serves as the input level control for the amplifier. For the best signal-to-noise ratio set this control so the Peak LED (#3) flashes when you strike a string fairly hard.

**5. BASS:** This is the primary low frequency control which allows for 8dB of cut or boost at 50Hz.

**6. ULTRA-MID:** This is the primary midrange control. Rotate the control to the left of center for a “contoured” sound (more distant, less midrange output) or to the right of center for a pronounced (more up-front) tone.

**7. TREBLE:** This is the primary high frequency control which allows for 12dB of boost or 19dB of cut at 5kHz.

**8. MASTER:** Set the overall output level of the amplifier with this control. The Effects Loop and Balanced Out (#19-21,24) are not affected by the Master control.

**9. LIMITER:** The B2/B2R uses an internal Optocoupler Limiter to assist in keeping the power amplifier’s output “clean” at extreme volume levels. (All amplifiers begin to clip their output signals as they approach maximum output levels, resulting in distortion which may damage your speakers.) To engage the Limiter, depress the Limit switch. Whenever the amplifier is at full power, the adjacent LED will flash. This is an indication that the limiter is keeping peak signals from clipping the output.

**NOTE:** Playing at full power with the Limiter off will give you increased output power, but the sound may be distorted. Use discretion when playing without the Limiter.

**10. EQ ON SWITCH:** Depress this switch to activate the Graphic EQ. The adjacent LED illuminates when the EQ is on.

**11. GRAPHIC EQ:** These sliders control the output of the frequencies indicated above each control. The center position of each control is flat (no boost or cut).

**12. POWER ON LED:** This LED indicator illuminates when the POWER switch (#13) is ON.

**13. POWER SWITCH:** This heavy-duty rocker switch applies the power to the amplifier. The amp is ON when the top of the switch is depressed, OFF when the bottom of the switch is depressed.

## The Rear Panel

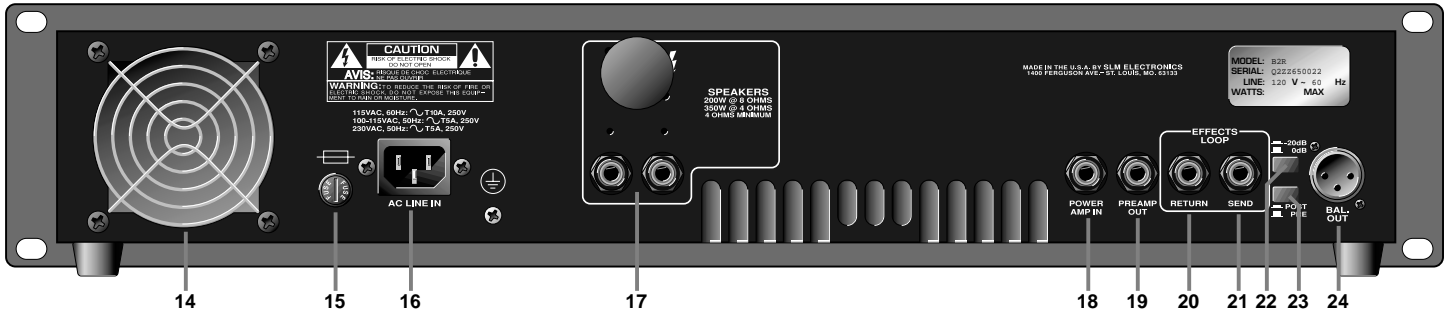

**14. FAN:** This temperature controlled, variable speed fan draws cool air into the amplifier, which forces heat out through the exhaust vents. Never block the vent holes or the fan opening.

**15. FUSE:** This protects the unit from damage due to overload conditions or power line surges. If the fuse blows, replace it only with the same size and type.

**16. AC LINE IN:** Firmly insert the supplied AC power cord into this socket until it is fully seated. Plug the male end of the cord into a grounded AC outlet. **DO NOT DEFEAT THE GROUND PRONG OF THE AC PLUG!**

**17. SPEAKER OUTPUTS:** Use these jacks to connect the amplifier to your speaker(s) using cables terminated with 1/4" connectors. For the B2 combo, use the supplied speaker cable to connect the output of the amplifier to the speaker jack. An extension speaker with an impedance of 8 ohms or higher may be connected and allows the amplifier to deliver its maximum power.

**NOTE:** In some areas 1/4" jacks are not acceptable for use as extension speaker jacks. For this reason the 1/4" jacks on your amplifier may be factory-sealed. In such cases use the Speakon® jack to connect to external speaker cabinets.

For the B2R, connect the output(s) using high quality speaker cables.

**NOTE:** When connecting multiple speaker cabinets to the B2/B2R, keep the overall impedance at or above four ohms! The following chart shows the total impedance load when connecting speaker cabinets in parallel:

Cabinet Impedance	# of Cabs	Total Impedance
8Ω	2	4Ω
16Ω	2	8Ω
16Ω	4	4Ω

**18. POWER AMP IN:** This mono jack allows you to feed the preamp output of another amplifier to the input of the B2/B2R's internal power amp. This bypasses the preamp circuitry of the B2/B2R.

**WARNING:** This jack goes directly into the power amplifier. DO NOT connect high level signals to it!

**19. PREAMP OUT:** A post-EQ signal may be taken from this jack and sent to the house mixing board, recording console or external power amplifier.

**20. EFFECTS RETURN:** To use an external effects device, connect the OUTPUT of the device to this jack by means of a shielded cable. This feeds the processed signal into the Master section of the B2/B2R.

**21. EFFECTS SEND:** Connect the output from this jack to the INPUT of your effects by means of a shielded cable. This sends a post-EQ signal to your effects.

**22. -20dB SWITCH :** This switch adjusts the output level at the Balanced Line Output jack (#24). The control works independently from the front panel Master control. Depressing the switch activates the 20dB pad. The result is a signal that is more compatible with the microphone inputs on a mixer.

**23. PRE/POST SWITCH:** You can select either Pre or Post EQ for the signal at the Balanced Out jack (#24) with this switch. With the switch in the OUT position, the signal at the jacks will be Pre-EQ. This is a direct output not affected by any EQ or boost settings. With the switch depressed, the signal is Post-EQ and is controlled and modified by the tone controls, Graphic EQ, and Effects Loop.

**24. BALANCED OUTPUT:** This XLR-type connector supplies a balanced preamp output signal for connecting to a house mixing board, recording console or external amplifiers with balanced inputs. The signal can be set to Pre or Post EQ by the back panel Pre/Post switch (#23). The level can be adjusted for either mic or line type inputs using the -20dB switch (#22).



## Some Suggested Settings

The setting of the Gain control depends on your particular instrument. The Master should be set to produce the appropriate output volume level. The Graphic EQ can be used to tailor the amplifier to your speaker cabinets, to compensate for room acoustics and to "fine tune" your sound.

### ROCK:

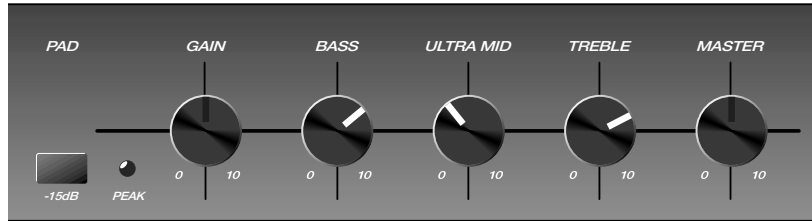

### JAZZ:

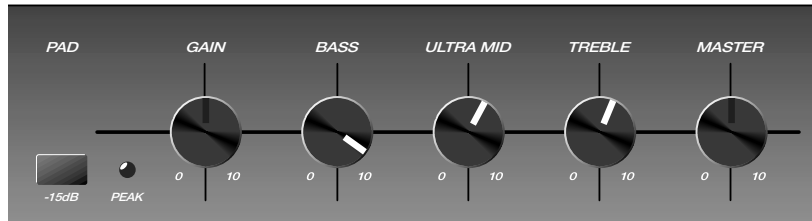

### COUNTRY:

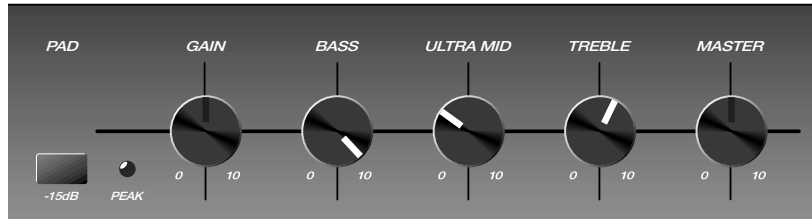

### FUNK "POPPING:"

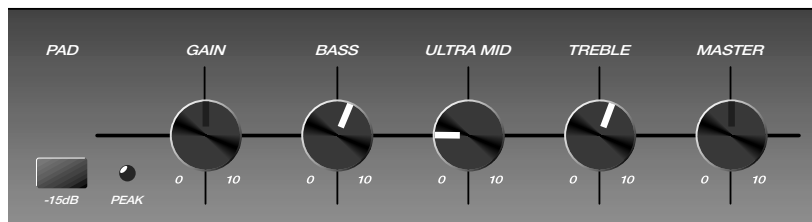

## Rack Mounting (B2R only)

When mounting the B2R into a rack, the four bottom feet should be removed to maintain the two rack space height of the amplifier. Be sure to keep the feet and their attachment bolts for future use. If the feet are reinstalled, never use screws which will protrude farther into the amplifier than the original hardware.

The rack must be a high quality enclosure capable of securely supporting the weight of the amplifier. Tighten the mounting screws securely through the amplifier's face plate, into the rack rails. Check the rack and mounting screws occasionally to ensure a continually safe and secure installation.

## Troubleshooting

In the unlikely event that your B2/B2R should malfunction, take a few minutes to troubleshoot it before you call for service. You can save yourself a lot of time and sometimes money by doing it yourself, and often the cure for the problem is something quite simple.

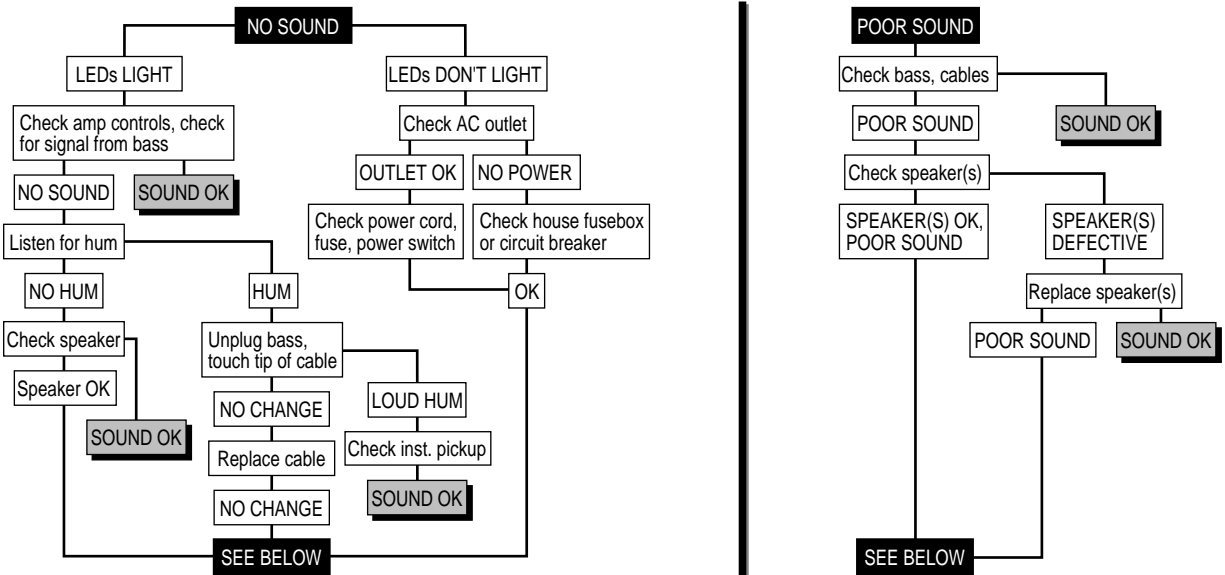

If the problem isn't covered above, or if the steps lead you here, then contact your Ampeg dealer for service information. Also, you should refer your amp to an authorized service center for servicing if it gets dropped, has liquid spilled into it, or sustains damage to its power cord (see page 3).

## System Block Diagram

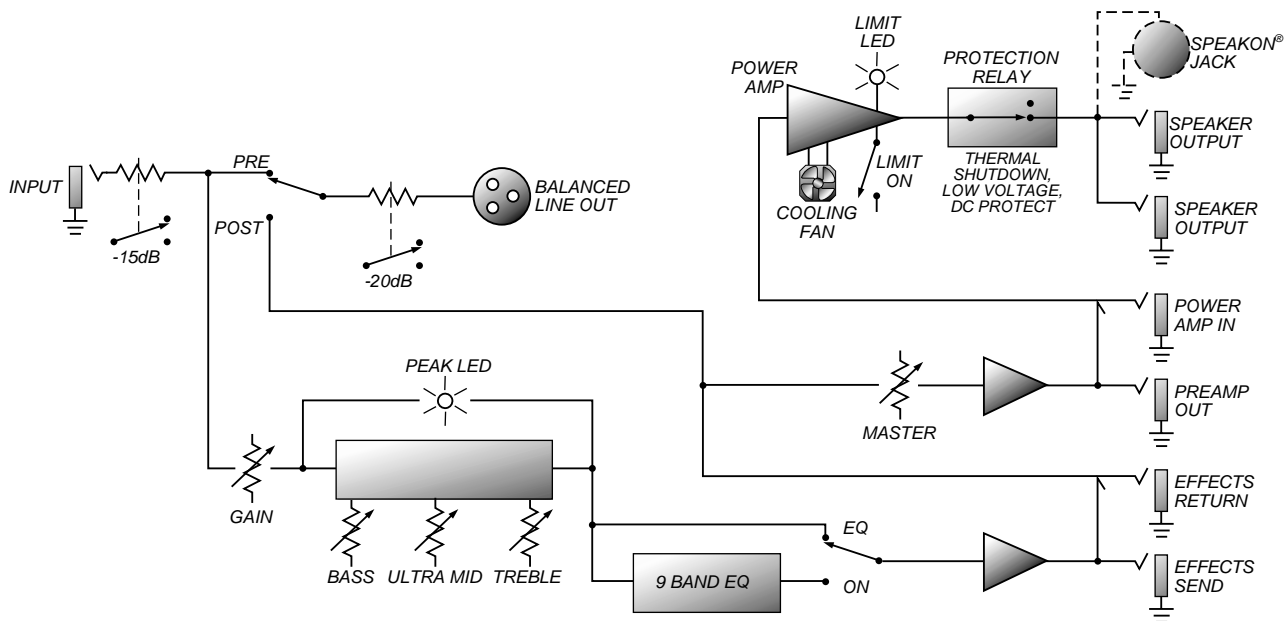



**Technical Specifications**

**OUTPUT POWER RATING** 350 Watts RMS, 4 ohm load, 120VAC  
200 Watts RMS, 8 ohm load, 120VAC

**POWER REQUIREMENTS**

**Domestic:** 120VAC, 60Hz, 310VA  
**Export:** 100/120VAC, 50/60Hz, 310VA  
230-240VAC, 50/60Hz, 310VA

**TONE CONTROL RANGE**

**Bass:** ±8dB @ 50Hz  
**Ultra Mid:** ±8dB @ 500Hz  
**Treble:** +12dB/-19dB @ 5kHz

**GRAPHIC EQ RANGE**

**40Hz:** ±11dB  
**80Hz:** ±8dB  
**150Hz:** ±8dB  
**300Hz:** ±8dB  
**600Hz:** ±8dB  
**900Hz:** ±8dB  
**2kHz:** ±8dB  
**5kHz:** ±9dB  
**8kHz:** ±12dB

**GAIN** 45dB typical, tones @ center

**SIGNAL TO NOISE RATIO** 75dB typical

**INTERNAL SPEAKER (B2 ONLY)**

**Size/Type:** 15" Ampeg Custom (1)  
**Magnet:** 56 oz.  
**Voice Coil:** 2.5"  
**Impedance:** 8 ohms

**SIZE AND WEIGHT**

**B2:** 24" W x 24.5" H (26.5" w/casters) x 16" D; 87 lbs.  
**B2R:** 19" W x 1.75" H x 12.75" D; 15 lbs.



[www.ampeg.com](http://www.ampeg.com)

*Ampeg reserves the right to change specifications without notice.*

