

User's Guide for the



SVT-6 PRO

Bass Amplifier



Proudly Made in the U.S.A. by Ampeg®



TABLE OF CONTENTS

Introduction	3
Features	3
The Front Panel	4
The Rear Panel	5
Some Suggested Settings	6
Rack Mounting	6
Troubleshooting	7
System Block Diagram	7
Technical Specifications	back cover

Declaration of Conformity

Manufacturer's Name: SLM Electronics
Corporate Headquarters: 1901 Congressional Drive, St. Louis, Missouri 63146
Primary Production Facility: 700 Hwy 202 W, Yellville, Arkansas, 72687
Product Type: Audio Amplifier

Products meet the regulations for compliance marking under:

- ETL standards UL6500, UL60065, or UL813
- CSA standards E60065 or C22.2 No.1-M90
- CE safety standard EN60065
- CE EMC standards EN55103 or EN55013 and EN61000
- FCC standards 47CFR 15.107 and 15.109 Class A
- C-tick designation Level 2, ABN #56748810738, ARBN# N222
- KETI standard K60065 (limited model approval)

Compliance Support Contact: SLM Electronics, Attn: R&D Compliance Engineer
 1901 Congressional Drive, St Louis, Missouri, 63146 • Tel.: 314-569-0141, Fax: 314-569-0175

	CAUTION RISK OF ELECTRIC SHOCK DO NOT OPEN	
<small>WARNING: TO REDUCE THE RISK OF FIRE OR ELECTRIC SHOCK, DO NOT EXPOSE THIS APPARATUS TO RAIN OR MOISTURE. TO REDUCE THE RISK OF ELECTRIC SHOCK, DO NOT REMOVE COVER. NO USER-SERVICEABLE PARTS INSIDE. REFER SERVICING TO QUALIFIED SERVICE PERSONNEL.</small>		

	PRECAUCION RIESGO DE CORRIENTAZO NO ABRA	
<small>PRECAUCION: PARA REDUCIR EL RIESGO DE INCENDIOS O DESCARGAS ELECTRICAS, NO PERMITA QUE ESTE APARATO QUEDA EXPUESTO A LA LLUVIA O LA HUMEDAD. PARA DISMINUIR EL RIESGO DE CORRIENTAZO, NO ABRA LA CUBIERTA. NO HAY PIEZAS ADENTRO QUE EL USUARIO PUEDA REPARAR. DEJE TODO MANTENIMIENTO A LOS TECNICOS CALIFICADOS.</small>		

	ATTENTION RISQUE D'ELECTROCUTION NE PAS OUVRIR	
<small>ATTENTION: PROTEGEZ CET APPAREIL DE LA PLUIE ET DE L'HUMIDITE AFIN D'EVITER TOUT RISQUE D'INCENDIE OU D'ELECTROCUTION. POUR REDUIRE D'ELECTROCUTION NE PAS ENLEVER LE COUVERCLE. AUCUNE PIECE INTERNE N'EST REPARABLE PAR L'UTILISATEUR. POUR TOUTE REPARATION, S'ADRESSEZ A UN TECHNICIEN QUALIFIE.</small>		

IMPORTANT SAFETY INSTRUCTIONS

- READ, FOLLOW, HEED, AND KEEP ALL INSTRUCTIONS AND WARNINGS.
- DO NOT OPERATE NEAR ANY HEAT SOURCE AND DO NOT BLOCK ANY VENTILATION OPENINGS ON THIS APPARATUS. FOR PROPER OPERATION, THIS UNIT REQUIRES 3" (75CM) OF WELL VENTILATED SPACE AROUND HEATSINKS AND OTHER AIR FLOW PROVISIONS IN THE CABINET.
- DO NOT USE THIS APPARATUS NEAR SPLASHING, FALLING, SPRAYING, OR STANDING LIQUIDS.
- CLEAN ONLY WITH LINT-FREE DAMP CLOTH AND DO NOT USE CLEANING AGENTS.
- ONLY CONNECT POWER CORD TO A POLARIZED, SAFETY GROUNDED OUTLET WIRED TO CURRENT ELECTRICAL CODES AND COMPATIBLE WITH VOLTAGE, POWER, AND FREQUENCY REQUIREMENTS STATED ON THE REAR PANEL OF THE APPARATUS.
- PROTECT THE POWER CORD FROM DAMAGE DUE TO BEING WALKED ON, PINCHED, OR STRAINED.
- UNPLUG THE APPARATUS DURING LIGHTNING STORMS OR WHEN UNUSED FOR LONG PERIODS OF TIME.
- ONLY USE ATTACHMENTS, ACCESSORIES, STANDS, OR BRACKETS SPECIFIED BY THE MANUFACTURER FOR SAFE OPERATION AND TO AVOID INJURY.
- WARNING: TO REDUCE THE RISK OF ELECTRIC SHOCK OR FIRE, DO NOT EXPOSE THIS UNIT TO RAIN OR MOISTURE.
- SERVICE MUST BE PERFORMED BY QUALIFIED PERSONNEL.
- OUR AMPLIFIERS ARE CAPABLE OF PRODUCING HIGH SOUND PRESSURE LEVELS. CONTINUED EXPOSURE TO HIGH SOUND PRESSURE LEVELS CAN CAUSE PERMANENT HEARING IMPAIRMENT OR LOSS. USER CAUTION IS ADVISED AND EAR PROTECTION IS RECOMMENDED IF UNIT IS OPERATED AT HIGH VOLUME.
- WARNING: THIS UNIT REQUIRES A SAFETY GROUNDED OUTLET WIRED TO CURRENT ELECTRIC CODES HAVING THE LINE SUPPLY VOLTAGE, POWER, AND FREQUENCY IDENTIFIED ON THE REAR OF THE UNIT. THE OUTLET MUST REMAIN ACCESSIBLE TO DISCONNECT THE UNIT IF A FAULT SHOULD ARISE WHILE IN USE. THIS UNIT SHOULD BE UNPLUGGED WHEN NOT IN USE.



EXPLANATION OF GRAPHICAL SYMBOLS:
 EXPLICACION DE SIMBOLOS GRAFICOS:
 EXPLICATION DES SYMBOLES GRAPHIQUES:

= "DANGEROUS VOLTAGE"
 "VOLTAJE PELIGROSO"
 "DANGER HAUTE TENSION"

= "IT IS NECESSARY FOR THE USER TO REFER TO THE INSTRUCTION MANUAL."
 "ES NECESARIO QUE EL USUARIO SE REFIERA AL MANUAL DE INSTRUCCIONES."
 "REFERREZ-VOUS AU MANUAL D'UTILISATION"



An Introduction to your new Ampeg SVT-6 PRO Bass Amplifier

The harmonically rich sound and legendary performance of the AMPEG SVT are redefined in the SVT-6 PRO. This versatile and powerful bass amplifier delivers up to 1100 watts of unsurpassed musical power, and offers the classic vibrancy of tubes with several outstanding features.

All of the features and controls of your SVT-6 PRO are covered in detail within the pages of this user's guide. We recommend that you go over them before you use the amplifier.

Features

In the world of high performance bass amps, Ampeg's SVT amplifiers stand alone. In true Ampeg tradition, the SVT-6 PRO offers you more power, performance and flexibility than any other bass amplifier in its class. Below are some of the outstanding features of your new amplifier - features which set it apart from the competition!

- **TUBE PREAMP:** 4 gain stages for high headroom and clarity
- **TUBE DRIVEN MOSFET POWERAMP:** The sound of a tube driver and the high power output available from MOSFETs
- **COMPRESSION CONTROL:** Allows you to control the dynamics of the tonal response characteristics of the preamp, from punchy to compressed
- **TUBE VOLTAGE:** Control the dynamics of tonal response characteristics from the power amp, from punchy to compressed
- **4-BAND SEMI-PARAMETRIC EQ:** Shape your sound to your own exacting standards, or eliminate unwanted room vibrations or buzzing
- **TUNER OUT JACK:** Allows connection to an electronic tuner and provides an "always live" monitor feed even when the output is muted
- **SPEAKON® JACKS:** For more reliable connections at higher power outputs (in addition to 1/4" speaker out jacks)
- **TRANSFORMER BALANCED LINE OUTPUTS:** Independent level control - one transformer balanced XLR and one balanced/unbalanced 1/4" jack to patch into house consoles, mixing boards, or external power amplifiers, pre or post eq
- **EFFECTS LOOP:** Connect your effects here for increased intensity and quieter operation
- **POWER AMP IN/PREAMP OUT:** A separate preamp may be connected to the Power Amp In jack, and the Preamp Out jack may be connected to a slave amp
- **FOOTSWITCH CONTROL:** Use a footswitch to activate the Mute feature
- **CURRENT LIMITING:** The current limiting circuit provides protection against short or fault conditions at the output
- **CIRCUIT BREAKER PROTECTION:** A heavy duty resettable circuit breaker provides protection against fault conditions



The Front Panel

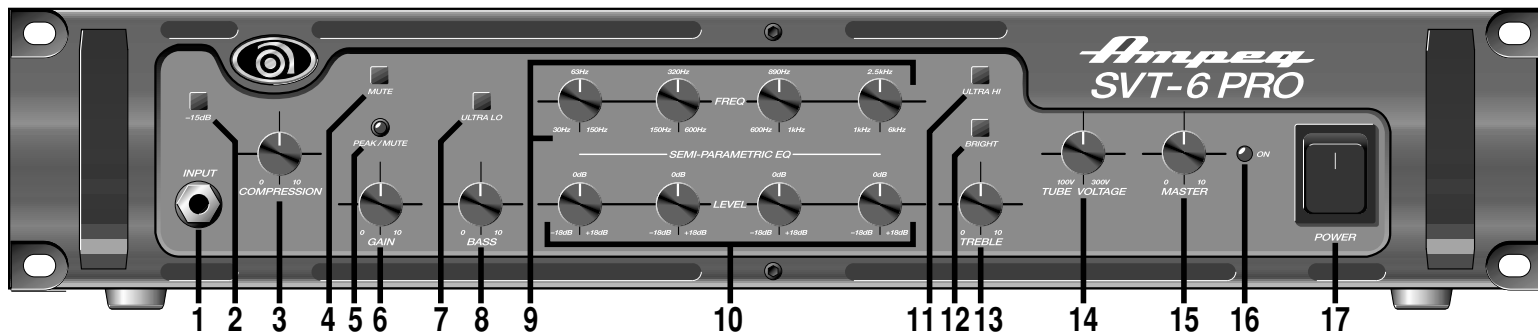

1. INPUT: Connect your bass guitar here by means of a shielded signal cable.

2. -15dB: This switch, when depressed, attenuates the input signal by 15dB. Attenuation allows the Gain control (#6) to be used over a larger portion of its range. If clipping is indicated with the Gain way down, attenuation is needed.

3. COMPRESSION: This controls the amount of signal compression. At the fully counterclockwise position there is no compression; at the fully clockwise position the compression ratio is 10:1. The sonic effect of compression is reduced dynamics, increased sustain and a more consistent output level regardless of how light or hard the strings are played. The compressor is very transparent – that is, there is very little effect on the tone of your instrument.

4. MUTE: This switch, when depressed, mutes all outputs except the Tuner Out (#25, rear panel). This allows you to use an electronic tuner without having to adjust any levels or turn down your house sound. The Peak/Mute LED (#5) illuminates when the Mute function is active. A footswitch may be used to control the mute function as long as this switch is in the out position. (The front panel switch remains active even when a footswitch is connected to the rear panel Footswitch jack – see #32, rear panel.)

5. PEAK/MUTE: This LED performs two functions. As a Peak LED it illuminates when the signal level into the preamp or power amp nears clipping. Adjust the Gain control (#6) until a strong signal from your instrument causes this LED to flicker with the Master control (#15) set low. As a Mute LED, it illuminates continually when the Mute function is active.

NOTE: If the LED flickers frequently with the Gain at a low setting, use the -15dB switch (#2) to attenuate the input signal and readjust the Gain. If the LED flickers only when the Master volume is increased, this may be rectified by turning the

Master control (#15) down or by turning the Compression control (#3) up. If the LED flickers after changing the settings of the EQ (#9, 10), the Gain control (#6) should be turned down.

6. GAIN: This controls the gain of the preamp. Adjust this control until the Peak/Mute LED (#5) flickers on strong signal peaks (but is not illuminated constantly while playing).

7. ULTRA LO: This switch, when depressed, greatly enhances the amount of low-end bass tones.

8. BASS: This control allows for 12dB of cut or boost at 50Hz. Use this control as your primary low frequency control.

9. SEMI-PARAMETRIC EQ FREQ: Use these controls to select the target frequencies for each of the four eq ranges. These controls, from left to right, cover the following ranges: 30-150Hz (bass), 150-600Hz (low mid), 600-1kHz (high mid), and 1k-6kHz (treble).

10. SEMI-PARAMETRIC EQ LEVEL: Each control allows for up to 18dB of cut or boost at the frequency selected by the Freq control directly above it.

NOTE: For each frequency band, the starting frequency has a small Q (bandwidth to amplitude ratio) while the ending frequency has a larger Q. In order to select a certain frequency with minimal side frequency overlap, use the Freq control where the desired frequency is located closest to its counterclockwise position. For example, to eliminate a 150Hz resonance, use the 150-600Hz Freq control instead of the 30-150Hz control.

11. ULTRA HI: This switch, when depressed, increases the high frequency output by 6dB at 5kHz.

12. BRIGHT: This switch, when depressed, adds a more lively top end response to the input signal.

13. TREBLE: This control allows for 19dB of cut or 14dB of boost at 5kHz.

14. TUBE VOLTAGE: The tube voltage control varies the high voltage supplied to the power amp tubes. This allows a variety of tonal response characteristics from the power amp and replaces the limiter found on typical solid state power amps. At “10” the voltage is at maximum, providing a dynamic, highly responsive tone. At “0” the voltage is at minimum, offer a thickened, more compressed tone. This tone can also be distorted, depending on volume level. In between settings are best for preventing harsh distortion when driving the power amp to its limits. The effect of this control increases from moderate to dramatic as the power amp is driven harder.

NOTE: When adjusting the tube voltage control from “10” to “0” rapidly, a low frequency hum as well as muting of the output signal occur simultaneously. This is due to shifting of the DC bias point of the tubes, and is no cause for concern. Adjusting the control from “0” to “10” brings a moderate delay due to the power supply capacitors charging.

15. MASTER: This controls the overall output level of the amplifier. For the best results, adjust the Gain control as directed (see #6) and use this control to obtain the desired volume level.

16. ON: This LED illuminates when the power is on.

17. POWER: This switch applies AC power to the amplifier: the amp is ON when the top of the switch is depressed, OFF when the bottom of the switch is depressed.

NOTE: Upon power up, there is a 30 to 40 second delay to allow all voltages to settle before the output relay engages. An occasional pop may be heard at varying levels. This is normal and is a result of the DC bias shifting associated with the tube driver section of the power amp.



SVT-6 PRO Bass Amplifier

The Rear Panel

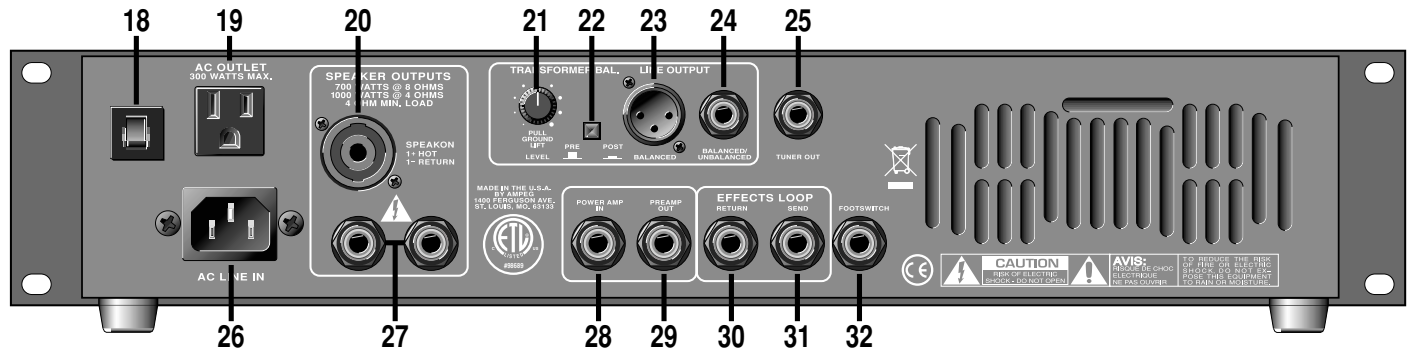

18. CIRCUIT BREAKER: The SVT-6 PRO employs an AC line circuit breaker to help protect against damages due to excessive current demands. If the amplifier stops working, check the circuit breaker.

19. AC OUTLET (Domestic units only): This unswitched outlet allows you to connect any AC powered device (such as an effects unit or electronic tuner) up to a maximum of 300 watts. This jack is “hot” whenever the amplifier is plugged into a live AC outlet, regardless of the setting of the Power switch.

20. SPEAKER OUTPUTS - SPEAKON: Use of this heavy duty connector is recommended when playing at full output levels. Connect the amplifier to your speaker cabinet(s) using heavy gauge speaker cables terminated with the appropriate connectors. Pin 1+ = hot, pin 1- = return.

21. TRANSFORMER BAL. LINE OUTPUT LEVEL / GROUND LIFT: This control adjusts the level at the Line Output jacks (#23, 24). This control works independantly from the front panel Master control. Pull this knob to engage the Ground Lift, if necessary, to help eliminate hum at the XLR jack.

22. TRANSFORMER BAL. LINE OUTPUT PRE/POST: The signal at the Line Output jacks (#23, 24) can be set to either Pre or post EQ with this switch. With the switch in the OUT position, the signal at the jacks is Pre-EQ. This

is a direct output not affected by any EQ or boost settings. With the switch depressed, the signal is Post-EQ and is controlled and modified by the tone controls, semi-parametric EQ, and the effects loop.

23, 24. TRANSFORMER BAL. LINE OUTPUT BALANCED/UNBALANCED: These jacks supply a line level signal for connection to a house mixing board, recording console or external amplifier. The signal level at these jacks is controlled by the Level control (#21) and is governed by the Pre/Post switch (#22).

25. TUNER OUT: This jack is provided for connection to an electronic tuner and is always “live,” even when the Mute switch (#3) is engaged. This allows for “silent tuning” as well as a monitor feed which stays hot even when the house mix is muted.

26. AC LINE IN: Firmly insert the supplied AC power cord into this socket until it is fully seated. Plug the male end of the cord into a grounded AC outlet. *DO NOT DEFEAT THE GROUND PRONG OF THE AC PLUG!*

27. SPEAKER OUTPUTS - 1/4”: These mono 1/4” jacks offer you a convenient method of connecting the amplifier to your speaker cabinet(s) using heavy gauge speaker cables terminated with the appropriate connectors. (Whenever playing at full output levels, it is recommended that you use the Speakon jacks, #20.) Tip = +, sleeve = -.

28. POWER AMP IN: This jack connects directly to the internal power amp for use with an external preamp. When using an external source, connect the output of the source to this jack by means of a shielded signal cable to feed the signal into the power amp section. The internal signal is disconnected when a connector is inserted into this jack.

29. PREAMP OUT: This jacks provides a direct preamp output for use with an external power amplifier, mixing board, etc. Connect this jack to the input of the external device by means of a shielded signal cable.

30. EFFECTS LOOP RETURN: When using an external signal processor, connect the output of the device to this jack by means of a shielded signal cable.

31. EFFECTS LOOP SEND: When using an external signal processor, connect this jack to the input of the device by means of a shielded signal cable.

32. FOOTSWITCH: Connect a single button footswitch to this jack for remote Mute On/Off control. The front panel Mute switch (#4) remains active when a footswitch is connected and must be left in the out position in order to control the Mute function with the footswitch.

IMPORTANT: This unit employs forced air cooling by means of an internal fan. The rear and side ventillation slots must remain unobstructed when operating this amplifier. When mounting the unit in a rack make sure there is ample room for proper air circulation. The rack must be constructed and positioned in such a manner to allow proper air flow and the exhausting of hot air away from the rack at all times.



Some Suggested Settings

Since so many variables affect the actual sound of any system, the following settings are offered as starting points to help you find the exact sounds your playing demands. When using the SVT-6PRO, please keep in mind the following points:

->The Gain control should be adjusted until the peak LED flashes on strong signals. (This level will vary, depending on your instrument and playing style.)

->The Compressor control can be adjusted to control the dynamic response of your instrument. Adjust according to your own preference.

->The Semi-Parametric EQ can be used to further fine-tune these basic suggested setting, to extend the frequency response of the cabinet being used, to compensate for room acoustics, etc.

Ampeg Rock:

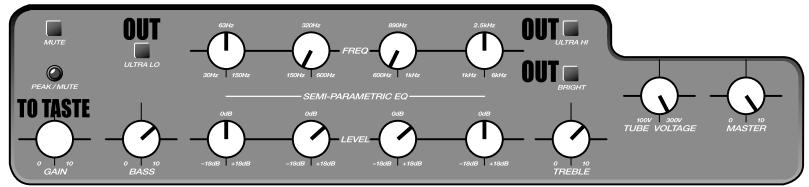

Jazz:

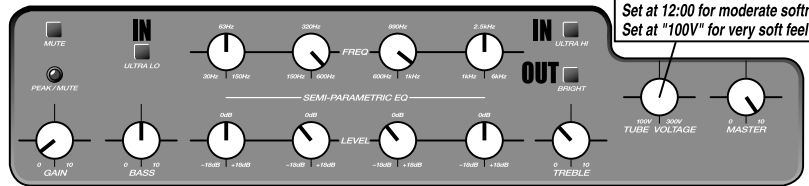

Jaco:

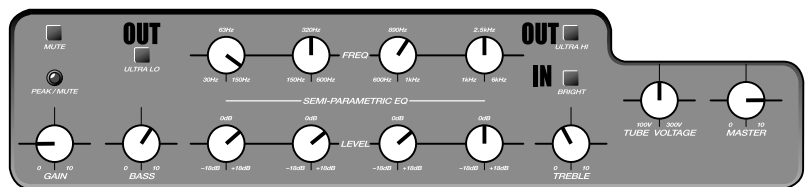

Country:

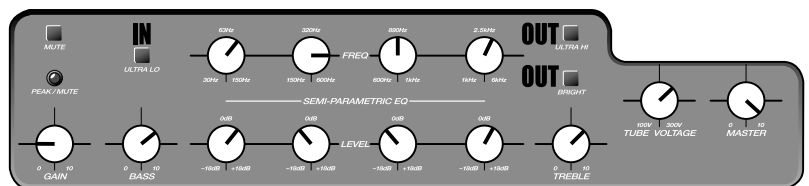

Funk:

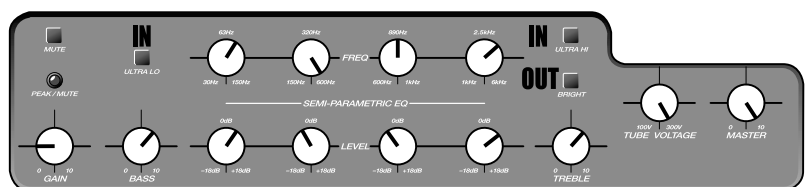

Funk Popping:

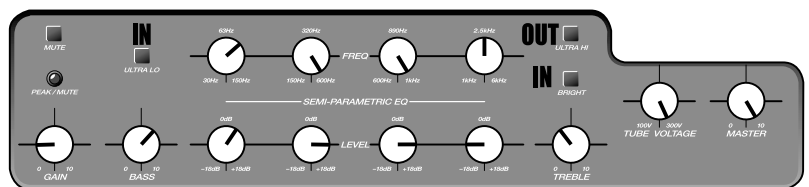

Rack Mounting

When mounting the SVT-6 PRO into a rack, the four bottom feet should be removed to maintain the two rack space height of the amplifier. Be sure to keep the feet and their attachment bolts for future use. If the feet are reinstalled, never use screws which will protrude farther into the amplifier than the original hardware!

The rack must be a high quality enclosure capable of securely supporting the weight of the amplifier. Tighten the mounting screws securely through the amplifier's face plate, into the rack rails. Check the rack and mounting screws occasionally to ensure a continually safe and secure installation. Additional rack ears are provided on the rear of the amplifier for connection to an additional support bracket. It is highly recommended that this additional support be used when rack mounting the amplifier.



Troubleshooting

In the unlikely event that your SVT-6 PRO should malfunction, take a few minutes to troubleshoot it before you call for service. You can save yourself time and money by doing it yourself, and often the cure for the problem is something quite simple.

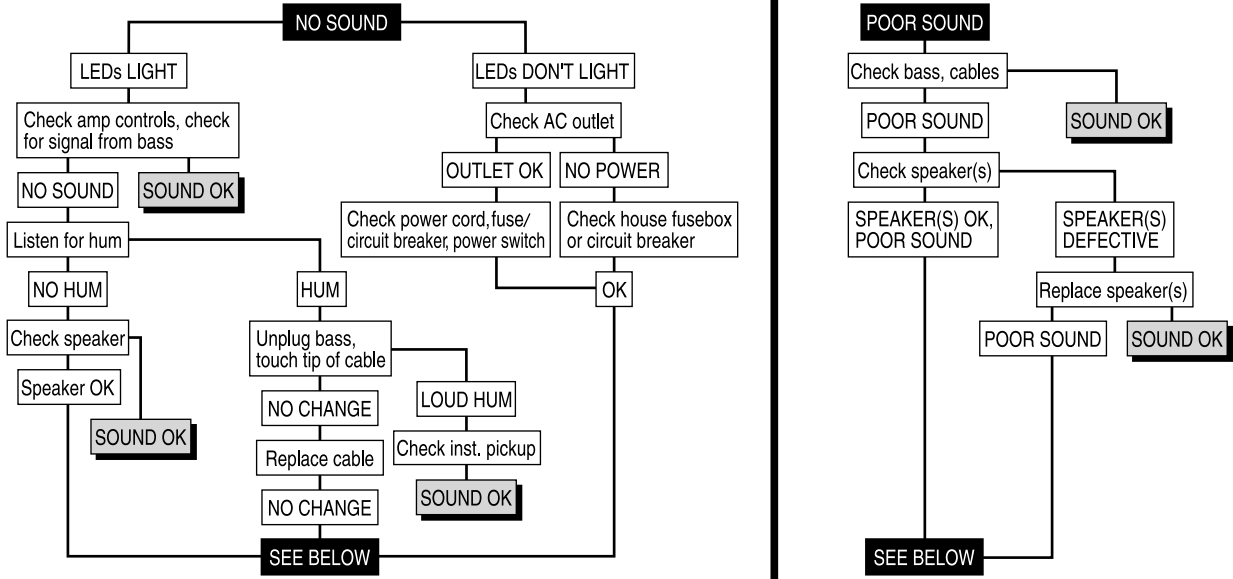

If the problem isn't covered above, or if the steps lead you here, then contact your Ampeg dealer for service information. Also, you should refer your amp for servicing if it gets dropped, has liquid spilled into it, or sustains damage to its power cord (see page 2). Regular maintenance and cleaning should be performed on a routine basis to prolong the amplifier's useful life.

System Block Diagram

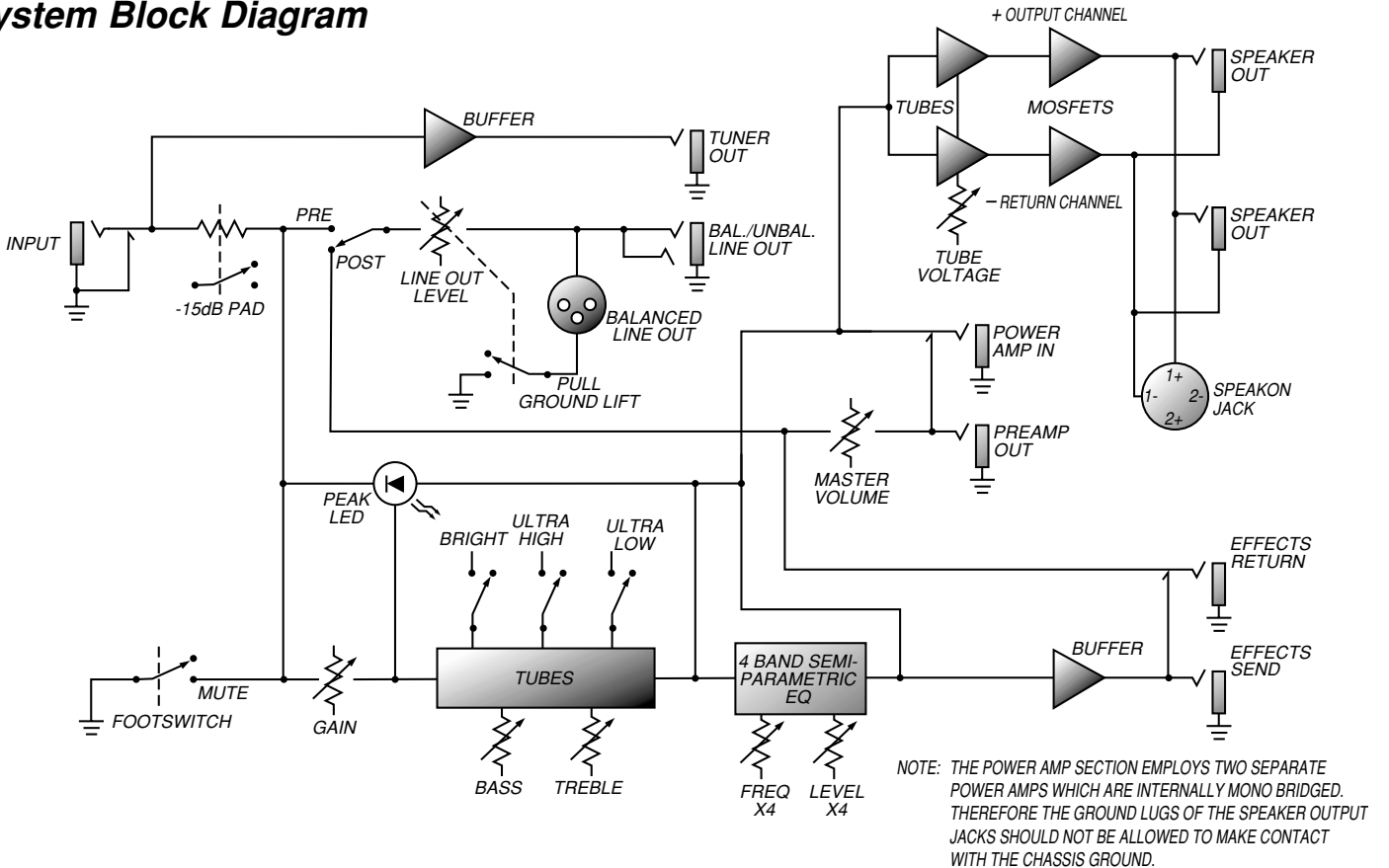



SVT-6 PRO Bass Amplifier

Technical Specifications

OUTPUT POWER RATING	1100 Watts RMS, 4 ohm load, 120VAC, 5% THD 750 Watts RMS, 8 ohm load, 120VAC, 5% THD
TONE CONTROL RANGE	Bass: $\pm 12\text{dB}$ @ 50Hz Treble: +14dB / -19dB @ 5kHz
SEMI-PARAMETRIC EQ RANGE	30Hz - 150Hz: $\pm 18\text{dB}$ 150Hz - 600Hz: $\pm 18\text{dB}$ 600Hz - 1kHz: $\pm 18\text{dB}$ 1kHz - 6kHz: $\pm 18\text{dB}$
BRIGHT SWITCH	+6dB @ 2kHz
ULTRA HIGH SWITCH	+6dB @ 5kHz
ULTRA LOW SWITCH	+2.5dB @ 50Hz -12dB @ 560Hz +1.5dB @ 5kHz
SIGNAL TO NOISE RATIO	75dB typical
COMPRESSION RATIO	10:1 (2dB change in output for 20dB change in input [50mV to 500mV])
FOOTSWITCH JACK	Mute On/Off
TUBE COMPLEMENT	12AX7 (4), 12AU7 (2)
POWER REQUIREMENTS	120VAC, 60Hz, 1000VA 100/115VAC 50/60Hz, 1000VA 230VAC, 50/60Hz, 1000VA
SIZE AND WEIGHT	19 / 17.4" W x 4" H (w/feet) x 18" D; 41 lbs

Ampeg reserves the right to change specifications without notice.



www.ameg.com

Ampeg is proudly Made in America. ©2005 SLM Electronics, 1400 Ferguson Avenue, St. Louis, MO 63133 U.S.A.

P/N 47-722-01 • 042005

