

REVISIONS		
E		
DRAWN	CHECKED	DATE 08.02. 1 10:31

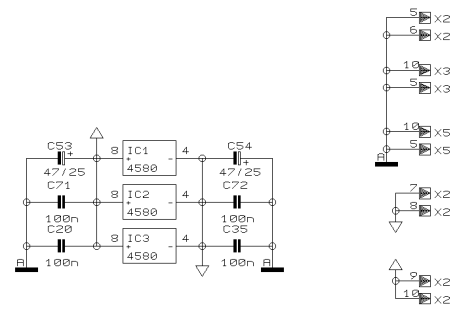

PROJECT
DX1000R
POWER SUPPLY/MIC PREAMP
MACHINE CONTROL
SHEET 1 OF 3 SHEETS TOTAL

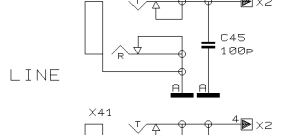
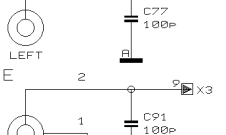
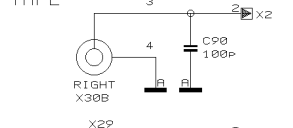
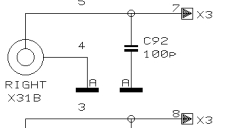
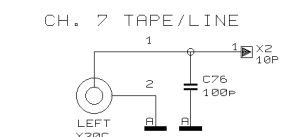
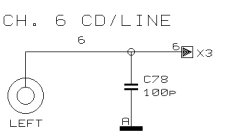
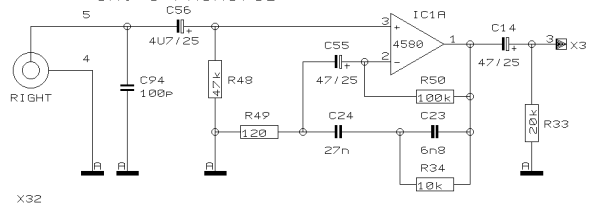
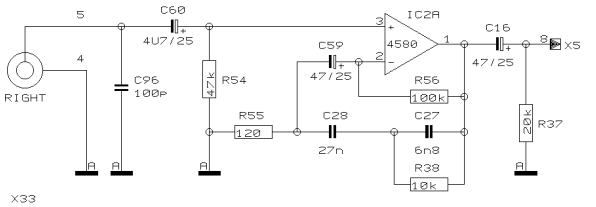
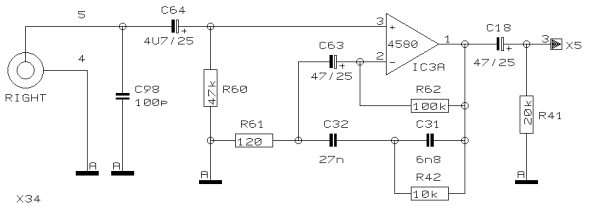
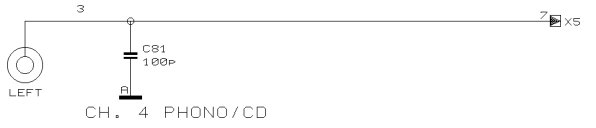
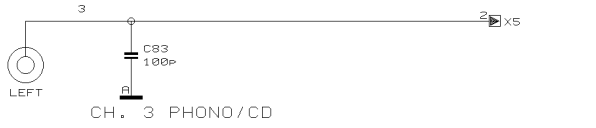
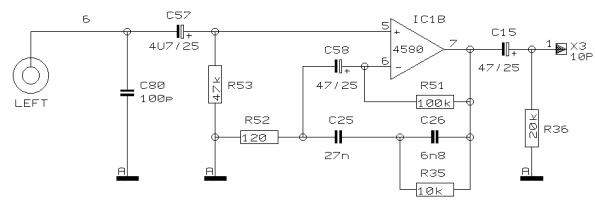
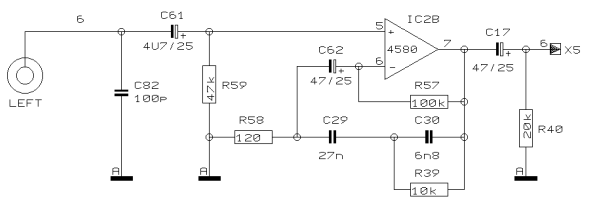
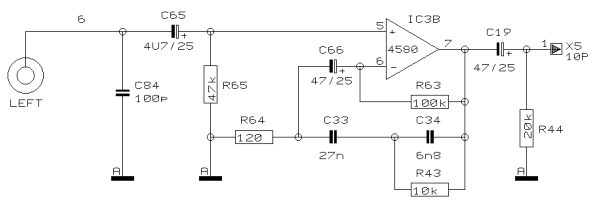

REVISIONS		
E		
DRAWN	CHECKED	DATE 08.02. 1 10:32

BEHRINGER®
Specialized Studio Equipment

PROJECT
DX1000R
PHONO PREAMPS
LINE INPUTS
SHEET 2 OF 3 SHEETS TOTAL

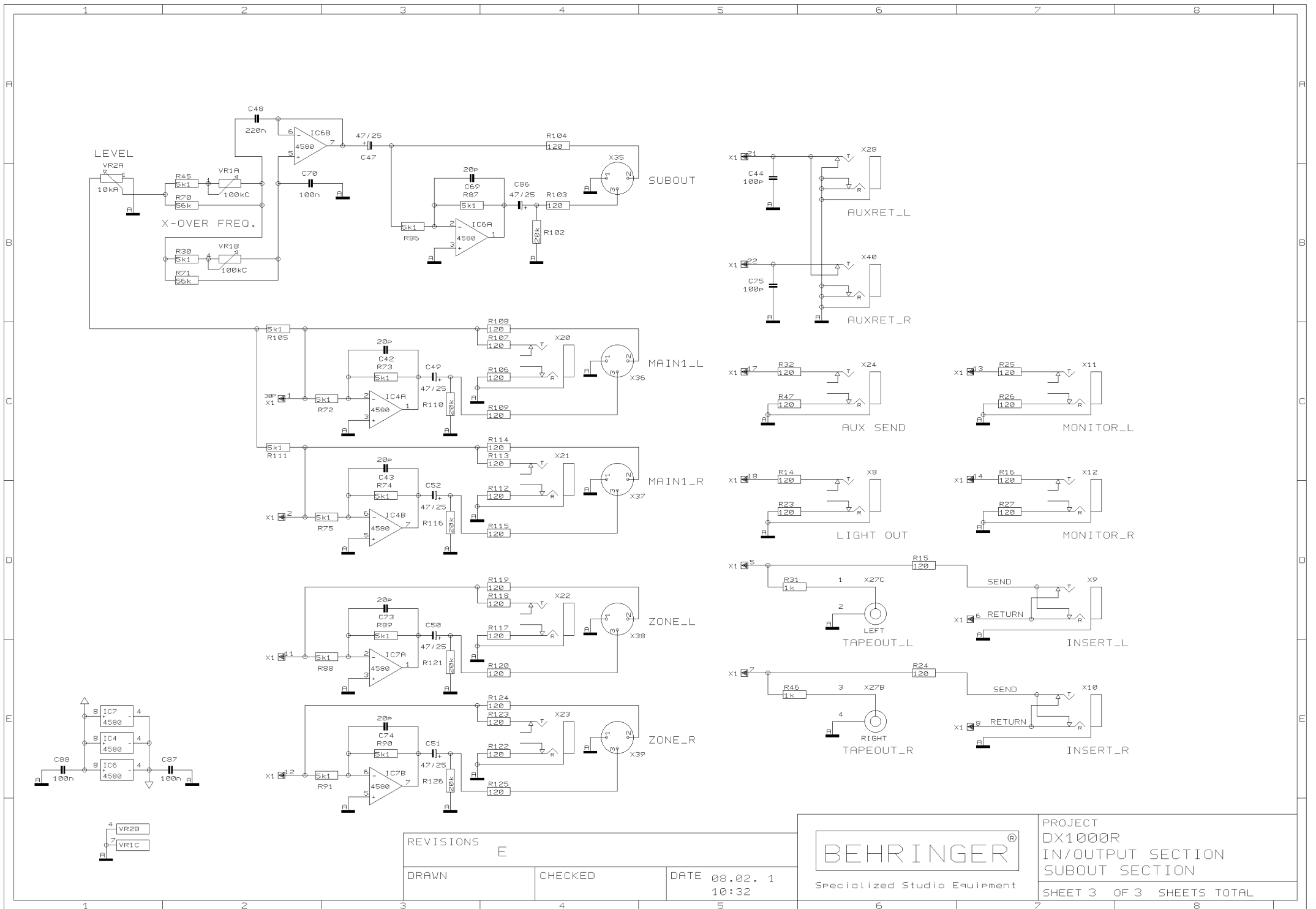

REVISIONS

DRAWN

CHECKED

DATE 08.02. 1
10:32

E



Specialized Studio Equipment

PROJECT
DX1000R
IN/OUTPUT SECTION
SUBOUT SECTION
SHEET 3 OF 3 SHEETS TOTAL