

DSP01

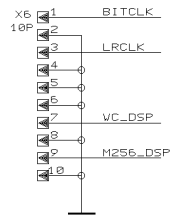

DSP01

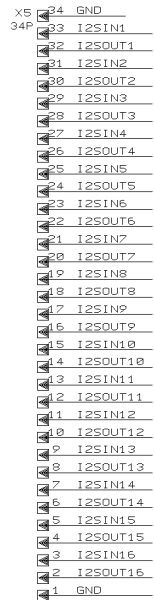

CPU01

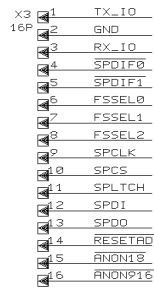

ANAIN02

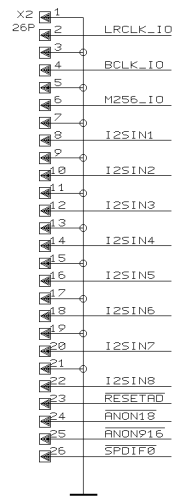

ANAOUT01

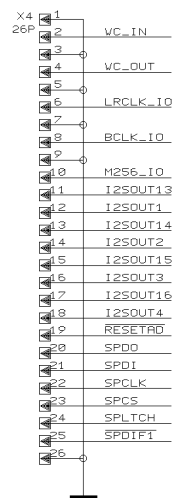

IOMODULE 1

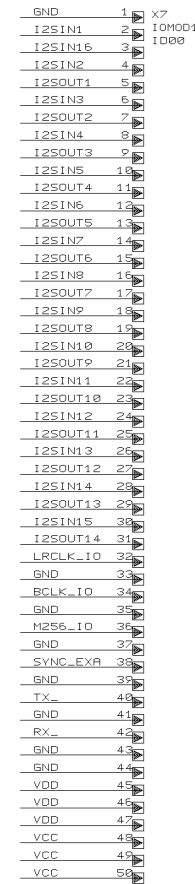

IOMODULE 2

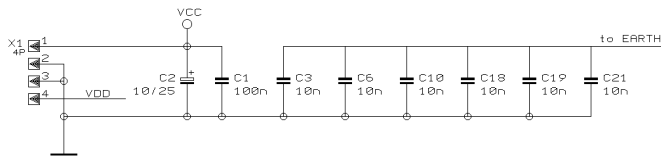
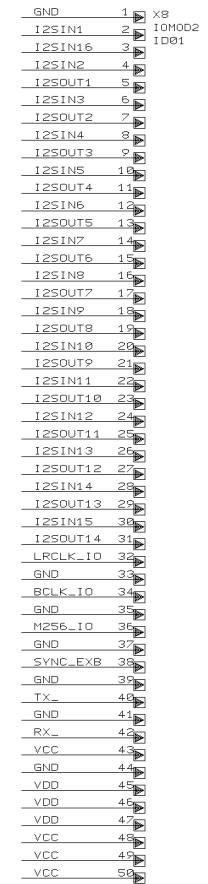

REVISIONS

D (17.07.00)

DRAWN

JK

CHECKED

DATE 02.04. 2
14:53



PROJECT
IOCONN01
MODEL DDX3216
I/O CONNECTORS

SHEET 1 OF 2 SHEETS TOTAL

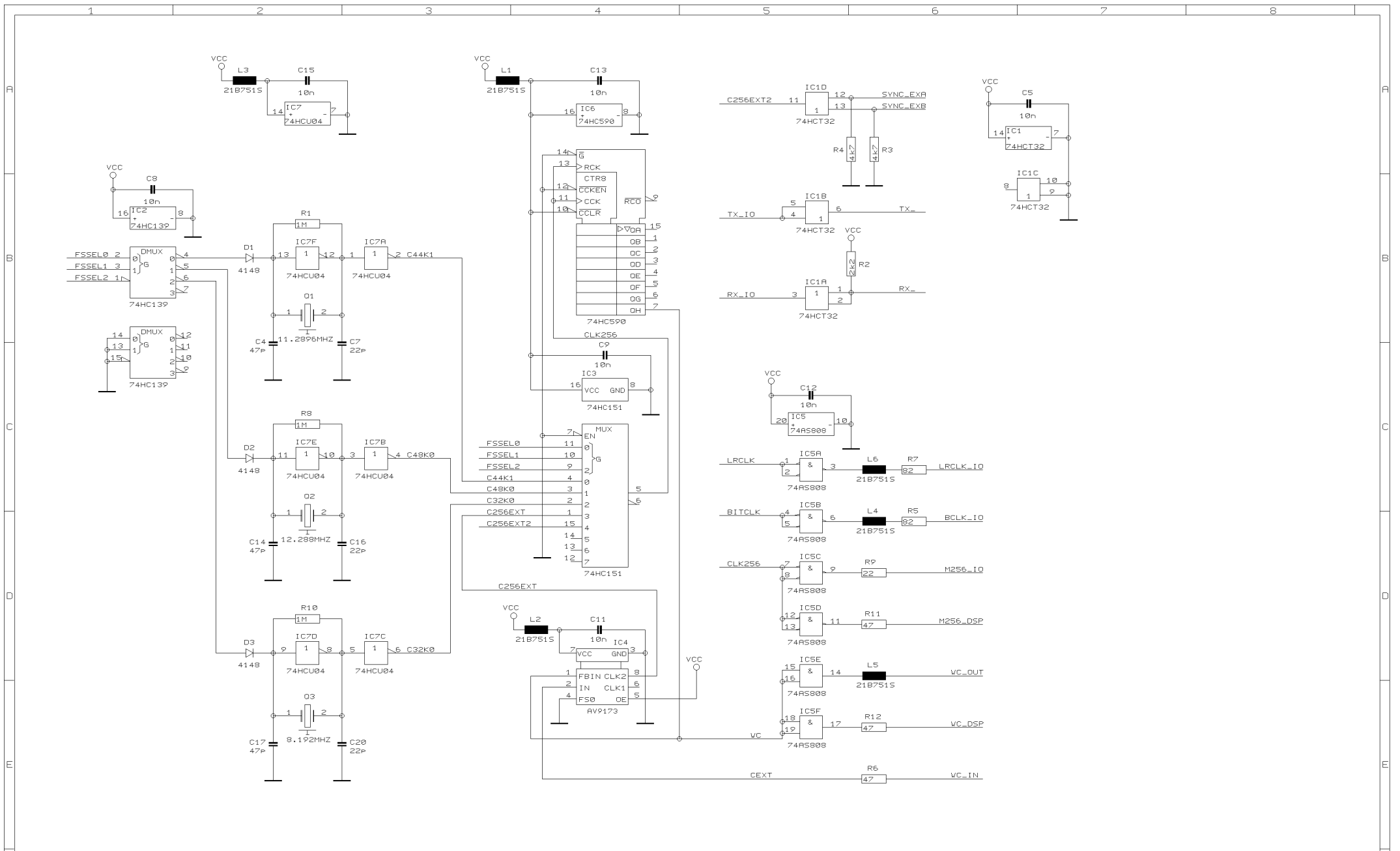

REVISIONS D (17.07.00)

DRAWN JK CHECKED DATE 02.04.2 14:53



PROJECT IOCONN01
 MODEL DDX3216
 CLOCK GENERATOR & SYNC
 SHEET 2 OF 2 SHEETS TOTAL