

# BOSS RV-2 SERVICE NOTES

First Edition

## SPECIFICATIONS

- Power Source : 9V DC (BOSS AC Adapter PSA series or RPW-7)
- Current Draw : 130mA @9V
- Input Level/Impedance : -20dBm (1kHz)/1MΩ
- Output Level/Impedance : -20dBm (1kHz)/4.7kΩ
- Output Load Impedance : More than 30kΩ
- Frequency Response : 30Hz to 10kHz (+1/-3dB)
- Sampling Rate : 31.25kHz
- Sampling System : 12 bit Linear
- Residual Noise : Less than -85dBm (IHF-A)
- Dimensions : 70 (W) x 125 (D) x 55 (H) mm  
2-3/4 (W) x 4-15/16 (D) x 2-3/16 (H) in.
- Weight : 420 g/15 oz.
- Accessories : AC Adapter BOSS PSA-100, 120, 220 or 240
- Options : Power Supply RPW-7

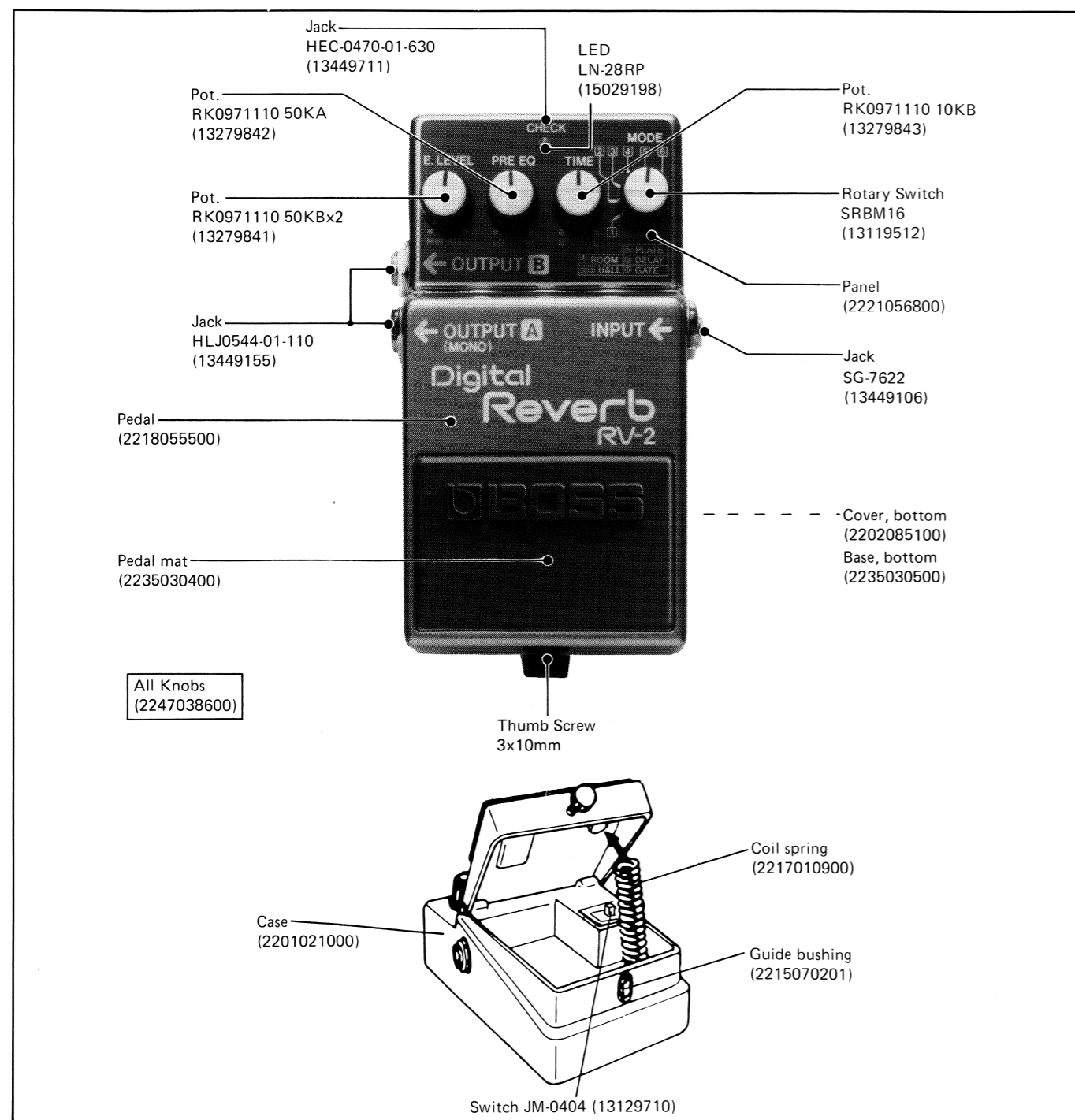

## PARTS LIST

### CASING

2201021000	Case
2221056800	Panel
2218055500	Pedal
2202085100	Cover
2235030400	Pedal Mat
2235030500	Base

### KNOB

2247038600	Knob	E.LEVEL, PRE EQ, TIME, MODE
------------	------	-----------------------------

### JACK

13449155	HLJ0544-01-110	OUTPUT A,B
13449106	SG-7622	INPUT
13449711	HEC-0470-01-630	9V DC IN

### SWITCH

13119512	SRBM16	rotary	MODE
----------	--------	--------	------

### PCB ASSY

75105570	ET Board	Replacement ET Board includes Analog Board. 補修用 ET Board は Analog Board を含みます。
2292050501	Analog Board	Note: Chip parts on Analog board are not available. 注意: Analog Board 上のチップ部品は供給されません。
7510553000	SW.VR Board (pcb 2292050000 3/4)	Replacement SW.VR Board includes the following: 補修用 SW.VR Board は下記を含みます。
7510554000	Jack Board 1 (pcb 2292050000 1/4)	
7510555000	Jack Board 2 (pcb 2292050000 2/4)	
7510556000	LED Board (pcb 2292050000 4/4)	

### IC

15229863	HG61H20R36F-BOS-007	gate array
15179377	M5M4416P-15	4x16K DRAM
15189202	M5239L	comparator
15189185	M5223L	op amp
15189195	M5238L-26	op amp
15199146	NJM2930L-05	regulator
15449110	M5M27C128-15	EP ROM

### TRANSISTOR

15129135	2SC2603F
15129602	2SD667C
15119602	2SB647C

### DIODE

15019209	S-5500G	
15019125	1SS133	
15029198	LN-28RP LED	CHECK

### POTENTIOMETER

13279843	RK0971110	10KB	TIME
13279842	RK0971110	50KA	PRE EQ
13279841	RK0971110	50KBx2	E.LEVEL
13299153	H0651A011	4.7KB	RT-1 (ET board)

### RESISTOR

13919175	RKM14L472-942F	R-2R	ladder network
13919179	RKM8L103-203F	R-2R	ladder network
13910113	RGSD4X103J	4x10K	

### MISCELLANEOUS

12389716	Ceramic Resonator 4MHz	CSA-8.00MS1
13529126	EMI Filter	EXC-EMT103C
2219099700	Pcb Holder 4P	
2225014000	Shield Plate	

1 2 3 4 5 6 7 8 9 10 11 12 13 14 15 16 17 18 19 20 21 22 23 24 25 26 27 28 29 30 31 32 33 34 35 36 37 38

# CIRCUIT DIAGRAM

A  
B  
C  
D  
E  
F  
G  
H  
I  
J  
K  
L  
M  
N  
O  
P  
Q  
R  
S  
T  
U

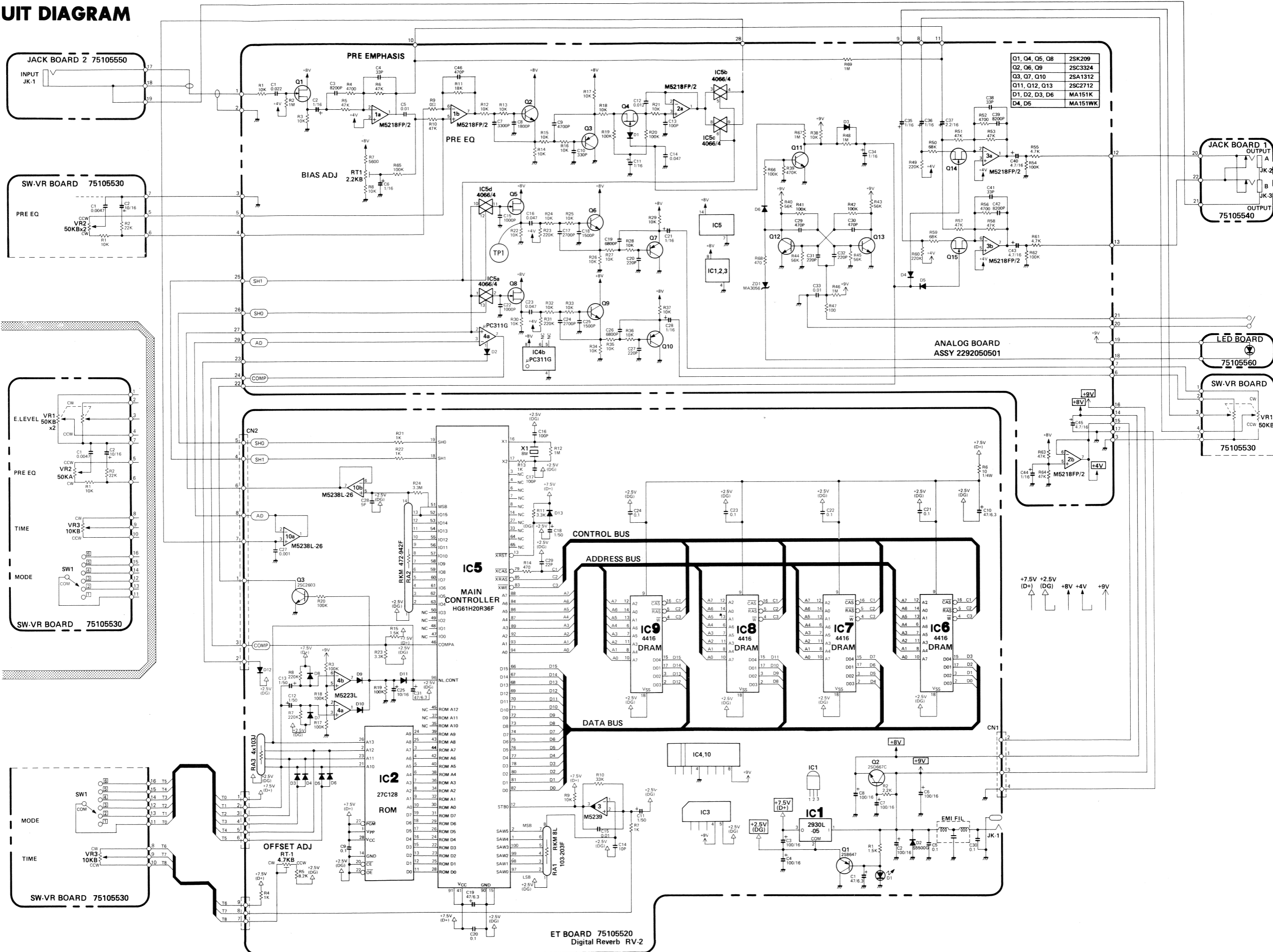

Q1, Q4, Q5, Q8	2SK209
Q2, Q6, Q9	2SC3324
Q3, Q7, Q10	2SA1312
Q11, Q12, Q13	2SC2712
D1, D2, D3, D6	MA151K
D4, D5	MA151WK

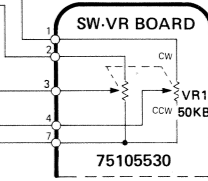
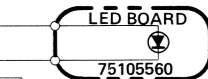
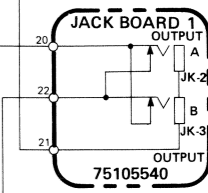
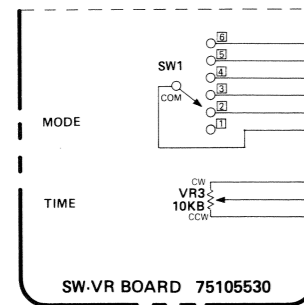
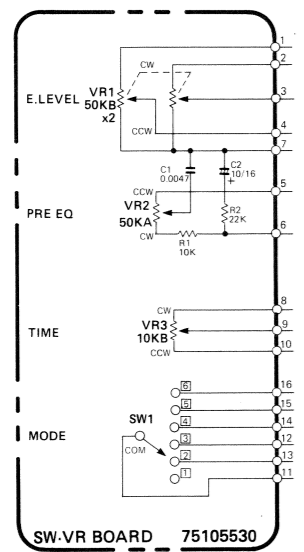
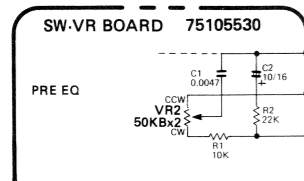
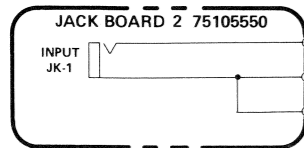

ET BOARD 75105520 Digital Reverb RV-2

1 2 3 4 5 6 7 8 9 10 11 12 13 14 15 16 17 18 19 20 21 22 23 24 25 26 27 28 29 30 31 32 33 34 35 36 37 38

**SW·VR BOARD**

7510553000  
(pcb 2292050000 3/4)

**JACK BOARD 2**

7510555000  
(pcb 2292050000 2/4)

**ET BOARD**

75105570  
(pcb 22920501)

A  
B  
C  
D  
E  
F  
G  
H  
I  
J  
K  
L  
M  
N  
O  
P  
Q  
R  
S  
T  
U

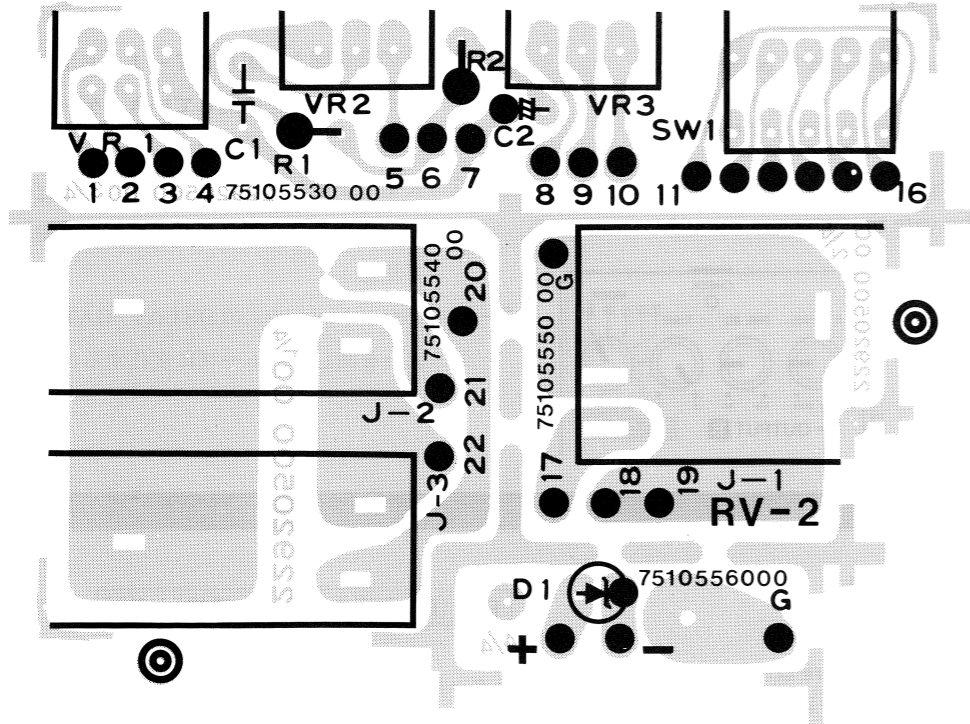

**JACK BOARD 1**

7510554000  
(pcb 2292050000 1/4)

**LED BOARD**

7510556000  
(pcb 2292050000 4/4)

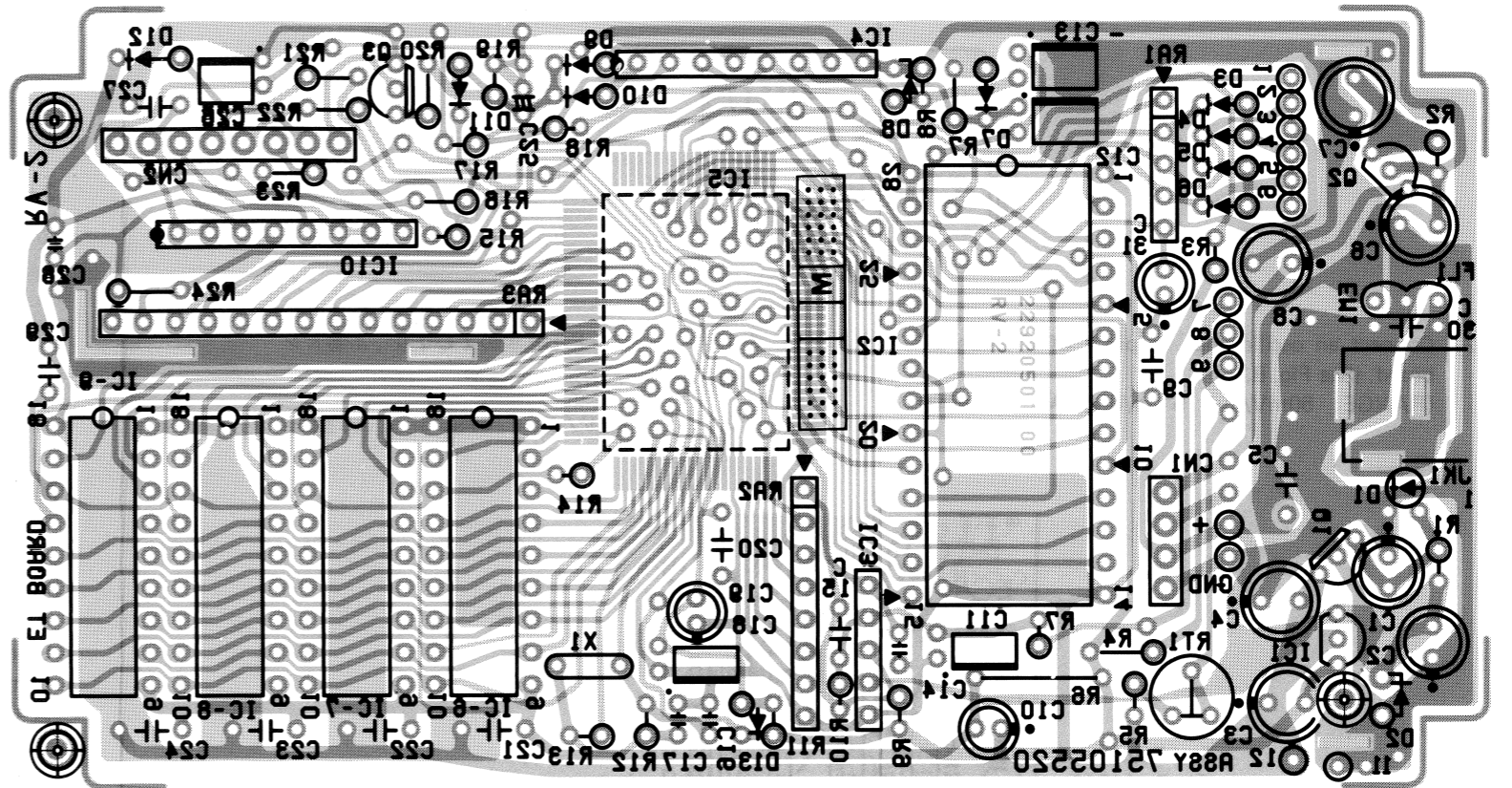

**NOTE:** Replacement SW·VR BOARD includes JACK BOARD 1, JACK BOARD 2 and LED BOARD.  
注意:補修用SW·VR BOARDは、JACK BOARD1、JACK BOARD2、LED BOARDを含みます。

**NOTE:** ET BOARD and ANALOG BOARD are soldered together and adjusted\*before shipping.  
注意:ET BOARD と ANALOG BOARD はハンダ付けされ調整された状態で供給されます。

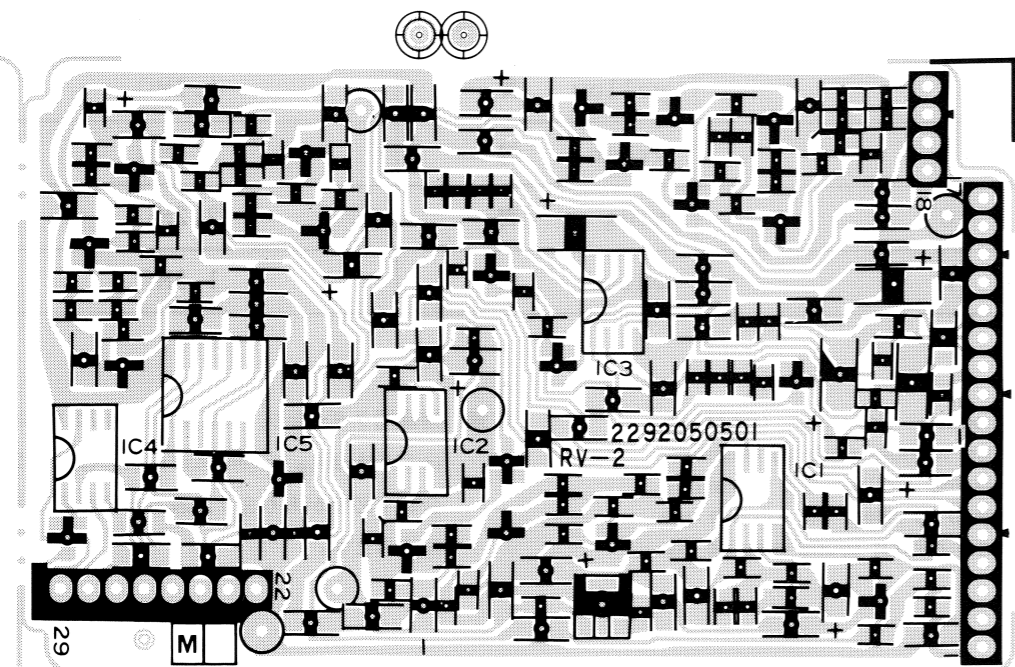

**ANALOG BOARD  
ASSY 2292050501**

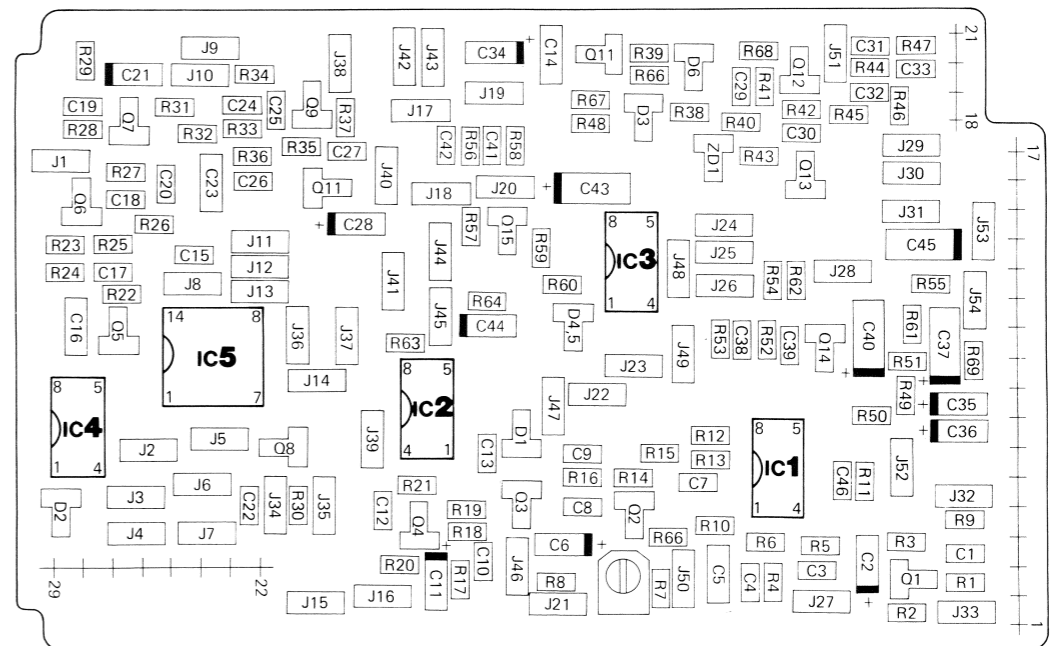

# ADJUSTMENT

# 調整仕様

## 1. A/D/A BIAS

- 1-1. Set Controls as follows.  
(Do not connect any plugs to INPUT.)

## 1.A/D/A バイアス

- 1-1. セッティング  
( INPUT ジャックには何も接続しないこと )

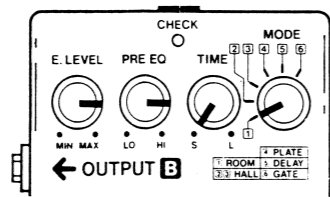

Fig. A

- 1-2. Connect an oscilloscope to pin 7 of IC10 on ET board. (See Fig. B.)  
(RANGE: 50mV/div, 5 μs/div, AC coupling)

- 1-2. オシロスコープをET基板のIC10, 7番ピンに接続する。( Fig. B参照 )  
(レンジ: 50mV/div, 5μs/div, AC接続)

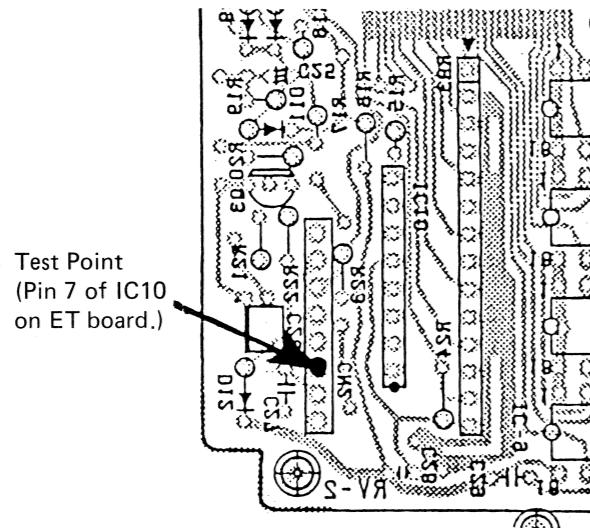

Fig. B

- 1-3. Adjust RT-1 on Analog board for A = 50mV as shown in Fig. C.

- 1-3. Fig. Cの“A” (電位差)が50mVになる様にアナログ基板のRT-1を調整する。

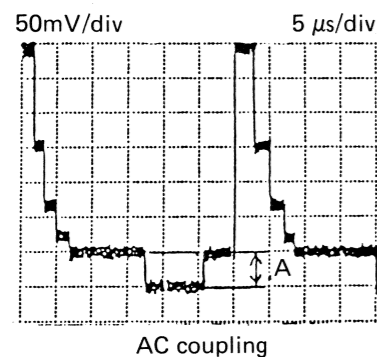

Fig. C (DA OUT)

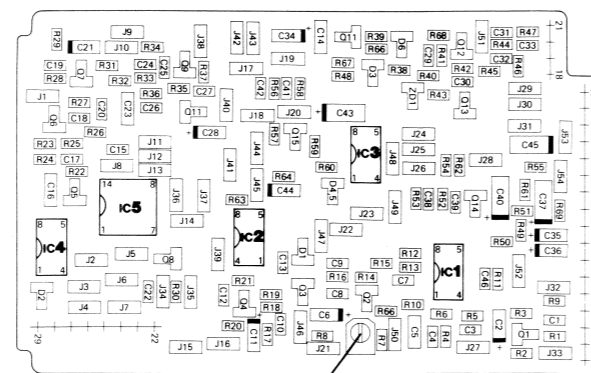

Fig. D

## 2. DELAY/GATE TIME OFFSET

- 2-1. Set Controls as follows.
- 2-2. Connect an amplifier with speaker to OUTPUT A.
- 2-3. Apply a percussive sound to INPUT jack.  
... sound suitable for reverb test will do.
- 2-4. Set RT-1 on ET board fully clockwise (CW).  
Listening to the effect sound, turn RT-1 counter-clockwise (CCW) by inches to find a point from which the gate time abruptly becomes shorter.
- 2-5. Advance RT-1 farther by a small amount to avoid critical point.
- 2-6. Turn DELAY/GATE TIME knob CW and CCW and make sure that the gate time changes smoothly.

## 2. DELAY/GATE TIME オフセット

- 2-1. セッティング
- 2-2. OUTPUT Aにスピーカ付アンプを接続する。
- 2-3. INPUTジャックにパーカッシブな音声信号を入力する。
- 2-4. その音を聞きながらRT-1 (ET基板上)を右端から徐々に左に回していき、ゲートタイムが急に短くなる点を見つける。
- 2-5. RT-1を上記の点からほんの少しだけさらに回し、止める。(きりぎりの点だと不安定になるので注意)
- 2-6. フロントパネル上のDELAY/GATE TIMEつまみを回し、スムーズに変化することを確認する。

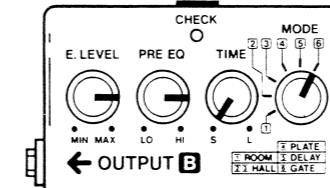

## RA2 (Ladder Resistor) and R24

— ET Board —

Since the resistances of RA2 and R24 are critical factor of the circuit, the factory classifies RA2 into six groups, A to D. Then a resistor whose resistance complements the circuit constant is mated. The table below lists the combinations.

## RA2 (ET基板上のラダー抵抗) と R24

— E T Board —

ラダー抵抗RA2 (RKM14L472F) にはバラツキがあります。これを吸収する為工場ではTable 1の様にRA2をA~Dランクに選別し、抵抗R24の値をこれに合わせています。

Table 1

RA2 (RKM14L472F)		RESISTOR 抵抗	
CLASSIFICATION 選別ランク	MARKING マーク	R24	
A	red 赤	unnecessary 不要	
A'	orange ダイダイ	6.8MΩ	
B	yellow 黄	4.7MΩ	
C	green 緑	3.3MΩ	
C'	blue 青	2.2MΩ	
D	white 白	1.5MΩ	

NOTE: Replacement Ladder Resistors (RKM14L472F) are supplied without undergo classification. When replacing, follow the procedure described on page 5 to select the suitable one for R24. Otherwise output sound may be distorted.

注意: 補修用ラダー抵抗 (RKM14L472F) は選別品では有りません。交換時には次頁の様にR24の値を合わす必要があります。設定がずれていると出力音が歪みます。

**How to determine the value for R24**

1. Setting MODE . . . . . 2  
 TIME . . . . . center  
 Other knobs . . don't care
2. Apply a -50dBm, 100 to 200 Hz sinewave from an audio generator to INPUT jack.
3. Depress the pedal for EFFECT ON.
4. Connect an oscilloscope to TP-1 on Analog Board as shown in Fig. B.

**R24の抵抗値設定方法**

1. セッティング  
 MODE..... 2  
 TIME..... center
2. INPUTにオーディオ・ジェネレータから-50dBm, 100~200Hzのサイン波を加える。
3. EFFECT ONにする。
4. オシロスコープをFig. BのTP-1に接続する。

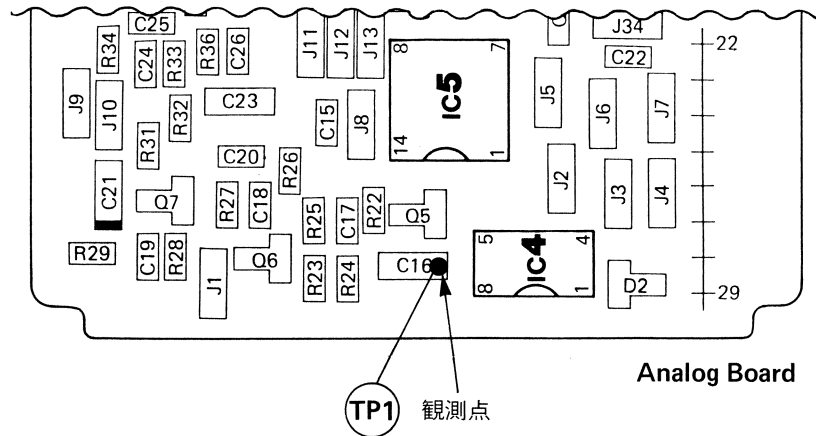
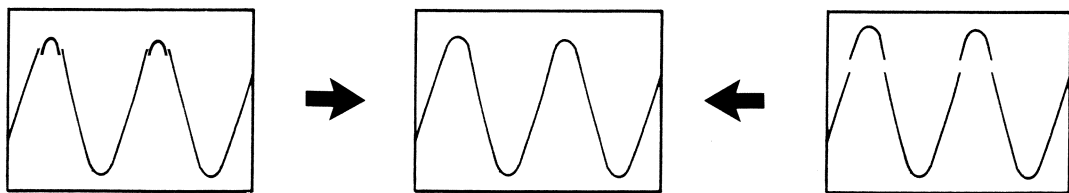

Fig. B

5. Observing the scope, change the frequency of the sinewave between 100 to 200 Hz for the maximum amplitude.
6. Find a resistor which makes the waveform symmetrical with respect to horizontal line as shown in Fig. C and solder.

5. 波形を観測しながらサイン波の周波数を可変(100~200Hz)し、振幅の大きくなる点に設定する。
6. Fig. Cの様に波形が対称になる様ET基板上のR24の値を設定する。



\* Decrease the resistance of R24.  
 \* R24の値を小さくする。

EXAMPLE: 4.7MΩ → 3.3MΩ  
 3.3MΩ → 2.2MΩ  
 2.2MΩ → 1.5MΩ

OK

\* Increase the resistance of R24.  
 \* R24の値を大きくする。

EXAMPLE: 3.3MΩ → 4.7MΩ  
 2.2MΩ → 3.3MΩ  
 1.5MΩ → 2.2MΩ

Fig. C

 Roland®

---

**17059458**

UPC 17059458



10981

 **BOSS**