

Dolby[®]
Model CP650
Digital Cinema Sound
Processor

Installation Manual

Issue 4

Part No. 91569



Dolby Laboratories, Inc.

Corporate Headquarters

Dolby Laboratories, Inc.

100 Potrero Avenue

San Francisco, CA 94103-4813

Telephone 415-558-0200

Fax 415-863-1373

www.dolby.com

European Headquarters

Dolby Laboratories, Inc.

Wootton Bassett

Wiltshire, SN4 8QJ, England

Telephone (44) 1793-842100

Fax (44) 1793-842101

Dolby and the double-D symbol are registered trademarks of Dolby Laboratories. Auditorium Assist, EQ Assist, and Surround EX are trademarks of Dolby Laboratories. All other trademarks remain the property of their respective owners.

© 2002 Dolby Laboratories, Inc. All rights reserved.

Issue 4
Part No. 91569
S02/14315/14409
Software Version 2.1.x.x

Table of Contents

List of Figures.....	vii
List of Tables.....	ix
CP650 Operating System Software History.....	x
Chapter 1 Introduction	
1.1 About the Dolby CP650 Digital Cinema Processor.....	1-1
1.2 Hardware Configurations Available.....	1-2
1.3 Accessories.....	1-3
1.4 Dolby Catalog Number Listing.....	1-3
1.5 Specifications.....	1-3
1.6 About Dolby Digital Surround EX.....	1-6
1.7 List of Formats Available.....	1-8
1.8 How to Identify Types of Soundtracks.....	1-9
1.9 Regulatory Notices.....	1-10
Chapter 2 Installation	
2.1 Replacing an Existing Sound System.....	2-1
2.1.1 Before Playing the Film:.....	2-1
2.1.2 While Playing the Film:.....	2-1
2.1.3 Disconnect the Old System.....	2-2
2.2 Check Fuse and Bypass Mains Voltage Selector.....	2-2
2.3 Mount the CP650.....	2-3
2.4 Mount the Auditorium Assist Microphone.....	2-4
2.5 Connect the CP650.....	2-4
2.5.1 Motor-Start Relays.....	2-4
2.5.2 Remote Controls.....	2-5
2.5.3 Solar Cell Reader Boards.....	2-5
2.5.4 Analog Nonsync Sources.....	2-8
2.5.5 Digital Audio Sources.....	2-8
2.6 Exploded View and Board Locations.....	2-12
Wiring Diagram- Input and Control.....	2-13
Wiring Diagram- Audio Outputs.....	2-14
Wiring Diagram- Audio Outputs for Bi-amplified Screen Speakers.....	2-15
Wiring Diagram- Audio Outputs for Tri-amplified Screen Speakers.....	2-16
System Signal Flow Chart.....	2-17
Chapter 3 Front Panel and Alignment Overview	
3.1 The CP650 Front Panel.....	3-1
3.2 The Setup Control Panel.....	3-6
3.3 Power Supply Voltage Test Points.....	3-8
3.4 Aligning the B-Chain and A-Chain.....	3-8

Chapter 4 B-Chain Alignment

4.1 Check Theatre Equipment4-1

4.2 Microphone Placement4-2

4.3 Initial Setup4-3

4.4 SPL (Sound Pressure Level) Calibration.....4-4

 4.4.1 Initial Setup (CP650s with Cat. No. 791 Crossover)4-4

 4.4.2 Calibration Procedure (All CP650s)4-4

4.5 Initial Output-Level Calibration4-6

 4.5.1 Main Channels4-6

 4.5.2 Subwoofer Channel.....4-8

4.6 Crossover Setup (CP650 with Cat. No. 791).....4-9

4.7 Room Equalization4-17

 4.7.1 Crossover Level Adjustment (for CP650s with Cat. No. 791) .4-17

 4.7.2 Setting Coarse (Bulk) EQ4-19

 4.7.3 Setting Fine EQ (1/3 Octave).....4-20

 4.7.4 The EQ Assist Feature4-22

 4.7.5 Setting Subwoofer Channel EQ4-23

 4.7.6 Final Output-Level Calibration.....4-25

4.8 Final Sound Check: Rotating Pink Noise.....4-28

Chapter 5 A-Chain Alignment

5.1 Overview5-1

5.2 Reverse-Scan Checkup: Projector5-2

5.3 Analog Optical Alignment: Projector.....5-2

5.4 Dolby Level Set.....5-4

5.5 Film-Path Alignment Check.....5-6

5.6 Cell Alignment Check5-7

5.7 Cell Wiring Check.....5-8

5.8 Azimuth Check.....5-8

5.9 Focus Check5-9

5.10 Optical HF Equalization (Slit-Loss EQ).....5-10

Chapter 6 Digital Soundheads

6.1 Mechanical Alignment6-1

6.2 Adjustment with Oscilloscope.....6-2

6.3 Focus Adjustment6-2

6.4 LED Brightness Confirmation and Adjustment6-3

 6.4.1 Inboard Digital Readers6-3

Chapter 7 Final Adjustments

7.1	Setting Bypass Level	7-1
7.2	Setting Optical Surround Delay.....	7-2
7.3	Setting Digital Surround Delay	7-3
7.4	Setting Dolby Digital Reader Delay.....	7-5
7.5	Nonsync Level Adjustment	7-7
7.6	Mono Level Trim and EQ Adjustment.....	7-8
7.7	Assigning Preset Fader Levels	7-9
7.8	Assigning User Button Formats	7-10
7.9	Assigning NS Button Format	7-11
7.10	Format 80/81 PCM Options	7-11
7.11	Reversion Mode.....	7-12
7.12	Auto Surround EX Disable.....	7-12
7.13	Noise Gating.....	7-13
7.14	Running Auditorium Assist.....	7-14
	7.14.1 Operation.....	7-14
	7.14.2 Establish Reference Measurements	7-15
	7.14.3 Auditorium Sound Check.....	7-16
	7.14.4 “FAIL” Parameters	7-17
7.15	Noise Floor Optimization	7-18
7.16	Clock Set	7-19
7.17	Date Set	7-20
7.18	Mute Fade Time Adjustment.....	7-20

Chapter 8 Accessories

8.1	Introduction	8-1
8.2	Cat. No. 779 Remote Control Installation	8-2
	8.2.1 Remove the Housing.....	8-2
	8.2.2 Make a Hole for the Interface Cable.....	8-2
	8.2.3 Connect to the Circuit Board	8-3
	8.2.4 Set the Address Switch	8-4
	8.2.5 Assemble the Unit.....	8-4
	8.2.6 Connect to the CP650	8-5
8.3	Cat. No. 771 Remote Fader Installation	8-6

Chapter 9 Maintenance and Troubleshooting

9.1 Print Cleanliness9-1

9.2 Digital Soundhead Maintenance.....9-1

9.2.1 Replacing the Cat. No. 701 LED Assembly9-2

9.2.2 Replacing the Cat. No. 700 Exciter Lamp9-5

9.3 CP650 Troubleshooting.....9-6

9.3.1 Power Supply Voltage Ranges.....9-6

9.3.2 Exploded View and Board Locations9-7

9.3.3 The Event Log.....9-8

9.3.4 Troubleshooting Chart9-8

Wiring Diagram- Power Supply, Black Cover.....9-18

Wiring Diagram- Power Supply, Gold Cover9-18

Exploded Views- Digital Readers9-19

Appendix A Software Operations

A.1 Display Information About This CP650 UnitA-1

A.2 Updating CP650 SoftwareA-2

A.3 Transferring Settings Between Two CP650sA-3

Appendix B Back Panel Connectors

Appendix C Optical Surround Level Trim

Appendix D Format Descriptions

D.1 Channel Definitions.....D-1

D.2 Format Definitions.....D-2

Appendix E External Control of CP650

E.1 Control via RS-232 Serial Data PortE-1

E.2 Control via Remotes ConnectorE-4

Appendix F Setup and User Menus

F.1 CP650 Setup Menu.....F-1

F.2 CP650 User MenuF-4

List of Figures

Figure 1–1 Surround Speaker/Amplifier Switching for 5.1 and Surround EX Modes	1-7
Figure 1–2 Photograph of Film Soundtracks.....	1-9
Figure 1–3 Film Soundtrack Identification	1-9
Figure 2–1 Main Fuse Assembly.....	2-2
Figure 2–2 Star Washers and Rack-Mounting Screws.....	2-3
Figure 2–3 Cell Preamp Wiring Using Two 3-Conductor Shielded (Screened) Cables	2-6
Figure 2–4 Cell Preamp Wiring Using One 5- or 6-Conductor Shielded (Screened) Cable.....	2-6
Figure 2–5 Cell Preamp Wiring Using Two 2-Conductor Shielded (Screened) Cable.....	2-7
Figure 2–6 Cell Preamp Wiring Using One 4-Conductor Shielded (Screened) Cable	2-7
Figure 2–7 Cat. No. 790 S/PDIF Connections	2-9
Figure 2–8 Cat. Nos. 794/778 AES/EBU and S/PDIF Jumper Selections and Connections	2-9
Figure 2–8 Model CP650 Exploded View	2-12
Wiring Diagram- Input and Control.....	2-13
Wiring Diagram- Audio Outputs.....	2-14
Wiring Diagram- Audio Outputs for Bi-amplified Screen Speakers.....	2-15
Wiring Diagram- Audio Outputs for Tri-amplified Screen Speakers.....	2-16
System Signal Flow Chart.....	2-17
Figure 3–1 Front-Panel Controls	3-1
Figure 3-2 Front-Panel Display Showing All Possible Channels Active.....	3-2
Figure 3-3 Front-Panel Display Showing a Dolby Digital Film Playing.....	3-3
Figure 3-4 Front-Panel Display Showing Dolby Digital Surround EX Film Playing.....	3-3
Figure 3-5 Front-Panel Display When Running Earlier Software	3-3
Figure 3–3 Fader Characteristic	3-4
Figure 3–4 CP650 Operation and Setup Menu Control Buttons.....	3-5
Figure 3–5 Setup Control Panel	3-6
Figure 3–6 Power Supply Voltage Test Points.....	3-8
Figure 4–1 EQ Microphone Placement	4-2
Figure 4–2 Cat. No. 772A Board Jumpers for Cat. No. 791 Crossover.....	4-9
Figure 4–3 Cat. No. 791 Board Jumpers for Screen Loss HF Boost.....	4-9
Figure 4–4 EQ Assist Operating Range	4-22
Figure 6–1 Digital Soundhead Adjustments.....	6-1
Figure 6–2 Digital Video Oscilloscope Image—Focus Adjustment.....	6-3
Figure 6–3 Cat. No. 701 LED Brightness Adjustment.....	6-3
Figure 8–1 Cat. No. 779 Remote Control Functions.....	8-2
Figure 8–2 Location to Drill Wiring Hole.....	8-3
Figure 8–3 Remote-Control Circuit-Board Connector.....	8-3
Figure 8–4 SW1 Address Switch Location	8-4
Figure 8–5 Connection of Remotes to the CP650.....	8-5

Figure 9–1 Digital/Analog Track Wear.....	9-1
Figure 9–2 LED Assembly Mounting Screws.....	9-2
Figure 9–3 LED Assembly Wiring.....	9-2
Figure 9–4 LED Assembly Initial Gap Setting	9-2
Figure 9–5 Scope Display of CP650 Video Test Point Signal.....	9-4
Figure 9–6 Adjust LED Assembly for Optimum Video Signal	9-4
Figure 9–7 LED Drive-Current Setting.....	9-4
Figure 9–8 Digital Soundhead Exciter Lamp Replacement	9-5
Figure 9–9 Power Supply Voltage Test Points.....	9-6
Figure 9–10 Model CP650 Exploded View	9-7

List of Tables

Table 1–1 Formats Supported by the CP650.....	1-8
Table 2–1 Solar Cell Preamp Board Connectors.....	2-6
Table 2–2 Examples of Available Balanced ↔ Unbalanced Adapters.....	2-11
Table 7–1 Surround Delays Based on Theatre Dimensions (in Feet)	7-4
Table 7–2 Surround Delays Based on Theatre Dimensions (in Meters)	7-5
Table 7–3 Typical Delay Settings for Dolby Digital Readers.....	7-6
Table 7–4 Typical Delay Settings for Built-in Digital Readers	7-6
Table 9–1 Main Power Supply Voltage Ranges.....	9-6
Table 9–2 Bypass Power Supply Voltage Ranges.....	9-6
Table B–1 Main Audio Output Connector Pinout.....	B-1
Table B–2 Option Card I/O Connector Pinout with Cat. Nos. 790, 791, or 794 Installed.....	B-2
Table B–3 Option Card I/O Connector Pinout with Cat. No. 778 Installed.....	B-3
Table B–4 Dolby Digital Reader Input Connector Pinout	B-4
Table B–5 Motor-Start Connector Pinout	B-5
Table B–6 Optical Input Connector Pinout	B-5
Table B–7 Mic Input Connector Pinout	B-5
Table B–8 MIC MUX Connector.....	B-6
Table B–9 Remote Unit and Remote Fader Connector Pinout	B-6
Table B–10 Six-Channel Analog Input Connector Pinout	B-7
Table B–11 Automation I/O Connector Pinout.....	B-8
Table B–12 Automation I/O Connector Pins Used for Noise Gating	B-9
Table B–13 Serial Data (RS-232) Connector Pinout	B-9
Table D–1 Channel Definitions.....	D-1
Table D–2 Format Characteristics Chart.....	D-10

CP650 Operating System Software History

V1.0.4.4

- First product shipments.
- Covered in Installation Manual, Issue 1.

V1.1.3.0

- Added support for Cat. No. 790 or 794 card: Dolby® Digital Surround EX™ decoder and AES/EBU input for stereo pulse-code modulated (PCM) or Dolby Digital bitstreams from consumer products.
- Covered in *Installation Manual Addendum*, Part No. 91743.

V1.1.5.0

- Added support for Cat. No. 779 remote control unit and Cat. No. 771 remote fader unit. Covered in *Remotes Installation Manual*, Part No. 91733.

V1.1.7.0

- Added support for formats 92 and 93, Dolby SR input selections.

V1.2.x.y (where x and y may be any numbers)

- Added support for Auto Dolby Digital Surround EX switching, external control via the RS-232 serial data port, and the rotating pink-noise feature.
- The EQ Assist® feature description was added to the installation manual.
- These features, along with all of the above updates, are covered in *Installation Manual*, Issue 2.

V2.0.x.y (where x and y may be any numbers)

- Added the Auditorium Assist™ feature, which measures and stores a characterization of the audio environment in a theatre, and allows periodic checks and comparisons to qualify the sound system.
- Added support for the Cat. No. 778 Eight-Channel Digital I/O Card for use in mixing studios.
- Added a noise floor optimization feature, which provides automatic gain adjustments in the equalizers for improved noise performance.
- These features, plus all of the above updates, are covered in this installation manual.

V2.1.x.y (where x and y may be any numbers)

- Added support for the Cat. No. 790 Dolby Digital Surround EX Decoder Card with four S/PDIF digital inputs. This card replaces the Cat. No. 794, adding three additional S/PDIF digital inputs.
- Added support for the Cat. No. 791 Digital Crossover Card. This card plugs into the Cat. No. 790, providing two- and three-way screen channel crossover capability along with support for Left Extra/Right Extra screen channels.

Chapter 1

Introduction

1.1 About the Dolby CP650 Digital Cinema Processor

The Dolby CP650 Digital Cinema Processor is a self-contained, all-digital cinema processor capable of supporting Dolby® Digital, Dolby Digital Surround EX™, Dolby SR, Dolby A-type, and Academy mono film sound playback.

The CP650 provides inputs for two projector soundheads (both analog and digital), an external six-channel processor, two nonsync sources, and a PA microphone. Its audio outputs are balanced, with a multipin connector configured to the THX standard. The CP650 is the first cinema processor to incorporate an Ethernet connection, enabling theatre personnel to monitor the unit's functions remotely from a PC.

For decoding analog soundtracks, the CP650's state-of-the art design incorporates the only digital implementations of Dolby A-type and Dolby SR decoding that meet Dolby Laboratories' own rigorous standards. Reductions in the cost of powerful digital signal processing (DSP) circuitry have made it possible for the first time to replace the analog circuitry previously necessary for the accurate reproduction of A-type and SR soundtracks.

An easy-to-read LCD screen, plus simple front-panel format selection and control buttons, makes it easy to install, operate, and maintain the CP650. Installation is further simplified by built-in test instrumentation that includes a real-time analyzer. Third-octave equalization, plus bass and treble trim controls, are provided for up to seven channels (Left, Center, Right, Left Surround, Right Surround, Back Surround Left, and Back Surround Right). A digital parametric equalizer is provided for subwoofer equalization.

Easily programmed internal software manages most existing or likely future formats. While an external PC is not required for setup, a full-featured software package is available in several languages to facilitate the setup process. A serial connector for a PC, an input for a calibration microphone multiplexer, and a variety of test points are all accessible behind an access door on the front-panel. Built-in diagnostic software runs automatically whenever the CP650 is turned on.

Calibration settings for a given theatre can be stored on a PC, and, if necessary, transferred directly to another CP650, or other modules, minimizing the need for additional calibration after repairs. As improvements to the CP650 digital control and processing software are developed, the latest revisions will be downloadable from a PC to the CP650. Updates to the digital processing used for Dolby Digital soundtracks are included from time to time on Dolby Digital release prints, and

download automatically into the CP650 the first time such a print is played in the cinema.

The standard Model CP650 includes a Cat. No. 790 (Cat. No. 794 in earlier units) plug-in module featuring Dolby Digital Surround EX decoding, plus four-input AES/EBU digital inputs accommodating PCM audio and Dolby Digital (consumer) bitstreams.

Options available for the CP650 include a remote fader (Cat. No. 771), a remote unit (Cat. No. 779) that duplicates many of the CP650's front-panel controls, and an eight-channel digital I/O card for use in mixing studios (Cat. No. 778).

1.2 Hardware Configurations Available

The CP650 is available in these versions:

Model CP650

- Dolby Digital soundtrack decoding
- Dolby A-type and SR analog soundtrack decoding
- Dolby Digital Surround EX decoding
- Four AES/EBU digital inputs
- Up to five AES/EBU digital outputs
- Six-channel analog input

Model CP650D

- Dolby Digital soundtrack decoding
- Dolby A-type and SR analog soundtrack decoding
- Six-channel analog input
- Upgradable to Dolby Digital Surround EX decoding and 4x AES/EBU digital inputs by installing upgrade kit UEX/650, which includes a Cat. No. 790 plug-in circuit board.

Model CP650SR

- Dolby A-type and SR analog soundtrack decoding capability
- Six-channel analog input
- Upgradable to Dolby Digital soundtrack decoding by adding upgrade kit UD/650, which includes a Cat. No. 773 plug-in circuit board
- Upgradable to Dolby Digital Surround EX decoding and 4x AES/EBU digital inputs by installing upgrade kits UD/650 and UEX/650 (which includes a Cat. No. 790 plug-in circuit board)

1.3 Accessories

- Upgrade kit UD/650, which includes the Cat. No. 773 circuit board
- Upgrade kit UEX/650, which includes the Cat. No. 790 circuit board
- Upgrade kit Cat. No. 735 Auditorium Assist™, which includes a microphone
- Cat. No. 771 Remote Fader
- Cat. No. 778 Digital I/O Board, which provides up to eight channels of digital I/O
- Cat. No. 779 Remote Control Unit
- Upgrade Kit Cat. No. 791 Digital Crossover, which provides two-way or three-way screen-channel crossover capability

1.4 Dolby Catalog Number Listing

Cat. No. 771	Remote Fader
Cat. No. 772A	Analog I/O and Bypass Circuit Board
Cat. No. 773	Dolby Digital Film Decoder Circuit Board
Cat. No. 774A	System Controller Circuit Board
Cat. No. 775	Backplane Board
Cat. No. 776	Power Supply Assembly
Cat. No. 777	Front-Panel Circuit Board
Cat. No. 778	Digital I/O Board
Cat. No. 779	Remote Control Unit
Cat. No. 790	Dolby Digital Surround EX™ Decoder with Four Digital Inputs (this board replaces the earlier Cat. No. 794)
Cat. No. 791	Crossover Board (Cat. Nos. 773, 790, 772A, and 774A required)
Cat. No. 792	Bypass Power Regulator Circuit Board
Cat. No. 794	Dolby Digital Surround EX Decoder with Digital AES/EBU Input Board (used in earlier CP650s; replaced by Cat. No. 790)
Cat. No. 797	Flash memory module (part of the Cat. No. 774A board)

1.5 Specifications

Signal Inputs

Optical: Balanced inputs for two projectors with stereo solar cells or analog LED readers, digitally controlled gain and digital slit-loss EQ, power available for external cell preamp circuits; 9-pin D-connectors

Digital film reader: Inputs for two Dolby digital soundheads; 25-pin D-connectors

Nonsync: Two stereo inputs, 21 k Ω , sensitivity: 0.2–4 V (NS 1), 0.06–1.5 V (NS 2); RCA-type phono connectors

Six-channel analog input: For external digital processor, 10 k Ω (L, R), 27 k Ω (C, Ls, Rs, SW), 300 mV operating level; 25-pin D-connector

Microphone: Balanced input for Auditorium Assist microphone, PA mic, or B-chain alignment mic (or multiplexer), 15 V phantom power switchable via front-panel DIP switch; rear-panel XLR and front-panel 9-pin D-connector

AES/EBU digital inputs: Accommodate stereo PCM audio at 48, 44.1, or 32 kHz, also accept Dolby Digital bitstreams; input via 25-pin D-connector with optional adapter boards (Cat. Nos. 790 or 778)

110 Ω \pm 20%, balanced (equipped with Cat. No. 778, four inputs), or 75 Ω \pm 20%, single-ended (equipped with Cat. No. 790, four inputs)

Signal Outputs

Balanced, output impedance: 100 Ω (load >600 Ω)

Maximum level: +26 dBu (15.5 V), balanced loads; +20 dBu (7.75 V), unbalanced loads

Dolby level output adjust range: -31 to -12 dBu (20-780 mV)

Other Connections

Cat. No. 779 remote control unit and Cat. No. 771 remote fader connector (terminals for stripped wires)

Connectors (front and rear) for external PC control and setup, RS-232C (9-pin D-connector)

Hearing-impaired output: Center-weighted sum of L, R, and C; output impedance 100 Ω , output level 200 mV fixed; unbalanced (RCA-type phono connector)

Automation connector for controlling and indicating format, fader select, and mute; interface similar to Model CP65

Connector for Ethernet link, RJ-45

Dolby Decoding

5.1 channels: Dolby Digital and Dolby Digital Surround EX

Four channels: Dolby A-type

Two channels: Dolby SR

Dolby Pro Logic®

Loudspeaker Equalization

L, C, R, Ls, Rs, Bsl, Bsr: Digital 27-band, 1/3-octave, plus bass and treble control
Le, Re (when equipped with optional Cat. No. 791): Digital 27-band,
1/3-octave, plus bass and treble control
SW: Digital parametric with 12 dB cut capability

Distortion

Typically 0.005% in Dolby SR mode (output –10 dBu, input 10 dB over Dolby level)

Dynamic Range

Typically 99 dB with fader set to 7

Power Requirements

Main supply: 100–120 and 200–240 VAC, 50–60 Hz, 100 W maximum (including built-in bypass power supply)
Unit designed to operate from a centrally switched power source

Dimensions and Weight

3-U rack-mount chassis; faceplate: 133 × 483 mm (5.25 × 19 inches)
Maximum projection behind equipment rack rail: 365 mm (14.4 inches)
Maximum projection in front of mounting plate: 38 mm (1.5 inches)
Net: 10.4 kg (23 lb)

Environmental Conditions

Operating: 0° to 40°C (32° to 104°F), forced-air cooling
Humidity: 20 to 80% relative humidity, noncondensing

1.6 About Dolby Digital Surround EX

Dolby Digital Surround EX adds a third surround channel to digital film sound, a concept first envisioned by sound designers at Lucasfilm's Skywalker Sound postproduction facility. It gives sound mixers a new level of creative freedom.

Dolby Digital Surround EX is fully compatible with all current 5.1 digital sound formats and theatre systems. Prints that use it play normally with current systems, and provide the extra surround channel when played using a CP650 cinema processor equipped with a Cat. No. 790 or 794 board.

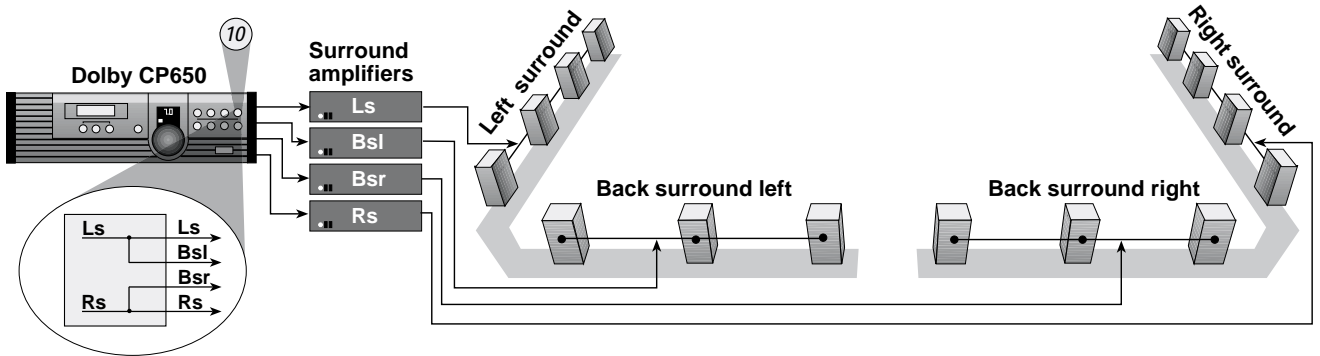
A center screen channel is necessary to ensure the precise localization of front sounds for all viewers, including those seated off to the sides. Dolby Digital Surround EX brings similar benefits to the surround sound field. With Surround EX, a back surround channel is reproduced by the speaker array at the back of the theatre, while left and right surround is reproduced by the side arrays. This means that sounds can now be positioned behind the audience, opening the door to exciting new effects, such as true 360-degree pans.

The back surround channel also makes front-to-back and back-to-front transitions more realistic. Flyovers really seem to pass overhead, rather than down the sides of the theatre. Even ambient sound reproduction is improved, being less affected by the width of the theatre. Equally important, the new back surround channel ensures that even viewers seated close to the left or right of the theatre experience the total surround ambience intended by the filmmaker.

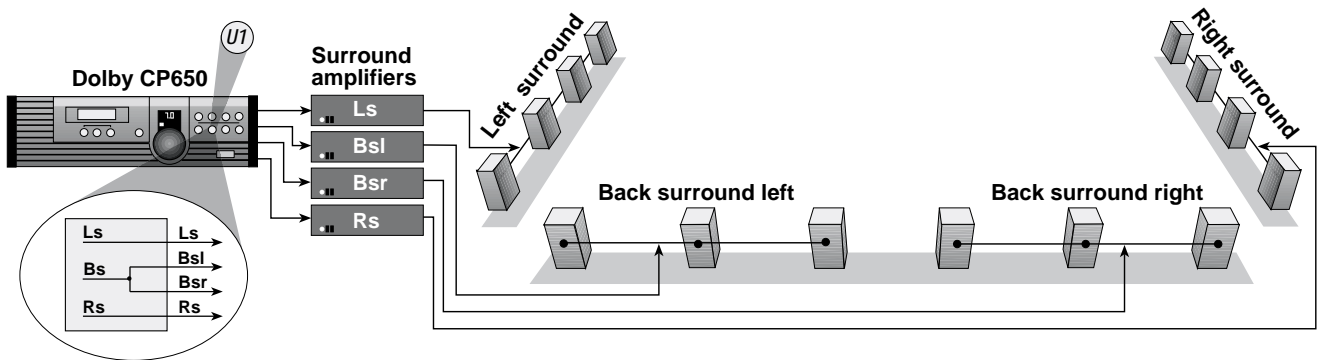
The UEX650 kit upgrades the CP650D 5.1-channel digital cinema sound processor to three surround channels that can play digital prints prepared with the Dolby Digital Surround EX process. The installation requires wiring the surround speakers into **left**, **back** (split into two groups), and **right**. Two power amplifier channels are required for powering the two groups of back surround channel speakers. The figures below show the surround signal distribution for conventional the 5.1-channel surround format and for the Dolby Digital Surround EX format.

Auto Surround EX

On Dolby Digital soundtracks that contain a data bit signifying Surround EX encoding, the CP650 will automatically switch to Dolby Digital Surround EX decoding (operating software version 1.2 and above).



Dolby Digital 5.1 mode



Dolby Digital Surround EX mode

Figure 1-1 Surround Speaker/Amplifier Switching for 5.1 and Surround EX Modes

1.7 List of Formats Available

The formats supported by the CP650 are listed below. See Appendix D for complete definitions of each format.

Table 1–1 Formats Supported by the CP650

Format	Description	Short Name
01	Academy mono optical	Mono
04	Dolby A-type optical	Dolby A-type
05	Dolby SR optical	Dolby SR
10	Dolby Digital film	Dolby Digital
11	External six-channel	
13	Dolby Digital Surround EX film	Surround EX
20	35 mm magnetic, L, C, R three-channel	Three-channel mag
22	35 mm magnetic, four-channel	Four-channel mag
42	70 mm Dolby A-type mag. mono surround	70 mm Dolby Stereo
60	Nonsync 1	
61	Nonsync 2	
64	Public-address center channel	Public address, C
65	Public Address Surround Channels	Public address, LsRs
66	Test Tone 320 Hz	
70	Video PA Nonsync 1	Video PA (NS1)
71	Video mono Nonsync 1	Video Mono (NS1)
73	Video LCR Nonsync 1	Video LCR (NS1)
74	Video Pro Logic no SW Nonsync 1	Vid Pro Logic no SW
75	Video Pro Logic with SW Nonsync 1	Vid Pro Logic +SW
80	Bitstream Master Digital Input	Master Digital In
81	Bitstream Master Digital + Surround EX	Fmt 80 w/Surr. EX
85	Bitstream PCM Eight-Channel Input, Ten-Channel Output (Le/Re Support)	Five Ch. Screen
86	Bitstream PCM Eight-Channel Input, Ten-Channel Output + Surround EX (Le/Re Support)	5 Ch. Screen + EX
87	Ext. Six-Channel with Surround EX	Fmt 11 w/Surr. EX
88	Six-Channel PCM	
89	Six-Channel PCM + Surround EX	Six-Channel PCM + EX
90	Six-Channel PCM	
92	Dolby SR Two-track printmaster	Dolby SR (Six-Ch In)
93	Dolby SR Two-track printmaster	Dolby SR (NS1)

1.8 How to Identify Types of Soundtracks

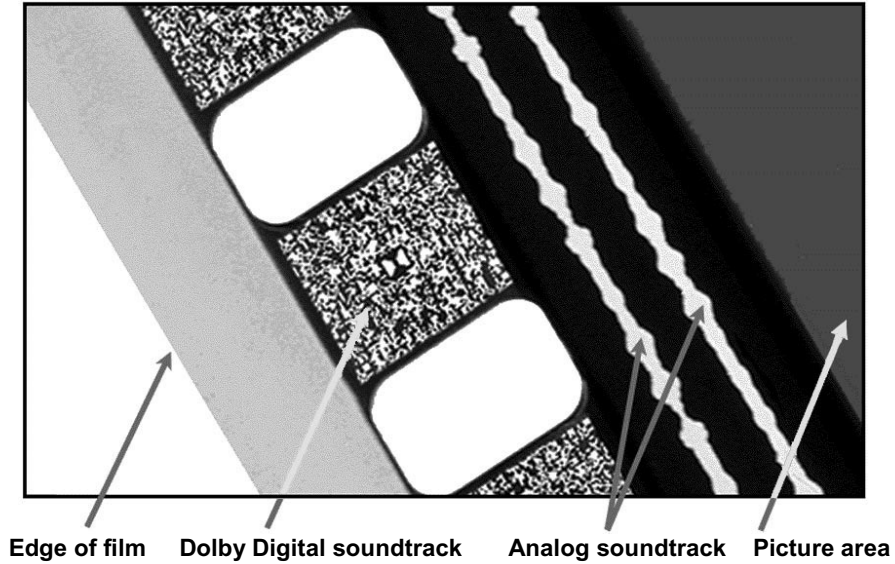


Figure 1–2 Photograph of Film Soundtracks

A Dolby Digital, Dolby Digital Surround EX, stereo optical (Dolby A-type or SR), or mono optical print should be identified as such on both the film can and the leader. However, with handling, the identification may be lost. If neither is available, close inspection of the film itself will help distinguish the various types. Digital data blocks are printed between the perforations on the side of the film next to the analog (Dolby SR) track.

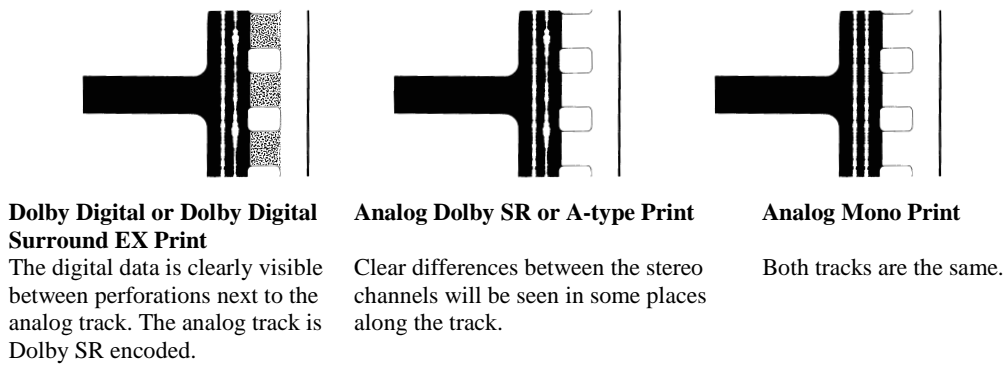


Figure 1–3 Film Soundtrack Identification

1.9 Regulatory Notices

1.9.1 FCC

This equipment has been tested and found to comply with the limits for a Class F digital device, pursuant to Part 15 of the FCC Rules. These limits are designed to provide reasonable protection against harmful interference when the equipment is operated in a commercial environment. This equipment generates, uses, and can radiate radio frequency energy and, if not installed and used in accordance with this instruction manual, may cause harmful interference to radio communications. Operation of this equipment in a residential area is likely to cause harmful interference in which case the user will be required to correct the interference at his or her own expense.

1.9.2 Canada

This Class A digital apparatus complies with Canadian ICES-003.

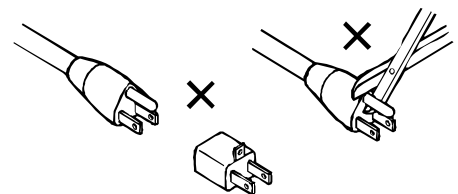
1.9.3 UL



WARNING: Troubleshooting must be performed by a trained technician. Do not attempt to service this equipment unless you are qualified to do so. Check that the correct fuses have been installed. To reduce the risk of fire, replace only with fuses of the same type and rating.

Exposed portions of the power supply assembly are electrically “hot.” In order to reduce the risk of electrical shock, the power cord **must** be disconnected when the power supply assembly is removed.

The ground terminal of the power plug is connected directly to the chassis of the unit. For continued protection against electric shock, a correctly wired and grounded (earthed) three-pin power outlet must be used. Do not use a ground-lifting adapter and never cut the ground pin on the three-prong plug.



1.9.4 UK

The power cord supplied for use in Europe (Dolby Part No. 92021) is not suitable for use in the UK. To use the cord in the UK cut off the CEE7/7 plug and replace with an approved BS 1363 13A plug:

- The core that is coloured green and yellow must be connected to the terminal in the plug identified by the letter **E** or by the earth symbol \equiv or coloured green or green and yellow.
- The core that is coloured blue must be connected to the terminal that is marked with the letter **N** or coloured black.
- The core that is coloured brown must be connected to the terminal that is marked with the letter **L** or coloured red.

This apparatus must be earthed.

1.9.5 Notices for Europe

This equipment complies with the EMC requirements of EN55103-1 and EN55103-2 when operated in an E2 environment in accordance with this manual.

IMPORTANT SAFETY NOTICE

This unit complies with the safety standard EN60065. The unit shall not be exposed to dripping or splashing and no objects filled with liquids, such as coffee cups, shall be placed on the equipment. To ensure safe operation and to guard against potential shock hazard or risk of fire, the following **must** be observed:

- o Ensure that your mains supply is in the correct range for the input power requirement of the unit.
- o Ensure **fuses fitted are the correct rating and type** as marked on the unit.
- o The unit **must be earthed** by connecting to a correctly wired and **earthed** power outlet.
- o The **power cord** supplied with this unit must be wired as follows:

Live—Brown Neutral—Blue Earth—Green/Yellow

(GB)

IMPORTANT – NOTE DE SECURITE

Ce matériel est conforme à la norme EN60065. Ne pas exposer cet appareil aux éclaboussures ou aux gouttes de liquide. Ne pas poser d'objets remplis de liquide, tels que des tasses de café, sur l'appareil. Pour vous assurer d'un fonctionnement sans danger et de prévenir tout choc électrique ou tout risque d'incendie, veuillez à observer les recommandations suivantes.

- o Le selecteur de tension doit être placé sur la valeur correspondante à votre alimentation réseau.
- o Les fusibles doivent correspondre à la valeur indiquée sur le matériel.
- o Le matériel doit être correctement relié à la terre.
- o Le cordon secteur livré avec le matériel doit être câblé de la manière suivante:

Phase—Brun Neutre—Bleu Terre—Vert/Jaune

(F)

WICHTIGER SICHERHEITSHINWEIS

Dieses Gerät entspricht der Sicherheitsnorm EN60065. Das Gerät darf nicht mit Flüssigkeiten (Spritzwasser usw.) in Berührung kommen; stellen Sie keine Gefäße, z.B. Kaffeetassen, auf das Gerät. Für das sichere Funktionieren des Gerätes und zur Unfallverhütung (elektrischer Schlag, Feuer) sind die folgenden Regeln unbedingt einzuhalten:

- o Der Spannungswähler muß auf Ihre Netzspannung eingestellt sein.
- o Die Sicherungen müssen in Typ und Stromwert mit den Angaben auf dem Gerät übereinstimmen.
- o Die Erdung des Gerätes muß über eine geerdete Steckdose gewährleistet sein.
- o Das mitgelieferte Netzkabel muß wie folgt verdrahtet werden:

Phase—braun Nulleiter—blau Erde—grün/gelb

(D)

NORME DI SICUREZZA – IMPORTANTE

Questa apparecchiatura è stata costruita in accordo alle norme di sicurezza EN60065. Il prodotto non deve essere sottoposto a schizzi, spruzzi e gocciolamenti, e nessun tipo di oggetto riempito con liquidi, come ad esempio tazze di caffè, deve essere appoggiato sul dispositivo. Per una perfetta sicurezza ed al fine di evitare eventuali rischi di scossa elettrica o d'incendio vanno osservate le seguenti misure di sicurezza:

- o Assicurarsi che il selettore di cambio tensione sia posizionato sul valore corretto.
- o Assicurarsi che la portata ed il tipo di fusibili siano quelli prescritti dalla casa costruttrice.
- o L'apparecchiatura deve avere un collegamento di messa a terra ben eseguito; anche la connessione rete deve avere un collegamento a terra.
- o Il cavo di alimentazione a corredo dell'apparecchiatura deve essere collegato come segue:

Filo tensione—Marrone Neutro—Blu Massa—Verde/Giallo

(I)

AVISO IMPORTANTE DE SEGURIDAD

Esta unidad cumple con la norma de seguridad EN60065. La unidad no debe ser expuesta a goteos o salpicaduras y no deben colocarse sobre el equipo recipientes con líquidos, como tazas de café. Para asegurarse un funcionamiento seguro y prevenir cualquier posible peligro de descarga o riesgo de incendio, se han de observar las siguientes precauciones:

- o Asegúrese que el selector de tensión esté ajustado a la tensión correcta para su alimentación.
- o Asegúrese que los fusibles colocados son del tipo y valor correctos, tal como se marca en la unidad.
- o La unidad debe ser puesta a tierra, conectándola a un conector de red correctamente cableado y puesto a tierra.
- o El cable de red suministrado con esta unidad, debe ser cableado como sigue:

Vivo—Marrón Neutro—Azul Tierra—Verde/Amarillo

(E)

VIKTIGA SÄKERHETSÅTGÄRDER!

Denna enhet uppfyller säkerhetsstandard EN60065. Enheten får ej utsättas för yttre åverkan samt föremål innehållande vätska, såsom kaffemuggar, får ej placeras på utrustningen." För att garantera säkerheten och gardera mot eventuell elchock eller brandrisk, måste följande observeras:

- o Kontrollera att späningsväljaren är inställd på korrekt nätspänning.
- o Kontrollera att säkringarna är av rätt typ och för rätt strömstyrka så som anvisningarna på enheten föreskriver.
- o Enheten måste vara jordad genom anslutning till ett korrekt kopplat och jordat el-uttag.
- o El-sladden som medföljer denna enhet måste kopplas enligt följande:

Fas—Brun Neutral—Blå Jord—Grön/Gul

(S)

BELANGRIJK VEILIGHEIDS-VOORSCHRIFT:

Deze unit voldoet aan de EN60065 veiligheids-standaards. Dit apparaat mag niet worden blootgesteld aan vocht. Vanwege het risico dat er druppels in het apparaat vallen, dient u er geen vloeistoffen in bekertjes op te plaatsen. Voor een veilig gebruik en om het gevaar van elektrische schokken en het risico van brand te vermijden, dienen de volgende regels in acht te worden genomen:

- o Controleer of de spanningscarroussel op het juiste Voltage staat.
- o Gebruik alleen zekeringen van de aangegeven typen en waarden.
- o Aansluiting van de unit alleen aan een gearde wandcontactdoos.
- o De netkabel die met de unit wordt geleverd, moet als volgt worden aangesloten:

Fase—Bruin Nul—Blauw Aarde—Groen/Geel

(NL)

Chapter 2 Installation

Do not connect the CP650 to mains power until all other connections have been made.

If air-conditioning noise is audible in the theatre, arrange for lubrication of the motor and fan bearings, adjustment of belts and drives, and cleaning of filters to reduce the ambient noise to a minimum. If the air-conditioning cannot be repaired, switch it off while the CP650 is being aligned.

2.1 Replacing an Existing Sound System

If the CP650 replaces an existing cinema sound system, play a typical film before you remove the old system so you will have a benchmark for comparison to the new system.

2.1.1 Before Playing the Film:

- Verify that the existing power amplifiers are in good working order.
- Verify that the existing speakers are in good working order, and that there are no loose or missing pieces, structural parts, or damaged drivers in the enclosures.
- Verify that all wiring is present and properly connected, and that crossovers are operating and are correctly adjusted.
- Check the polarity of the speaker connections.
- Verify that there are adequate ground (earth) connections.
- Verify that radio interference problems are adequately resolved.

2.1.2 While Playing the Film:

While running the film, listen carefully in various parts of the theatre for audio system problems, including:

- Hum
- Noise, clicks, or pops
- Distorted sound
- Poor tonal balance (lack of high-frequency or bass content)

These problems must be resolved before the installation process can proceed.

2.1.3 Disconnect the Old System

- Disconnect power from the existing cinema sound equipment.
- Disconnect all cabling from the existing sound processor. Leave the cables connected to the power amplifiers, booth monitor, etc.

2.2 Check Fuse and Bypass Mains Voltage Selector



WARNING: Check that the correct main fuse has been installed. To reduce the risk of fire, replace only with fuses of the same type and rating.

The CP650 uses a universal switching power supply that can accommodate nominal mains voltages from 100 to 120, and 200 to 240 VAC, at frequencies from 50 to 60 Hz.

Check Main Fuse

The main power supply fuse is a 6.3 A, 250V, 20 mm, time-lag, low breaking capacity fuse (T 6.3 L). With a small flat-blade screwdriver, open the fuse compartment door on the AC power input housing (See Figure 2–1.)

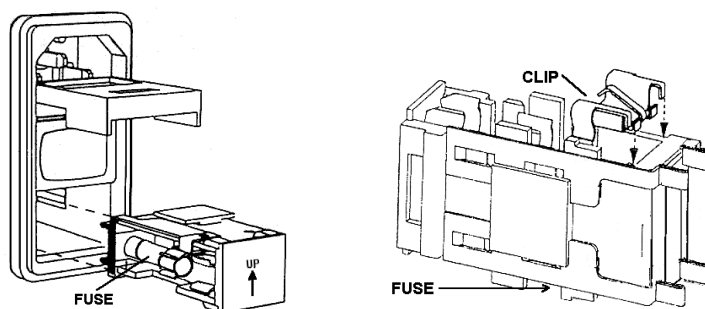


Figure 2–1 Main Fuse Assembly

Remove the fuse carrier and check that the fuse in the active (left position) is of the correct rating. The fuse carrier must be inserted into the compartment with the fuse oriented to the left. *Do not force the carrier into the compartment. Damage will result.* The polarizing clip must be attached on the right side of the carrier at the rear. Snap the fuse compartment door closed.

Check Bypass Supply Mains Voltage Setting

The bypass power supply mains voltage selector switch is accessible through a hole in the top cover of the CP650. Use a screwdriver to set the switch to either 120 or 220 VAC Figure2_8 shows the switch location.

Caution: Be sure to check this setting. If the bypass voltage selector is set to 120 V but the unit is connected to 220 V mains voltage, the bypass power supply fuse will blow.

Bypass Power Supply Fuse

The bypass power supply fuse is accessible by removing the plastic front-panel and the front subpanel. It is located above the power/bypass switch. The fuse values are:

For 110 VAC Mains

T 200 mA L (time-lag, 200 mA, 20 mm, low breaking capacity, 250 V)

For 220 VAC Mains

T 100 mA L (time-lag, 100 mA, 20 mm, low breaking capacity, 250 V)

Caution: Early CP650s used a 315 mA fuse for all mains voltages. The fuse ratings above should be used for more reliable overcurrent protection.

Internal Fuse

The switching DC power supply contains a separate internal fuse, not accessible to the installation engineer or user. Do not remove the power supply cover. The CP650 main fuse will protect most fault conditions. If this fuse blows, the power supply has certainly failed.

2.3 Mount the CP650

To avoid heat or hum pickup problems, do not mount the Dolby CP650® immediately above or below the power amplifiers. Locate the power amplifiers away from the CP650 to avoid hum pickup problems. Always leave a 1U space (43 mm, or 1.75 inches) above and below the CP650 to provide adequate ventilation. Install an air guide or baffle to deflect hot air from equipment below the CP650.

To ensure good ground contact, install a star washer on at least one (and preferably all) rack-mounting screw(s) per piece of equipment (Figure 2–2). This will also aid in the prevention of electrical noise problems.

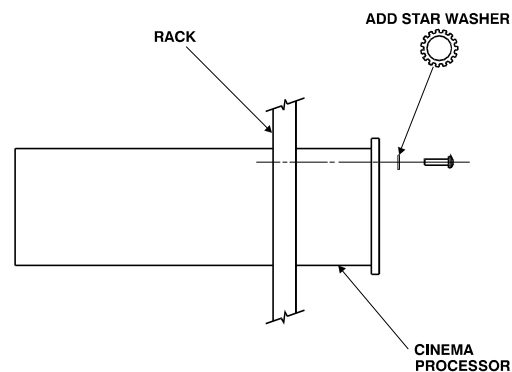


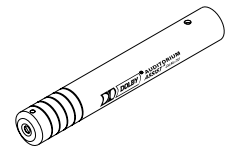
Figure 2–2 Star Washers and Rack-Mounting Screws

Proper shielding and termination of cables and cable assemblies are also very important. Follow the methods shown in the wiring diagrams.

If you are installing a Dolby Cat. No. 701 Digital Soundtrack Reader, refer to its installation manual for mounting and alignment.

2.4 Mount the Auditorium Assist Microphone

Auditorium Assist™ operation requires the use of the Cat. No. 735 microphone. Mount the microphone permanently in the auditorium, at a convenient location away from sound sources. If the rear wall is used, the microphone should be centered between surround speakers. Wall plates with an integrated XLR connector are available. Examples include:



Switchcraft J3FS—Stainless Steel
Whirlwind WP1B/1FND—Black

Connect the microphone to the mic input located on the rear panel of the CP650 cinema processor. If the microphone input in your installation is currently dedicated to other uses, such as an emergency public address, install the necessary hardware to switch between microphones.

2.5 Connect the CP650

Refer to the appropriate foldout pages, located at the end of this chapter, showing connections to the CP650.

Shields must be connected as shown in the foldout pages to avoid radio frequency interference.

Note: Follow all local codes and regulations covering electrical wiring. It is recommended that conduit be used for wiring runs.

Connector shells have been included in your installation kit for use in countries that are governed by the EMC directives. The shells **must** be used as noted on the foldout pages.

2.5.1 Motor-Start Relays (Models CP650 and CP650D)

For two-projector installations, motor-start relays are required for projector changeover. Digital data on the soundtrack is read in advance of the picture; therefore an advanced changeover signal is required. Projector motor-start contact closures provide this signal to the CP650. **Isolated** contact closures from mechanical or opto-isolated relays wired across projector motors must be used. Refer to the **Installation Wiring Inputs and Control diagram** at the end of this chapter.

Signal levels:

Motor Start: Less than 1 VDC with respect to signal ground
Motor Off: Greater than 3.5 VDC, less than 18 VDC

If the CP650 is to be used in a platter operation (single projector), a jumper must be installed. A pre-wired connector is installed at the factory for this purpose.

2.5.2 Remote Controls

Three types of remote controls can be used with the CP650. A maximum of three remote units (in any combination) can be used.

The **Cat. No. 779 CP650 Remote Control Unit** duplicates the front-panel format selection, fader, and mute functions of the CP650.

The **Cat. No. 771 Remote Fader Unit** duplicates the front-panel main fader knob and level display of the CP650.

A customer-supplied **100 k Ω linear pot**, wired as a variable resistor, can also be used. Minimum pot resistance corresponds to a front-panel fader setting of maximum (10).

Details on how to connect any of these remote controls to the CP650 are shown in Chapter 8.1 and in the **Installation Wiring Input and Control** drawing located at the end of this chapter.

2.5.3 Solar Cell Reader Boards

Most new projectors sold around the world incorporate a reverse-scan LED analog soundhead reader. In addition, many existing projectors are being upgraded to include this superior method of playing back SVA soundtracks. The Dolby Cat. No. 655 solar cell preamp board is an example of this kind of upgrade. The output of the solar cell in this system is at a lower level than a normal incandescent exciter lamp solar cell. In order to provide the correct signal level for the cinema processor, this small preamp board is mounted in the soundhead. Some care needs to be given to the wiring between the board and the CP650 in order to avoid grounding problems and to provide immunity to RF interference. In principle, this means separating the audio ground connections and the RF shielding screen connections.

The 0 V point (audio ground) must be connected from the inboard reader board to the CP650 by a separate wire (or wires) along with the audio signal wires. The cable shield (screen) must be kept separate from the audio ground connections. It must be connected only to the chassis or enclosure of the equipment at each end.

The following diagrams show two connectors on the Cat. No. 655 circuit board. The three-pin connector, J1, is used for the power connections. The signal output connector, J2, provides six output pins: two each for the balanced left and right outputs, and two 0 V audio ground connections.

The physical orientation of the board mounting in the projector and the orientation of the connector body mounting on the board affect which channel appears on which pin of the connector. **Be aware that pin allocations for the channels will vary depending on mounting arrangements of the board and connector.** The J2 connector pin solder hole with a square outline is pin 1.

Table 2-1 Solar Cell Preamp Board Connectors

J2 Pin Number	Signal
1	Right (or Left) +
2	Signal Ground
3	Right (or Left) -
4	Left (or Right) +
5	Signal Ground
6	Left (or Right) -
J1 Pin Number	Power from CP650
7	+15 V
8	-15 V
9	Signal Ground

There must be a connection between the ground pins at the Cat. No. 655 solar cell circuit board and the audio common in the CP650. This connection must **not** use the shield of the optical input cable, since doing so may impose RF energy on the CP650 ground system.

Pin numbers 6 and 9 of each 9-pin D-connector (“Projector”) on the CP650 allow these connections to be made. The wire that connects either of these pins to the Cat. No. 655 audio ground should pass inside the same shield as the optical input cables and not connect with the shield at any point.

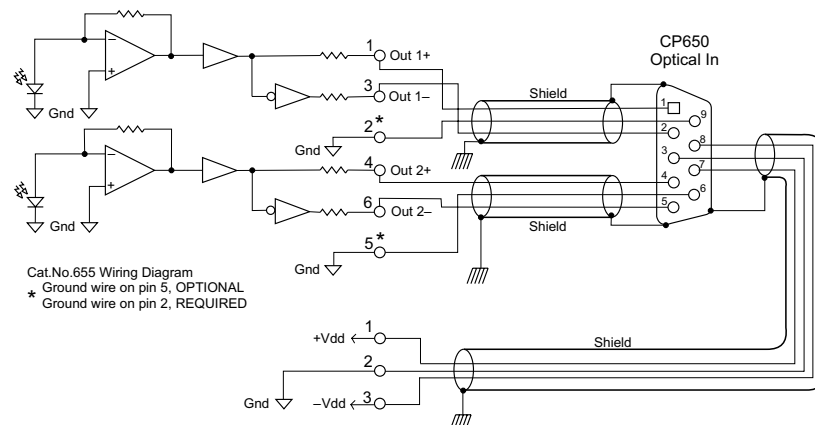


Figure 2-3 Cell Preamp Wiring Using Two 3-Conductor Shielded (Screened) Cables

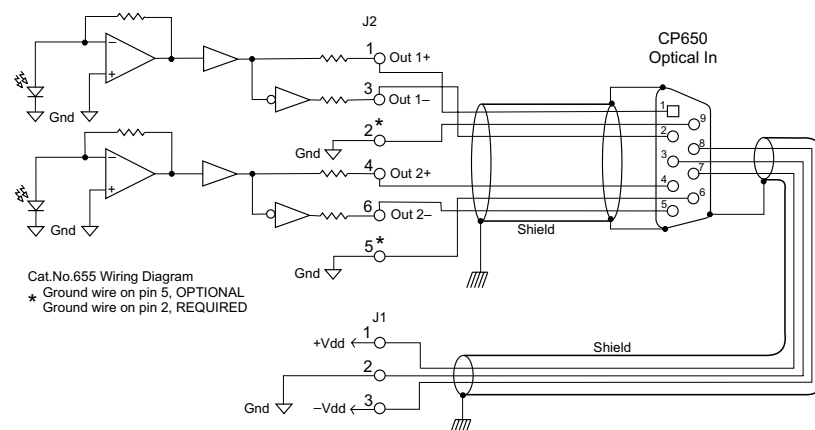


Figure 2-4 Cell Preamp Wiring Using One 5- or 6-Conductor Shielded (Screened) Cable

For Non-EU Countries Only:

If it is necessary to use two- or four-conductor shielded cables, use the following wiring diagrams.

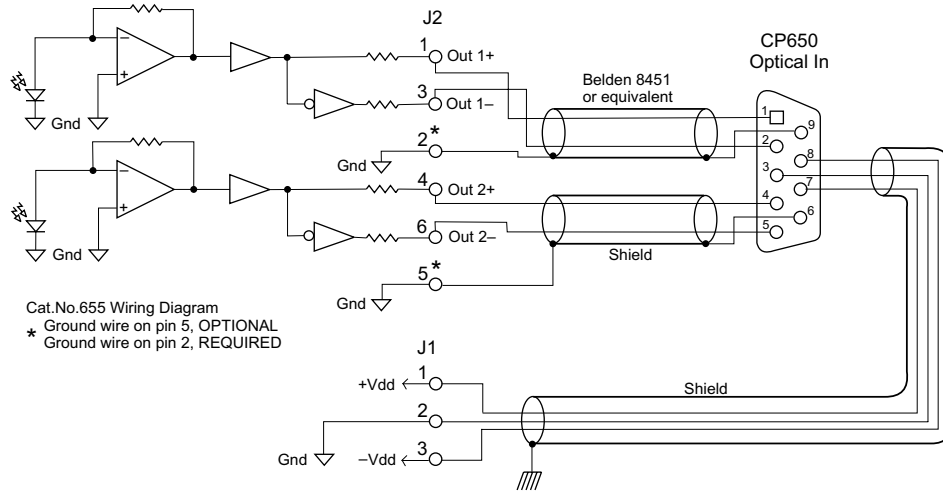


Figure 2-5 Cell Preamp Wiring Using Two 2-Conductor Shielded (Screened) Cable

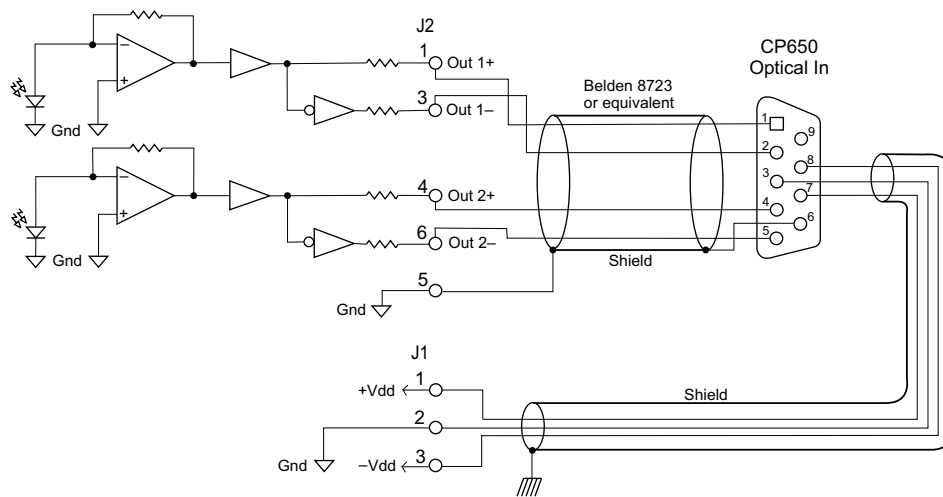


Figure 2-6 Cell Preamp Wiring Using One 4-Conductor Shielded (Screened) Cable

2.5.4 Analog Nonsync Sources

The CP650 has two sets of analog nonsync inputs, designated nonsync 1 (Format 60), and nonsync 2 (Format 61). The input impedance is 11 k Ω . They both have a wide range of input level adjustment, but to further extend the possible range of input levels, the two sets of inputs have different gain adjustment ranges:

- The nonsync 1 input will accommodate input levels between approximately 0.2 and 4 V.
- The nonsync 2 input will accommodate input levels between approximately 0.06 and 1.5 V.

2.5.5 Digital Audio Sources

The CP650 can accept AES/EBU or S/PDIF digital audio bitstreams, generated by digital audio sources including CD players, DAT recorders, DVD players, satellite television receivers, HDTV receivers, or HD video players.

With the Cat. No. 790 board (included with the standard model CP650) installed, the CP650 accepts up to four two-channel PCM (pulse code modulated) bitstreams. Each bitstream contains the data for two channels of PCM audio. Sampling rates of up to 48 kHz—with up to 24-bit resolution—are accommodated. This bitstream format can be found on the digital output connector of a CD player, DAT recorder, DVD player, or any basic piece of digital audio equipment. The inputs are S/PDIF single-ended signals. To use these inputs, a digital input format (Format 80, 81, 88, 89, or 90) may be assigned to one of the user-definable format buttons U1, U2, or NS.

See Sections 7.8 and 7.9.

With the Cat. No. 794 board (included with earlier CP650s) installed, the CP650 accepts a digital audio bitstream. The Cat. No. 794 can accept either AES/EBU differential signals or S/PDIF single-ended signals, depending on jumper settings on the board itself (see Figure 2-7). To use this input, Format 80 (Master Digital In) must be assigned to one of the user-defined format buttons U1, U2, or NS. See Sections 7.8 and 7.9.

With an optional Cat. No. 778 board installed, the CP650 gains the capability to accept up to four two-channel digital audio bitstreams, and provides up to five digital two-channel audio bitstream outputs. The CP650 can accept either PCM or Dolby Digital bitstreams on its AES1 digital audio input. Additionally, the Cat. No. 778 allows the CP650 to accept up to four PCM-formatted AES/EBU inputs, giving a total of eight discrete audio channels. The board provides five AES/EBU outputs to support up to ten discrete audio channels. All inputs and outputs comply with AES/EBU standards. The CP650's main analog outputs are disabled with a Cat. No. 778 installed.

Connecting to the Digital Audio Input

The external electrical connections to the optional boards in the CP650 are available on the 25-pin D-connector marked “Option I/O” on the rear panel of the CP650. Since the boards have different functionality, each pin on this connector changes its function depending on which optional card is installed. Refer to Table B-2 for the signal definitions. Make external connections by soldering the appropriate wires to the male solder-cup connector shipped with the CP650, then plug this connector into the Option I/O connector on the CP650.

Note: When wiring to the digital inputs on the Cat. No. 790 or Cat. No. 778, be sure to ground all unused digital inputs. Failure to do so will cause unused channels to show signal level due to crosstalk between the used digital inputs and the unused digital inputs.

In a CP650 equipped with a **Cat. No. 790** board, the input type is S/PDIF. See Figure 2-7 for Option I/O connector hookup details. Refer to Table B-2 for signal definitions.

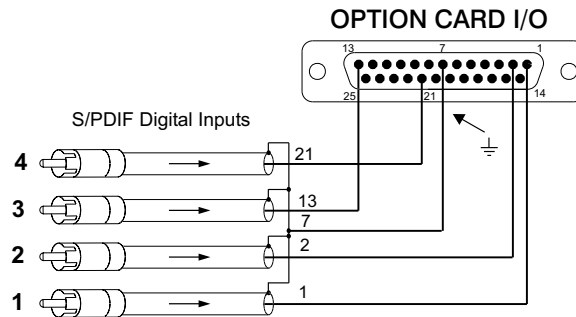


Figure 2-7 Cat. No. 790 S/PDIF Connections

In a CP650 equipped with the earlier **Cat. No. 794** board, the input type (AES/EBU or S/PDIF) must be selected using jumpers on the board. The default factory setting is AES/EBU. See Figure 2-7 for Option I/O connector hookup details. Refer to Table B-2 for signal definitions. When a **Cat. No. 778** board is installed, the input type is always AES/EBU.

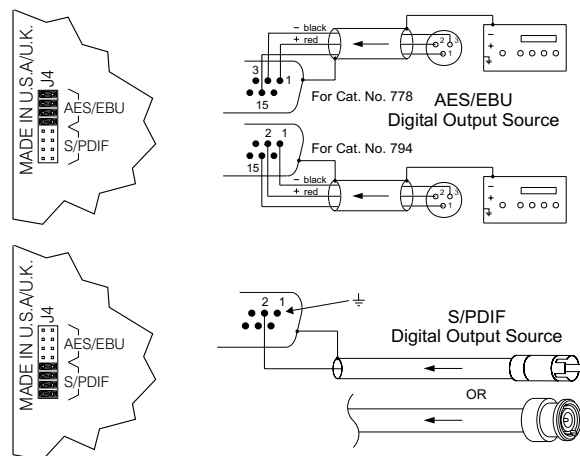


Figure 2-8 Cat. Nos. 794/778 AES/EBU and S/PDIF Jumper Selections and Connections

Professional Interface Standards for Digital Audio

There are two professional interface formats used for digital audio: **AES/EBU (also known as AES3)** and **AES3id**. These stream the same digital data and professional audio header information over copper conductor links, but use different types of conductors and connectors.

AES/EBU uses a balanced connection (two conductors plus shield) with a characteristic input impedance of 110Ω , nominal peak-to-peak signal level of 5 V, and most commonly, XLR connectors. The typical maximum transmission distance is 100 meters. AES3id uses an unbalanced connection (one signal conductor plus shield) with a characteristic input impedance of 75Ω , peak-to-peak signal level of 1 V, and BNC (“push and twist”) connectors. The typical maximum transmission distance is 1000 meters.

Professional digital audio equipment usually uses the AES/EBU format because balanced operation yields superior noise immunity, as it does with analog audio signals, and because XLR connectors have been standard on analog professional audio equipment.

Professional video equipment usually uses the AES3 variation of this interface, with BNC connectors. Like the use of XLR connectors on pro audio equipment, the adoption of BNC connectors for the audio on professional video equipment stems from their existing use for the video signal. Also, the unbalanced AES3 signal can connect to more than one piece of equipment by using the loop-through connectors that are available on some devices, and is robust for long cable runs.

Consumer Interface Standards for Digital Audio

The consumer interface standard for digital audio is **S/PDIF (IEC61937)**. S/PDIF is found using either coaxial unbalanced connections (one signal conductor plus shield) with a characteristic input impedance of 75Ω with RCA (phono) connectors, or a fiber-optic cable with Toslink™ connectors. The unbalanced coaxial connection has a peak-to-peak signal level of 0.5 V. The typical maximum transmission distance is 10 meters. Although S/PDIF-specific cables with suitable connectors can be purchased, good results can also be obtained using high-quality 75Ω video cable with the appropriate connectors and/or adapters.

Cable Issues

Even in digital audio, noise-free signals are still very important. The cable used for digital signals is specifically designed for digital audio use, even though it appears to be the same as that used for analog audio or video signals. Any professional audio equipment or broadcast supply company can provide 110Ω cable with connectors (or without, if you wish to terminate them yourself) for AES/EBU connections, and high-quality 75Ω video cables with BNC connectors for AES3id connections. Use of cables or connectors with incorrect impedance or not designed for digital transmission compromises the integrity of the bitstream and may create an unreliable link between pieces of equipment, particularly with long cable runs.

Multiple Sources: Conversion Between Interface Standards

Although some details of the bitstreams used in the AES and S/PDIF standards are different, the audio information is exactly the same. As a consequence, most audio equipment will accept either standard with no need to convert the bitstream itself; this is the case with the CP650. However, if you intend to connect sources across different types of digital audio inputs, **Do not** attempt to convert a digital interface type by, for example, directly wiring an XLR connector to a BNC or RCA plug. This causes an impedance mismatch and signal reflections, resulting in degradation of the digital waveform. It may seem to work, but the results are unreliable and dropouts occur.

For conversion between the AES3id and S/PDIF formats you can use high-quality RCA (phono plug)-to-BNC adapters because the cable and impedance are both the same (75Ω).

For conversion between the AES/EBU and AES3id or AES/EBU and S/PDIF formats, a simple and economical method is to use inline transformers. These devices perform the necessary impedance and balanced/unbalanced conversion. Table 2–2 shows some examples of suitable adapters. The unbalanced connector in these examples is a BNC. BNC-to-RCA adapters can be added to connect to consumer S/PDIF connections. The units listed use passive circuitry.

Table 2–2 Examples of Available Balanced ↔ Unbalanced Adapters

Adapter Type	Neutrik®	Canare™
XLR female 110Ω in to BNC Female 75Ω out	NA-BF	BCJ-XJ-TRA
BNC Female 75Ω in to male XLR 110Ω out	NA-BM	BCJ-XP-TRA

Higher-priced units incorporating active circuitry are also available. These offer additional features like multiple inputs, inputs for Toslink digital connections, and multiple outputs.

2.6 Exploded View and Board Locations

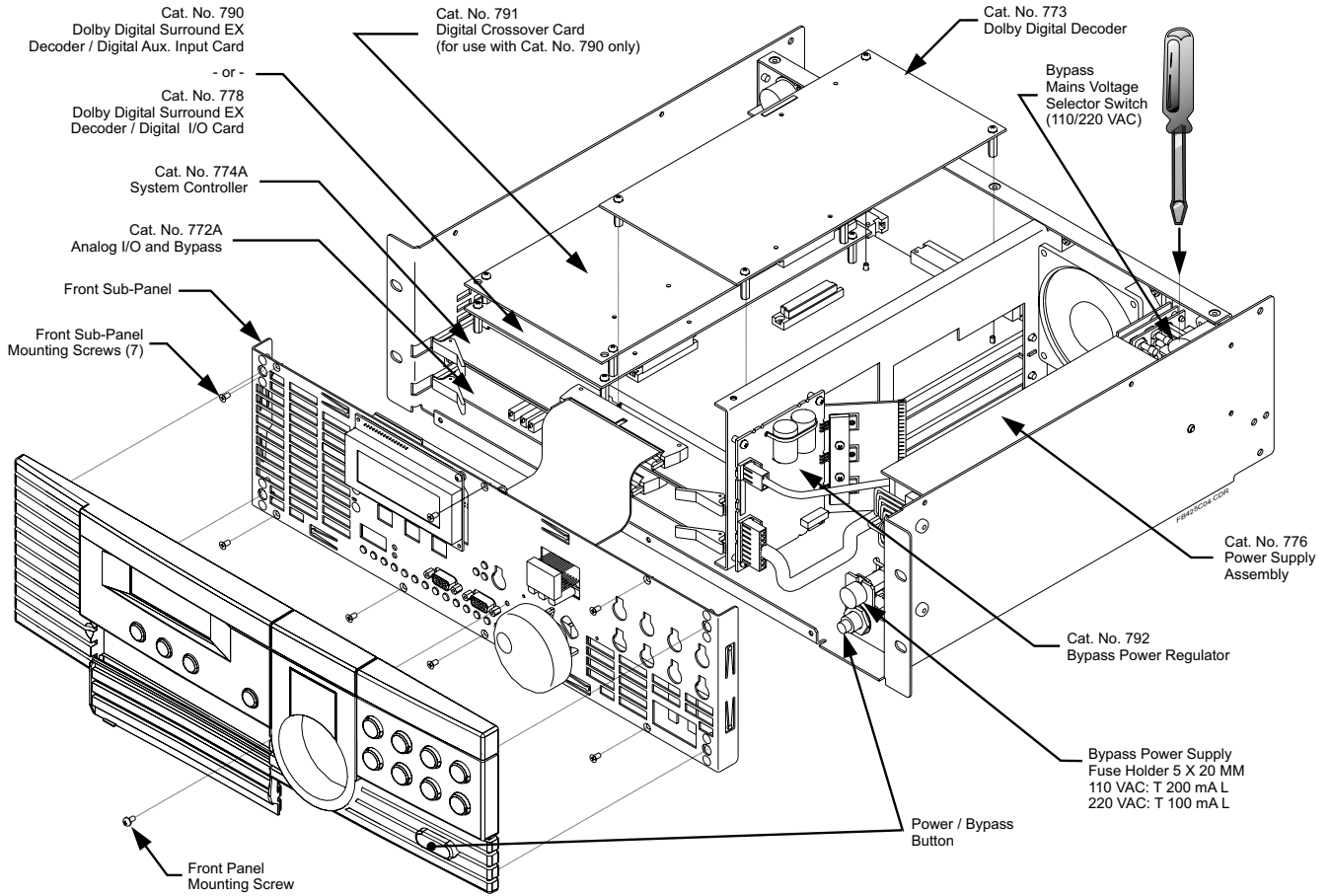
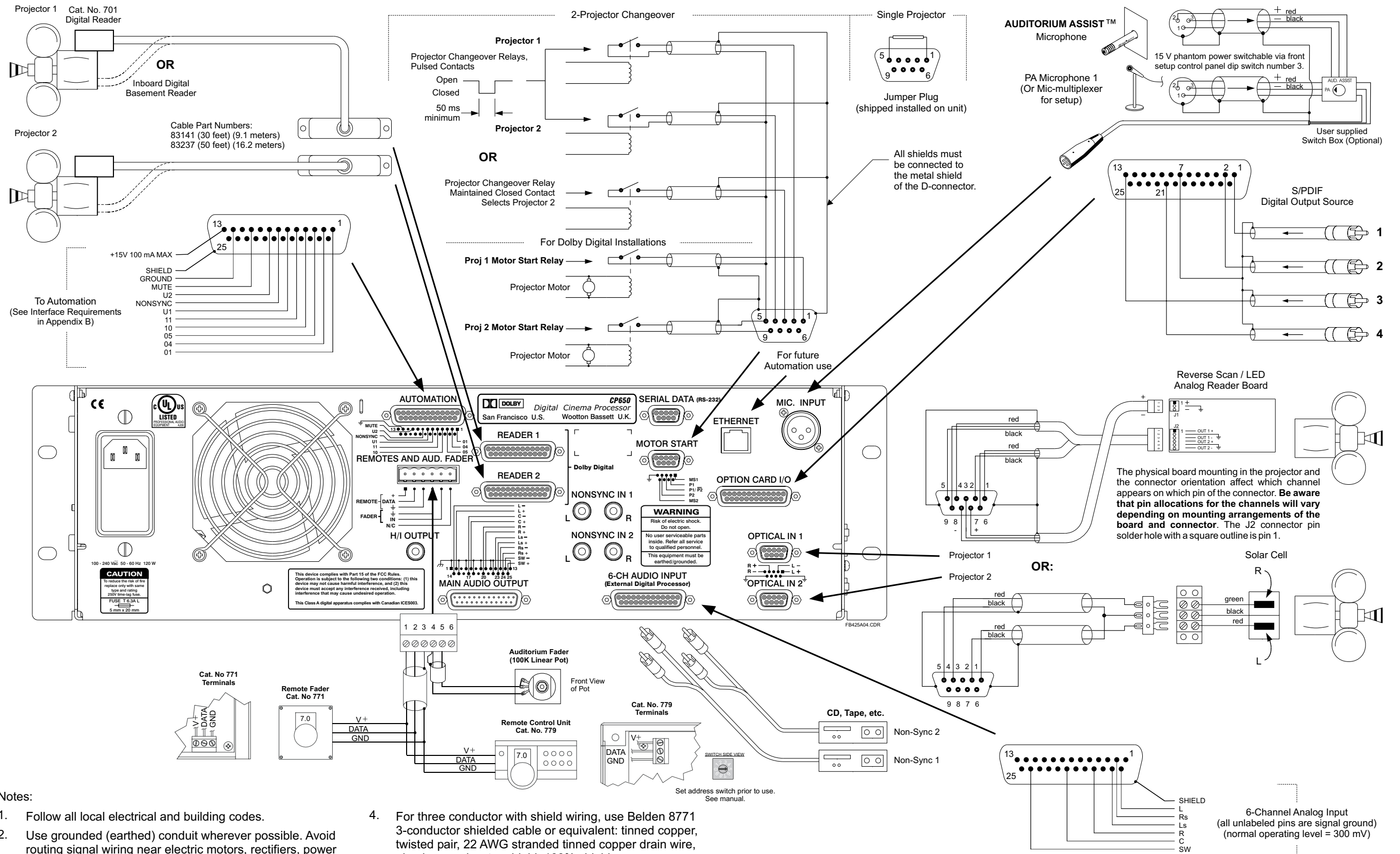


Figure 2-8 Model CP650 Exploded View

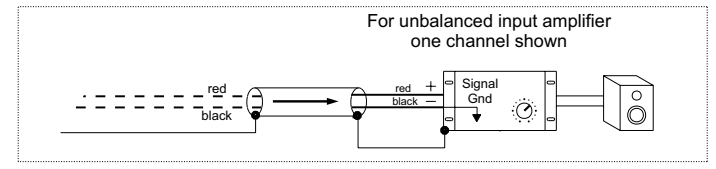
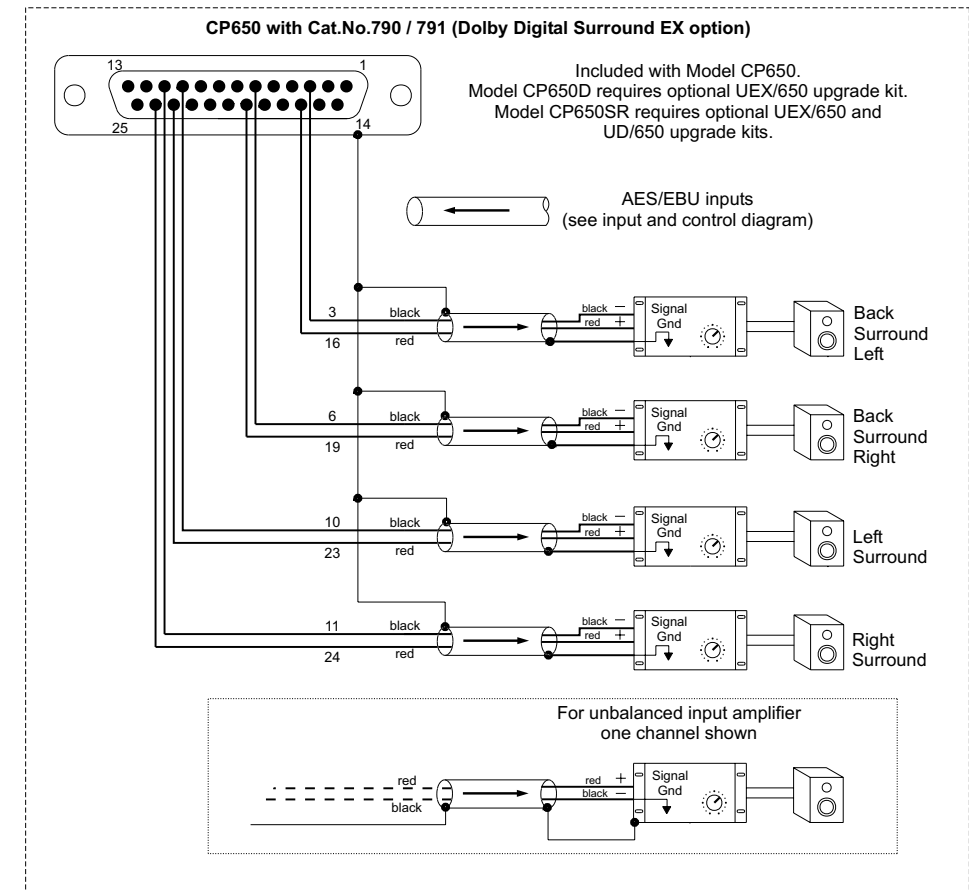
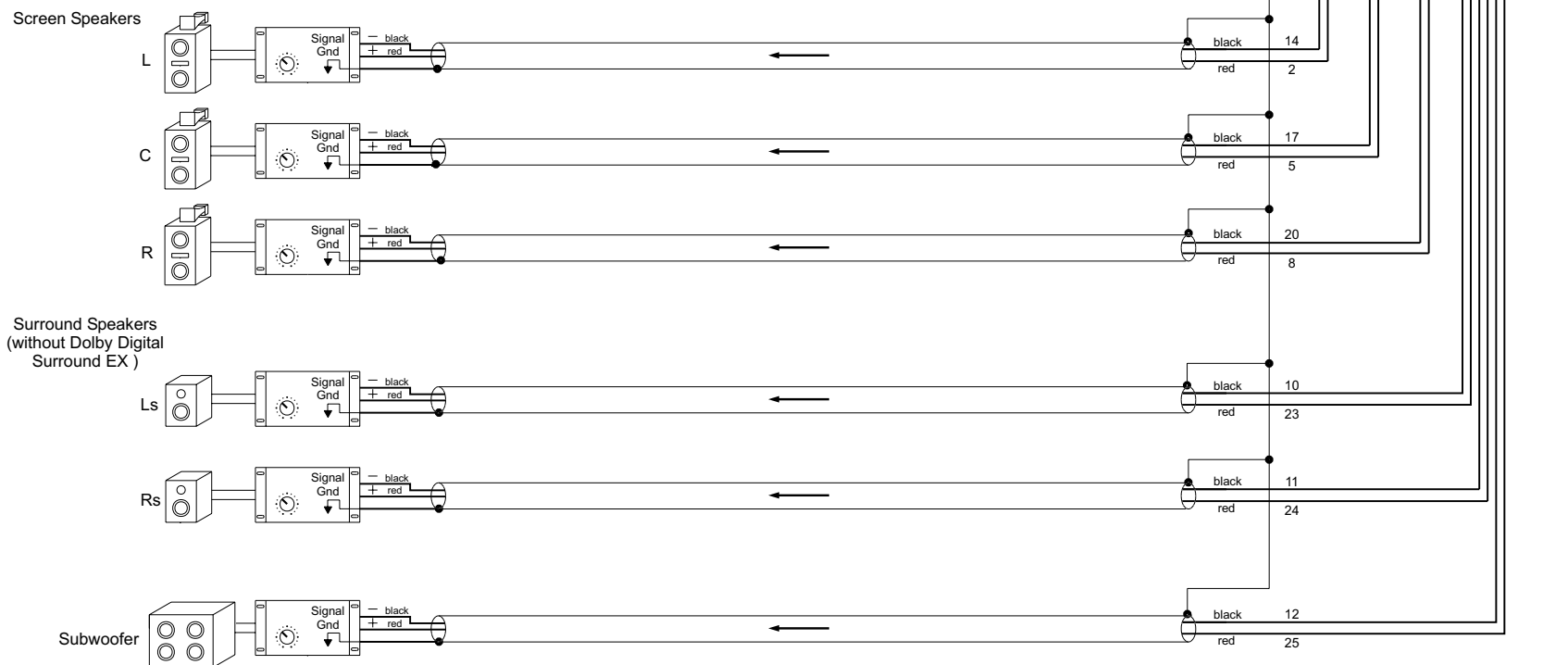
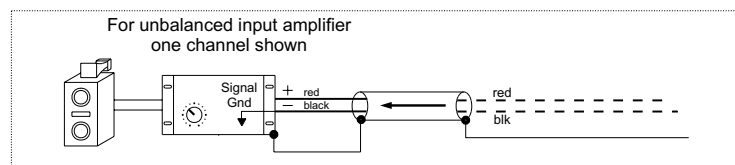
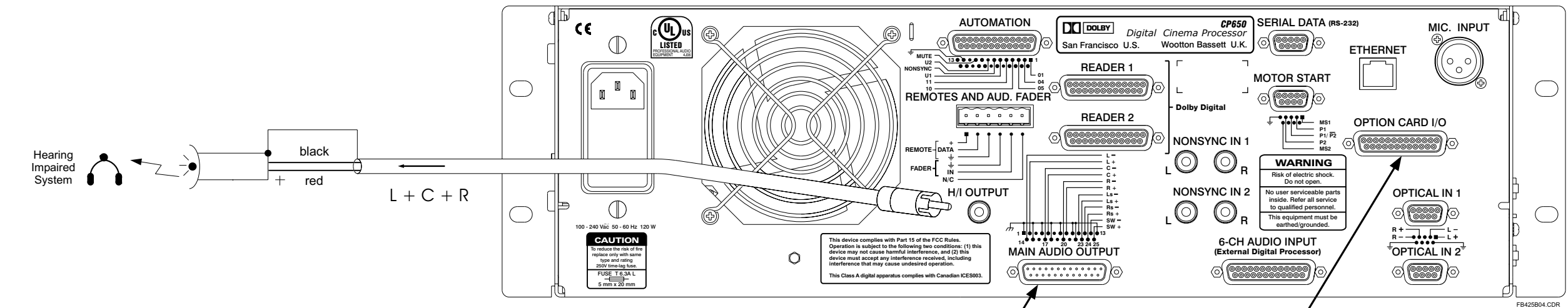
Disassembly steps can be found in the troubleshooting section of this manual.
(See Section 9.3.2.)



Notes:

- Follow all local electrical and building codes.
- Use grounded (earthed) conduit wherever possible. Avoid routing signal wiring near electric motors, rectifiers, power wiring, dimmer wiring, or other sources of electrical noise.
- For two conductor with shield wiring, use Belden 8451 2-conductor shielded cable or equivalent: tinned copper, twisted pair, 22 AWG stranded tinned copper drain wire, aluminum-polyester shield, 100% shield coverage, conductor-to-conductor 111 pF per meter.
- For three conductor with shield wiring, use Belden 8771 3-conductor shielded cable or equivalent: tinned copper, twisted pair, 22 AWG stranded tinned copper drain wire, aluminum-polyester shield, 100% shield coverage, conductor-to-conductor 75 pF per meter.
- All shields must be connected to the CHASSIS of the CP650. This achieves the required RF interference immunity. A metal housing must be used for all D-connectors and the shields must be connected to the housing. Chassis ground and circuit (audio) ground are internally connected.

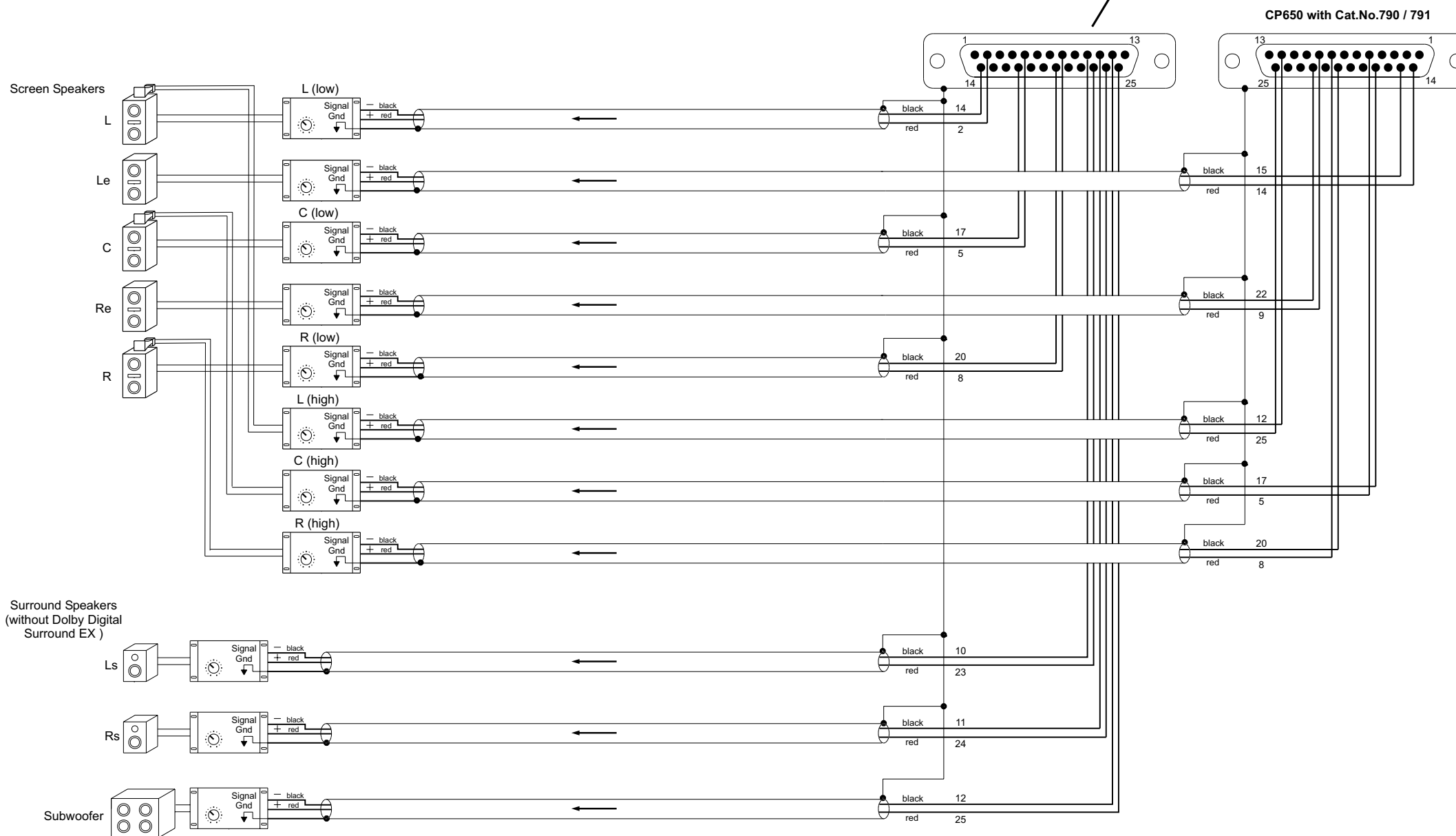
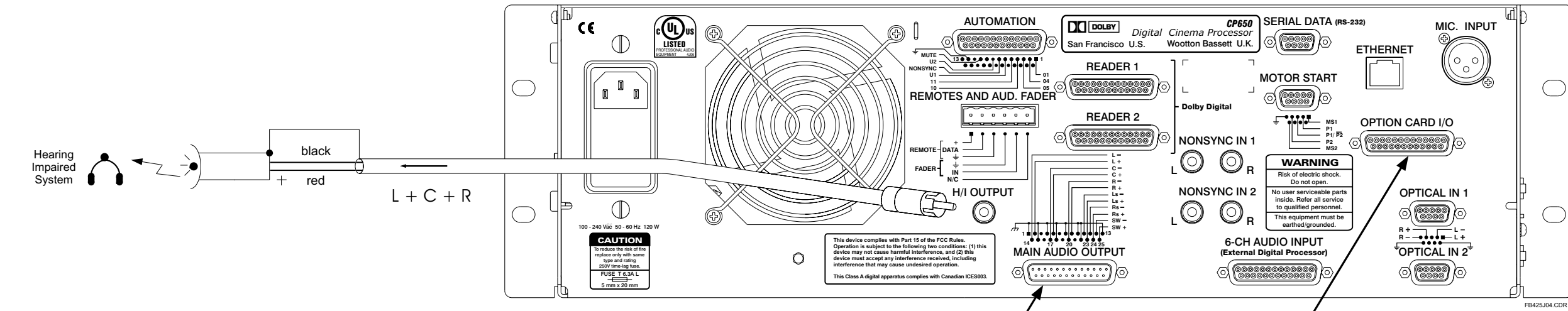
CP650 INSTALLATION WIRING INPUT AND CONTROL CONNECTIONS



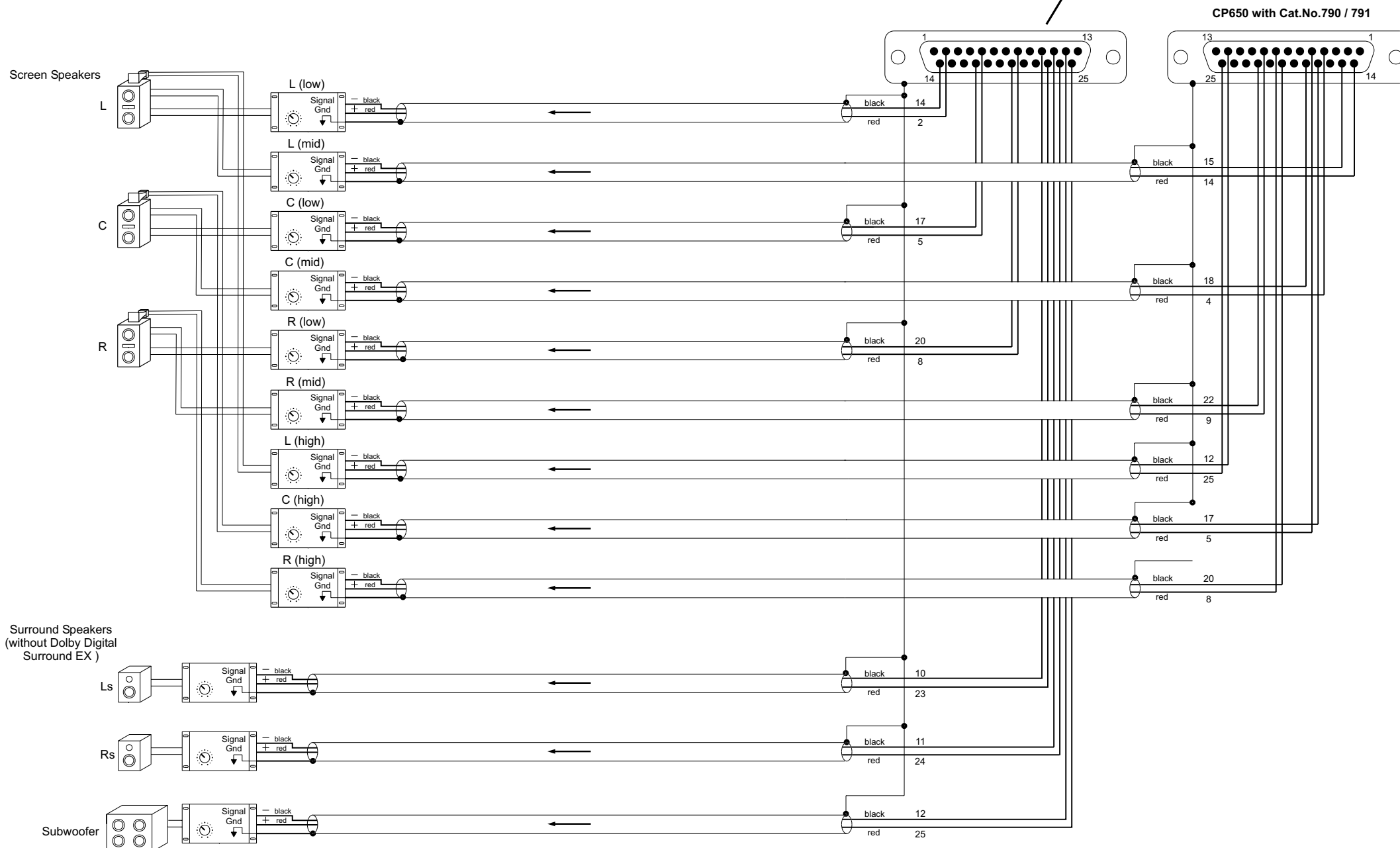
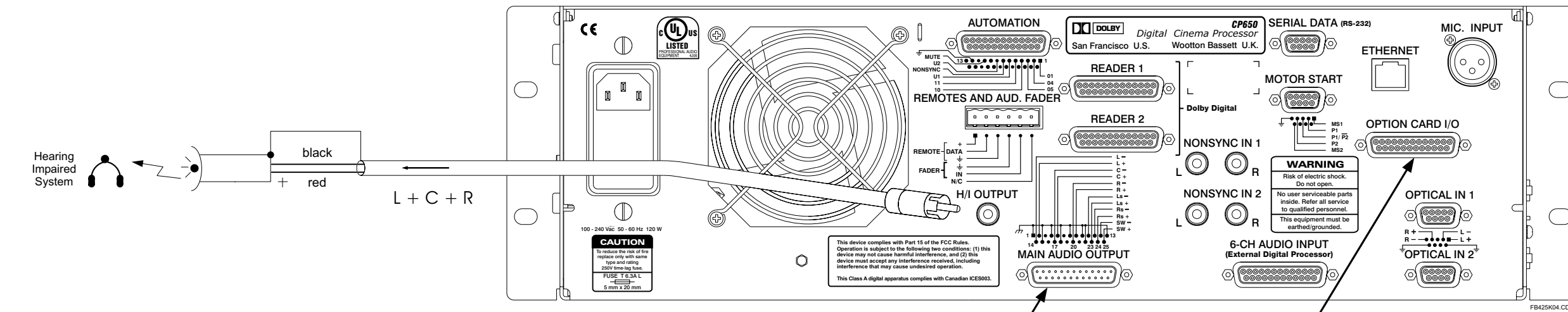
Notes:

1. Follow all local electrical and building codes.
2. Use grounded (earthed) conduit wherever possible. Avoid routing signal wiring near electric motors, rectifiers, power wiring, dimmer wiring, or other sources of electrical noise.
3. For two conductor with shield wiring, use Belden 8451 2-conductor shielded cable or equivalent: tinned copper, twisted pair, 22 AWG stranded tinned copper drain wire, aluminum-polyester shield, 100% shield coverage, conductor-to-conductor 111pF per meter.
4. All shields must be connected to the CHASSIS of the CP650. This achieves the required RF interference immunity. A metal housing must be used for all D-connectors and the shields must be connected to the housing. Chassis ground and circuit (audio) ground are internally connected.

**CP650 INSTALLATION WIRING
AUDIO OUTPUT CONNECTIONS**

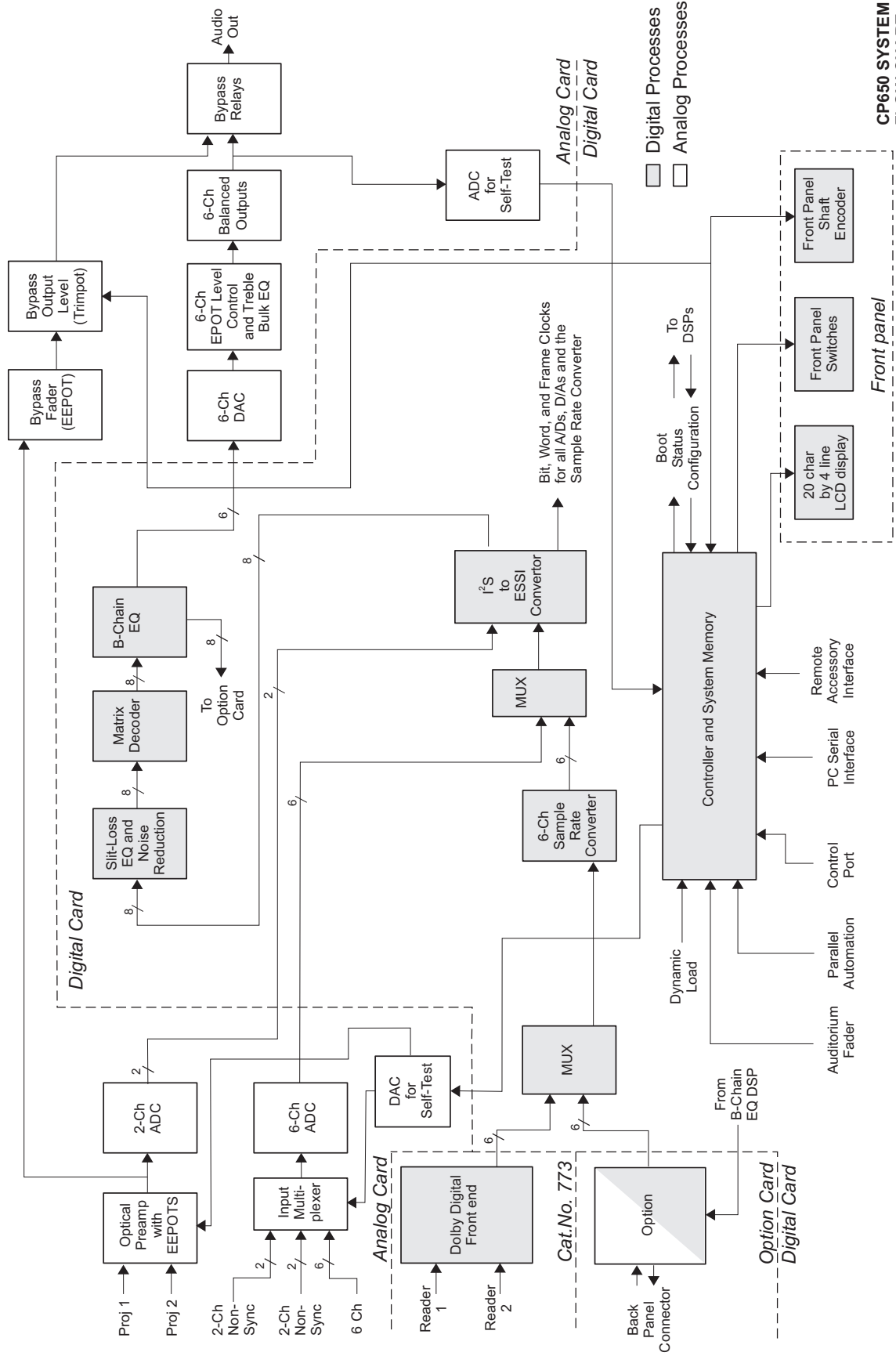


**CP650 INSTALLATION WIRING
AUDIO OUTPUT CONNECTIONS
FOR BIAMPLIFIED SCREEN SPEAKERS**



**CP650 INSTALLATION WIRING
AUDIO OUTPUT CONNECTIONS
FOR TRIAMPLIFIED SCREEN SPEAKERS**

Dolby® Model CP650 Installation Manual



CP650 SYSTEM FLOW CHART

FB425F01.CDR

Chapter 3

Front Panel and Alignment Overview

This chapter describes the features on the CP650 front panel, along with an overview of the general principles involved in the alignment of Dolby® cinema equipment. It is useful to develop an understanding of why the CP650 is aligned as described in this manual. If the installer is already familiar with the CP650 and these principles, or is in a hurry to complete the installation, this chapter may be read later. Continue the setup procedure beginning with the next chapter.

3.1 The CP650 Front Panel

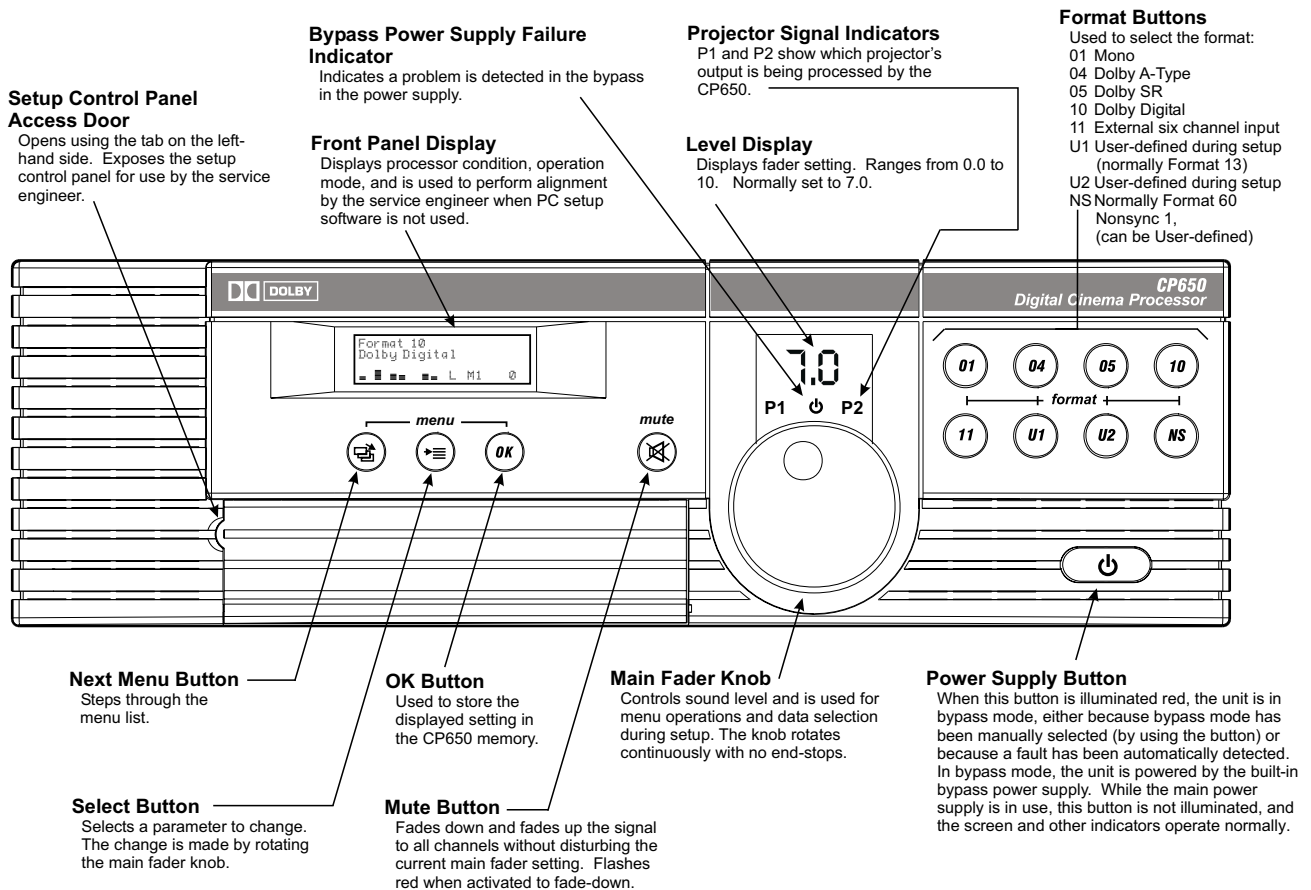


Figure 3-1 Front-Panel Controls

Front-Panel Display

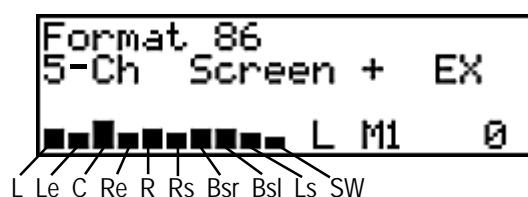


Figure 3-2 Front-Panel Display Showing All Possible Channels Active

Day-to-day operation of the CP650 is performed through interaction with this display. The 20-character, four-line LCD provides a read-out of processor condition and operation mode. It can be used by the service engineer to align the CP650 if PC setup software is not used.

Figure 3-2 shows the display that is active when the CP650 is processing and playing a digital signal connected to the CP650 input with all channels active. The top two lines display the current format, which in this case is Dolby® Digital Surround EX™, with five screen channels active. The bottom left area contains an active bar graph display of the sound signals present on each channel. The bars move, confirming that sound is passing through the CP650.

The bars are displayed starting with the Left screen channel, and moving clockwise around the auditorium:

Left screen, Left Extra screen, Center screen, Right Extra screen, Right screen, Right Surround, Back Surround Right, Back Surround Left, Left Surround, Subwoofer.

The **L** on the display indicates that fader control is set to **local**, meaning that the fader knob on the front panel of the CP650 (and any Dolby remote box fader knob) controls the sound level in the auditorium. If the display shows an **A**, an external non-Dolby auditorium fader knob controls the sound level.

M1 indicates that the projector 1 motor contact is closed or jumpered (motor-start connector on the back panel). The motor running signals are used in the timing of changeovers while running Dolby Digital films in a two-projector system.

The **0** shown on the bottom right is the Dolby Digital film error rate. The first indication of satisfactory digital film playback is the detection of a low error rate. The error rate is a number between 0 and 8. With a correctly aligned digital film reader, most films will play at an error rate of **6** or lower. If the digital error rate exceeds **8**, or if the display shows **F** (data not readable) or “-” (no digital soundtrack), the CP650 automatically switches to playing the film’s analog soundtrack until usable data appears.

Other Possible Front-Panel Sound Format Displays

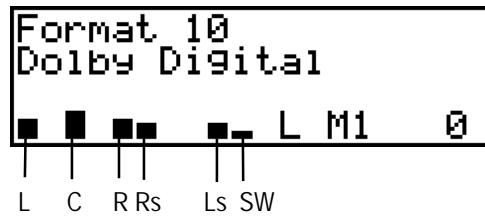


Figure 3-3 Front-Panel Display Showing a Dolby Digital Film Playing

Figure 3-3 shows the display when the CP650 is playing a Dolby Digital soundtrack with no Dolby Digital Surround EX decoder board installed. Since there are no Le, Re, Bsr or Bsl channels present in this configuration, no signal bars are indicated for those channels.

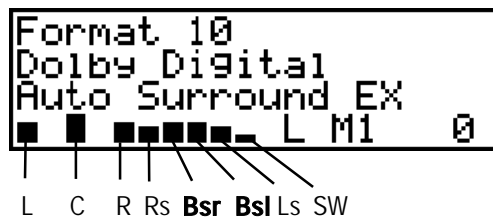


Figure 3-4 Front-Panel Display Showing Dolby Digital Surround EX Film Playing

Figure 3-4 shows the display when the CP650 is equipped with a Dolby Digital Surround EX decoder board, and playing a Dolby Digital Surround EX soundtrack. The additional Back Surround Left and Back Surround Right channels are present in this configuration.

The digital sound data from current films produced with the Dolby Digital Surround EX process contains auto-switching bits (Surround EX flags). A CP650 equipped with the Cat. No. 790 Surround EX Board detects these bits and automatically switches the CP650 to Surround EX decoding. If the flags indicate that the film is not a Surround EX film, or if the flag bits are not present, Surround EX mode is switched off. The Bsr and Bsl channels are automatically configured for either 5.1 mode or Surround EX mode.

Front-Panel Sound Format Display on Units with Earlier Software

The bar graph display on CP650s running software earlier than version 2.1.x.x (x can be any number) is slightly different:

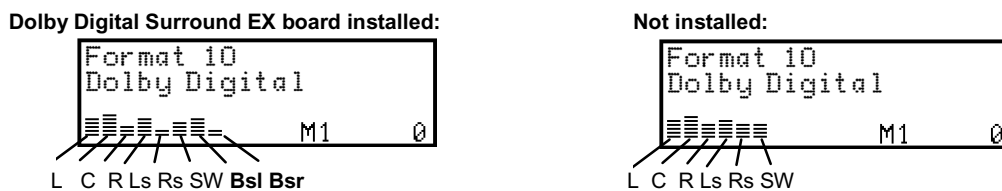


Figure 3-5 Front-Panel Display When Running Earlier Software

Level Display

The main fader level is displayed as a two-digit number. Starting from a display of 0.0, the level increases from -90 to -10 dB (display 4.0) as the fader knob is turned clockwise. The level then increases in smaller steps from -10 to $+10$ dB (display 10). As with previous generations of Dolby cinema processors, a fader setting of 7.0 (0 dB) is the nominal correct operating level. This setting matches the level used during production of the film.

Main Fader Knob

Use this knob to adjust the sound level. A fader reading of 7.0 is the nominal correct operating level. The main fader knob rotates continuously with no end-stops. The knob is also used for data selection during setup operations.

When the fader knob is rotated between readings 0 and 4.0, the output level changes in 20 dB steps between -90 and -10 dB. When the fader knob is rotated between readings 4.0 and 10, the output level changes in $3\frac{1}{3}$ dB steps between -10 dB and $+10$ dB.

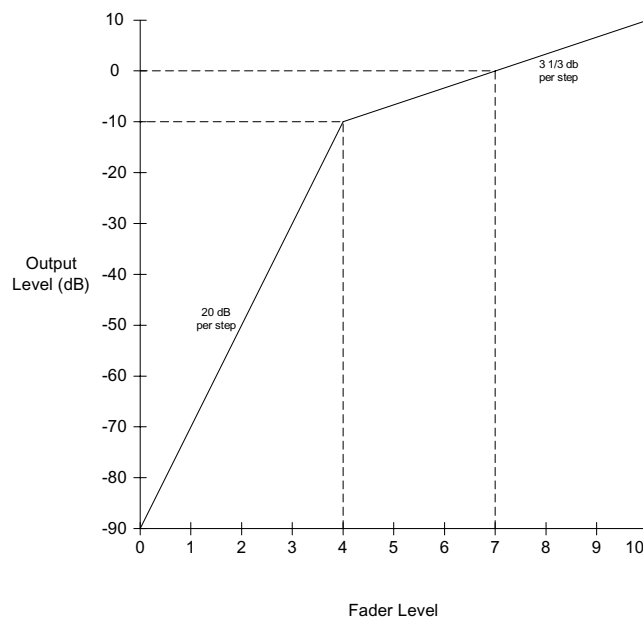


Figure 3-3 Fader Characteristic

Projector Signal Indicators

P1 and **P2** show which projector optical input has been selected.

Bypass Power Supply Failure Indicator

This indicator lights if a problem is detected in the bypass power supply circuitry.

Power Supply Button

This button operates the main power supply for the CP650. As with other Dolby cinema processors, the CP650 utilizes a separate backup (bypass) power supply. A red LED built into the switch is activated when the unit is powered from the bypass supply. While the main power supply is in use, this button is not illuminated, and the screen and other indicators operate normally. When this button is illuminated red, the unit is in bypass mode, either because bypass mode has been manually selected (by using the button) or because a fault has been automatically detected. In bypass mode, the unit is powered by the built-in bypass power supply.

Format Buttons

These buttons select the desired format. Pressing a format button during menu operations will return the display to the top-level menu.

Setup Control-Panel Access Door

For use by the service engineer, the access door is opened to expose the setup control panel.

Mute Button

Pressing the mute button fades the audio output to all channels without disturbing the current main fader setting. The speed of fade-in and fade-out is separately adjustable from 0.2 to 5 seconds using the front-panel menu buttons or PC setup software. The mute button flashes red when mute is activated.

Operation and Setup Menu Control Buttons

The menu control buttons are used by both the operator and the service engineer to navigate front-panel screen menus, select various menu options, and store setup data.

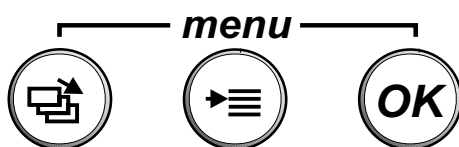


Figure 3-4 CP650 Operation and Setup Menu Control Buttons

The left-hand **next menu** button is used to step through the menu list. Pressing and releasing the button once will change the display to the next menu item. Pressing and holding the button while rotating the main fader knob will step the display through all menu items.

The center **adjust parameter** button is used to select a parameter to adjust when there are multiple items available on the display. Pressing and releasing the button will select among them. The adjustment is then made by rotating the main fader knob.

The right-hand **OK** button is used to accept the setting displayed on the front-panel screen and store it in CP650 memory. Any changes to settings will occur

immediately, but will not be saved until this button is pressed. Leaving the current menu before pressing the button will cause the change to be discarded.

Note: For convenience, pressing the illuminated format button once, or any other format button twice, causes the CP650 to immediately return to the menu top-level screen display. This feature is handy for making a quick change, then returning to normal operation. This feature is not active in setup mode (described below).

3.2 The Setup Control Panel

The setup control panel is located behind the front-panel access door.

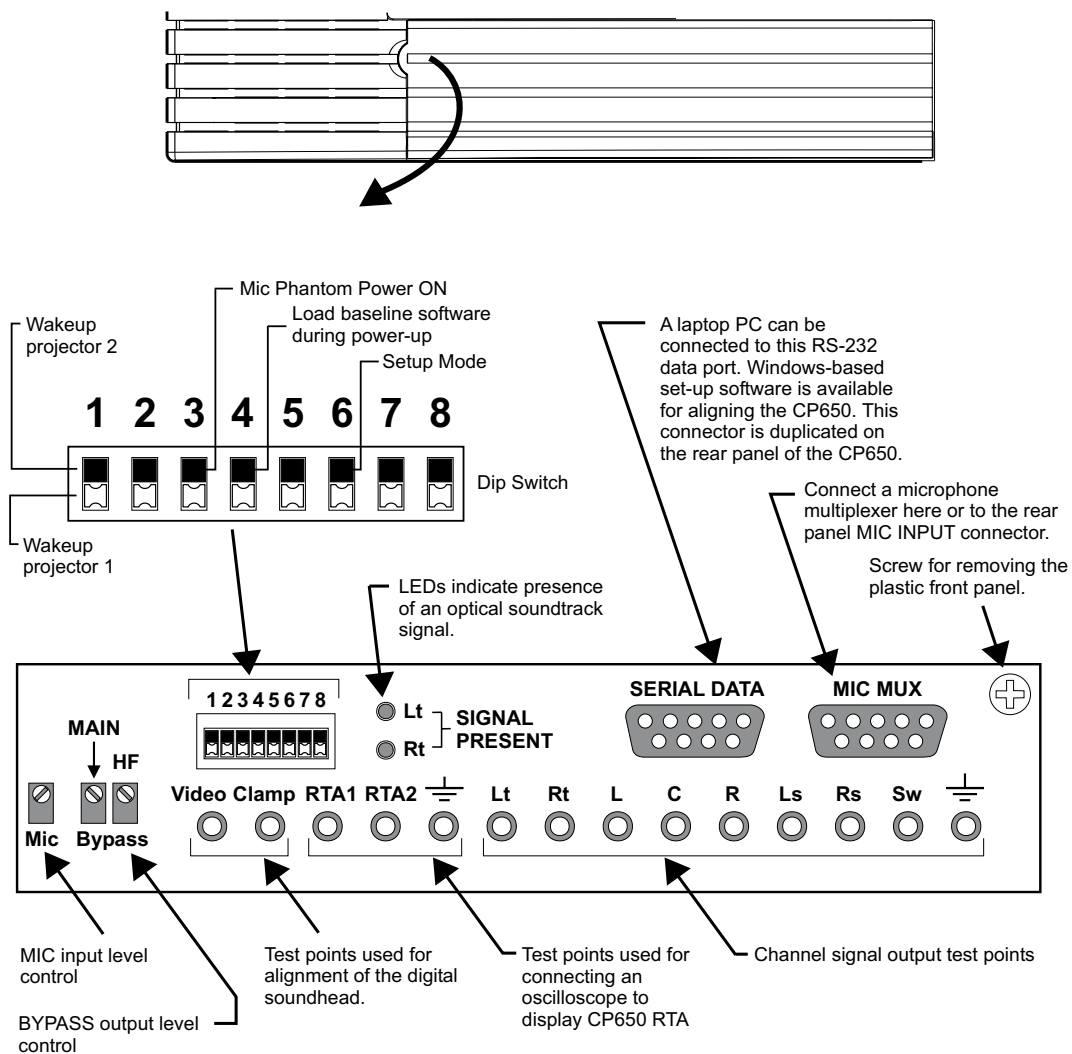


Figure 3-5 Setup Control Panel

Mic Input Level Control

This ten-turn potentiometer has an end-to-end range of 46 dB. It is shipped from the factory set to minimum.

Bypass Output Level Controls

These two potentiometers, located on the Cat. No. 772A card, set the CP650 output level when the unit switches to bypass operation. The HF control is used if the CP650 is equipped with a Cat. No. 791 Crossover Card. Earlier units used the Cat. No. 772 (non-A) card with a single potentiometer.

Setup DIP Switch

The eight-position DIP switch is used to set the functions shown. All switches are factory-set to down. Switches 2, 5, 7, and 8 are not used. DIP switch 6 is used to enter CP650 setup mode.

Lt/Rt Signal Presence LEDs

These LEDs indicate that signals exist on the Lt and Rt sound channels from the film's analog soundtrack. They flash during film playback in both normal and bypass operation.

Serial Communications Port (RS-232)

A laptop PC can be connected to this port using a straight-through (pin 1 to pin 1, pin 2 to pin 2, etc.) cable. A cable with receive and transmit lines swapped (null modem cable) will not work. Setup software is available for aligning the CP650. This connector is duplicated on the rear panel of the CP650.

***Caution:** The front- and rear-panel connectors are wired in parallel and should not be used simultaneously. Do not plug anything into the rear-panel connector if the front-panel connector is being used.*

MIC MUX Connector

When setting up a CP650, a microphone multiplexer can be plugged into this connector (or to the XLR connector on the rear panel for some types of units).

Test Points

These test points are provided to allow rapid access to the required signals used during CP650 setup. Each test point is a 2 mm diameter female socket that accepts a 2 mm male test pin. Test point pins can be obtained in the USA from ITT Pomona® Electronics. Type 3221 is a useful, stacking, pin-to-BNC female adapter.

3.3 Power Supply Voltage Test Points

Six test points are located behind the front-panel for measuring power supply voltages. They can be accessed by removing the front panel. See Section 9.3.1 for the voltage test ranges.

- Main power supply DC test points: +15 V, -15 V, +5 V
- Bypass (“B”) power supply DC test points: +14 V, -14 V, +5 V

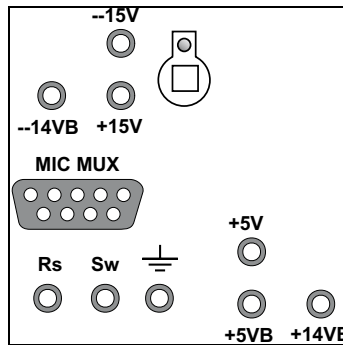


Figure 3–6 Power Supply Voltage Test Points

(A portion of the front subpanel, with front panel removed, is shown in this figure.)

3.4 Aligning the B-Chain and A-Chain

The B-chain is made up of system components from the main fader through to the loudspeakers. In the CP650, B-chain adjustments include speaker equalization, level settings, surround speaker delay settings, and mute fading time. If your CP650 is equipped with an optional Cat. No.791 Crossover Card, additional steps are required such as setting crossover points, filter types, and crossover slopes to select.

It is not practical for the entire cinema industry to standardize to a single make and model of loudspeaker. The different acoustical characteristics of individual theatres require individual speaker solutions. Therefore, electronic equalization of individual loudspeaker systems is used to achieve consistent results in a broad spectrum of environments, and with a broad range of speakers.

Accurate equalization requires the use of standardized acoustic measurement procedures.

The CP650’s built-in pink-noise generator provides a continuous random noise signal that covers the total bandwidth. This signal is used to measure and adjust the response of the loudspeakers. The use of random noise eliminates the problems inherent with the use of test tones (standing wave patterns in the theatres) and enables the frequency response of the entire system to be observed. Each channel can be measured and adjusted independent of the other channels.

A multi-microphone setup with multiplexer is placed in the auditorium to receive the pink noise reproduced by the loudspeaker. The output of the selected microphone is fed to a real-time analyzer (RTA) circuit built into the CP650 (or to your separate

RTA if you prefer.) Equalization can be performed by using an oscilloscope connected to the RTA output test points or by using a PC running Dolby setup software. Either display will represent the spectrum received by the microphones. The effect of adjustments to the equalizers is quickly and easily seen. The Auditorium Assist™ feature, available in system software version 2.0 and above, measures and saves the auditorium characteristics for future checking.

One of the problems inherent in equalization is the nature of the environment. In an open space, a perfect loudspeaker, radiating a perfectly flat pink-noise response in all directions, placed in front of a perfectly flat microphone, producing perfectly flat response to sounds arriving from all directions, will display a perfectly flat response on the RTA output. In an enclosed space such as a theatre, the results are different. When the pink-noise generator is first turned on, all of the sound that initially reaches the microphone comes directly from the loudspeaker, and the response is flat—for a few milliseconds. Then, reflected sound from the walls, ceiling, floor, seats, and so on arrives at the microphone, together with the direct sound from the loudspeaker. This indirect, or reflected, sound reinforces the direct sound. The system soon settles into an equilibrium condition. As much energy is being absorbed by the walls, ceiling, and seats as is fed into the room. Since high- and mid-frequency energy is absorbed when sound is reflected, the displayed response appears to have a falling treble characteristic. At first glance, boosting the high frequencies may appear to be the logical solution to achieve a flat steady-state response, but such an arrangement works only on sustained sounds. Dialogue contains short, impulsive sounds that will yield a much-too-bright result because there is no time for reverberation to build and add to the original sound. A standard response curve is required that favors such impulsive “first arrival” sound and implies the same gently falling response that is observed when the output of an ideal loudspeaker is measured with a perfect microphone in the theatre.

The amount of reverberation varies with frequency. As frequency rises, more audio is absorbed rather than being reflected. A typical reverberation curve in a theatre rolls off at about 3 dB per octave above 2 kHz. This characteristic is used to define the standard steady-state response curve for all dubbing theatres in which films with Dolby soundtracks are mixed and for all Dolby processor-equipped cinemas.

The size of the theatre affects the reverberation time, and therefore the measurement of frequency response. After alignment to this standard curve, some slight adjustment of high-frequency slope may be necessary for extremely large or small theatres. The Bulk EQ Treble Adj. menu selection can be used to reduce the output by approximately 1 dB at 8 kHz for very a large theatre; or to increase the output 1 dB at 8 kHz for a very small theatre. Any such adjustment should be based on an evaluation, by ear, of actual known films rather than as a rule of thumb.

Some loudspeakers used in theatres are far from ideal and require boosting of the low- and high-frequency extremes in order to produce an approximation of the standard reference response curve. Bass and treble controls centered on the turnover points of typical loudspeakers lift the ends of the spectrum without the need for large amounts of narrow-band boost from the third-octave EQ circuitry.

The final factor is masking of the screen. The masking curtains must be drawn back sufficiently to clear the left and right screen speakers before any adjustments or measurements are made. The high-frequency horns should clear the screen frame and be mounted as close as possible to the screen. Conventional black felt side-masking can severely restrict high-frequency response. Consequently, there would be severe losses if the left and right loudspeakers were equalized with the masking set for a 2.35:1 film, and then the masking were brought in for a 1.85:1 film, thus obscuring the outer speakers. To avoid this problem, some theatres have installed acoustically transparent masking cloth, and others leave the masking open whenever they are showing a 1.85:1 film with a stereo soundtrack. Moving the speakers towards the center of the screen to clear heavy masking is not a good solution, since the stereo separation would be degraded.

Repainted screens cannot be used for quality sound playback, because the perforations, which allow the high frequencies through the screen, can become clogged with paint.

Chapter 4

B-Chain Alignment

4.1 Check Theatre Equipment

Thoroughly check the loudspeakers and power amplifiers for any sources of poor performance, using the suggested checklists below as a guide.

Speakers

- Loudspeaker cables—Check that they are in good condition and that they are the correct gauge for the impedance of the speakers and the length of the run.
- Speaker wiring—Check that the speakers are connected to the correct power amp channel.
- Rattles—A leak in the low-frequency driver cabinet may sound like a rattle.
- Also check for loose bolts or other hardware.
- Open drivers—In systems with pairs of drivers, one voice coil of the pair may be open but the system will still function. Check the speakers with an ohm meter. If one channel requires markedly more equalization than the other, or if one speaker overloads at lower levels than the other speakers, an open driver circuit could be the cause.
- Check for missing drivers or other components.
- Crossover settings matching the type of drivers in use and the acoustics of the theatre—The high-frequency driver level control must be set for the best possible frequency response before you attempt any equalization. This is especially true if the system uses active crossovers with bi-amp equipment. If your CP650 is equipped with a Cat. No. 791 Crossover Board, please refer to Section 4.4 for information on settings.
- Check for proper polarity between the low- and high-frequency drivers, and between the channels.
- Aiming of speakers—Ensure that the speakers are correctly aimed into the auditorium, and that they are not obstructed by the screen frame, struts, or other obstructions.

Amplifiers

- Check for distortion.
- Gross gain differences among amplifiers—If one amplifier differs in performance from the others, it should be checked and repaired if necessary, before proceeding further. Input gain controls should all be at the same setting.
- Check for blown fuses.

- Ensure that there is good air movement through power amplifiers.

Air-Conditioning

If air-conditioning noise is audible in the theatre, arrange for lubrication of the motor and fan bearings, adjustment of belts and drives, and cleaning of filters to reduce the ambient noise to a minimum.

4.2 Microphone Placement

Position a microphone multiplexer in the center of the listening area. Place each microphone in the auditorium so that each is substantially in the reverberant field rather than in an area that receives the most direct energy from the speakers. In addition, avoid perfect symmetry. Arrange the microphones so that they are not arranged in a perfect square or rectangle parallel to the sides of the room. Take care not to place any of the microphones (except mic number 1) on the central axis of the room. Standing waves and nodes at these positions can cause measurement errors. Microphone number 1 should be placed two-thirds of the distance from the front speakers to the rear, at the exact side-to-side center of the room, approximately five feet above the floor level, and rotated 45 degrees upward towards the screen. Placement of this microphone is important for output level adjustments.

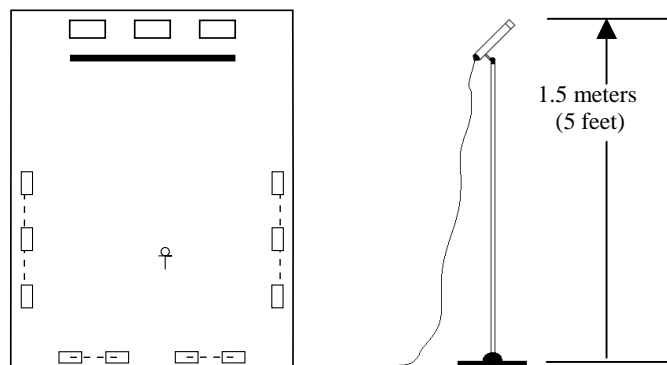
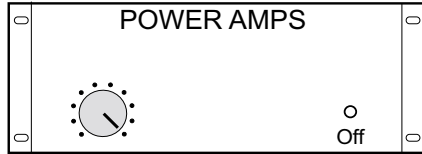


Figure 4–1 EQ Microphone Placement

If a single microphone is used (NOT advised), the recommended position would be two-thirds of the way from the front speakers to the rear, off the axis of the center speaker, five feet above the floor level, and rotated 45 degrees upward towards the screen.

Route the output cable to the CP650 and connect it to the microphone connector on the rear panel or front setup panel (XLR on the rear panel or nine-pin D-connector “MIC MUX” input on front setup panel). The mic input connectors are wired in parallel. Phantom power is optionally provided to both mic connectors by moving DIP switch 3 to the up position.

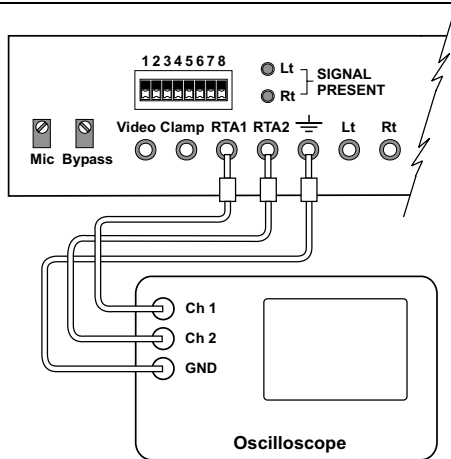
4.3 Initial Setup



Set all the gain controls on all power amplifiers to a known, repeatable setting. **The preferred setting for most amplifier gain controls is maximum.**

If a different setting is required in order to optimize the noise performance of the system, the controls should be locked in position or marked clearly.

Caution: The following steps will cause the CP650 to output pink noise to the power amplifiers. The CP650 output levels may be set too high. If you are unsure of the settings on your unit, turn off the power amplifiers before selecting the “Calibrate SPL” menu item shown in Section 4.4 below. Then, select and observe the present output level adjustment settings. (Press left menu button two times while the unit is in setup mode.)

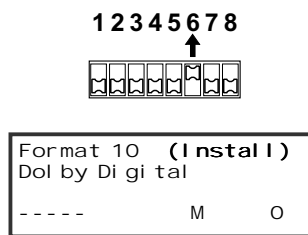


Connect an oscilloscope to the following test points located on the setup panel:

- RTA1**-to-scope channel 1
- RTA2**-to-scope channel 2

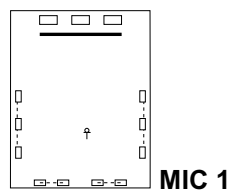
Set the oscilloscope to display both channels. Use the “chop” mode instead of “alt” mode for the best display results.

Apply power to the CP650.



Slide DIP switch-6 to the up position. This switches the CP650 into setup mode.

“(Install)” appears on the display screen.



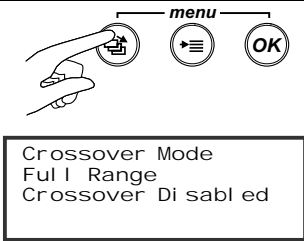
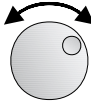
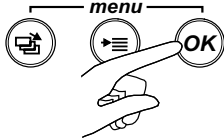
If a microphone multiplexer is being used, select MIC 1.

4.4 SPL (Sound Pressure Level) Calibration

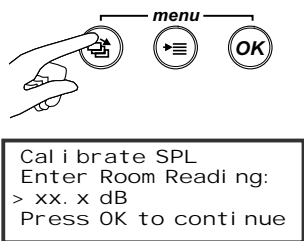
If your CP650 is equipped with a Cat. No. 791 Crossover Board, an initial setup is required before you begin the SPL calibration. If you do not have a Cat. No. 791 installed, skip to Section 4.4.2.

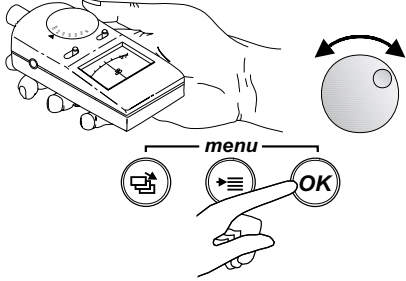
4.4.1 Initial Setup (CP650s with Cat. No. 791 Crossover)

SPL calibration of CP650s equipped with a Cat. No. 791 Crossover Board is performed with the crossover set to “Full Range” mode. Pink noise is applied only to the CP650 low-frequency (LF) main outputs and these outputs are switched to full-frequency operation for calibrating the CP650 to the room sound pressure level.

	<p>Press the left menu button four times to display the Crossover Mode screen.</p> <p>One of three crossover configuration choices is displayed on the second line: Full Range, 2-Way, or 3-Way.</p>
	<p>Rotate the front-panel knob until Full Range is displayed.</p>
	<p>Press OK to save this setting.</p>

4.4.2 Calibration Procedure (All CP650s)

	<p>Press the left menu button twice to move the display to the Calibrate SPL menu item.</p> <p>Pink noise is sent to the center channel speaker.</p> <hr/> <p>Note: If pink noise is not being generated, this indicates that the status of the digital input has changed. If you are using the digital input on the CP650, either disconnect or power down the device attached the digital input during calibration. A change in the digital input bitstream will cause the CP650 to mute the pink noise.</p>
---	--

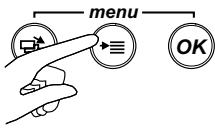
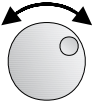
	<p>The scope should now be receiving sync signals from the CP650. Set the scope vertical inputs to 100 mV/div. Set the horizontal sweep rate to 1 ms/div. Temporarily switch the inputs to GND and move the vertical position of each trace to line up with the bottom screen graticule line. Do not move the vertical positions after completing this step. Switch the inputs to DC and adjust the sync to trigger on the waveform. Adjust the scope horizontal position offset such that each displayed burst appears on the left and right-hand sides of the screen. If necessary, adjust the Mic input-level pot until the center area of the displayed pink noise moves to the middle of the scope screen.</p>
 <div data-bbox="395 1086 699 1187" style="border: 1px solid black; padding: 5px; width: fit-content; margin: 10px auto;"> <p>Please Wait . . . Calibrating . . .</p> </div>	<p>With a sound pressure level meter, measure the noise level in the room. Rotate the front-panel knob until the room reading is shown on the front-panel screen.</p> <hr/> <p>Note: Hold the sound pressure level meter near the location of mic 1. The adjustment range is from 45 to 108.5 dB in 0.5 dB steps.</p> <hr/> <p>Press the OK button.</p> <p>Wait while the system automatically calibrates to the room reading.</p> <hr/> <p>Note: The calibration is retained in CP650 memory and can be used in future alignments. However, it is advisable to recalibrate the system when re-arranging microphones because the sound pressure level will vary slightly with microphone placement.</p>
<div data-bbox="402 1321 705 1422" style="border: 1px solid black; padding: 5px; width: fit-content; margin: 10px auto;"> <p>Mic Level Too Low or Too High Proceeding Uncalibrated</p> </div> <p>The CP650 is shipped from the factory with the Mic input-level control set to minimum.</p>	<hr/> <p>Note: The spectrum analyzer, built into the CP650, has automatic level control covering a range of mic input levels. However, if you see an error message reporting mic level too low or too high:</p> <p>The microphone(s) may require phantom power. Move DIP switch 3 up, press and hold the left menu button, and rotate the main fader counterclockwise one step back to the Calibrate SPL Menu, and repeat the above steps.</p> <p>OR</p> <p>While watching the oscilloscope RTA display, adjust the Mic gain control to place the flat part of the signal in the approximate center of the screen. The trimpot is accessible through an opening in the setup panel. Then press / hold the left menu button, and rotate the main fader counterclockwise one step back to the Calibrate SPL menu, and repeat the above steps.</p>

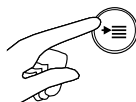

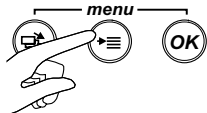

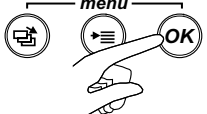
4.5 Initial Output-Level Calibration

Each of the channels should now be adjusted to give a reasonable sound pressure level in the room. It is not necessary to get exact readings at this point because the levels will change slightly during equalization of the room. Exact output level adjustment will be performed after equalization.

Note: If pink noise is not being generated, this indicates that the status of the digital input has changed. If you are using the digital input on the CP650, either disconnect or power down the device attached the digital input during calibration. A change in the digital input bitstream will cause the CP650 to mute the pink noise.

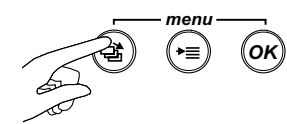
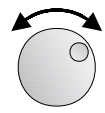

4.5.1 Main Channels

<pre>Output Level s >Channel : Center Level : xx Room Level xx. x dB</pre>	<p>After auto-calibration, the Output Levels adjust screen appears with Center Channel active.</p>
 <pre>Output Level s Channel : Center >Level : xx Room Level xx. x dB</pre>	<p>Note: The RTA oscilloscope display is not active on this menu.</p>
 <pre>Adjust Output Level Channel : Center > Level : xx Room Level 85.0 dB</pre>	<p>Press the center menu button, moving the cursor down one line to Level:</p>
	<p>Note: The Level: line on the display shows a relative number. The number has no units.</p>
	<p>Rotate the main fader knob to change the CP650 pink-noise output signal level into the auditorium while watching the measured Room Level shown on the bottom line of the display. Set it to 85 dB.</p>
	<p>Note: If the room level does not appear, the calibration step may have failed or was not performed. Repeat Section 4.4.</p>

 <div data-bbox="486 268 782 369" style="border: 1px solid black; padding: 5px;"> <p>Output Levels >Channel : Center Level : xx Room Level xx. x dB</p> </div>  <div data-bbox="486 425 782 526" style="border: 1px solid black; padding: 5px;"> <p>Adjust Output Level >Channel : Left Level : xx Room Level xx. x dB</p> </div>   <div data-bbox="478 705 774 817" style="border: 1px solid black; padding: 5px;"> <p>Adjust Output Level Channel : Left >Level : xx Room Level 85.0 dB</p> </div>	<p>Press the center menu button once to move the cursor back up to the Channel: selection.</p> <p>Rotate the main fader knob counterclockwise to change the Channel selection to Channel: Left.</p> <p>Press the center menu button, moving the cursor down one line to Level:</p> <p>Rotate the main fader knob to set the room level to 85 dB.</p>
<p style="text-align: center;">Right = 85 dB</p>	<p>Repeat this process for the Right screen channel.</p>
<p style="text-align: center;">Ls and Rs = 82 dB or Ls, Bsl, Bsr, Rs = 82 dB</p>	<p>Repeat this process setting the Ls and Rs channels (Ls, Bsl, Bsr, and Rs channels if your unit is equipped with Dolby Digital Surround EX) to 82 dB.</p>
 <div data-bbox="414 1243 718 1344" style="border: 1px solid black; padding: 5px;"> <p>Saving Changes.</p> </div>	<p>When all channels have been adjusted, press the right-hand OK button.</p> <p>“Saving Changes” appears on the front-panel screen.</p> <p><i>Caution: If any other button is pressed, all of the settings will be lost!</i></p>

4.5.2 Subwoofer Channel

The initial subwoofer level adjustment uses a displayed RTA reference line, established from the center channel pink-noise level. The subwoofer level is adjusted to match the displayed reference line. Final subwoofer level adjustments for both digital and optical signal paths are carried out later, after the room is equalized.

 <div data-bbox="414 689 718 795" style="border: 1px solid black; padding: 5px;"> <p>Di gi tal Subwoofer >Level : xx Pol ari ty: Normal Center Noi se: Off</p> </div>	<p>Switch the microphone multiplexer to cycle. Press the left menu button once to move the display one menu step. The Digital Subwoofer channel adjust menu appears next. Scope channel 2 displays a reference line.</p> <hr/> <p>Note: The RTA oscilloscope display is active on this menu.</p>
<div data-bbox="414 846 726 952" style="border: 1px solid black; padding: 5px;"> <p>Di gi tal Subwoofer >Level : xx Pol ari ty: Normal Center Noi se: Off</p> </div> 	<p>Pink noise is now present on the subwoofer channel only (100 Hz bandwidth). Using the front-panel knob, adjust the subwoofer channel level by moving the average subwoofer RTA display to the reference line displayed on the scope.</p>
 <div data-bbox="486 1137 790 1243" style="border: 1px solid black; padding: 5px;"> <p>Savi ng Changes.</p> </div>	<p>Press the right-hand OK button to save the level setting.</p>

4.6 Crossover Setup (CP650 with Cat. No. 791)

If your CP650 is **not** equipped with a Cat. No. 791 Crossover Board, please skip this section.

Two jumpers, located on the Cat. No. 772A board, must be set to “yes” when a Cat. No. 791 Crossover Card is installed. CP650s shipped with a Cat. No. 791 board have the correct jumper setting. See Section 9.3.2 for instructions on gaining access to the jumpers.

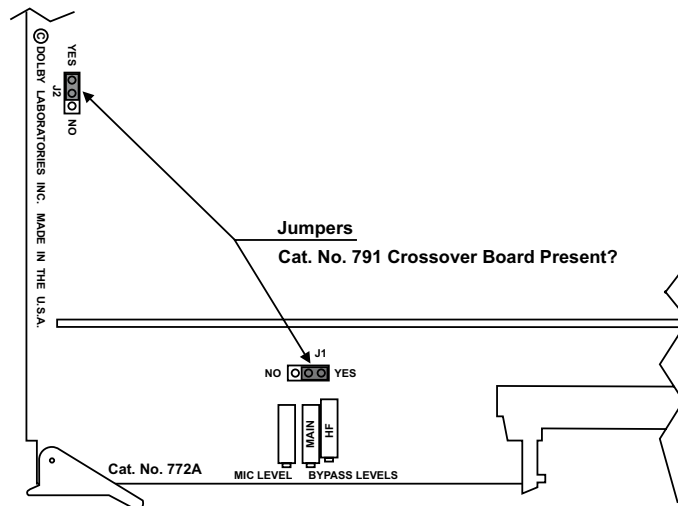


Figure 4–2 Cat. No. 772A Board Jumpers for Cat. No. 791 Crossover

The Cat. No. 791 Crossover Card contains a circuit in each high-frequency output channel (Left high, Right high, and Center high) to boost high frequencies. This allows the outputs to overcome the loss caused by placing the high-frequency drivers behind a perforated theatre screen. The circuit adds a maximum of 8 dB boost starting at approximately 6 kHz. This boost, combined with the bulk treble and equalization adjustments, provides enough high-frequency gain to suit most applications.

Since not all applications require this boost, jumpers are provided on the card to enable or disable it. The jumpers are set to **disable** at the factory. See Section 9.3.2 for instructions on gaining access to the jumpers.

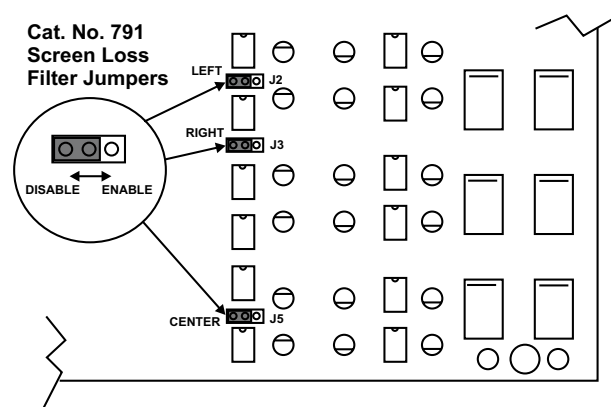
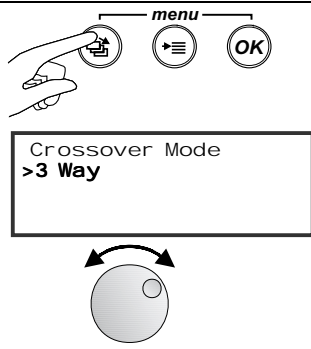



Figure 4–3 Cat. No. 791 Board Jumpers for Screen Loss HF Boost

The following parameters must be set before adjusting the room equalization in your auditorium:

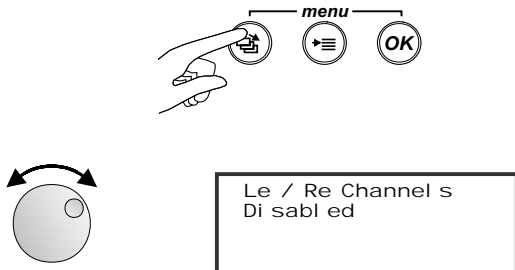
- Crossover Mode (2-Way or 3-Way)
- Left Extra (Le) and Right Extra (Re) screen channel support (available only in 2-Way and Full Range crossover modes)
- Filter type used at each crossover point (Linkwitz-Riley or Butterworth)
- Filter corner frequency at each crossover point
- Filter slope (Butterworth filter type only)
- Delay
- Polarity inversion to check for speaker wiring connections

Crossover Mode

	<p>Press the left menu button multiple times to move to the Crossover Mode menu.</p> <p>Rotate the front-panel knob to select the crossover mode desired: 2-Way or 3-Way.</p> <p>Note: Selecting Full Range mode disables the crossover outputs and switches the main channel outputs to full bandwidth for calibrating the SPL in the auditorium (see Section 4.4.1).</p>
	<p>Press the OK button to save your selection.</p>

Le/Re Screen Channel Support

If your application calls for Le and Re support, the crossover must be operated in 2-Way or Full Range mode. In this case, the Le and Re outputs are full bandwidth. If these channels also require a crossover, you must use external units.

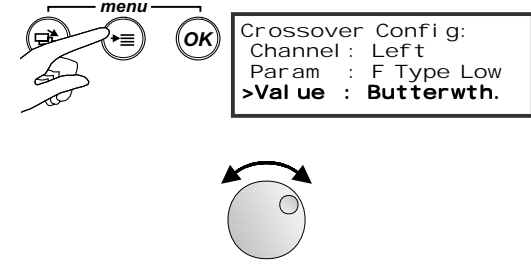
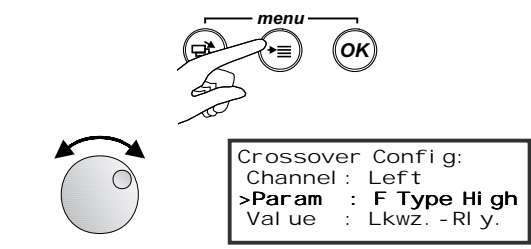
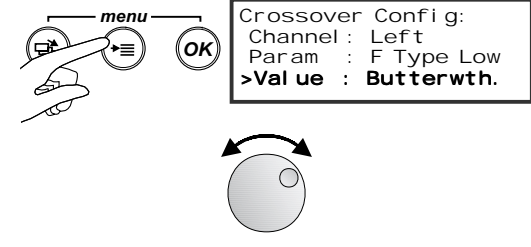
	<p>Press the left menu button once to display the Le/Re Channels screen.</p> <p>Rotate the front-panel knob to enable or disable Le/Re support.</p> <p>Note: Le/Re screen channel support is available in 2-Way and Full Range mode only.</p>
---	---

Selecting Butterworth Filter Type

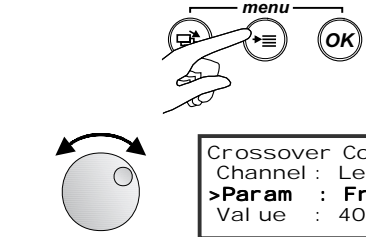
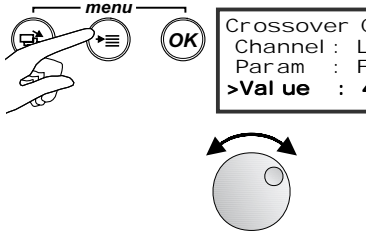
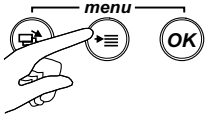
The crossover filters designed into the Cat. No. 791 are adjustable to allow tailoring of the response to your particular system. For most applications, the crossover filter type should be set to Linkwitz-Riley. The slopes in this filter are not adjustable. The filter has two cascaded two-pole Butterworth filters for the lowpass side, and a 3-pole filter for the high-pass side at the crossover point. The corner frequency for each crossover point is adjustable.

To customize the filter slopes, change the crossover filter type to Butterworth by following the steps below.

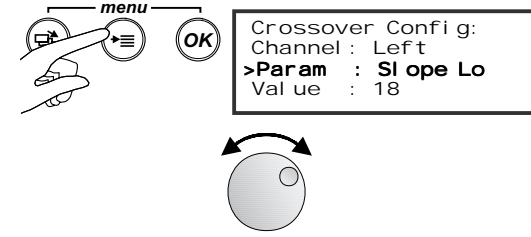
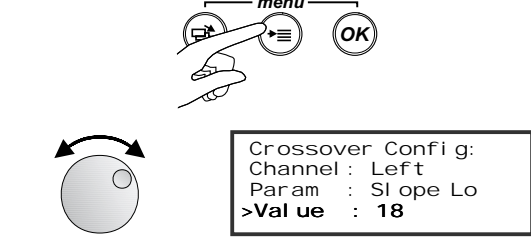
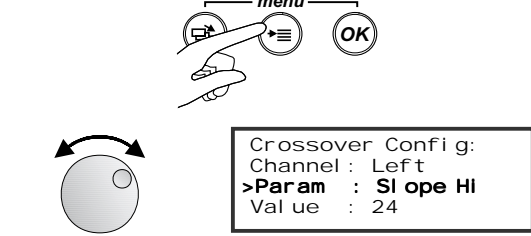
	<p>Move the display to the Crossover Configuration menu, by pressing the left menu button multiple times, or by pressing and holding the button while rotating the front-panel knob.</p> <p>Rotate the front-panel knob to select the channel that you wish to set up.</p>
<p>Select: Filter Type, Freq, Slope, Delay, Polarity Inversion</p>	<p>Press the center menu button to move the selection arrow to Parameter. This allows you to select which parameter you wish to set.</p> <p>Rotate the front-panel knob to select the filter type (F Type.) The default filter type is Linkwitz-Riley. If you wish to change the crossover filter slope to customize your application, the type must be changed to Butterworth by following the next steps.</p>

 <p>Crossover Config: Channel : Left Param : F Type Low >Value : Butterwth.</p>	<p>If you configured the crossover mode as 2-Way, there is one crossover point for setting the filter type. Press the center menu button to move the arrow to Value.</p> <p>Rotate the front-panel knob to select the Butterworth filter type</p>
 <p>Crossover Config: Channel : Left >Param : F Type High Value : Lkwz. -RI y.</p>	<p>If you configured the crossover mode as 3-Way, set the filter type for the high-frequency crossover point:</p> <p>For a 3-Way crossover, press the center menu button to move the arrow to the Parameter selection, and rotate the front-panel knob to select High for the mid-to-high crossover filter type.</p>
 <p>Crossover Config: Channel : Left Param : F Type Low >Value : Butterwth.</p>	<p>Select the type of filter that you wish to use for the high-frequency crossover by pressing the center button to select Value.</p> <p>Rotate the front-panel knob to select the Butterworth filter type.</p>

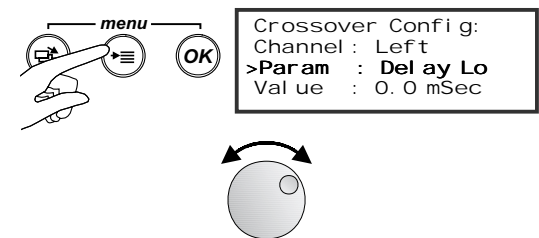
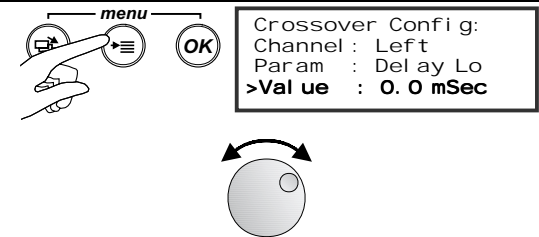
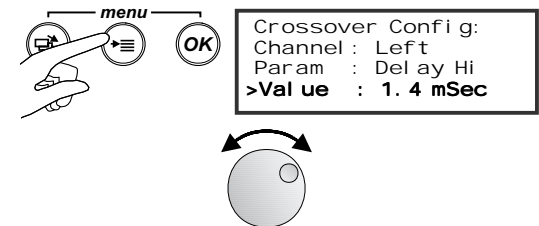
Setting Corner Frequency

 <div data-bbox="534 448 837 548" style="border: 1px solid black; padding: 5px;"> <p>Crossover Config: Channel : Left >Param : Freq Lo Value : 400</p> </div>	<p>Press the center menu button to move the arrow to the Parameter selection.</p> <p>Rotate the front-panel knob to select the lowpass filter corner frequency parameter (Freq Lo).</p>
 <div data-bbox="550 593 853 694" style="border: 1px solid black; padding: 5px;"> <p>Crossover Config: Channel : Left Param : Freq Lo >Value : 400</p> </div>	<p>Press the center menu button to move the arrow to the Value selection.</p> <p>Rotate the front-panel knob to select the desired corner frequency.</p>
 <div data-bbox="454 1019 766 1131" style="border: 1px solid black; padding: 5px;"> <p>Crossover Config: Channel : Left Param : Freq Hi >Value : 1200</p> </div>	<p>Press the center menu button two times to move the arrow back to the crossover Parameter selection.</p> <p>If you configured the crossover mode as 2-Way, repeat the steps above to set the highpass corner frequency (Freq Hi).</p> <p>If you configured the crossover mode as 3-Way, repeat the step above to set the mid-to-low (Freq M Lo), mid-to-high (Freq M Hi), and highpass frequencies (Freq Hi).</p>

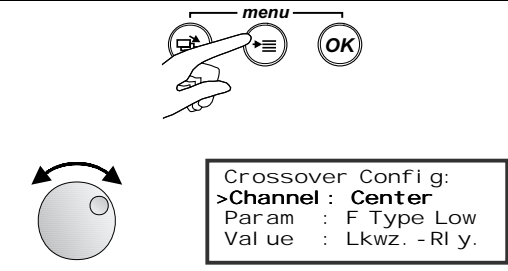
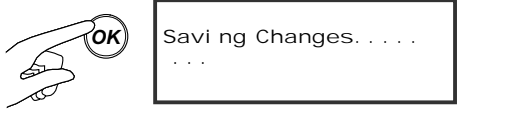
Setting Butterworth Filter Slope

	<p>If you selected Butterworth for the crossover filter type, press the center menu button twice to move the arrow to the Parameter selection.</p> <p>Rotate the front-panel knob to select the low- frequency slope (Slope Lo).</p>
	<p>Press the center menu button to move the arrow to the Value selection.</p> <p>Rotate the front-panel knob to set the desired slope value.</p>
	<p>Repeat the above steps to adjust the high frequency slope (2-Way), or the mid-to-low, mid-to-high, and high-frequency slopes (3-Way).</p>

Setting Delay

	<p>The delay settings must be adjusted to compensate for different physical mounting positions of the speaker drivers.</p> <p>Press the center menu button twice to move the arrow to the Parameter selection.</p> <p>Rotate the front-panel knob to select the low-frequency output delay (Delay Lo).</p>
	<p>Press the center menu button to move the arrow to the Value selection.</p> <p>Rotate the front-panel knob to adjust the output delay, in milliseconds, for the low-frequency output.</p>
	<p>Repeat the steps above to adjust the high-frequency delay (2-Way), or mid-frequency and high-frequency delay (3-Way).</p>

Next Channel

	<p>After all parameters have been set for this channel, press the center menu button to move the arrow to the channel selection, and rotate the front-panel knob to select the next screen channel to be adjusted. This example shows the center channel selected.</p> <p>Repeat the steps above to set the crossover parameters for that channel.</p>
	<p>When all crossover parameters have been set, press the OK button to save all settings.</p>

4.7 Room Equalization

Room equalization is performed using the real-time analyzer (RTA) circuit built into the CP650 along with an oscilloscope for RTA display. The adjustments for all output channels involves two steps: coarse, or “bulk,” adjustment using bass and treble controls, and fine adjustment, using a 27-band equalizer. Subwoofer channel equalization involves setting the frequency, “Q,” and level of “cut,” using a single-band parametric equalizer circuit.

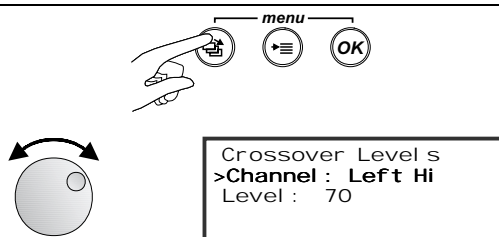
If your CP650 is equipped with an optional Cat. No. 791 Crossover Board, there are additional steps to perform before setting room equalization. See Section 4.7.1 below.

The RTA screen on the scope displays a standard (ISO 2969) response curve. The ideal setting is reached when the room response readings fall on (or very close to) this standard curve.

Note: If pink noise is not being generated, this indicates that the status of the digital input has changed. If you are using the digital input on the CP650, either disconnect or power down the device attached the digital input during equalization. A change in the digital input bitstream will cause the CP650 to mute the pink noise.

4.7.1 Crossover Level Adjustment (for CP650s with Cat. No. 791)

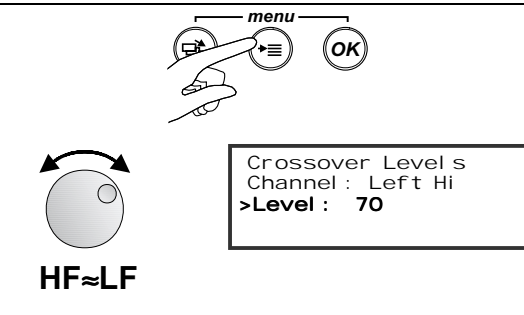
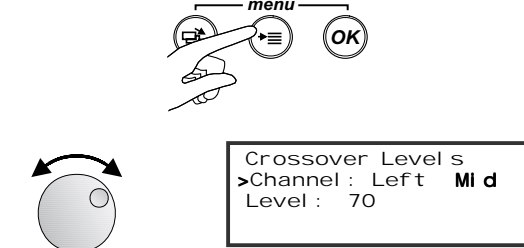
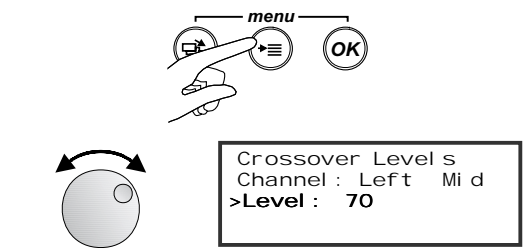
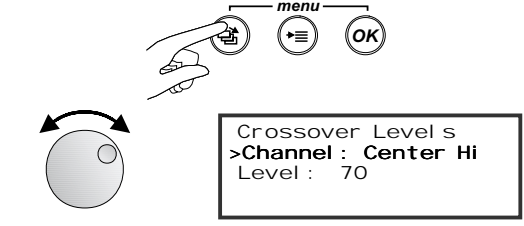
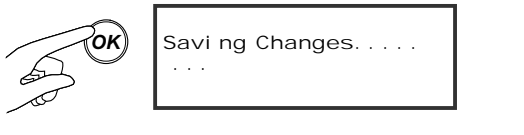
If your CP650 is equipped with a Cat. No. 791 Crossover Board, perform the steps below before adjusting the bulk treble and bass settings in the next section. In order to properly set the levels of the various bands (low and high for 2-Way, or low, mid, and high for 3-Way systems), you must first adjust the levels of all bands to be approximately equal. By performing this adjustment first, the final amount of equalization required to match the standard response curve will be less.



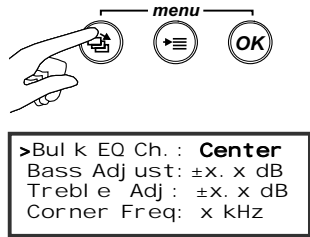
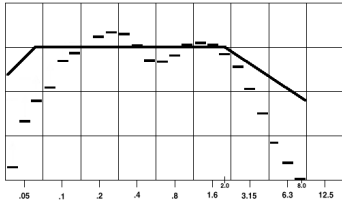
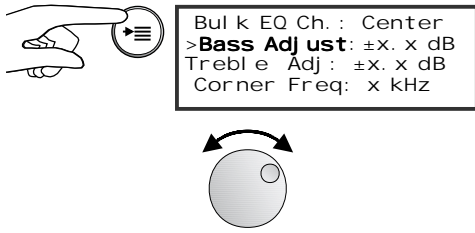
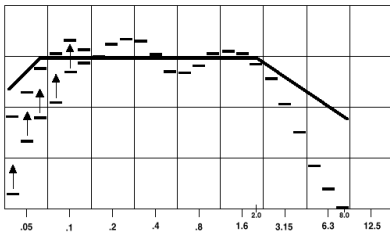
From the main format screen, press the left menu button multiple times to display the **Crossover Levels** screen.

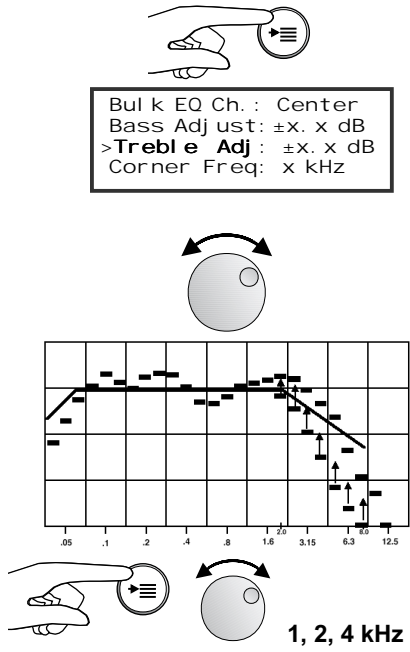
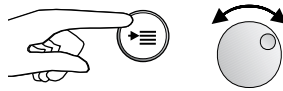
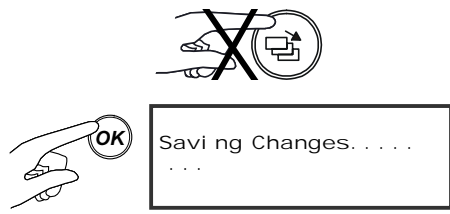
Rotate the front-panel knob to select the **Left channel high-frequency** output.

Note: With the crossover mode set to 2-Way or 3-Way, each output (low, mid, and high) will affect the RTA display in the band set by the crossover corner frequency settings. Each crossover output level (mid and high) should be adjusted separately from the main level control in order to match the low-frequency output level.

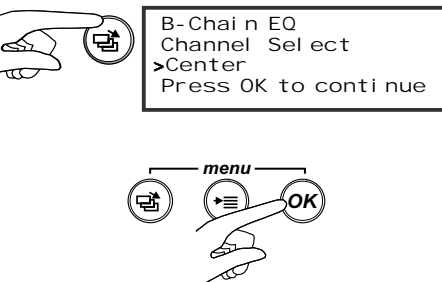
	<p>Press the middle menu button to move the arrow to the Level selection.</p> <p>While observing the RTA display on the oscilloscope, rotate the front-panel knob until the high-frequency bands are at the same approximate level as the low-frequency bands.</p>
 	<p>If you configured the crossover mode as 3-Way, press the center menu button to move the arrow to the channel selection.</p> <p>Rotate the front-panel knob to select the Left channel mid-frequency output.</p> <p>While observing the RTA display on the oscilloscope, rotate the front-panel knob until the mid-frequency bands are at the same approximate level as the low-frequency bands.</p>
	<p>Press the center menu button to move the arrow to the channel selection, and repeat the above procedure for the remaining channels.</p>
	<p>When all of the crossover level adjustments have been set, press the OK menu button to save your settings.</p>

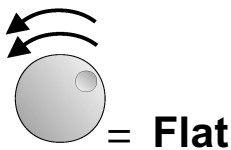
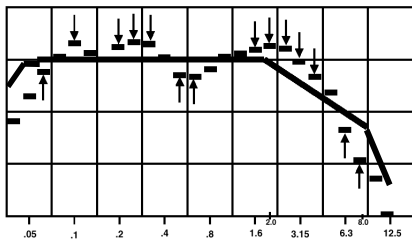
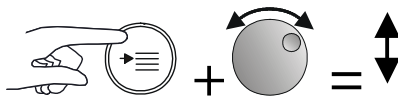
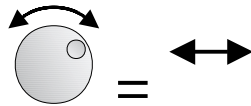
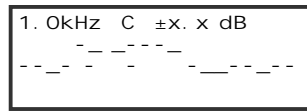
4.7.2 Setting Coarse (Bulk) EQ

	<p>Press Left menu button.</p> <p>The Bulk EQ menu appears with Center channel selected.</p> <p>Pink noise will appear at the center channel speaker.</p>
	<p>The standard response curve should appear over the average of the displayed mid-frequency peaks. If this is not the case, the scope setup step may have been performed incorrectly. See Section 4.3, first step.</p>
 	<p>Press the center menu button to move cursor down to Bass Adjust:</p> <p>Slowly move the front-panel knob to adjust the low-frequency response as close as possible to the reference line displayed on the RTA.</p>

 <p>Bulk EQ Ch.: Center Bass Adjust: ±x. x dB >Treble Adj: ±x. x dB Corner Freq: x kHz</p> <p>1, 2, 4 kHz</p>	<p>Press the center menu button to move cursor down to Treble Adjust:</p> <p>Slowly move the front-panel knob to adjust the high-frequency response as close as possible to the reference line displayed on the RTA.</p> <p>If a satisfactory response is not obtained, try changing the corner frequency. Pressing the center menu button again moves the cursor to Corner frequency. The frequency selections are 1, 2, 3, or 4 kHz, and are set by rotating the front-panel knob.</p>
 <p>L, R, and Ls, Rs or L, R, Ls, Bsl, Bsr, Rs</p>	<p>Adjust each of the remaining full-range channels by using the center menu button to move the cursor to Bulk EQ Ch.:, and front-panel knob to select the desired channel.</p> <p>Note: Bulk equalization facilities for the surround channels are slightly different than for the screen channels. The corner frequency is fixed at 2 kHz and is not changeable. There is also a 3 dB level shift to the standard response curve displayed on the scope.</p>
 <p>Saving Changes.</p>	<p>Caution: Do not press the left menu change button. All settings would be lost!</p> <p>Press the right-hand OK button to save all bulk EQ settings.</p>

4.7.3 Setting Fine EQ (1/3 Octave)

 <p>B-Chain EQ Channel Select >Center Press OK to continue</p>	<p>Press the left menu button once to move to the B-Chain EQ menu. The software enters this menu with Center channel selected.</p> <p>Press the OK button to begin final EQ on this channel.</p>
--	--



Discarding Changes. . .

The 27-band RTA now displays on the oscilloscope.

1 kHz is the default start frequency band selected. A small marker on the scope trace shows the frequency band selected. Turn the front-panel knob (with no button pressed) to select the active band. The CP650 screen cursor (line) blinks to indicate which band is active.

When the front-panel knob is rotated to select frequencies at the far left (or right) side of the LCD screen, the displayed bands will “scroll” left or right to show the low- or high-frequency bands.

Press **and hold** the middle menu button while moving the front-panel knob to adjust the level of the selected band. Perform fine adjustment of each band adjusting the response to be as close as possible to the standard curve displayed on the scope.

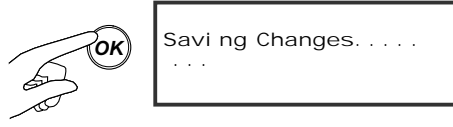

All of the equalizer bands interact with each other. You should not start at the low-frequency end of the response curve and merely work your way to the high-frequency end. As each band is adjusted, the response of adjacent bands is affected. Start at the center frequencies. The desired curve is a flat frequency response up to 2 kHz, falling at 3 dB per octave to 8 kHz (1 dB per third-octave band). If modern woofer systems (vented-box direct radiator enclosures) are installed in the theatre, moderate bass equalization may be used down to 40 Hz. Once an adjustment seems OK, work on the frequencies on either side of it. You may find that a cut at one frequency is followed by a slight boost at adjacent frequencies.

Shortcuts:

Spin the front-panel knob **counterclockwise** (more than 100 steps) to set the equalization to **flat** (no boost, no cut).

Spin the front-panel knob **clockwise** (more than 100 steps) to activate the EQ Assist™ feature. See the description at the end of this section.

Caution: Do not press the left menu change button unless you wish to reset your changes. All settings would be lost!

	<p>When the desired response for this channel has been achieved, press the right-hand OK button to save the settings.</p>
 <p>L, R, and Ls, Rs or L, R, Ls, Bsl, Bsr, Rs</p>	<p>Press the left menu button once, then move the front-panel knob to select the next channel to be equalized. Repeat the above procedure for the remaining full-range channels.</p>

4.7.4 The EQ Assist Feature

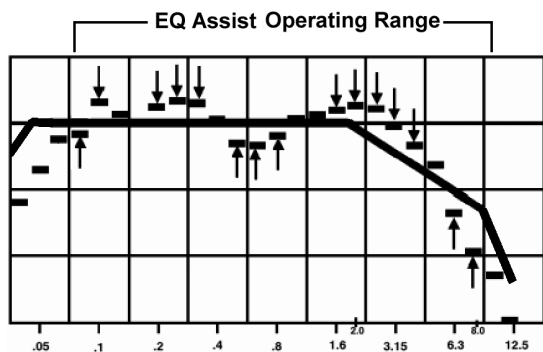


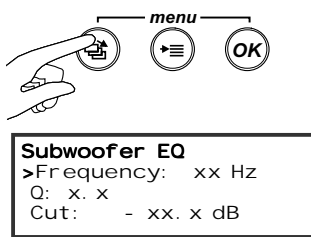
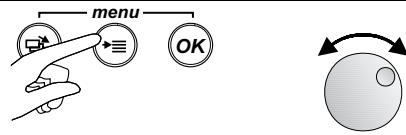
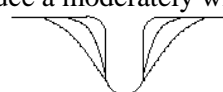
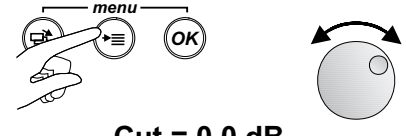
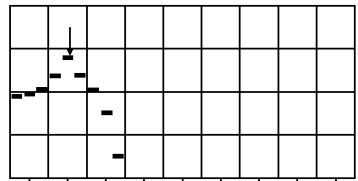
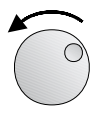
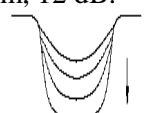
Figure 4-4 EQ Assist Operating Range

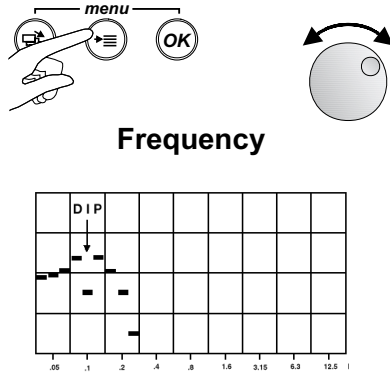
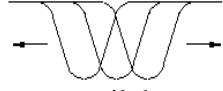
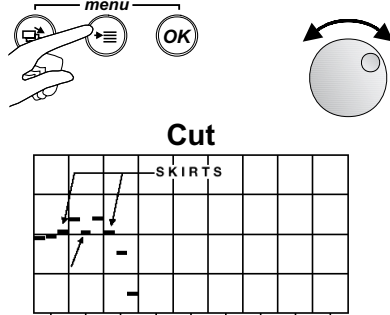
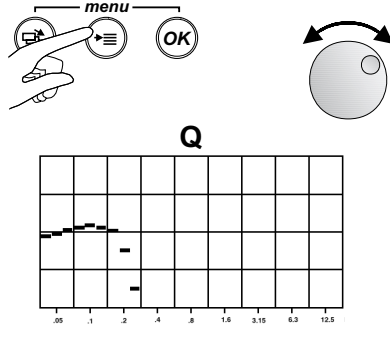

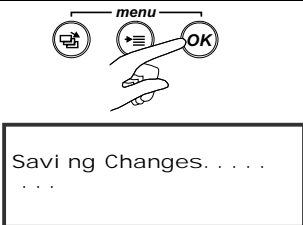
The EQ Assist function automatically adjusts the B-chain EQ levels in 22 bands, attempting to bring the spectrum of the audio in the auditorium in alignment with the standard response curve. **Course (bulk) EQ must be performed before activating EQ Assist. (See Section 4.7.2.)**

Activate EQ Assist by rotating the front-panel knob clockwise to move the blinking cursor up to the 16 kHz band. Keep spinning the knob clockwise. When the cursor stops blinking, EQ Assist is active and no further changes are allowed while it operates. You will see the levels moving, and hear the audio in the auditorium changing as the EQ Assist operates. When the cursor begins blinking again (after approximately eight seconds) EQ Assist has finished.

It is important to note that the lowest three bands of the graphic equalizer (40, 50, and 63 Hz) and the uppermost two bands (12.5 and 16 kHz) will not be adjusted. This is to protect the speakers against undesirable level boosts in those bands. Set these bands manually then verify that the overall equalization is satisfactory.

4.7.5 Setting Subwoofer Channel EQ

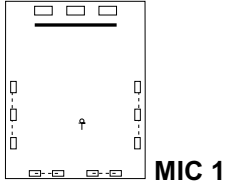
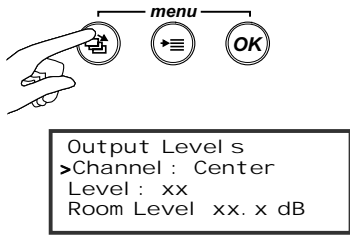
 <p>Subwoofer EQ >Frequency: xx Hz Q: x. x Cut: - xx. x dB</p>	<p>Press the left menu button twice to move to the Subwoofer EQ screen.</p> <p>Equalization facilities for the subwoofer channel are different than for the other channels. This process is designed to correct the principal room resonance in the operating range of the subwoofer. The subwoofer equalizer is a cut-only filter, with adjustable frequency (25 to 125 Hz), Q (center width, selectable between four values), and amount of cut (0 to 12 dB). There is no standard curve displayed for this function.</p> <p>The center menu button is used to select Frequency, Q, or Cut, then the main fader knob to change the setting.</p>
 <p>Q = 2.0</p>	<p>Press the center menu button to move the cursor to Q., then rotate the front-panel knob to set Q to 2.0. This will produce a moderately wide notch.</p> 
 <p>Cut = 0.0 dB</p>	<p>Press the center menu button, moving the cursor to Cut., then rotate the front-panel knob setting cut to 0.0 dB (minimum cut). This will disable the EQ so that you can determine the low-frequency resonant peak to be equalized. The factory setting is 0.0 dB.</p>
	<p>From the analyzer display, determine the primary low-frequency resonant peak of the room.</p>
 <p>Cut = 12.0 dB</p>	<p>Rotate the front-panel knob counterclockwise to set Cut to maximum, 12 dB.</p> 

 <p style="text-align: center;">Frequency</p>	<p>Press the center menu button to move the cursor to Frequency:, then rotate the front-panel knob. A dip in the frequency response will move along the frequency axis of the scope RTA display.</p>  <p>Adjust the frequency until the center of the dip is in the same band as the peak displayed in the previous unequalized frequency response.</p>
 <p style="text-align: center;">Cut</p>	<p>Press the center menu button to move the cursor to Cut:</p> <p>Slowly reduce the amount of cut to flatten the dip displayed above. The center of the dip should be at the same level as the skirts.</p>
 <p style="text-align: center;">Q</p>	<p>Press the center menu button to move the cursor to Q:</p> <p>Adjust Q for the flattest possible frequency response.</p> 
	<p>When the desired response has been achieved, press the right menu OK button to save the settings.</p> <p>After saving the settings, the display returns the Subwoofer EQ screen.</p>




4.7.6 Final Output-Level Calibration

Now that room equalization is complete, the sound pressure level in the theatre can be set accurately.

Main Channels

	<p>If a microphone multiplexer is being used, select MIC 1.</p>
 <p>Output Levels >Channel : Center Level : xx Room Level xx. x dB</p> <p>L, C, R = 85 dB Ls and Rs = 82 dB or Ls, Bsl, Bsr, Rs = 82 dB</p>	<p>Press the left menu button to display the Output Levels screen.</p> <p>Repeat the output level setting steps given in Section 4.5.1, starting with the second step in that section.</p> <hr/> <p>Note: Since the sound pressure level calibration was performed earlier, a recalibration is not required unless the microphone placement has changed. Repeat the steps in Section 4.4 if necessary.</p>

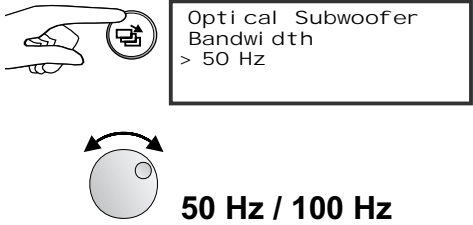
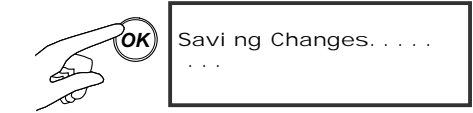
Digital Subwoofer Channel

 <p>Digital Subwoofer >Level : xx Polarity: Normal Center Noise: Off</p>	<p>Switch the microphone multiplexer to cycle.</p> <p>Press the left menu button once to move the display one menu step to Digital Subwoofer Level.</p> <hr/> <p>Note: The RTA oscilloscope display is active on this menu. If the reference line does not appear, the calibration step may have failed or was not performed. Repeat the SPL steps in Section 4.4.</p>
<p>Digital Subwoofer >Level : xx Polarity: Normal Center Noise: Off</p> 	<p>Pink noise is now present on the subwoofer channel only (100 Hz bandwidth).</p> <p>Using the front-panel knob, adjust the subwoofer channel by moving the average subwoofer RTA display to the reference line displayed on the scope.</p>
 <p>Saving Changes.</p>	<p>Press the right-hand OK button to save the final level setting.</p>

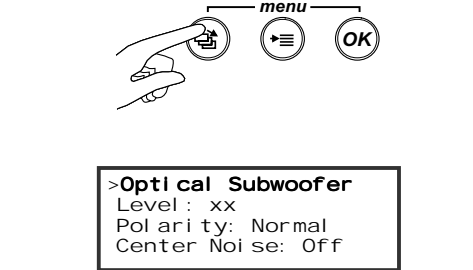
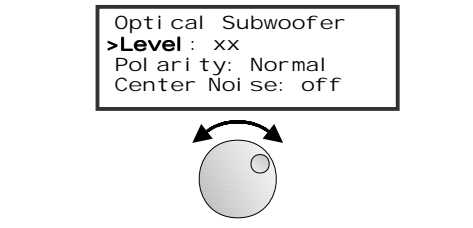
Note: If pink noise is not being generated, this indicates that the status of the digital input has changed. If you are using the digital input on the CP650, either disconnect or power down the device attached the digital input during level setting. A change in the digital input bitstream will cause the CP650 to mute the pink noise during level setting.

Optical Subwoofer Bandwidth

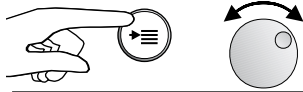
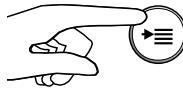


This menu item sets upper frequency limit of the subwoofer channel to either 50 or 100 Hz. The recommended setting depends on the type of screen speakers in your cinema. If you have direct radiator type screen speakers, set the bandwidth to 50 Hz. If you have the older horn-loaded type of screen speakers (such as Altec A-4), set the bandwidth to 100 Hz.

	<p>Press the left menu button once to move the display one menu step to the Optical Subwoofer Bandwidth.</p> <p>Rotate the front-panel knob to select the desired bandwidth.</p>
	<p>Press the right-hand OK button to save the selection.</p>

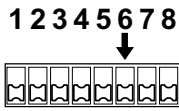
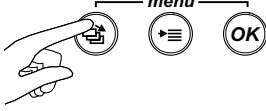



Optical Subwoofer Channel Level

	<p>Press the left menu button once to move the display one menu step to the Optical Subwoofer Level setup menu. Pink noise is now present on the subwoofer channel only.</p> <p>Note: The RTA oscilloscope level reference line displays 10 dB lower for this adjustment and the pink-noise generator bandwidth is 50 Hz for the optical subwoofer setup. If the reference line does not appear, the calibration step may have failed or was not performed. Repeat the steps in Section 4.4.</p>
	<p>Rotate the front-panel knob to move the average level of the displayed pink noise up or down to the meet the reference line.</p>

Subwoofer Speaker Polarity Check

 <div data-bbox="414 414 718 515" style="border: 1px solid black; padding: 5px;"> <p>Optical Subwoofer Level : xx Polari ty: Normal >Center Noi se: On</p> </div>  <p>Polarity:</p>  <p>Normal / Inverse 20–80 Hz Level ↓</p>	<p>Using the center menu button, move the cursor to Center Noise, then rotate the front-panel knob to On.</p> <p>Press the center menu button to move the cursor to Polarity:</p> <p>Use the front-panel knob to switch between Normal and Inverse polarity.</p> <p>Note the change in the average level of the RTA bands between 20 and 80 Hz. There should be a level DECREASE when the polarity is Inverse. The polarity of the subwoofer wiring is incorrect if you do not see a decrease. In this case, reverse the subwoofer speaker wiring connections.</p> <p>If the subwoofer wiring polarity is correct, you will see a level increase between 20 and 80 Hz on the RTA display when the front-panel knob is rotated to Normal.</p>
 <div data-bbox="478 1243 790 1355" style="border: 1px solid black; padding: 5px;"> <p>Savi ng Changes.</p> </div>	<p>Press the right OK button to save the settings.</p> <hr/> <p>Note: The subwoofer polarity will always be reset to the “normal” setting. “Inverse” is a temporary setting for this test only.</p>

4.8 Final Sound Check: Rotating Pink Noise

	<p>Slide DIP switch 6 down to the normal position. The CP650 will switch to normal operation with the user's menu choices available.</p>
 <div data-bbox="427 595 730 701" style="border: 1px solid black; padding: 5px; margin-top: 10px;"> <p style="text-align: center;">CAUTION</p> <p>Pressing OK will play pink noise in the auditorium</p> </div>	<p>Press the left menu button multiple times to move the display to the Rotating Pink Noise screen.</p>
	<p>Press the right OK button to start the pink noise.</p>
<div data-bbox="427 902 730 1005" style="border: 1px solid black; padding: 5px; margin-bottom: 20px;"> <p>Rotating Noise Press OK to Start or Stop Running</p> </div>  	<p>Pink noise is sent to each channel in turn, holding for five seconds at each channel. The channel currently running pink noise is shown on the bottom right-hand side of the display.</p> <p>Unlike the different levels used during alignment, the rotating pink noise is set to 85 dB for all channels during this test.</p> <p>Pressing the right OK button stops the pink noise from moving to the next channel. Pressing the OK button again resumes pink-noise rotation.</p> <p>Go to the auditorium and sit two-thirds of the distance from the front speakers to the rear, and at the center from side-to-side. All channels should sound equally loud and have similar frequency response as the noise rotates. An SPL meter can be used to confirm accurate and equal level settings.</p> <p>Press the illuminated format button to return the CP650 to normal operation.</p>

Chapter 5

A-Chain Alignment

5.1 Overview

The A-chain alignment involves adjustments made to the projector soundhead optics, solar cell, and optical preamplifier board. It is the part of the sound system that covers the film path, analog soundtrack solar cell, optical preamplifier, slit-loss equalizer, digital soundtrack reader, associated digital signal processing and decoding circuitry, and Dolby® processing circuits.

The A-chain optical level is calibrated with the Cat. No. 69T Dolby Tone test film. This film is used to establish the correct Dolby operating level within the CP650.

A Cat. No. 69P pink-noise test film is used for A-chain frequency response and soundhead alignment. Pink noise has a constant amount of energy per 1/3-octave band, creating a flat response on a real-time analyzer display.

The optical slit is the key element in the A-chain because it imposes the initial limitation on the high-frequency response of the system. Light from the exciter lamp passes through the optical slit and is focused on the optical soundtracks on the film. The light that passes through the soundtracks falls on the stereo solar cell, which generates an electrical signal proportional to the audio signal recorded on the optical soundtracks. The slit introduces high-frequency loss, which must be compensated by circuitry in the CP650.

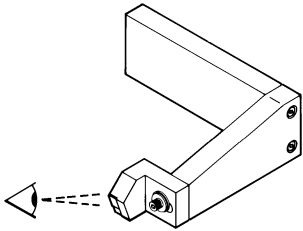
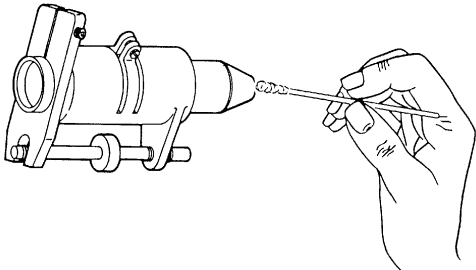
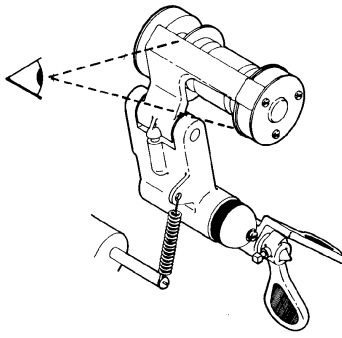
The slit image must be correctly focused on the film and must be set at precisely a right angle to the direction of film movement in order to maintain the correct phase relationships between the two optical tracks. Any azimuth error will show as a loss of high frequency in the front channels and potentially excessive crosstalk in the surround channels.

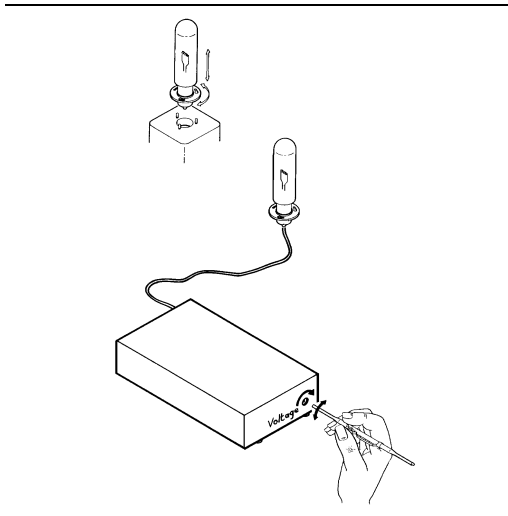
Each channel in the CP650 optical preamplifier is equipped with a slit-loss equalizer control. Adjustment of this control shifts a fixed amount of boost upward or downward in frequency, but the shape of the curve remains constant. A flat response to 16 kHz can be achieved.

5.2 Reverse-Scan Checkup: Projector

Clean the optical surfaces with a cotton swab moistened with glass cleaner. Inspect the film guides for evidence of cuts, cracks, surface defects, or any foreign materials that could impair smooth film guiding.

5.3 Analog Optical Alignment: Projector

	<p>If a stereo solar cell is already installed on Projector No. 1, inspect the surface of the cell for cracks, chipping, or other damage. If the cell appears to require replacement, remove the mounting bracket from the projector and replace the cell and mounting block assembly.</p>
	<p>Clean the lens surfaces with a cotton swab moistened with glass cleaner. But keep in mind that you may find, during optical preamp adjustment, that it will be necessary to remove and inspect the lens if the high-frequency response is not correct.</p> <p>If the lens is removed, clean the lens as indicated above and look through the lens at a light. Repeated heating and cooling of the lens can cause oil or other contaminants to enter the lens barrel. Verify that there is a clear, unobstructed light path through the lens and that the edges of the slit are sharp without cracks or corrosion. Fit a new lens assembly if you are unable to clear the optical path through the slit.</p>
	<p>Inspect the lateral film guides for evidence of cuts, cracks, surface defects, or any foreign materials that could impair the film guiding. Clean or replace the guides as necessary. The guide roller must rotate freely; if it is spring-mounted, make sure that lateral movement and return are not obstructed. If the roller has a felt or rubber insert, check for a flat spot and replace the roller if necessary.</p>

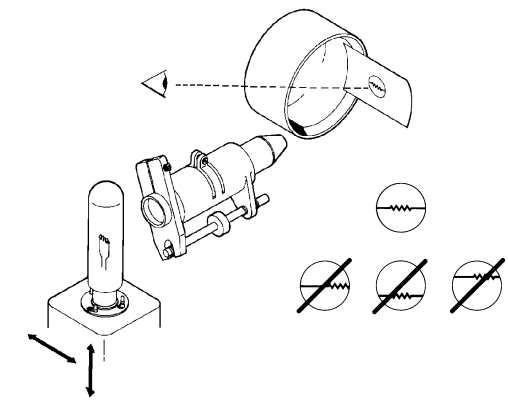


Remove the existing exciter lamp and replace with a new lamp.

Adjust the exciter lamp DC voltage to between 70 and 85 percent of the rated voltage. Using an AC millivolt meter or oscilloscope, verify that there is no more than 3 percent ripple present with the lamp on.

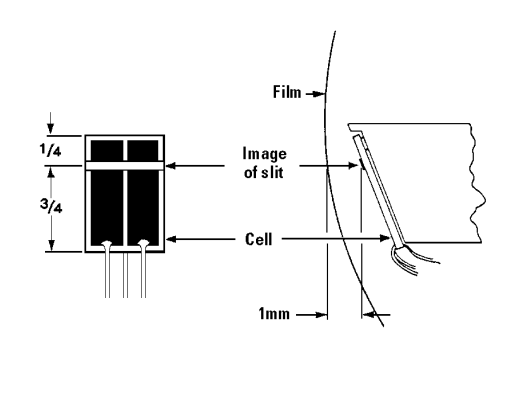
LAMP VOLTAGE	DC ADJUSTMENT
6 V	4-5 Volts
9 V	6.5-8 Volts

If the projector uses a plastic light pipe or tube, verify that the light output is not appreciably affected by dirt, cracks or flaws, yellowing, or foreign matter. Replace if necessary.

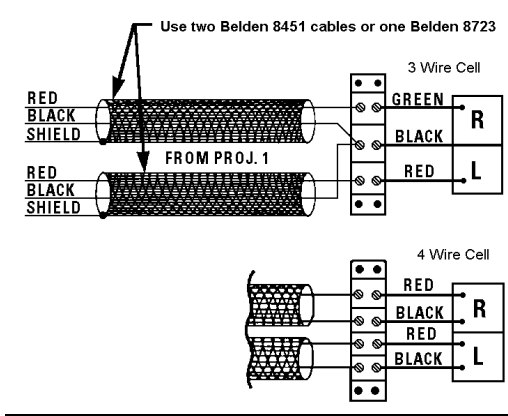


Place a white card at the front of the lens close to the position of the film sound track. Adjust the position of the exciter lamp until the image of the filament is centered both vertically and horizontally as shown.

If you have difficulty obtaining an image of the filament, place a piece of tissue paper over the lens to assist in seeing the image. Some projectors do not use adjusting screws to change the position of the lamp; shims are sometimes used for positioning.



Loosely install the stereo solar cell bracket on the projector. Position the bracket carefully until the surface of the cell is 1 mm from the film plane surface. If this distance is exceeded, there will be crosstalk between the two optical stereo tracks. Check the image of the slit on the cell: It should be a thin sharp line. The slit image should be the width of the cell, and positioned three-quarters of the way up the cell. Try to get the best compromise among all of these conditions and then tighten the cell bracket mounting screws.


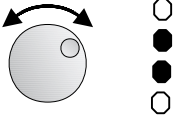
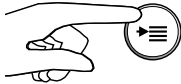
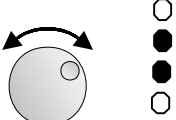

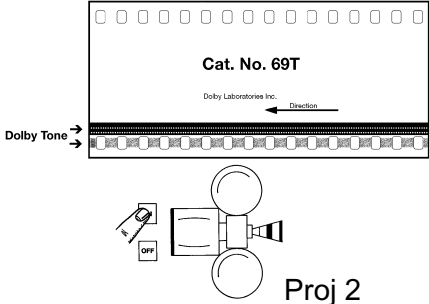
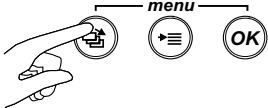


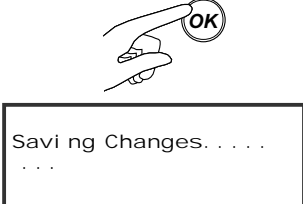
Confirm that the cell wiring and connections are correct. Shielded cables must be used. The inner conductors must be wired to the CP650 OPTICAL input connectors exactly as shown on the wiring diagram foldout.

Note: The solar cell associated with the right channel is closest to the edge of the film.

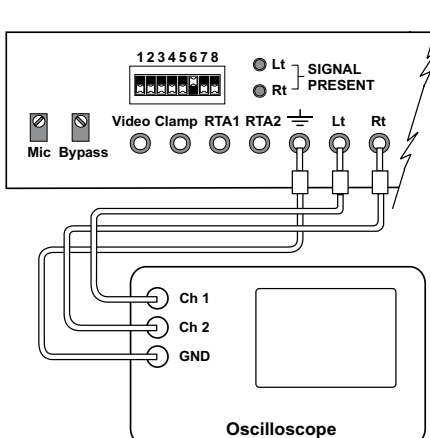
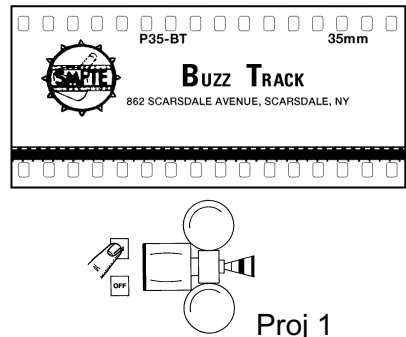
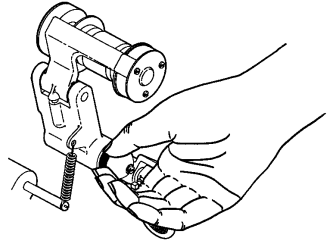
5.4 Dolby Level Set

	<p>Connect the oscilloscope to the Lt and Rt test points.</p> <p>Slide DIP switch 6 to the up position. This switches the CP650 into setup mode.</p>
<div style="border: 1px solid black; padding: 5px; width: fit-content;"> <p>Automatic Optical Level Adjust Projector 1 Press OK When Ready.</p> </div>	<p>Press the left menu button multiple times to move the display to Automatic Optical Level Adjust Projector 1.</p>
	<p>Thread and play a Dolby Tone test film, Cat. No. 69T on projector 1. The film emulsion should face away from the screen.</p> <p>Verify that the signal presence LEDs on the CP650 setup panel are illuminated. The Dolby tone signal should be visible on the oscilloscope.</p> <p>Listen to the tone on the booth monitor to identify any problems with distortion or unwanted film playing speed variations.</p>
<div style="border: 1px solid black; padding: 5px; width: fit-content;"> <p>Please Wait. L O O R O O O O O O</p> </div>	<p>Press the OK button to begin the automatic level calibration for projector 1.</p> <p>Perform automatic calibration for Projector 2 if the theatre is equipped with a second projector.</p>
<div style="border: 1px solid black; padding: 5px; width: fit-content;"> <p>Unable to complete Level adjustment. Press OK to continue</p> </div>	<p>If there is a problem with automatic calibration, this screen will appear.</p> <p>In this case, press the OK button to return to the Automatic Optical Level adjust screen, then press the left menu button twice to move to Manual Optical Level Adjust for Projector 1.</p>

 <div style="border: 1px solid black; padding: 5px; margin: 10px 0;"> <table style="width: 100%; border-collapse: collapse;"> <tr> <td style="width: 60%;">Manual</td> <td style="text-align: center;">L</td> <td style="text-align: center;">O</td> <td style="text-align: center;">O</td> <td style="text-align: center;">R</td> </tr> <tr> <td>Level</td> <td style="text-align: center;">0</td> <td style="text-align: center;">0</td> <td style="text-align: center;">0</td> <td style="text-align: center;">0</td> </tr> <tr> <td>P1</td> <td style="text-align: center;">xx</td> <td style="text-align: center;">0</td> <td style="text-align: center;">0</td> <td style="text-align: center;">0</td> </tr> </table> </div> 	Manual	L	O	O	R	Level	0	0	0	0	P1	xx	0	0	0	<p>Press the OK button to begin manual adjustment.</p> <p>The number displayed on the bottom line represents the level setting for Left channel. The four vertical circles display the Left channel signal level, similar to an LED meter.</p> <p>Rotate the front-panel knob until the two center circles fill black.</p>
Manual	L	O	O	R												
Level	0	0	0	0												
P1	xx	0	0	0												
 <div style="border: 1px solid black; padding: 5px; margin: 10px 0;"> <table style="width: 100%; border-collapse: collapse;"> <tr> <td style="width: 60%;">Manual</td> <td style="text-align: center;">L</td> <td style="text-align: center;">O</td> <td style="text-align: center;">O</td> <td style="text-align: center;">R</td> </tr> <tr> <td>Level</td> <td style="text-align: center;">0</td> <td style="text-align: center;">0</td> <td style="text-align: center;">0</td> <td style="text-align: center;">0</td> </tr> <tr> <td>P1</td> <td style="text-align: center;">0</td> <td style="text-align: center;">0</td> <td style="text-align: center;">xx</td> <td style="text-align: center;">0</td> </tr> </table> </div> 	Manual	L	O	O	R	Level	0	0	0	0	P1	0	0	xx	0	<p>Press the center menu button to select the Right channel.</p> <p>The number displayed on the bottom line will move the Right-channel column.</p> <p>Rotate the front-panel knob until the two center circles fill black.</p>
Manual	L	O	O	R												
Level	0	0	0	0												
P1	0	0	xx	0												
 <div style="border: 1px solid black; padding: 5px; margin: 10px 0;"> <p>Saving Changes.</p> <p>.</p> </div>	<p>Press the OK button to save the level settings.</p>															
	<p>Stop the projector and load/run Cat. No. 69T film loop on projector 2, if so equipped.</p>															
 <div style="border: 1px solid black; padding: 5px; margin: 10px 0;"> <p>Manual Optical Level Adjust Projector 2 Press OK when ready.</p> </div>	<p>Press the left menu button to move the displayed menu to Manual Optical LevelAdjust for projector 2.</p> <p>Repeat the above procedure for the Left and Right channels.</p>															

	<p>Press the OK button to save the level settings for Projector 2, Left and Right channels.</p>
---	---

5.5 Film-Path Alignment Check

	<p>Connect the oscilloscope to the Lt and Rt test points.</p>
	<p>Thread and play a SMPTE Buzz Track test film. This film has modulation just beyond the normally scanned areas of the optical sound tracks. The objective of this test is to ensure that the slit illuminates only the soundtracks.</p>
	<p>The method of positioning the slit relative to the optical tracks varies with the design of projector installed. In many cases, the film guide is adjusted laterally for a null if the lens and exciter lamp are fixed in position. If the film guide cannot be moved, then adjust the lens and LED/exciter lamp assembly laterally.</p>

	<p>The adjustment is correct when there is no signal output while the film is running. It may not be possible to adjust for a null with some older slits; in such instances, adjust for a minimum and equal signal on L and R.</p>
	<p>Some projectors use a lens with an adjustable slit width. The adjustment is correct at the point when the left and right signals both disappear equally.</p>

OSCILLOSCOPE TRACES

5.6 Cell Alignment Check

	<p>Remove the SMPTE Buzz Track test film and thread and play the Cat. No. 97 Stereo Cell Alignment Film.</p>
	<p>If a large amount of crosstalk is present on the scope display, loosen the stereo solar cell head and move it from side to side until the crosstalk is minimum and equal.</p>
<p>Note: The Right channel is the track toward the outside of the projector. On some projectors, it may be necessary to stop the film to adjust the position of the cell.</p>	
<p>Lock the cell bracket into position after completing this adjustment. Check that the crosstalk does not change as the bracket is tightened.</p>	

5.7 Cell Wiring Check

	<p>Verify that the outputs of the right and left solar cells are properly connected by placing a white card over the right sound track (nearer the outside of the projector) and verifying that the level of the Right channel drops, as indicated by the Rt Signal Present LED on the CP650 setup panel.</p>
--	--

If the film path, optics, or LED / exciter lamp were adjusted, repeat the previous film-path alignment and cell alignment steps. The optimum setting is attained when no further adjustments are required using the two test films.

5.8 Azimuth Check

	<p>Thread and play the Cat. No. 69 P pink-noise test film.</p>
<p> </p>	<p>Switch the oscilloscope to the X/Y mode and adjust the azimuth of the projector optics for the narrowest diagonal trace.</p> <p> </p> <p>Also, if the ends of the trace display thicker than the center area, then improper lighting of the edges of the optical tracks should be corrected.</p> <p>Note: If necessary, repeat the buzz track and cell alignment steps or LED/exciter lamp position steps above to reduce such blooming to a minimum.</p>





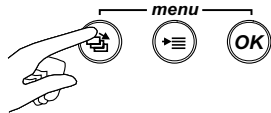
5.9 Focus Check

	<p>Reconnect the scope to RTA1 and RTA2 test points.</p>
	<p>Press the CP650 left menu button to move to the Optical Focus adjust menu.</p> <p>The scope RTA will display the frequency response of the Left channel optical preamp output for projector 1.</p> <p>The center menu button selects the projector or channel.</p> <p>The front-panel knob selects P1/P2, or Left/Right channel to view. Select projector 1.</p>
	<p>With the pink-noise test film running, observe the high-frequency response displayed on the scope.</p> <p>Adjust the focus of the sound track lens for the best high-frequency response on both the left and right channels.</p> <p>The RTA trace shown may not be typical of your results. Merely attempt to obtain the best response. The azimuth and focus adjustments interact so you must repeat the azimuth and focus adjustments until no further improvement is obtained. Do not proceed to the next step until both the left and right results are similar.</p>
	<p>Repeat the focus adjustment for projector 2.</p>

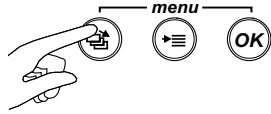
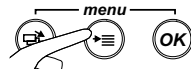

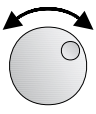
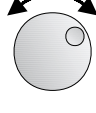
5.10 Optical HF Equalization (Slit-Loss EQ)

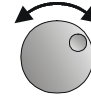
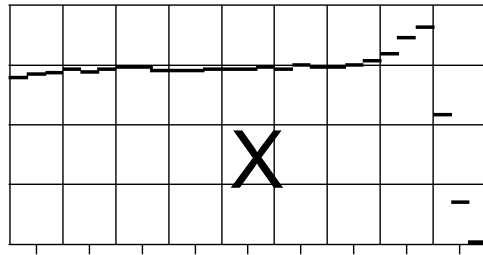
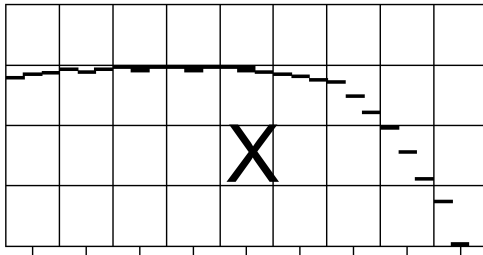
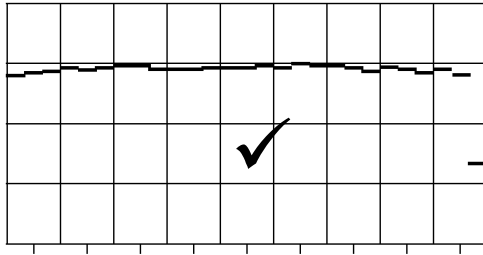
This step adjusts the high-frequency response of the optical preamplifier circuit. The CP650 provides both automatic and manual facilities for optical, or slit-loss, high-frequency equalization. The Auto menu appears first:

Auto Slit-Loss EQ

 <p>Pink Noise</p>	<p>Continue to play the Cat. No. 69 P pink-noise test film.</p>
<p>Projector 1:</p> <div style="border: 1px solid black; padding: 5px; margin-bottom: 10px;"> <p>Auto Slit-Loss EQ Projector P1</p> <p>Press OK when ready.</p> </div> <div style="border: 1px solid black; padding: 5px;"> <p>Auto Slit-Loss EQ Level Adjust done. Press OK to save the current settings.</p> </div>   	<p>Move the CP650 menu display to Auto Slit-Loss EQ for Projector 1.</p> <p>Press the OK button to begin automatic equalization. The HF response on both the Left and Right channels are automatically equalized. You can observe the action on the scope RTA display. Dots shown on the front-panel display show progress. When the dots reach the end of the line, the Right channel is automatically equalized.</p> <p>When EQ is completed, as shown on the display, press the OK button to save the settings.</p>
	<p>Press the left menu button to move to the Projector 2 menu and repeat the procedure above if a second projector is installed.</p>

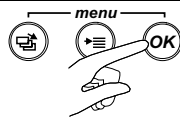
Manual Slit-Loss EQ

	<p>The next menu is used for manually adjusting the slit-loss EQ.</p>
<p>Projector 1:</p> <div style="border: 1px solid black; padding: 5px; margin-bottom: 10px;"> <p>Manual Slit-Loss EQ Projector 1 >Channel : Left Value: xx</p> </div>   <div style="display: flex; justify-content: space-around; align-items: center;"> <div style="text-align: center;">  <p>Left / Right</p> </div> <div style="text-align: center;">  <p>Adjust EQ</p> </div> </div>	<p>Use the center menu button to chose between the channel to be adjusted and the setting (value).</p>



Rotate the front-panel knob for the most extended high-frequency response without “peaking.”

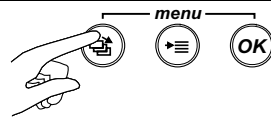
Note: If this procedure does not improve the response, the problem may be a degraded slit or lens damage.



Saving Changes.
.....

When the desired response has been achieved, press the right menu **OK** button to save the settings.

After saving the settings the display returns the **Manual Slit-Loss EQ Projector 1** menu.



Projector 2:
Manual Slit-Loss EQ
Projector 2
>Channel : Left
Val ue: xx

Press the left menu button to move to **the Manual Slit-Loss EQ Projector 2** menu and repeat the procedure above.

Chapter 6

Digital Soundheads

6.1 Mechanical Alignment

Mechanical alignment of the Cat. No. 701 (or 700) Digital Soundhead consists of confirming that the film path through the digital soundhead is aligned with the path through the projector. For built-in reverse-scan (basement) digital soundheads, see the manufacturer's instructions.

1. Thread a length of film from a supply reel through the digital soundhead (refer to the threading diagram located on the soundhead), and continue through the projector as you would any film.
2. Apply tension to the film and inspect for equal tension on both edges of the film.
3. Check for uneven forces on the rollers, or twisting of the film.
4. When the path is aligned, tighten the soundhead mounting bolts and reel arm.

Set film path so that top and bottom tension arm rollers (A) are approximately 5 mm (1/4 inch) apart. Use the white painted semi-circles (B) for angular alignment of tension arms (C). Make sure that the rollers do not touch.

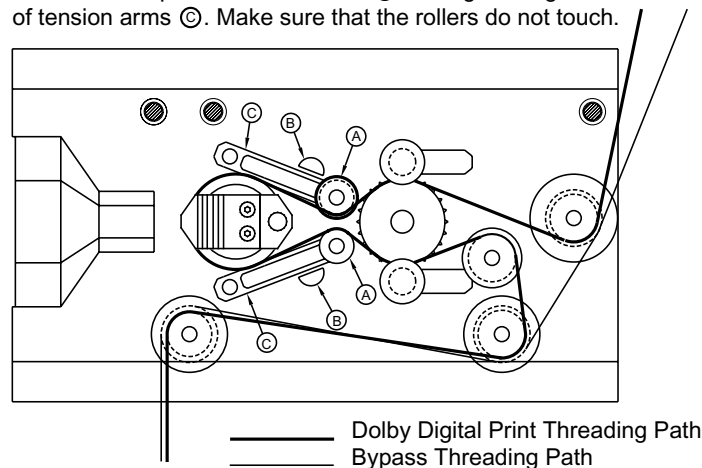


Figure 6-1 Digital Soundhead Adjustments

6.2 Adjustment with Oscilloscope

Note: The Cat. No. 701 Digital Soundhead is optically aligned at the factory and should not require adjustment unless the CCD Circuit Board has been disturbed.

The following test setup will enable adjustment of focus and confirmation or adjustment of light level and optical alignment.

1. Make sure power to the digital soundhead is provided. Power to the CP650 should also be on.
2. Open the CP650 front-panel setup access door.
3. Connect a probe from Channel 1 of an oscilloscope (with 20 MHz or greater bandwidth) to the VIDEO Test Point, with the ground lead attached to the ground test point.
4. Connect a second probe from the scope's Channel 2 to the CLAMP signal test point to trigger the scope. Connect the second probe's ground wire to the ground test point.
5. Set the trigger source on the scope to Channel 2.
6. Adjust the Channel 2 vertical trace position to move the trace off the screen. It is not necessary to view this signal after triggering has been established.
7. Adjust the scope for one horizontal trace across the screen, and adequate vertical gain (approximately 2 μ s/div. horizontal, 1 V/div. vertical).
8. With digital film threaded and running in the projector, observe the video waveform. (See Figure 6-2.)

6.3 Focus Adjustment

Cat. No. 701 (or 700) Digital Soundheads are factory adjusted and should not require adjustment during installation. If the soundhead has become misadjusted, it may be necessary to re-focus. Using the setup as above, adjust the objective lens/CCD assembly in the reader head by loosening the 2 mm hex socket set screw (located below the lens bore), which holds the lens/CCD assembly in place, then moving the assembly back and forth. There are two methods for moving the assembly. A flat blade screw driver inserted in the oval slot above the lens can be twisted to slide the assembly. Alternatively, if the CCD circuit board cover is removed, the assembly can be moved back and forth with your thumb and forefinger. The best focus is achieved when the scope pattern has minimum brightness in the center of the trace. (See Figure 6-2.) Look for the most "in-focus" display possible, while maintaining minimum brightness inside the envelope. Setting the best focus will help minimize the digital error rate.

Re-tighten the lens-holding screw.

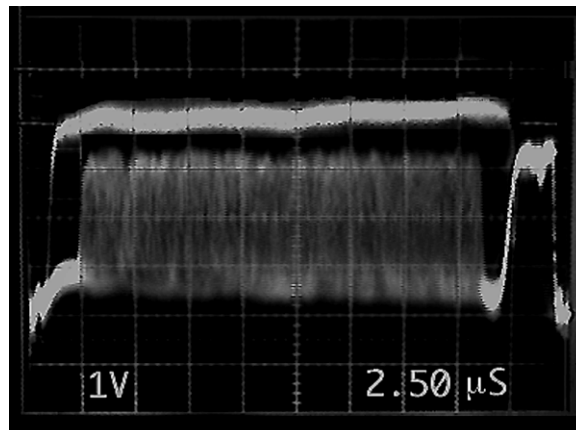


Figure 6–2 Digital Video Oscilloscope Image—Focus Adjustment

6.4 LED Brightness Confirmation and Adjustment

The optimum peak video signal voltage (unobstructed light through the perf hole) is **4 V**, measured from the 0 V reference baseline to the **upper trace**. If necessary, adjust the Cat. No. 701 power supply output to achieve the correct video voltage. See Figure 6-3 for adjustment location (VR1). The back cover of the digital soundhead must be removed to gain access to the output adjustment.

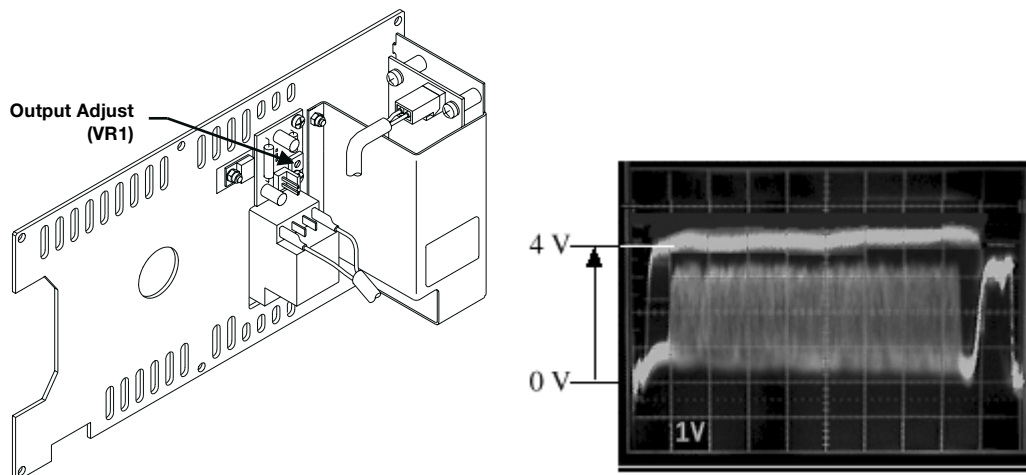


Figure 6–3 Cat. No. 701 LED Brightness Adjustment

6.4.1 Inboard Digital Readers

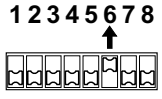

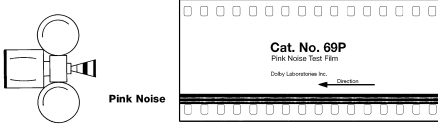
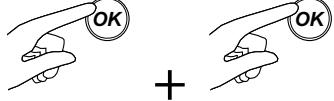
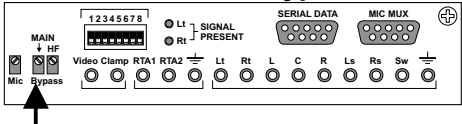
There are several varieties of basement readers, some use lamps, and some use LEDs as the illumination source. Refer to the instructions for the built-in reader for details on adjusting lamp/LED current. In any case, the proper video level is 4 V. If the top of the video waveform is not reasonably flat (± 1 division), check for dirt, dust, or other obstruction to the light path, and clean.

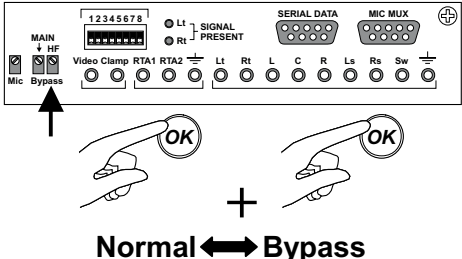
Chapter 7

Final Adjustments

7.1 Setting Bypass Level

With a Cat. No. 791 Crossover Card installed, two jumpers, located on the Cat. No. 772A card, must be set to “Yes”. This enables the Cat. No. 791 card bypass output and sends a full-range signal to the hearing-impaired output. CP650s shipped with a Cat. No. 791 card have the correct jumper settings. See Figure 4–2 .

 <p>1 2 3 4 5 6 7 8 ↑ DIP switch 6 up</p>	<p>Ensure that DIP switch 6 is in the “up” position</p>
 <div style="border: 1px solid black; padding: 5px; width: fit-content; margin: 10px auto;"> <p>Bypass Level Adjust</p> <p>Press OK to enter bypass.</p> </div>	<p>Press the left menu to move the Bypass Level Adjust menu (or press and hold while rotating the front-panel knob). Press the OK button, switching the CP650 to bypass operation. The main power button will illuminate, confirming that the unit is in bypass.</p>
 <p>Pink Noise</p>	<p>Thread and play a loop of Cat. No. 69P pink-noise test film.</p>
 <p>Normal ↔ Bypass</p> 	<p>Using the OK button, toggle back and forth between normal and bypass operation, while setting the MAIN bypass level trimpot (located through the access hole on the setup panel). Adjust the pot until the audio level in the auditorium sounds the same for normal and bypass.</p>

	<p>If your CP650 is equipped with a Cat. No. 791 Crossover Card:</p> <p>Follow the previous steps to set the Main bypass level trimpot for correct low-frequency level matching.</p> <p>With the unit in bypass, adjust the HF bypass level trimpot for correct low/high-frequency balance. A real-time analyzer should be used for accurate setting.</p> <p>Verify that the audio level in the auditorium sounds the same when in normal and bypass modes by using the OK button to toggle back and forth between normal and bypass.</p>
	<p>When finished, leave the CP650 in normal operating mode (Power button not showing red).</p>

Optical Surround Level Trim

It is recommended that you perform this adjustment. (See Appendix C.)

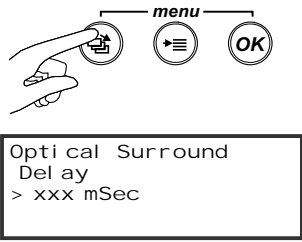

7.2 Setting Optical Surround Delay

In analog optical formats, the CP650 incorporates a delay line in the surround channel to ensure that sound from the rear of the theatre arrives at the listeners’ ears approximately 20 milliseconds after the arrival of sound from the front speakers. The delay is adjustable from 20 to 150 ms, in 1 ms steps. The setting is stored to CP650 memory using the procedure outlined below. Use the following formula to calculate the correct delay setting:

1. Estimate the distance between a rear seat and the nearest surround loudspeaker, in feet. If the metric system is used, multiply the meters by 3 to convert to feet.
2. Estimate the distance from this seat to the front loudspeakers (again, in feet). If the metric system is used, multiply the distance by 3 to convert distance from meters to feet.
3. Subtract the distance measured in step 1 above from the distance measured in step 2, then add 20. The result is the delay time, in milliseconds.

For example:

- The selected seat is 10 feet (3.3 meters) from the nearest surround speaker.
- The selected seat is 80 feet (26.7 meters) from the front speakers.
- The delay is set for $(80-10) + 20 = 90$ milliseconds.

	<p>Press the left menu button to move to the Optical Surround Delay menu.</p>
	<p>Rotate the front-panel knob to show the desired delay, then push the OK button.</p>

You can verify that the delay setting is acceptable by listening to a familiar Dolby® A-type film that ideally contains both center-channel dialogue and some discernible surround sound. The Dolby Cat. No. 251 SR/Digital film “*Jiffy*” serves this purpose well. If a stereo film is not available, the delay time can be checked with a mono film if the film is played in Format 04, Dolby A-type optical with surround. All speakers should be **on** for this test.

While the film is playing, walk around the theatre and listen carefully to the surround speakers during center-channel dialogue. The dialogue should appear to be coming primarily from the screen, and not from the surround speakers.

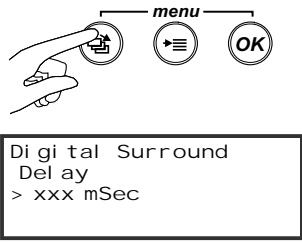

If you hear discernible dialogue from the surround speakers, the delay time was probably set too long.

If you hear an objectionable amount of dialogue from the surround speakers that persists regardless of the delay time setting, there is probably a severe gain or azimuth error in the system. Re-check both the Dolby level and the A-chain alignment of the optical system.

In many films, the surround information is intended for subtle effects and may provide only a low-level ambience. If the surround level and delay time have been adjusted as previously described, the surround information will be at the level desired by the film director. Do not be tempted to increase the surround level, because the effect desired by the film production team may be thwarted.

7.3 Setting Digital Surround Delay

The CP650 automatically calculates a typical digital surround delay based on the optical surround delay setting performed in the previous section. Actual theatre geometry affects the amount of surround delay required; you may, therefore, wish to set the delay manually.

	<p>Press the left menu button to move to the Digital Surround Delay menu.</p>
	<p>Rotate the front-panel knob to show the desired delay then push the OK button.</p>

Tables 7-1 and 7-2 show approximate delay values (in milliseconds) based on theatre width and length. Setting of surround delay should be verified by listening at various locations in the theatre.

Table 7-1 Surround Delays Based on Theatre Dimensions (in Feet)

		Width (feet)												
		20	30	40	50	60	70	80	90	100	110	120	130	140
Length (feet)	20	10	10	10	10	10	10	10	10	10	10	10	10	10
	30	10	10	10	10	10	10	10	10	10	10	10	10	10
	40	20	20	20	20	20	20	20	20	20	20	20	20	20
	50	30	20	20	20	20	20	20	20	20	20	20	20	20
	60	30	30	30	30	30	30	30	30	30	30	30	30	30
	70	40	30	30	30	30	30	30	30	30	30	30	30	30
	80	50	40	40	40	40	40	40	40	40	40	40	40	40
	90	50	50	40	40	40	40	40	40	40	40	40	40	40
	100	60	50	50	50	50	50	50	50	50	50	50	50	50
	110	70	60	60	50	50	50	50	50	50	50	50	50	50
	120	70	70	60	60	50	50	50	50	50	50	50	50	50
	130	80	80	70	70	60	60	60	60	60	60	60	60	60
	140	90	80	80	70	70	60	60	60	60	60	60	60	60
	150	90	90	80	80	80	70	70	70	70	70	70	70	70
160	100	100	90	90	80	80	70	70	70	70	70	70	70	
170	110	100	100	90	90	80	80	80	80	80	80	80	80	
180	110	110	100	100	100	90	90	80	80	80	80	80	80	
190	120	120	110	110	100	100	90	90	90	90	90	90	90	
200	130	120	120	110	110	100	100	100	90	90	90	90	90	

Table 7–2 Surround Delays Based on Theatre Dimensions (in Meters)

		Width (meters)								
		10	15	20	25	30	35	40	45	50
Length (meters)	10	20	20	20	20	20	20	20	20	20
	15	20	20	20	20	20	20	20	20	20
	20	30	30	30	30	30	30	30	30	30
	25	40	40	40	40	40	40	40	40	40
	30	50	50	50	50	50	50	50	50	50
	35	60	60	50	50	50	50	50	50	50
	40	80	70	60	60	60	60	60	60	60
	45	90	80	70	70	70	70	70	70	70
	50	100	90	80	80	80	80	80	80	80
	55	110	100	90	90	80	80	80	80	80
	60	120	110	110	100	90	90	90	90	90
	65	130	120	120	110	100	100	100	100	100
	70	140	140	130	120	110	110	110	110	110
75	150	150	140	130	120	120	110	110	110	

7.4 Setting Dolby Digital Reader Delay

On a Dolby Digital print, the digital sound data is located 6 frames in advance of the analog soundtrack, and 26 frames in advance of the picture. When the digital soundhead is mounted above the analog soundhead (as with the Cat. No. 701), a delay is necessary to synchronize the digital soundtrack with the analog track and the picture. In the CP650, this delay is set by entering the number of film perforations, within the range from 12 perfs (approximately 160 ms delay) to 512 perfs (approximately 5 seconds).

Soundhead delay can be determined in either of two ways—**static or dynamic**—as described below:

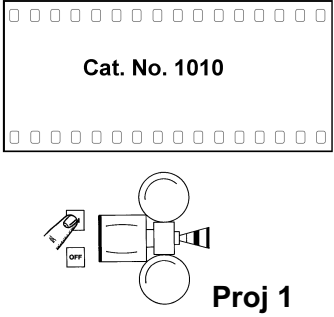
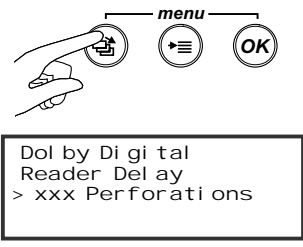
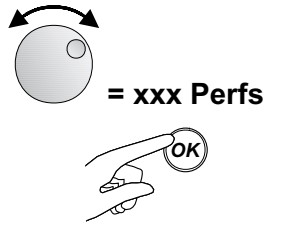
Static

1. Thread a length of Cat. No. 1010 Digital Soundhead alignment test film such that the “bullet” frame (perf 106) is located in the picture gate, and perf number 26 is located at the analog soundhead.
2. With the length threaded through the Cat. No. 701 Digital Soundhead, read the number of perforations present in the light path of the digital soundhead. Enter this number using the procedure shown below:

	<div style="border: 1px solid black; padding: 5px;"> Dol by Di gi tal Reader Del ay > xxx Perforati ons </div>	Press the left menu button to move to the Dolby Digital Reader Delay menu.	
	= xxx Perfs		Rotate the front-panel knob to show the number of perforations obtained above, then push the OK button.

3. Verify the accuracy of the setting by running a loop of Cat. No. 1010 test film and observing that the flash on the screen coincides with a pip in the sound.

Dynamic

	<p>Thread a loop of Cat. No. 1010 Digital Soundhead alignment test film through the projector, analog soundhead, and digital soundhead. Run the projector.</p>
	<p>Press the left menu button to move to the Dolby Digital Reader Delay menu. Both optical and digital audio are present while the CP650 is set to this menu item.</p>
	<p>The audio contains equal digital and optical sound simultaneously.</p> <p>Rotate the front-panel knob to set the number of perfs that produce a minimum delay between the analog and digital track, then push the OK button.</p>

The tables below show representative delay settings for a variety of common projectors in use:

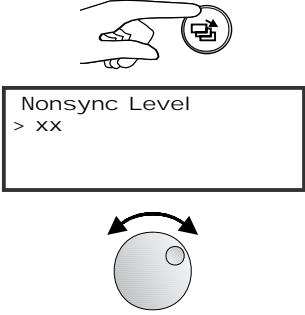
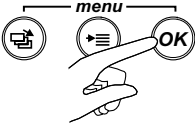
Table 7-3 Typical Delay Settings for Dolby Digital Readers

Projector	Delay (Perfs)	Projector	Delay (Perfs)
Ballantyne 35mm	247	Christie	250
Century 35mm (SA)	245	Norelco/Kinoton	283
Century 35/70 (JJ)	309	AAlI (DP70)	242
Cinemeccanica V5	252	Simplex 35mm (XL)	298
Cinemeccanica V8	260	Simplex 35/70	


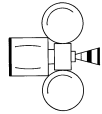


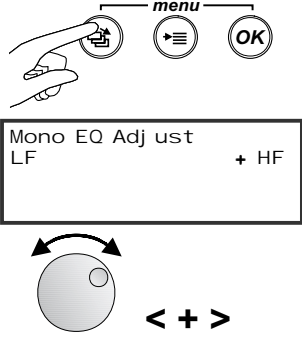

Table 7-4 Typical Delay Settings for Built-in Digital Readers

Projector	Delay (Perfs)	Projector	Delay (Perfs)
Century w/ Component Engineering or Kelmar	20	Cinemeccanica V5	28
Christie	26	Simplex 5 Star w/ Component Engineering or Kelmar	26
Ernemann 15	30		

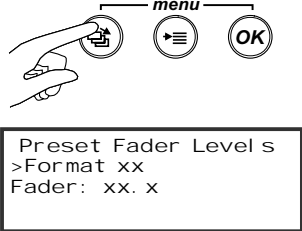
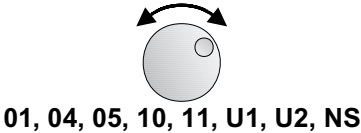
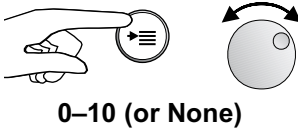

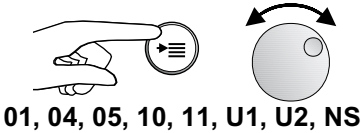
7.5 Nonsync Level Adjustment

 <p>The diagram illustrates the first step of the adjustment process. A hand is shown pressing the left menu button. Below this, a rectangular display shows the text 'Nonsync Level' followed by '> xx'. Underneath the display is a circular knob with a curved arrow above it, indicating that the knob should be rotated to adjust the level.</p>	<p>Press the left menu button to move to the Nonsync 1 Level (or Nonsync 2 Level) menu.</p> <p>Play a CD or cassette, etc, on the nonsync device and adjust the front-panel knob for the desired level in the theatre. If possible, select a recording that has a natural ambience such as an orchestral work.</p> <hr/> <p>Note: During nonsync level setting, the main fader level is fixed at 7.0. This makes special fader settings for nonsync unnecessary.</p>
 <p>The diagram shows a hand pressing the 'OK' menu button. Above the buttons, the word 'menu' is written with a line connecting the left and middle buttons. The 'OK' button is the rightmost button in the sequence.</p>	<p>Press the OK menu button to save the desired level setting.</p>

7.6 Mono Level Trim and EQ Adjustment







	<p>Press the left menu button to move to the Mono Level Trim menu.</p>
	<p>Thread and play a mono film familiar to you.</p>
	<p>While the film is running, adjust the front-panel knob to the desired loudness level.</p> <hr/> <p>Note: During mono level setting, the main fader level is fixed at 7.0. This makes special fader settings for mono films unnecessary.</p>
	<p>Press the OK menu button to save the desired level setting.</p>
	<p>Press the left menu button to move to the Mono EQ Adjust menu.</p> <p>If necessary, adjust the front-panel knob to change the equalization for a more pleasing sound.</p> <hr/> <p>Note: With the "+" symbol located at the far-right position (HF setting) of the display, the CP650 applies the "Academy" filter.</p>
	<p>Press the OK menu button to save the desired EQ setting.</p>

7.7 Assigning Preset Fader Levels

	<p>Press the left menu button to move to the Preset Fader Levels menu. Preset levels can be assigned to each CP650 format button.</p>
	<p>Rotate the front-panel knob to select the format button you wish to preset.</p>
	<p>Press the center menu button to move the selection to “Fader:”, then rotate the front-panel knob to the desired level setting.</p>
	<p>Press the OK menu button to save the setting.</p>
	<p>Press the center menu button to move to “Format” and rotate the front-panel knob to select the next format button you wish to preset. Repeat the steps above to set the preset fader level and save the change.</p>

7.8 Assigning User Button Formats

Any available format can be assigned to the U1, U2, or NS buttons (“User 1”, “User 2”, “Nonsync”). Then, when the button is pressed, that format will be selected.

 <div style="border: 1px solid black; padding: 5px; width: fit-content; margin: 10px auto;"> User Format 1 > Format xx format name </div>	<p>Press the left menu button to move to the User Format 1 menu.</p>
 <div style="border: 1px solid black; padding: 5px; width: fit-content; margin: 10px auto;"> User Format 1 >Format 80 Di gi tal Input </div>	<p>Rotate the fader knob to select one of the many format choices available to you. This example shows Format 80, Bitstream Master Digital Input, selected.</p>
 <div style="border: 1px solid black; padding: 5px; width: fit-content; margin: 10px auto;"> Savi ng Changes. . . </div>	<p>Press the OK button to save the assignment to the User 1 button.</p>
 <p style="text-align: center; font-weight: bold; font-size: 1.2em;">1X</p>	<p>Press the left menu button once to step to the User Format 2 menu.</p>
 <div style="border: 1px solid black; padding: 5px; width: fit-content; margin: 10px auto;"> User Format 2 >Format 65 Publ i c Address LsRs </div>	<p>Rotate the fader knob to select the desired format. This example shows format 65, PA microphone sent to left and right surround speakers.</p>
 <div style="border: 1px solid black; padding: 5px; width: fit-content; margin: 10px auto;"> Savi ng Changes. . . </div>	<p>Press the OK button to save the assignment to the User 2 button.</p>

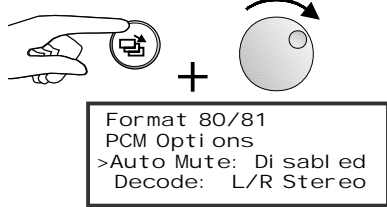
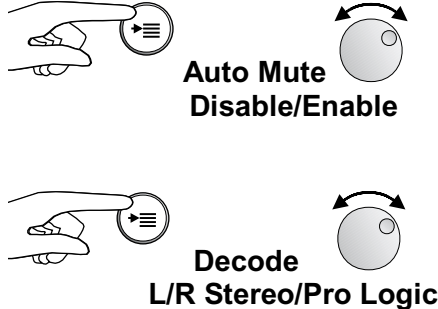
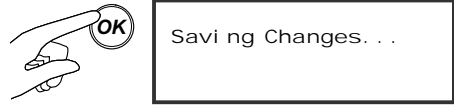
7.9 Assigning NS Button Format

The nonsync button, “NS,” can be assigned to any available format. Then, when the button is pressed, that format will be selected. Follow the procedure in the previous steps.

7.10 Format 80/81 PCM Options

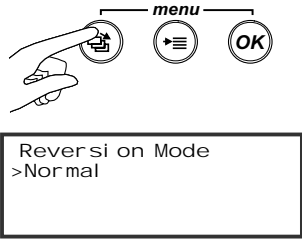
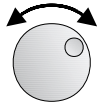

Use this menu to change the settings for processing a PCM digital input to the Cat. No. 790 or 794 card, or the first digital input of the Cat. No. 778 card (Option Card I/O connector). Pro Logic® decoding can be applied to the signal if desired.

Auto-Mute causes the CP650 outputs to mute automatically if a Dolby Digital bitstream input is not present. When a PCM input bitstream is detected, the CP650 outputs will mute. Use this option with caution.

	<p>Press the left menu button, or press and hold the button while rotating the front-panel knob to move to the Format 80/81 PCM Options menu.</p>
	<p>Press the middle menu button to choose between setting PCM Auto Mute and PCM Pro Logic Decode.</p> <hr/> <p>Note: Be aware that enabling PCM auto mute will not allow the CP650 to play back any PCM content.</p> <hr/> <p>Rotate the front-panel knob to make the selections.</p>
	<p>Press the OK button to save the settings.</p>

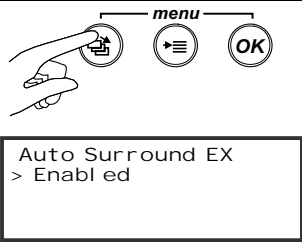
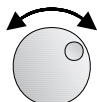

7.11 Reversion Mode

Caution: Be aware that leaving the CP650 set to **No Reversion** mode prevents automatic switching to analog optical sound if there is a loss or failure of the Dolby Digital soundtrack.

	<p>Press the left menu button to move to the Reversion Mode menu.</p>
	<p>Rotating the front-panel knob will switch the CP650 between Normal and No Reversion.</p> <p>Note: The mode will always be set to Normal after switching the power on.</p>
	<p>Press the OK menu button to save the setting.</p>


7.12 Auto Surround EX Disable

Caution: Be aware that leaving the CP650 set to **Disabled** prevents automatic switching to Dolby Digital Surround EX when these films are played.

	<p>Press the left menu button to move to the Auto Surround EX screen.</p> <p>The Auto Dolby Digital Surround EX feature can be disabled for testing purposes.</p>
	<p>Rotating the front-panel knob will switch the CP650 between Enabled and Disabled.</p> <p>Note: Auto Surround EX will always be set to Enabled after switching the power on.</p>
	<p>Press the OK menu button to save the setting.</p>

7.13 Noise Gating

This menu item is for special applications. It can be used with specialized test equipment to make RT-60 measurements. See Table B-11 in Appendix B for signal connection details.

 <p>Noi se Gat i ng Acti ve</p>	<p>Press the left menu button to move to the Noise Gating Active screen.</p> <p>When this menu item is selected, connecting certain automation port terminals to ground will cause pink noise to be sent to individual or all channels.</p>
--	---

7.14 Running Auditorium Assist

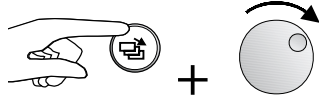
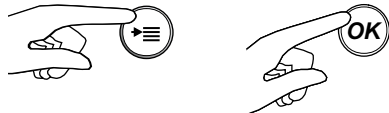

The Auditorium Assist™ feature, included in CP650 operating system software version 2.0 and higher, provides an indication of the stability and characteristics of your theatre's speakers, crossovers, amplifiers, and auditorium acoustics. The first time it is used, the frequency response and sound level of each speaker are checked and stored in the CP650 memory. Whenever Auditorium Assist is subsequently selected, all channels are measured and compared to these reference settings. Auditorium Assist also checks and compares the level of the ambient noise floor in the auditorium to the reference level originally stored.

7.14.1 Operation

Activate the Auditorium Assist reference measurement function after the first B-chain alignment is finished, and again after any subsequent changes in the EQ settings or sound equipment have been made. The initial measurements should be performed after the CP650 theatre installation is complete: with seats, carpet, screen, and room treatment all installed. Auditorium conditions should include the following:

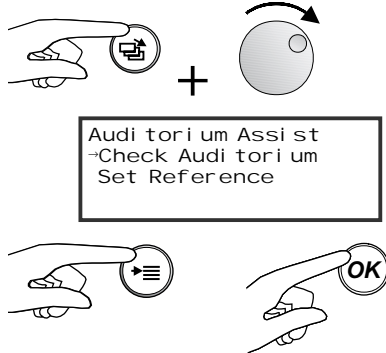
- Curtains and masking fully open
- Auditorium unoccupied
- Doors closed
- Heating and air conditioning system switched to a known and repeatable condition

7.14.2 Establish Reference Measurements

 <div data-bbox="416 499 721 602" style="border: 1px solid black; padding: 5px;"> Audi tori um Assi st No Reference ↳Set Reference </div> <div data-bbox="416 613 721 714" style="border: 1px solid black; padding: 5px;"> Audi tori um Assi st Check Audi tori um ↳Set Reference (I nval i d Reference) </div>	<p>To move the display to the Auditorium Assist menu, press the left menu button multiple times, or press and hold the button while rotating the front-panel knob.</p> <p>A “No Reference” display means there are no reference measurements stored in CP650 memory.</p> <p>An “Invalid Reference” display means the CP650 room equalization settings were changed after the previous reference measurements were stored.</p>
	<p>Use the middle menu button to choose Set Reference, then press the OK button to begin the process. The CP650 will output pink noise to the center channel speaker for initial microphone input level calibration.</p>
<div data-bbox="427 943 732 1046" style="border: 1px solid black; padding: 5px;"> Audi tori um Assi st Cal i brate mi c . . . L > H Press OK to conti nue </div> <div data-bbox="427 1090 732 1193" style="border: 1px solid black; padding: 5px;"> Audi tori um Assi st Cal i brate mi c . . . L * H Press OK to conti nue </div> 	<p>If reference measurements have not been previously stored, a meter appears allowing you to trim the microphone input level. Adjust the input level by turning the mic input level pot located directly next to the bypass output level pot on the setup control panel.</p> <p>The display shows an asterisk midway between the Low and High indicators when the ideal mic level is reached.</p> <p>Press the OK button to accept the mic level setting and do not make any further changes to the mic level pot.</p>
<div data-bbox="427 1339 732 1442" style="border: 1px solid black; padding: 5px;"> Audi tori um Assi st Setti ng Reference: Left Press OK to cancel </div>	<p>Auditorium Assist automatically begins the reference calibration sequence, beginning with an auditorium noise floor measurement, then cycling through all channels. The channel being measured is displayed.</p> <hr/> <p>Note: The CP650 outputs pink noise at 85dBC for the L, C, and R channels; 82dBC for each of the surround channels; and +10 dBr for the subwoofer.</p> <hr/> <p>When finished, the reference measurements are automatically saved in the CP650 memory for comparison against future checks, and the display returns to the initial Auditorium Assist menu.</p>

7.14.3 Auditorium Sound Check

The Auditorium Assist sound-check function can be performed at any time.

 <p>Auditorium Assist -Check Auditorium Set Reference</p> <p>Auditorium Assist -Check Auditorium Set Reference (Invalid Reference)</p>	<p>To move the display to the Auditorium Assist menu, press the left menu button multiple times, or press and hold the button while rotating the front-panel knob.</p> <p>Use the middle menu button to choose Check Auditorium, then press the OK button to begin the process.</p> <hr/> <p>Note: The display shows “Invalid Reference” if the CP650 room equalization settings were changed after reference measurements were stored. A new set of reference measurements must be stored.</p>
<p>Auditorium Assist Checking Auditorium: Left Press OK to cancel</p>	<p>Auditorium Assist automatically begins the measurement sequence, beginning with an auditorium noise floor measurement, then cycling through all channels. The channel being measured is displayed.</p> <hr/> <p>Note: The CP650 outputs pink noise at 85dBC for the L, C, and R channels; 82dBC for each of the surround channels; and +10dBr for the subwoofer.</p>
<p>Auditorium Assist L: OK C: OK R: OK LS: X SW: OK RS: OK BSL: OK Amb: OK Bsr: OK</p>	<p>Upon completion, channels are listed with “OK” for pass, or “X” for fail. Any “X” (failure) indication is logged into the event log. (See Section 9.3.3.)</p>

7.14.4 “FAIL” Parameters

Noise Floor

A failure is indicated if a new auditorium noise floor measurement differs from the saved reference measurement by more than ± 10 dB. The measurement is taken at a bandwidth between 20 Hz and 16 kHz.

The noise level in the auditorium is an important part of any theatre environment. This test is designed to measure the room noise, and to determine if it has changed significantly. The CP650 mutes, and a comparison is made between the noise received by the microphone and the stored reference reading. If this comparison fails, the following message is inserted into the event log:

“Aud Noise xx dBr”

Where xx dB is the number of decibels over or under the stored reference noise reading. If the auditorium noise is more than ± 10 dB from the reference level, then the frequency tests do not occur.

Level and Frequency Response

A failure is indicated if a new frequency response measurement of any channel (L, C, R, Ls, Rs, Bsl, or Bsr) differs from the saved reference measurements by more than ± 3 dB. The measurement is taken in the region between 200 Hz and 5 kHz.

A failure is indicated in the subwoofer channel if the frequency response deviates by more than ± 5 dB from the reference reading, in the region between 60 and 100 Hz. A change in the sound level from a speaker can be caused by many factors, including:

- Power amplifier gain has been changed, or the amplifier has failed
- Crossover has been changed or has failed
- Speaker has been changed, has failed, an element has an open circuit, etc.

If the comparison fails any of the frequency response/level tests, a message is inserted into the event log. For example:

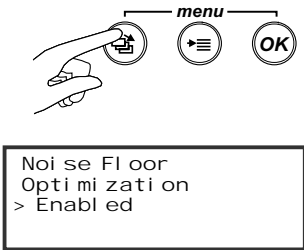

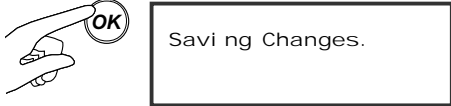
“R FAIL MH”

The “R” indicates the Right channel. An “L,” “M,” or “H” represents low-, mid-, and high-frequency regions. L frequencies are below 315 Hz, M frequencies are between 315 Hz and 2 kHz, and H frequencies are above 2 kHz. If more than one channel failed the test, multiple events are added to the event log.

7.15 Noise Floor Optimization

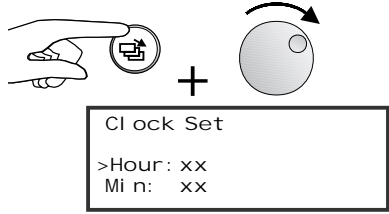
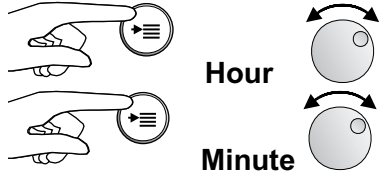
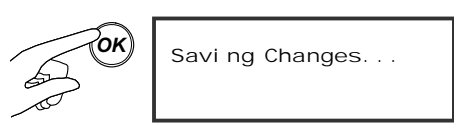
The Noise Floor Optimization feature provides improved dynamic range in certain specialized installations. It works by adjusting for any unused headroom in the B-chain EQ, lowering the noise floor by that amount.

Note: When Noise Floor Optimization is enabled, a fader setting other than 7 can cause signal clipping.

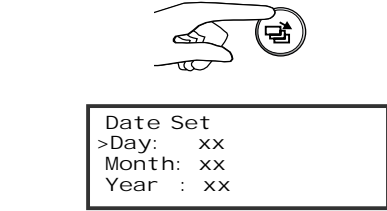
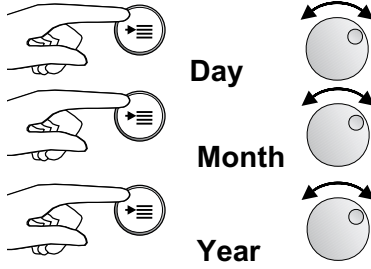

	<p>Press the left menu button to move to the Noise Floor Optimization screen.</p> <p>The Noise Floor Optimization feature can be previewed by enabling and disabling it before saving.</p>
	<p>Rotating the front-panel knob will switch the selection between Enabled and Disabled.</p> <p>Note: The default setting is Disabled.</p>
	<p>Press the OK menu button to save the setting.</p>

7.16 Clock Set

The clock is used only to “time-stamp” event log messages to aid in troubleshooting. The CP650 will operate perfectly without setting the clock.




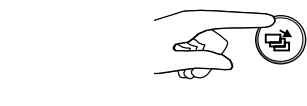
	<p>Press the left menu button, or press and hold the button while rotating the front-panel knob to move to the Clock Set menu.</p>
	<p>Press the middle menu button to choose between setting Hour and Minute. Rotate the front-panel knob to set the times.</p>
	<p>Press the OK button to save the settings.</p>

7.17 Date Set

	<p>Press the left menu button to move to the Date Set menu.</p>
	<p>Press the middle menu button to choose between setting the Day, Month, or Year. Rotate the front-panel knob to make the settings.</p>
	<p>Press the OK button to save the settings.</p>

7.18 Mute Fade Time Adjustment

The mute speed is the length of time it takes for the sound to fade from the normal setting to muted after the **Mute** button is pressed, and the time it takes to fade back to normal after the **Mute** button is pressed again. Both times are independently adjustable.

	<p>Slide DIP switch 6 to the normal (down) position. The CP650 will switch to normal operation with the user's menu choices available.</p>
	<p>Press the left menu button multiple times to move to the Mute Fade-in Time screen.</p> <p>Set the desired fade in time using the front-panel knob.</p>
	<p>Press the OK button to save the settings.</p>
	<p>Press the left menu button to set the mute fade-out time using the same procedure.</p>

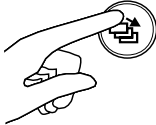
Chapter 8 Accessories

8.1 Introduction

This chapter covers installation of the Cat. No. 779 Remote Control and the Cat. No. 771 Remote Fader. Before installing remote units, read these general considerations:

- No more than three remote units (in any combination) may be used with a CP650. A customer-supplied auditorium fader can be connected in addition to the remotes, but it cannot be operated at the same time as any remote.
- The combined length of connecting cable to all the remote units should not exceed 100 m (300 ft).
- When you connect one or more remote units to the CP650, all units are live and communicate with each other. Any fader level adjustment changes the display on all of the connected units.

Before installing any remote units, check the software version running in your CP650:

	<p>Press the left menu button multiple times to step through the menus to About this CP650.</p> <hr/> <p>Note: You can also press and hold the left menu button while rotating the front-panel fader knob clockwise to step through the menu items.</p>
<div style="border: 1px solid black; padding: 5px; width: fit-content;"> <p>About this CP650: System v. a. b. c. d Cat. No. xyz installed Cat. No. xyz installed</p> </div>	<p>About this CP650 is made up of three menu screens. The first information screen displays the version number of the installed system control software, and lists any optional circuit boards installed in your unit.</p> <p>The version number must be 1.1.5.0 or later. If it is not, obtain a software upgrade before proceeding with installation. Press the illuminated format button to return the CP650 to normal operation.</p>

8.2 Cat. No. 779 Remote Control Installation

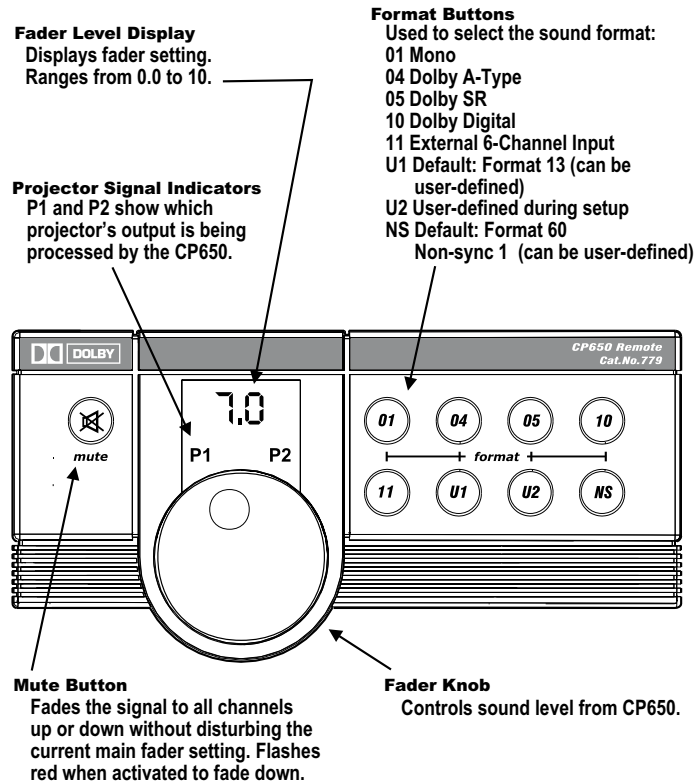


Figure 8–1 Cat. No. 779 Remote Control Functions

8.2.1 Remove the Housing

1. Hold the plastic front-panel firmly with both hands on either side of the unit, and pull one side. The front-panel snaps away from the circuit board and housing.
2. Remove the four screws that fasten the circuit board to the housing and store them nearby.
3. Remove the housing from the circuit board.

Caution: Do not touch circuit-board components. Static electricity can damage components.

8.2.2 Make a Hole for the Interface Cable

Use a two-conductor shielded cable (Belden 8451 or equivalent) to connect the remote to the CP650. To prevent wear on the cable from the metal edge of the hole you create, use a rubber or neoprene grommet on the cable. The diameter of the hole you make should be the same as the diameter of the cable grommet or conduit bushing.

The wire to the CP650 must run from the connection point on the circuit board without touching any circuit-board components.

- If the remote control will be mounted in a console or on a wall, we recommend placing the hole in the bottom of the housing.
- If the remote control will stand alone, we recommend placing the hole in the side of the housing.
- If you must put the hole in the top of the housing, place the hole in either of the locations shown in Figure 8-2 to ensure that the wire has sufficient clearance.

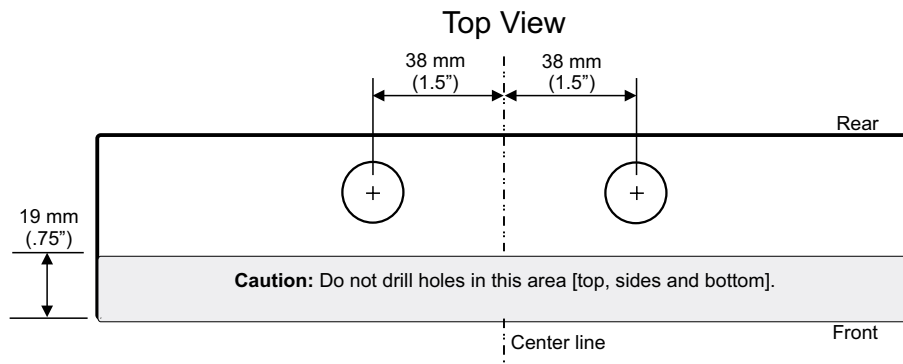


Figure 8–2 Location to Drill Wiring Hole

Caution: Do not drill in the front one-third of the housing (the shaded area in the figure) on any side, or the circuit board will obstruct the opening.

8.2.3 Connect to the Circuit Board

Thread the interface wire through the hole you made. The J1 interface connector is in the upper left-hand corner of the circuit board. Connect the wire to the J1 interface connector as shown below.

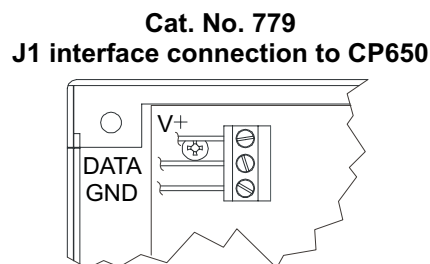


Figure 8–3 Remote-Control Circuit-Board Connector

8.2.4 Set the Address Switch

For the CP650 to communicate with all the remote units, each unit must be set to a unique address number using switch SW1.

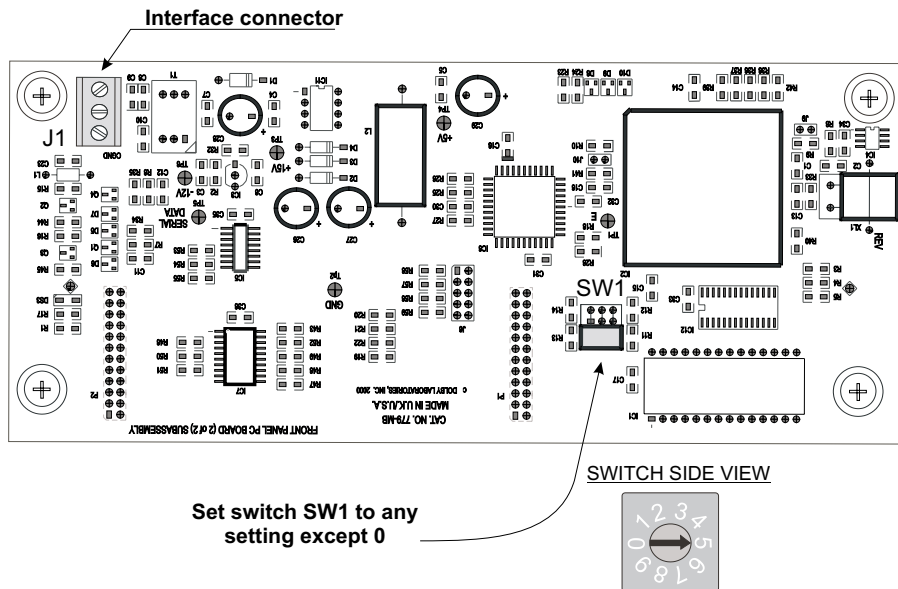


Figure 8–4 SW1 Address Switch Location

Use a small flat-blade screwdriver to set switch SW1. **Do not set the arrow to the “0” position**, because that setting generates an error message and disables the unit. It is not important what address number any single unit is set to, but no two remote units can be set to the same number, so record what number you assign for each unit. If your installation has only one remote unit right now, it is still a good idea to record the setting in case you add another remote later. The CP650 will display the address number assigned to each remote control via the Remote Addresses user menu.

8.2.5 Assemble the Unit

If the remote control is to be mounted on a wall or in a console, mount it before reattaching the circuit board to the housing. The housing has pre-cut holes in the back panel for easy mounting.

1. Carefully pull the interface cable through the hole you drilled in the housing as you bring the circuit board into position.

Caution: Keep the cable clear of all circuit-board components as you pull.

2. Secure the four circuit-board screws you removed earlier.
3. Snap the front-panel back into place. The remote control will be ready to use as soon as you connect the interface cable to the CP650, as described in the following section.

8.2.6 Connect to the CP650

1. Connect the interface wires to the six-way connector shown in the figure below. If you cannot locate the connector, you can order one (Part No. 70206) from Dolby Laboratories.

Note: All remote units attach to the same terminals on the connector. Do not connect wires from any Dolby remote unit to terminal 4, 5, or 6.

2. Plug the connector into the **Remotes and Aud Fader** input on the CP650 rear panel.

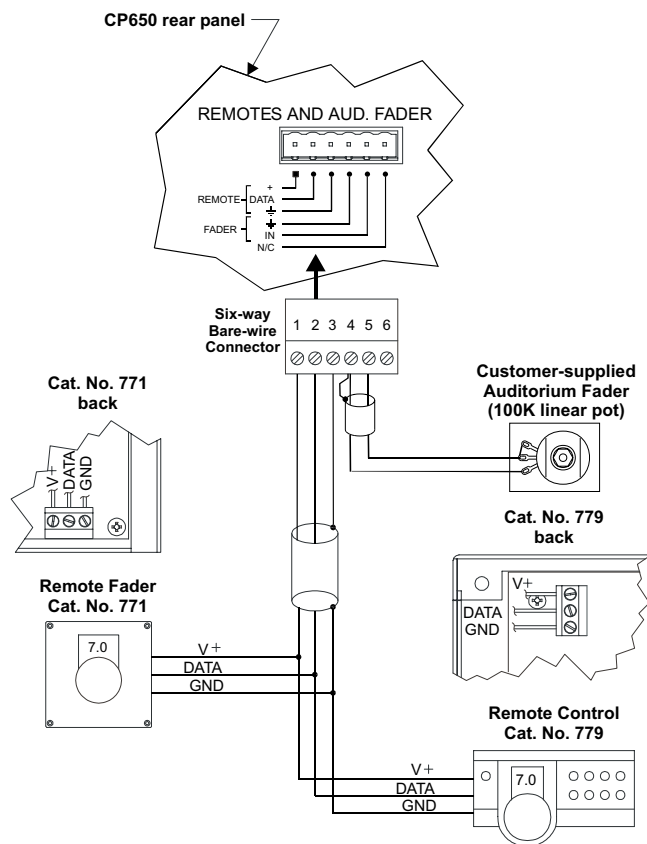
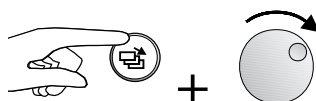


Figure 8–5 Connection of Remotes to the CP650

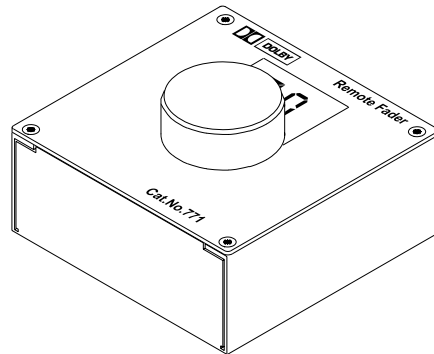
You can confirm that remote units are connected and communicating with the CP650 by selecting the Remote Addresses menu on the CP650.



Press the left menu button multiple times, or press **and hold** the button while rotating the front-panel knob to move the display to the **Remote Addresses** menu.

The single-digit address of each connected remote unit is displayed.

8.3 Cat. No. 771 Remote Fader Installation



The Cat. No. 771 Remote Fader can be mounted on a wall or in a console, or can stand alone.

To install the remote fader:

1. Remove the four screws from the corners of the front-panel. Store the screws nearby and remove the rear housing.

Caution: Do not touch circuit-board components. Static electricity can damage components.

2. Make a hole in the housing for the interface wire. We recommend you place the hole on the bottom if the remote fader will be mounted, or on a side if the fader will stand alone.
3. Use a two-conductor shielded cable (Belden 8451 or equivalent) to connect the remote to the CP650. To prevent wear on the cable from the metal edge of the hole you create, use a rubber or neoprene grommet on the cable. The diameter of the hole you make should be the same as the diameter of the cable grommet or conduit bushing.
4. Thread the interface wire and attach the +voltage, data, and ground wires to the interface connector as shown in Figure 8-3.
5. Use a small flatblade screwdriver to set address switch SW2. **Do not set the arrow to the “0” position**, because that setting generates an error message and disables the unit. It is not important what number any single unit is set to, but no two remote units can be set to the same number, so record what address you set for each unit. If your installation includes only one remote unit right now, it is still a good idea to record the setting in case you add another remote later.
6. Replace the housing, pulling the interface cable tight enough to keep it from touching any components on the circuit board.
7. Secure the front-panel to the housing with the screws you removed in Step 1.
8. Connect the interface cable to the CP650 as shown in Figure 8-5.

Chapter 9

Maintenance and Troubleshooting

9.1 Print Cleanliness

As with any soundtrack, keeping the film print clean will give best performance. The Dolby® Digital print format has robust error correction information encoded along with the audio data, and the CP650 uses a powerful digital error-correction technique, allowing the data to be read perfectly even if scratches and dirt are present. However, best performance will be obtained if the print is kept clean. Standard film cleaners will provide good results.

The sound quality of the digital track has properties unlike those of an analog track with regard to print wear. With any analog track, print wear will degrade quality in a more or less linear fashion; the more wear, the lower the quality of the sound. With a digital soundtrack, wear will have no audible effect until the picture quality is degraded beyond use. At this point, wear may exceed the error correction capabilities of the Dolby Digital decoder, and the CP650 will automatically switch to the analog Dolby SR track.

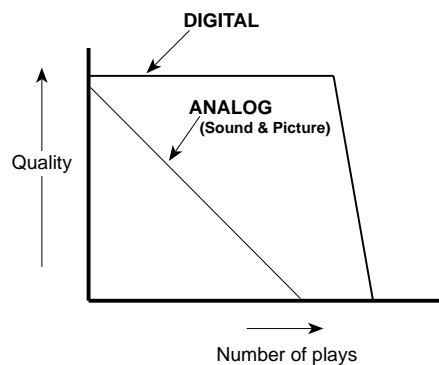


Figure 9-1 Digital/Analog Track Wear

9.2 Digital Soundhead Maintenance

The digital soundhead should be kept clean and free of dust and dirt for best performance, just like the analog soundhead. Wiping the external surfaces with a clean cloth on a regular basis will keep the head looking new. The optical path should be inspected regularly and kept clean with a photographer's lens cleaning kit (available from most camera stores). Use care not to scratch the lens. The film path (rollers and drum) should be cleaned regularly, as you would on the projector. Acetone, carbon tetrachloride, and other dangerous cleaners **should not be used**.

9.2.1 Replacing the Cat. No. 701 Digital Soundhead LED Assembly

In normal operation, the LED assembly used in the Cat. No. 701 Digital Soundhead will exhibit gradually reduced light output over its life. If it becomes necessary to replace the LED, follow the procedure outlined below. The LED assembly is Dolby Part No. 83308.

Installation

1. Turn off power to the Cat. No. 701 soundhead.
2. Remove the two screws that mount the LED assembly to the arm.
3. Carefully pull the LED assembly off the pivot pin.

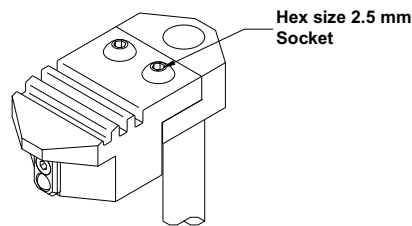


Figure 9-2 LED Assembly Mounting Screws

4. Carefully turn over the assembly and loosen the two screw terminals, and remove the wires. Note the wire colors and terminal locations.

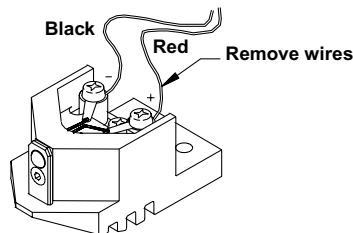


Figure 9-3 LED Assembly Wiring

5. Attach the wires to the replacement LED assembly using the same wire locations as in the original LED assembly. The wires may require restripping since they have been compressed previously, and could be too weak. Inspect the wires carefully before attaching them to the terminals.
6. Remount the LED assembly onto the pivot pin. Initial adjustment can be made by tightening the screws slightly with a parallel gap between the rear of the LED assembly and the facing edge of the arm. Using a sheet of paper will usually provide the proper clearance.

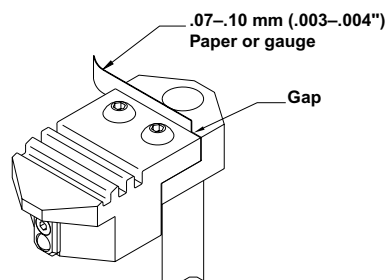


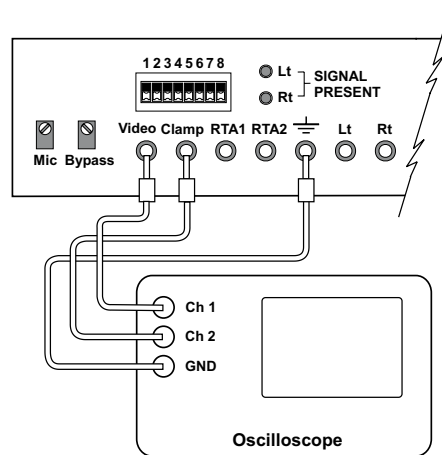
Figure 9-4 LED Assembly Initial Gap Setting

Alignment



Warning: Class 2 LED Product per EN 60825-1:1996. Do not stare into the red LED beam. Do not attempt to view the LED beam with any type of optical device.

1. Connect an oscilloscope (20 MHz minimum bandwidth) to test points on the setup control panel. Some digital oscilloscopes may not be usable for this procedure even though they may have the required bandwidth.
 - a. Ensure that the probes are 1X and connect scope Channel 1 to the “Video” test point. Connect only this probe's ground to the ground test point.
 - b. Connect scope Channel 2 to the “Clamp” test point.



- c. Set both channel vertical input sensitivity controls to 1 V/div, DC coupling. Set the vernier to calibrated (usually the inner knob—rotate until it “clicks”).
 - d. Set horizontal sweep rate to 2 μ s/div.
 - e. Set the trigger source to Channel 2 and positive polarity.
 - f. Turn on power to the digital soundhead and the CP650.
2. Set the oscilloscope display.
 - a. Thread and play a Cat. No. 69T Dolby tone test film loop.
 - b. Display only Channel 2, and adjust trigger level to lock onto the clamp signal.
 - c. Adjust horizontal position to line up inside edge of left clamp signal with left screen graticule.
 - d. Adjust the timebase sweep vernier to line up the inside edge of right clamp signal with right screen graticule.
 - e. Select Channel 1 display.
 - f. Temporarily switch the scope channel 1 input (video) to GND and adjust the vertical position to coincide with a horizontal screen graticule. This is the 0 V reference baseline.

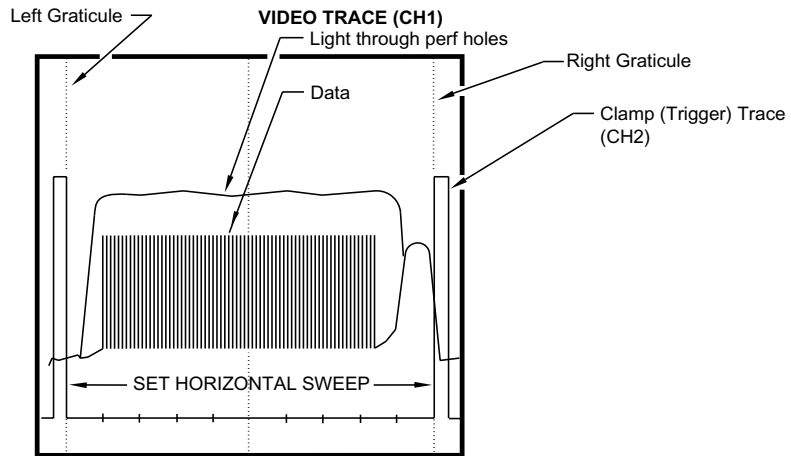


Figure 9-5 Scope Display of CP650 Video Test Point Signal

3. Adjust the LED Position.

- a. Switch the Channel 1 video input coupling back to DC.

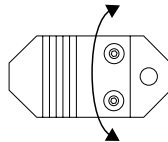


Figure 9-6 Adjust LED Assembly for Optimum Video Signal

- b. Loosen the 2.5 mm hex screws and carefully rotate the LED assembly while watching the scope image. Adjust for maximum video signal voltage (unobstructed light through the perf hole) on the **upper trace**. Also, the waveform must be reasonably flat. (It should fit within one scope major division.) In other words, adjust for peak voltage with minimum ripple.

4. Check/Set LED drive current.

The optimum peak video signal voltage (unobstructed light through the perf hole) is **4 V**, measured from the 0V reference baseline to the **upper trace**. If necessary, adjust the Cat. No. 701 power supply output to achieve the correct video voltage. See the Figure 9-7 for adjustment location (VR1). The back cover of the digital soundhead must be removed to gain access to the output adjustment.

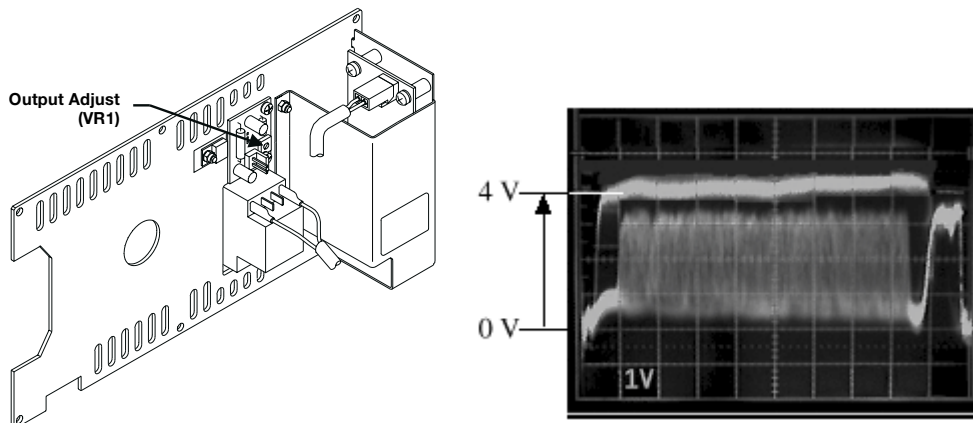


Figure 9-7 LED Drive Current Setting

9.2.2 Replacing the Cat. No. 700 Digital Soundhead Exciter Lamp

To replace the exciter lamp, carefully remove the six screws holding the rear cover/power supply of the digital soundhead. Allow the lamp to cool if necessary. With the rear cover removed, the lamp will be visible but still attached to the rear cover assembly by its two supply wires. Slide the lamp out of its base. Carefully remove a new lamp from the protective box, and using gloves or a clean, lint-free cloth, replace the lamp in the socket. Be careful not to touch the bulb or inner surface of the reflector in the lamp. If either is accidentally touched, carefully clean the area with isopropyl alcohol when the bulb is cool. Slide the lamp back into its base in the soundhead, replace the rear cover assembly, and tighten the six screws.

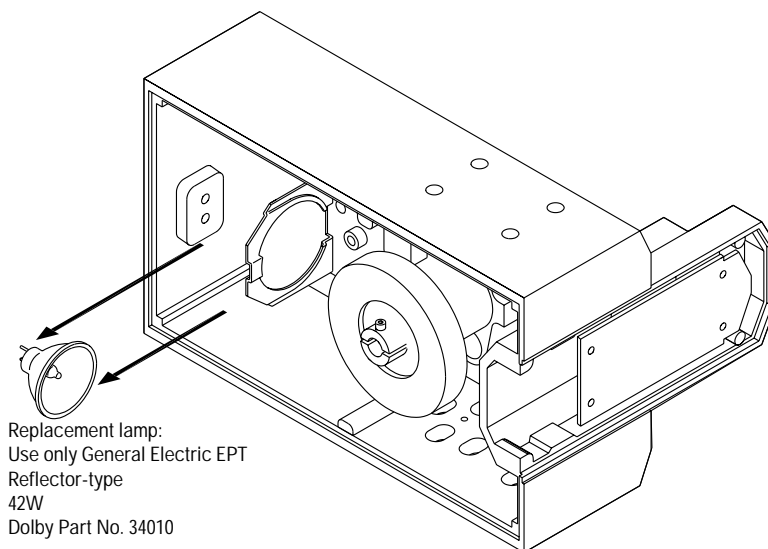


Figure 9–8 Digital Soundhead Exciter Lamp Replacement

9.3 CP650 Troubleshooting

9.3.1 Power Supply Voltage Ranges

Six test points are located on the front subpanel for measuring power supply voltages. They can be accessed by removing the front panel.

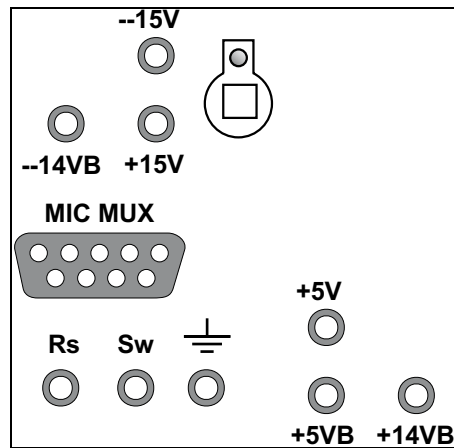


Figure 9–9 Power Supply Voltage Test Points

Table 9–1 Main Power Supply Voltage Ranges

Test Point	Voltage Range
+15 V	14.5 to 15.8
–15 V	–14.5 to –15.8
+5 V	4.85 to 5.15

Table 9–2 Bypass Power Supply Voltage Ranges

Test Point	Voltage Range	
	Main AND Bypass Supplies On	ONLY Bypass Supply On
+14 VB	13.9 to 15.2	11.0 to 12.5
–14 VB	–13.9 to –15.2	–11.0 to –12.5
+5 VB	4.6 to 5.0	4.6 to 5.0

9.3.2 Exploded View and Board Locations

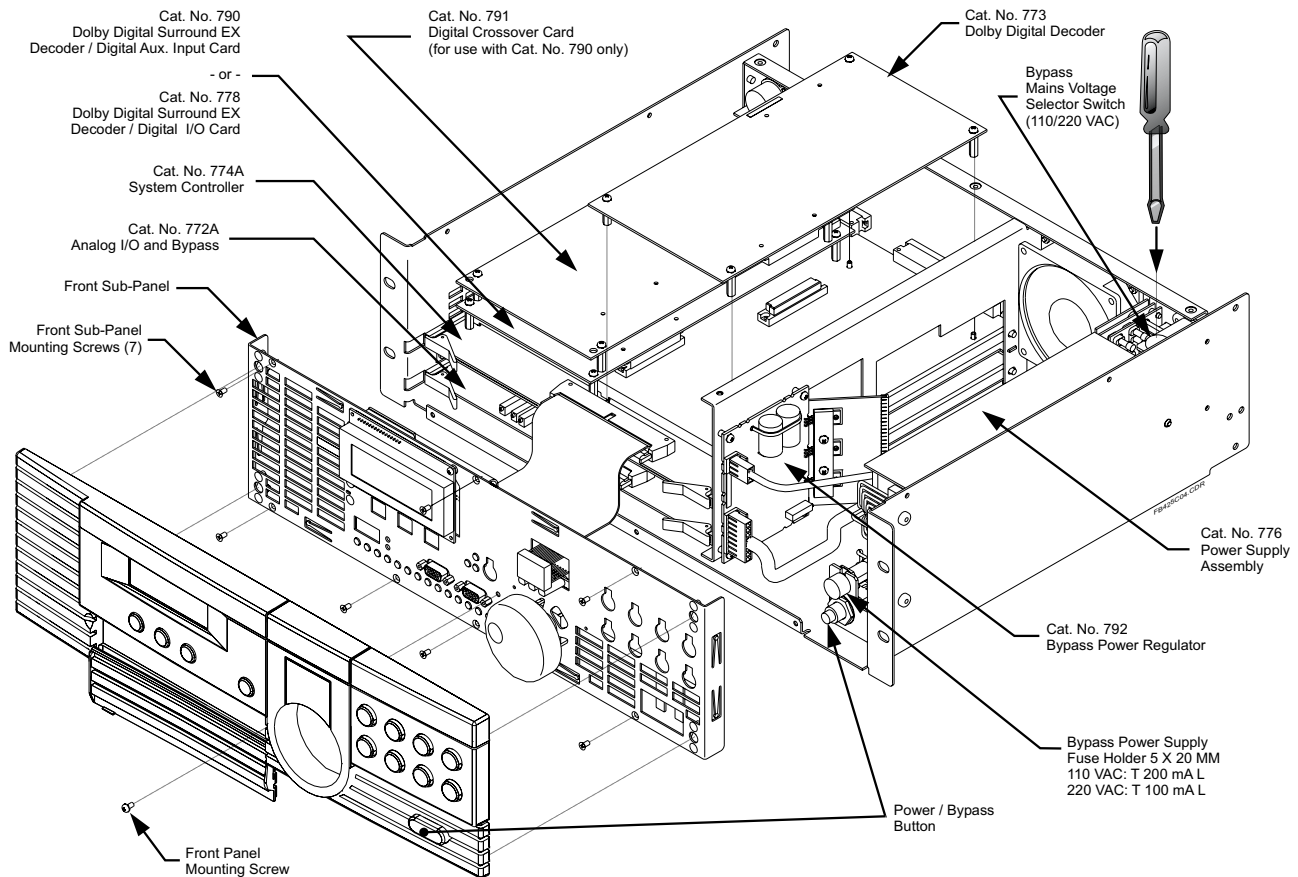


Figure 9–10 Model CP650 Exploded View

Caution: Many components used on the circuit boards are sensitive to electrostatic damage. It is essential to wear an earthing strap while handling or changing CP650 circuit boards.

To gain access to the CP650 circuit boards:

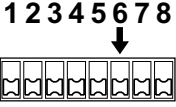
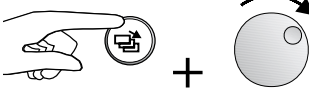
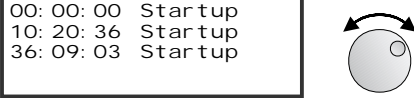
1. Remove the AC mains power cable.
2. Open the setup control-panel access door.
3. Remove the front-panel mounting screw located in the upper right-hand corner of the setup control panel and carefully pull the front-panel toward you to remove it.
4. Remove the seven front subpanel mounting screws, and carefully pull the subpanel toward you to remove it.
5. Unplug the two ribbon cables connected to the internal circuit boards.

The power supply assembly can be removed by loosening the two finger screws on the front edge of the assembly and the two rear-panel screws above and below the AC mains connector. From the front of the unit, carefully remove the connector at the backplane along with the two front connectors, then slide the assembly out.

9.3.3 The Event Log

The event log stores entries on the operation of the CP650. It can be useful in troubleshooting or tracking subtle system failures. Also, Auditorium Assist "fail" parameters are stored in the event log. (See Section 7.14.4.) Normally, a single log entry occurs every time the CP650 powers on. When viewing the event log display, the newest entries appear at the top; turn the front-panel knob to scroll through the list.

To view the event log:

	<p>The event log is a User Menu item (Ensure that DIP switch 6 is in the normal (down) position).</p>
	<p>Press the left menu button multiple times, or press and hold the button while rotating the front-panel knob to move the display to the Event Log menu.</p>
	<p>Scroll through the event log using the front-panel knob.</p>
<p>Note: If film is running during CP650 power-up, you may see erroneous information entered into the even log. The power-up self-test software applies test signals to the optical input circuits. If film is playing, the test signals are mixed with film sound, producing unpredictable test results.</p>	

9.3.4 Troubleshooting Chart

The following chart may assist you in solving problems.

Symptom	Probable Cause	Recommended Action
NO SOUND AT ALL		
<p>No sound, front-panel dark, power button not glowing.</p>	<p>No power to either main or bypass systems.</p>	<p>See if AC mains panel circuit breaker feeding the CP650 is tripped. Verify that all power connectors are fully inserted into their sockets.</p> <p>Press main power button. If CP650 still does not come on, check fuse behind plastic door in AC mains power inlet module located on the rear of the unit.</p>
<p>No sound, and switching to Bypass doesn't restore sound.</p> <p>OR</p>	<p>Defective analog reader LED, exciter lamp, or LED/lamp power supply.</p>	<p>Check that the LED or exciter lamp is on. If not, fade up background music, transfer the reel to the alternative projector and continue the show until the LED/lamp or its power supply can be replaced. Call service engineer.</p>
<p>No sound, front-panel dark, power button is illuminated, and system is already in Bypass.</p>	<p>Projector selection wire/switch is faulty.</p>	<p>If the front-panel indication (<i>P1</i>, <i>P2</i>) for the currently active projector is not correct, check the projector selector switch wiring. In addition, check that the switch or relay is operating properly.</p>
	<p>No signals coming from stereo solar cells.</p>	<p>Check that the signal-presence LEDs inside the setup panel access door are flashing while film is running. If not, there is no signal from the solar cells, or the Cat. No. 772 analog board has failed. Substitute a known, working Cat. No. 772 board.</p>
	<p>Power amplifiers switched off.</p>	<p>Check power feed to power amplifiers for blown circuit breaker or fuse or accidental disconnection.</p>
<p>No sound, front-panel normal.</p>	<p>Check the causes listed above, plus wrong format selected, system muted, or fader turned down.</p>	<p>Check same components as mentioned above. Then verify selected format, mute status, and fader setting. If no formats produce sound, there may be a CP650 internal problem. Call your local service engineer.</p>

Symptom	Probable Cause	Recommended Action
NO SOUND IN SOME FORMATS		
No analog film sound (Formats 01,04, or 05). Front-panel normal, Dolby Digital sound OK, and nonsync OK.	<p>The analog LED or exciter lamp or power supply may have failed or the wrong projector may be selected.</p> <p>Solar cell connections may be loose or damaged.</p> <p>The remote solar cell preamp board used with LED analog readers may have failed.</p>	<p>If the signal-presence LEDs inside the access door are not flashing, verify exciter operation and solar cell connections as described above. Substitute known working Cat. No. 772 board.</p>
No Dolby Digital sound (Format 10). Front-panel normal, analog sound OK.	<p>Digital reader LED not working, Dolby Digital decoder board Cat. No. 773 not installed or not working, non-Dolby Digital print being played, film not threaded correctly in reader, reader failure.</p>	<p>Verify that the LED (or exciter lamp) in the digital film reader is on. Verify that the print you are playing is correctly threaded through the digital reader and that it includes Dolby Digital information. If the CP650 accepts a Format 10 command, the digital sub-system is probably still working.</p>
No sound on external six-track input (Format 11, 70 mm, external Dolby model DA20, or other multichannel sound sources), Front-panel normal.	<p>Cat No. 772 board defective. Wrong format, external device not receiving good data. Six-channel input connector not fully plugged in.</p>	<p>Check external device for audio output. Re-seat the six-channel connector.</p>
No sound in nonsync	<p>Nonsync source not working, nonsync level set too far down, faulty Cat. No. 772 board. If nonsync is a user format, is the input from Nonsync 1 or Nonsync 2? Which channels are the signals being sent to? Are those power amplifiers working?</p>	<p>Verify output of nonsync source. Determine from front-panel display which channels the output is directed to and verify that power amplifiers and speakers for those channels are working. After checking the above, adjust nonsync level in setup, changing both left and right channels by equal amounts.</p>
Power button illuminated. Front-panel dark. There is sound.	<p>System is in bypass mode.</p>	<p>Turn on the CP650 with the front-panel power button. Call service engineer if the system is still not operating correctly.</p>

Symptom	Probable Cause	Recommended Action
FADER PROBLEMS		
Front-panel fader knob has no effect.	External analog remote fader pot selected.	Select front-panel (“local”) fader by pressing the left menu button to show the Fader Setting menu, then turning the front-panel knob to display “Local”. Press the OK button. This will restore control to the main front-panel fader and any digital remotes that are connected.
Fader level display changes when no change of CP650 front-panel fader has been made.	A remote digital fader is being operated. A format with a different fader setting was selected. Analog remote fader is selected and being changed.	Note: Digital remote faders are always active. Disconnect the remote to disable it.
CONTROL PROBLEMS		
CP650 won't accept a format selection, and displays a “Format Unavailable” message.	CP650 doesn't have the optional modules needed for that format, or that part of the system is not working. For example: Format 10 requires the Dolby Digital Cat. No. 773 board. Formats 13, 80, or 81 require the Cat. No. 790 or 794 Dolby Digital Surround EX board, or Cat. No. 778 Digital I/O board. Digital reader LED not working, non-Dolby Digital print being played, film not threaded correctly in reader, reader failure.	Obtain and install the necessary circuit boards. If they are already present, ensure that they are firmly seated in their connectors. Verify that the LED (or exciter lamp) in the digital film reader is on. Verify that the print you are playing is correctly threaded through the digital reader and that it includes Dolby Digital information. If the CP650 accepts a Format 10 command, the digital sub-system is probably still working.
Front-panel display reads “ Reverted! ” when Format 10 is selected and stays in optical Dolby SR.	No Dolby Digital data available, not a Dolby Digital print, projector not running, or data blocks badly damaged.	Review each possible cause.

Symptom	Probable Cause	Recommended Action
RUMBLES, WHISTLES, HUM IN SOUND		
Rumble in sound, regardless of format.	Audio grounding scheme may need changing.	Call service engineer.
Whistles in sound.	Audio grounding scheme may need changing.	Call service engineer.
Hum (power line frequency) in sound.	Malfunctioning exciter lamp or lamp power supply. Stray light striking the stereo solar cells.	Cover the solar cells with a business card or other opaque object. Do NOT touch the cells and do NOT disturb the position of the cell bracket! <ul style="list-style-type: none"> • If the hum disappears, the problem is in the exciter lamp. • If hum persists, turn out all lights in the booth to check if stray light is striking the cells. If the hum disappears, turn on booth lights that are usually on during projection, one at a time, until you detect hum again. Redirect the light from the offending source or keep it off during a showing. If the hum still is present, the problem is either in the grounding or wiring or in the CP650. Call your service engineer.

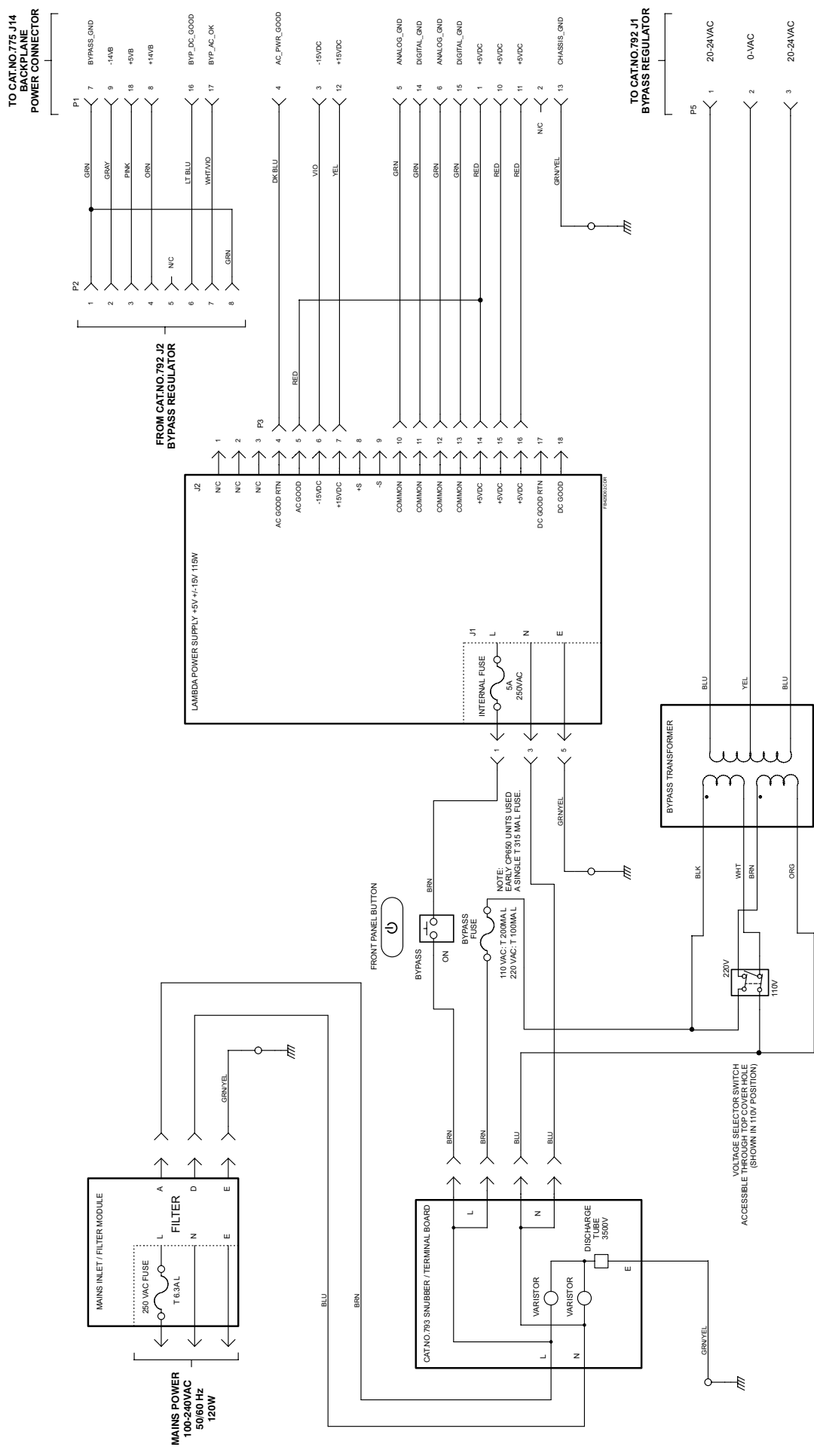
Symptom	Probable Cause	Recommended Action
TROUBLE IN ONE OR MORE CHANNELS		
One channel fails.	<p>Defective power amplifier, external crossover, or wiring for that channel.</p> <p>Power amplifier input level setting turned down.</p> <p>Malfunctioning board in CP650.</p>	<p>Place the CP650 in bypass. All three screen speakers should become active. If not, there is a fault in the power amplifier, external crossover, or wiring for the missing channel.</p> <p>Check whether the amplifier is on and check for blown fuses.</p> <p>Check that the power amplifier volume control setting has not been changed.</p> <p>Check that the wiring from the CP650 to the amplifier or the loudspeaker wiring has not been broken or disconnected.</p> <p>If the power amplifier and the wiring are satisfactory, the problem may be a malfunctioning circuit in the CP650. Switch to bypass and call service engineer.</p>
The sound from one channel is distorted and you can hear the distortion through the booth monitor at normal listening level.	<p>Defective power amplifier for that channel.</p> <p>Defective speaker for that channel. (The booth sound is OK but sound in the auditorium is bad).</p> <p>Malfunctioning Cat. No. 772 board in CP650.</p> <p>Wiring from the stereo solar cell to the CP650.</p>	<p>Check that the amplifier is on and the fuses are OK.</p> <p>Check speaker.</p> <p>Call service engineer.</p> <p>Check that the wiring from the stereo solar cell to the CP650 has not become damaged and that the solder connections to the fanning strip are secure. Check that the D-connector for the solar cell is firmly plugged into the CP650. Call service engineer if wiring problems are found.</p>

Symptom	Probable Cause	Recommended Action
The sound from two or more channels is distorted and you can hear the distortion through the booth monitor at normal listening level.	Malfunctioning two-channel power amplifier.	If two distorted channels are served by the same two-channel amplifier, the problem may be in the amplifier. See the manufacturer's instructions. Call service engineer.
When a stereo film is projected, the sound appears to be coming from the wrong speakers.	The A-chain has become misaligned.	Check Dolby level calibration. Call service engineer.
Sound from the front (screen) channels is leaking into the surround channel.	The A-chain has become misaligned. Surround sound delay set improperly.	Call service engineer. Call service engineer.
You hear an echo in a small theatre.	Surround sound level set too high.	Call service engineer.
The sound level in bypass is higher or lower than the normal sound level.	Surround sound delay set improperly. Adjust with the front-panel knob, since other parts of the system may be malfunctioning.	Call service engineer. Call service engineer. Call service engineer.

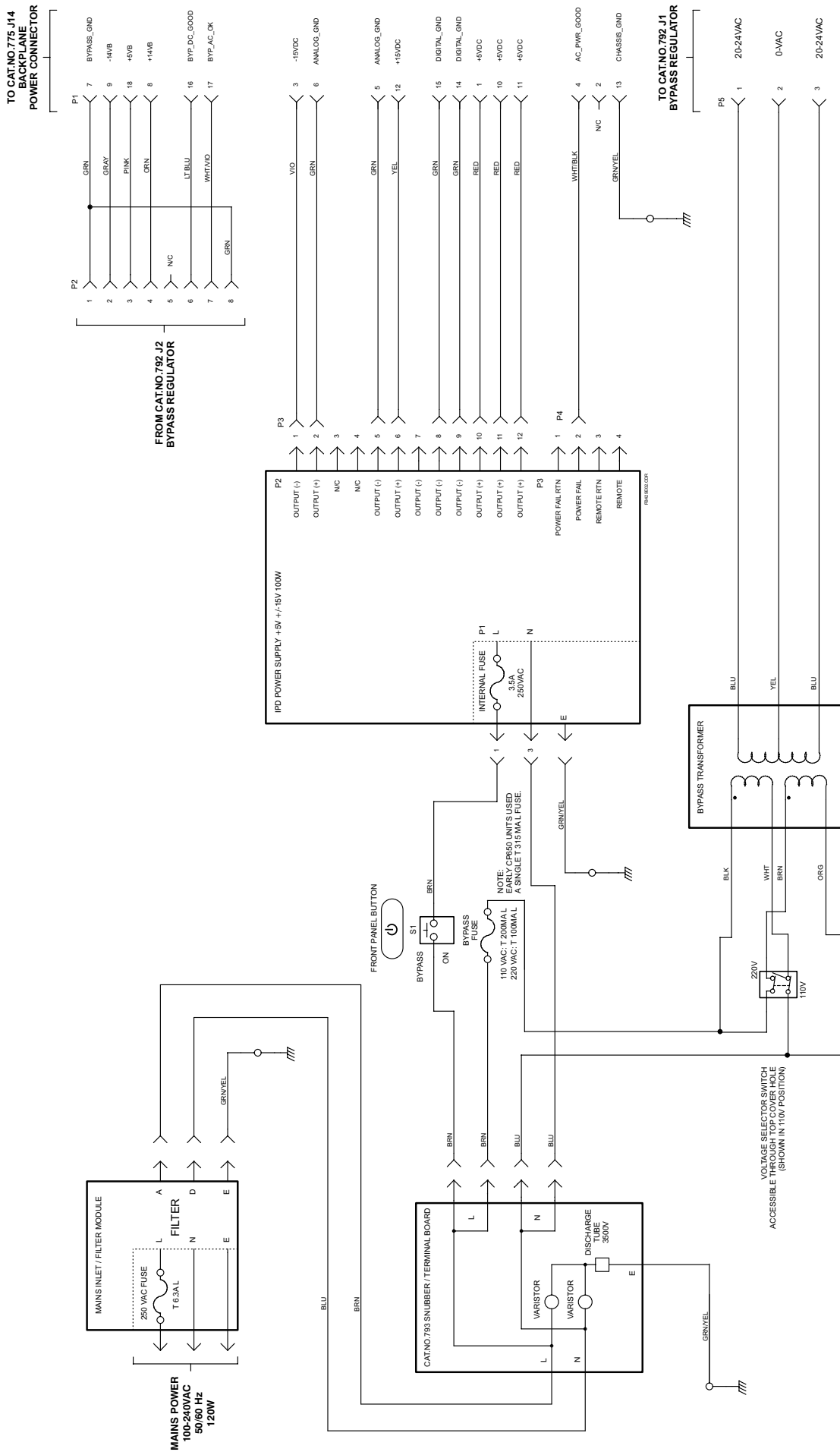
Symptom	Probable Cause	Recommended Action
There is distortion when you play non-sync sound, but sound from the film is not distorted.	The nonsync source is introducing distortion. Excessive output level from nonsync source.	Change the nonsync selection (in case the track being played is distorted). If you have control of the output level of the nonsync device (cassette deck, CD player, etc.), turn down its output level, especially if you have to operate the nonsync with the fader set far below 7. If this does not help, try a different device. If changing both the device and the selection does not eliminate the distortion, the problem is in the CP650, probably on the Cat. No. 772 board.
Nonsync sound is heard in other formats.	Defective Cat. No. 772 board.	Call service engineer.
Sound from a mono film is distorted, as is sound from the center channel of a stereo film.	The nonsync source output level is set far too high or there is a balanced/unbalanced wiring problem. Malfunctioning power amplifier. Malfunctioning loudspeaker.	Turn down nonsync source level if possible and call service engineer. If turning the nonsync source down doesn't correct the problem, turn it off during the show. Interchange power amplifiers to determine if distortion is still present. Interchange speakers to determine if distortion is still present.

Symptom	Probable Cause	Recommended Action
CHANGEOVER AND CONTROL TROUBLES		
<p>Projector changeover command does not change the sound to the output of the selected projector and the front-panel indicators <i>P1</i> or <i>P2</i> do not light according to the projector selected.</p>	<p>Defective changeover relay or switch.</p> <p>Defective wiring from relay or switch to terminals on rear of the CP650.</p> <p>Defective Cat. No. 772 board.</p>	<p>If possible, check that the relay or switch contacts actually open and close as the changeover command is issued several times.</p> <p>Check that the wiring has not been damaged and that connections are firmly made at both ends.</p> <p>Call service engineer.</p>
<p>With an automation system connected to the CP650:</p> <p>The CP650 freezes into one format and does not accept any other selected format when you press the front-panel buttons.</p>	<p>Incorrect wiring to D-connector plugged into CP650; defective or incorrectly programmed automation equipment.</p>	<p>Unplug the D-connector from the back of the CP650. If you can exercise local control over the CP650, the problem is either the wiring to the automation equipment or the automation equipment itself. Call service engineer.</p> <p>If you cannot exercise local control over the CP650 even with the automation equipment disconnected, switch to bypass mode by pressing the front-panel power button, and call service engineer.</p>

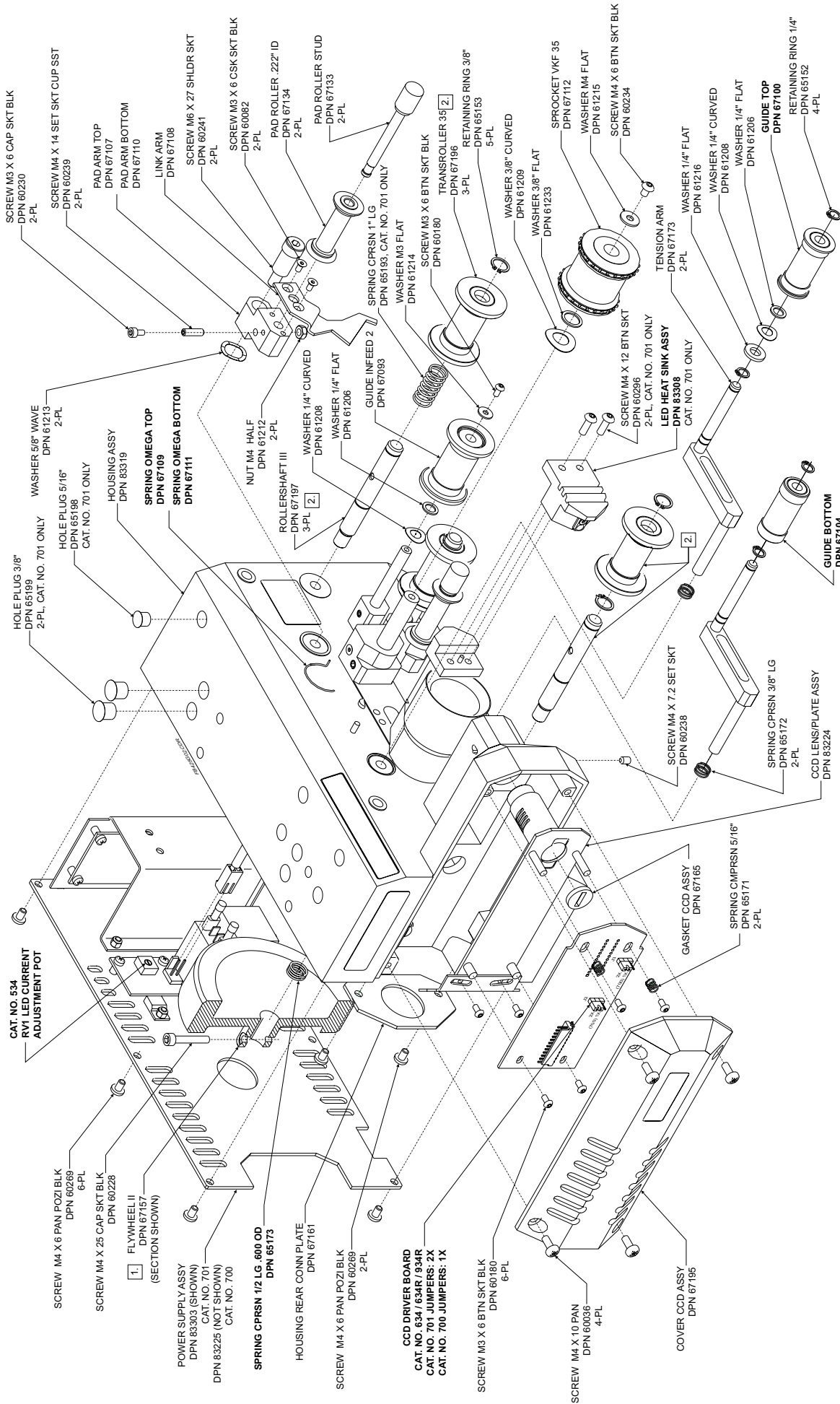
Symptom	Probable Cause	Recommended Action
You can hear pops or thumps during projector changeover.	<p>If the projector changeover relay power is DC, a diode should be soldered across the winding of the relay to prevent switching noise from leaking into the audio wiring. This diode may be missing or defective.</p> <p>If the projector changeover relay is AC powered, a capacitor soldered to the relay coil terminals may be defective.</p> <p>Malfunctioning Cat. No. 772 board.</p>	<p>If possible, check that the diode is installed across the relay winding. If you are familiar with such electronic components, check to see that it is not defective. If the diode is not present or if it appears to be open, install a good diode. Activate the changeover and use a multimeter to find the polarity of DC that appears on the relay coil. Install the diode with the band end soldered to the positive terminal. The diode should be a 1N4004 (1A, 400 V), or 1N4008 (1A, 800 V), or equivalent.</p> <p>Install a 0.01 μF 600 V capacitor across the relay coil terminals.</p> <p>Call service engineer to correct the malfunction.</p>

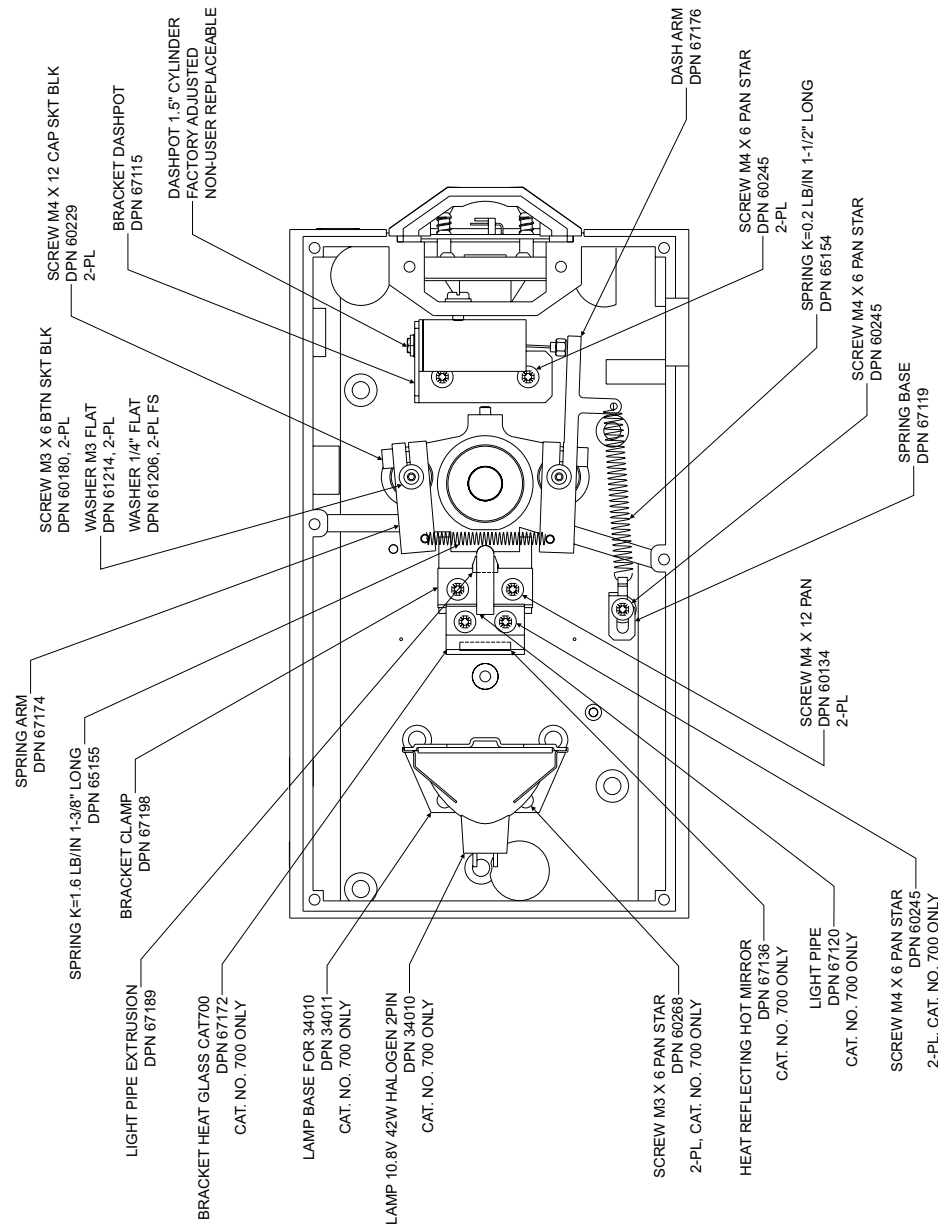
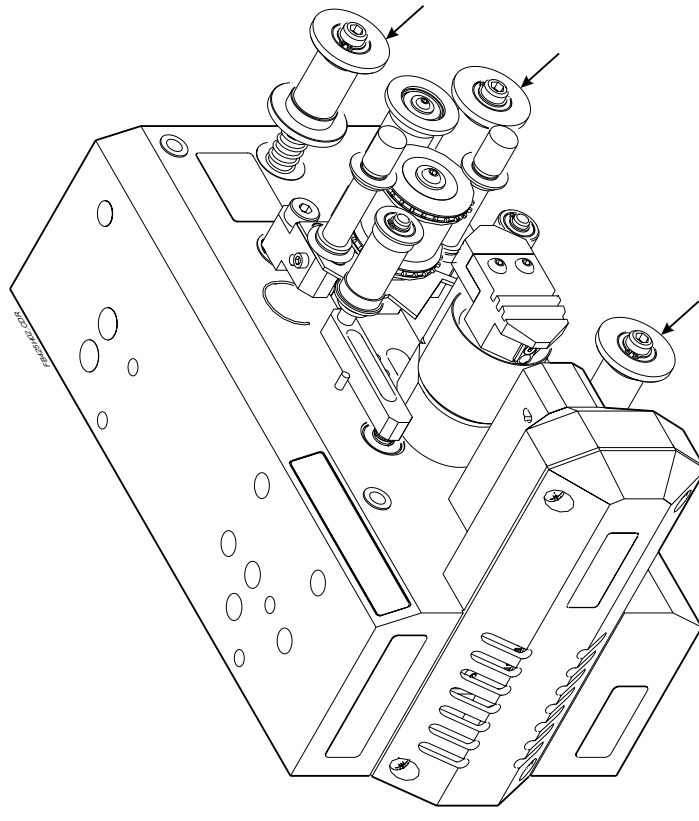


CP650 POWER SUPPLY WIRING
CATNO.776-1 (BLACK COVER)



CP650 POWER SUPPLY WIRING
CAT.NO.776-2 (GOLD COVER)





**CAT. NO. 700/701 REAR VIEW
(POWER SUPPLY ASSEMBLY NOT SHOWN)**

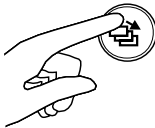
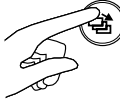


CAT. NO. 701 TRANSROLLER PARTS	
STANDARD 35 MM	OPTIONAL 35/70 MM BYPASS (DPN 83239)
DESCRIPTION	DOLBY PART NUMBER (DPN)
TRANSROLLER	67196
SHAFT	67177
RETAINING CLIP (2)	65153
	67097
	65153

Appendix A

Software Operations

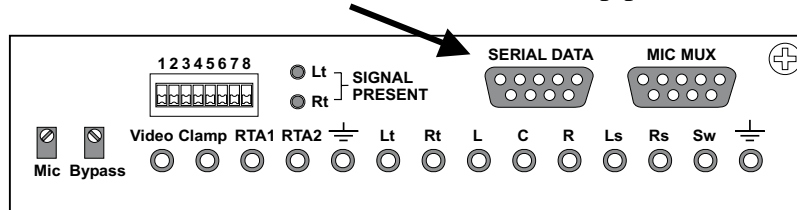
A.1 Display Information About This CP650 Unit

A User Menu item (DIP switch 6 down) provides information about the software and hardware installed in your CP650.

	<p>Press the left menu button multiple times to step through the menus to About This CP650.</p> <hr/> <p>Note: You can also press and hold the left menu button while rotating the front-panel fader knob clockwise to step through the menu items.</p>												
<div data-bbox="422 963 726 1064" style="border: 1px solid black; padding: 5px;"> <p>About this CP650: System v. a. b. c. d Cat. No. xyz installed Cat. No. xyz installed</p> </div>	<p>About This CP650 is made up of three menu screens. Pressing the left menu button cycles the menu display between these three screens.</p> <p>The first information screen displays the version number of the installed system control software, and lists any optional circuit boards installed in your unit.</p>												
 <div data-bbox="478 1220 782 1321" style="border: 1px solid black; padding: 5px;"> <p>About this CP650: Module Version 010101010000</p> </div>	<p>The second information screen displays the version numbers of the various software “modules” running in your unit.</p>												
 <div data-bbox="478 1467 774 1568" style="border: 1px solid black; padding: 5px;"> <p>About this CP650: Hardware Information Network: xxxxxxxx Boards: 4374x</p> </div>	<p>The bottom line on the third information screen displays the version number of each circuit board installed in your unit. The version numbers are listed for each board in the following order:</p> <p>Cat. No. 772A, Cat. No. 773, Cat. No. 774A, Cat. No. 777, Cat. No. 790 (or earlier Cat. No. 794)</p> <p>If an “X” is displayed, the corresponding board is not installed. In the example shown, the following board versions are installed:</p> <table border="0" style="width: 100%;"> <thead> <tr> <th style="text-align: left;">Board</th> <th style="text-align: left;">Version</th> </tr> </thead> <tbody> <tr> <td>Cat. No. 772A</td> <td>4</td> </tr> <tr> <td>Cat. No. 773</td> <td>3</td> </tr> <tr> <td>Cat. No. 774A</td> <td>7</td> </tr> <tr> <td>Cat. No. 777</td> <td>4</td> </tr> <tr> <td>Cat. No. 790 (or earlier Cat. No. 794)</td> <td>Not Installed</td> </tr> </tbody> </table>	Board	Version	Cat. No. 772A	4	Cat. No. 773	3	Cat. No. 774A	7	Cat. No. 777	4	Cat. No. 790 (or earlier Cat. No. 794)	Not Installed
Board	Version												
Cat. No. 772A	4												
Cat. No. 773	3												
Cat. No. 774A	7												
Cat. No. 777	4												
Cat. No. 790 (or earlier Cat. No. 794)	Not Installed												
	<p>Press the illuminated format button to return to normal operation.</p>												

A.2 Updating CP650 Software

1. Connect the PC to the CP650 Cinema processor using a serial cable connected to the CP650 serial data connector on the front setup panel (or on the rear panel).



2. Run the CP650 Setup Software on the PC.
3. From the “Action” menu, choose “Connect”, or click on the connect icon.
4. If prompted, choose to “Retrieve” cinema processor settings.
5. From the “Action” menu, choose “Update Software...”.
6. If desired, you may save the newly retrieved settings to disk.
7. Browse for and select the software update file (.bin) to be used for updating the CP650.
8. Select “Update Now”.

Note: This process should not be interrupted. If the connection is lost during the update process, the CP650 displays:

Update Failed!
Reconnect and update
Software to proceed.

If this occurs, you must reconnect the CP650 Setup Software and restart the software update process. If the software update is not completed successfully before the CP650 main power is turned off, the CP650 will become inoperable and the Cat. No. 797 flash memory module must be replaced.

9. When the update has finished, the CP650 will automatically restart.
10. Next, the CP650 Setup Software will automatically reconnect, send the cinema processor settings back, and remain connected.

The update process is now complete. The CP650 will contain updated software while retaining your original alignment settings.

A.3 Transferring Settings Between Two CP650s

1. Connect the PC to the source CP650 using a serial cable.
2. Run the CP650 PC Setup Software on the PC.
3. From the “Action” menu, choose “Connect” or click on the connect icon.
4. If prompted, choose “Retrieve” to retrieve existing cinema processor settings.
5. After the settings have been retrieved, choose “Disconnect” from the “Action” menu, or click on the disconnect icon.
6. From the “File” menu choose “Save”, or click on the save icon.
7. Save the retrieved settings to disk. The file name should end with the “.dby” extension.
8. Unplug the serial cable from the source CP650 and plug it into the destination CP650.

Note: If you have closed the CP650 Setup program or opened another settings parameter file (.dby), then before continuing, you must select “Open” from the “File” menu and open the file that was saved in step 6 above.

9. Repeat steps 1 through 3.
10. When prompted, select “Send Settings”.
11. The saved settings will be sent to the destination CP650.
12. You must select “Disconnect” from the “Action” menu (or click the disconnect icon) to allow the settings to be saved in the destination CP650.

Note: Only the settings that appear in the CP650 Setup program are transferred during this process.

Appendix B

Back Panel Connectors

B.1 Output Connectors

Main Audio Output Connector

The main audio outputs of the CP650 are sourced from balanced output circuits. The connector type and pin configuration conform to the THX® standard. With a Cat. No. 790 Dolby® Digital Surround EX™ decoder board installed (standard Model CP650), the Left Surround and Right Surround outputs on this connector are disabled. All surround channel audio outputs appear on the Option Card I/O connector.

Table B-1 Main Audio Output Connector Pinout

Pin	Connection
1	Chassis
2	Left +
3	n.c.
4	Chassis
5	Center +
6	n.c.
7	Chassis
8	Right +
9	Chassis
10	*Left Surround – (Models CP650D and CP650SR)
11	*Right Surround – (Models CP650D and CP650SR)
12	Subwoofer –
13	Chassis
14	Left –
15	Chassis
16	n.c.
17	Center -
18	Chassis
19	n.c.
20	Right –
21	n.c.
22	Chassis
23	*Left Surround + (Models CP650D and CP650SR)
24	*Right Surround + (Models CP650D and CP650SR)
25	Subwoofer +

* See Option Card I/O connector table B-2 for surround outputs on Model CP650, which contains a Cat. No. 790 board. (Cat. No. 794 board in earlier units).

Option Card I/O Connector

The pinout of this connector is determined by the type of option board installed in the connectors of the Cat. No. 774A system controller board.

In a standard CP650, the Cat. No. 790 Dolby Digital Surround EX Decoder/Digital Input Board is shipped in this location (Cat. No. 794 on earlier units). Output signals for the surround channels appear on this connector. The digital input pins can be connected to devices incorporating S/PDIF digital outputs. Format 80 or 88 enables this input.

Table B–2 Option Card I/O Connector Pinout with Cat. Nos. 790, 791, or 794 Installed

Pin	Signal with Cat. No. 790 Installed	Additional Outputs with Cat. No. 791 Crossover Installed	Signal with Earlier Cat. No. 794 Installed
1	S/PDIF 1 (L/R) Input +		AES/EBU Input – S/PDIF Gnd
2	S/PDIF 2 (C/SW) Input +		AES/EBU Input + S/PDIF Input +
3	Back Surround Left –		Back Surround Left –
4	n.c.*	Center mid +	n.c.
5	n.c.	Center high +	n.c.
6	Back Surround Right –		Back Surround Right –
7	Gnd – digital inputs See Note		n.c.
8	n.c.	Right high +	n.c.
9	n.c.	Right mid + [Right Extra +**]	Chassis Gnd
10	Left Surround –		Left Surround –
11	Right Surround –		Right Surround –
12	n.c.	Left high –	n.c.
13	S/PDIF 3 (Ls/Rs) Input +		n.c.
14	n.c.	Left mid + [Left Extra +**]	n.c.
15	n.c.	Left mid – [Left Extra –**]	Chassis Gnd
16	Back Surround Left +		Back Surround Left +
17	n.c.	Center high –	n.c.
18	n.c.	Center mid –	Chassis Gnd
19	Back Surround Right +		Back Surround Right +
20	n.c.	Right high –	n.c.
21	S/PDIF 4 (Bsl/Bsr) Input +		n.c.
22	n.c.	Right mid – [Right Extra –**]	Chassis Gnd
23	Left Surround +		Left Surround +
24	Right Surround +		Right Surround +
25	n.c.	Left high +	n.c.

* No connection.

** Available only when system is configured as a two-way crossover and Le/Re mode is enabled.

Note: The screen (shield) of all analog output connections must be connected to the shell of the D-connector.

The optional Cat. No. 778 card has four pairs of AES inputs, the first of which provides a single digital bitstream input (Dolby Digital), or up to eight channels of digital PCM audio input. The card provides eight channels of digital audio outputs while supporting the Dolby Digital Surround EX audio format. With this card installed, all output channel level trims default to 127 to allow for the proper gain structure. **The analog outputs of the CP650 are muted when a Cat. No. 778 card is installed. All audio outputs are digital.**

Table B–3 Option Card I/O Connector Pinout with Cat. No. 778 Installed

Pin	Digital Signal I/O with Cat. No. 778 Installed	
1	AES1 (L/R) In +	This digital input pair can receive either PCM or Dolby Digital bitstreams. The remaining AES pairs receive PCM only.
2	AES1 (L/R) In –	
3	AES3 (Ls/Rs) In +	
4	AES2 (C/Sw) In +	
5	AES4 (Bsl/Bsr) In +	
6	X1/2 In+	
7	AES1 (L/R) OUT +	
8	AES3 (Ls/Rs) OUT +	
9	Chassis Gnd	
10	X1/2 OUT +	
11	Chassis Gnd	
12	AES2 (C/SW) In –	
13	AES3 (Ls/Rs) In –	
14	Chassis Gnd	
15	AES1 (L/R) OUT –	
16	AES3 (Ls/Rs) OUT –	
17	X1/2 Out -	
18	Chassis Gnd	
19	X1/2 In -	
20	AES4 (Bsl/Bsr) In -	
21	AES4 (Bsl/Bsr) Out -	
22	AES4 (Bsl/Bsr) Out +	
23	AES2 (C/SW) Out –	
24	AES2 (C/SW) Out +	
25	Chassis Gnd	

Hearing-Impaired (H/I) Output Connector

The Hearing-Impaired output is an unbalanced signal output. The connector used is a female RCA-type phono connector.

B.2 Input Connectors

Dolby Digital Reader Connectors (Reader 1 and 2)

These connectors are used for connecting up to two Dolby Digital film soundtrack readers to the CP650 or CP650D. These connections are inactive on model CP650SR. The pinout and the signals on these connectors are identical to the Dolby's DA20 Digital Film Sound Processor and CP500D Digital Cinema Processor.

Note: If only one projector input is required (platter operation), then the interconnecting cable must be plugged into **READER 1**.

Table B-4 Dolby Digital Reader Input Connector Pinout

Pin Number	Signal Name	Signal Description
1	n.c.	
2	n.c.	
3	n.c.	
4	TTCO	Row Clock Return
5	TCOGND	Row Clock Common
6	FTCO	Row Clock Send
7	TSCO	Pixel Clock Return
8	SCOGND	Pixel Clock Common
9	FSCO	Pixel Clock Send
10	n.c.	
11	n.c.	
12	n.c.	
13	n.c.	
14	VO	Differential Video V0
15	VOGND	V0 Common
16	+15VIDEO	+15 VDC
17	V1	Differential Video V1
18	V1GND	V1 Common
19	-15VIDEO	-15 VDC
20	n.c.	
21	n.c.	
22	n.c.	
23	n.c.	
24	n.c.	
25	n.c.	

Motor-Start Connector

The motor-start connector is used to interconnect the changeover control lines of the CP650 with the theatre control system. If the CP650 is to be used in a platter operation (single projector), a jumper must be installed on this connector between pins 1 and 5. This configuration is identical to the one used on the Dolby CP500.

- Motor Start: Less than 1 VDC with respect to signal ground.
 Motor Off: Greater than 3.5 VDC, less than 18 VDC.

Table B–5 Motor-Start Connector Pinout

Pin	Connection
1	Motor Start 1
2	P1 Changeover select (gnd)
3	P1 / P2 Changeover select (gnd for P2)
4	P2 Changeover select (gnd)
5	Chassis Gnd
9	Motor Start 2

Optical Input Connectors (1 and 2)

There are two connectors for analog solar cell inputs from analog soundheads. Up to two projectors can be connected to the CP650. The pinout for each connector is identical. In addition to providing for the input of the analog soundhead signals, the CP650 has bipolar DC outputs to supply power to optical preamplifiers (± 14 VDC). This DC voltage is supplied from the CP650 bypass power supply to ensure that optical preamplifiers still function if the CP650 switches to bypass operation during a performance. The maximum supply current available is 15 mA per preamp.

Table B–6 Optical Input Connector Pinout

Pin	Connection
1	L+
2	L–
3	GND
4	R+
5	R–
6	GND
7	+14 V supply (through a 150 Ω resistor) 20 mA max
8	–14 V supply (through a 150 Ω resistor) 20 mA max
9	GND

MIC Input Connector

The Mic Input is a balanced input using a three-pin XLR female connector. This connector is a duplicate of the MIC MUX input connector on the front setup panel.

Table B–7 Mic Input Connector Pinout

Pin	Connection
1	Shield
2	+ signal
3	– signal

MIC MUX Connector on front setup control panel

An EQ microphone or mic multiplexer can be connected at this location without the need for access to the CP650 rear panel. Pins 1, 2, and 5 are wired in parallel with the rear-panel microphone input XLR connector. If you wish to use a connector already wired for use with a Dolby CP500, add a jumper between pins 5 and 6.

Caution: *It is essential that nothing be connected to the rear-panel microphone input connector if this front-panel connector is used for performing equalization.*

Table B–8 MIC MUX Connector

Pin	Connection
1	+ mic signal
2	– mic signal
3	n.c.
4	n.c.
5	Mic cable ground
6	n.c.
7	+15 V (through a PTC resistor) 100 mA max
8	Data ground
9	Digital control signals for multiplexer

Nonsync Input Connectors (1 and 2)

Both Nonsync input connectors are female phono (RCA-type) connectors and the input circuit is unbalanced, 11 K Ω , sensitivity: 0.2–4 V for NS 1, and 0.06–1.5 V for NS 2.

Remote Unit and Remote Fader Connector

Table B–9 Remote Unit and Remote Fader Connector Pinout

Pin	Connection
1	Power +
2	Remote Data
3	Chassis Gnd
4	Chassis Gnd
5	Remote Fader Wiper
6	n.c.

6-Channel Analog Audio Input Connector

This input is an unbalanced analog audio input. The nominal reference level is approximately 300mV. There are no input level trim controls within the CP650 for this input.

Table B-10 Six-Channel Analog Input Connector Pinout

Pin	Connection	
1	Signal Ground	
2	EXT3	Right Surround Channel External Input
3	Signal Ground	
4	Signal Ground	
5	Signal Ground	
6	Signal Ground	
7	Signal Ground	
8	Signal Ground	
9	Signal Ground	
10	Signal Ground	
11	Signal Ground	
12	Signal Ground	
13	Signal Ground	
14	EXT0	Left Channel External Input
15	EXT2	Left Surround Channel External Input
16	Signal Ground	
17	EXT1	Right Channel External Input
18	Signal Ground	
19	Signal Ground	
20	EXT4	Center Channel External Input
21	Signal Ground	
22	Signal Ground	
23	Signal Ground	
24	EXT5	Subwoofer Channel External Input
25	Signal Ground	

B.3 I/O Connectors

Automation I/O Connector

This connector is a 25-pin female D-connector, wired to closely match the configuration of the Dolby Model CP65.

Table B–11 Automation I/O Connector Pinout

Pin	Connection	Specification	
1	S0 (automation select) format 01—Mono	Control signal LOW = select LOW = < 2.4 Vdc for at least 20 ms If a solid-state switch is used, it must have a saturation (on) voltage of less than 2.4 V at a current of 2.5 mA, or a resistance of 950 ohms or less, and 0V offset.	
2	S1 (automation select) format 04—A-type		
3	S2 (automation select) format 05—SR		
4	S3 (automation select) format 10—Digital		
5	S4 (automation select) format 11—External 6-channel analog		
6	S5 (automation select) format User1		
7	S6 (automation select) format Nonsync		
8	S7 (automation select) format User2		
9	(automation select) remote fader select		
10	(automation select) mute		
11	n.c. (–15V in Model CP65)		
12	DGND		
13	+15V (through a PTC resistor)	100 mA maximum current available	
14	ID0 (automation indicator) format 01—Mono	ID on = internal 1.5K resistor to +15 V ID off = Open Circuit	
15	ID1 (automation indicator) format 04—A-type		
16	ID2 (automation indicator) format 05—SR		
17	ID3 (automation indicator) format 10—Digital		
18	ID4 (automation indicator) format 11—External 6-channel analog		
19	ID5 (automation indicator) format User1		
20	ID6 (automation indicator) format Nonsync		
21	ID7 (automation indicator) format User2		
22	Fader local/remote fader (automation indicator)	HIGH = Local	Internal circuit: HIGH = 10K to +15 V.
23	Mute (automation indicator)	LOW = Muted	LOW = 500 Ohms +1.2V fixed drop to GND
24	n.c.		
25	Projector status (automation indicator)	Internal circuit: HIGH=Projector 1: 1.5 kΩ to +13 VDC (1.5 kΩ to +10 VDC in bypass) LOW=Projector 2: 1.5 kΩ to GND	

Note: In order to maintain CP65 compatibility, the order of the select/indicator lines does not correspond to the front-panel button order.

Automation I/O Connector: Pins Used for Noise Gating

The table below lists the pin numbers used for the Noise Gating function. See Section 7.13 for a description of this setup menu item. Grounding the listed pin will send pink noise to the listed channel when the setup menu is set to Noise Gating.

Table B–12 Automation I/O Connector Pins Used for Noise Gating

Grounding This Pin:	Sends Pink Noise To:	Level
1	Left	85 dB
2	Center	85 dB
3	Right	85 dB
4	Left Surround	82 dB
5	Right Surround	82 dB
6	Subwoofer	Digital SW Level
7	All Channels	
8	Back Surround (both Bsl and Bsr)	82 dB

Serial Data (RS-232) Connector

This connector “mirrors” the RS-232 connector located on the front setup panel. A PC can be connected at either location for performing complete cinema processor alignment using Dolby CP650 setup software.

Caution: Only one of the two RS-232 connectors can be used at any given time.

Table B–13 Serial Data (RS-232) Connector Pinout

Pin	Connection
1	n.c.
2	Data Out
3	Data In
4	Connected to pin 6
5	Chassis
6	Connected to pin 4
7	Connected to pin 8
8	Connected to pin 7
9	n.c.

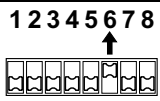
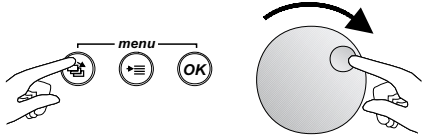
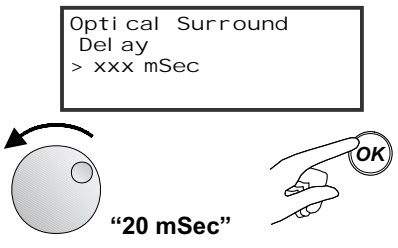
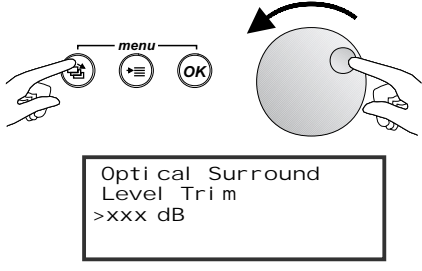

Ethernet Connector

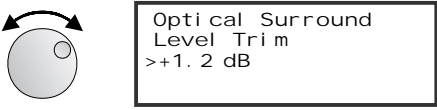

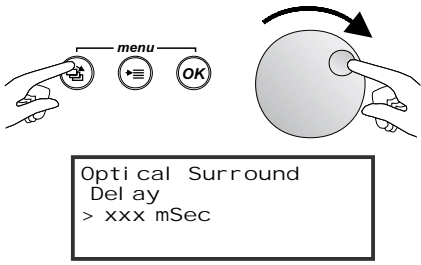

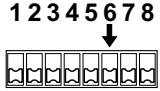
For future automation use.

Appendix C

Optical Surround Level Trim

Use this procedure to subjectively balance front and surround loudspeaker levels using the Cat. No. 151B test film. The film contains band-limited noise, restricted to the range 500 Hz to 2 kHz. The noise is cycled between the front center speaker and rear surround speakers. The surround level should have already been set using the final output level calibration procedure in Section 4.7.6.

	<p>Ensure that DIP switch 6, located on the setup control panel, is in the “up” position.</p>
	<p>Temporarily set the optical surround delay to minimum (20 ms). This step eliminates any confusion while the test film noise cycles between front and rear speakers.</p> <p>Press and hold the left menu button while rotating the front-panel knob to step the menu to Optical Surround Delay.</p>
	<p>Note: If the optical surround delay has been set during a previous CP650 system setup, write down the current delay setting displayed!</p> <p>Rotate the front-panel knob counterclockwise to set the delay to 20 ms. Then press the OK button to save the setting.</p>
	<p>Press and hold the left menu button while rotating the front-panel knob counterclockwise until the Optical Surround Level Trim menu appears.</p>
	<p>Thread and play a loop of the Cat. No. 151B test film.</p>

	<p>Walk around the auditorium, and make an overall judgment of the surround level compared to the screen level. Because of the “diffuse” nature of the surround sound, it will commonly require a slight increase in surround level to get it to match the screen level. The tonal balance and acoustic level should subjectively match.</p> <p>Rotate the fader knob to set the surround level trim desired. The range is –3 dB to +6 dB. This example shows the level trim set to set to +1.2 dB.</p>
	<p>Press the OK button to save the change.</p>
	<p>If a previous CP650 setup has been performed, restore the original optical surround delay setting noted in the step above.</p>
	<p>Press the OK button to re-save the original setting.</p>
	<p>If you are NOT continuing with final adjustments (Chapter 7), move DIP switch 6 to the “down” position.</p>

Appendix D

Format Descriptions

Each format supported by the CP650 is described below. More specifically, each listing describes the audio processing applied by each format for any Dolby® cinema processor. Table D–1 describes the parameters for each format.

D.1 Channel Definitions

Table D–1 Channel Definitions

L	Left screen channel
Le	Left extra screen channel
C	Center screen channel
Re	Right extra screen channel
R	Right screen channel
S	Mono surround
SW	Subwoofer
Lt, Rt	Left total and right total signals, which contain the encoded signals to be matrix-decoded into a four-channel signal
Ls	Left surround
Rs	Right surround
Bsl	Back surround left
Bsr	Back surround right
Bs	Back surround; internal Surround EX decoded signal sent to Bsl and Bsr outputs

Note: In Dolby Digital 5.1 mode, Ls refers to the combination of Bsl and Ls speakers; Rs refers to the combination of Bsr and Rs speakers. In Dolby Digital Surround EX™ mode, Ls and Rs refer only to the left and right side speakers. (See the output switching Figure 1-1.)

D.2 Format Definitions

The formats supported by the CP650 are described below. If a format name is too long for display on the CP650 front-panel (limited to 19 characters), a second, short name is given.

Format 01

Academy Mono Optical

Short name: Mono

Audio Description: Optical mono audio comes in on either projector's optical input, has no noise reduction applied, and is intended to produce audio on the center channel only. This format takes Lt + Rt and puts the result on the center channel only. There is no derived subwoofer. The mono EQ and mono level trim settings are enabled.

In this format, processing is applied after the optical preamps and the slit-loss filter, to obtain the desired response curve.

Format 04

Dolby A-type Optical

Short name: Dolby A-type

Audio Description: Either projector's optical input provides Lt/Rt inputs, and matrix decoding produces four output channels (L, C, R, S). A-type noise reduction is applied to Lt and Rt.

The subwoofer signal is derived by summing L + C + R (after matrix decoding). This audio is then filtered by applying a user-selectable 50 or 100 Hz subwoofer filter, applying the downward expander, the parametric equalizer, and finally a separate optical subtrim. The level is nominally set to match the passband level of the center channel using an RTA.

Format 05

Dolby SR Optical

Short name: Dolby SR

Audio Description: Either projector's optical inputs provides Lt/Rt inputs, and matrix decoding produces four output channels (L, C, R, S). SR processing is applied to Lt and Rt.

The subwoofer signal is derived in the same way as in Format 04.

Format 10**Dolby Digital Film (Cat. No. 773 required)****Short name: Dolby Digital**

Audio Description: The input is from the Dolby Digital reader, which provides the signal to the Dolby Digital decoder and creates six discrete channels (L, C, R, Ls, Rs, SW). The optical soundtrack is processed as in Format 05 at all times, to enable rapid reversions to analog film sound when needed.

On a reversion event, the following actions take place:

1. The subwoofer level is set back to 0 dB, relative to the center channel passband.
2. The subwoofer lowpass filter is set to 50 or 100 Hz.
3. The downward expander is turned on.
4. The sound crossfades from the digital audio to the optical to minimize the audibility of the reversion.

On an “unreversion” event, the following actions take place:

1. The subwoofer level is set back to +10 dB, relative to the optical subwoofer level.
2. The subwoofer lowpass filter is set to 180 Hz.
3. The downward expander is turned off.
4. The sound crossfades from the optical audio to the digital, to minimize the audibility of the unreversion.

Format 11**External 6-Channel**

Audio Description: This external audio format has six discrete channels (L, C, R, Ls, Rs, SW), is input via the six-channel analog input D-connector, and can be used when an external digital processor is utilized. The subwoofer channel level is +10 dB referenced to the optical, with no downward expander.

Format 13**Dolby Digital Surround EX Film (Cat. Nos. 773 and 790 required)****Short name: Surround EX**

Audio Description: This format is very similar to Format 10. Digital audio is processed normally. The Cat. No. 790 (or earlier Cat. No. 794) applies the Surround EX matrix decoder to the unequalized Ls and Rs channels, which yields the channels Ls, Bs (which are copied into the Bsl and Bsr channels), and Rs. The out-of-phase information is discarded. The audio for the screen channels and subwoofer is output via the CP650's main audio outputs, and the audio for the four surround channels is output via the “Option card I/O” D-connector. Note that reversions occur exactly the same as in Format 10.

Format 20**35 mm Magnetic, L, C, R 3-Channel****Short name: 3-Channel Mag**

Audio Description: This magnetic audio format has four discrete channels (L, C, R, S, though S is unused) and is input through the six-channel analog input. The magnetic preamplifier units (MPUs) are external, and the Academy mag filters (if required) are also external to the CP650. There is no derived subwoofer.

Format 22**35 mm Magnetic, 4-Channel****Short name: 4-Channel Mag**

Audio Description: This format differs from Format 20 only because the mono surround channel (S) is not muted in Format 22. This magnetic audio format has four discrete channels (L, C, R, S) and is input through the six-channel analog input. The MPUs are external, and the Academy mag filters (if required) are also external to the CP650. There is no derived subwoofer.

Format 42**70 mm Dolby A-type Mag. Mono Surround****Short name: 70 mm Dolby Stereo**

Audio Description: This magnetic audio format has six discrete input channels (L, Le, C, Re, R, S) and is input through the six-channel analog input. The MPUs are external. Four channels of A-type noise reduction are applied to the L, C, R, and S tracks (tracks 1, 3, 5, and 6). The CP650 generates the outputs L, C, R, Ls, Rs, and SW. The Ls and Rs outputs are copies of the “S” mono surround input track. The subwoofer track is created by lowpass filtering the Le and Re tracks at 180 Hz and summing them. The subwoofer level is set to +10 dB (relative to the optical subwoofer level). The Le and Re tracks are used only to generate SW output, and do not pass on any screen- or surround- channel audio.

Format 60**Nonsync 1**

Audio Description: This external audio format has two discrete input channels (L, R) and is input through the Nonsync 1 input connectors. L and R are passed to the L and R outputs of the CP650. The L and R channels are also passed to the Pro Logic® decoder with only the surround signal being utilized and sent to the surround outputs of the CP650.

Format 61**Nonsync 2**

Audio Description: This external audio format has two discrete input channels (L, R) and is input through the Nonsync 2 input connectors. L and R are passed to the L and R outputs of the CP650. The L and R channels are also passed to the Pro Logic decoder with only the surround signal being utilized and sent to the surround outputs of the CP650.

Format 64**Public Address Center Channel****Short name: Public Address, C****Audio Description:** A single channel is input through the microphone input connector. The audio output is sent to Center only.**Format 65****Public Address Surround Channels****Short name: Public Address LsRs****Audio Description:** A single channel is input through the microphone input connector. The audio output is sent to Ls and Rs only.**Format 66****Test Tone 320 Hz****Audio Description:** This internally generated audio format outputs a 320 Hz Dolby level tone on all channels.**Format 70****Video PA Nonsync 1****Short name: Video PA (NS1)****Audio Description:** This external audio format has two discrete input channels (L, R) and is input through the Nonsync 1 input connectors. L and R are summed to mono, with the resulting audio sent to the C, Ls, and Rs channels. There is no derived subwoofer channel.**Format 71****Video Mono Nonsync 1****Short name: Video Mono (NS1)****Audio Description:** This external audio format has two discrete input channels (L, R) and is input through the Nonsync 1 input connectors. L and R are summed to mono, with the resulting audio sent to the C channel only. There is no derived subwoofer channel.**Format 73****Video LCR Nonsync 1****Short name: Video LCR (NS1)****Audio Description:** This external audio format has two discrete input channels (L, R) and is input through the Nonsync 1 input connectors. The audio is processed with Pro Logic decoding with the surround output muted, and is output on channels L, C, and R (including the surround audio). There is no derived subwoofer channel.

Format 74**Video Pro Logic No SW Nonsync 1****Short name: Vid Pro Logic No SW**

Audio Description: This external audio format has two discrete input channels (L, R) and is input through the Nonsync 1 input connectors. The audio is processed with Pro Logic decoding and output on channels L, C, R, with a mono signal to Ls and Rs. There is no derived subwoofer.

Format 75**Video Pro Logic with SW Nonsync 1****Short name: Vid Pro Logic +SW**

Audio Description: This external audio format has two discrete input channels (L, R) and is input through the Nonsync 1 input connectors. The audio is processed with Pro Logic decoding and output on all channels. The subwoofer signal is derived by summing L + C + R (after matrix decoding). This audio is then sent to the user-selectable 50 or 100 Hz subwoofer filter, and the output level is controlled by the separate optical subtrim. As in optical formats, the level is nominally set to match the passband level of the center channel using an RTA.

Format 80 (Cat. No. 790 or 778 required)**Bitstream Master Digital Input****Short name: Master Digital In**

Audio Description: The input is a digital bitstream into the Option Card I/O connector, AES 1 (L/R) pins. This format automatically detects whether the bitstream is PCM or Dolby Digital (AC-3), and configures the decoder appropriately. For a PCM (two-channel) input signal, matrix decoding may be applied using the “Format 80/81 PCM Options” screen. This screen also contains a “PCM Auto Mute” option that causes the CP650 to mute automatically if it does not detect a Dolby Digital bitstream. This prevents noise when working only with encoded bitstream audio. For Dolby Digital bitstreams, the metadata contained in the bitstream specifies the channel format and surround processing to be applied.

This format does not support more than two channels of PCM. For multichannel PCM support, use formats 88, 89, or 90 (see below).

Format 81 (Cat. No. 790 required)
Bitstream Dolby Digital Surround EX
Short name: Fmt 80 w/Surr. EX

Audio Description: The input signal is a digital bitstream into the Option Card I/O input. The signal is Dolby Digital (consumer) decoded, and the resultant L, C, R, and SW signals are sent to the output. The Ls and Rs channels are sent to the Surround EX matrix decoder to yield the channels Ls, Rs and Bs (which is copied into the Bsl and Bsr channels). The out-of-phase information is discarded. The audio for all channels output via the Option Card I/O connector.

For PCM or bitstream material with fewer than two discrete surround channels, this format is identical to Format 80.

Format 85 (Cat. Nos. 790/791 or Cat. No. 778 Required)
Bitstream PCM 8-Channel Input, 10-Channel Output
Short name: 5-Ch. Screen

Audio Description: The input signals are S/PDIF formatted bitstreams into the Option Card I/O inputs. S/PDIF input 1 carries Left and Right Channel audio data and is output on the Left and Right channel analog outputs. S/PDIF input 2 carries center and Subwoofer channel audio data is output on the Center and Subwoofer channel analog outputs. S/PDIF input 3 carries Left Surround and Right Surround channel audio data. Left Surround audio is output on the Left Surround and Back Surround Left analog outputs. The Right Surround audio is output on the Right Surround and Back Surround Right analog outputs. There are two additional output channels labeled Left Extra and Right Extra. These are input on S/PDIF input 4 and output on the Left and Right mid-frequency analog outputs. In order to use this format, the CP650 must be configured for 2-Way crossover operation, and Le/Re mode must be enabled.

Format 86 (Cat. Nos. 790/791 or Cat. No. 778 Required)
Bitstream PCM 8-Channel Input, 10-Channel Output
Short name: 5-Channel Screen + EX

Audio Description: The input signals are S/PDIF formatted bitstreams into the Option Card I/O inputs. S/PDIF input 1 carries Left and Right channel audio data and is output on the Left and Right channel analog outputs. S/PDIF input 2 carries Center and Subwoofer channel audio data and is output to the Center and Subwoofer channel analog outputs. S/PDIF input 3 carries Left Surround and Right Surround channel audio data. These channels are Dolby Digital Surround EX decoded. The Left Surround audio is output on the Left Surround analog output. Back Surround Left audio is output on the Back Surround Left analog outputs. Right Surround audio is output on the Right Surround analog output. Back Surround Right audio is output on the Back Surround Right analog outputs. In this format, there are two extra channels, labeled Left Extra and Right Extra. These two channels are input on S/PDIF input 4 and output on left and right mid-frequency analog outputs. In order to use this format, the CP650 must first be configured for 2-Way crossover operation, and Le/Re mode must be enabled.

Format 87 (Cat. No. 790 or earlier Cat. No. 794 required)**External 6-Channel with Surround EX****Short name: Fmt 11 w/Surr. EX**

Audio Description: This external audio format is a combination of Formats 11 and 13, and can be used when an external digital processor is connected. Signals of six discrete channels (L, C, R, Ls, Rs, SW) are connected to the six-channel analog input connector. L, C, R, and SW are sent discrete to the outputs. The unequalized Ls and Rs channels are sent to the Surround EX matrix decoder to yield the channels Ls, Bs (which are copied into the Bsl and Bsr channels), and Rs. The out-of-phase information is discarded. The audio for the screen channels and subwoofer is output via the CP650's main audio outputs, and the audio for the four surround channels is output via the Option card I/O connector. The subwoofer channel level is +10 dB referenced to the optical, with no downward expansion.

Format 88 (Cat. No. 790 or 778 required)**6-Channel PCM**

Audio Description: This format uses six discrete input channels (L, R, C, SW, Ls, Rs) and processes them in the following manner:

1. The master audio clock source is the L/R input (first AES pair).
2. Dolby Digital bitstream decoding is disabled.
3. Digital subwoofer EQ and level processing is applied, but no lowpass filter is used.
4. The Ls input is duplicated on the Bsl output, and the Rs input is duplicated on the Bsr output.
5. The surround level adjustments are similar to those for 5.1 film formats, where Ls/Bsl together produce 82 dBC SPL, and Rs/Bsr together produce 82 dBC SPL.

Format 89 (Cat. No. 778 required)**6-Channel PCM + Surround EX****Short name: 6-Channel PCM + EX**

Audio Description: This format is identical to Format 88 with the exception that Surround EX decoding is applied to Ls and Rs producing additional Bsl/Bsr (identical) outputs.

Format 90 (Cat. No. 778 required)**7-Channel PCM**

Audio Description: This format is used to input seven discrete channels: L, C, R, Ls, Rs, Sw, and Bs, as would exist in a pre-encoded Surround EX mix. Processing is identical to Format 88 with the following exceptions:

1. The Back Surround (Bs) input (Channel 1 of AES input 4) is copied to Bsl and Bsr outputs.
2. No Surround EX decoding is performed.

The output levels are adjusted to produce reference 85 dB SPL in Ls and Rs, and 82 dB SPL in Bsl and Bsr. (This produces a net 85 dB SPL from the combined Back Surround outputs.)

Format 92**Dolby SR 2-Track Printmaster****Short name: Dolby SR (6-Ch In)**

Audio Description: This format is the equivalent of Format 05, but takes the audio from the six-channel analog input L/R pair instead of the optical Lt/Rt input.

Format 93**Dolby SR 2-Track Printmaster****Short name: Dolby SR (NS1)**

Audio Description: This format is the equivalent of Format 05, but takes the audio from the NS1 input instead of the optical Lt/Rt input.

Table D-2 Format Characteristics Chart

Format Number	Format Name	Required Option 2 board	Input	Decode	Noise Reduction	Subwoofer	Sub Low-pass	Sub Output Level Referenced to Center	Downward Expander	Surrounds	Optical Surr Lvl Offset
01	Academy Mono Optical		Optical in	L+R summed to center w/Academy filter	None					None	
04	Dolby A-type Optical		Optical in	Pro Logic derived L, C, R, S	A-type	Derived from L, C, R	User defined: 50/100 Hz	0 dB	Yes	Mono Pro Logic derived	Yes
05	Dolby SR Optical		Optical in	Pro Logic derived L, C, R, S	SR	Derived from L, C, R	User defined: 50/100 Hz	0 dB	Yes	Mono Pro Logic derived	Yes
10	Dolby Digital Film		Digital reader	Dolby Digital (film)		Discrete	120 Hz, defined by recording	+10 dB		Discrete Ls, Rs	
11	External 6-Channel		Six-channel	Discrete		Discrete	20-20 kHz	+10 dB		Discrete Ls, Rs	
13	Dolby Digital Surround EX film	Cat. No. 790 or 794	Digital reader	Dolby Digital (film) w/Surround EX		Discrete	120 Hz, defined by recording	+10 dB		EX derived Ls, Bs, Rs to Option I/O outputs	
20	35 mm Magnetic, L, C, R 3-channel		Six-channel	Discrete							
22	35mm magnetic 4-channel		Six-channel	Discrete						Discrete mono	
42	70 mm Dolby Stereo		Six-channel	Discrete	A-type x 4	Summed from Lc, Rc	180 Hz	+10 dB	Yes	Discrete mono	
60	Non-sync 1		Non-sync 1	Discrete L/R, Pro Logic surround						Mono Pro Logic derived	Yes
61	Non-sync 2		Non-sync 2	Discrete L/R, Pro Logic surround						Mono Pro Logic derived	Yes
64	P.A. Center Channel		Mic. Input	Input signal sent to Center							
65	P.A. Surround Channels		Mic. input	Input signal sent to Surrounds							
66	Test Tone			320 Hz tone		Tone				Tone	
70	Video PA Non-sync 1		Non-sync 1	L + R summed to C, Ls, Rs						L + R summed to Ls, Rs	
71	Video mono Non-sync 1		Non-sync 1	L + R summed to Center							
73	Video LCR Non-sync 1		Non-sync 1	Pro Logic no surrounds							N/A
74	Video Pro Logic no SW Non-sync 1		Non-sync 1	Pro Logic derived L, C, R, S						Mono Pro Logic derived	Yes
75	Video Pro Logic with SW Non-sync 1		Non-sync 1	Pro Logic derived L, C, R, S		Derived from L, C, R	User defined: 50/100 Hz	0 dB		Mono Pro Logic derived	Yes

Format Number	Format Name	Required Option 2 board	Input	Decode	Noise Reduction	Subwoofer	Sub Low-pass	Sub Output Level Referenced to Center	Downward Expander	Surrounds	Optical Surr. Lvl Offset
80	Master Digital Input	Cat. No. 778	AES1	Auto-detect/decode PCM, Dolby Digital (consumer)		In bitstream				Up to four discrete, dependent on format	
		Cat. No. 790	S/PDIF								
		Cat. No. 794	AES/EBU, S/PDIF								
81	Master Digital In + Surround EX	Cat. No. 778	AES1	Dolby Digital (consumer): with Surround EX		In bitstream				EX derived Ls, Bs, Rs to Option I/O outputs	
		Cat. No. 790	S/PDIF								
		Cat. No. 794	AES/EBU, S/PDIF								
85	5-Ch. Screen	Cat. Nos. 790/791	AES/EBU	8-channel discrete	None	Discrete bitstream input				Bsl = Ls, Bsr = Rs; Ls and Rs are discrete PCM streams	
			S/PDIF								
86	5-Ch. Screen + EX	Cat. No. 778	AES/EBU	8-channel discrete, Surround EX decode of Ls and Rs inputs	None	Discrete bitstream input				Surround EX-derived Ls, Bs, Rs to Option I/O outputs	
		Cat. Nos. 790/791	S/PDIF								
87	Ext. 6-channel with surround EX	Cat. No. 790 Cat. No. 794	Six-channel	Discrete L, C, R, SW with EX decode of Ls, Rs		Discrete	20 Hz-20 kHz	+10 dB		Surround EX derived Ls, Bs, Rs to Option I/O outputs	
88	6-Channel PCM	Cat. No. 778	AES x 3	Discrete							
89	6-Channel PCM + Surround EX	Cat. No. 778	AES x 3	Discrete							
90	7-Channel PCM	Cat. No. 778	AES x 4	Discrete							
92	Dolby SR 2-track Printmaster		Six-channel L, R input	Pro Logic derived L, C, R, S	SR	Derived from L, C, R	User defined: 50/100 Hz	0 dB	Yes	Mono Pro Logic derived	Yes
93	Dolby SR 2-track Printmaster		Nonsync 1	Pro Logic derived L, C, R, S	SR	Derived from L, C, R	User defined: 50/100 Hz	0 dB	Yes	Mono Pro Logic derived	Yes

Appendix E

External Control of CP650

The CP650 can be controlled by devices connected to the RS-232 **serial data** connector, or to the **remotes** connector located on the rear of the CP650.

This appendix is for use by customers who are highly qualified to modify hardware and write software. Dolby Laboratories cannot be held liable for incidental, special, direct, indirect, or consequential damages; or loss of use, revenue, or profit by users attempting to interface the CP650 with other systems.

E.1 Control via RS-232 Serial Data Port

CP650 control via the serial data connector (the primary interface designed and supported by Dolby) is available in CP650 system software version 1.2.1.1 and later.

The CP650 provides a SERIAL DATA port that supports standard 9-pin serial connections to PC serial ports and other RS-232 devices. Although this port is primarily used while running the Dolby® CP650 Setup software from a PC, the software interface described below allows the serial data port to be used with a simple ASCII character interface to set and get information regarding the current CP650 processor status.

The raw serial interface parser accepts ASCII commands as described below. Each command consists of a simple keyword, <key>, followed by an “=” sign and the <value> for that key. A command is terminated by an end-of-line character combination (“\r\n”). This is the typical “end of line” combination sent by PC terminal programs.

Current CP650 settings may be queried by substituting a question mark “?” for the “<value>” field. The complete set of known settings may be queried by using the special “all=?” command. See the examples below.

Commands

Key	Range of Values	Notes
format_button	0 .. 7 indicates which button on the CP650 front-panel should be applied: Data Button Applied 0 Format 01 1 Format 04 2 Format 05 3 Format 10 4 Format 11 5 User Format 1 6 User Format 2 7 Nonsync Format Any Preset Fader Level associated with the indicated button is also applied, and the LED for the selected button is illuminated.	
fader_level	0 .. 100 corresponding to fader values 0.0 ... 10.0	Querying fader_level while the fader_setting is "auditorium" returns the level as determined by the auditorium fader.
fader_setting	"local" "auditorium" If "auditorium" is selected, the main shaft fader is disabled as are any attached Remotes (Cat. No. 779, Cat. No. 771).	<see above> If changed via this serial interface, this setting is lost at the next CP650 restart.
mute	0 .. 2 indicating the desired mute setting: Data Mute Operation 0 Unmute 1 Mute 2 Toggle Any applicable "Fade In/Out Time" is applied just as if the front-panel MUTE button were used.	
user_formats		This key can only be queried, not modified. Querying this key returns on one line a comma-separated list indicating the user formats: <user 1>, <user 2>, <nonsync>
projector	1 .. 2	This key can only be queried, not modified.
preset_fader_level		This key can only be queried, not modified. Querying this key returns on one line a comma-separated list indicating the current value for all format buttons separated by commas. The buttons are listed in the following order: 01, 04, 05, 10, 11, U1, U2, NS Each level can be 0–100, or –1. A setting of –1 indicates no preset fader level for that button.

Query

Querying an Individual Parameter

“<key>=?” returns a “<key>=<value>” output line for that key.

Querying All Available Parameters

“all=?” results in a series of output lines representing every known key in the serial control system.

Query Errors

If a query cannot be parsed or does not match a known parameter, “error” will be output. External controllers must wait for the response to a query before proceeding.

Notes

1. The ASCII interface system operates at a baud rate of 9600 bps (8 data bits, 1 stop bit, No Parity, No Flow Control) and cannot be invoked while the SERIAL DATA port is in use by the CP650 Setup or Reader Alignment programs.
2. The interface operates in RAW serial mode. Characters are not echoed back to the controller, and control characters are ignored.
3. Command parsing is not case sensitive.
4. Whitespace (<space>, <tab>, etc.) is ignored on input lines.
5. No error correction (CRC), sync bytes, or protocol is applied to this interface. Customers must be aware of any stability or dropout issues with their own hardware.
6. If a command is parsed successfully but the value is out of range (or the same as the current setting), no error is issued and the command has no effect.

Examples

Operation	Character String to Send	Output from the CP650
To set the CP650 fader level to 6.5	fader = 65\r\n	
To ensure the CP650 is not muted	mute = 0\r\n	
To apply the Format 10 button	format_button = 3\r\n	
To query the status after the above three commands are sent	query all\r\n	fader = 65\r\n mute = 0\r\n format_button = 3\r\n user_formats = 13, 64, 60\r\n projector = 1\r\n preset_fader_level = -1, -1, -1, 65, 68, -1, -1, 75\r\n

E.2 Control via Remotes Connector

CP650 control using single-wire communications via the **remotes** connector is available in CP650 System software version 1.1.5 and later. To do so, it is recommended that a Cat. No. 779 Remote Control or Cat. No. 771 Remote Fader be used.

Dolby Laboratories occasionally receives requests to interface the CP650 to other types of computers, for the purposes of remote control. While this was never intended to be a feature of the remote port, it may be possible to command the CP650 to change the fader level, select any one of the eight front-panel formats, and to toggle the mute status.

The remote port interface consists of three wires. One provides 15 volts at low current to power the remote units. The other two lines of the remote port are ground (0 volts) and data. The ground line should be connected to the reference ground voltage of the serial port on the computer. This is usually found on pin 7 of a serial 25-pin D-connector, or pin 5 of a 9-pin D-connector.

The single data line presents the single biggest challenge of interfacing another computer to the CP650. All industry-standard RS-232 ports have two data lines; one to transmit, and one to receive. The CP650 data line works by placing the single data line in a “high impedance” state while listening for transmitted data, and driving voltages onto this line when it needs to send information. In other words, the single data line is a “receiving” line for all devices, except when they need to send data, at which point it is a “transmitting” line.

Thus, when the CP650 needs to communicate, or a remote accessory needs to communicate with the CP650, it “takes control” of the single data line just long enough to send its message. It then must place the line back in a high-impedance state, and listen for a response.

Interfacing an external computer's serial port to the single data line can be tricky. The actual requirement, as stated above, is for the serial port to “tri-state” its transmitter when it is not sending.

If a one cannot engineer this type of circuit for the computer's serial port, an alternate method can be tried, but it may damage the serial port. Pass the serial port's transmit line through a series-connected resistor, and tie that line to both the serial port receive line and the CP650's data line. If one is lucky, the serial port's transmitter (which does not tri-state) can be overridden by the CP650's transmitter, and yet still function as a transmitter when necessary (when the CP650 is in “listen” or high-impedance mode).

To do this, start with a high resistance (say, 100 k Ω), and reduce it until the computer's serial port is able to both send and receive data. The exact value required depends on the types of chips used in the serial port.

The DDCMP Protocol

Digital Data Communications Message Protocol (DDCMP) was developed by Digital Equipment Corporation as a serial link layer protocol.

All messages between the CP650 and the remote accessories take place within the context of the DDCMP protocol. An important reference document, *ddcmp.txt*, is published by Digital Equipment Corporation

The network is a half-duplex multipoint network. The operating mode of the remote accessories is that of a half-duplex tributary station, with the control station being the CP650.

The CP650 supports remote accessory device addresses 1 through 9.

The CP650 has intentionally added one nonstandard modification to the DDCMP protocol. If the CP650 sends out the hex value “FF” twenty times in a row, all remote accessories should recycle themselves to their power-on state. This includes resetting themselves to the ISTRT state, and attempting to re-establish the link.

Disclaimer: An attempt has been made to implement the DDCMP protocol as defined in the document referenced above. If there is a difference between the reference document and the CP650 implementation, the CP650 method is defined to be correct, and will not be modified. Dolby Laboratories reserves the right to make changes to the remote port communication scheme or interface at any time, without notice.

DDCMP Timers

A real timer must exist in both the ISTRT and ASTRT states, of approximately one second, for sending STRT and STACK messages respectively.

Establishing the DDCMP Link

On power-up, the remote accessories should be in the ISTRT state. As specified in the DDCMP document, the link to the CP650 is established by each remote accessory sending one (or more) STRT messages until the remote accessory receives the STACK message (indicating that the link has been established).

The delay between repeated STRT messages should be determined by each accessory’s address (slightly different for each address) to prevent repeated transmission collisions.

Remote Accessories-to-CP650 Message

A periodic ACK from the CP650 will pass the select flag to each remote accessory (in turn). If no change in the state of the CP650 is required by the selected remote accessory, the remote simply returns the select flag via an ACK message.

If the remote has been given the select flag, and it intends to change the state of the CP650, it will send the one-byte data message.

Note: All remotes must parse all messages. This requires looking at the length and cannot be ignored.

To command the CP650 to toggle the mute setting, the data message must have a value of zero. If the CP650 was unmuted before receiving this command, it will be in the muted mode afterwards, and if muted before, it will be unmuted after.

The CP650 front-panel buttons can be thought of as being numbered 1 through 8 (format 01, 04, 05, 10, 11, U1, U2, and NS, respectively). To command the CP650 to assert a format change, the data byte should be a number between 1 to 8.

To change the fader level, the data byte should be a value between 10 and 110. This corresponds to a fader setting between 0.0 and 10. (Subtract 10 from the value of the data byte, and then divide by 10 to obtain the resulting fader value.)

CP650-to-Remote Accessories Message

The message from the CP650 to any remote accessory will always contain two bytes of data. The CP650 will periodically transmit this message to all registered remote accessories to ensure that they have the proper data. This data message will also be sent immediately whenever there is a relevant change in the state of the CP650.

The least significant seven bits of the first byte in the data packet (received from the CP650) contains the current fader level, between 0 and 100. Divide by ten to obtain the correct fader level.

The most significant bit of the first byte in the data packet tells the remote accessory whether or not to blank its fader display (0 = display on, 1 = display off).

The least significant three bits of the second byte in the data packet contain the current format of the CP650. The value will be between 1 and 8, corresponding to the front-panel buttons as described above.

The next most significant bit tells whether the CP650 is muted (0 = not muted, 1 = muted).

The next most significant bit tells which projector is in use (0 = projector 1, 1 = projector 2).

The next most significant bit tells whether the current CP650 format is valid (0 = normal, 1 = invalid format).

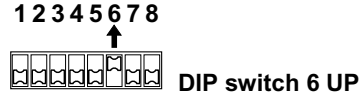
The next most significant bit tells whether the auditorium fader is active (0 = not active, 1 = active).

The most significant bit of the second data byte is not used.

Appendix F

Setup and User Menus

F.1 CP650 Setup Menu



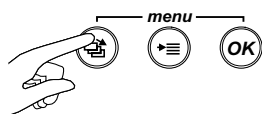
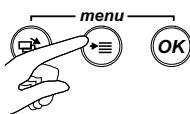
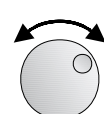
The *Bsl* and *Bsr* channels (shown in italics) are available only with Cat. No. 790 installed.
 The *Le* and *Re* channels (shown in italics) are available only with Cat. No. 791 installed.

B-Chain:





				Notes
	Format and CP650 Status Display		0–10	Adjust fader. Standard setting is 7.0.
1	Le/Re Channels (with Cat No. 791 crossover installed)		Enable/Disable <i>Le/Re</i> channel support	Crossover mode. must be Full Range or 2-Way. ←
2	Calibrate SPL		Enter room readings: 45–108.5 dB	Calibrates CP650 internal SPL meter to agree with auditorium sound level meter reading.
3	Output Levels Adjust (Initial)	Channel: Level:	L, C, R, Ls, <i>Bsl</i> , <i>Bsr</i> , Rs 1–127 (0.3 dB steps)	Subwoofer level is set in separate menu items.
4	Crossover mode (with Cat No. 791 crossover installed)	select: Select:	Full Range, 2-way, 3-way Enable/Disable	Must be Full Range or 2-Way in order to enable <i>Le/Re</i> .
5	Crossover Levels (with Cat No. 791 crossover installed)	Channel: Level	Select crossover output Select level	Available only with optional Cat. No. 791 crossover card installed.
6	Crossover Configuration (with Cat No. 791 crossover installed)	Channel: Parameter: Value:	Select L, C, or R Type, Freq, Slope, Delay Set value of the parameter selected above	Available only with optional Cat. No. 791 crossover card installed.
7	Digital Subwoofer Level Adjust (initial)	Level:	1–127 (0.3 dB steps)	
8	Bulk EQ Adjust	Channel: Bass Adjust: Treble Adjust: Corner Frequency:	L, C, R, Ls, <i>Bsl</i> , <i>Bsr</i> , Rs ± 6 dB ± 10 dB 1, 2, 3, 4 kHz	Set these before adjusting B-Chain EQ. (Corner fixed at 2 kHz for Ls, <i>Bsl</i> , <i>Bsr</i> , Rs)
9	B-Chain EQ Adjust		Select channel: L, C, R, Ls, <i>Bsl</i> , <i>Bsr</i> , Rs	OK Press OK to start. ←
			Select frequency band: 40 Hz–16 kHz ↔	
		Hold down middle button and turn the knob to adjust level: ±6 dB in the selected band.		

(Continued on next page)

CP650 Setup Menu, B-Chain (continued):

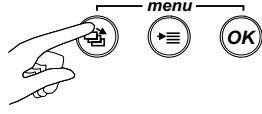
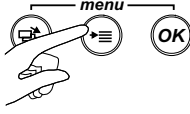
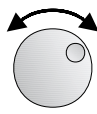


					Notes
10	Subwoofer EQ Adjust	EQ center frequency: EQ filter width (“Q”): Level Cut:	25–125 Hz 0.5, 1, 2, 4 0 to –12 dB		
11	Output Levels Adjust (Final)	Channel: Level:	L, C, R, Ls, Bsl, Bsr, Rs 1–127 (0.3 dB steps)		Final level adjustment after EQ.
12	Digital Subwoofer Level Adjust (Final)	Level:	1–127 (0.3 dB steps)		
13	Optical Subwoofer Bandwidth	50/100 Hz	50/100 Hz		Match SW to LF limit of main screen speakers.
14	Optical Subwoofer Level	Level: Polarity: Center Noise:	1–127 (0.3 dB steps) Normal/Inverse on/off		Perform final level adjustment and polarity check: Center noise LF output should decrease when polarity is inverse.

A-Chain:

15	Automatic Optical Level Adjust, Projector 1			Run Cat. No. 69T test film and press OK.
16	Automatic Optical Level Adjust, Projector 2			
17	Manual Optical Level Adjust, Projector 1			Run Cat. No. 69T test film and press OK.
		Left channel/Right channel	Adjust level of selected cell: 0–63 (0.3 dB steps)	
18	Manual Optical Level Adjust, Projector 2			Run Cat. No. 69T test film and Press OK.
		Left channel/Right channel	Adjust level of selected cell: 0–63 (0.3 dB steps)	
19	Optical Focus	Projector: Channel:	P1/P2 L / R	Adjust lens for max HF.
20	Automatic Slit-Loss Projector 1			Run Cat. No. 69P test film and press OK.
21	Automatic Slit-Loss Projector 2			
22	Manual Slit-Loss Projector 1	Channel:	L/R	
23	Manual Slit-Loss Projector 2	Value:	1–127	

(Continued on next page)

CP650 Setup Menu, (continued):

				Notes
24	Bypass Level Adjust			 Bypass/Normal set bypass trimpot(s)
25	Optical Surround Level Trim		-3 to +6 dB	Run Cat. No. 151B test film
26	Optical Surround Delay Adjust		20–150 ms	
27	Digital Surround Delay Adjust		20–150 ms	
28	Dolby Digital Reader delay		16–512 perfs	
29	Nonsync 1 Level Adjust		1–127	
30	Nonsync 2 Level Adjust		1–127	
31	Mono Level Trim		0 to -12 dB	
32	Mono EQ Adjust		LF  HF	
33	Preset Fader Levels	Format: Fader level set:	1,4,5,10,11,U1,U2,NS 0–10 or None	
34	User Format 1 Select		Select Format to assign to the U1 button.	
35	User Format 2 Select		Select Format to assign to the U2 button.	
36	Nonsync Format Select		Select Format to assign to the NS button.	
37	Format 80/81Options PCM Options	Auto Mute: Decode:	Disabled/Enabled L/R Stereo/Pro Logic	Mutes CP650 if not detecting Dolby Digital input bitstreams.
38	Reversion Mode	Normal/No Reversion	Normal/No Reversion	Recommended for test use only. Resets to Normal after powering on.
39	Auto Surround EX	Enabled/Disabled	Enabled/Disabled	
40	Noise Gating Active			Special application. For use with RT-60.
41	Auditorium Assist™	No Reference or Check Auditorium Set Reference		"No Reference" is displayed when no room measurements have been stored.
42	Noise Floor Optimization	Enabled/Disabled	Enabled/Disabled	When enabled, automatically improves noise floor characteristics of the CP650.
43	Authorization Password		Edit Password Digits	Use the Format buttons to enter password digits.
44	Clock Set	Hour: Minute:	Set Set	
45	Date Set	Day: Month: Year:	Set Set Set	

F.2 CP650 User Menu

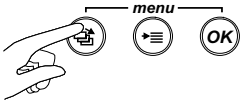
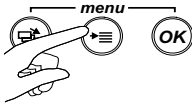
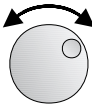


The options shown in bold are the default settings when the unit was shipped from the factory.

				Notes
	Format and CP650 Status Display			This is the top-level menu display.
1	Fader Setting	Local/Auditorium	Local/Auditorium	
2	Preset Fader Levels	Format: Fader level set:	1,4,5,10,11,U1,U2,NS 0-10 or None	
3	Auto Dolby Digital	Enabled/Disabled	Enabled/Disabled	
4	Auto Digital Target		Select Target Format: Format 10 or Format 13	Format 13 must be one of the user formats.
5	Rotating Pink Noise			Press OK to start/stop movement.
6	Auditorium Assist™	Check Auditorium or No Reference		"No Reference" is displayed when no room measurements have been stored.
7	Automatic Optical Level Adjust Projector 1			Run Cat. No. 69T test film. Press OK to start. Press OK to save.
8	Automatic Optical Level Adjust Projector 2			Press OK to start. Press OK to save.
9	Manual Optical Level Adjust Projector 1		Set level	Press OK to start. Press OK to save.
10	Manual Optical Level Adjust Projector 2		Set level	Press OK to start. Press OK to save.
11	User Format 1 Select		Select Format to assign to the U1 button	Default is Format 13 .
12	User Format 2 Select		Select Format to assign to the U2 button	Default is Format 65 .
13	Nonsync Format Select		Select Format to assign to the NS button	Default is Format 60 .
14	Format 80/81 PCM Options	Auto Mute: Decode:	Disabled/Enabled L/R Stereo/Pro Logic	Mutes CP650 if not detecting Dolby Digital or Dolby E input bitstreams.
15	Mute Fade-In Time		0.2-5 Seconds	
16	Mute Fade-Out Time		0.2-5 Seconds	
17	Power-On Format Select	Select from Format list or select Last Format used.	Select from Format list or select Last Format used.	

(Continued on next page)

CP650 User Menu, Continued

				<p>Notes</p>
<p>18</p>	<p>Contrast Adjustment</p>		<p>Set the display contrast.</p>	
<p>19</p>	<p>Event Log</p>		<p>Scroll up and down the event listing.</p>	
<p>20</p>	<p>About this CP650—Screen 1</p> <ul style="list-style-type: none"> • Control software version number • Optional boards installed 			<p>Useful for telephone discussions.</p>
<p>21</p>	<p>About this CP650—Screen 2</p> <ul style="list-style-type: none"> • Software module version numbers 			
<p>22</p>	<p>About this CP650—Screen 3</p> <ul style="list-style-type: none"> • Network address • Board version numbers 			<p>The version numbers are listed for each board in the following order: Cat. No. 772A, Cat. No. 773, Cat. No. 774A, Cat. No. 777, Cat. No. 790 or 794 "x"= Board not installed</p>
<p>23</p>	<p>Remote Addresses</p>			<p>Displays the single-digit address of each attached remote unit (three remotes maximum).</p>
<p>24</p>	<p>Return to the Top-Level Menu Display</p>			

