

# CARVER

P R O F E S S I O N A L

PM-350

## MAGNETIC FIELD POWER AMPLIFIER SERVICE MANUAL

CONTENTS	Page
1. SAFETY INFORMATION.....	3
2. INTRODUCTION.....	4
3. SPECIFICATIONS .....	5
4. CIRCUIT DESCRIPTIONS .....	6
5. TEST PROCEDURE.....	12
6. SCHEMATICS AND LAYOUTS.....	15
7. PARTS ORDERING .....	23
8. PARTS LIST.....	24
9. VOLTAGE CONVERSION .....	32
10. SERVICE BULLETINS .....	33

# SECTION 1

## SAFETY INFORMATION

### WARNING.

Any person performing the procedures described in this manual will be exposed to hazardous voltages and the risk of electric shock.

Carver Corporation assumes that any person who removes the cover from the unit has been properly trained in protecting against avoidable injury and shock.

Therefore, the procedures described here are to be performed by qualified electronics service personnel only.

We recommend that the unit be tested only when line isolation is provided by an isolation transformer. The line cord of the unit must be disconnected and the power supply fully discharged before any components are replaced. Failure to do so may result in severe damage to the unit and the risk of electric shock.

The safety tests described below must be performed properly.

### CAUTION:

Before returning the unit to the customer, one of the following safety tests must be performed.



1. Check the leakage current. Connect the unit to 120 VAC supply and turn the power switch "ON". Using an ammeter, measure the current between the neutral side of the AC supply and chassis ground of the unit under test. If leakage current exceeds 0.5mA, the unit is defective.

Reverse the polarity of the AC supply and repeat.

2. Measure the resistance from either side of the linecord to chassis ground. If it is less than 500k ohms, the unit is defective.

**WARNING - DO NOT** return the unit to the customer if it fails one of these tests until the problem is located and corrected.

### CAUTION

	<b>CAUTION</b> RISK OF ELECTRIC SHOCK DO NOT OPEN	
CAUTION: TO REDUCE THE RISK OF ELECTRIC SHOCK DO NOT REMOVE COVER (OR BACK) NO USER-SERVICEABLE PARTS INSIDE REFER SERVICING TO QUALIFIED PERSONNEL		



The lightning flash with arrowhead symbol within an equilateral triangle is intended to alert the user to the presence of uninsulated "dangerous voltage" within the product's enclosure, that may be of sufficient magnitude to constitute a risk of electric shock to persons.



The exclamation point within an equilateral triangle is intended to alert the user of the presence of important operating and maintenance (servicing) instructions in the literature accompanying the appliance.

## SECTION 2

### INTRODUCTION

This manual is intended for use by qualified, authorized personnel only.

Due to the unique and complex circuit designs of Carver Corporation, the following procedure is recommended to diagnose & repair problems with speed and accuracy.

The best way to figure out what is wrong is to learn what is working properly first. Then, through the process of elimination, the defective area can be located. Upon locating the defective area, you then would use your own preferred troubleshooting skills.

The removal of parts for testing, should be kept to an absolute minimum. "In circuit" analysis should provide you with enough data to determine correct operation.

At Carver Corporation we continually strive for the most reliable, cost-efficient product available.

When updates and service bulletins are sent to you, please take the time to review them and insert them into the correct service manuals.

The Carver PM-350 Magnetic Field Power Amplifier was released in July of 1986. It was in production until early 1990 when the entire line of professional power amplifiers was redesigned and renamed for the 1990's.

The PM-350 has an accessory cover on the rear panel which can be removed for installing the Carver PMX Electronic Crossover Module. Beginning at S/N 5001, the connectors were changed for interconnecting the PMX with the PM-350. PM-350 amplifiers with S/N 5000 and below will accept PMX crossovers with S/N below 600, unless the amplifier has been modified as described in Service Bulletin PM-350-5 (see Section 10). The PM-350 will also accept the Carver PG/2 Paging Module and the Carver PMT-2 Input Module, which provides transformer balanced inputs. However, the PM-350 interconnect must be modified to accommodate these modules as described in Service Bulletin PM-350-5 for the PMX Module.

The balanced XLR inputs of the PM-350 were configured for pin 2 high (DIN standard) from S/N 0001 through 1625. Beginning with S/N 1626 the XLR inputs were configured with pin 3 high (American standard).

The PM-350 is a stereo power amplifier rated at 350W per channel into 8 ohms and 450W per channels into 4 ohms. In bridged mono mode, it will deliver 900W into 8 ohms.

## SECTION 3

### SPECIFICATIONS

#### Specifications for the PM-350 Magnetic Field Power Amplifier

##### Power Output:

Continuous Average Output Power, both channels driven:

350 watts per channel into 8 ohms from 20 Hz to 20 kHz, with no more than 0.5% THD  
450 watts per channel into 4 ohms from 20 Hz to 20 kHz, with no more than 0.5% THD

Bridged-mono operation:

900 watts into 8 ohms from 20Hz to 20 kHz, with no more than 0.5% THD  
1000 watts into 70V distribution system

Frequency Response:	20Hz to 20kHz (+0, - 0.5dB)
Damping Factor:	Greater than 200 at 1kHz
Input Impedance:	15k ohms unbalanced; 30k ohms balanced
Sensitivity:	1.5V rms for rated power into 8 ohms at 1kHz. 80mV rms for 1W output into 8 ohms at 1kHz.
Gain:	31dB
Input Overload:	+15dBu
IM Distortion:	Less than 0.1%
THD:	Less than 0.5%
Noise:	-115dB A-weighted, referenced to rated power -89dBW A-weighted, referenced to 1W
Slew Rate:	25V/ $\mu$ S
Power Consumption:	1200W at full power
Power Requirements:	120VAC/60Hz (USA and Canada) 230VAC/50Hz (Europe)
Display:	4 LED's; Power On, Protect, Clip and Signal Present
Size (H x W x D):	3.5" x 19" x 11.5" (13.5" overall) 89mm x 483mm x 292mm (343mm overall)
Weight:	21 lbs. 9.5 kg

Test Note: Accurate measurement depends on a sufficiently "stiff" AC supply. The 60 Hz AC line distortion must be below IHF specifications.

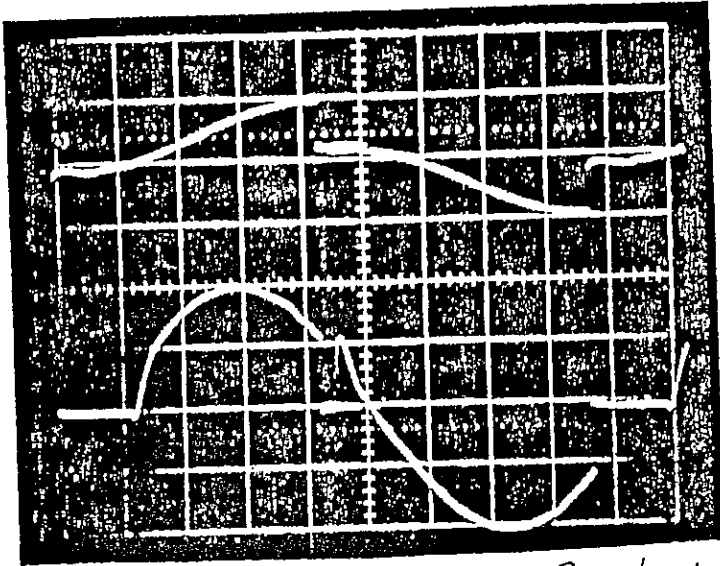

START UP VOLTAGES

VOLTAGE ACROSS C4

VOLTAGE ACROSS TRIAC

FIG. 1 2ms/DIV

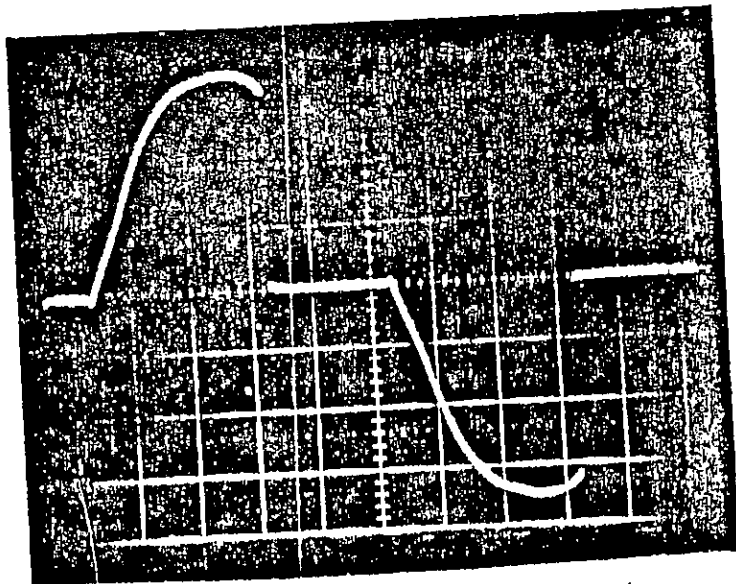

VOLTAGE ACROSS TRIAC  
AT IDLE

FIG. 2 2ms/DIV

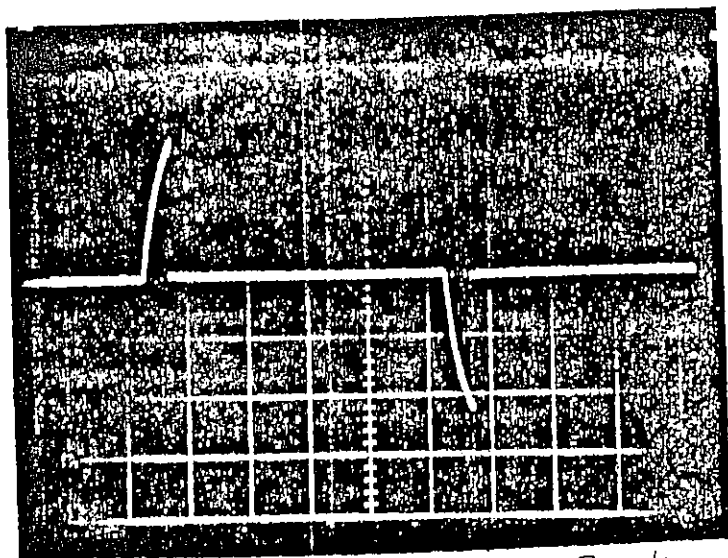

VOLTAGE ACROSS TRIAC  
AT RATED POWER  $8\Omega$

FIG. 3 2ms/DIV

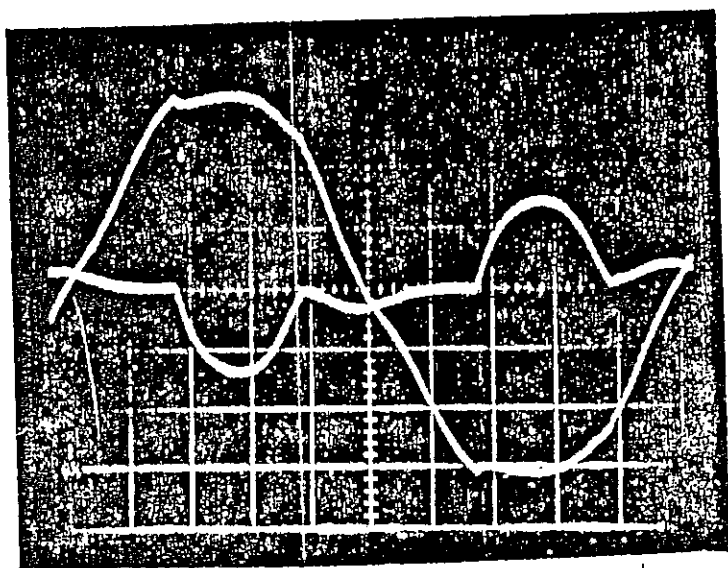

LINE CURRENT  
LINE VOLTAGE  
RATED POWER  $8\Omega$

FIG. 4 2ms/DIV

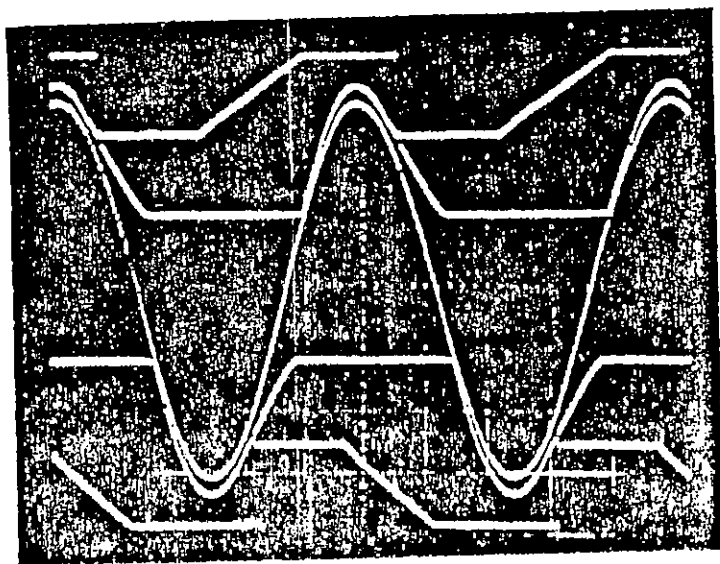

COMMUTATED POWER SUPPLIES  
+56  
+27  
OUTPUT  
-27  
-56

FIG. 5 2ms/DIV



# SECTION 6

## SCHEMATICS AND LAYOUTS

	Page
PM-350 Amp Schematic .....	16
PM-350 Amp Board Layout.....	17
PM-350 Regulator Schematic .....	18
PM-350 Regulator Board Layout .....	19
PM-350 Final Assembly .....	20
PM-350 Wiring Diagram .....	21
PM-350 Button-Up .....	22

# SECTION 4

## CIRCUIT DESCRIPTION

### PM-350

#### TECHNICAL DESCRIPTION

The magnetic-field amplifier design incorporated in the PM-350 allows a degree of efficiency and protection unequaled in conventional amplifiers.

The high efficiency and comprehensive protection are made possible by a triac phase controlled power supply and multiple level DC amplifier supplies. These features greatly reduce size, weight, heat and cost per watt.

To better understand this design, which is far from conventional, the following circuit description should be read carefully. Attempting to repair the unit without the following information may lead to severe damage to the unit.

#### PRIMARY CIRCUIT

The 230V PM-350 is fused with an MDL 6-1/4 amp fuse. The 115V PM-350 is fused with an MDQ 10 amp fuse. It is thermally protected by a 100° C thermal breaker.

An RC line filter network is used to suppress line noise generated by the triac conduction, and to reduce noise already present on the AC line.

The PM-350 power supply provides both AC line and secondary load regulation. This is achieved through triac phase control.

#### START-UP SEQUENCE

The triac and power to the unit is held off as long as the power switch shorts out the phase shift capacitor C4 on the regulator board.

Once the power switch is turned on and C4 is unshorted, C4 will charge through R8 and Q2 or Q3 depending on the polarity. The "+" half cycle of the AC line will charge C4 through R8 and Q3. This charging current causes Q3 to conduct which turns on Q4. No gate current will flow because D6 is reverse biased. C4 will continue charging until the

charge on C4 is greater than the now falling line voltage formed by divider R8 and R9 (see figure 1). Q3 and Q4 will turn off and C4 will begin to discharge through Q2 because the junction of R8 and R9 is more negative than the emitter of Q2 (C4). Q2 will conduct and turn on Q1. The positive charge on C4 will now supply gate current through Q1, Q2, D5 and R10, and thus turn on the triac. The triac fires at the same point on the negative half cycle. The negative charge on C4 supplies gate current through Q3, Q4, D6 and R10.

This minimum triac conduction angle provides enough voltage to the primary of the power transformer to allow the secondary regulator stage on the amp board to begin operating.

OC1 LED current is supplied by U1 pin 1. This differential amplifier senses the low voltage secondary supplies through R22, R23, R24, R28, R29 and R30. The output voltage at U1 pin 1 increases at the rate determined by C3 (slow start up). OC1 photo transistor will begin to conduct and charge C4 on the regulator board at a faster rate through R2. This decrease in phase shift results in a longer triac conduction time and higher secondary voltages. The idle secondary voltages are set by RP1 on the amp board. The top supply should be set to 95Vdc cold (20-30° C). The triac conduction angle at idle is shown in Figure 2. The secondary DC voltages at idle should be approximately +/- 97V, 56V, 27V, 13V and 10V.

#### LOAD REGULATION

The conduction angle of the triac, which controls the voltage on the primary of the transformer, is increased as the conduction of OC1 increases. The phototransistor conduction of OC1 is controlled by OC1 LED current. When either amplifier channel of both are driven into a load (8 or 4 ohm), the DC supplies will begin to "sag". Differential



amplifier U1 (pins 1, 2, 3) senses this and increases OC1 LED current. This action increases the following in the primary circuit:

- OC1 phototransistor conduction
- Triac conduction
- Primary voltage

Increasing the primary transformer voltage regulates the secondary voltages. Load regulation at rated power into 8 ohms is within 10% or 7Vdc.

Figure 3 is the conduction angle and voltage across the triac at full power. Figure 4 is the primary current and line voltage. The amplifier is being driven to rated power into 8 ohms, both channels.

## AMPLIFIER CIRCUITRY

Both channels are basically identical, therefore for the purpose of simplification reference to only the right channel will be made.

The input circuit used in the PM-350 is an electronic balanced type, which can be driven by either the XLR or the parallel TRS 1/4" phone jacks.

The output of the differential amplifier (U2) is coupled to the right level control through the accessory module jumpers (pins 5-6).

The wiper of the level control pot is coupled to the input buffer op-amp U101 through the mono bridging switch. R105 provides local negative feedback around U101 to decrease the differential gain at clipping. The output of the input buffer is coupled to Q101 and Q110 which provide a current source for DC biasing and also provide DC level shifting which is required for referencing the audio signal to the top DC supplies. The output of the DC level shifters drives a pair of predriver voltage amplifiers (Q102 and Q111). This stage provides full voltage swing to the following current gain stages and supplies "tracking" for the commutator circuits.

The bias network of Q103 and Q104 provides adjustment of the DC idle current through outputs Q109 and Q117. Q104 is mounted on the heatsink and provides thermal feedback to prevent thermal runaway and helps maintain a constant idle current. RP100 on the amp board adjusts the idle current, which should be adjusted so that the common mode current is approximately 15mA cold (20-30° C).

The predrivers drive the "driver" stage (Q106 and Q113) which provide current amplification for driving the outputs and supply commutating circuitry.

Under a short circuit condition, the available current to the base of the drivers is limited by limiter transistors Q105 and Q112. Q105/Q112 are biased on by the voltage drop across the output emitter resistors R133 and R157. Q105 also provides a shutdown pulse to the protection mute circuitry (see overcurrent protection).

Q105 will also be biased on by excessive high frequency. This is achieved with C108. As frequency increases, the current through R123 increases on a positive going output voltage, turning on Q105 sooner with higher frequencies.

Current from drivers Q106 and Q113 provide drive for the two high gain, high linearity output devices Q109 and Q117. These devices provide full voltage swing and current drive to the loads.

The active local bias network of Q114, R129 and R151 provides variable "pull-down" of the bases of Q109 and Q117 to help prevent common-mode conduction of the output transistors and reduce their turnoff time.

The first supply commutator transistors, Q107/Q108 and Q115/Q116 are used to increase the supply voltages on the collectors of Q109 and Q117 from 21V to 44V as required. The diode network of D107, D108 and D109 (and their negative equivalents) in the base of Q109 and Q117 provide voltage "lead" for the first supply commutating transistors Q107/Q108 and Q115/Q116. This allows the supply voltages to stay ahead of the audio demand. As frequency increases, Q107/Q108 and Q115/Q116 require additional "lead" time to stay ahead of the audio. This is achieved by C109 and R126 (and their negative equivalents).

The first commutator transistors operate linearly and "track" the audio output. The second commutator transistors are switching type (see figure 5). The second commutators Q122 and Q119 switch on when the peak output voltage is within 12 volts of the +/-44V supplies. The turn-on threshold is set by zener diodes D122, D119. As the output of the amplifier is increased and Q120, Q123 are biased on, Q118, Q121 will turn on and will switch on commutators Q119, Q122.

The second supply commutators Q119, Q122 switch the supply voltages on the collectors of Q107/Q108 and Q115/Q116 from +/-44V to +/-70V

as required (voltages are lower depending on load). This in turn allows Q107/Q108 and Q115/Q116 to increase Q109 and Q117 collector voltages to within a few volts of the top supply, 70Vdc (see figure 5).

D110, D118, D117 and D121 prevent current from the higher commutated supplies from flowing back into the lower supplies.

If the clipping eliminator switch is pushed, then the input signal is processed by a circuit which consists of an optocoupler U102, a "steering" bridge (D125-D128), and a filter network (R176, R177, C123). The clipping eliminator is driven by the error signal on the output of input buffer U101. Distortion in excess of 1% will provide sufficient drive to attenuate the input and light the headroom exhausted LED on the display. This circuit will prevent distortion in excess of 3% with up to 15dB of overdrive on the input.

## PROTECTION CIRCUITS

Depending on the fault condition, the type of protection may be handled in one of three ways:

1. Inputs muted.
2. Triac conduction angle reduced to minimum value.
3. In-line thermal switch shuts off the unit temporarily.

The protection circuits are:

- A) Turn-on mute
- B) Overcurrent
- C) Excessive high frequency
- D) DC offset
- E) Low voltage fault
- F) Thermal

### A) TURN-ON MUTE

When the amplifier is turned on, FET Q1 and Q2 shunt the left and right channel respectively to ground. C1 is charged up through R6. After approximately 4 seconds Q3 will turn on and apply -13Vdc to the junction of R1/R2. This will pinch off Q1 and Q2 and the signal paths will unmute.

### B) OVERCURRENT

Short circuit current limiting is limited by Q105, Q112 on the right channel (Q205, Q212 on the left). When the short circuit current through emitter resistors R133 (R233) or R157 (R257) is greater

than 7.6 amps, Q105 (Q205) or Q112 (Q212) will turn on and will clamp the base drive current to Q106 (Q206) or Q113 (Q213).

Conduction of Q105 or Q205 will turn on Q8. Q8 will supply base current through D10 to turn on Q9 and light the protect LED. Q8 will also provide base current for Q4 allowing it to turn on and short out C1. Shorting out C1 will turn on both FETs (Q1/Q2) and mute both channels for 4 seconds repeatedly until the short is removed.

### C) EXCESSIVE HIGH FREQUENCY

When either amplifier (left or right) is driven at excessive high frequencies, C108 or C208 will supply base current to Q105 or Q205. This will mute the inputs the same as the short circuit condition and light the protect LED. C108 (C208) should only turn on Q105 (Q205) at frequencies greater than 20kHz.

### D) DC OFFSET

DC present at the output of either channel is coupled to a low pass filter. C7, R44 and R45 roll off the output in the audio spectrum. DC voltages greater than +/-8V on the left channel or +/-14V on the right channel will cause the output of comparator U1 pin 7 to go from -13V to +13Vdc. This will forward bias D11, turning the protect LED on. D7 also is forward biased driving the regulator U1 pin 1 negative and cutting off OC1 LED current. This causes the conduction angle of the triac to be reduced.

Since both channels are AC coupled by C101 (C201), DC fault protect would only occur if an internal fault condition existed. This will normally represent a load on the amplifier and with no regulation the maximum sustained DC output voltage will be less than +/-10Vdc.

Internal fault failures cause the protect LED to glow dimly because the secondary power supplies are reduced.

### E) LOW VOLTAGE FAULT

Failure of either the +/-10Vdc or +/-13Vdc supplies will result in regulator U1 pin 1 being driven negative. With no OC1 LED current, the conduction angle of the triac is minimum and therefore the secondary supplies are low. With very low power supplies the amplifier offset is low.

## F) THERMAL

Thermal protection is accomplished by an in-line thermal switch that will switch the unit temporarily off when the heatsink reaches 100° C. Reset time is determined by the ventilation allowed. Reset temperature is 70° C.

## DISPLAY

**Power LED:** connected in series with a 15k ohm resistor across the +/- 13Vdc supply.

**Signal Present LED:** Q7 on the amp board is driven directly off the output of both channels. The LED will light at about 0.1 watt output into 8 ohms in dual channel operation, and 0.5 watts in the bridged mono operation.

**Clip LED:** The negative differential output at clipping from U201 pin 1 or U101 pin 1 quickly charges C2 through R8, R11 and D2, D3. The negative charge on C2 turns on Q5 which drives Q6 to light the clip LED. The turn off time of the LED is determined by the RC time constant C2, R13.

**Protect LED:** As explained in the protection circuit section, the protect LED may light from either a short circuit condition, excessive high frequency or a DC offset at either amplifier output. For the first two faults the LED will be bright and last for four seconds (same as the mute time). The on time is determined by C8, R47 and R48. When the latter (DC offset) occurs the power supply is reduced to minimize the offset and the LED will be dim. A dim protect LED will usually indicate an internal amplifier or power supply fault, while a bright protect LED will indicate an external amplifier problem.

## COOLING

The PM-350 is cooled by a variable speed fan that increases airflow in direct proportion to the power output of the amplifier. This is accomplished by controlling the voltage to the fan directly in relation to the triac conduction angle. This is done by D25, D26, R68, R69, R70 and C31. When the heatsink reaches a temperature of about 50° C, the thermal switch in the fan circuit closes and shorts out R68. This increases the airflow and cooling capacity by about 2 times.

**SECTION 5**  
**TEST PROCEDURE**  
**PM-350**

**CAUTION**

All primary waveforms must be viewed with an isolated, line triggered scope with no secondary ground reference.

1. Set RP-100 and RP-200 bias controls for minimum idle current (fully CCW). Set RP-1 for minimum secondary voltage (fully CCW). Set level pots fully CW.
  2. Plug unit into variac and bring variac up until the optocoupler conducts, approximately 85Vac line.
    - a) Check for triac conduction and symmetry.
    - b) Both channels pass a signal with a crossover notch.
    - c) Check for balanced supplies, approximately:
      - +/-75Vdc on the large filter capacitors
      - +/-43Vdc on the cathode of D19 and anode of D21
      - +/-21Vdc on the cathode of D15 and anode of D17
      - +/-13Vdc on U2 pins 4 and 8
      - +/-10Vdc on U101 pins 4 and 8
  3. Bring Variac up to 120Vac line. Input a 1Vrms signal at 2kHz into both channels, with an 8 ohm load connected to both outputs.
    - a) Check signal present LED.
    - b) Check for triac firing (triac will not fire if there is excessive current draw).
    - c) Verify both channels pass 2kHz, 1Vrms signal with crossover notch.
  4. Disconnect inputs. Set top rail to +/- 95Vdc cold (97Vdc warm).
  5. Adjust idle current after 2 minutes warm-up.
    - a) Adjust RP-100 for 2.5mVdc (+/-0.5mV) across R133 with no load. This will set the right channel idle current.
    - b) Adjust RP-200 for 2.5mVdc (+/-0.5mV) across R233 with no load. This will set the left channel idle current.
  6. Check triac for good symmetry.
    - a) Triac firing must remain symmetrical and continuous from 100Vac to 135Vac line.
    - b) Highest rail must be <99Vdc at 135Vac line.
  7. Frequency response.
    - a) Set amp for 2.44Vrms output (+10dBm) into an 8 ohm load.
    - b) Verify output is flat from 20Hz to 20kHz (+/- 0.5dB).
  8. Check level pots.
  9. Common mode rejection.
    - a) Verify common mode rejection ratio is <-45dB.
-

10. Input connections.
    - a) Set amp for 2.44Vrms output at 2kHz into an 8 ohm load.
    - b) Check mono switch for 180 deg phase shift on the left channel.
    - c) Check that both XLR and TRS 1/4" inputs are functional.
  11. Check both channels at 2kHz full power into 8 ohm loads.

Note: 350W into 8 ohms = 52.9Vrms.

    - a) Verify symmetrical clipping.
    - b) Verify that clip LED lights within 0.5dB of clipping.
    - c) Verify commutator operation at 2kHz and 6kHz. First commutator is a tracking type, second is a switching type.
    - d) Verify distortion <0.25% at full power (350W/8 ohms).
  12. Check power bandwidth at full power.
    - a) Verify 52.9Vrms at 20Hz for 4 seconds without blowing fuse.
    - b) Verify 52.9Vrms at 20kHz with now shut-down (do not run amp for more than 5 seconds at 20kHz).
  13. Check high frequency trip point.
    - a) Check both channels independently.
    - b) Unit must not shut-down driven with 20kHz before clipping (do not run amp for more than 5 seconds at 20kHz).
    - c) Unit will mute when slightly into clipping, 20-30% distortion.
    - d) Verify mute time of 4 seconds, +/-1 sec.
    - e) Verify protect LED lights.
  14. Check DC offset protection.
    - a) Set amp for an output of 10Vrms at 2kHz into an 8 ohm load.
    - b) Short cathode of D13 to node of R203 and R202. Verify amp shuts down.
    - c) Short cathode of D13 to node of R103 and R202. Verify amp shuts down.
    - d) Verify shut down time of 4 seconds, +/-1 sec.
  15. Check 10 volt fault trip.
    - a) Set amp for an output of 10Vrms at 2kHz into an 8 ohm load.
    - b) Short cathode of D13 to ground. Verify unit shuts down for 4 seconds, +/-1 sec.
    - c) Short anode of D14 to ground. Verify unit shuts down for 4 seconds, +/-1 sec.
  16. Check overcurrent trip.
    - a) Set amp for an output of 10Vrms at 2kHz into an 8 ohm load.
    - b) Short left channel output and verify amplifier shuts down with no increase in line current.
    - c) Short right channel output and verify amplifier shuts down with no increase in line current.
    - d) Shut down time is 4 seconds, +/-1 sec.
  - 17) Low frequency test.
    - a) Drive each channel independently at 10Hz to clipping into an 8 ohm load. Verify amp does not shut down.
  - 18) 4 ohm power test.
    - a) Drive both channels to 32.0Vrms into 4 ohms (250W/4 ohms). Line voltage must be maintained at 120Vrms.
    - b) Verify distortion <0.5%, both channels driven.
-

- 19) Noise.
  - a) Verify noise  $<168\mu\text{V}$  ( $-73.3\text{dBm}$ ;  $-75.5\text{dBV}$ ) A-weighted, with inputs shorted.
- 20) Gain.
  - a) Verify gain is  $31\text{dB}$  ( $\pm 1\text{dB}$ ).
- 21) Turn off thump.
  - a) Set amp for  $1\text{Vrms}$  output at  $2\text{kHz}$ , both channels into and  $8\text{ ohms}$  load.
  - b) Turn amplifier off and verify less than  $\pm 2\text{V}$  peak.
- 22) Restart test.
  - a) Set line voltage to  $95\text{Vac}$ . Verify unit will turn back on and confirm operation.
- 23) Line Leakage.
  - a) With an approved safety analyzer, verify line leakage is less than  $500\mu\text{A}$  from both high and low sides of the line to ground.
- 24) Dielectric Breakdown.
  - a) With a calibrated and approved tester, verify that the unit can withstand application of a  $1000\text{ Vac}$  signal for at least one second.
  - b) Apply the signal between either side of the line and an exposed ground on the unit. The power switch should be ON.

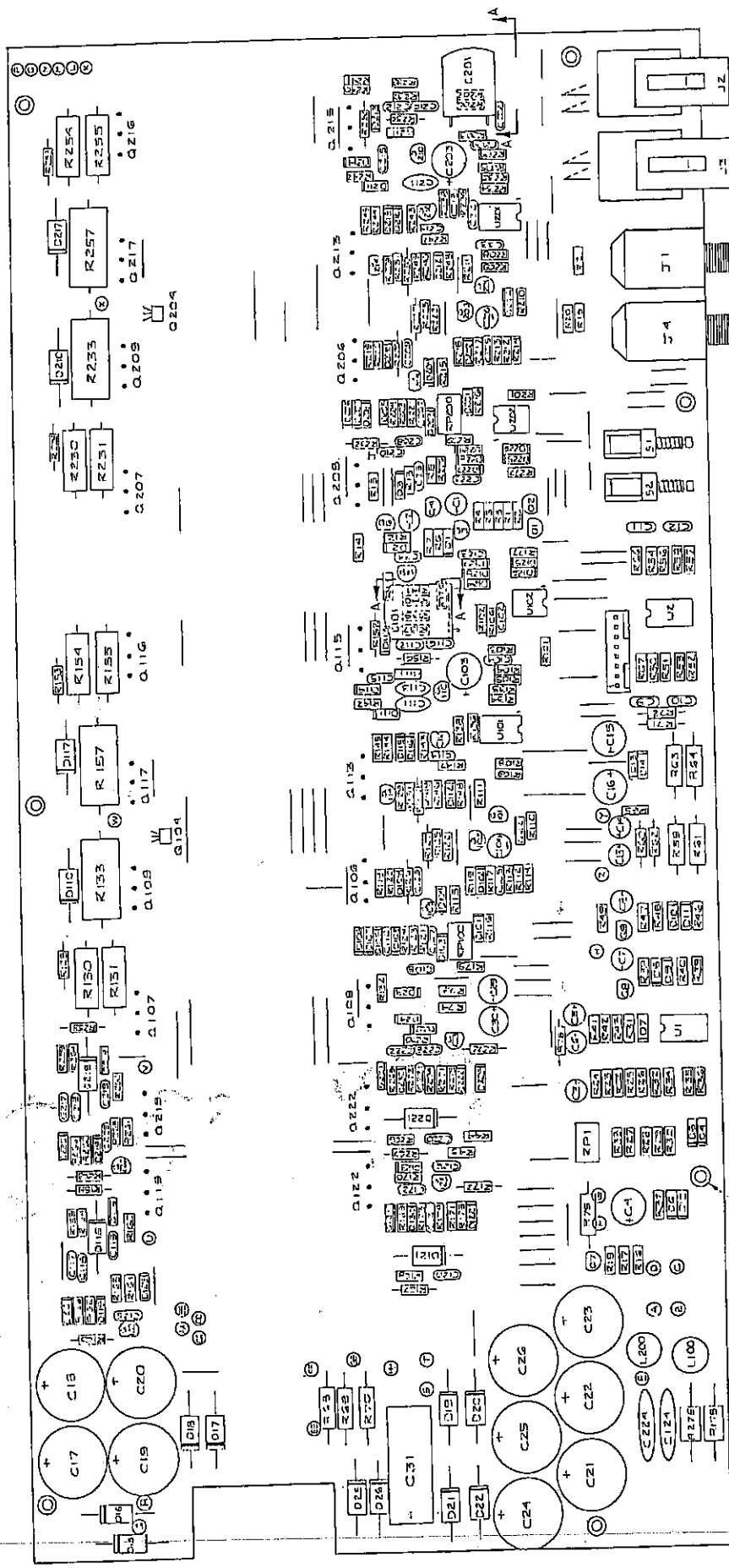

CARVER CORP.	
1	RM-350 AME
2	PARTS LOCATOR
3	REV. 1
4	REV. 2
5	REV. 3
6	REV. 4
7	REV. 5
8	REV. 6
9	REV. 7
10	REV. 8
11	REV. 9
12	REV. 10
13	REV. 11
14	REV. 12
15	REV. 13
16	REV. 14
17	REV. 15
18	REV. 16
19	REV. 17
20	REV. 18
21	REV. 19
22	REV. 20
23	REV. 21
24	REV. 22
25	REV. 23
26	REV. 24
27	REV. 25
28	REV. 26
29	REV. 27
30	REV. 28
31	REV. 29
32	REV. 30
33	REV. 31
34	REV. 32
35	REV. 33
36	REV. 34
37	REV. 35
38	REV. 36
39	REV. 37
40	REV. 38
41	REV. 39
42	REV. 40
43	REV. 41
44	REV. 42
45	REV. 43
46	REV. 44
47	REV. 45
48	REV. 46
49	REV. 47
50	REV. 48
51	REV. 49
52	REV. 50
53	REV. 51
54	REV. 52
55	REV. 53
56	REV. 54
57	REV. 55
58	REV. 56
59	REV. 57
60	REV. 58
61	REV. 59
62	REV. 60
63	REV. 61
64	REV. 62
65	REV. 63
66	REV. 64
67	REV. 65
68	REV. 66
69	REV. 67
70	REV. 68
71	REV. 69
72	REV. 70
73	REV. 71
74	REV. 72
75	REV. 73
76	REV. 74
77	REV. 75
78	REV. 76
79	REV. 77
80	REV. 78
81	REV. 79
82	REV. 80
83	REV. 81
84	REV. 82
85	REV. 83
86	REV. 84
87	REV. 85
88	REV. 86
89	REV. 87
90	REV. 88
91	REV. 89
92	REV. 90
93	REV. 91
94	REV. 92
95	REV. 93
96	REV. 94
97	REV. 95
98	REV. 96
99	REV. 97
100	REV. 98

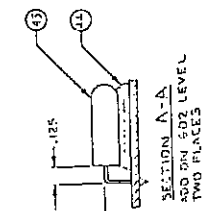

INSTALL FERM-NUT  
T PL

- NOTES: UNLESS OTHERWISE SPECIFIED,  
 1. ALL RESISTORS ARE IN OHMS 1/4WATT  
 2. ALL CAPACITORS ARE IN MICROFARADS  
 3. ALL DIODES ARE 4148  
 4. U1, U2, U3, U4, U5, U6, U7, U8, U9, U10, U11, U12, U13, U14, U15, U16, U17, U18, U19, U20, U21, U22, U23, U24, U25, U26, U27, U28, U29, U30, U31, U32, U33, U34, U35, U36, U37, U38, U39, U40, U41, U42, U43, U44, U45, U46, U47, U48, U49, U50, U51, U52, U53, U54, U55, U56, U57, U58, U59, U60, U61, U62, U63, U64, U65, U66, U67, U68, U69, U70, U71, U72, U73, U74, U75, U76, U77, U78, U79, U80, U81, U82, U83, U84, U85, U86, U87, U88, U89, U90, U91, U92, U93, U94, U95, U96, U97, U98, U99, U100, U101, U102, U103, U104, U105, U106, U107, U108, U109, U110, U111, U112, U113, U114, U115, U116, U117, U118, U119, U120, U121, U122, U123, U124, U125, U126, U127, U128, U129, U130, U131, U132, U133, U134, U135, U136, U137, U138, U139, U140, U141, U142, U143, U144, U145, U146, U147, U148, U149, U150, U151, U152, U153, U154, U155, U156, U157, U158, U159, U160, U161, U162, U163, U164, U165, U166, U167, U168, U169, U170, U171, U172, U173, U174, U175, U176, U177, U178, U179, U180, U181, U182, U183, U184, U185, U186, U187, U188, U189, U190, U191, U192, U193, U194, U195, U196, U197, U198, U199, U200, U201, U202, U203, U204, U205, U206, U207, U208, U209, U210, U211, U212, U213, U214, U215, U216, U217, U218, U219, U220, U221, U222, U223, U224, U225, U226, U227, U228, U229, U230, U231, U232, U233, U234, U235, U236, U237, U238, U239, U240, U241, U242, U243, U244, U245, U246, U247, U248, U249, U250, U251, U252, U253, U254, U255, U256, U257, U258, U259, U260, U261, U262, U263, U264, U265, U266, U267, U268, U269, U270, U271, U272, U273, U274, U275, U276, U277, U278, U279, U280, U281, U282, U283, U284, U285, U286, U287, U288, U289, U290, U291, U292, U293, U294, U295, U296, U297, U298, U299, U300, U301, U302, U303, U304, U305, U306, U307, U308, U309, U310, U311, U312, U313, U314, U315, U316, U317, U318, U319, U320, U321, U322, U323, U324, U325, U326, U327, U328, U329, U330, U331, U332, U333, U334, U335, U336, U337, U338, U339, U340, U341, U342, U343, U344, U345, U346, U347, U348, U349, U350, U351, U352, U353, U354, U355, U356, U357, U358, U359, U360, U361, U362, U363, U364, U365, U366, U367, U368, U369, U370, U371, U372, U373, U374, U375, U376, U377, U378, U379, U380, U381, U382, U383, U384, U385, U386, U387, U388, U389, U390, U391, U392, U393, U394, U395, U396, U397, U398, U399, U400, U401, U402, U403, U404, U405, U406, U407, U408, U409, U410, U411, U412, U413, U414, U415, U416, U417, U418, U419, U420, U421, U422, U423, U424, U425, U426, U427, U428, U429, U430, U431, U432, U433, U434, U435, U436, U437, U438, U439, U440, U441, U442, U443, U444, U445, U446, U447, U448, U449, U450, U451, U452, U453, U454, U455, U456, U457, U458, U459, U460, U461, U462, U463, U464, U465, U466, U467, U468, U469, U470, U471, U472, U473, U474, U475, U476, U477, U478, U479, U480, U481, U482, U483, U484, U485, U486, U487, U488, U489, U490, U491, U492, U493, U494, U495, U496, U497, U498, U499, U500, U501, U502, U503, U504, U505, U506, U507, U508, U509, U510, U511, U512, U513, U514, U515, U516, U517, U518, U519, U520, U521, U522, U523, U524, U525, U526, U527, U528, U529, U530, U531, U532, U533, U534, U535, U536, U537, U538, U539, U540, U541, U542, U543, U544, U545, U546, U547, U548, U549, U550, U551, U552, U553, U554, U555, U556, U557, U558, U559, U560, U561, U562, U563, U564, U565, U566, U567, U568, U569, U570, U571, U572, U573, U574, U575, U576, U577, U578, U579, U580, U581, U582, U583, U584, U585, U586, U587, U588, U589, U590, U591, U592, U593, U594, U595, U596, U597, U598, U599, U600, U601, U602, U603, U604, U605, U606, U607, U608, U609, U610, U611, U612, U613, U614, U615, U616, U617, U618, U619, U620, U621, U622, U623, U624, U625, U626, U627, U628, U629, U630, U631, U632, U633, U634, U635, U636, U637, U638, U639, U640, U641, U642, U643, U644, U645, U646, U647, U648, U649, U650, U651, U652, U653, U654, U655, U656, U657, U658, U659, U660, U661, U662, U663, U664, U665, U666, U667, U668, U669, U670, U671, U672, U673, U674, U675, U676, U677, U678, U679, U680, U681, U682, U683, U684, U685, U686, U687, U688, U689, U690, U691, U692, U693, U694, U695, U696, U697, U698, U699, U700, U701, U702, U703, U704, U705, U706, U707, U708, U709, U710, U711, U712, U713, U714, U715, U716, U717, U718, U719, U720, U721, U722, U723, U724, U725, U726, U727, U728, U729, U730, U731, U732, U733, U734, U735, U736, U737, U738, U739, U740, U741, U742, U743, U744, U745, U746, U747, U748, U749, U750, U751, U752, U753, U754, U755, U756, U757, U758, U759, U760, U761, U762, U763, U764, U765, U766, U767, U768, U769, U770, U771, U772, U773, U774, U775, U776, U777, U778, U779, U780, U781, U782, U783, U784, U785, U786, U787, U788, U789, U790, U791, U792, U793, U794, U795, U796, U797, U798, U799, U800, U801, U802, U803, U804, U805, U806, U807, U808, U809, U810, U811, U812, U813, U814, U815, U816, U817, U818, U819, U820, U821, U822, U823, U824, U825, U826, U827, U828, U829, U830, U831, U832, U833, U834, U835, U836, U837, U838, U839, U840, U841, U842, U843, U844, U845, U846, U847, U848, U849, U850, U851, U852, U853, U854, U855, U856, U857, U858, U859, U860, U861, U862, U863, U864, U865, U866, U867, U868, U869, U870, U871, U872, U873, U874, U875, U876, U877, U878, U879, U880, U881, U882, U883, U884, U885, U886, U887, U888, U889, U890, U891, U892, U893, U894, U895, U896, U897, U898, U899, U900, U901, U902, U903, U904, U905, U906, U907, U908, U909, U910, U911, U912, U913, U914, U915, U916, U917, U918, U919, U920, U921, U922, U923, U924, U925, U926, U927, U928, U929, U930, U931, U932, U933, U934, U935, U936, U937, U938, U939, U940, U941, U942, U943, U944, U945, U946, U947, U948, U949, U950, U951, U952, U953, U954, U955, U956, U957, U958, U959, U960, U961, U962, U963, U964, U965, U966, U967, U968, U969, U970, U971, U972, U973, U974, U975, U976, U977, U978, U979, U980, U981, U982, U983, U984, U985, U986, U987, U988, U989, U990, U991, U992, U993, U994, U995, U996, U997, U998, U999, U1000.

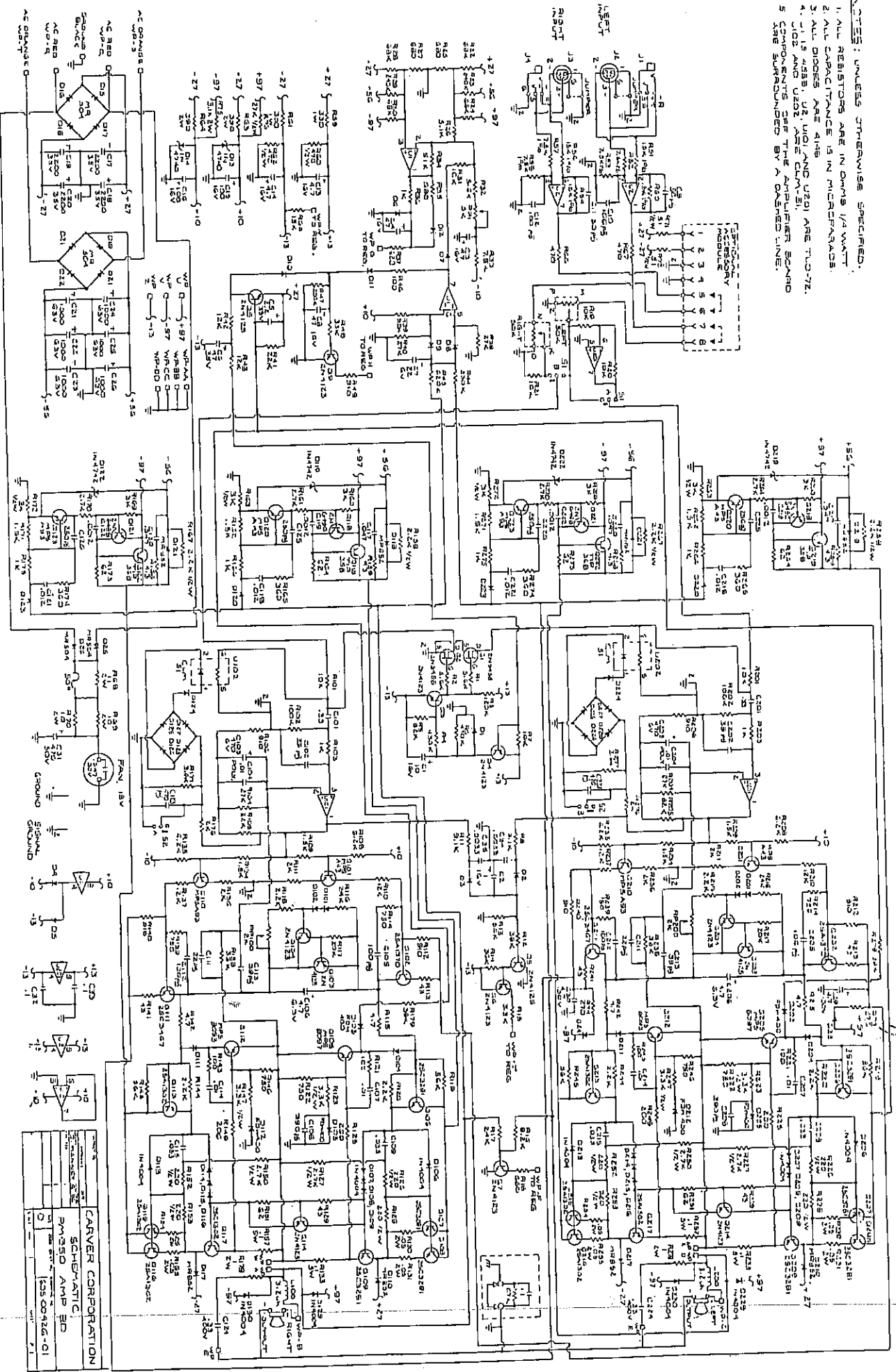

QTY	DESCRIPTION	REF. DESIG.
1	2A550 AMP ED	U1
1	125 CG-26-C1	U2

CARVER CORPORATION  
 SCHEMATIC  
 2A550 AMP ED  
 125 CG-26-C1



**NOTES :** UNLESS OTHERWISE SPECIFIED.

1. ALL RESISTORS ARE IN OHMS 1/4 WATT.
2. ALL CAPACITANCE IS IN MICROFARADS.
3. ALL DIODES ARE 1N4004.
4. COMPONENTS OFF THE REGULATOR BOARD ARE SURROUNDED BY A DASHED LINE.

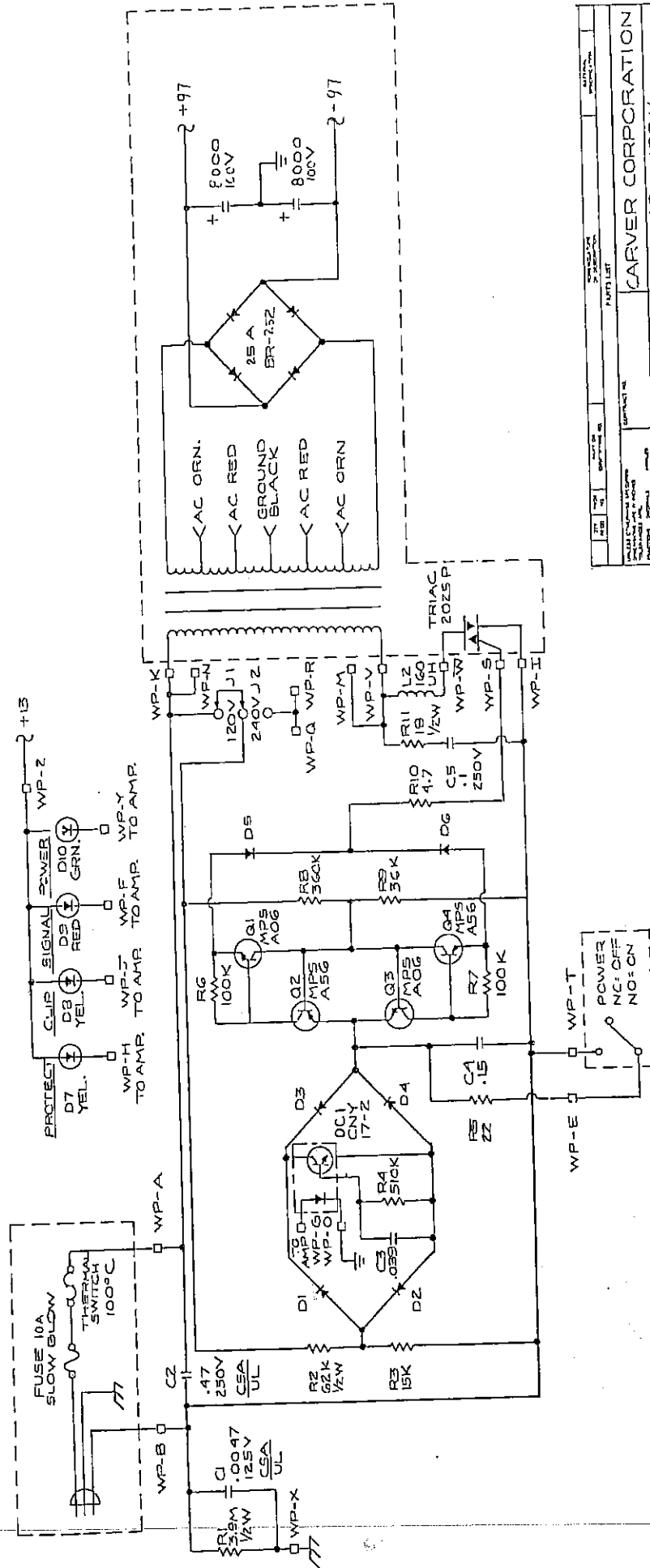

REV	DATE	BY	CHKD	DESCRIPTION
PARTS LIST				
CARRIER CORPORATION				
RM-350 120V				
REGULATOR BOARD				
SCHEMATIC				
D. MANNING				
C 1				
50E-CC427-01 A				
PAGE 1 OF 1				

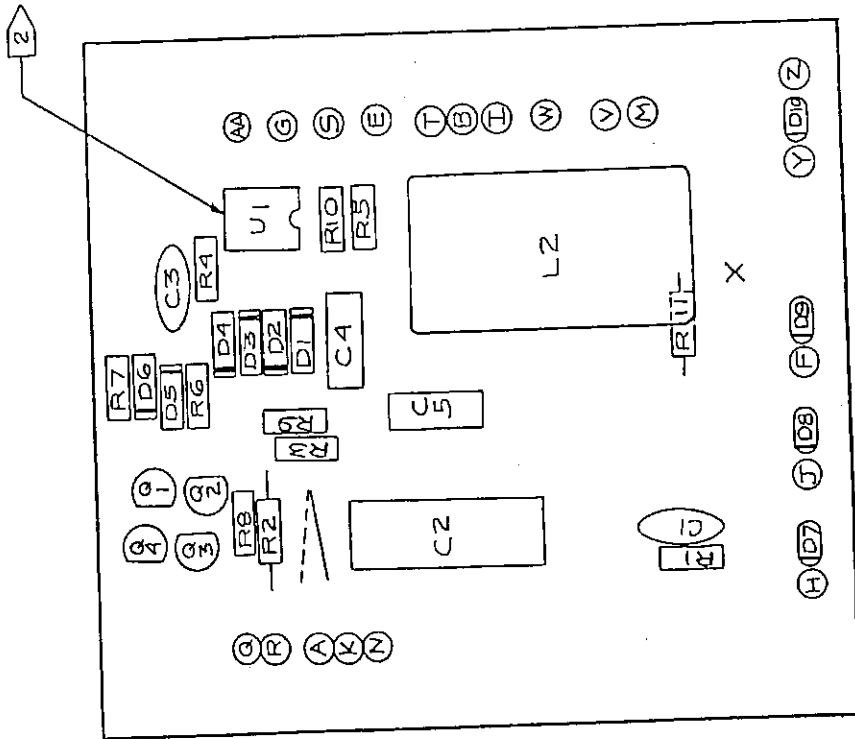

□ ITEM ON 60Z PARTS LISTS.  
 NOTES: UNLESS OTHERWISE SPECIFIED;

CONTRACT NO.		CARVER CORPORATION	
APPROVALS	DATE	PM-175 & PM-350 120V	
DESIGN	DESIGN	REGULATOR BD	
DRAWN	DATE	PARTS LOCATOR	
DIRECTOR	REV.	DWG. NO.	REV.
RECORD		SIZE	501-00427-00 B
		FORM NO.	C

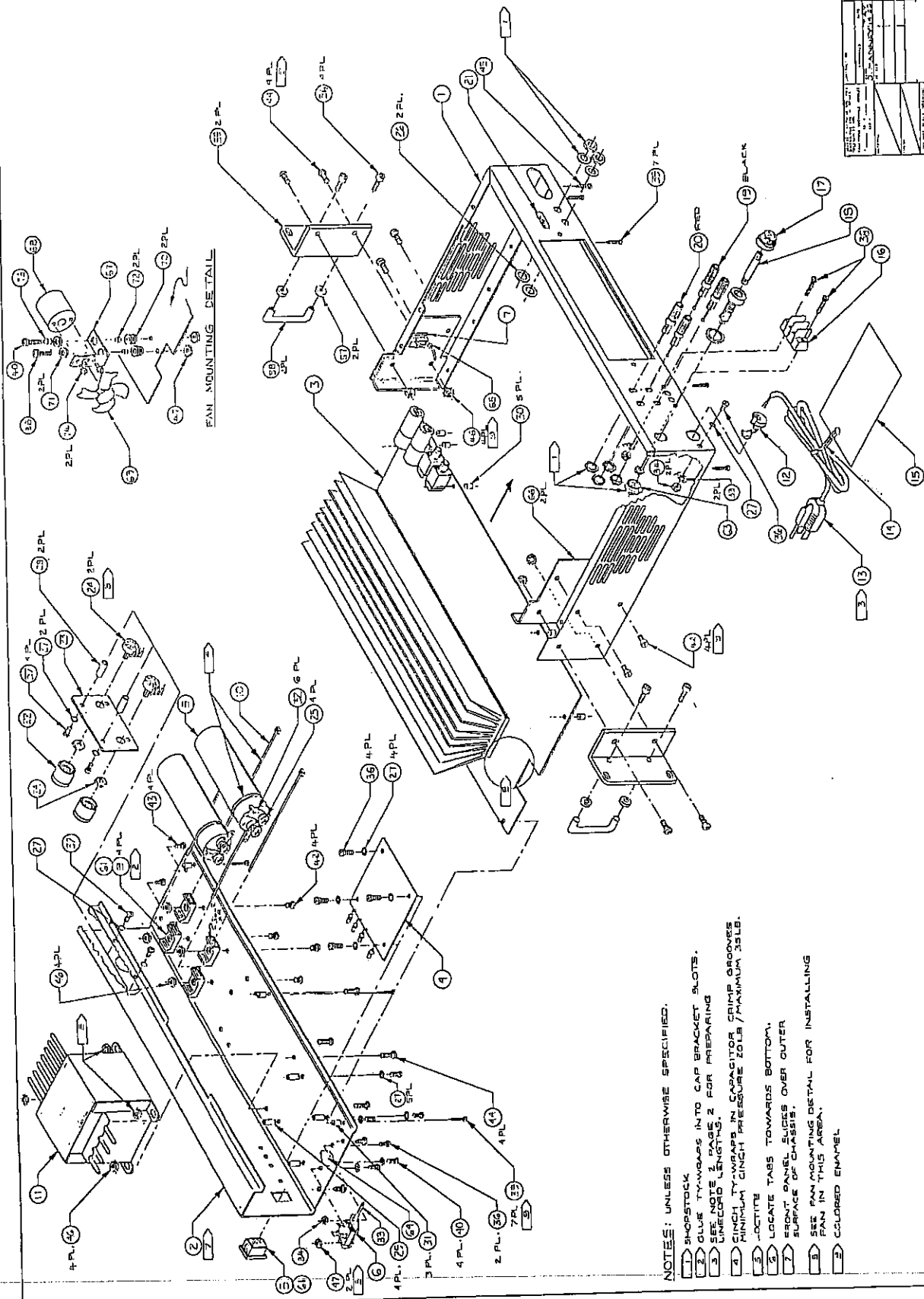

REV. 1	DATE	BY	CHKD.	APP. 1	APP. 2
REV. 2	DATE	BY	CHKD.	APP. 1	APP. 2
REV. 3	DATE	BY	CHKD.	APP. 1	APP. 2
REV. 4	DATE	BY	CHKD.	APP. 1	APP. 2
REV. 5	DATE	BY	CHKD.	APP. 1	APP. 2
REV. 6	DATE	BY	CHKD.	APP. 1	APP. 2
REV. 7	DATE	BY	CHKD.	APP. 1	APP. 2
REV. 8	DATE	BY	CHKD.	APP. 1	APP. 2
REV. 9	DATE	BY	CHKD.	APP. 1	APP. 2
REV. 10	DATE	BY	CHKD.	APP. 1	APP. 2
REV. 11	DATE	BY	CHKD.	APP. 1	APP. 2
REV. 12	DATE	BY	CHKD.	APP. 1	APP. 2
REV. 13	DATE	BY	CHKD.	APP. 1	APP. 2
REV. 14	DATE	BY	CHKD.	APP. 1	APP. 2
REV. 15	DATE	BY	CHKD.	APP. 1	APP. 2
REV. 16	DATE	BY	CHKD.	APP. 1	APP. 2
REV. 17	DATE	BY	CHKD.	APP. 1	APP. 2
REV. 18	DATE	BY	CHKD.	APP. 1	APP. 2
REV. 19	DATE	BY	CHKD.	APP. 1	APP. 2
REV. 20	DATE	BY	CHKD.	APP. 1	APP. 2
REV. 21	DATE	BY	CHKD.	APP. 1	APP. 2
REV. 22	DATE	BY	CHKD.	APP. 1	APP. 2
REV. 23	DATE	BY	CHKD.	APP. 1	APP. 2
REV. 24	DATE	BY	CHKD.	APP. 1	APP. 2
REV. 25	DATE	BY	CHKD.	APP. 1	APP. 2
REV. 26	DATE	BY	CHKD.	APP. 1	APP. 2
REV. 27	DATE	BY	CHKD.	APP. 1	APP. 2
REV. 28	DATE	BY	CHKD.	APP. 1	APP. 2
REV. 29	DATE	BY	CHKD.	APP. 1	APP. 2
REV. 30	DATE	BY	CHKD.	APP. 1	APP. 2
REV. 31	DATE	BY	CHKD.	APP. 1	APP. 2
REV. 32	DATE	BY	CHKD.	APP. 1	APP. 2
REV. 33	DATE	BY	CHKD.	APP. 1	APP. 2
REV. 34	DATE	BY	CHKD.	APP. 1	APP. 2
REV. 35	DATE	BY	CHKD.	APP. 1	APP. 2
REV. 36	DATE	BY	CHKD.	APP. 1	APP. 2
REV. 37	DATE	BY	CHKD.	APP. 1	APP. 2
REV. 38	DATE	BY	CHKD.	APP. 1	APP. 2
REV. 39	DATE	BY	CHKD.	APP. 1	APP. 2
REV. 40	DATE	BY	CHKD.	APP. 1	APP. 2
REV. 41	DATE	BY	CHKD.	APP. 1	APP. 2
REV. 42	DATE	BY	CHKD.	APP. 1	APP. 2
REV. 43	DATE	BY	CHKD.	APP. 1	APP. 2
REV. 44	DATE	BY	CHKD.	APP. 1	APP. 2
REV. 45	DATE	BY	CHKD.	APP. 1	APP. 2
REV. 46	DATE	BY	CHKD.	APP. 1	APP. 2
REV. 47	DATE	BY	CHKD.	APP. 1	APP. 2
REV. 48	DATE	BY	CHKD.	APP. 1	APP. 2
REV. 49	DATE	BY	CHKD.	APP. 1	APP. 2
REV. 50	DATE	BY	CHKD.	APP. 1	APP. 2
REV. 51	DATE	BY	CHKD.	APP. 1	APP. 2
REV. 52	DATE	BY	CHKD.	APP. 1	APP. 2
REV. 53	DATE	BY	CHKD.	APP. 1	APP. 2
REV. 54	DATE	BY	CHKD.	APP. 1	APP. 2
REV. 55	DATE	BY	CHKD.	APP. 1	APP. 2
REV. 56	DATE	BY	CHKD.	APP. 1	APP. 2
REV. 57	DATE	BY	CHKD.	APP. 1	APP. 2
REV. 58	DATE	BY	CHKD.	APP. 1	APP. 2
REV. 59	DATE	BY	CHKD.	APP. 1	APP. 2
REV. 60	DATE	BY	CHKD.	APP. 1	APP. 2
REV. 61	DATE	BY	CHKD.	APP. 1	APP. 2
REV. 62	DATE	BY	CHKD.	APP. 1	APP. 2
REV. 63	DATE	BY	CHKD.	APP. 1	APP. 2
REV. 64	DATE	BY	CHKD.	APP. 1	APP. 2
REV. 65	DATE	BY	CHKD.	APP. 1	APP. 2
REV. 66	DATE	BY	CHKD.	APP. 1	APP. 2
REV. 67	DATE	BY	CHKD.	APP. 1	APP. 2
REV. 68	DATE	BY	CHKD.	APP. 1	APP. 2
REV. 69	DATE	BY	CHKD.	APP. 1	APP. 2
REV. 70	DATE	BY	CHKD.	APP. 1	APP. 2
REV. 71	DATE	BY	CHKD.	APP. 1	APP. 2

- NOTES: UNLESS OTHERWISE SPECIFIED.
- 1 BUSHSTOCK
  - 2 GLUE TY-WRAPS INTO CAP BRACKET SLOTS.
  - 3 GLUE TY-WRAPS INTO CAP BRACKET SLOTS.
  - 4 SILENCER LENGTHS.
  - 5 SILENCER LENGTHS.
  - 6 SILENCER LENGTHS.
  - 7 SILENCER LENGTHS.
  - 8 SILENCER LENGTHS.
  - 9 SILENCER LENGTHS.
  - 10 SILENCER LENGTHS.
  - 11 SILENCER LENGTHS.
  - 12 SILENCER LENGTHS.
  - 13 SILENCER LENGTHS.
  - 14 SILENCER LENGTHS.
  - 15 SILENCER LENGTHS.
  - 16 SILENCER LENGTHS.
  - 17 SILENCER LENGTHS.
  - 18 SILENCER LENGTHS.
  - 19 SILENCER LENGTHS.
  - 20 SILENCER LENGTHS.
  - 21 SILENCER LENGTHS.
  - 22 SILENCER LENGTHS.
  - 23 SILENCER LENGTHS.
  - 24 SILENCER LENGTHS.
  - 25 SILENCER LENGTHS.
  - 26 SILENCER LENGTHS.
  - 27 SILENCER LENGTHS.
  - 28 SILENCER LENGTHS.
  - 29 SILENCER LENGTHS.
  - 30 SILENCER LENGTHS.
  - 31 SILENCER LENGTHS.
  - 32 SILENCER LENGTHS.
  - 33 SILENCER LENGTHS.
  - 34 SILENCER LENGTHS.
  - 35 SILENCER LENGTHS.
  - 36 SILENCER LENGTHS.
  - 37 SILENCER LENGTHS.
  - 38 SILENCER LENGTHS.
  - 39 SILENCER LENGTHS.
  - 40 SILENCER LENGTHS.
  - 41 SILENCER LENGTHS.
  - 42 SILENCER LENGTHS.
  - 43 SILENCER LENGTHS.
  - 44 SILENCER LENGTHS.
  - 45 SILENCER LENGTHS.
  - 46 SILENCER LENGTHS.
  - 47 SILENCER LENGTHS.
  - 48 SILENCER LENGTHS.
  - 49 SILENCER LENGTHS.
  - 50 SILENCER LENGTHS.
  - 51 SILENCER LENGTHS.
  - 52 SILENCER LENGTHS.
  - 53 SILENCER LENGTHS.
  - 54 SILENCER LENGTHS.
  - 55 SILENCER LENGTHS.
  - 56 SILENCER LENGTHS.
  - 57 SILENCER LENGTHS.
  - 58 SILENCER LENGTHS.
  - 59 SILENCER LENGTHS.
  - 60 SILENCER LENGTHS.
  - 61 SILENCER LENGTHS.
  - 62 SILENCER LENGTHS.
  - 63 SILENCER LENGTHS.
  - 64 SILENCER LENGTHS.
  - 65 SILENCER LENGTHS.
  - 66 SILENCER LENGTHS.
  - 67 SILENCER LENGTHS.
  - 68 SILENCER LENGTHS.
  - 69 SILENCER LENGTHS.
  - 70 SILENCER LENGTHS.
  - 71 SILENCER LENGTHS.

CARVER CORPORATION  
 FINAL ASSEMBLY  
 204-00344-001.2  
 204-00344-001.2

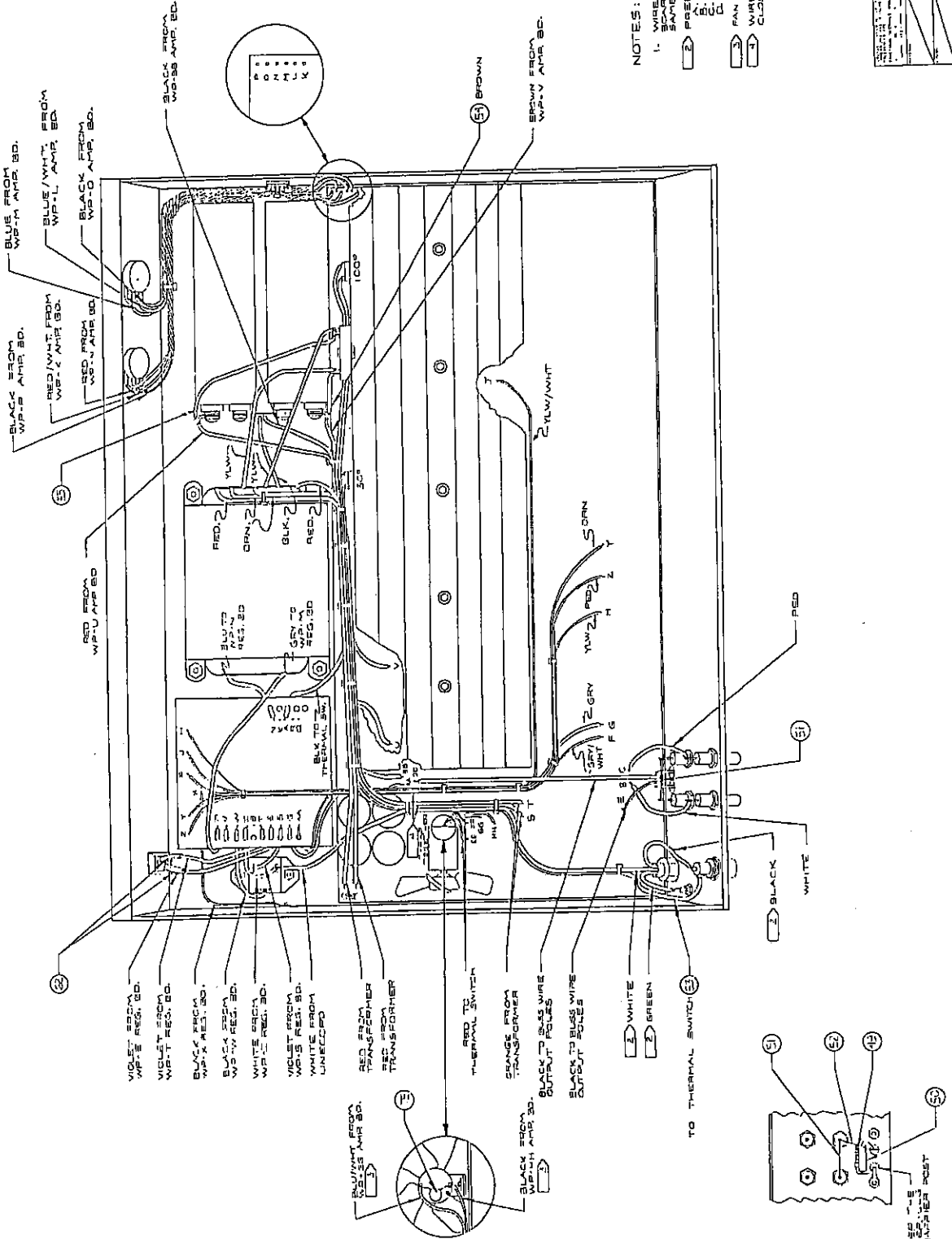

NOTES: UNLESS OTHERWISE SPECIFIED:

- 1. WIRES FROM WIRE BOARD TO AMP BOARD ARE DESIGNATED BY THE SAME LETTERS AT WIRE BOARD
- 2. PREPARE UNLESS AS FOLLOWS
  - A. GREEN WIRE: 1/4" LONG
  - B. BLACK WIRE: 3/8" LONG
  - C. EACH WIRE STRIPPED 3/8"
- 3. FAN WIRES NOT TYPED
- 4. WIRE BUNDLE MUST BE ROUTED CLOSE TO CIRCUIT BOARD.

CARTER CORP.	
MODEL	BM-380
REVISION	FINAL ASSEMBLY
DATE	WIRING INSTRUCTIONS
BY	D
APP. NO.	6CA-00341-00
REV. NO.	REV. 2.2.2

337-00341-00 1 1

1 2 3 4 5 6 7 8

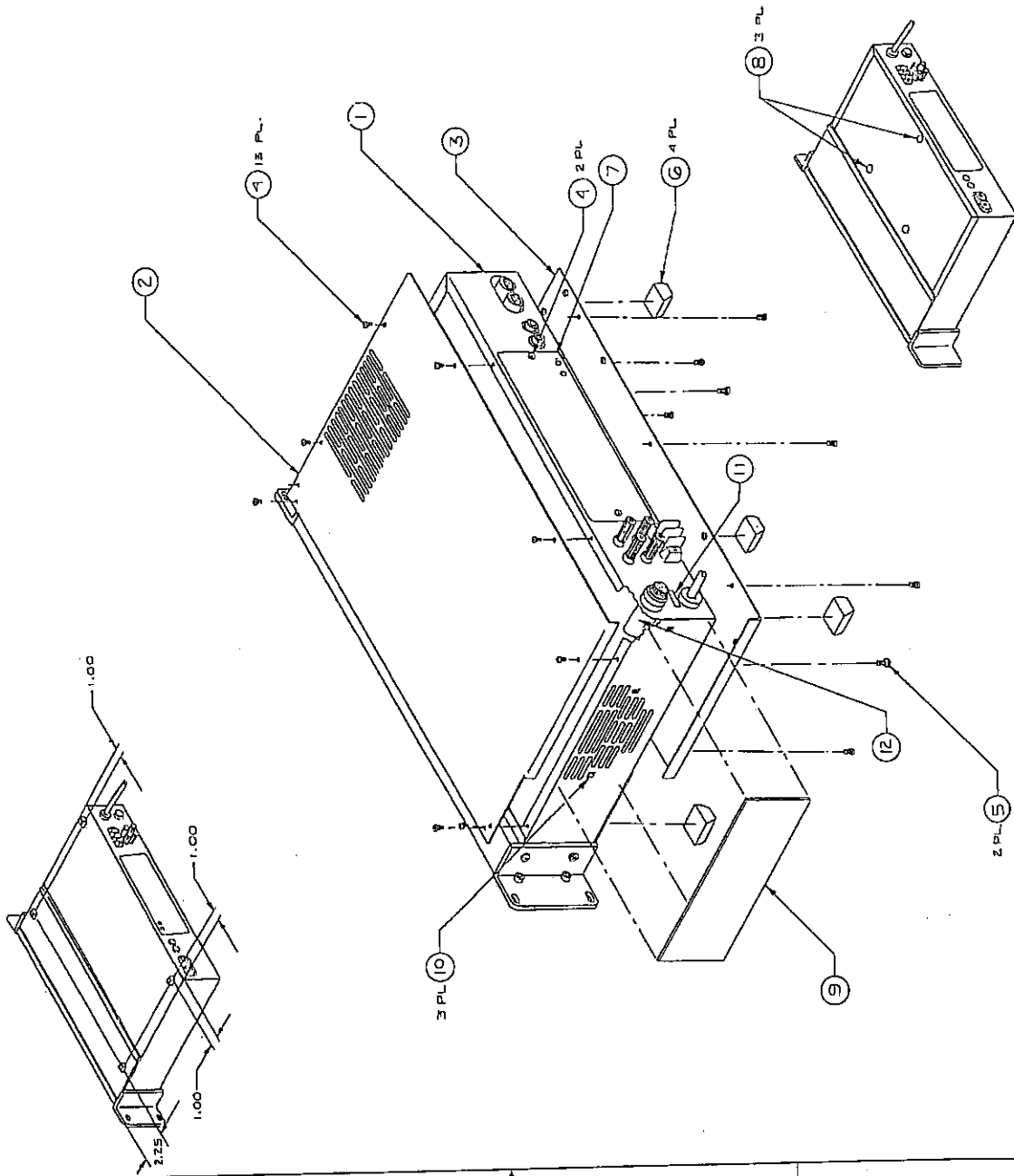

PART LIST		
REV	DATE	DESCRIPTION
1		
DRAWN BY D. MANNING		
CHECKED BY JUNE		
DATE 4 8 63		
PROJECT BUTTON-UP		
SCALE 1:1		
DRAWING NO. 337-00341-00		
SHEET NO. 1 OF 1		

1 2 3 4 5 6 7 8

**SECTION 7**  
**PARTS ORDERING**

Please provide the Model numbers of the units involved when ordering genuine CARVER replacement parts. Also provide the CARVER part number and the generic part number to confirm the correct part needed.

The Carver Parts Department is open Monday thru Friday, 7:00 a.m. to 4:45 p.m. PST.  
The following phone number is to be used for part orders only!  
Technical assistance is not available on this line.

1-800-433-0547

Or if you prefer to FAX in your part order, please use the following FAX number:

1-206-775-9180

From time to time, when it is necessary, we may make a substitution for the original part ordered, due to circuit revisions or part availability.

Random deviation from the original CARVER designated part is not recommended!  
Complete PCB replacement is not recommended. You must have prior approval for warranty repair should PCB replacement be necessary.

# SECTION 8

## PARTS LIST

PM-350 AMP BOARD  
P/N 602-00426-01

### CAPACITORS

CARVER P/N	DESCRIPTION	REF DESIGNATORS	NOTES
201-00004-00	CAP CER DISC 22pF 10% 1000V	C111,211	
201-00006-00	CAP CER DISC 39pF 10% 1000V	C102,202,211,311	
201-00008-00	CAP CER DISC 50pF 10% 1000V	C9,11	
201-00012-00	CAP CER DISC 100pF 10% 1000V	C10,12,105,112,205,212	
201-00019-00	CAP CER DISC 250pF 10% 1000V	C125,126,225,226	
201-00022-00	CAP CER DISC 390pF 10% 1000V	C108,208	
201-00023-00	CAP CER DISC 470pF 10% 1000V	C123,223	
204-00004-00	CAP MYLAR .0012μF	C119,122,219,222	
204-00009-00	CAP MYLAR .0033μF	C34,35	
204-00015-00	CAP MYLAR .01μF	C107,114,207,214	
204-00016-00	CAP MYLAR .047μF	C118,121,218,221	
204-00024-00	CAP MYLAR .047μF	C117,120,217,220	
204-00027-00	CAP MYLAR .1μF	C32,33	
204-00033-00	CAP MYLAR .33μF/400V	C124,224	
205-00002-00	CAP LYTIC 2.2μF/35V RAD	C5	
205-00005-00	CAP LYTIC 4.7μF/35V RAD	C2,13,14,106,206	
205-00009-00	CAP LYTIC 4.7μF/100V RAD	C29,30	
205-00011-00	CAP LYTIC 22μF/16V RAD	C7,8	
205-00013-00	CAP LYTIC 47μF/25V RAD	C1,3,4	
205-00014-00	CAP LYTIC 47μF/35V RAD	C6	
205-00016-00	CAP LYTIC 100μF/16V RAD	C15,16	
205-00019-00	CAP LYTIC 470μF/6.3V RAD	C103,203	
205-00037-00	CAP LYTIC 470μF/50V AX	C31	
205-00056-00	CAP LYTIC 1000μF/63V RAD	C21-26	MAX DIA 0.71"
205-00057-00	CAP LYTIC 2200μF/35V RAD	C17-20	MAX DIA 0.71"
207-20001-00	CAP POLYPROP .01μF/50V RAD	C104,204	

### RESISTORS

CARVER P/N	DESCRIPTION	REF DESIGNATORS	NOTES
251-00013-00	RES CFILM 4.3 OHM 1/4W PREP .4	R159,168,259,268	
251-00014-00	RES CFILM 4.7 OHM 1/4W PREP .4	R115,142,215,242	
251-00037-00	RES CFILM 43 OHM 1/4W PREP .4	R113,129,141,213,229,241	
251-00041-00	RES CFILM 62 OHM 1/4W PREP .4	R151,164,173,251,264,273	

CARVER P/N	DESCRIPTION	REF DESIGNATORS	NOTES
251-00046-00	RES CFILM 100 OHM 1/4W PREP .4	R46,121,143,221,243	
251-00053-00	RES CFILM 200 OHM 1/4W PREP .4	R125,149,225,249	
251-00056-00	RES CFILM 270 OHM 1/4W PREP .4	R73,74	
251-00059-00	RES CFILM 360 OHM 1/4W PREP .4	R165,174,265,274	
251-00062-00	RES CFILM 470 OHM 1/4W PREP .4	R66,67	
251-00065-00	RES CFILM 620 OHM 1/4W PREP .4	R37	
251-00066-00	RES CFILM 680 OHM 1/4W PREP .4	R18,25,27,35	
251-00067-00	RES CFILM 750 OHM 1/4W PREP .4	R114,122,139,146,214,222,239,246	
251-00069-00	RES CFILM 910 OHM 1/4W PREP .4	R49,106,112,140,206,212,240	
251-00070-00	RES CFILM 1K 1/4W PREP .4	R36,103,166,175,203,266,275	
251-00074-00	RES CFILM 1.5K 1/4W PREP .4	R109,134,162,171,209,234,262,271	
251-00077-00	RES CFILM 2.0K 1/4W PREP .4	R111,136,176,211,236,276	
251-00078-00	RES CFILM 2.2K 1/4W PREP .4	R118,120,144,218,220,244	
251-00080-00	RES CFILM 2.7K 1/4W PREP .4	R161,170,261,270	
251-00081-00	RES CFILM 3.0K 1/4W PREP .4	R160,169,260,269	
251-00082-00	RES CFILM 3.3K 1/4W PREP .4	R15	
251-00083-00	RES CFILM 3.6K 1/4W PREP .4	R177,277	
251-00087-00	RES CFILM 5.1K 1/4W PREP .4	R26	
251-00088-00	RES CFILM 5.6K 1/4W PREP .4	R1,2,32	
251-00089-00	RES CFILM 6.2K 1/4W PREP .4	R108,135,208,235	
251-00091-00	RES CFILM 7.5K 1/4W PREP .4	R33	
251-00092-00	RES CFILM 8.2K 1/4W PREP .4	R16	
251-00093-00	RES CFILM 9.1K 1/4W PREP .4	R8,11	
251-00094-00	RES CFILM 10K 1/4W PREP .4	R7,19-21,31	
251-00096-00	RES CFILM 12K 1/4W PREP .4	R42,43,110,137,210,237	
251-00097-00	RES CFILM 13K 1/4W PREP .4	R13	
251-00098-00	RES CFILM 15K 1/4W PREP .4	R65,101,201	
251-00099-00	RES CFILM 16K 1/4W PREP .4	R5	
251-00101-00	RES CFILM 20K 1/4W PREP .4	R117,217	
251-00102-00	RES CFILM 22K 1/4W PREP .4	R41	
251-00103-00	RES CFILM 24K 1/4W PREP .4	R17,116,216	
251-00104-00	RES CFILM 27K 1/4W PREP .4	R38,40,104,204	
251-00106-00	RES CFILM 33K 1/4W PREP .4	R48	
251-00107-00	RES CFILM 36K 1/4W PREP .4	R12,14,138,238	
251-00108-00	RES CFILM 39K 1/4W PREP .4	R179,279	
251-00111-00	RES CFILM 51K 1/4W PREP .4	R34	
251-00112-00	RES CFILM 56K 1/4W PREP .4	R119,145,219,245	
251-00114-00	RES CFILM 66K 1/4W PREP .4	R22,24,28,30	
251-00116-00	RES CFILM 82K 1/4W PREP .4	R4,105,205	
251-00117-00	RES CFILM 91K 1/4W PREP .4	R6	
251-00118-00	RES CFILM 100K 1/4W PREP .4	R102,202	
251-00120-00	RES CFILM 120K 1/4W PREP .4	R3	
251-00125-00	RES CFILM 200K 1/4W PREP .4	R47	
251-00127-00	RES CFILM 240K 1/4W PREP .4	R23,29	
251-00130-00	RES CFILM 330K 1/4W PREP .4	R44	
251-00135-00	RES CFILM 510K 1/4W PREP .4	R39	
251-00137-00	RES CFILM 620K 1/4W PREP .4	R45	



CARVER P/N	DESCRIPTION	REF DESIGNATORS	NOTES
251-10039-00	RES CFILM 51 OHM 1/2W PREP .5	R71,72	
251-10054-00	RES CFILM 220 OHM 1/2W PREP .5	R128,153,228,253	
251-10062-00	RES CFILM 470 OHM 1/2W PREP .5	R60,62	
251-10078-00	RES CFILM 2.2K 1/2W PREP .5	R158,167,258,267	
251-10080-00	RES CFILM 2.7K 1/2W PREP .5	R127,150,227,250	
251-10081-00	RES CFILM 3.0K 1/2W PREP .5	R163,172,263,272	
251-10082-03	RES CFILM 3.3K 1/2W UNPREP	R123,147,223,247	
251-10104-00	RES CFILM 27K 1/2W UNPREP	R76	
252-00373-00	RES CFILM 7.50K 1/4W 1%	R52,53,57,58	
252-00402-00	RES CFILM 15.0K 1/4W 1%	R50,51,54,56	
253-20000-00	RES WIRE WOUND .05 OHM 2W 10%	R130,131,154,155,230,231,254,255	
253-20018-00	RES WIRE WOUND 1.0 OHM 2W	R178,278	
253-40001-00	RES WIRE WOUND .1 OHM 5W 10%	R133,157,233,257	
255-10081-00	RES MET OXIDE 330 OHM 1W	R59,61	
255-20041-00	RES MET OXIDE 10 OHM 2W	R69,70	
255-20042-00	RES MET OXIDE 11 OHM 2W	R68	
255-20086-00	RES MET OXIDE 390 OHM 2W	R63,64	
255-20124-00	RES MET OXIDE 6.8K 2W	R75	
259-20003-00	TRIM POT 5K PCB MOUNT	RP1	
259-20011-00	TRIM POT 2K PCB MOUNT	RP100,200	

## DIODES

CARVER P/N	DESCRIPTION	REF DESIGNATORS	NOTES
320-20001-00	DIODE 1N4148 75V PREP	D1-12,23,24,101,102,104,111,120,123-128,201,202,204,211,220,223-228	
320-20004-00	DIODE 1N4004 400V PREP .4	D106-109,113-116,129,130,206-209,213-216,229,230	
320-20005-03	DIODE MR504 400V	D25,26	
320-20006-00	DIODE BAV20 400V PREP .4	D103,105,112,203,205,212	
320-20007-03	DIODE MR852	D110,117,118,121,210,217,218,221	
320-20010-03	DIODE 6 AMP 200V UNPREP	D15,16,18-22	Was MR504 400V (P/N 320-20005-00)
320-30000-00	DIODE ZENER 1N4740 10V PREP	D13,14	
320-30001-00	DIODE ZENER 1N4742 12V PREP	D119,122,219,222	

## TRANSISTORS

CARVER P/N	DESCRIPTION	REF DESIGNATORS	NOTES
321-30013-00	XISTOR TO3P(L) NPN PWR 25C3281	Q106-109,206-209	
321-30014-00	XISTOR TO3P(L) PNP PWR 2SA1302	Q113,115-117,213,215-217	
321-40000-00	XISTOR TO92 NPN SM SG MPS8097	Q105,205	
321-40001-00	XISTOR TO92 NPN SM SG MPSA43	Q101,120,210,220	
321-40003-00	XISTOR TO92 PNP SM SG MPS8093	Q112,212	
321-40004-00	XISTOR TO92 PNP SM SG MPSA93	Q110,123,210,223	
321-40005-00	XISTOR TO92 JFET SM SG 2N5458	Q1,2	

CARVER P/N	DESCRIPTION	REF DESIGNATORS	NOTES
321-40009-00	XISTOR TO92 PNP SM SG 2N4125	Q5,8,103,203	
321-40010-00	XISTOR TO92 NPN SM SG 2N4123	Q3,4,6,7,8,104,114,204,214	
321-60004-00	XISTOR TO220 NPN 2N6488	Q121,221	
321-60006-00	XISTOR TO220 PNP 2N6490	Q118,218	
321-60008-00	XISTOR TO220 PNP 2SA137D	Q102,202	
321-60009-00	XISTOR TO220 NPN 2SC3467	Q111,211	
321-80000-00	XISTOR TO218AA NPN TIP358	Q119,219	
321-80003-00	XISTOR TO218AA PNP TIP36B	Q122,222	

## INTEGRATED CIRCUITS

CARVER P/N	DESCRIPTION	REF DESIGNATORS	NOTES
330-30001-00	IC DUAL OP AMP BIFET TL072	U2,101,201	
330-30008-00	IC DUAL OP AMP 4558	U1	
330-40008-00	IC OPTOISOLATOR DIP VTL5C4	U102, 202	(Or CLM 51)

## MISCELLANEOUS ITEMS

CARVER P/N	DESCRIPTION	REF DESIGNATORS	NOTES
109-00002-00	JACK, RT ANGLE XLR CONNECTOR	J2,3	
109-20001-00	JACK, PHONE 1/4" PC MT	J1,4	
112-20002-00	MOUNT, SNAKE LUG		
118-80011-00	STANDOFF THREADED 6-32 x .750"L		
151-00258-00	SCREW MACH SCKT H HEX 1/4 x 20 x 1"		
151-20001-00	SCREW MACH PP BLK 440 x 1/4"		
151-20007-00	SCREW MACH PP BLK 440 x 5/16"		
151-20055-00	SCREW MACH PP BLK 6-32 x 5/8"		
151-20106-00	SCREW MACH PP BLK 8-32 x 3/4"		
152-00005-02	NUT HEX 1/4-20 CAD		
152-10001-00	KEPNUT, 4-40 ZC		
152-10003-00	KEPNUT, 8-32 x 11/32" ZC		
154-00005-01	WASHER, BELL ZC 1/4" ID		
154-10251-00	WASHER FLAT SAE BLK .25 x .625"		
154-20052-00	WASHER INT LOCK SAE BLK #6		
154-40302-01	WASHER SHOULDER NYLON 1/4"		
160-20005-00	CONNECTOR RIBBON CABLE 8 POS		Before S/N 5000
160-20007-00	CONNECTOR, MINI LINK .025" SPACING	J5	After S/N 5000
160-30013-00	HEADER LOCKING GOLD MOLEX		After S/N 5000
204-00031-00	CAP MYLAR .33μF	C101,201	
318-10009-00	SWITCH PUSH 1 KEY NO FRAME MINI W/BUTTON	S1	
318-50000-00	SWITCH THERMAL 50 DEG C		
318-50003-00	SWITCH THERMAL 100 DEG C		

CARVER P/N	DESCRIPTION	REF DESIGNATORS	NOTES
401-10115-00	WIRE 18 AWG TEW RED 16"		
401-10125-00	WIRE 18 AWG TR-64 BLACK 12"	WP-BB	
401-10127-00	WIRE 18 AWG TR-64 RED 11"	WP-U	
401-10151-00	WIRE 18 AWG TR-64 BLACK 7"	WP-DD	
401-10161-00	WIRE 18 AWG TEW RED 3"	WP-C	
401-10163-00	WIRE 18 AWG TR-64 BROWN 11"	WP-V	
401-10170-00	WIRE 18 AWG TEW WHITE 16"		
401-10501-00	WIRE 22 AWG TR-64 BLACK 2.25"	WP-E	
401-10508-00	WIRE 22 AWG TR-64 RED 11"		
401-10541-00	WIRE 22 AWG TR-64 BLACK 3.5"		
401-10583-00	WIRE 22 AWG TR-64 BLU/WHT 3"		
401-30002-00	JUMPER INSULATED #22 .3"		
401-30003-00	JUMPER INSULATED #22 .4"		
401-30005-00	JUMPER INSULATED #22 .5"		
401-30006-00	JUMPER INSULATED #22 .6"		
401-30007-00	JUMPER INSULATED #22 .7"		
401-30012-00	JUMPER NONINSULATED #22 .10"		
401-40013-00	WIRE T #22 1-BRN, BRN/WHT, BLK 9.5"		
403-10003-00	SEALANT SILIGONE RUBBER RTV		
403-10009-00	LOCTITE TAK PAK ADHESIVE		
403-10010-00	LOCTITE TAK PAK ACCELERATOR		
403-20001-00	THERMALCOTE #253		
501-00426-00	PCB, AMP PM-175		
511-10001-01	HEATSINK ANODIZED BLACK PM-175/PM-350		
512-10501-00	SHIM PM-175/PM-350		
512-10610-00	MICA INSULATOR LARGE PM-175		
512-10611-00	MICA INSULATOR SMALL PM-175		
512-10704-00	PLATE THERMAL PRESSURE PM-175		
616-00005-00	COIL AIR CORE	3.2μH	L100,200

## PM-350 REGULATOR BOARD P/N 602-00427-01

### CAPACITORS

CARVER P/N	DESCRIPTION	REF DESIGNATORS	NOTES
201-00033-00	CAP CER DISC .0047μF/400V 20%	C1	⚠
204-00023-00	CAP MYLAR .039μF	C3	
204-00029-00	CAP MYLAR .15μF	C4	
207-10003-00	CAP MET POLY .1μF/250V 20% RAD	C5	
207-10005-00	CAP MET POLY .47μF/250V	C2	⚠

## RESISTORS

CARVER P/N	DESCRIPTION	REF DESIGNATORS	NOTES
251-00014-00	RES CFILM 4.7 OHM 1/4W PREP .4	R10	
251-00030-00	RES CFILM 22 OHM 1/4W PREP .4	R5	
251-00068-00	RES CFILM 15K 1/4W PREP .4	R3	
251-00107-00	RES CFILM 36K 1/4W PREP .4	R9	
251-00118-00	RES CFILM 100K 1/4W PREP .4	R6,7	
251-00131-00	RES CFILM 360K 1/4W PREP .4	R8	
251-00135-00	RES CFILM 510K 1/4W PREP .4	R4	
251-10028-00	RES CFILM 18 OHM 1/2W PREP .5	R11	
251-10113-00	RES CFILM 62K 1/2W PREP .5	R2	
251-10156-00	RES CFILM 3.9M 1/2W PREP .5	R1	



## DIODES

CARVER P/N	DESCRIPTION	REF DESIGNATORS	NOTES
320-20004-00	DIODE 1N4004 400V PREP .4	D1-6	
320-40001-00	LED RED	D9	
320-40002-00	LED AMBER	D7,8	
320-40004-00	LED GREEN H.E.	D10	



## TRANSISTORS









CARVER P/N	DESCRIPTION	REF DESIGNATORS	NOTES
321-40011-00	XISTOR TO92 NPN SM SG MPSA06	Q1,3	
321-40012-00	XISTOR TO92 PNP SM SG MPSA56	Q2,4	

## MISCELLANEOUS ITEMS

CARVER P/N	DESCRIPTION	REF DESIGNATORS	NOTES
330-40002-00	OPTOISOLATOR PHOTOTRANSISTOR CNY172	OC1	
401-10104-00	WIRE 18 AWG TEW BLACK 5"	WP-W	
401-10120-00	WIRE 18 AWG TEW VIOLET 3"	WP-S	
401-10155-00	WIRE 18 AWG TEW BLACK 14"	WP-A	
401-10158-00	WIRE 18 AWG TEW WHITE 5"	WP-I	
401-10533-00	WIRE 22 AWG TR-64 RED 15"	WP-Z	
401-10556-00	WIRE 22 AWG TR-64 BLACK 5"	WP-L	
401-10565-00	WIRE 22 AWG TR-64 WHT/GRY 12.5"	WP-F	
401-10575-00	WIRE 22 AWG TEW GREY 10.5"	WP-C	
401-10599-00	WIRE 22 AWG TEW VIOLET 6.5"	WP-E, WP-T	
401-10600-00	WIRE 22 AWG TEW YELLOW 14"	WP-H	
401-10601-00	WIRE 22 AWG TR-64 YEL/WHT 18"	WP-7	
401-10628-00	WIRE 22 AWG TEW BLACK 7"	WP-AA	
401-30003-00	JUMPER INSULATED #22 .4"		
402-00006-00	SLEEVING BLACK 18 GA .4"		
501-00427-00	PCB REGULATOR PM-175		
616-00053-00	CHOKE 160µH	L2	

**PM-350 FINAL ASSEMBLY**  
**P/N 607-00341-00**

CARVER P/N	DESCRIPTION	REF DESIGNATORS	NOTES
101-00004-00	BARRIER STRIP 2 POS PANEL MNT		
101-10004-00	BLADE, FAN PLASTIC 2.5" CCW		
101-30001-00	BUMPONS RUBBER ROUND MEDIUM		
101-30003-00	BUMPONS RUBBER SQUARE .81 x .515"H		
105-10003-00	FILTER ELEMENT 2-7/8" x 7" x 3/16" TH		
105-40002-00	FUSEHOLDER PANEL MOUNT DOMESTIC		
106-30004-00	GROMMET FAN MOUNT PM-350		
108-00102-00	INSULATOR, RAG PAPER .015"1.25" x 3.25"		
111-20051-00	SOLDER LUG #6		
111-20151-00	SOLDER LUG #10		
112-10003-00	MOTOR, FAN 18V		
112-20001-00	MOUNT TYRAP WHITE		
112-20003-00	MOUNT TYRAP, SCREW MNT #10		
115-30001-00	POST SPEAKER BINDING RED		
115-30002-00	POST SPEAKER BINDING BLACK		
118-60003-00	SPACER #4 CLR .250"D x .188"L		
118-60004-00	SPACER #4 CLR .250"D x .312"L NYLON		
118-60010-00	SPACER #6 CLR .250"D x .32"L METAL		
118-60012-00	STANDOFF THREADED 6-32 x .50"L NYLON		
118-60013-00	STANDOFF HEX THREADED 6-32 x .75"L		
118-90007-00	STRAIN RELIEF MCT.063 SJT 16/3 & 18/3		
151-00154-00	SCREW MACH SCKT H BLK 10-32 x 1/2"		
151-20001-00	SCREW MACH PP BLK 440 x 1/4"		
151-20004-00	SCREW MACH PP BLK 440 x 9/16"		
151-20051-00	SCREW MACH PP BLK 6-32 x 1/4"		
151-20052-00	SCREW MACH PP BLK 6-32 x 3/8"		
151-20054-00	SCREW MACH PP BLK 6-32 x 3/4"		
151-20055-00	SCREW MACH PP BLK 6-32 x 5/8"		
151-20056-00	SCREW MACH PP BLK 6-32 x 5/16"		
151-20101-00	SCREW MACH PP BLK 6-32 x 1/4"		
151-20103-00	SCREW MACH PP BLK 8-32 x 1/2"		
151-20151-01	SCREW MACH PP BLK 10-32 x 1/4"		
151-30004-00	SCREW SHT MTL PP BLK 4 x 9/16" A		
151-30051-00	SCREW SHT MTL PP BLK 6 x 1/4" "B"		
151-30101-00	SCREW SHT MTL #8 x 1/4" TYPE "B" BLK		
152-00001-00	NUT HEX 6-32 x 5/16" ZC		
152-10002-00	KEPNUT 6-32 x 5/16" ZC		
152-10003-00	KEPNUT 8-32 x 11/32" ZC		
154-10052-00	WASHER FLAT #6 .156"ID x .562"OD x .040"TH		
154-20052-00	WASHER INT LOCK SAE BLK #6		
154-20351-02	WASHER INT LOCK CAD PLTD 1/2"ID		
154-40351-01	WASHER FLAT NYL 3/8"ID x 5/8"OD		
158-50001-00	TYRAP 3-3/8" L WHT		
158-50004-00	TYRAP 7-3/8" L NATURAL		

CARVER P/N	DESCRIPTION	REF DESIGNATORS	NOTES
201-00042-00	CAP CER DISC .047 $\mu$ F/100V 20%		Use on Fan
205-00058-00	CAP LYTIC 8000 $\mu$ F/100V RAD		
207-10002-00	CAP MET POLY .1 $\mu$ F/250V 10% AX		Use on Ground Lift Terminal
251-10104-03	RES CFILM 27K 1/2W UNPREP		Use on Ground Lift Terminal
259-10005-00	POT 50KB PANEL MOUNT		
315-14001-00	FUSE MDQ10		 115V Version
315-12004 -00	FUJSE MDL 6-1/4		 230V Version
318-20001-00	SWITCH ROCKER SPOT BLK		
319-00031-00	RECTIFIER BRIDGE 200V 25A		
319-00055-00	TRIAC T03 F/P 25A 200V		
401-10114-00	WIRE 18 AWG TR-64 RED 6.5'		
401-10116-01	WIRE 18 AWG TR-64 BROWN 4'		
401-10167-00	WIRE 18 AWG TEW BLACK 20'		
401-20101-00	BUSS WIRE 18 GA 1.5'		
401-20108-00	BUSS WIRE 18 GA 1.25'		
401-90006-00	LINECORD 16 AWG SJT 6'		
402-10002-00	TUBING HEATSHRINK CLR 1/4"		
403-10003-00	SEALANT SILICONE RUBBER RTV		
403-10005-00	LOCTITE		
403-10007-00	PLASTIC ADHESIVE		
403-20001-00	THERMALCOTE #253		
403-40006-00	VELCO STRIP HOOK SIDE 5/8"		
502-30026-01	CHASSIS SCREENED PM-175/PM-350		
503-40021-01	PANEL FRONT SCREENED PM-350		
504-20026-01	COVER TOP PAINTED BLACK PM-350		
504-20028-01	COVER BOTTOM PAINTED BLACK PM-350		
506-20003-01	BRACKET EXT APP PAINTED BLK PM-175		
507-00020-00	BRACKET 50KB POT MNT PM-175/PM-350		
507-00027-00	BRACKET SUPPORT PM-175/PM-350		
507-00029-00	BRACKET FAN MNT PM-350		
508-00012-13	KNOB 22mm SMOOTH BLK 90 DGR		
509-20001-01	FERRULE 5/16" PAINTED BLK		
510-20001-01	HANDLE 2" PAINTED BLK		
512-10001-01	SPACER BLK OX 3/16" ID x 5/16" OD x .17"		
512-10703-01	PANEL ACCESSORY COVER SCREENED		
530-10064-00	LABEL 10A/120V SLO-BLO 1200W		
602-00426-01	ASSY PCB AMP PM-350		
602-00427-01	ASSY PCB REGULATOR PM-350		
617-10028-00	TRANSFORMER 115/230V PM-350		
617-10029-00	TRANSFORMER 115V PM-350		



# SECTION 9

## VOLTAGE CONVERSION FOR PM-350

For switchable units only, containing power transformers with a split primary winding (4 wires).

PM-350 120V/240V CONVERSION

<p><u>CONVERSION TO 120V</u></p> <p>1. MOVE J1 TO 120V POSITION. ———</p> <p>2. MOVE TRANSFORMER WHITE WIRE FROM "Q" TO WIRE PAD "M". ———▶</p> <p>3. MOVE TRANSFORMER BROWN WIRE FROM "R" TO WIRE PAD "K". ———▶</p> <p>4. CHANGE FUSE TO 10A/120V SLO-BLO.</p> <p>5. REMOVE 6A/240V SLO-BLO LABEL.</p>	<p><u>CONVERSION TO 240V</u></p> <p>1. MOVE J1 TO 240V POSITION. — — — —</p> <p>2. MOVE TRANSFORMER WHITE WIRE FROM "M" TO WIRE PAD "Q". — — — —▶</p> <p>3. MOVE TRANSFORMER BROWN WIRE FROM "K" TO WIRE PAD "R". — — — —▶</p> <p>4. CHANGE FUSE TO 6A/240V SLO-BLO.</p>
---	--

530-10071-00

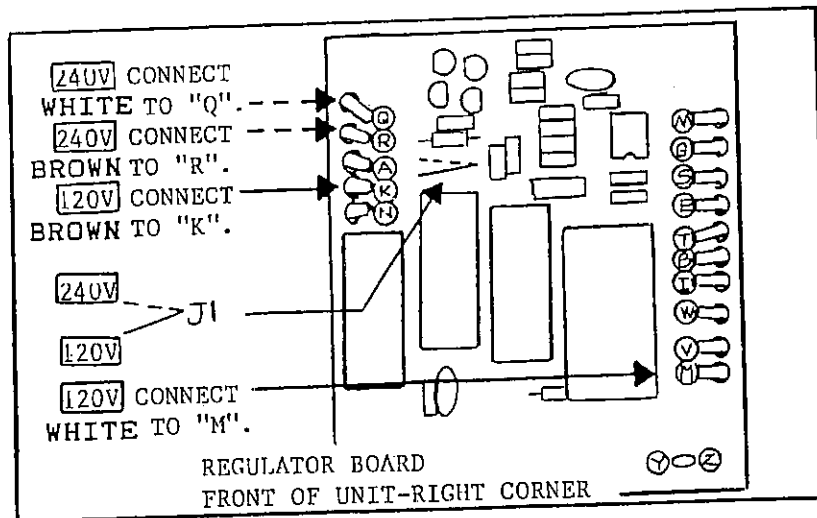



## **SECTION 10**

### **SERVICE BULLETINS**

Please insert Carver Service Bulletins pertaining to the PM-350 here to ensure proper repair in the future.



CARVER	<i>SERVICE BULLETIN</i>	PM350-4
--------	-------------------------	---------

DATE 07-12-88	PRODUCT PM350	PCB MAIN
---------------	---------------	----------

<i>SERVICE PRIORITY</i>		ALL UNITS
		SERIAL NOS. (specify)
	X	AFTER REPAIR/WHEN INSTALLING ACCESSORY MODULE
		SPECIFIC CHANGE

## PROCEDURE

After repair, please locate Q221 (to 220 case) visible through the left side of accessory module panel. Make sure that it is positioned vertically to prevent possible short from case of Q221 to chassis of PMX module or of modules to come.

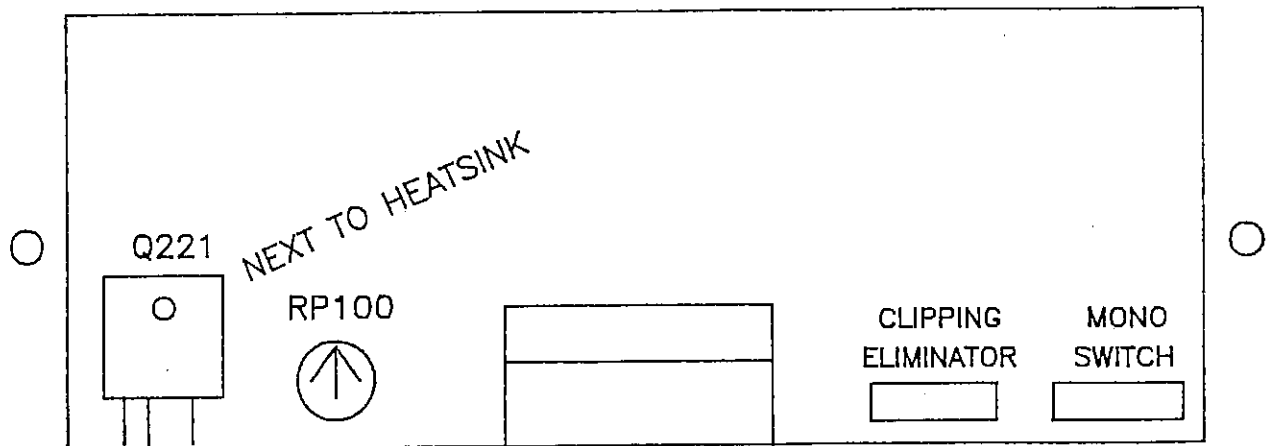

CARVER CORPORATION  
SERVICE BULLETIN

Service Bulletin # PM-350-5

Model PM-350

Serial # 5000 and below

Reason: To make the PMX interconnect cable connection stronger and simpler to install

Procedure: Change the Ribbon Connector to a Header Connector and add mini-link plug.  
Install the mini-link's between pins 5 & 6 and between pins 7 & 8

NOTE: PMX's below S/N 600 will NOT plug into this amplifier unless the PMX is modified by replacing the interconnect cable or using a adapter.

ECO #954

Delete: Qty (1) 160-20005-00 J5  
(Ribbon Connector)

Add: Qty (1) 160-30013-00 J5  
(Molex Header)  
Qty (2) 160-20007-00  
(Mini-link jumper)

SERVICE APPROVAL \_\_\_\_\_  
ENGINEERING APPROVAL \_\_\_\_\_

3/07/89