

CASIO®

Service Manual

(without price)

CTK-671

JUN. 2001

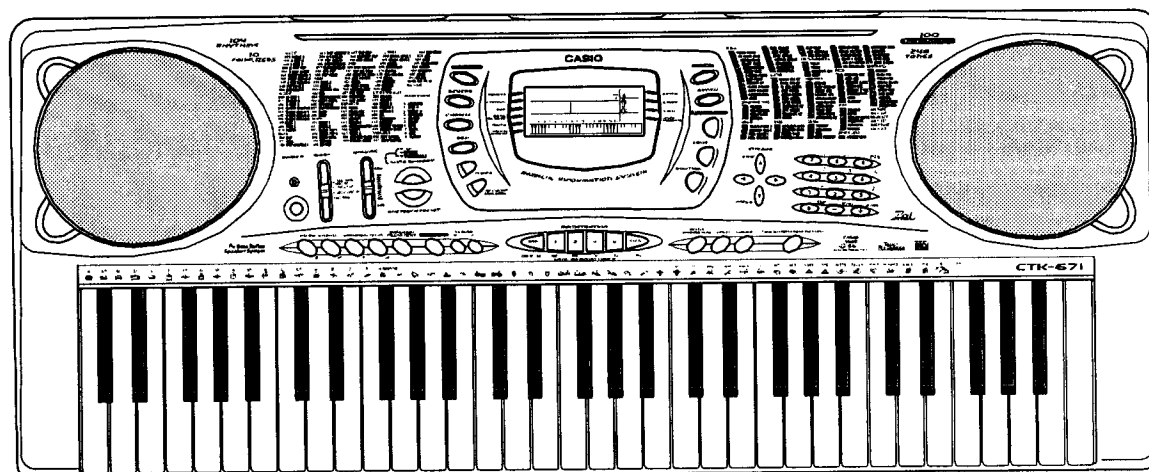

CTK-671

ELECTRONIC KEYBOARD

Ver.1 : SEP.2001

CONTENTS

	Page
Specifications	1
Block Diagram	3
Circuit Description	4
Printed Circuit Boards	5
Schematic Diagrams	7
Exploded View	12
Parts List	13

SPECIFICATIONS

GENERAL

- Keyboard: 61 standard-size keys, 5 octaves with touch response (Off / Light / Normal / Heavy)
- Tones: 348 total (100 panel tones + 128 GM tones + 10 drum sounds + 10 user tones + 100 Advanced Tones); layer/split
- Rhythm Instrument Tones: 61
- Polyphony: 32 notes maximum (16 for certain tones)
- Effects: DSP (110 types: internal, 10 user areas) + Reverb (16 types) + Chorus (16 types)
- Equalizer: 10 types, 4 bands
- Auto Accompaniment
- Rhythm Patterns: 104 (internal, 4 user areas)
 - Tempo: Variable (226 steps, ♩ = 30 to 255)
 - Chords: 3 fingering methods (CASIO CHORD, FINGERED, FULL RANGE CHORD)
 - Rhythm Controller: Start/Stop, INTRO/ENDING 1 and 2, VARIATION/FILL-IN 1 and 2, SYNCHRO/FILL-IN NEXT
 - Accomp Volume: 0 to 127 (128 steps)
 - One-touch Presets: Recalls settings for tone, tempo, layer on/off, and harmonize on/off in accordance with rhythm.
 - Auto Harmonize: Automatic addition of notes that harmonize with melody note in accordance with specified Auto Accompaniment chords.
- Memory Function
- Songs: 2
 - Recording Tracks: 6 (2 through 6 are melody tracks)
 - Recording Methods: Real-time, step
 - Memory Capacity: Approximately 3,500 notes (total for two songs)
* Same memory is shared for user rhythm storage.
 - Edit Function: Equipped
- Demo Tunes: 2

Tune Number	Name	Composer	Play Time
0	Crystal Fountain	Edward Alstrom	1:54
1	Night Breeze	Hage Software	1:52

Synthesizer Function

- Parameters: Attack time; release time; resonance; cutoff frequency; vibrato type; vibrato delay; vibrato depth; vibrato rate; octave shift; level; touch sense; reverb send; chorus send; DSP line; DSP type and DSP parameter

Registration Memory

- Number of Setups: 16 (4 setups × 4 banks)
- Memory Contents: Tone select, Rhythm select, Tempo settings, Split on/off, Split point settings, Layer on/off, Mixer settings (Channels 1~10), Effect settings, Equalizer settings, Touch Response settings, Assignable jack setting, Transpose settings, Tuning settings, Accompaniment volume settings, Harmonize on/off

Mixer Function	
Channels:	16
Parameters:	Channel on/off; tone; part on/off; volume; pan pot; octave shift; coarse tune; fine tune; reverb send; chorus send; DSP line
MIDI:	16 multi-timbre receive, GM Level 1 standard
Other Functions	
Transpose:	49 steps (-24 semitones to +24 semitones)
Tuning:	Variable (A4 = approximately 440Hz ±100 cents)
LCD:	Adjustable contrast
Terminals	
MIDI Terminals:	IN, OUT
Sustain/ Assignable Terminal:	Standard jack (sustain, sostenuto, soft, rhythm start/stop)
Headphone/ Output Terminal:	Stereo standard jack Output Impedance: 140 ohms Output Voltage: 4.5V (RMS) MAX
Power Supply Terminal:	9V DC
Power Supply:	Dual power supply system
Batteries:	6 D-size batteries
Battery Life:	Approximately 4 hours continuous operation on manganese batteries
AC Adaptor:	AD-5
Auto Power Off:	Turns power off approximately six minutes after last key operation. Enabled under battery power only, can be disabled manually.
Speaker Output:	2.5W + 2.5W
Power consumption:	9V == 7.7W
Dimensions:	96.0 × 37.5 × 14.7 cm (37 13/16 × 14 3/4 × 5 13/16 inch)
Weight:	Approximately 5.8 kg (12.8lbs) (without batteries)

About General MIDI

General MIDI standardizes MIDI data for all sound source types, regardless of manufacturer. General MIDI specifies such factors as tone numbering, drum sounds, and available MIDI channels for all sound sources. This standard makes it possible for all MIDI equipment to reproduce the same nuances when playing General MIDI data, regardless of the manufacturer of the sound source.

This keyboard supports General MIDI, so it can be used to play commercially available pre-recorded General MIDI data and General MIDI data sent to it from a personal computer.

BLOCK DIAGRAM

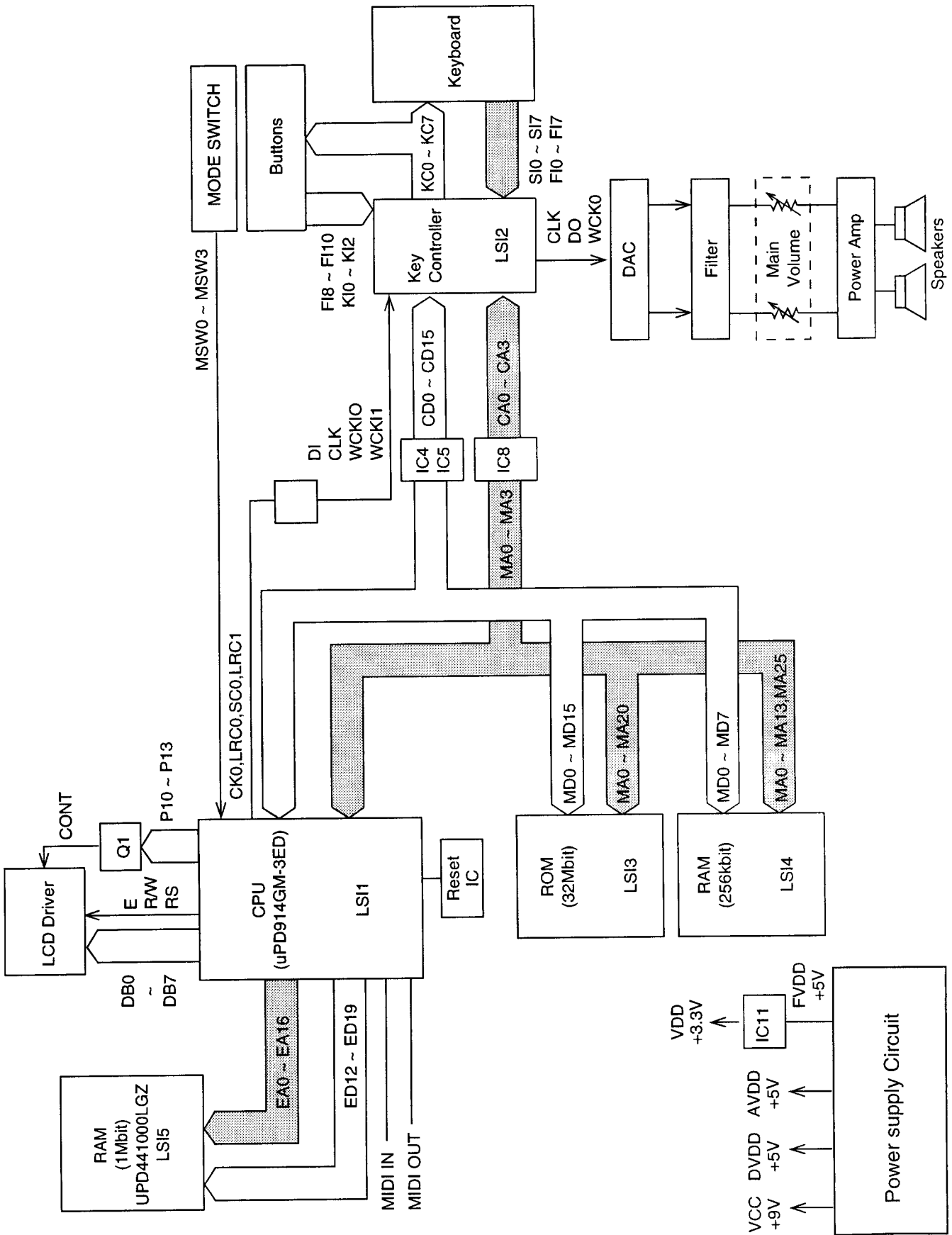

CIRCUIT DESCRIPTION

KEY MATRIX

	KC0	KC1	KC2	KC3	KC4	KC	KC6	KC7
FI0	C2 (1)	C#2 (1)	D2 (1)	D#2 (1)	E2 (1)	F2 (1)	F#2 (1)	G2 (1)
SI0	C2(2)	C#2 (2)	D2 (2)	D#2 (2)	E2 (2)	F2 (2)	F#2 (2)	G2 (2)
FI1	G#2 (1)	A2 (1)	A#2 (1)	B2 (1)	C3 (1)	C#3 (1)	D3 (1)	D#3 (1)
SI1	G#2 (2)	A2 (2)	A#2 (2)	B2 (2)	C3 (2)	C#3 (2)	D3 (2)	D#3 (2)
FI2	E3 (1)	F3 (1)	F#3 (1)	G3 (1)	G#3 (1)	A3 (1)	A#3 (1)	B3 (1)
SI2	E3 (2)	F3 (2)	F#3 (2)	G3 (2)	G#3 (2)	A3 (2)	A#3 (2)	B3 (2)
FI3	C4 (1)	C#4 (1)	D4 (1)	D#4 (1)	E4 (1)	F4 (1)	F#4 (1)	G4 (1)
SI3	C4 (2)	C#4 (2)	D4 (2)	D#4 (2)	E4 (2)	F4 (2)	F#4 (2)	G4 (2)
FI4	G#4 (1)	A4 (1)	A#4 (1)	B4 (1)	C5 (1)	C#5 (1)	D5 (1)	D#5 (1)
SI4	G#4 (2)	A4 (2)	#4 (2)	B4 (2)	C5 (2)	C#5 (2)	D5 (2)	D#5 (2)
FI5	E5 (1)	F5 (1)	F#5 (1)	G5 (1)	G#5 (1)	A5 (1)	A#5 (1)	B5 (1)
SI5	E5 (2)	F5 (2)	F#5 (2)	G5 (2)	G#5 (2)	A5 (2)	A#5 (2)	B5 (2)
FI6	C6 (1)	C#6 (1)	D6 (1)	D#6 (1)	E6 (1)	F6 (1)	F#6 (1)	G6 (1)
SI6	C6 (2)	C6# (2)	D6 (2)	D#6 (2)	E6 (2)	F6 (2)	F#6 (2)	G6 (2)
FI7	G#6 (1)	A6 (1)	A#6 (1)	B6 (1)	C7 (1)			
SI7	G#6 (2)	A6 (2)	A#6 (2)	B6 (2)	C7 (2)			

BUTTON MATRIX

	KC0	KC1	KC2	KC3	KC4	KC5	KC6	KC7
FI8	ONE TOUCH	REVERB	EQUALIZER	RNYTHM	TONE	7	8	9
FI9	SONG MEMORY	CHORUS	SYNTH		TRANPOSE	4	5	6
FI10	ACCOMP VOLUME	DSP	MIXER	SPECIAL	+	1	2	3
KI0	INTRO/ ENDING1	VARIATION /FILL-IN1	SYNCHRO /CROSS FILL	AUTO HIARMONIZE	DEMO	-	0	SPLT
KI1	STORE	INTRO/ ENDING2	VARIATION /FILL-IN2	START/ STOP	TEMPO UP	EXIT	ENTER	LAYER
KI2	BANK	A	B	C	D	TEMPO DOWN	LEFT	RIGHT

PRINTED CIRCUIT BOARDS

Main PCB JCM703-MA1M

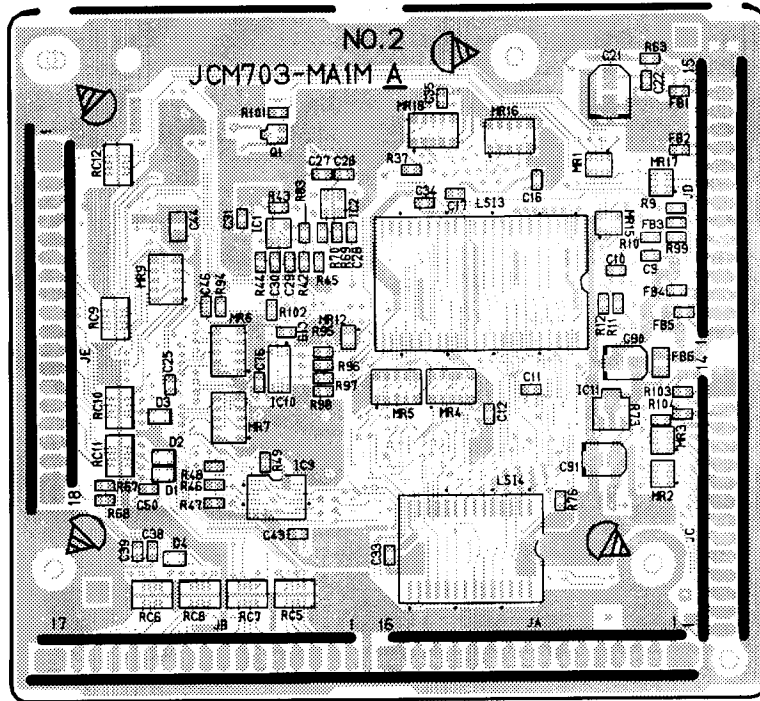

Top View

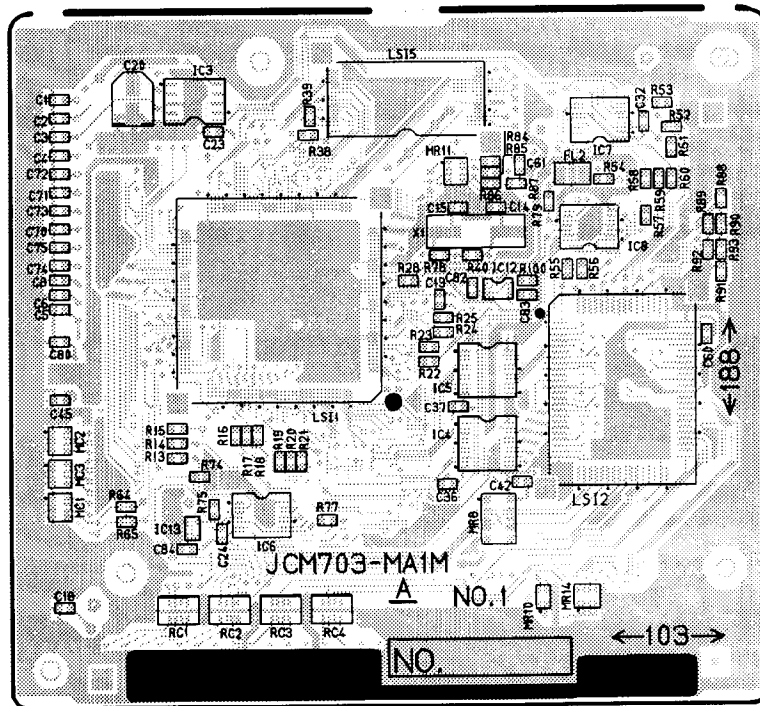

Bottom View

Sub PCB KDM703-MA2M

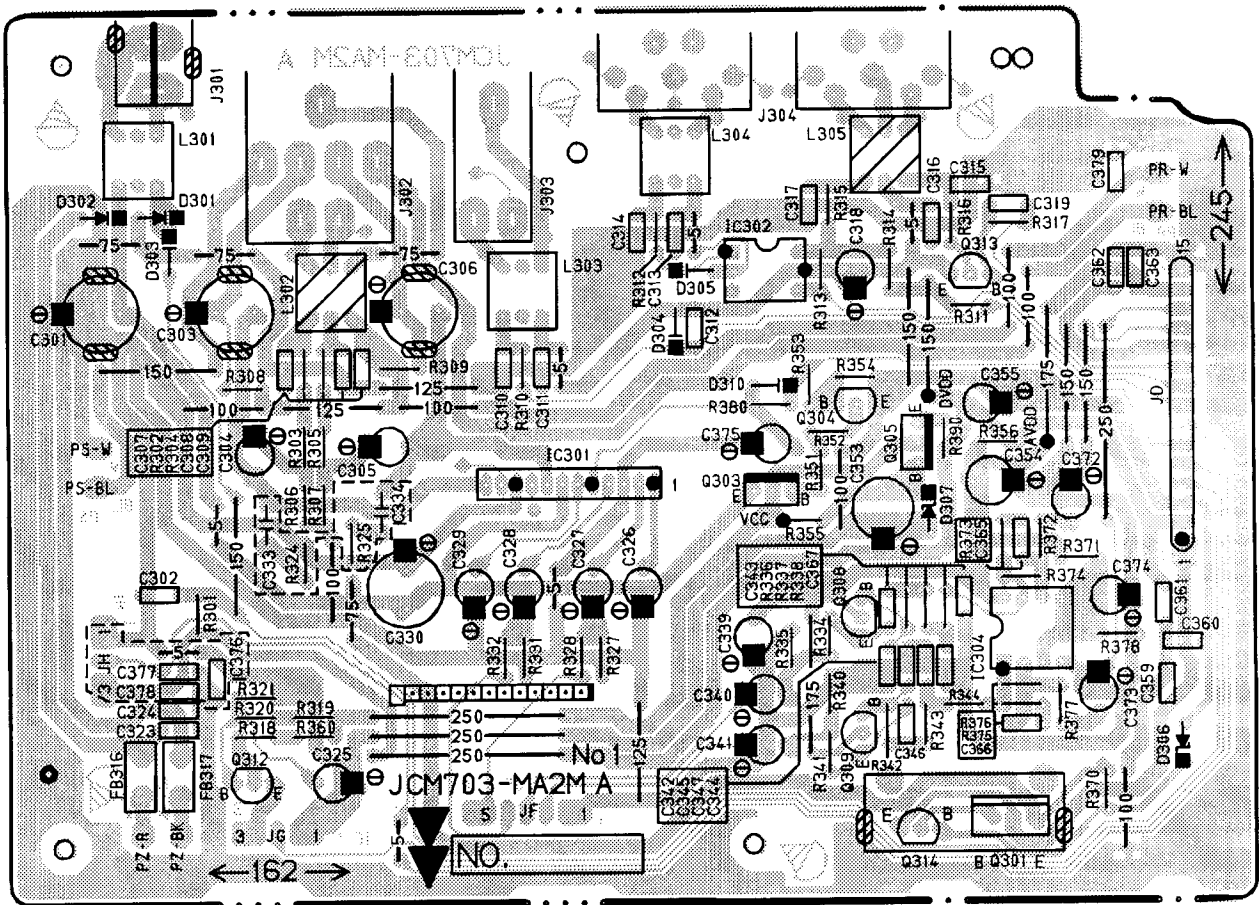

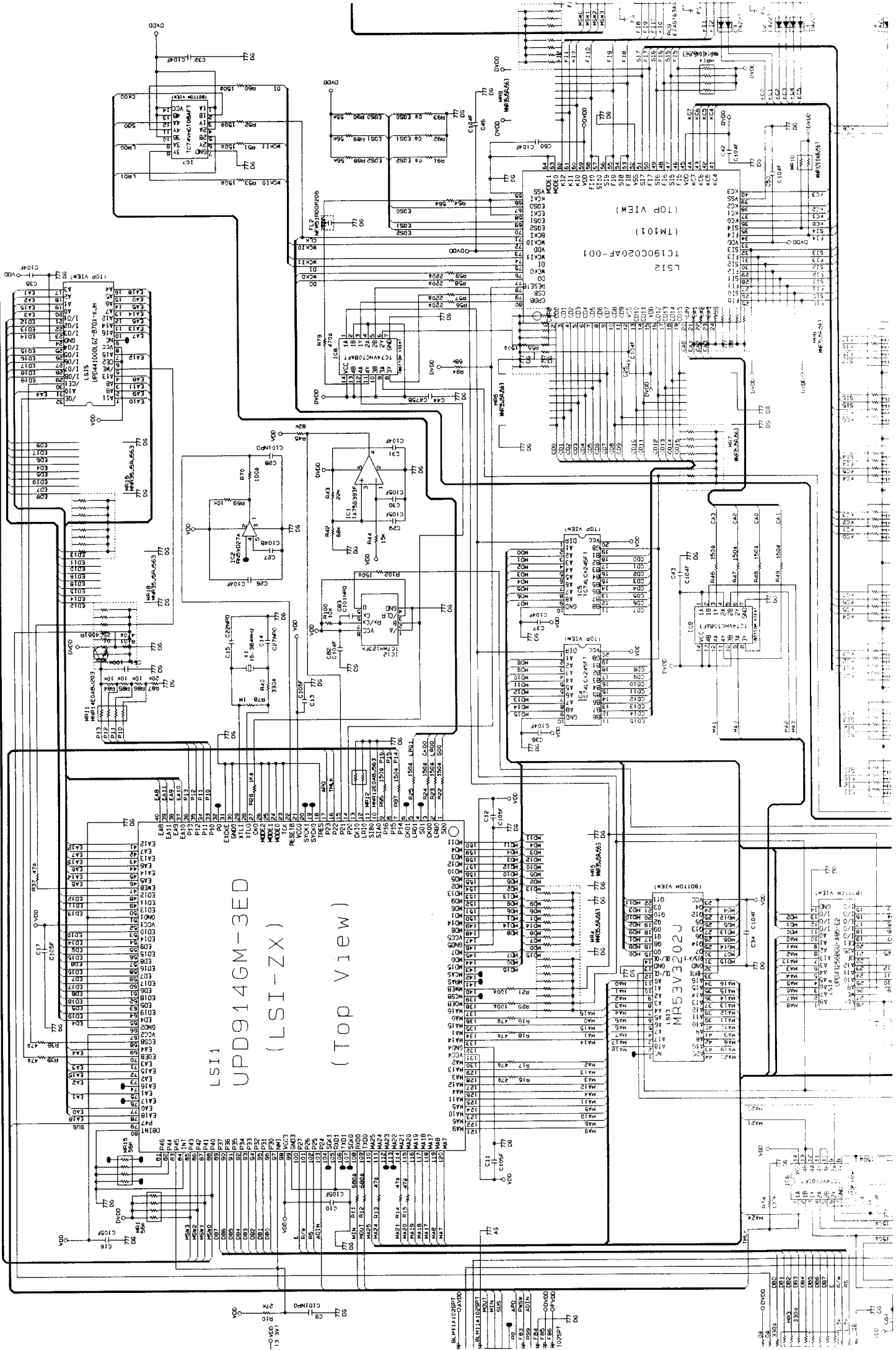

LSI1
 UPD914GM-3ED
 (LSI-ZX)
 (TOP VIEW)

LSI2
 TC190C020AF-001
 (TOP VIEW)

MR53V320J
 (BOTTOM VIEW)

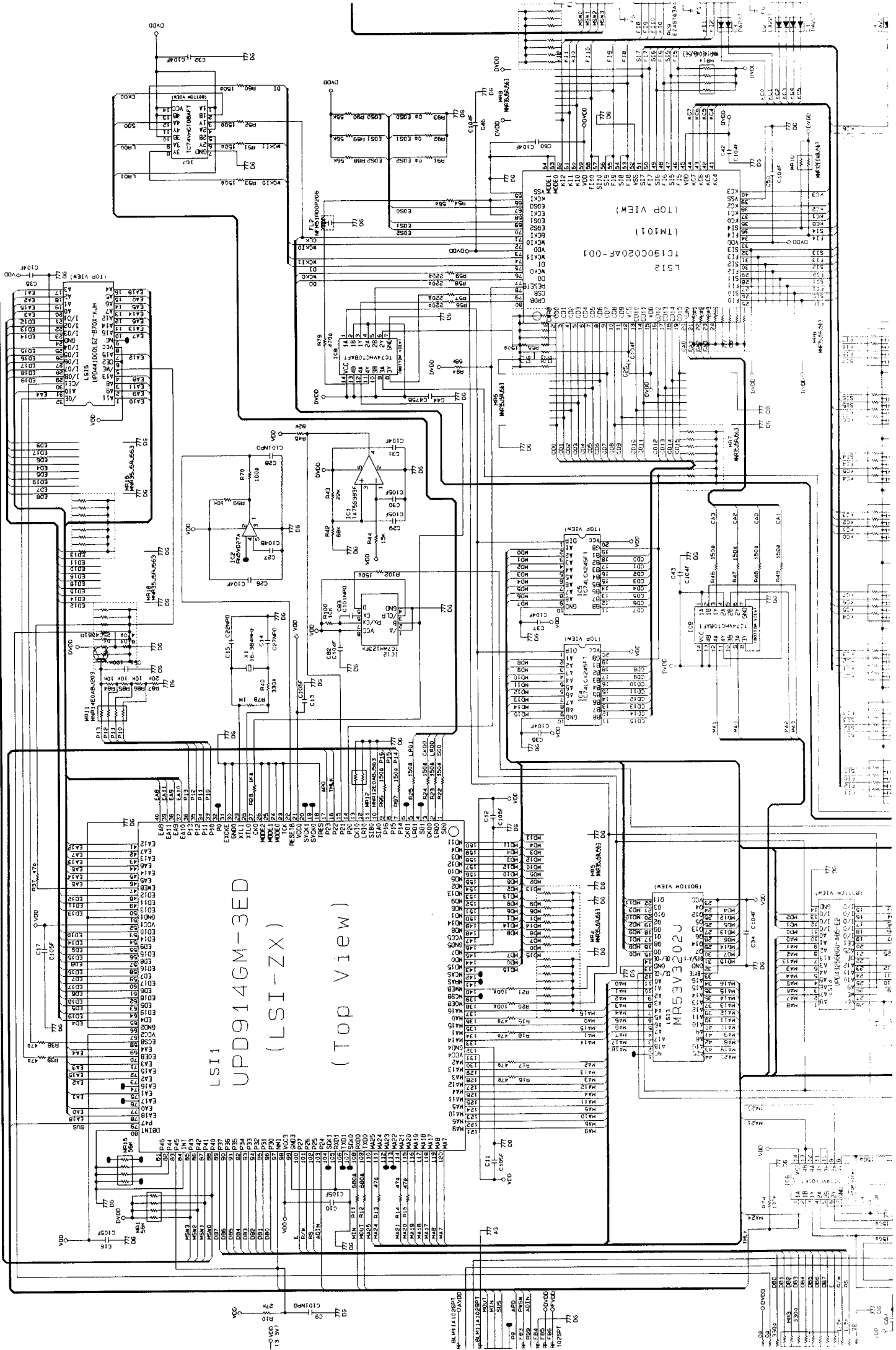

LSI1
 UPD914GM-3ED
 (LSI-ZX)
 (TOP VIEW)

LSI2
 TC190C020AF-001
 (TOP VIEW)

MR53V320J
 (BOTTOM VIEW)

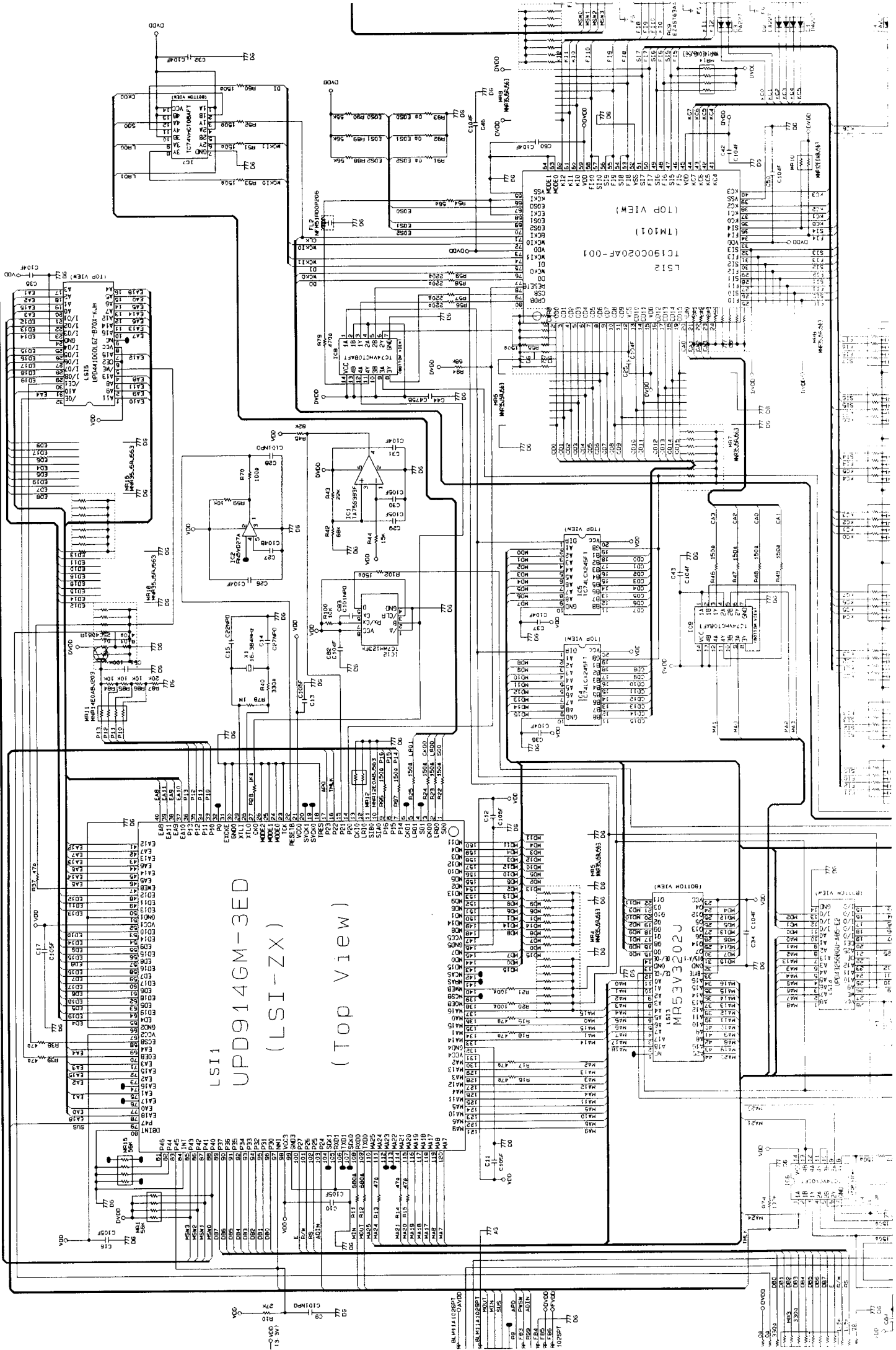

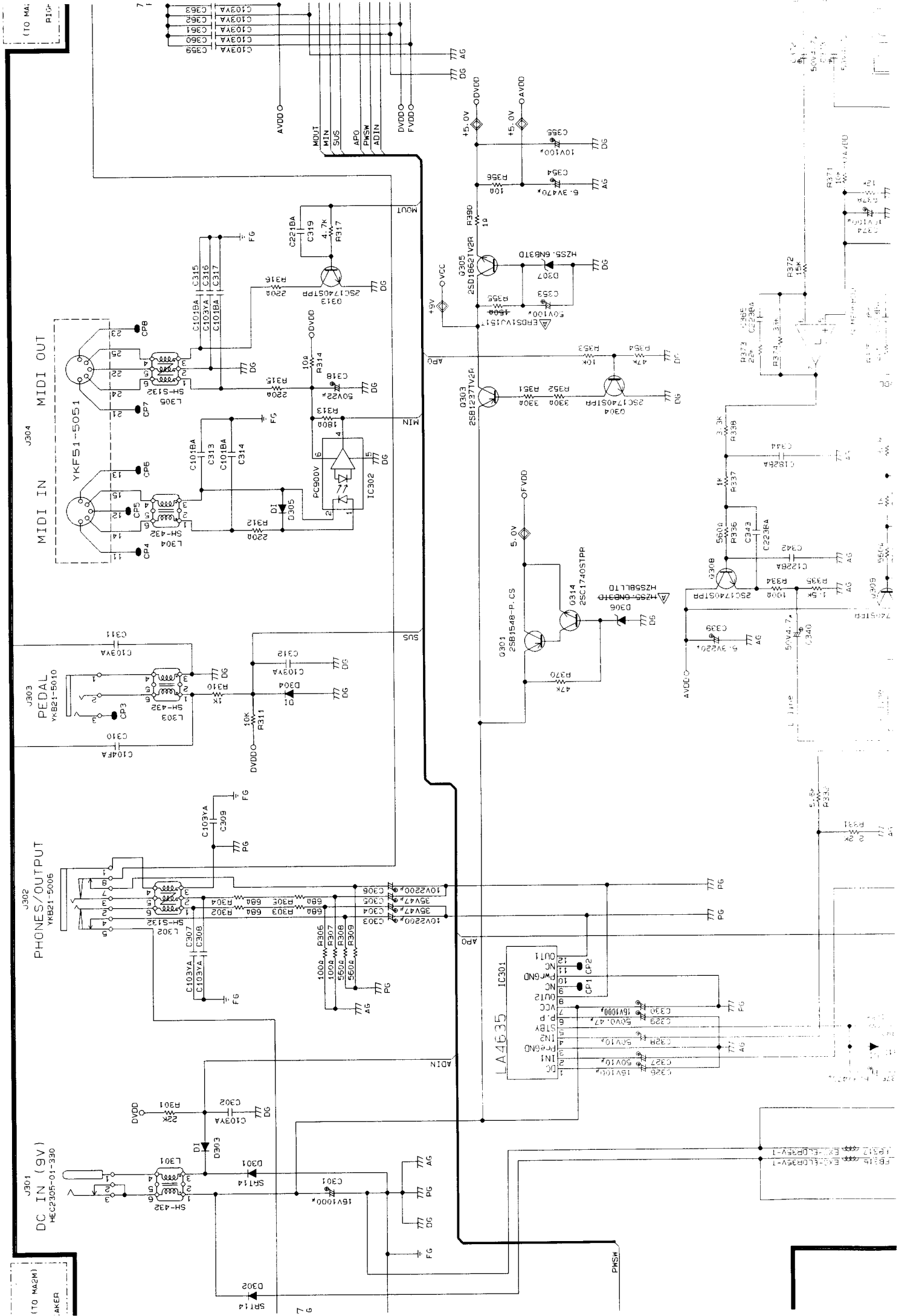

(TO MA: R10P

(TO MA2M) JAKER

FB15 EX-FELP35V-1
R312 EX-FELP35V-1
R311 EX-FELP35V-1
R310 EX-FELP35V-1
R309 EX-FELP35V-1
R308 EX-FELP35V-1
R307 EX-FELP35V-1
R306 EX-FELP35V-1
R305 EX-FELP35V-1
R304 EX-FELP35V-1
R303 EX-FELP35V-1
R302 EX-FELP35V-1
R301 EX-FELP35V-1

7

7

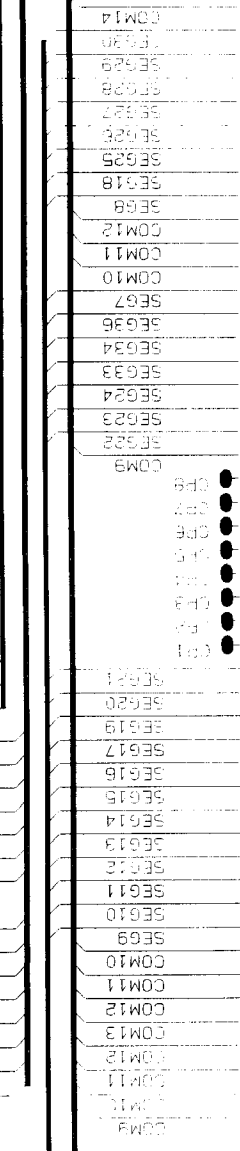
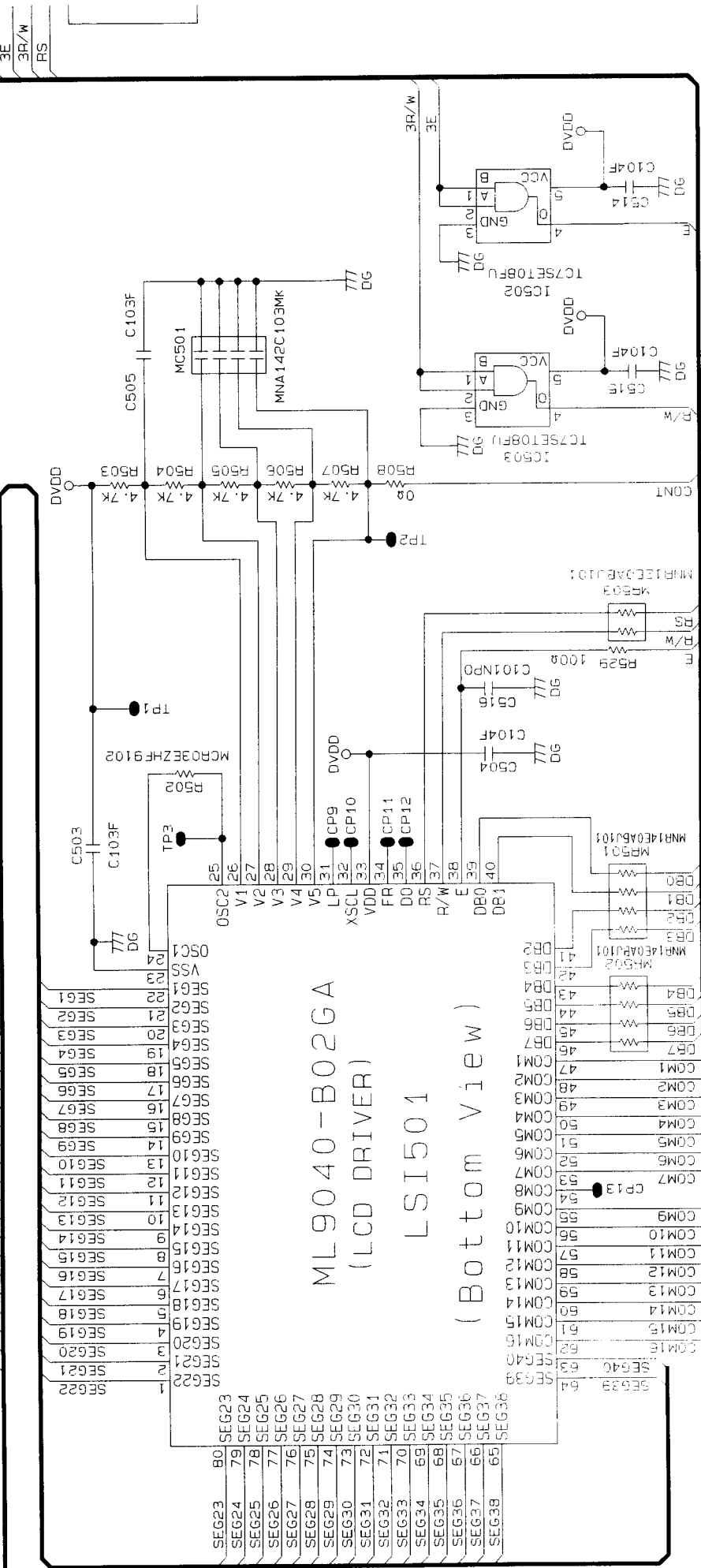
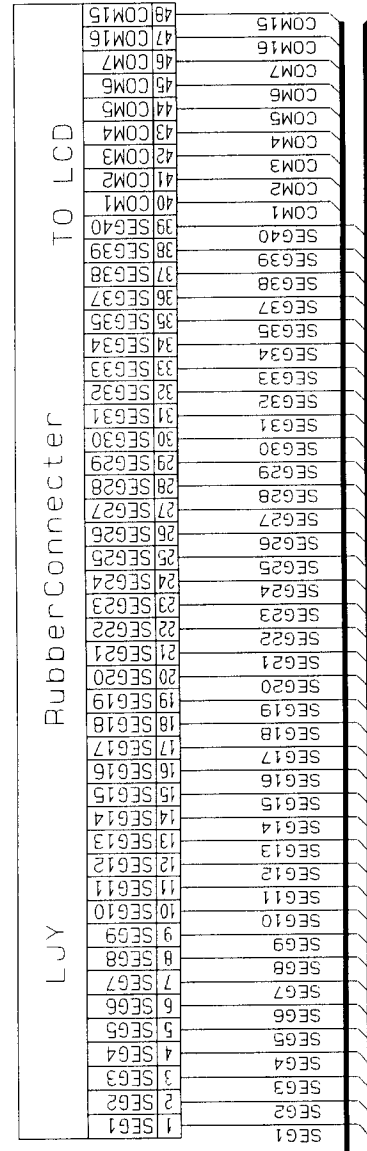

JCM618T-KY2M

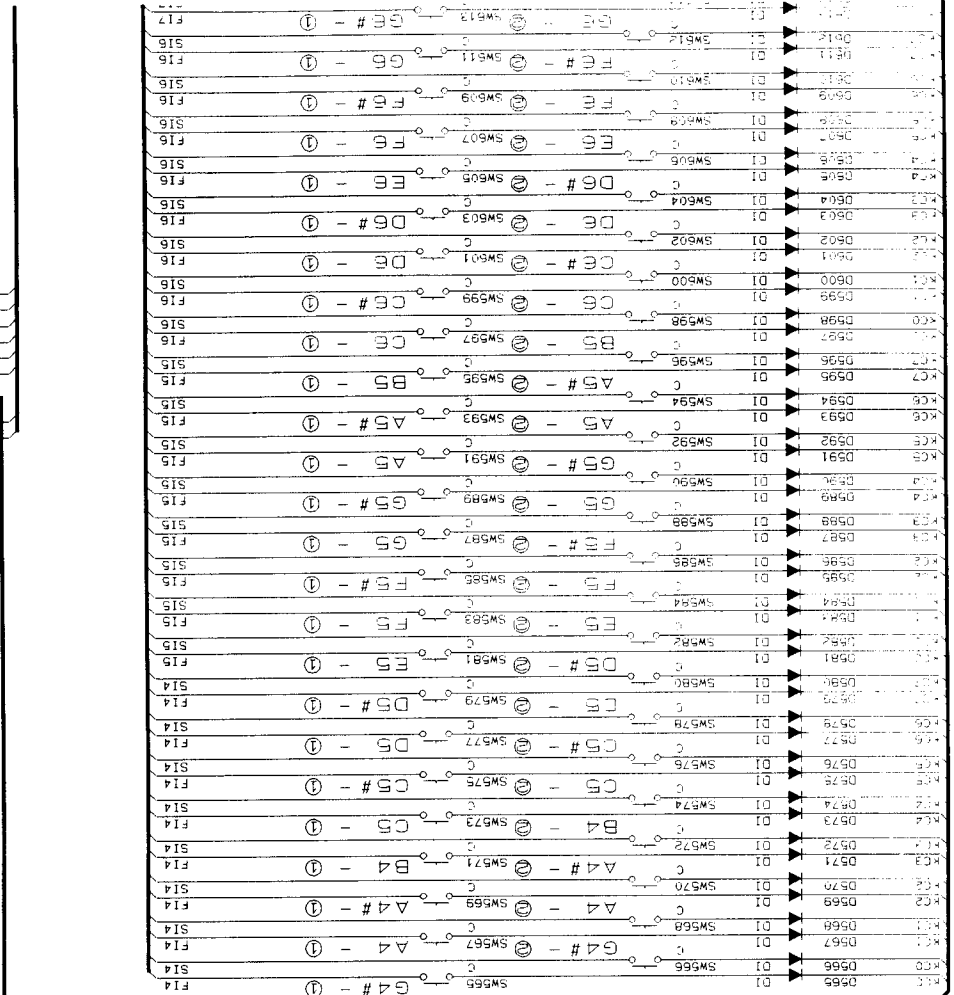
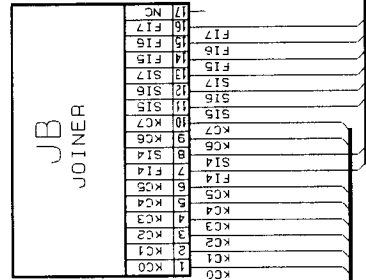

JCM618T-KY1M

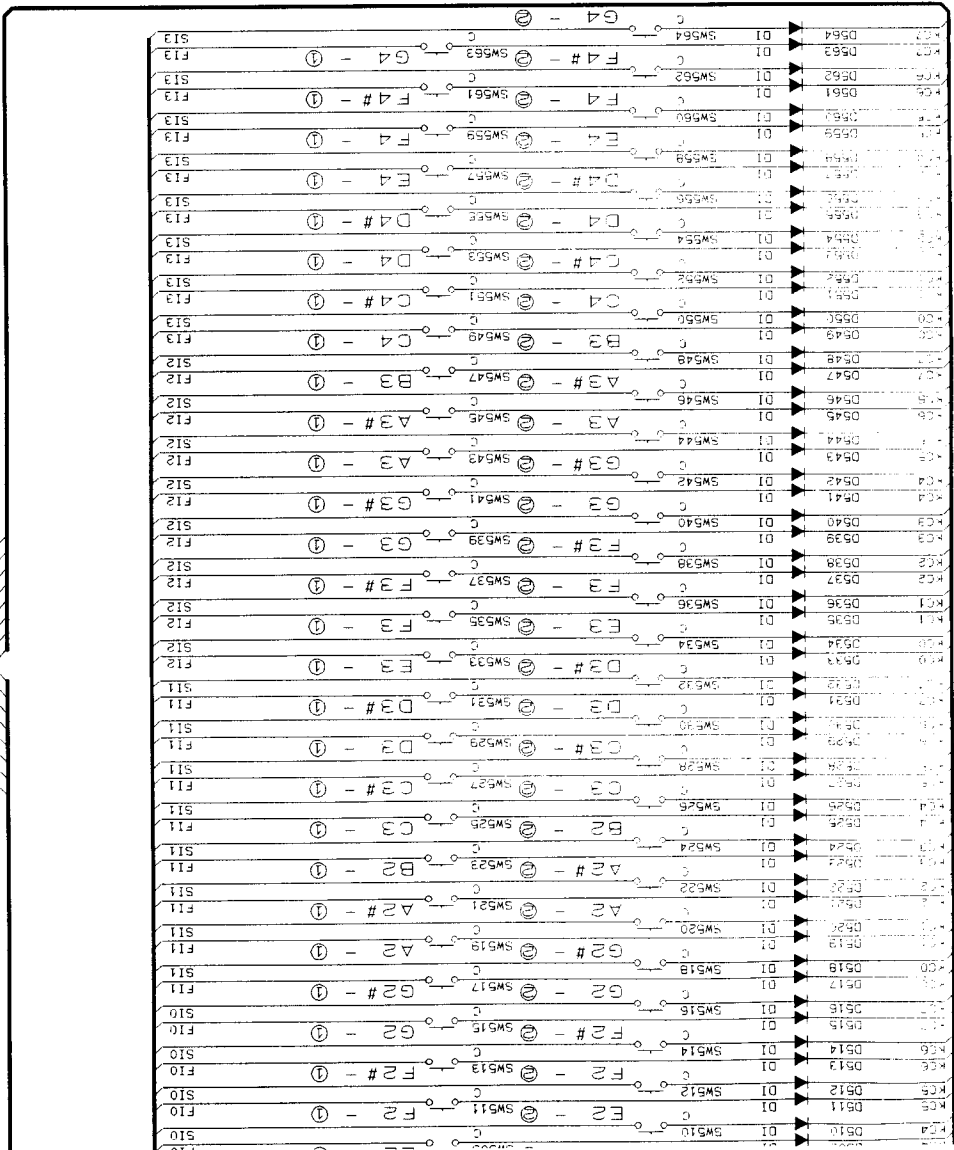
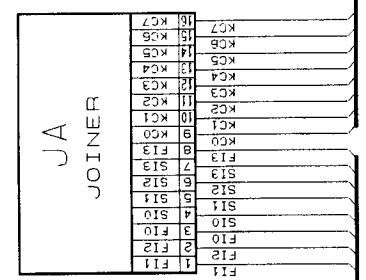

T-77-T
3T-77-T)

CN2

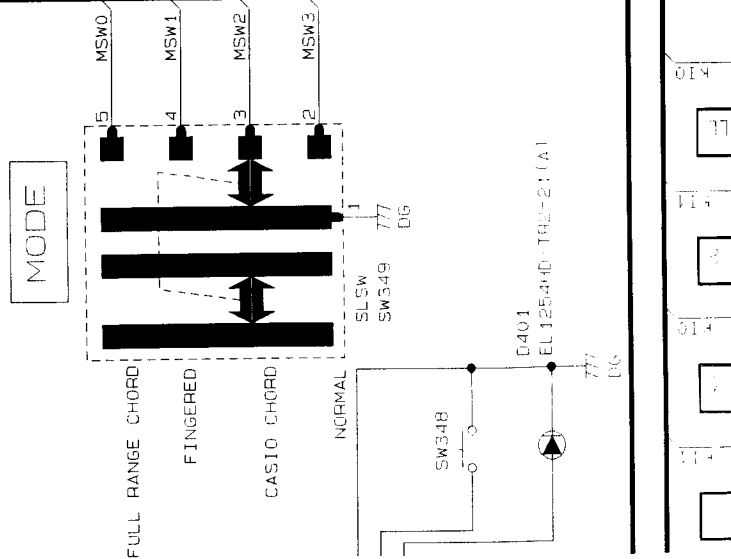
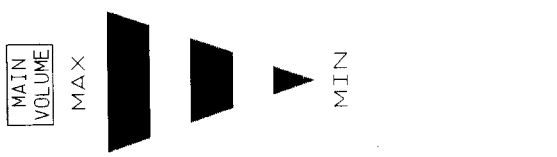
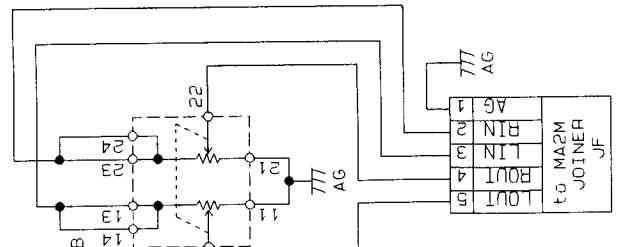

JCM703-CN1

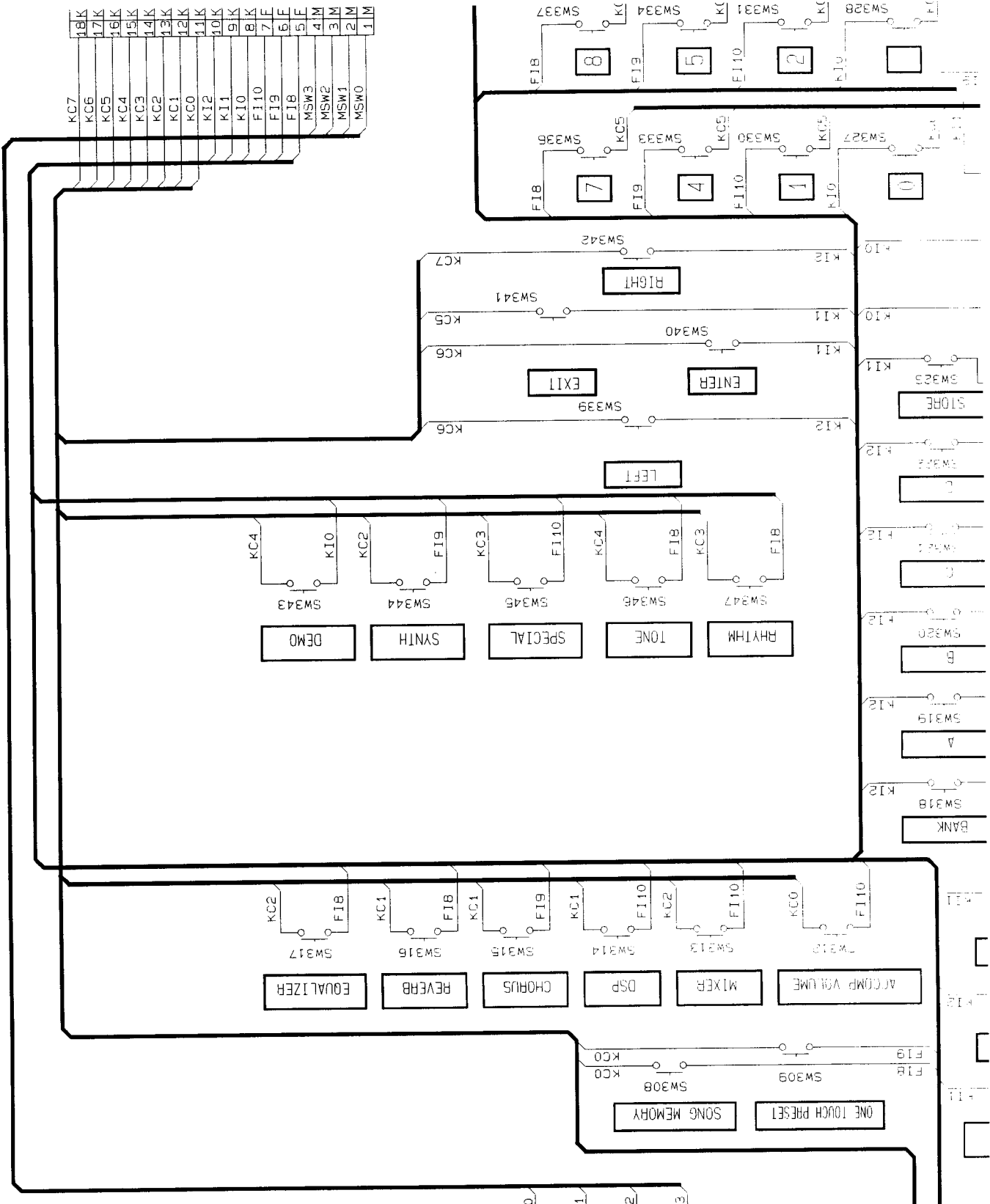

- KC7
- 18K
- KC6
- 17K
- KC5
- 16K
- KC4
- 15K
- KC3
- 14K
- KC2
- 13K
- KC1
- 12K
- KC0
- 11K
- KI2
- 10K
- KI1
- 9K
- KI0
- 8K
- F110
- 7F
- F19
- 6F
- F18
- 5F
- MSW3
- 4M
- MSW2
- 3M
- MSW1
- 2M
- MSW0
- 1M

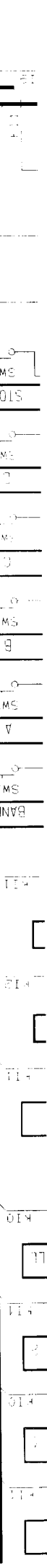
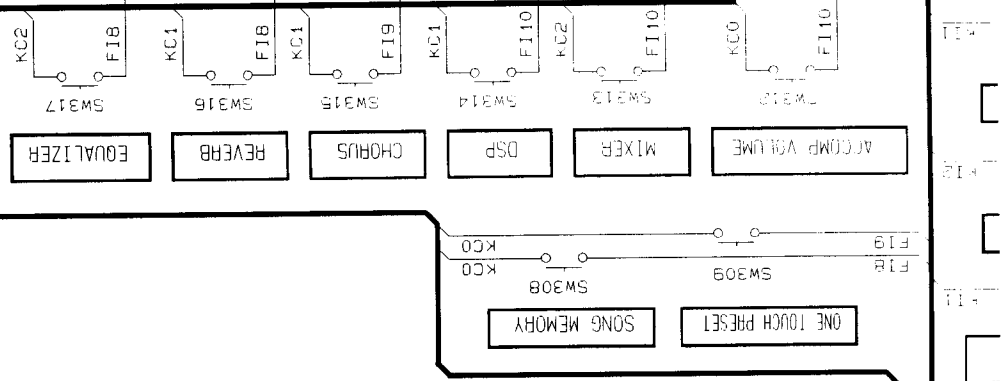
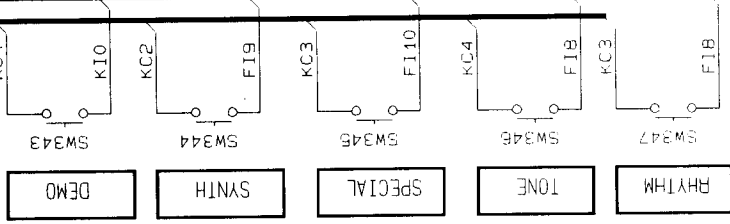
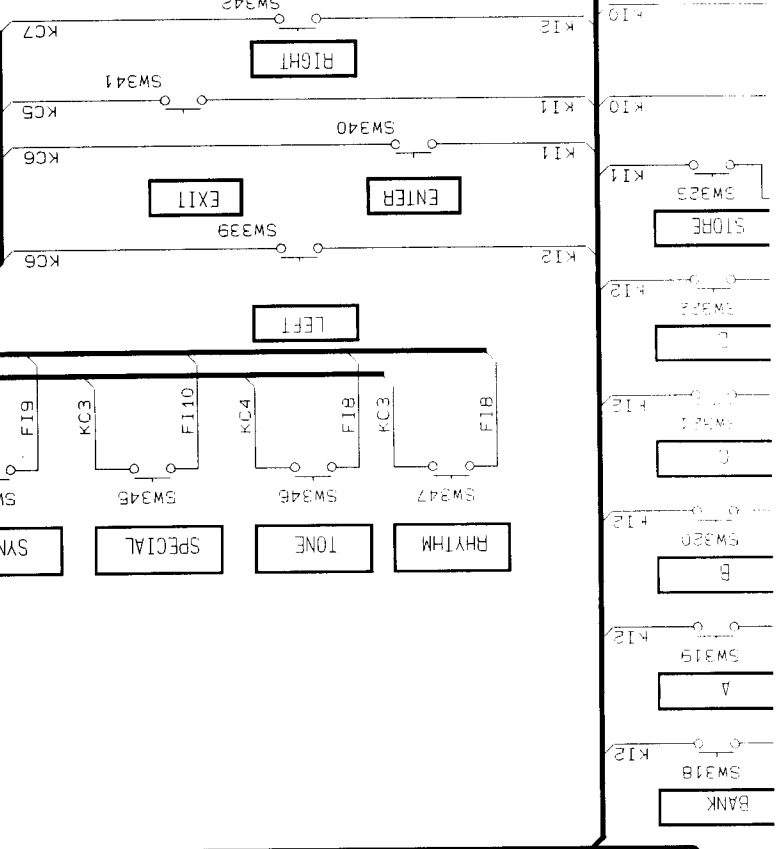
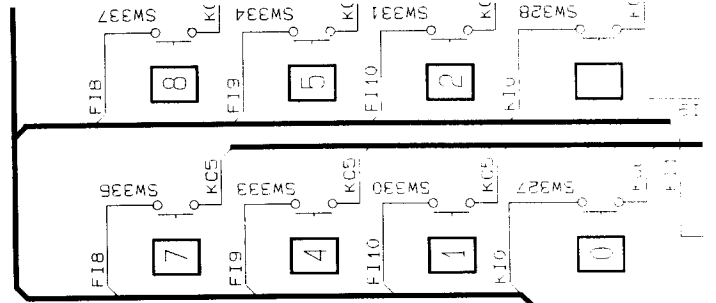

EXPLODED VIEW

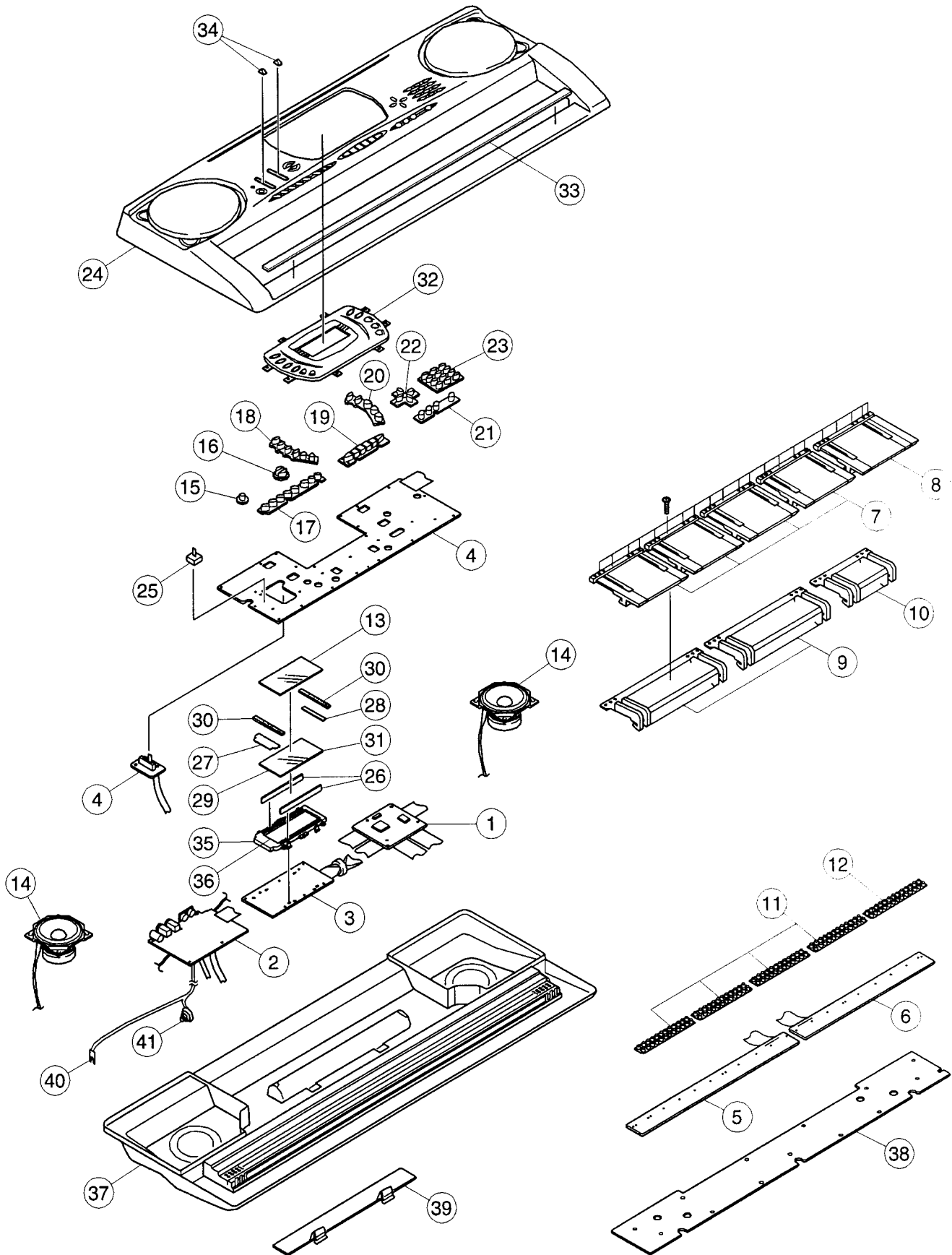

PARTS LIST

CTK-671

Notes: This parts list does not include the cosmetic parts, which parts are marked with item No. "R-X" in the exploded view.

Contact our spare parts department if you need these parts for refurbish.

1. Prices and specifications are subject to change without prior notice.
2. As for spare parts order and supply, refer to the "GUIDEBOOK for Spare parts Supply", published seperately.
3. The numbers in item column correspond to the same numbers in drawing.

N	ITEM	CODE NO.	PART NAME	SPECIFICATION	Q	PRICE CODE	R
MAIN PCB							
		1	1005 9366	PCB ASSY(MA1M)	TK-M241620*1(M703)		A
	D1-D4		6930 4610	DIODE	DA227	4	B
	FL2		3025 1862	FILTER/EMI	NFM51R00P206	1	B
	IC1		2105 4158	IC/MOS	TA75S393F(TE85L)	1	A
	IC11		6931 0466	IC/MOS	XC6203E332PR	1	A
	IC12		6930 9999	IC/L-MOS	TC7WH123FK(TE85L)	1	A
	IC13		6930 9995	IC/L-MOS	TC7SZ08FU(TE85L)	1	A
	IC2		7911 3782	IC/MOS	RN5VD27AA-TR	1	A
	IC3		2105 4746	LSI	UPD6379GR-E1	1	A
	IC4,IC5		2105 6576	IC/C-MOS	TC74LCX245FT(EL)	2	A
	IC6		6930 9980	IC/C-MOS	TC74VCX00FT(EL)	1	A
	IC7-IC9		6930 9981	IC/C-MOS	TC74VHCT08AF (EL)	3	A
	LSI1		1005 4502	LSI	UPD914AGM-3ED	1	A
	LSI2		2012 5987	LSI	TC190C020AF-001	1	A
	LSI3		1005 3636	LSI	MR27V3202E-86MA-N	1	A
	LSI4		1005 3638	LSI	UPD43256BGU-A85-E2	1	A
	LSI5		1005 3639	LSI	D441000LGZB70XKJE4	1	A
	Q1		6930 0298	TRANSISTOR	2SC4081T106R	1	B
	X1		1005 9360	OSCILLATOR/CRYSTAL	SMD-49-16.384M	1	B
SUB PCB ASSY							
		2	1005 9365	PCB ASSY(MA2M)	TK-M241622*1(M703)	1	B
	D301,D302		2390 3021	DIODE	SRT14	2	B
	D303-D305,D310		2315 3132	DIODE	1SS133T-77	4	B
	D306		2360 0644	DIODE/ZENER	HZS5BLLTD	1	B
	D307		2360 3084	DIODE/ZENER	HZS5.6NB3TD	1	B
	IC301		1004 3474	IC/MONOLITHIC	LA4635A	1	A
	IC302		2114 1421	IC/PHOTO COUPLER	PC900V	1	B
	IC304		2121 0072	IC/MONOLITHIC	NJM2068DD	1	A
	J301		3501 7049	JACK/DC	HEC2305-01-330	1	A
	J302		3612 0665	JACK/PHONE	YKB21-5006	1	B
	J303		3612 0789	JACK	YKB21-5010	1	B
	J304		3501 4816	JACK/DIN	YKF51-5051	1	B
	Q301		2251 0672	TRANSISTOR	2SB1548-P.CS	1	A
	Q303		2250 1591	TRANSISTOR	2SB1237TV2R	1	A
	Q304,Q308,Q309, Q312-314		2250 1592	TRANSISTOR	2SC1740STPR	6	A
	Q305		6930 0356	TRANSISTOR	2SD1862TV2R	1	A
DISPLAY PCB							
		3	1006 4963	PCB ASSY(LCD1M)	TK-M241650*1(M703)	1	B
	IC502,IC503		6930 9991	IC/L-MOS	TC7SET08FU(TE85L)	2	A
	LSI501		1000 6502	LSI	ML9040-B02GA	1	A
CONSOLE PCB							
		4	1005 9367	PCB ASSY(CN1,2)	TK-M241624*1(M703)	1	B
	D401		6930 4806	LED	EL-204HD/TR2-1(A)	1	B
	VR401		2765 2213	VOLULME	RS20H121-2KB	1	A
KEYBOARD PCB							
		5	1002 5799	PCB ASSY(KY1M)	TK-M140687*7(M474)	1	B
		6	1005 9370	PCB/ASSY(KY2M)	TK-M140688*10(M703)	1	B
	D501~D564		2301 0101	DIODE	1S2473-T-77-T	64	B
	D565~D622		2301 0101	DIODE	1S2473-T-77-T	58	B

Notes:N- New parts

Q- Quantity used per unit

R- Rank

N	ITEM	CODE NO.	PART NAME	SPECIFICATION	Q	PRICE CODE	R
KEYBOARD UNIT							
	7	6922 2721	WHITE KEY SET/LT	M312118A*1	4		A
	8	6922 2731	WHITE KEY SET/LT	M312118A*2	1		A
	9	6906 8482	BLACK KEY SET 10P	M140369B-3	2		A
	10	6906 8592	BLACK KEY SET 5P	M140369B-4	1		A
	11	6922 2762	RUBBER/KEY	M211704B-1	4		B
	12	6922 2772	RUBBER/KEY	M211705B-1	1		B
PANEL UNIT							
	13	1005 3647	LCD	CG1902-TTP	1		B
	14	1005 9358	SPEAKER	12K60SHA9225C	2		B
	15	1004 7853	RUBBER/BUTTON	M341423-1	1		B
	16	1004 7854	RUBBER/BUTTON	M241550-1	1		B
	17	1004 7855	RUBBER/BUTTON	M241543-1	1		B
	18	1004 7856	RUBBER/BUTTON	M241544-1	1		B
	19	1004 7857	RUBBER/BUTTON	M241545-1	1		B
	20	1004 7858	RUBBER/BUTTON	M241546-1	1		B
	21	1004 7859	RUBBER/BUTTON	M241547-1	1		B
	22	1004 7860	RUBBER/BUTTON	M241548-1	1		B
	23	1004 7861	RUBBER/BUTTON	M241549-1	1		B
	24	1005 9359	CASE SUB ASSY/UPPER	M241619*1	1		B
	25	6927 0510	CONTACT/SL	CSB-08D	1		C
	26	1002 7158	CONNECTOR	M441141-1	2		C
	27	6930 7200	PIECE/TOP 476-L	M441142A-1	1		X
	28	6930 7201	PIECE/TOP 476-R	M441143A-1	1		X
	29	6930 7202	FILM	M441144A-1	1		C
	30	1003 7738	SPONGE	M441167-1	2		C
	31	1003 0993	PLATE/BL	M341362-1	1		C
	32	1005 3931	PANEL/DISPLAY	M141171-1	1		C
	33	6922 4480	DUMPER/KEY	M412324-1	1		C
	34	6921 5030	KNOB/SLIDE	M311859-1	2		B
	35	1006 2649	REFLECTOR	M241321A-2	1		B
	36	1003 7737	FACE/D	M441174-1	1		X
D506,D509		1003 2149	LED	FY4067S-2C1-B170	2		B
COMPONENT							
	37	1005 9361	CASE SUB ASSY/MUSIC	M141274*1	1		X
	38	6906 9252	PLATE/LOWER	M240573B-2	1		X
	39	1003 7742	BATTERY COVER SUB ASSY	M341235*3(M476)	1		B
	40	6903 2150	SPRING/BATTERY(+)	M41330-1	1		X
	41	6902 6141	SPRING/BATTERY(-)	M41226A-1	1		X
		6928 5280	STAND ASSY/MUSIC	M340769*2 TK	1		X

Notes: N- New parts

Q- Quantity used per unit

R- Rank

Ver.1 : Correction of all contents except exploded view and parts list.
Because Service Manual for CTK-671 in Vol.CB-15 contains
totally wrong information.

CASIO TECHNO CO.,LTD.
Overseas Service Division

Nishi-Shinjuku Kimuraya Bldg. 1F
5-25, Nishi-Shinjuku 7-Chome
Shinjuku-ku, Tokyo 160-0023, Japan