

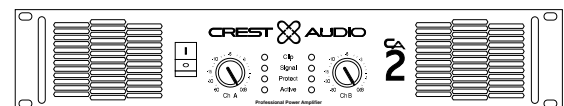

PROFESSIONAL POWER AMPLIFIERS

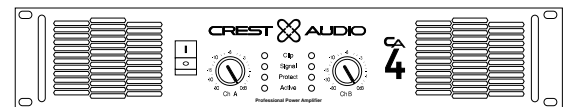
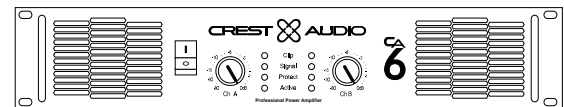
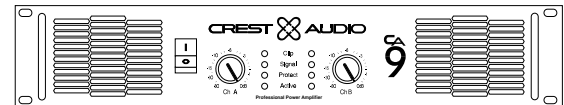
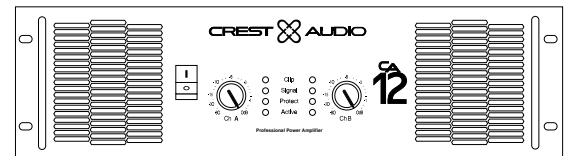
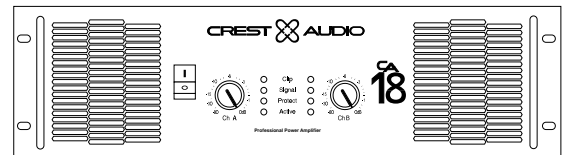

OWNER'S MANUAL

# Important Precautions



This symbol is used to alert the operator to follow important operating procedures and precautions detailed in documentation.



This symbol is used to warn operators that uninsulated “dangerous voltages” are present within the equipment enclosure that may pose a risk of electric shock.

- 1. Save the carton and packing material even if the equipment has arrived in good condition.** Should you ever need to ship the unit, use only the original factory packing.
- 2. Read all documentation before operating your equipment.** Retain all documentation for future reference.
- 3. Follow all instructions** printed on unit chassis for proper operation.
- 4. Do not spill water or other liquids into or on the unit,** or operate the unit while standing in liquid.
- 5. Make sure power outlets conform to the power requirements** listed on the back of the unit.
- 6. Do not use the unit if the electrical power cord is frayed or broken.** The power supply cords should be routed so that they are not likely to be walked on or pinched by items placed upon or against them, paying particular attention to cords and plugs, convenience receptacles, and the point where they exit from the appliance.
- 7. Always operate the unit with the AC ground wire connected** to the electrical system ground. Precautions should be taken so that the means of grounding of a piece of equipment is not defeated.
- 8. Mains voltage must be correct and the same as that printed on the rear of the unit.** Damage caused by connection to improper AC voltage is not covered by any warranty.
- 9. Have gain controls on amplifiers turned down during power-up** to prevent speaker damage if there are high signal levels at the inputs.
- 10. Power down & disconnect units from mains voltage before making connections.**
- 11. Never hold a power switch in the “ON” position if it won’t stay there itself!**
- 12. Do not use the unit near stoves, heat registers, radiators, or other heat producing devices.**
- 13. Do not block fan intake or exhaust ports.** Do not operate equipment on a surface or in an environment which may impede the normal flow of air around the unit, such as a bed, rug, weathersheet, carpet, or completely enclosed rack. If the unit is used in an extremely dusty or smoky environment, the unit should be periodically “blown free” of foreign matter.
- 14. Do not remove the cover.** Removing the cover will expose you to potentially dangerous voltages. There are no user serviceable parts inside.
- 15. Connecting amplifier outputs to oscilloscopes or other test equipment** while the amplifier is in bridged mode may damage both the amplifier and test equipment!
- 16. Do not drive the inputs with a signal level greater than that required to drive equipment to full output.**
- 17. Do not connect the inputs / outputs of amplifiers or consoles to any other voltage source,** such as a battery, mains source, or power supply, regardless of whether the amplifier or console is turned on or off.
- 18. Do not run the output of any amplifier channel back into another channel’s input. Do not parallel- or series-connect an amplifier output with any other amplifier output.** Crest Audio is not responsible for damage to loudspeakers for any reason.
- 19. Do not ground any red (“hot”) terminal. Never connect a “hot” (red) output to ground or to another “hot” (red) output!**
- 20. Non-use periods.** The power cord of equipment should be unplugged from the outlet when left unused for a long period of time.
- 21. Service Information** Equipment should be serviced by qualified service personnel when:
  - A.** The power supply cord or the plug has been damaged;
  - B.** Objects have fallen, or liquid has been spilled into the equipment;
  - C.** The equipment has been exposed to rain;
  - D.** The equipment does not appear to operate normally, or exhibits a marked change in performance;
  - E.** The equipment has been dropped, or the enclosure damaged.
- 22. To obtain service,** contact your nearest Crest Audio Service Center, Distributor, Dealer, or Crest Audio at 201.909.8700 (USA).

## Table of Contents

	Introduction	5
	Unpacking	5
	Installation and Mounting	5
	Front Panel	6
	Rear Panel	7
	Internal Configuration and Control	8
	Operation	9
Connecting Power / Circuit Size Requirements		9
	Cooling Requirements	9
	Connecting Inputs	10
	Connecting Outputs	10
	Mode Selection	10
Stereo /Parallel/Bridged Mono Connections		12
	TourClass® Protection Features	14
	User Precautions	15
	Speaker Protection	15
Recommended Speaker Cabling		15
	Maintenance	16
	User Responsibility	16
	Service and Repair	16
Appendix A	Specifications	
Appendix B	CA Block Diagram	
Appendix C	Wire Gauge Charts	
Appendix D	Rear Panel Symbols - Legend	
Appendix E	CA18 Power Amplifier - Special Functions	

### CA12, CA18 Front View

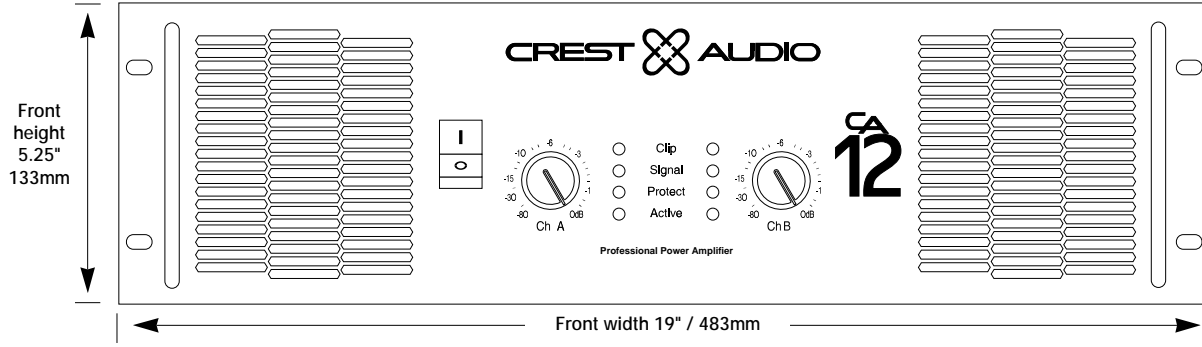

### CA2-9 Front View

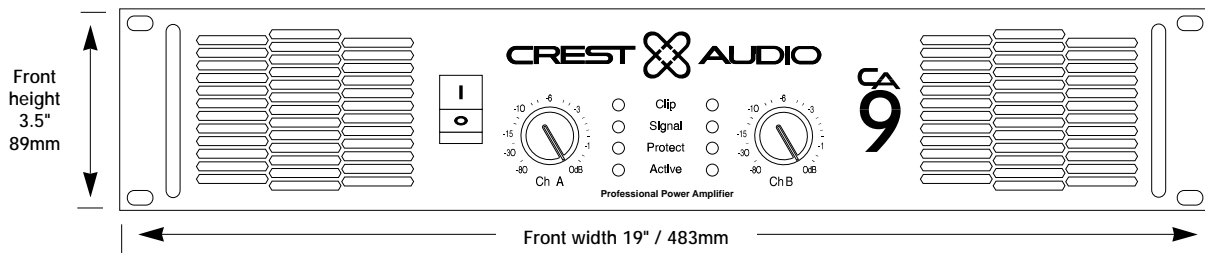

### Rear & Side Views

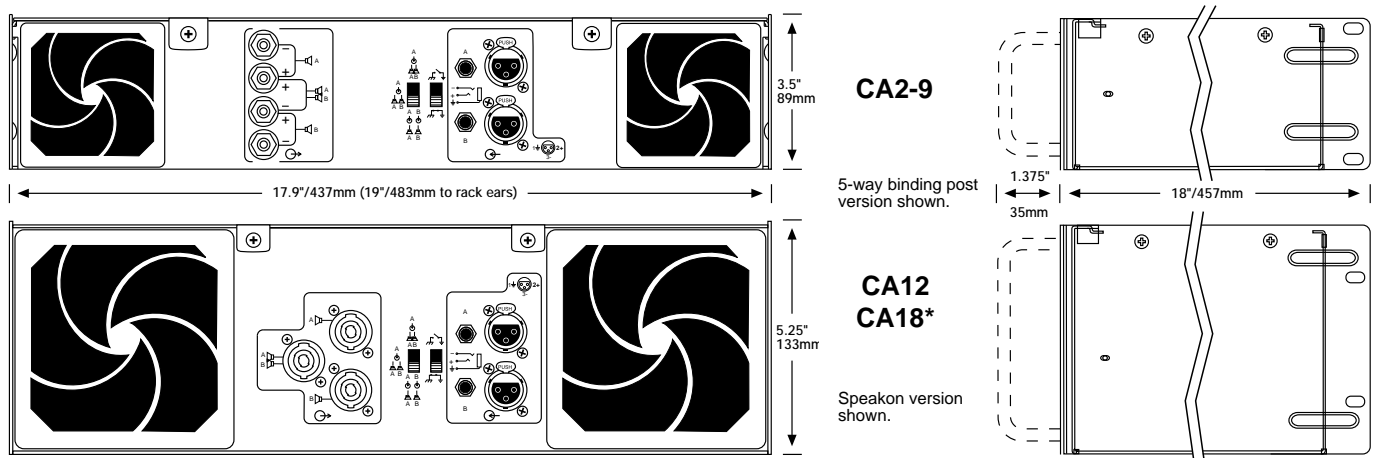

*\*Note: see Appendix E for detailed CA18 rear panel drawings.*

## Introduction

Congratulations on your purchase of a new CA Series professional power amplifier, and thank you for your confidence in Crest Audio products. You are among the growing number of audio professionals who have made Crest Audio one of the world's leading suppliers of professional and commercial/industrial audio systems.

For your safety, please read the Important Precautions section before installing and operating the amplifier.

The Crest Audio CA Series is based on the same advanced circuit topologies that have made Crest amplifiers the choice of touring professionals worldwide. CA Series amplifiers are designed for high operating efficiency and accurate sonic performance across the full audio bandwidth, even under stressful conditions. In order to maintain strict quality assurance standards, all CA Series amplifiers are built in Crest's state-of-the-art USA manufacturing facility. Internal components are the finest available, and key sub-assemblies are pre-tested before final assembly. Finally, each amplifier is "burned in" and thoroughly tested (using precision audio test equipment) before shipping. In addition, all CA Series amplifiers incorporate Crest's exclusive TourClass protection features to safeguard both internal circuitry and connected loudspeakers.

This proven combination of advanced design, quality construction, and comprehensive circuit protection is your guarantee of fail-safe reliability. You can depend on consistent, stable performance even when your CA Series amplifier is subjected to punishing extremes in the most demanding fixed or mobile sound reinforcement applications.

## Unpacking

Please inspect the amplifier carefully immediately after unpacking. If you find any damage, notify your supplier/dealer immediately. Only the shipper may file a damage claim with the carrier for damage incurred during shipping. Be sure to save the carton and all packing materials for the carrier's inspection.

If your packing materials are in good condition, please save them. If you ever need to ship the unit back to Crest Audio or an authorized service center, you should use only the original factory packing.

## Installation and Mounting

Four CA Series amplifiers are 2-rack-space units: models CA2, CA4, CA6, and CA9. Models CA12 and CA18 are 3-rack-spaces high. All mount in standard 19-inch racks. Four front-panel mounting holes are provided on each amplifier. Rear mounting ears give additional support, and use of rear supports is highly recommended in all mobile and touring sound systems. Optional rack-mount handles are available.

## Front Panel

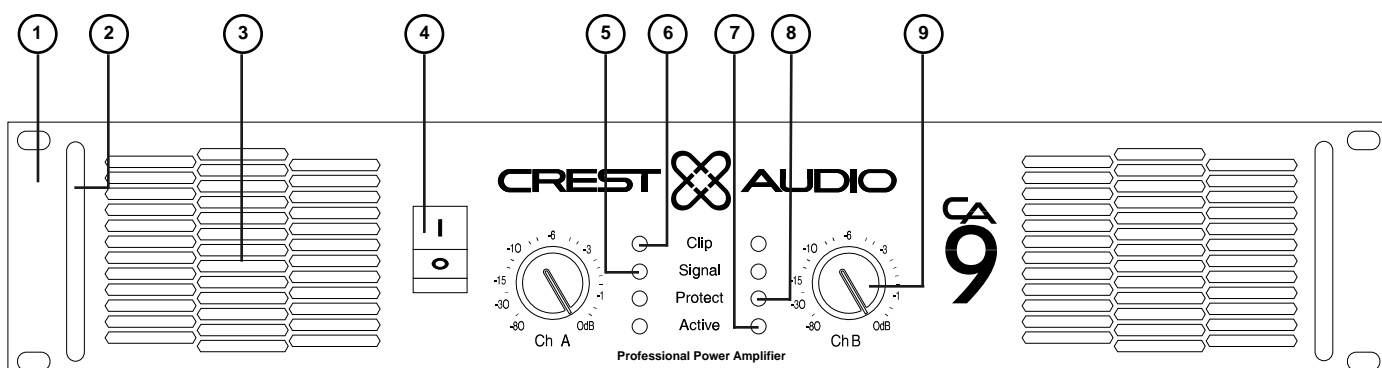

### 1. Rack Mounting Ears.

Two front panel mounting holes are provided on each mounting ear.

### 2. Optional Rack Handles.

Available from your authorized Crest Audio supplier.

### 3. Fan Outlet Grills.

CA Series amplifiers are cooled by two, rear-mounted fans. Cool air flows over the heat sinks and exhausts through the front grills. Make sure these outlets remain clear to allow unrestricted air flow.

### 4. AC Power Switch/Circuit Breaker.

CA Series amplifiers have a front-panel combination AC switch and circuit breaker. (No fuses are used.) If the switch shuts off during normal use, push it back to the “ON” position once. If it will not stay on, the amplifier needs servicing.

### 5. Signal LED.

Illuminates to indicate that a signal (above a minimum threshold) is present at the amplifier input, and that the signal is being amplified.

### 6. Clip LED.

Illuminates at the clipping threshold. Continuous illumination also indicates that ACL (Active Clip Limiting) protection circuitry is engaged.

### 7. Active LED.

Indicates that AC power is connected and the amplifier is turned on.

### 8. Protect LED.

Indicates that the channel is in Protect mode (speakers disconnected by output relay).

### 9. Input Attenuators.

Two input attenuators adjust level for their respective amplifier channels. In Bridged Mono Mode, both attenuators are used to control signal level and must be adjusted to the same setting.



**Never try to hold the circuit breaker/power switch in the “ON” position if it won’t stay there itself!**

**Rear Panel** See Appendix E for information specific to model CA18.

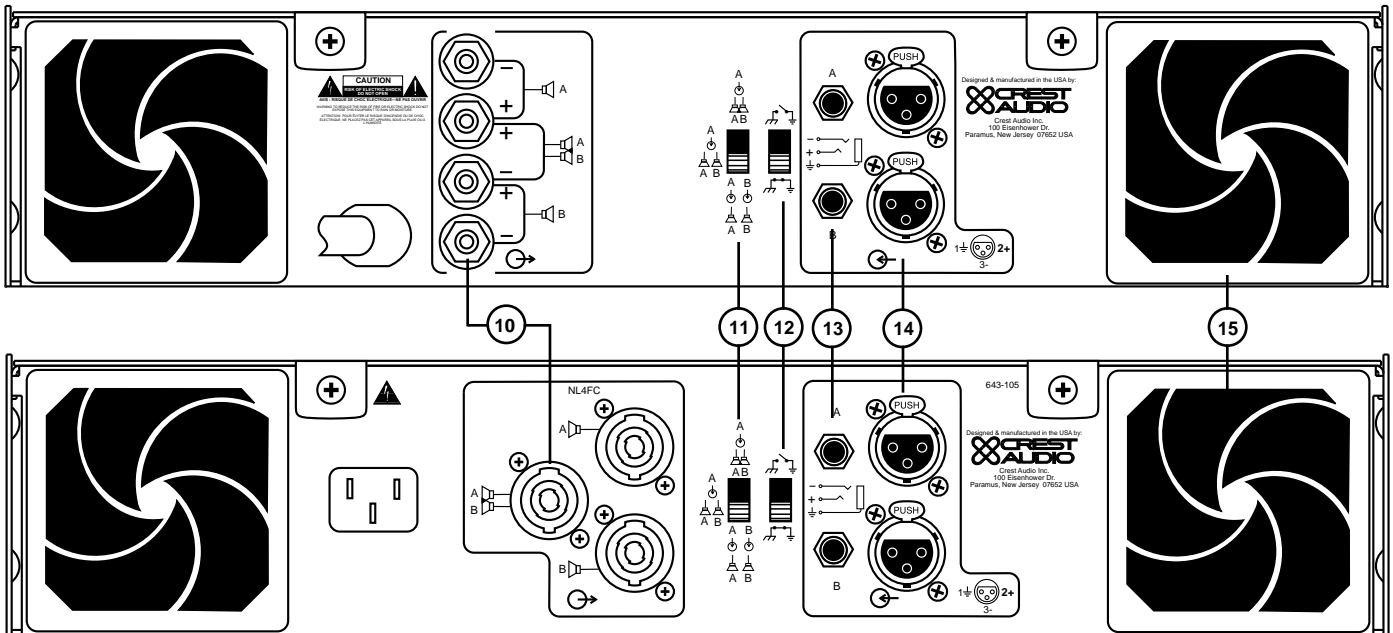

**10. Output Connectors (Two versions, market dependent)**

CA Series amplifiers are supplied with either 5-way Binding Posts or Speakon connectors. Connection to the binding posts can be made with bare wire, banana plugs, or spade lug terminations. Make connections to both the Channel A and Channel B terminals for Stereo or Parallel Mode, or a single connection across the red (“hot”) terminals only of Channels A and B for Bridged Mono Mode. Using Speakon-type speaker cables, make connections to both the Channel A and Channel B connectors for Stereo or Parallel Mode, or to the Bridged mode connector for Bridged Mono Mode. See Appendix D and the section on *Mode Selection* for more information. *NOTE: on the 5-way Output Binding Post version of the CA18, two pairs of 5-way binding posts are provided for each channel, so that paralleling of speakers is possible.*

**11. Mode Selection Switch.**



**Never connect a “hot” (red) output to ground or to another “hot” (red) output!**

This recessed, three-position switch configures the amplifier for Stereo, Parallel or Bridged Mono Mode operation. Amplifiers are factory-configured for Stereo Mode. See Appendix D and the section on *Mode Selection* for more information.

**12. Signal Ground Lift Switch.**

The recessed signal ground lift switch (factory-set to the ‘ground’ [bottom] position) electrically connects signal ground to the chassis/AC ground. The top position lifts the amplifier’s signal ground. In a properly designed system (for safety purposes and to minimize noise), amplifiers should be connected to ground through the AC line cord. Also, whenever possible, the signal source equipment should share the same AC ground as the amplifier. In some cases this may not be possible, and a ground loop results. If this happens, the first step is to move the ground lift switch to the top (‘lift’) position. In this position, the signal ground is lifted and completely isolated from the chassis/AC ground. Do not change the switch to the ‘lift’ position if the amplifier and the signal source equipment are on the same AC ground. Should the ground loop problem persist after the ground lift switch has been set to the ‘lift’ position, then the shield on balanced input lines should be grounded at one end only (usually the signal source).

### 13-14. Balanced 1/4" (TRS) & XLR Input Connectors.

These connectors accept input signals on balanced TRS and XLR input plugs. See the figure at the left for information on polarity. Connectors for each channel are in parallel; the unused connectors may be used for “loop through” connection to other amplifiers.

*NOTE: Unbalanced “Tip/Sleeve” plugs may be used with the balanced TRS “Tip/Ring/Sleeve” connectors. The “ring” terminal or negative input will be connected to ground internally. When using three-pole (‘stereo’) TRS connectors, make sure that the ring connection is made either to the cold (-) output of the source equipment, or to ground. Incorrect connections may cause a 6dB loss in level.*

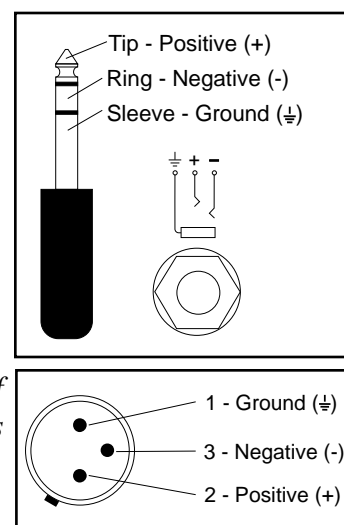

### 15. Fan Inlet Ports & Filters.

Cooling air enters the amplifier through the fan inlet ports located on the rear of the amplifier chassis. Be sure not to block these ports when installing the amplifier or other associated equipment. Air must flow unimpeded through these ports. Fan filters (removable without tools) are provided to minimize entry of dust and dirt.

## Internal Configuration and Control

### Input XLR Polarity

CA Series amplifiers are supplied standard with the XLR configured as “Pin 2 hot” (+). On models CA2, CA4, CA6, CA9 and CA12, an internal jumper makes it possible to alter the amplifier to “Pin 3 hot” (+).

*NOTE: This jumper is NOT user configurable. Please consult your supplier or local Crest Audio service center if you wish to have the input XLR polarity changed*

On the CA18, an external XLR polarity switch is featured. (See Appendix E).

### Input Sensitivity

The CA Series amplifiers have a standard input sensitivity of .775 Volts for rated power at 8 Ohms. Models CA2, CA4, CA6, CA9 and CA12 are fitted with an internal jumper which allows optional gains of X20 or X40. Model CA18 features an external voltage gain/input sensitivity switch (See Appendix E). Standard and optional voltage gains/input sensitivities are detailed below.

	CA2		CA4		CA6		CA9		CA12		CA18	
	Gain	Sens	Gain	Sens	Gain	Sens	Gain	Sens	Gain	Sens	Gain	Sens
<b>Std.</b>	X45	.775V	X61	.775V	X68	.775V	X86.5	.775V	X97.5	.775V	X115	.775V
<b>Opt. 1</b>	X40	.866V	X40	1.12V	X40	1.32V	X40	1.66V	X40	1.87V	X40	2.24V
<b>Opt. 2</b>	X20	1.73V	X20	2.24V	X20	2.65V	X20	3.32V	X20	3.74V	X20	4.47V

*NOTE: This jumper is NOT user configurable. Please consult your supplier or local Crest Audio service center if you wish to have the voltage gain / input sensitivity changed.*



## Operation

### Connecting Power / Circuit Size Requirements.

CA Series amplifier power requirements are rated at:

- a) “idle”
- b) 1/8th power (“typical” music conditions)
- c) 1/3rd power (“continuous” music conditions)
- d.) maximum rated power (circuit breaker limited).

The maximum power current draw rating is limited only by the front panel circuit breaker. Consult the specifications in the *Appendices* section for figures on the current that each amplifier will demand.

Make sure the mains voltage is correct and is the same as that printed on the rear of the amplifier. Damage caused by connecting the amplifier to improper AC voltage is not covered by any warranty. Unless otherwise specified when ordered, Crest amplifiers shipped to customers are configured as follows:

North America	-	120VAC / 60Hz
Europe	-	230VAC / 50Hz
Asia	-	220VAC / 50Hz
Australasia	-	240VAC / 50Hz
South America	-	120VAC / 60Hz or 220VAC / 50Hz
Japan	-	100VAC / 50Hz

*NOTE: Always turn off and disconnect the amplifier from mains voltage before making audio connections. Also, as an extra precaution, have the attenuators turned down during power-up.*

### Cooling System and Requirements.

CA Series amplifiers use a twin-tunnel forced-air cooling system to maintain a low, even operating temperature. Drawn in by dual 45 cubic feet-per-minute (CFM) fans on the rear panel, air flows through the cooling fins of the channel heat sinks (dissipating power transistor heat), then exhausts through the front panel slots. The “intelligent” variable-speed DC fans are controlled by heat sink temperature-sensing circuits. When the amplifier is turned on, the fans briefly “rev up,” then slow to an idle; this indicates that the temperature sensing circuits are operating normally. The fan speed increases only as required by heat sink temperatures, keeping fan noise to a minimum. Under extreme thermal load, the fans will force a very large volume of air through the heat sinks. If either heat sink surpasses the maximum allowed temperature, the sensing circuit will open the output relay, disconnecting the load from that channel. If the power transformer overheats, another sensing circuit opens both channel output relays until the transformer cools to a safe temperature.

*IMPORTANT: To ensure optimum cooling, periodically clean the amplifier fan filters (removable without tools). Also make certain that there is enough space around the front of the amplifier to allow the cooling air to escape. If the amplifier is rack-mounted, do not use doors or covers on the front of the rack; the exhaust air must flow out without resistance. If the amplifiers are to be housed in racks with closed backs, allow at least one (1) standard rack space of opening in the front of the rack for every four amplifiers.*



### **Connecting Inputs.**

Use either the XLR or 1/4-inch input connectors on the rear to supply audio signals to your Crest Audio CA Series amplifier. Both connectors accept balanced and unbalanced audio connections. (The CA Series amplifiers are configured standard with “Pin 2 hot” on XLR inputs. Please note that some other Crest Audio amplifiers are configured with “Pin 3 hot”). The unused connector can be used to jumper the audio input to another amplifier input. For more information, see the sections on *Balanced 1/4" (TRS) & XLR Input Connectors*, *Input XLR Polarity*, and *Input Sensitivity*.

### **Connecting Outputs.**

Speakers are connected using 5-way Output Binding Posts or Speakon connectors, depending on version supplied. Please note that on the 5-way Output Binding Post version of the CA18, two pairs of 5-way binding posts are provided for each channel, so that paralleling of speakers is possible.

For more information, see the *Output Connectors* and *Mode Selection* sections.

## Mode Selection.

The three-position, recessed Mode Select switch (located on the rear panel) configures the amplifier for either Stereo, Parallel or Bridged Mono Mode. Amplifiers are factory-configured for Stereo Mode.

### Stereo Mode.

In Stereo Mode, both channels operate independently, with their input attenuators controlling their respective levels. Signal at Channel A's input produces output at Channel A's output, while signal at Channel B's input produces output at Channel B's output. Recommended minimum nominal load impedance for stereo operation is 2 ohms per channel. Either the 1/4" (TRS) inputs or the XLR inputs may be used.

### Parallel Mode.

When set to Parallel Mode, a signal applied to Channel A's input will be amplified and appear at outputs for both Channels A & B. Either the 1/4" (TRS) input or the XLR input on Channel A may be used.

### Bridged Mono Mode.

Bridged Mono Mode straps both amplifier channels together to make a very powerful, single-channel monaural amplifier. One channel "pushes" and the other "pulls" equally, doubling the power over that of either channel alone. Signal is applied to the Channel A input only. Both attenuators are used to control signal level; in addition, both must be adjusted to the same setting. Either the 1/4" (TRS) or XLR input may be used.

*NOTE: The channel B input connectors (XLR and/or TRS) may be used to "loop thru" the channel A signal when in parallel or bridged mono mode.*

*Use extreme caution when operating the amplifier in Bridged Mono Mode. Never ground either side of the speaker cable when the amplifier is in Bridged Mono Mode; both sides are "hot." If an output patch panel is used, all connections must be isolated from each other and from the panel. The recommended minimum nominal load impedance in the Bridged Mono Mode is 4 ohms, which is the equivalent to driving both channels separately at 2 ohms. Driving bridged loads of less than the recommended minimums will activate the IGM circuitry, resulting in a loss of power, and may also lead to a thermal protect condition.*

See figures on pages 12 & 13 showing output connection information.



**Connecting amplifier outputs to oscilloscopes or other test equipment while the amplifier is in bridged mode may damage both the amplifier and test equipment!**

**Stereo Mode Connections  
(5-Way Output Binding Posts)**

*NOTE: the Binding Post version of the CA18 features two pair of 5-Way Output Binding Posts.*

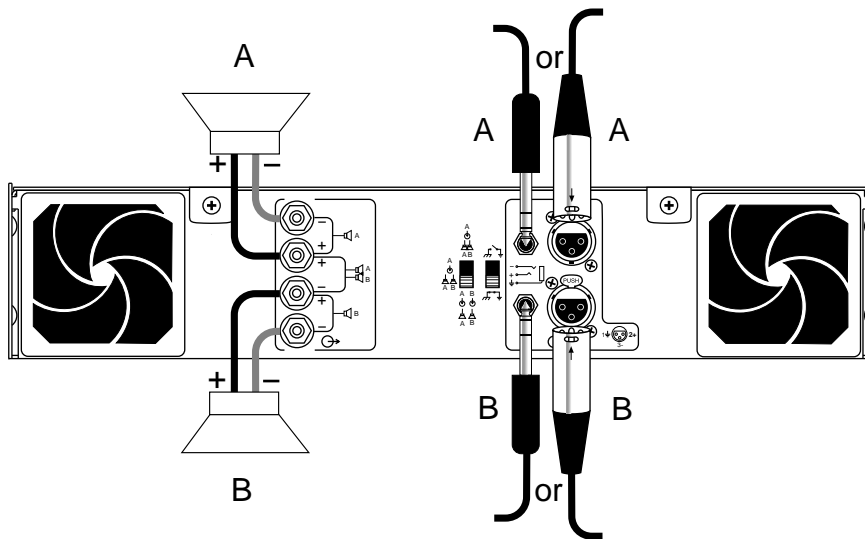

**Parallel Mode Connections  
(5-Way Output Binding Posts)**

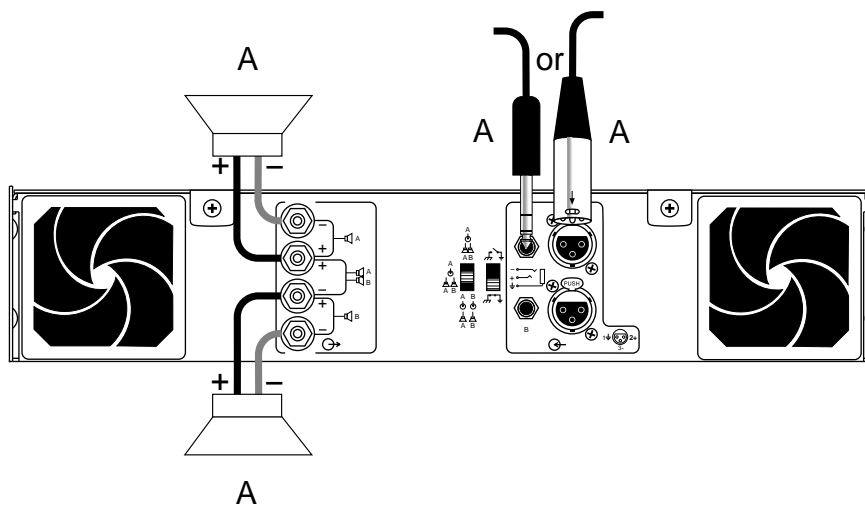

**Bridged Mono Mode Connections  
(5-Way Output Binding Posts)**

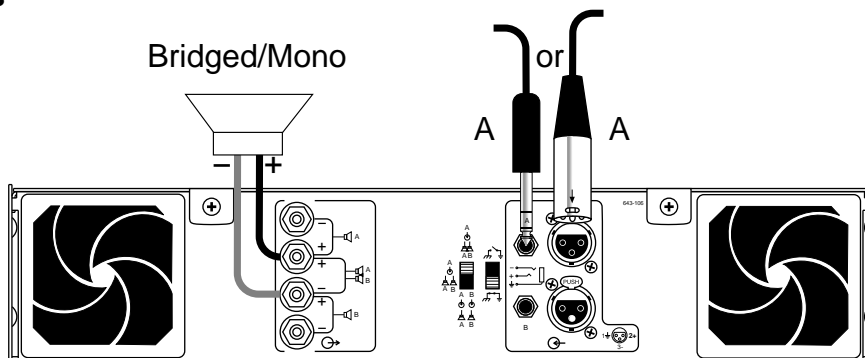

**Stereo Mode Connections  
(Speakon Output Connectors)**

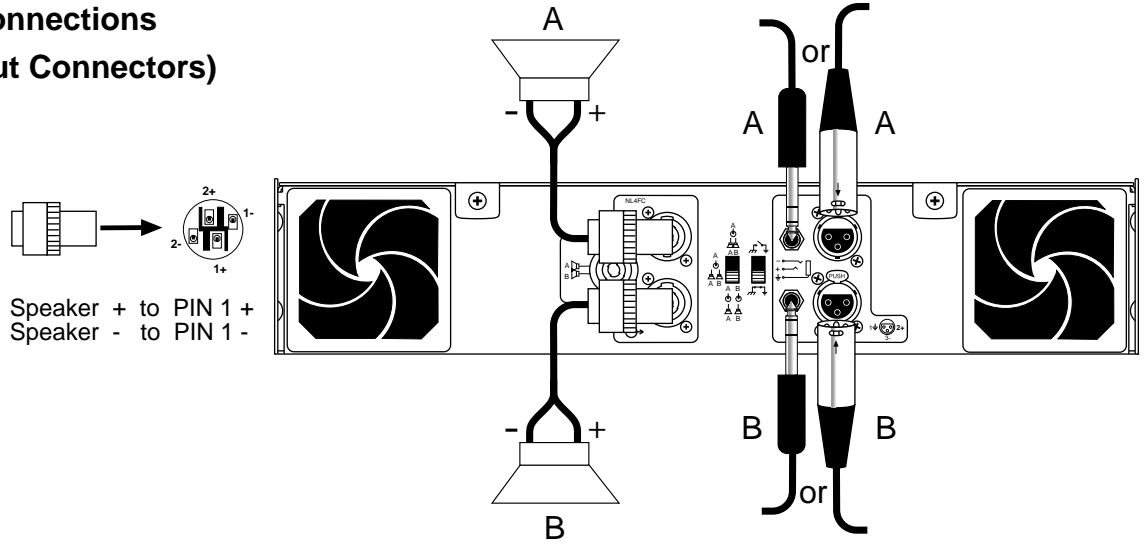

**Parallel Mode Connections  
(Speakon Output Connectors)**

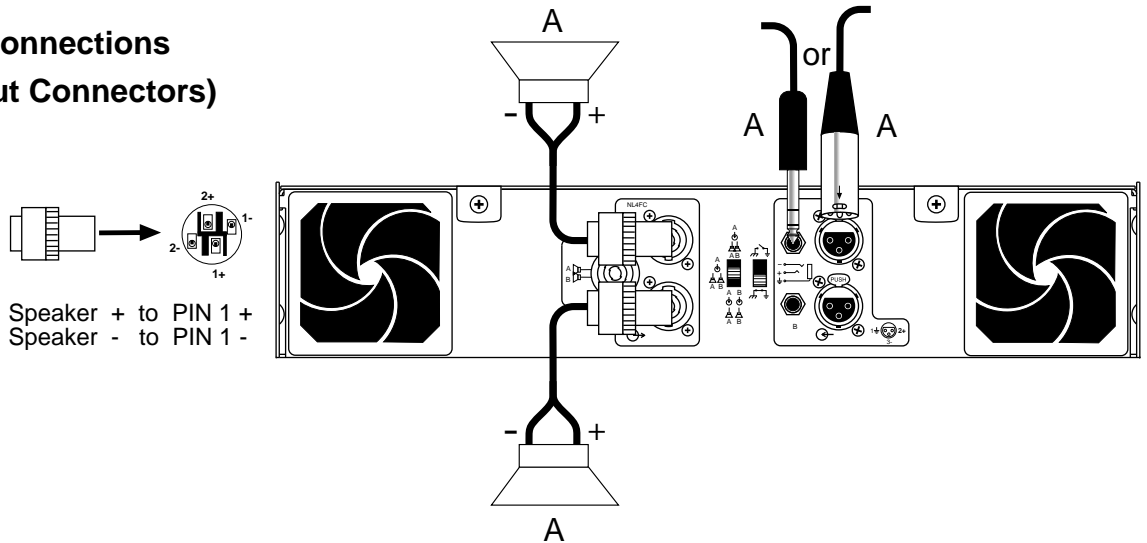

**Bridged Mono Mode Connections  
(Speakon Output Connectors)**

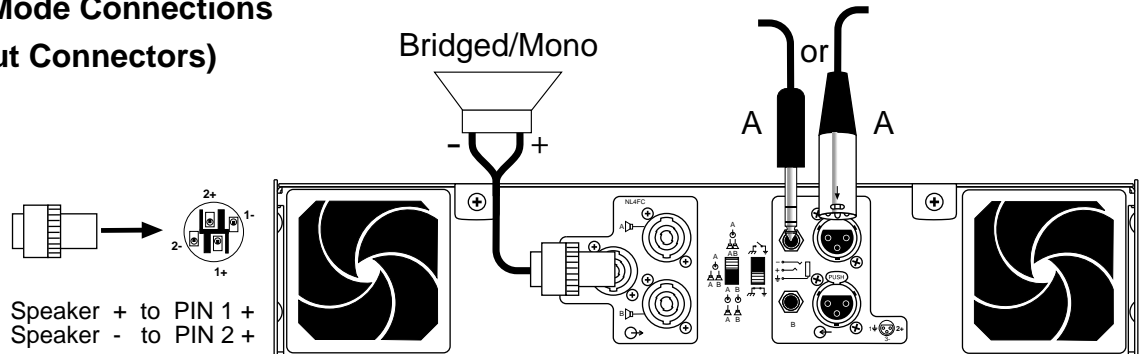



## TourClass® Protection

Every model in the CA Series incorporates TourClass protection features. Derived from Crest Audio's extensive experience with the world's largest sound rental companies, the TourClass group of circuits sets the industry standard for assured protection of internal amplifier circuits and all connected loads.

### **ACL (Active Clip Limiting).**

At the amplifier's full power limit, or clipping point, ACL will be activated. This is indicated by illumination of the Clip LED. The channel gain is automatically reduced, protecting the loudspeakers from potential damage from the high power, continuous square waves that would otherwise be produced. ACL may be activated by uncontrolled feedback, oscillations, improper equipment gain settings, or an equipment malfunction upstream from the amplifier. Only steady or excessive clipping (not normal program transients) will trigger ACL. The circuit is virtually transparent in operation and full signal bandwidth is maintained.

### **IGM Impedance Sensing.**

IGM (Instantaneous Gain Modulation) is an innovative circuit that allows the amplifier to operate safely into loads as low as 2 ohms. When the amplifier sees a load that overstresses the output stage, the IGM circuit adjusts the channel gain to a safe level. Like ACL, the IGM circuit is inaudible in normal use. In addition, if extreme and sustained low impedance is encountered, the amplifier's output relay will open.

### **AutoRamp Protection.**

Auto Ramp operates every time the amplifier is turned on or is reactivated after a protect condition is corrected. This exclusive Crest Audio feature gradually increases gain to the attenuator setting avoiding unnecessary stress on the loudspeakers.

### **Thermal Protection.**

Abnormally high heat sink temperatures will engage the Protect circuit for the overheating channel only. (An output relay disconnects the loudspeakers until nominal temperature range is restored.) During this time, the Protect LED will light. If the power transformer gets too hot, its thermal sensing circuit will disconnect both channel outputs. During this time, the Active LED will extinguish, the Protect and Clip LEDs will stay lit, and the cooling fan will continue running at low speed. Normal operation resumes once the transformer cools to a safe level.

### **Short Circuit.**

If an output is shorted (i.e., defective speakers or crossed speaker wires) the IGM and thermal circuits will automatically protect the amplifier. The IGM circuit senses the short circuit as an extremely stressful load condition and attenuates the signal, protecting the channel's output transistors from over-current stress. If the short circuit remains, the load will be disconnected by the thermal protection circuitry (output relay opens).

### **DC Voltage Protection.**

If an amplifier channel detects DC voltage at its output terminals, the output relay will immediately open to prevent loudspeaker damage. The Protect LEDs will light.

### **Subsonic Frequencies.**

Built-in high pass filtering provides subsonic frequency protection for each channel. In addition, a relay will open if excessive subsonic energy appears at the output.

## User Precautions

### Speaker Protection

All loudspeakers have electrical, thermal, and physical limits which must be observed to prevent damage or failure. Cone or compression drivers can be damaged (sometimes to the point of failure) from excessive power, low frequencies applied to high frequency drivers, severely clipped waveforms, and DC voltage. All CA Series amplifiers automatically protect speakers from DC voltages and subsonic signals. For more information, see the *TourClass Protection* section.

Mid- and high-frequency transducers—compression driver in particular—are highly susceptible to damage from overpowering, clipped waveforms, or frequencies below their rated passband. When using an electronic crossover, make absolutely certain that the low and mid bands are connected to the correct amplifiers and drivers—and not accidentally connected to those for a higher or lower frequency band.

The amplifier's clipping point is its maximum peak output power. At maximum peak output power, Crest Audio CA Series amplifiers will deliver more power than many speakers can safely handle. Be sure the peak power capability of the amplifier is not excessive for your speaker system. To ensure that the speakers never receive excessive power, and to prevent amplifier clipping, use a properly adjusted external limiter (or a compressor with a ratio of 10:1 or higher) to control power output. Use one compressor/limiter for each frequency band in systems with active electronic crossovers.

The ACL clip limiting circuit will automatically limit the duration of squared-off, continuous waveforms applied to the speakers. The amplifier will, however, allow normal musical transient bursts to pass. Of course, when the amplifier does clip, it is operating at its maximum output power. Note that some speaker systems are packaged with proprietary “processors” that have power limiting circuits and therefore should not require additional limiting.

Do not drive any low-frequency speaker enclosure with frequencies lower than its own tuned frequency; the reduced acoustical damping could cause a ported speaker to “bottom out” even at moderate power. Consult the speaker system specifications to determine its frequency limits, and employ a roll-off filter if necessary.

### Recommended Speaker Cabling

The wire gauge charts will assist you in determining the optimum copper wire gauge for your speaker cables. Remember that the speaker cable resistance robs amplifier power in two ways: through power lost directly to resistance (often referred to as  $I^2R$  loss), and through increased total load resistance, which decreases the amount of power available from the amplifier. The charts (Appendix C) give cable length figures in feet/AWG wire gauges and in metric values.



## **Maintenance**

A CA Series amplifier requires no routine maintenance other than occasional cleaning or replacement of the fan intake filters on the rear of the amplifier. (This operation does not require any tools). Filters must be kept clear and clean to ensure proper ventilation through the unit. If the amplifier is used in an extremely dusty or smoky environment, the filter should be cleaned or changed frequently and the unit should be periodically “blown free” (using compressed air) of any foreign matter that may penetrated through the filter.

Users will not need to make any internal adjustments to the amplifier during its lifetime. There are no user-serviceable parts or adjustments that require opening the power amplifier. Cover removal exposes the risk of shock, so refer all servicing to qualified service technicians authorized by Crest Audio.

## **User Responsibility**

Your CA Series amplifier is very powerful and can be potentially dangerous to loudspeakers and operators alike. It is your responsibility to read the section titled “Important Precautions” and make sure that the amplifier is installed, wired, and operated properly as instructed in this manual. Many loudspeakers can be easily damaged or destroyed by overpowering, especially with the high power available from a bridged amplifier. Read the section on Speaker Protection and always be aware of the speaker’s continuous and peak power capabilities. Crest Audio is not responsible for damage to loudspeakers for any reason.

## **Service and Repair**

In the unlikely event that your amplifier develops a problem, it must be returned to an authorized distributor, service center or shipped directly to our factory. To obtain service, contact your nearest Crest Audio Service Center, Distributor, Dealer, or any of the worldwide Crest Audio offices. For contact information, reach Crest Audio Inc. Customer Service directly at: TEL. 201.909.8700 (USA) Fax. 201.909.8744 (USA). Because of the complexity of the design and the risk of electrical shock, all repairs should be attempted only by qualified technical personnel. If the unit needs to be shipped back to the factory, it must be sent in its original carton. If improperly packed, your amplifier may be damaged.

---

**For those with Internet access, please visit the Crest Audio website at: <http://www.crestaudio.com>**





# ***Appendices***



# Appendix A - Amplifier Specifications



	CA 2	CA 4	CA 6	CA 9	CA 12	CA 18
<b>1kHz, 0.01% THD+N</b>						
8Ω Stereo Power	160W	250W	400W	600W	700W	1000W (.03% THD+N)
4Ω Stereo Power	250W	435W	600W	900W	1200W	1800W (.03% THD+N)
2Ω Stereo Power	N/A	500W	750W	1000W	1400W	2500W (.03% THD+N)
8Ω Bridged Mono Power	500W	830W	1200W	1800W	2400W	3600W (.03% THD+N)
4Ω Bridged Mono Power	N/A	1000W	1500W	2000W	2800W	5000W (.03% THD+N)
<b>20Hz-20kHz, 0.1% THD+N</b>						
8Ω Stereo Power	150W	245W	350W	550W	650W	950W
4Ω Stereo Power	200W	400W	500W	800W	1100W	1700W
2Ω Stereo Power	N/A	450W	600W	900W	1100W	2400W
8Ω Bridged Mono Power	450W	800W	1000W	1600W	2200W	3400W
4Ω Bridged Mono Power	N/A	900W	1200W	1800W	2200W	4800W
Max RMS Output Voltage (each channel)	44V	58V	73V	82V	90V	99V
Max Peak Output Voltage	62V	82V	103V	116V	126V	140V
Frequency Response (+0/-0.3dB, 1W/8Ω)	20Hz-20kHz, -3dB@135kHz	20Hz-20kHz, -3dB@135kHz	20Hz-20kHz, -3dB@135kHz	20Hz-20kHz, -3dB@135kHz	20Hz-20kHz, -3dB@135kHz	20Hz-20kHz, -3dB@150kHz
Power Bandwidth (rated power at 4Ω, 1%THD+N)	20Hz-20kHz, -9dB(+,15dB)	20Hz-20kHz, -9dB(+,5dB)	20Hz-20kHz, -1.1dB(+0dB)	20Hz-20kHz, -.84dB(+0dB)	20Hz-20kHz, -.23dB(+.85dB)	20Hz-20kHz, -.2dB(+.2dB)
<b>TourClass Protection</b> ACL, IGM, AutoRamp, short circuit, DC voltage, turn-on/off transient, current inrush, sub/ultrasonic input						
THD+N (rated power, 4Ω/1kHz)	<0.01%	<0.01%	<0.01%	<0.01%	<0.01%	<0.03%
SMPTE IMD (rated power, 8Ω, 60 Hz & 7kHz)	<0.01%	<0.01%	<0.01%	<0.01%	<0.01%	<0.01%
Damping Factor (10-400Hz at 8Ω)	368:1	550:1	400:1	700:1	800:1	800:1
Input CMRR (1kHz)	> -60 dB	> -60 dB	> -60 dB	> -60 dB	> -60 dB	> -70dB
Standard Input Sensitivity (rated power at 8Ω) ‡	0.775V	0.775V	0.775V	0.775V	0.775V	0.775V
Standard Voltage Gain (rated power @ 8Ω) ‡	X45	X61	X68	X86.5	X97.5	X115
Input Impedance (balanced/unbalanced)	>20kΩ/>10kΩ	>20kΩ/>10kΩ	>20kΩ/>10kΩ	>20kΩ/>10kΩ	>20kΩ/>10kΩ	>20kΩ/>10kΩ
Hum and Noise ("A" weighted, full power at 4Ω)	-105dB	-105dB	-105dB	-105dB	-105dB	-115dB
Crosstalk ("A" weighted, full power at 4Ω)	> -60dB	> -60dB	> -60dB	> -60dB	> -60dB	> -80dB
Class	AB	AB	H	H	H	H
Input Connectors (per channel)	Female XLR (pin 2+, configurable for pin 3+), TRS (tip+)					
Output Connectors (per channel)	5-way binding posts (2 pair on CA18) or Speakon connectors (market dependent)					
Filter Storage	20,000 µF	27,200 µF	68,000 µF	80,000 µF	140,000 µF	144,000 µF
Power Supply (factory configured)	100V-240V, 50-60Hz	100V-240V, 50-60Hz	100V-240V, 50-60Hz	100V-240V, 50-60Hz	100V-240V, 50-60Hz	100V-240V, 50-60Hz
Idle Current Draw (120V)	1.2A	1.4A	1.6A	2.0A	2.8A	3.0A
1/8 Power Curr. Draw (typical music cond., 120V/4Ω)	3.25A	6.8A	6.0A	8.6A	10.5A	12.0A
1/3 Power Curr. Draw (cont. music cond., 120V/4Ω)	5.5A	10.0A	13.0A	16.0A	23.0A	25.0A
Max Curr. Draw (continuous music cond., 120V/4Ω)	9.0A	15.0A	18.0A	21.0A	30.0A	36.0A
Thermal Emissions (1/8 Power, 4Ω)	1119 BTU/hr	2030 BTU/hr	2630 BTU/hr	3250 BTU/hr	4750 BTU/hr	7125 BTU/hr
Thermal Emissions (1/3 Power, 4Ω)	1607 BTU/hr	2726 BTU/hr	3713 BTU/hr	4341 BTU/hr	6300 BTU/hr	9450 BTU/hr
Cooling	Two rear panel variable speed DC fans, filters detachable without tools					
Controls	Front panel: 2 attenuators, magnetic circuit breaker/power switch; Rear panel: signal ground lift & mode switches; CA18: XLR polarity & input sens./voltage gain switches)					
LED Indicators (per channel)	Clip/Limit, Signal, Temp/DC, Active					
Construction	Steel chassis, 16 gauge. Double thickness in rack ear areas.					
Dimensions (Height x Width x Depth to rear rack ears)	3.5" x 19" x 18"	3.5" x 19" x 18"	3.5" x 19" x 18"	3.5" x 19" x 18"	5.25" x 19" x 18"	5.25" x 19" x 18"
	89 x 483 x 457mm	89 x 483 x 457mm	89 x 483 x 457mm	89 x 483 x 457mm	133 x 483 x 457mm	133 x 483 x 457mm
Gross Weight	38 lbs. (17.25 kg)	46 lbs. (20.88 kg)	49 lbs. (22.24 kg)	52lbs. (23.60 kg)	72 lbs. (32.68 kg.)	82 lbs. (37.23 kg.)
Net Weight	33 lbs. (14.98 kg)	41 lbs. (18.61 kg)	44 lbs. (19.97 kg)	47 lbs. (21.33 kg)	67 lbs. (30.42 kg)	77 lbs. (34.96 kg.)
Warranty	5 years*	5 years*	5 years*	5 years*	5 years*	5 years*

† For full power at 4 Ohms. ‡ See table below for optional settings. \* 3-Year Warranty with 2 additional years if Registration Card is sent to Crest Audio. (USA, Canada, United Kingdom and many other countries).  
Crest Audio reserves the right to make changes or improvements in manufacturing or design which may affect specification. ©1997 Crest Audio Inc. 10/13/97

	CA2		CA4		CA6		CA9		CA12		CA18	
Factory Standard	Gain	Sens	Gain	Sens	Gain	Sens	Gain	Sens	Gain	Sens	Gain	Sens
Option 1	X45	.775V	X61	.775V	X68	.775V	X86.5	.775V	X97.5	.775V	X115	.775V
Option 2	X40	.866V	X40	1.12V	X40	1.32V	X40	1.66V	X40	1.87V	X40	2.24V
	X20	1.73V	X20	2.24V	X20	2.65V	X20	3.32V	X20	3.74V	X20	4.47V

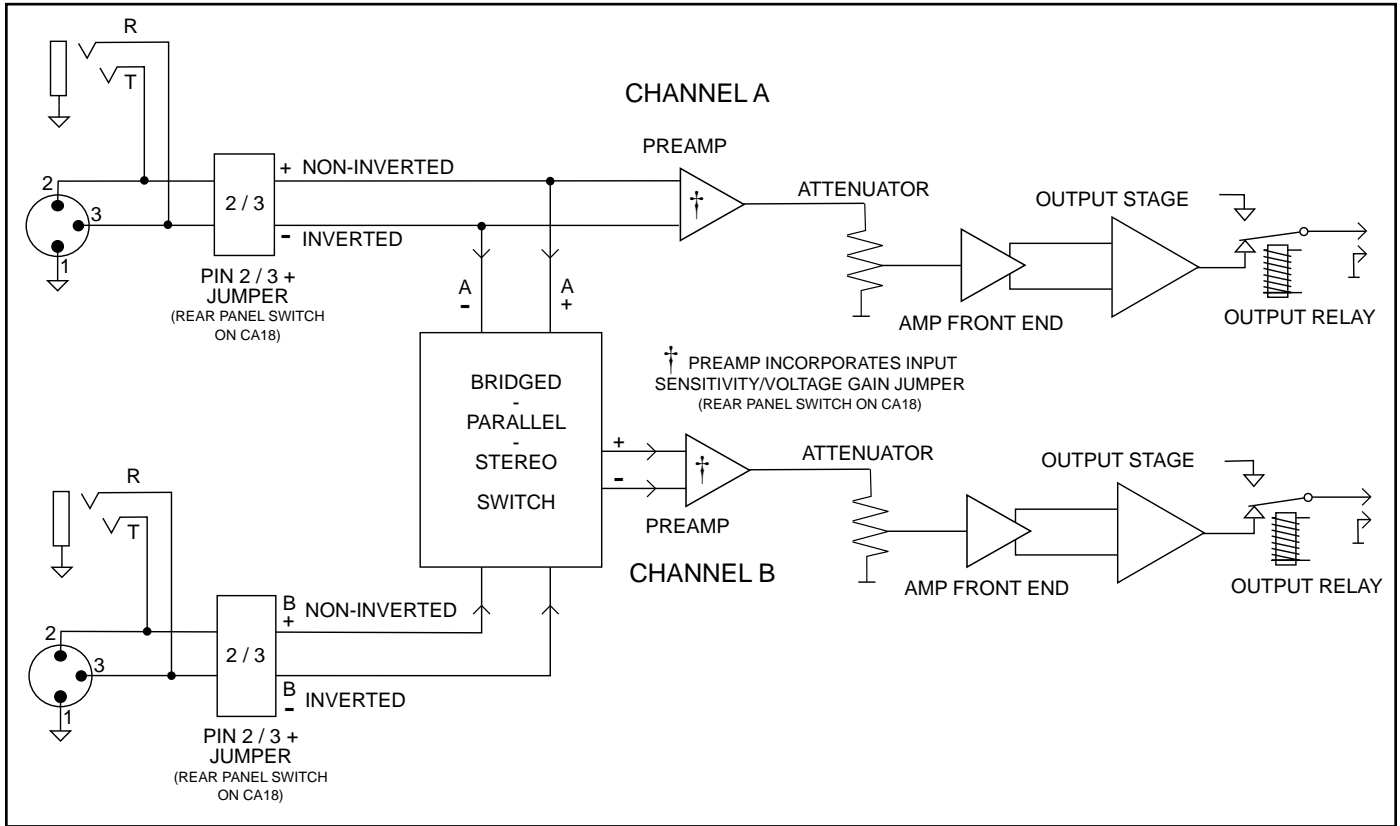



## Appendix C - Wire Gauge Chart (Metric)



Stranded Cable Lgth. (m)	Wire Gauge (mm <sup>2</sup> )	Power Loss (8 ohm load)	Power Loss (4 ohm load)	Power Loss (2 ohm load)
2	0.3	2.9%	5.6%	10.8%
	0.5	1.74	3.4	6.7
	0.75	1.16	2.3	4.5
	1.5	0.58	1.16	2.3
	2.5	0.35	0.70	1.39
	4	0.22	0.44	0.87
5	0.5	4.3%	8.2%	15.5%
	0.75	2.9	5.6	10.8
	1.5	1.45	2.9	5.6
	2.5	0.87	1.74	3.4
	4	0.55	1.09	2.2
	6	0.37	0.73	1.45
10	0.5	8.24%	15.5%	28%
	0.75	5.6	10.8	19.9
	1.5	2.9	5.6	10.8
	2.5	1.74	2.9	6.7
	4	1.09	1.74	4.3
	6	0.73	1.09	2.9
30	0.75	15.5%	0.73%	45%
	1.5	8.2	15.5	28
	2.5	5.1	9.8	18.2
	4	3.2	6.3	12.0
	6	2.2	4.3	8.2
	10	1.31	2.6	5.1



## Appendix C - Wire Gauge Chart (Imperial)



















Stranded Cable Lgth. (ft.)	Wire Gauge (AWG)	Power Loss (8 ohm load)	Power Loss (4 ohm load)	Power Loss (2 ohm load)
5	18	0.81%	1.61%	3.2%
	16	0.51	1.02	2.0
	14	0.32	0.64	1.28
	12	0.20	0.40	0.80
	10	0.128	0.25	0.51
10	18	1.61%	3.2%	6.2%
	16	1.02	2.0	4.0
	14	0.64	1.28	2.5
	12	0.40	0.80	1.60
	10	0.25	0.51	1.01
40	18	6.2%	11.9%	22%
	16	4.0	7.7	14.6
	14	2.5	5.0	9.6
	12	1.60	3.2	6.2
	10	1.01	2.0	4.0
	8	0.60	1.20	2.4
80	18	11.9%	22%	37%
	16	7.7	14.6	26
	14	5.0	9.6	17.8
	12	3.2	6.2	11.8
	10	2.0	4.0	7.7
	8	1.20	2.4	4.7



## Appendix D Rear Panel Symbols - Legend

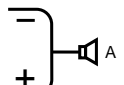
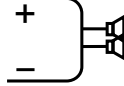

-  Input Connection Section
-  XLR Connector Polarity Indicator
-  TRS Connector Polarity Indicator
-  Mode Selection Switch - Bridged Mono Position
-  Mode Selection Switch - Parallel Position
-  Mode Selection Switch - Stereo Position
-  Chassis Ground Lift Switch - Ground Lifted Position
-  Chassis Ground Lift Switch - Grounded Position
-  Gain Select Switch (CA18)  
GAIN  
∅ 40x 20x  
dBu
-  XLR pin hot (+) select switch (CA18)  
XLR Pin +  
2 3
-  Output Connection Section
-  Speakon Output Connector - Channel A Stereo/Parallel
-  Speakon Output Connector - Channel B Stereo/Parallel
-  Speakon Output Connector - Bridged Mono
-  5-Way Binding Post Output Connection - Channel A Stereo/Parallel
-  5-Way Binding Post Output Connection - Bridged Mono
-  5-Way Binding Post Output Connection - Channel B Stereo/Parallel

The CA18 rear panel features external switches for the following:

**XLR Pin+ Switch:** This switch configures XLR input connection polarity. Either pin 2 or pin 3 may be selected as the “hot” (+) pin. Amplifiers are shipped pin 2 “hot” (+) from the factory.

**Gain Switch:** This switch permits the amplifier to be configured for the standard input sensitivity (.775V for rated power @ 8Ω), or for optional voltage gains of X40 or X20. Refer to the specifications for input sensitivity values at optional voltage gains of X40 and X20.

*NOTE: on the 5-way Output Binding Post version of the CA18, two pairs of 5-way binding posts are provided for each channel, so that paralleling of speakers is possible.*



**ALWAYS power down the amplifier before changing settings with either the XLR Pin+ switch or the Gain switch!**

### CA18 Binding Post Version - Rear View

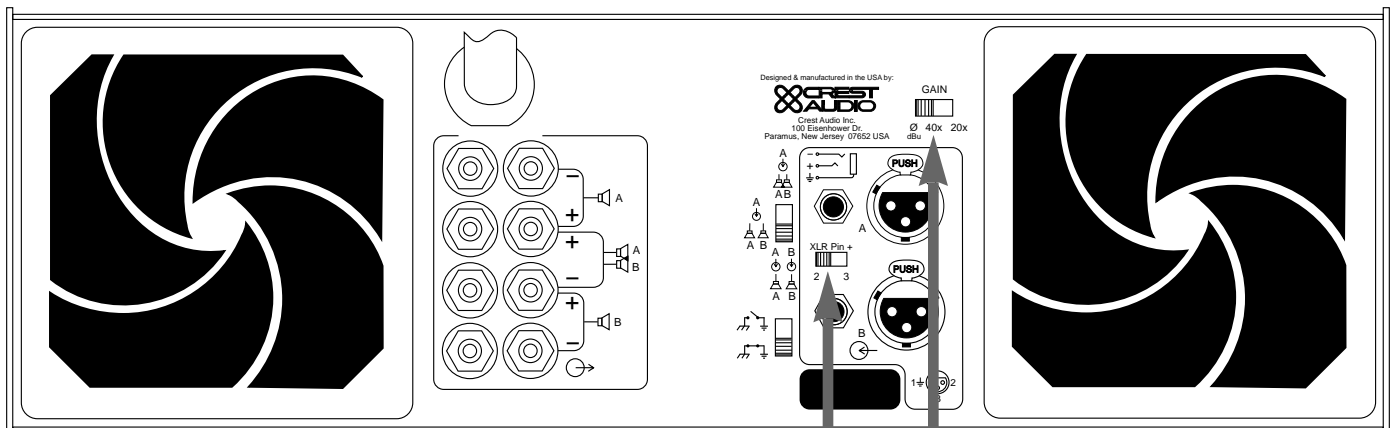

**XLR Pin (+) Switch      Gain Switch**

### CA18 Speakon Version - Rear View

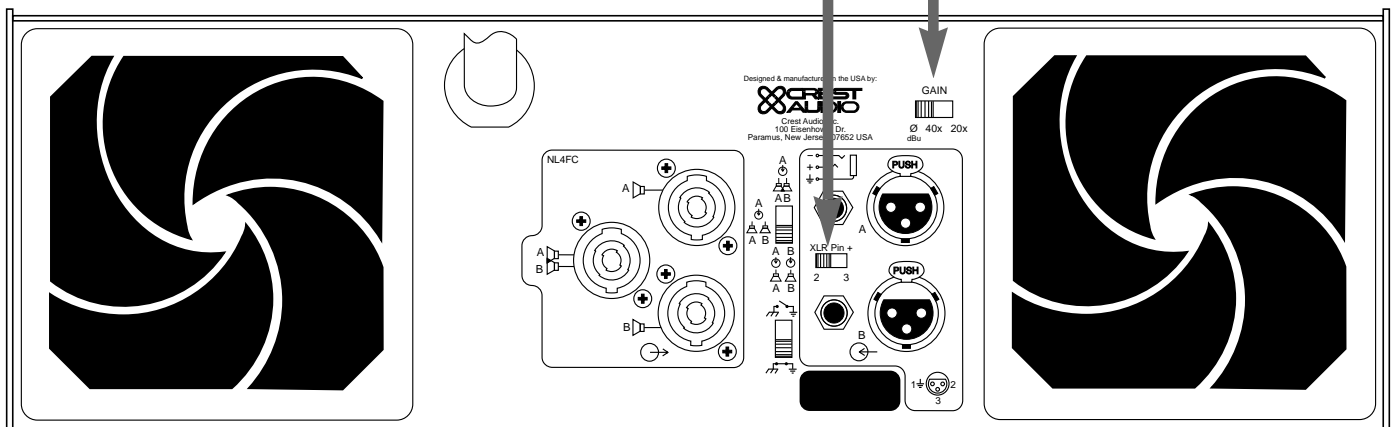



**Crest Audio Inc.**  
100 Eisenhower Dr., Paramus NJ 07652 USA  
TEL: 201.909.8700 FAX: 201.909.8744  
<http://www.crestaudio.com>

Printed in USA

---

**Choice of touring professionals.**



\*B5000013\*