



# CENTURY SERIES

---

# GTx

## OWNER'S MANUAL



Congratulations on your purchase of a Century Series console. All of us at Crest Audio in Paramus, New Jersey, USA, support your decision, knowing your console contains the finest combination of design and manufacture in the industry.

While your new Century Series console is one of the most feature-packed available, great effort has been put into making it simple to operate.

This manual explains the functions of your new console, how they operate and how they relate to each other. If properly cared for, your new console will provide you with trouble-free, sonically accurate mixing clear into the next Century and beyond.

Please keep the following contact information on hand:

Crest Audio Customer Service Dept.  
100 Eisenhower Drive  
Paramus NJ 07652 USA  
TEL 201.909.8700 FAX 201.909.8744  
<http://www.crestaudio.com>

**Crest Audio Inc.**  
100 Eisenhower Dr., Paramus NJ 07652 USA  
TEL: 201.909.8700 FAX: 201.909.8744  
<http://www.crestaudio.com>

Printed in USA

# TABLE OF CONTENTS

---

GTx	Feature Overview	2
	A brief description of the Vx design, features and functions.	
GTx	Wiring Conventions	3
	Contains diagrams indicating how connectors for Crest consoles are wired.	
GTx	Rear Panel Connections	4
	Details the rear panel input and output connections to be made to the GTx console.	
GTx	Power Supply	6
	A brief description of the rack-mountable Century Series consoles power supply.	
GTx	Power Connections	7
	A brief description of Crest console power connections.	
GTx	Console Cooling	7
	A brief description of the dual-fan cooling setup.	
GTx	System Connections	8
	Contains diagrams illustrating conventional system connections.	
GTx	Input Module	10
	Profiles the GTx input module. The module is illustrated and described.	
GTx	Stereo Input Module	12
	Profiles the GTx stereo input module. The module is illustrated and described.	
GTx	Group Modules	15
	Profiles the GTx group module. The module is illustrated and described.	
GTx	Matrix Module	17
	Profiles the GTx matrix module. The module is illustrated and described.	
GTx	Master Section	19
	Profiles the GTx master section. Modules are illustrated and described.	
GTx	Meter Bridge	21
	This section profiles the GTx meter bridge.	
GTx	Technical Information	Appendix A
	Includes dimensions, specifications, console access details, user options, console block diagram, and rear panel layout.	
GTx	Glossary	Appendix B
	The specific details of console operation are described here.	
GTx	Schematics	Appendix C
	Lists available schematics for all GTx Console Modules & Power Supply	

## Feature Overview

- Extensive Meter bridge provides signal level metering of LEFT, RIGHT, CENTER/MONO, SOLO LEFT, SOLO RIGHT, and 8 SUBGROUPS. The LEFT, RIGHT, CENTER/MONO and SOLO meters are of a larger size and are centered on the meter bridge. For 64 and 52 positions frames sizes only, metering is also provided for the 8 AUX SENDS. All level meters are of the mechanical moving coil type, are referenced to +4 dBu, and are illuminated by long-life LED's.
- Variable Hi-Pass filter on input channels allows for precise control over a signal's unwanted low frequency content.
- Channel inserts are implemented using separate 1/4" TRS jacks for send and return. An insert switch with indicator LED allows A/B comparisons and signal processor bypass.
- Switchable Q on Hi Mid and Lo Mid EQ bands adds more flexibility to an EQ circuit that already offers four sweepable bands and selectable peak/shelving on the Hi and Lo bands.
- Dual concentric send controls for auxes 1&2, and 3&4, in addition to sends 5-8 allow each input to send onto any or all of the 8 aux buses, while occupying a minimal amount of module space.
- AUX pre/post switches. The first four aux sends can be selected to be pre or post by the Aux 1-4 pre/post switch. In addition, Aux pairs 5&6 and 7&8 each have designated pre/post switches. The Pre source is internally selectable to Pre-EQ or Pre-Fader.
- Discreet bus assignments and L-C-R (Left-Center-Right) panning. Input channels and Effects Returns incorporate an uncompromised bus assignment section. Features include true L-C-R panning, standard panning, clean mono bus, discrete bus assigns, and panable stereo bus assigns.
- Each input channel features a five-segment LED array, including a signal present LED, three signal level LEDs and a peak indicator.
- SSM/PMI high-quality preamplifiers on balanced microphone/line inputs for uncompromised audio quality and reliability. All IC's within the audio path are socket mounted for easy upgrade or service.
- 48 Volt switchable phantom power on all microphone inputs.
- Optional transformers available on all microphone inputs and on Group, Left/Right, Mono, Aux, and Matrix outputs.
- Mono/Stereo PFL (Pre-Fader-Listen) and AFL (After-Fader-Listen) system. When a stereo module is used, the signal is monitored in stereo while mono modules are monitored in mono. Selected outputs may be monitored in mono or as stereo pairs.
- Standard frame sizes include 44, 52, and 64 positions. The Master section occupies four positions and Groups occupy eight positions.
- Any frame size may be ordered short loaded for later expansion.
- Direct access to Group Mix buses allows expander mixers to be easily patched into the console.
- Full facility effects return section includes Gain Control to handle a wide range of input levels, High and Low frequency EQ, Aux Sends, expanded bus assignment section, and level, pan, PFL and Mute controls.
- Mute system on input channels is designed to mute both pre- and post-fader signals including those Aux sends used as monitors. When muted, PFL circuitry, Peak, Level, and Dynamic Signal Present LED indicators remain fully operational.
- Twin power supply capability with automatic changeover backup for uncompromised reliability. Second power supply optional.
- Optional Matrix modules available, useful for the creation of independent mixes using the main outputs and External Input as signal sources.
- Optional Stereo Input modules available, useful for remote feeds, effects inputs, and other mic or line level signals requiring stereo handling.
- Comprehensive Talkback section allows access to all primary console outputs. Additional access provided to an external location such as an on-stage monitor mixer system. External signals can also be assigned into the talkback system including Oscillator and Pink Noise source inputs.
- Left/Right summing switches to Aux 1-2 and Aux 3-4 allow for simple setups of mixes by allowing Left/Right signals to be blended with auxiliary mixes when used in recording applications. In contracting applications, this feature allows these Aux outputs to act as additional distribution amplifiers for the Left/Right signals.

### Wiring Conventions

Crest consoles are wired with connectors that are used throughout the professional audio industry. Wiring is as follows:

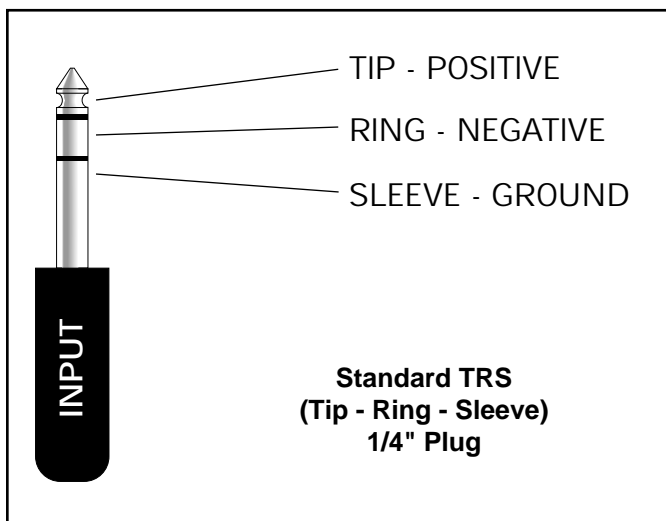
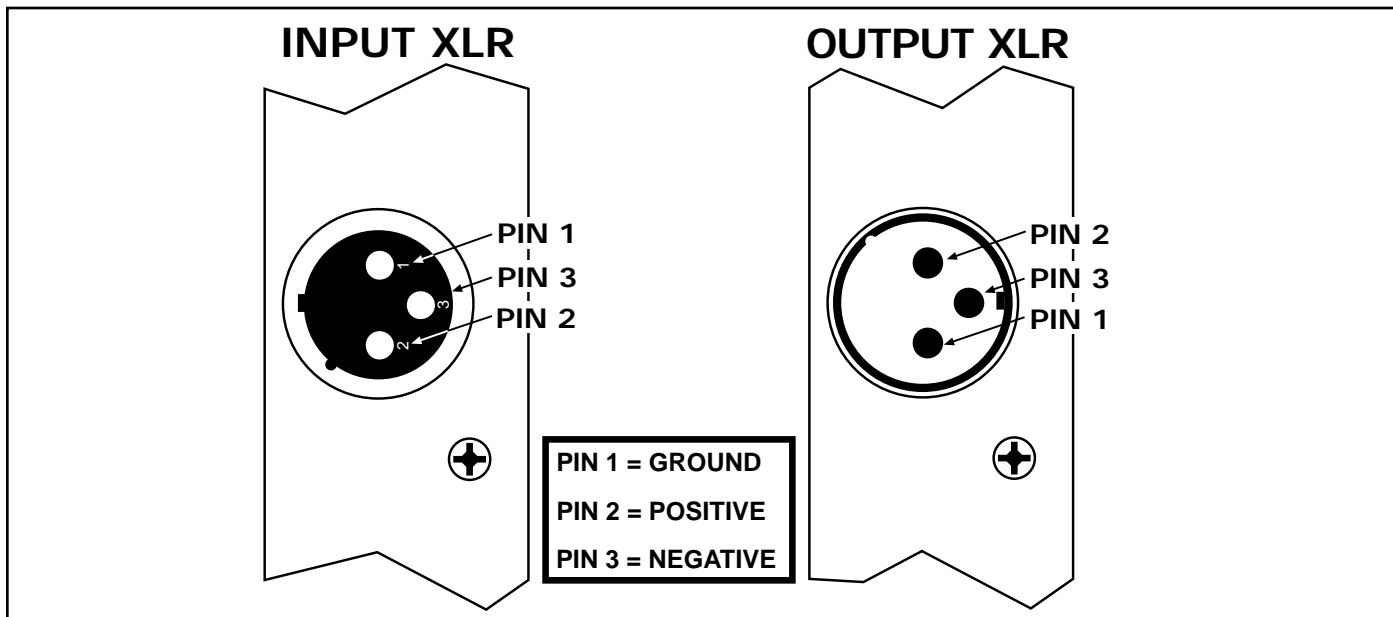

Input / Output

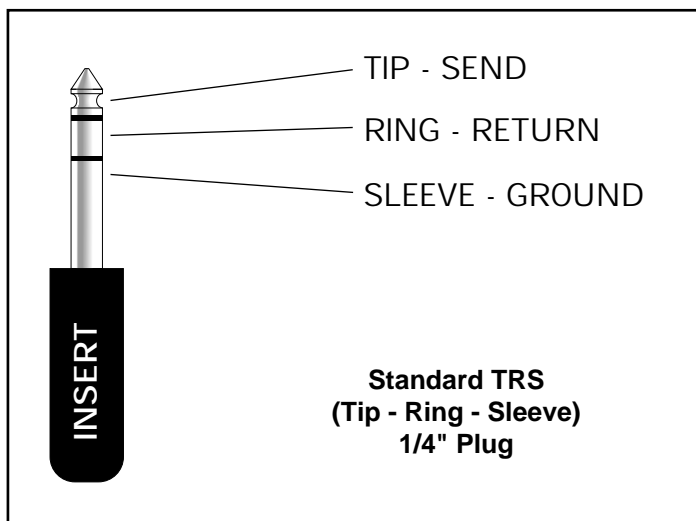

Insert

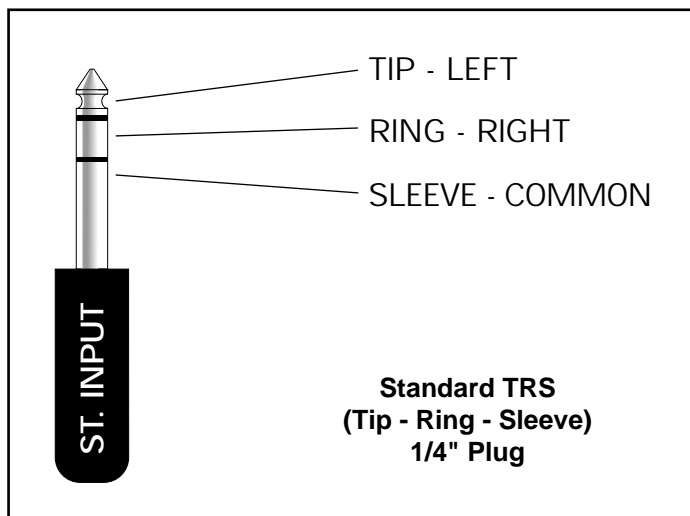

Stereo Program In

## REAR PANEL CONNECTIONS

### Input Module Connections

#### Direct Out

This 1/4-inch balanced TRS jack delivers the direct output signal (post fader & post mute) from the associated input channel.

#### Insert Send

This 1/4-inch jack is used for sending a post-input preamp, post Hi Pass Filter, pre-EQ signal to an outboard processor. The signal at this jack is unbalanced and always active regardless of the Insert Switch setting.

#### Bal Insert Return

This 1/4-inch balanced TRS jack receives its signal from an outboard processor. It can also be used to bring a signal into the channel, bypassing the input preamp and gain circuit. The return input is balanced and must be enabled by depressing the channel Insert switch.

#### Bal Line In

This 1/4-inch balanced TRS jack accepts a balanced or unbalanced line level input, and delivers it into the associated input channel.

#### Mic In

This XLR connector accepts balanced microphone inputs for the associated input channel.

### Stereo Input Module Connections

#### Insert L / Insert R

These 'combined send & return' TRS jacks are used to insert effects or signal processing into the Left and Right channels of the Stereo Input module. It can also be used to bring a signal into the channel, bypassing the input preamp and gain circuit. The return input is enabled by depressing the channel Insert switch.

#### Bal Line In L / Bal Line In R

These 1/4-inch balanced TRS jacks accept balanced or unbalanced line level inputs, and deliver them into the associated (Left or Right) input channels of the Stereo Input.

#### Bal Mic In L / Bal Mic in R

These XLR connectors accept balanced microphone inputs, and deliver them into the associated (Left or Right) input channels of the Stereo Input.

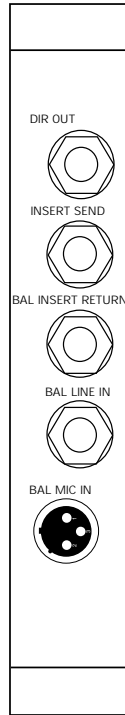

**GTx  
Input  
Module**

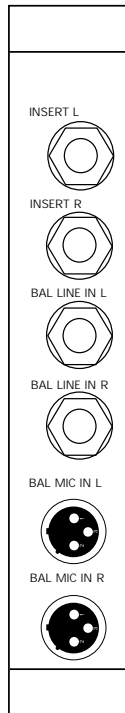

**GTx  
Stereo  
Input  
Module**

### Group Module Connections

#### Group Out

This XLR connector carries the post-fader output signal from the associated group module.

#### Group Ins Send

This 1/4-inch TRS jack allows for the group signal to be sent to an effect or signal processor.

#### Bal Ins Return

This 1/4-inch balanced TRS jack allows for the return of the effected and/or processed group signal back into the associated group.

#### EFX Return

These two connectors allow for effect signals to be brought back into the board. The 1/4-inch balanced TRS jack accepts a balanced or unbalanced signal at -10 dB level and delivers the signal to the EFX return section. The female XLR connector accepts a balanced signal at +4dB level and delivers the signal to the EFX return section of the group. Signals from both jacks are mixed together.

#### Bus In

This XLR connector accepts a balanced signal at +4dB level, and then sums it with all the other signals assigned to the associated groups.

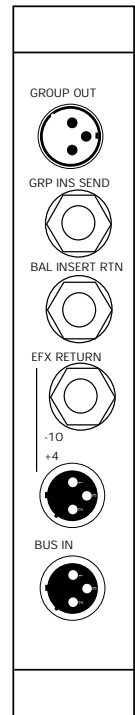

**GTx  
Group  
Module**

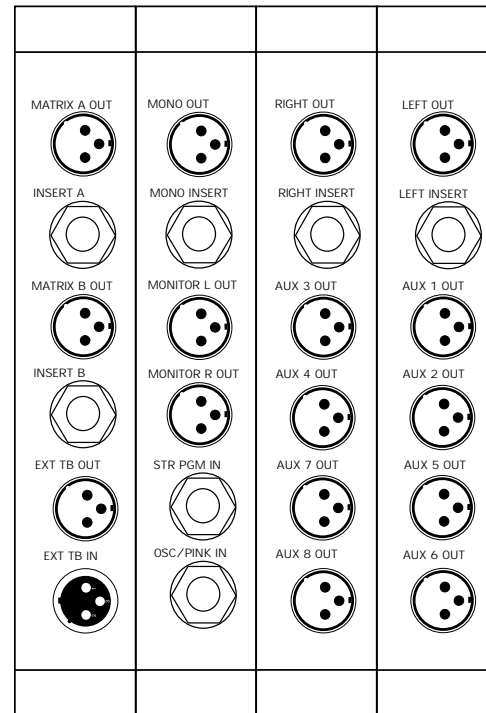

**GTx  
Master  
Modules**

## Master Module Connections

### Matrix Out (A&B)

These two XLR connectors deliver a balanced signal from the associated matrix sends.

### Mono Out

This XLR connector delivers a balanced post-fader signal containing all signals assigned to the Mono clean bus.

### Right Out

This XLR connector delivers a balanced post-fader signal containing all signals assigned to the right output.

### Left Out

This XLR connector delivers a balanced post-fader signal containing all signals assigned to the left output.

### Matrix Insert (A&B)

This 'combined send & return' TRS jack allows for the insertion of an effect or signal processor into the audio path of the associated matrix.

### Mono Insert

This 'combined send & return' TRS jack allows for the insertion of a signal processor into the path of the mono sub-mix.

### Right Insert

This 'combined send & return' TRS jack allows for the insertion of an effect or signal processor into the audio path of the right sub-mix.

### Left Insert

This 'combined send & return' TRS jack allows for the insertion of an effect or signal processor into the audio path of the left sub-mix.

### Monitor Out (R&L)

These two XLR connectors provide a balanced signal for the left and right local monitor.

### Aux 1-8 Out

These eight XLR connections provide the balanced output signals from their respective auxiliary buses.

### Ext. Talkback Out

This XLR connector provides an external balanced signal from the selected talkback source.

### Ext. Talkback In

This XLR connector accepts a balanced signal which is assignable to any of the locations in the talkback system.

## Stereo Program In

This 1/4-inch jack accepts an unbalanced stereo line level signal. Polarity is as follows: Tip=Left, Ring=R, Sleeve=Common.

## Oscillator / Pink Noise In

This 1/4-inch TRS connector accepts a balanced or unbalanced signal from an oscillator or pink noise generator. This signal is assignable via the talkback assignment switches. Plugging into this jack disables the internal 1kHz oscillator.

## Matrix Module Connections

### Matrix Out

This XLR connector delivers a balanced signal from the matrix module.

### Matrix Insert

This 'combined send & return' TRS jack allows for the insertion of an effect or signal processor into the audio path of the matrix output.

### Aux In 1

This XLR connector accepts a balanced signal at +4dB level, which can be summed with all the other signals in the matrix output.

### Aux In 2

This XLR connector accepts a balanced signal at +4dB level, which can be summed with all the other signals in the matrix output.

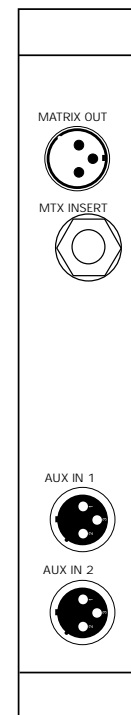

**Matrix  
Module**

# Century Series Console Power Supply

Century Series consoles use a separate rack-mountable power supply which provides the specific voltages used by each console. Crest Consoles' Century Series makes use of two different power supplies. All frame sizes (44, 52, 64) of the GTx console use the Model XCVA06 Power Supply.

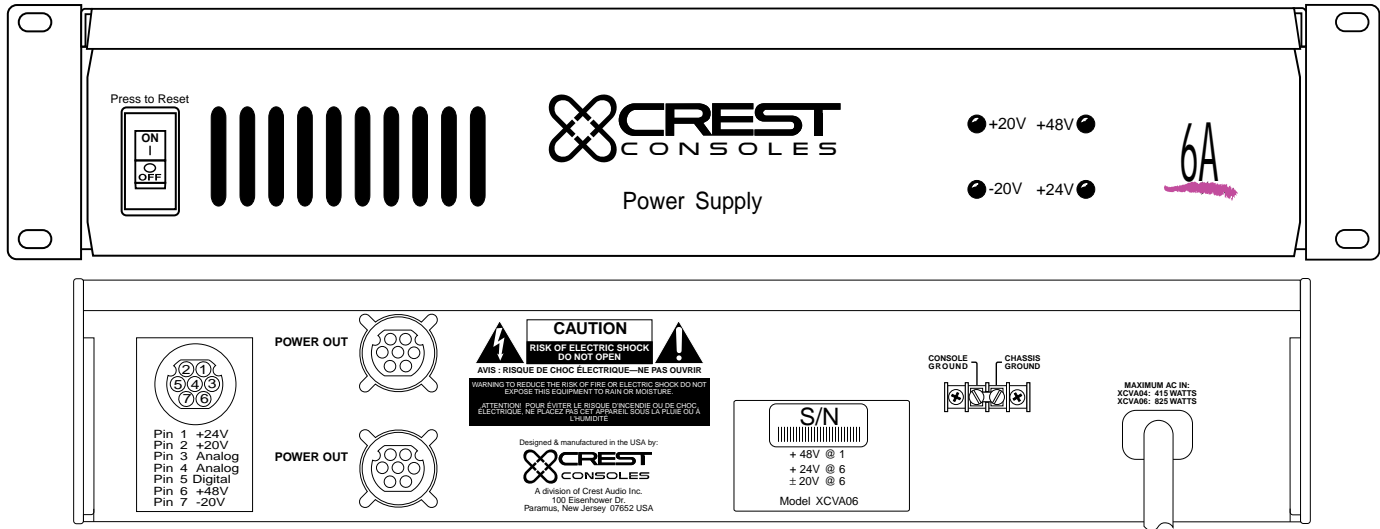

## Supply Identification

The type of power supply can be identified by the model number shown on the back of the chassis and panel label..

## Power Requirements

The Century Series power supplies have certain electrical requirements to operate properly. If possible the power supply should be connected to a dedicated circuit. Should any other appliance on the same circuit draw enough current to overload the circuit, the breaker or fuse will trip causing loss of power to the console. Note the maximum current draw specifications at right. Be sure that the circuit to which you connect the supply can handle the draw.

The power switch on the supply front panel is also a circuit breaker, there is no power fuse. Should the supply ever shut down, or trip at start up, simply push the switch to the off position and then on again.

## Ground Linking

**Safety Considerations**  
Each new power supply is shipped with the AC third wire ground connected to the console chassis ground. The connection is made at the rear of the power supply unit. This is necessary for safety reasons so that exposed metal parts are grounded. In the event of a live conductor making contact with the console chassis or the power supply chassis then the current will flow to ground without a safety hazard arising. Note that when the console is disconnected from the power supply the chassis ground connection to AC third wire ground is broken and safety protection is lost. For uninterruptible grounding, in a fixed installation for example, make a connection directly to the console chassis from the safety ground. Disconnect the ground link on the rear of the power supply. This disconnects console ground from power supply AC third wire ground which would otherwise create a hum-loop.

## Twin Supply Operation

When twin supplies are in use for automatic back-up, then the ground links on both supplies should be fitted.

In a situation where the safety ground to the console chassis has been connected and the ground path via the power supply is causing a hum-loop, then disconnect the ground links on BOTH power supplies.

## Console and Power Supply Grounding

Console chassis ground is electrically connected to audio ground, pin 1 of XLR connectors and 1/4" sockets and to the terminal 'CONSOLE GROUND' at the rear of the power supply. The AC third wire connection in the power supply cable connects the metal chassis of the power supply to safety ground. This connection should never be disturbed. Hazardous voltages exist inside the power supply which require the case to be grounded. When rack-mounted, the power supply ground may transfer to the rack case thru the front fixing screws, though this connection is not reliable. When a console is configured within a complete sound system the grounding requirements may call for the ground link to be disconnected. This is permissible only when an alternative ground path has been provided. If in doubt seek the advice of an experienced electrical engineer.

Power Supply Model	Max Current Draw @ 120V	Max Current Draw @ 240V
XCVA06	9 Amps	5 Amps

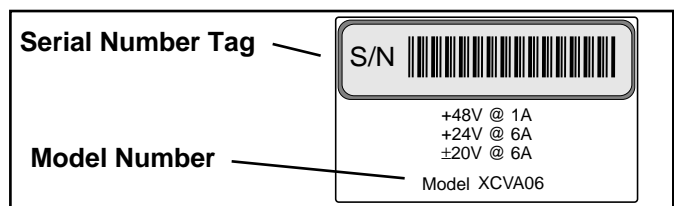



## Power Connections

The connections to and from the power supply vary depending on your specific configuration. Before setting up the console, always check to make sure the AC voltage marked on the power supply agrees with the local supply. Always connect the console to the power supply before switching on the power supply. Do not run the power supply if it is not connected to the console.

Multiple power supplies can be daisy-chained to provide fail-safe protection in the event of a supply failure. When two or more supplies are used, both power supplies run all the time. In the event of supply failure, the remaining power supply(s) will take over the entire load.

*NOTE: Although both of the multi-pin connectors on the back of the power supply are labeled “POWER OUT”, it is necessary (and acceptable) to link two power supplies together as shown in the diagram below.*

*ADDITIONAL NOTE: The multi-conductor cable used for power supply-to-power supply connection is different than that used for a conventional power supply-to-console connection, and must be specified when the second power supply is ordered.*

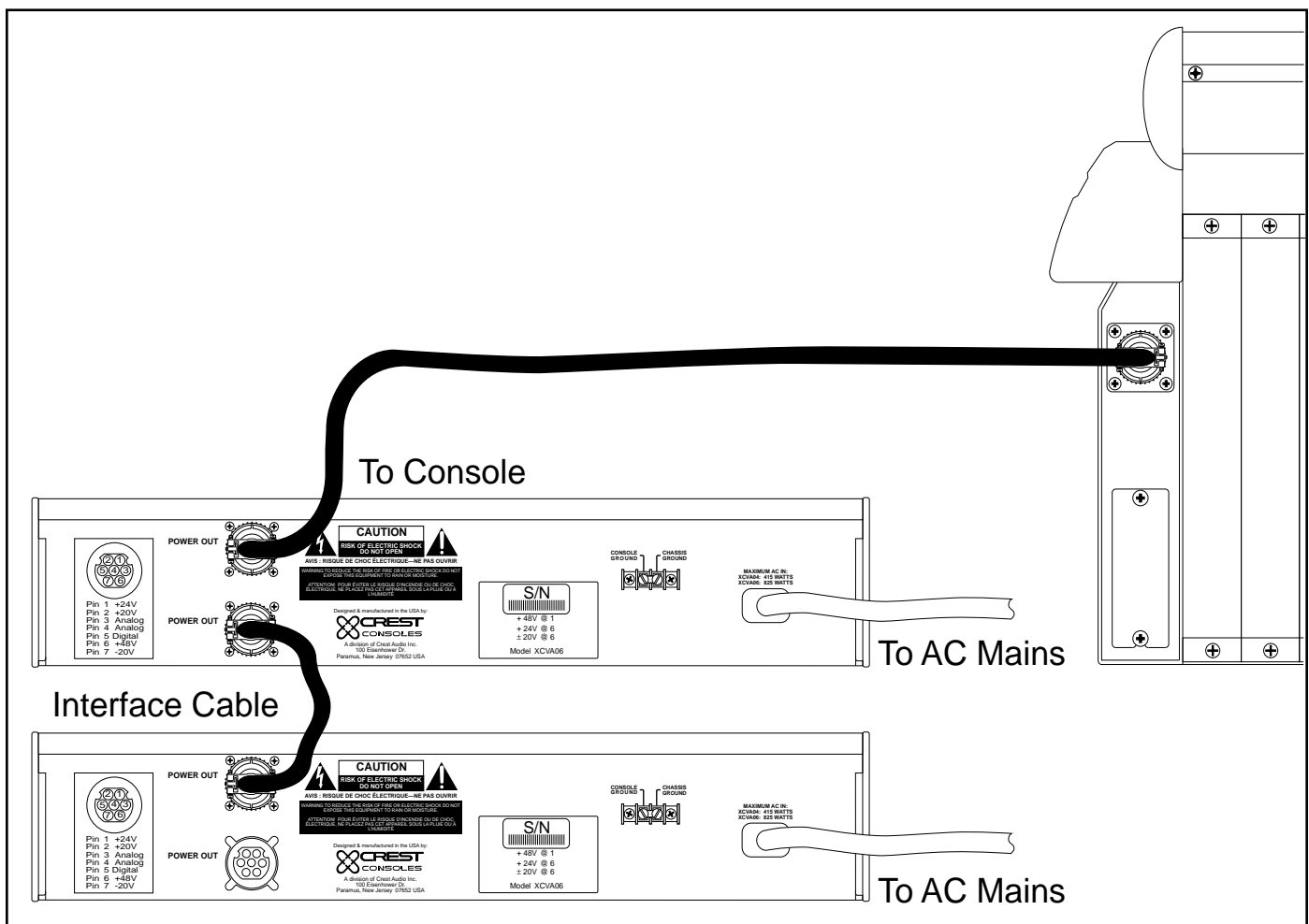

## Console Cooling

A cooling fan configuration is included in all GTx consoles. Two fans (one at each end of the console) draw air in through the sides of the chassis (under the sidebars). Air is distributed through the chassis via a “vortex pan”, then proceeds up through the console modules, where the heated air exits the console chassis.

Once the console is powered up, cooling fans remain on. A rear panel switch permits the fans to be set at low, medium or high speeds.

There are no filters to change or clean. As with any console, use in dusty/unclean environments should be avoided.

### System Connections

The console is the hub of a sound system. Because it controls most of the variables within a system, proper connection and component relationships are vital to assure accurate operation and results. The following diagrams illustrate conventional system connections.

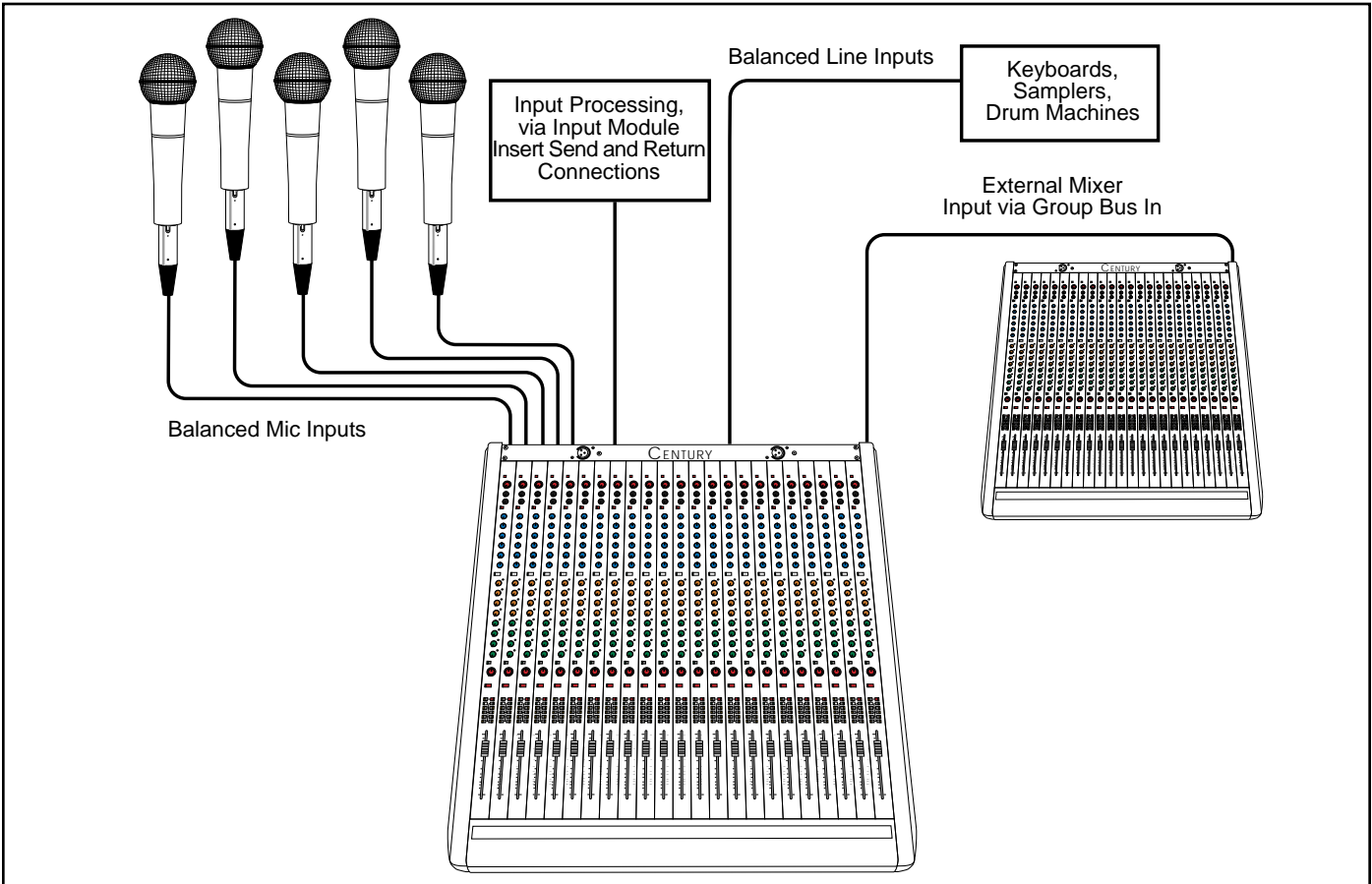

### Input Connections

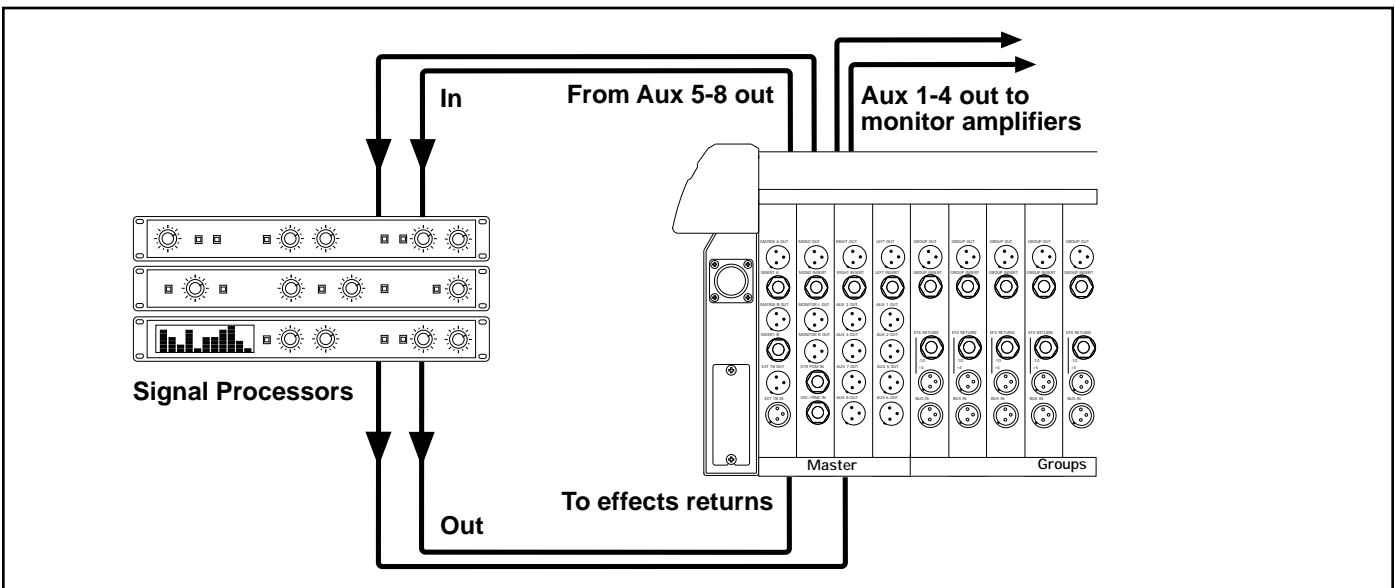

### Aux Connections

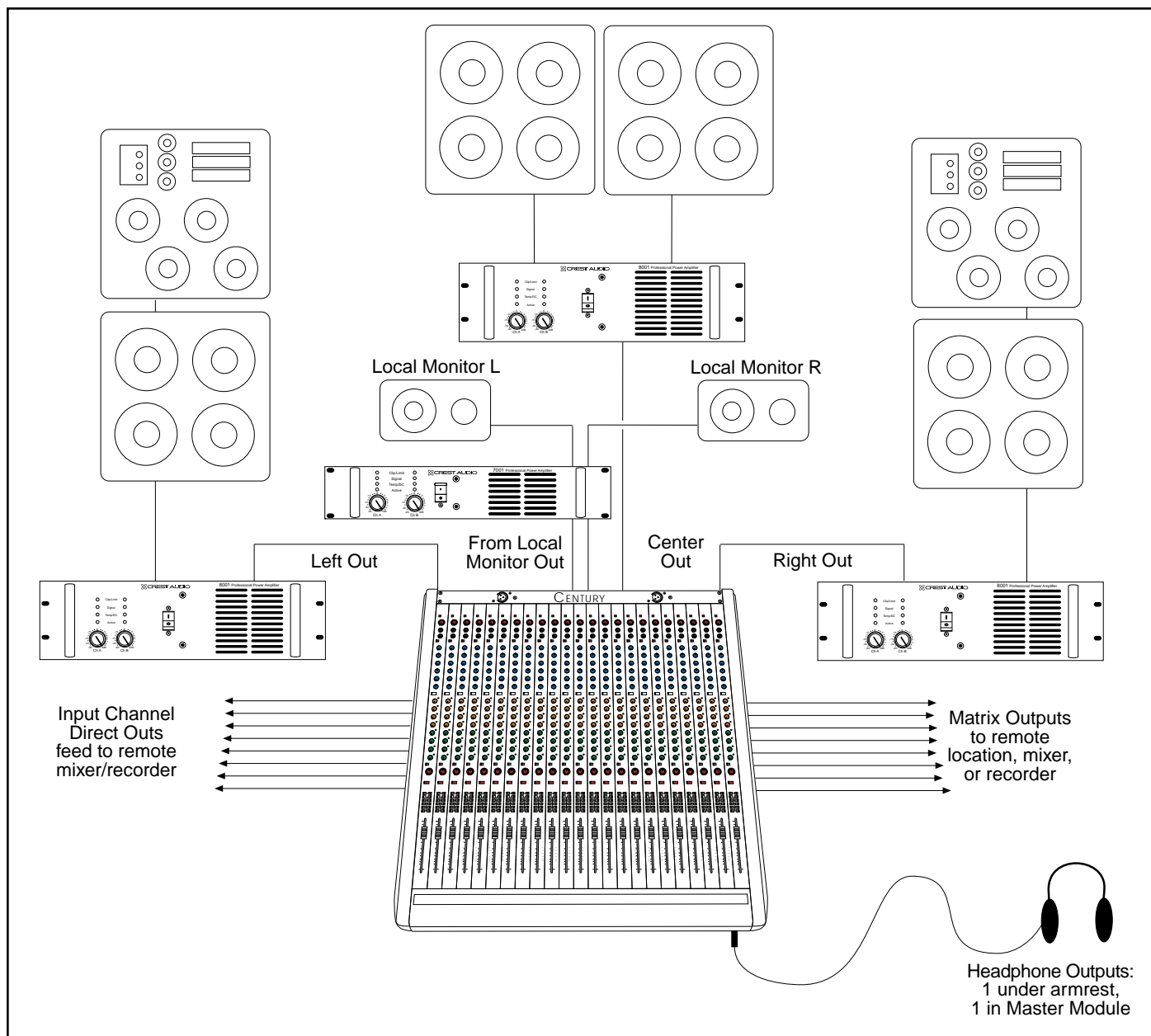

Output Connections

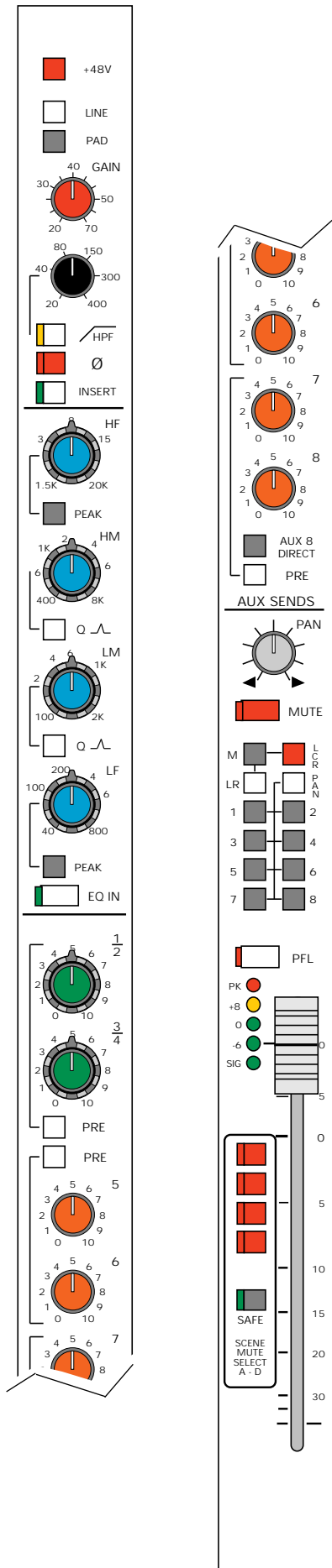

## GTx Input Module

The input module is the main method by which input signals are brought into the console. The GTx input module brings several new features to the Century Series, including a 5-segment LED signal meter array, Adjustable Hi Pass filter, Insert switch, four-band sweep EQ (with selectable peak/shelving on HF & LF EQ bands and selectable Q on HM & LM EQ bands), 8 discrete AUX sends, and L-C-R (Left-Center-Right) bus assignment section.

### 48V Phantom Power Switch

Applies 48 Volts DC to pins 2 & 3 of the microphone input XLR jack for microphones requiring phantom power.

### LINE Switch

Switches between the balanced female XLR microphone Input connector and the balanced Line Input 1/4" TRS connector.

### PAD Switch

Introduces a -15 dB attenuation to the mic input signal, useful when handling high-gain signals.

### GAIN Control

Adjusts input gain for proper signal level. Maximum gain is 70 dB.

### Adjustable High Pass Filter

Reduces all low frequency content at a -12db per octave rate adjustable from 20 to 400 Hz (-3db point). Yellow LED illuminates when switch is down.

### Polarity Reverse Switch

Inverts the polarity of both the microphone and line inputs. The red LED illuminates when switch is down.

### INSERT Switch

Switches any signal processing patched into the Input module (via the rear panel Send/Return jacks) in and out of the signal path. Associated green LED is illuminated when switch is down.

### Four-Band Sweep Equalizer Controls

There are two knobs for each of the four bands. The inner knob controls the boost or cut (15 dB); the outer knob controls the center frequency. Center frequencies are indicated around the outer knob.

### PEAK/SHELVE HF Switch

Used for switching the high frequency EQ between the normal shelving setting to a peak setting.

### SWITCHABLE Q on HI MID and LO MID EQ

Q is switchable between .8 (switch up) and 1.8 (switch down).

### PEAK/SHELVE LF Switch

Used for switching the low frequency EQ between the normal shelving setting to a peak setting.

### EQ IN Switch

Inserts the EQ section into the input channel (post insert, pre fader). An associated green LED illuminates when the switch is down.

### AUX SENDS 1&2 and 3&4 Individual Level Controls

Adjusts signal level sent to respective Aux buses. The signal source for these mixes may be selected pre or post fader by an associated switch. AUX pairs 1&2 and 3&4 are configured as dual concentric pots with the inner knobs controlling the odd sends (1&3), and the outer knobs controlling the even sends (2&4).

### PRE/POST Switch

Switches the Aux 1&2 and Aux 3&4 signal sources between pre and post fader positions. **AUX SENDS 5-8 Individual Level Controls**

Adjusts signal level sent to respective Aux buses. The signal source for these mixes may be selected pre or post fader by the associated AUX 5&6 PRE/POST or AUX 7&8 PRE/POST switches.

### Aux 8 Direct Switch

Removes the Aux 8 signal from the Aux 8 bus, and assigns the signal to the direct out 1/4" connector on the rear panel, instead of the normal post fader Dir Out signal.

### AUX 5&6 PRE/POST Switch

Switches the Aux 5 & 6 signal sources between pre and post-fader.

### AUX 7&8 PRE/POST Switch

Switches the Aux 7 & 8 signal sources between pre and post-fader

### PAN CONTROL

Positions the channel image between left and right or between left-center-right. (See L-C-R Switch)

### MUTE Switch with LED

Mutes the channel and all send functions. Mute does not affect the PFL switch or the Peak and Signal Present LED indicators. Red LED illuminates when the channel is muted.

### MONO Bus Assign Switch

Assigns the input signal directly to the Center / Mono bus.

### L-C-R Switch

Configures Left/Right and Center/Mono assignments for L-C-R panning. To enable L-C-R panning, L-R and Mono assign switches must be down.

### PAN Switch / Group Assign Switches (1-8)

With PAN switch down, the PAN control varies the level of the group assignments with odd numbered groups on the left and even numbered groups on the right. With PAN switch up, groups can be individually selected and are unaffected by the PAN control. Group assign switches route signals to the Group buses.

### PFL Switch

Samples the channel's signal (pre-fader) and allows for monitoring within the master section of the console. This signal is not affected by the Mute switch. When depressed, the signal level can be seen on the Solo meters (which brighten in intensity), and can be heard via the mixer's headphone or local monitor output. When this PFL switch is depressed, the associated yellow LED illuminates.

### 5-Segment LED Array

The signal is monitored pre-fader. Signal Present LED (green) responds to levels as low as -30 dB and comes to full brightness at -8dB, varying in intensity according to level. -6dB LED (green), 0dB LED (green), and +8 dB (yellow) illuminate accordingly. The Peak (red) LED responds to overloads at three points in the module; pre-EQ, post-EQ, and post-fader.

### 100mm Fader

Used for control of all outputs of the channel except those Aux output sections selected by the PRE/POST switch to a pre-fader position. (The Insert output level is not affected by the fader position.)

### Scene Mute Assignment Buttons

Assigns input channels to any of the four Scene Mute groups. Scene Mute combines with the module's local Mute button, and actuates the local Mute LED.

### Scene Mute Safe Switch

Disables any selected Scene Mute assignments. An associated green LED indicates the channel is in a Safe state.

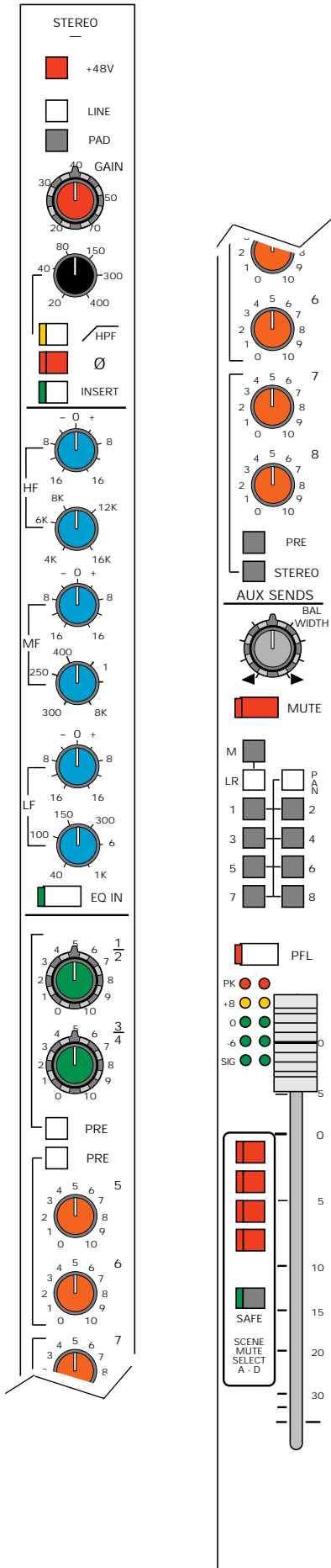

## GTx Stereo Input Module

The GTx Stereo Input module is essentially two GTx Input modules packaged to fit into a one-module space. This module is very useful for accepting remote feeds, effects outputs and other signals that require stereo handling.

### 48V Phantom Power Switch

Applies 48 Volts DC to pins 2 & 3 of the both L and R XLR inputs, for microphones requiring phantom power.

### LINE Switch

Switches between the balanced XLR Microphone Input connector and the balanced Line Input 1/4" TRS connector for both L and R channels.

### PAD Switch

Introduces a -20 dB attenuation to the mic input signal for both L and R XLR inputs.

### L GAIN & R GAIN Controls

These concentric controls adjust input gain for proper signal level for both Left and Right inputs. Maximum gain is 70 dB. Inner knob is for L GAIN, outer knob is for R GAIN.

### Adjustable High Pass Filter

For both Left and Right inputs, reduces all low frequency content at a -12db per octave rate adjustable from 20 to 400 Hz (-3dB point). Yellow LED illuminates when switch is down.

### Polarity Reverse Switch

For both input channels, inverts the polarity of both the microphone and line inputs. An internal jumper selects between Left channel only (default) or both Left & Right channels. When this switch is pushed, an associated LED lights.

### INSERT Switch

Switches signal processor in and out of L and R signal paths. Associated green LED is illuminated when switch is down.

### Three-Band Sweep Equalizer Controls

The equalization controls in this module act upon both L and R stereo channels at once. All three EQ bands are set up as sweep EQ's: the upper knob controls the gain or cut (15 dB); while the lower knob controls the center frequency adjusted by the inner knob. Center frequencies are indicated around the lower knob.

### EQ IN Switch

Inserts the EQ section into both L and R input channel signals at once. An associated green LED illuminates when the switch is down.

### AUX Level 1 & 2 / 3 & 4

Adjusts signal level sent to respective Aux buses. The signal source for this mix may be selected pre or post fader by an associated switch. The left channel is sent to the odd-numbered Auxes, and the right channel is sent to the even-numbered Auxes.

**PRE/POST Switch (1&2 / 3&4)**

Selects the Aux 1&2 and Aux 3&4 signal sources between post and pre-fader positions.

**PRE/POST Switch (5&6)**

Selects the Aux 5&6 signal sources between post and pre-fader positions.

**AUX 5 - 8 Individual Level Controls**

Adjusts audio level of a mix for use as a monitor or an effect send. The signal source for these mixes may be selected pre or post-fader by an associated switch.

**STEREO Switch**

AUX 7&8 Individual Level Controls normally send a summed (L+R) signal to the AUX outputs. When the STEREO switch is depressed, AUX 7 and 8 become a send 'left' and 'right' send respectively. This can be used for a stereo effects send.

**PRE/POST Switch (7&8)**

Selects the Aux 7&8 signal sources between post and pre fader positions.

**WIDTH Control**

When used together with the BAL(ance) control, the WID(th) control provides a unique way to configure stereo panning. When turned all the way counter-clockwise, this control conventionally assigns the left signal to the left (odd) channel assignment, and the right signal to the right (even) channel assignment. When adjusted to the 'twelve o'clock' position, left and right signals are panned straight up the middle, effectively summing them to mono. When this knob is turned all the way clockwise, the left and right signals are 'flip-flopped', left being assigned to the right (even) side, and the right side being assigned to the left (odd) side.

**BAL Control**

Positions the entire channel image between the left (odd) and right (even) channel assignment. Together with the WID control, this gives total control of the stereo image.

**MUTE Switch with LED**

Mutes the channel and all send functions. This switch does not affect the PFL switch or the Peak and Signal Present LED indicators. The LED illuminates when the channel is muted.

**MONO Bus Assign Switch**

Assigns the input signal directly to the Mono bus.

**Bus Assign Switches (L/R, 1-8)**

Assigns the post Pan signals to mix bus in odd/even-numbered pairs. Pan controls assignment between these two mix buses with extreme left pan assigning signal exclusively to the odd-numbered mix bus and extreme right pan assigning signal exclusively to the even-numbered mix buses. When the pan is in its center position, signal is fed equally to the odd (left) and even (right) mix buses. When used in stereo applications, the channel signal may be located anywhere within the stereo image as controlled by the Pan control.

**PFL Switch**

Samples the channel's signal pre-fader and allows for monitoring within the master section of the console. This signal is not affected by the Mute Switch. When depressed, the signal level can be seen on the Solo meters, and heard via the mixer's headphone or local monitor output. When this PFL Switch is depressed, the channel PFL LED indicator illuminates.

**PEAK LED Indicator**

Illuminates RED when any of the points monitored come within 3db of the clipping point. Signal is sampled after the input preamplifier stage, after the EQ section, and after the fader.

**5-Segment Dual-Ladder LED Array**

This dual LED array monitors the stereo signals pre-fader. Signal Present LED (green) responds to levels as low as -30 dB and comes to full brightness at -8dB, varying in intensity according to level. -6dB LED (green), 0dB LED (green), and +8 dB (yellow) illuminate accordingly. The Peak (red) LED responds to overloads at three points in the module; pre-EQ, post-EQ, and post-fader.

**100mm Fader**

Used for control of all outputs of the channel except those Aux output sections selected by switch to a pre-fader position. (The Insert output level is not affected by the fader position.)

**Scene Mute Assignments**

Assign the input channel to any of the four Scene Mute groups. Scene Mute combines with the module's local Mute button, and actuates the local Mute LED.

**Scene Mute Safe Switch**

Disables any selected Scene Mute assignments. An associated green LED indicates the channel is in a Safe state.

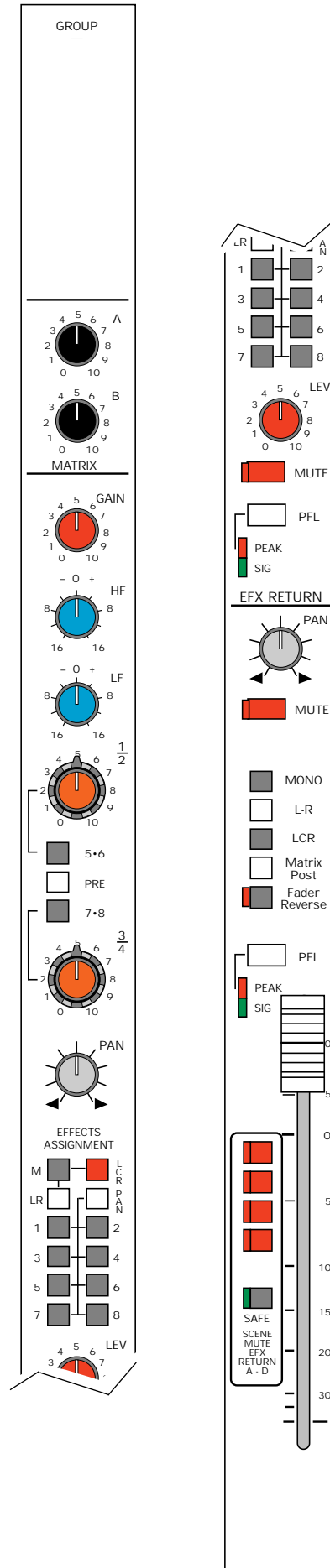



## GTx Group Modules

The Group Module is where input signals are combined and configured for grouped output; effects & aux assignment/routing are also accomplished here. Fully loaded GTx consoles have eight group modules. Group number is indicated on PFL switch.

### Group Meter

Located on the meter bridge, it indicates the post-fader output level of the group.

### Matrix Levels (A, B)

Adjusts the level of group signal sent to the respective matrix.

### Effect Return Gain

Controls gain on the signal returning from the attached effect.

### Effect Return EQ Controls

Alter the effect return signal pre-fader by providing 16 dB of boost and cut. Upper control is centered at 80Hz, while the lower control is centered at 10 kHz.

### Effect Aux Sends 1/2 (5/6)

A dual-concentric pot is used to control the level of effect return signal sent to Aux Sends 1(center knob) and 2(outer knob).

### Aux 5•6 Switch

Switches function of Effect Aux Sends control between Auxes 1&2 and Auxes 5&6.

### Pre/Post Switch

Switches effect return signal between pre & post Effect Level Control.

### Effect Aux Sends 3&4 (7/8)

A dual concentric pot is used to control the level of effect return signal sent to Aux Sends 3(center knob) and 4(outer knob).

### Aux 7•8 Switch

Switches function of Effect Aux Sends control between Auxes 3&4 and Auxes 7&8.

### Effects Assignment L-C-R Switch

Configures Left/Right and Center/Mono assignments for Left - Center - Right Panning. L-R and Mono assign switches must be down

### Effects Assignment Pan Switch / Group Assign Switches (1-8)

With PAN switch down, PAN control varies the level of the group assignments with odd numbered groups on the left and even numbered groups on the right. With PAN switch up, groups can be individually selected and are unaffected by PAN control. Group Assign switches assign signals to Group buses.

### Effects (EFX) Return Pan

Positions the EFX Return signal between left & right, between left-center-right, or between odd & even-numbered assigned groups.

### Effects (EFX) Return Level

Adjusts the final effect return signal level.

### Effects (EFX) Mute

Mutes the effect return signal.

### Effects (EFX) PFL

Allows for Pre-fader listening of the effect return signal.

### Effects (EFX) Peak & Signal LED's

The red LED indicates that the effect signal is within 3dB of the clipping point. The green LED constantly displays the level of signal activity by varying in intensity.

### Group Pan

Positions group image between Left & Right output assignments.

### Group Mute

Mutes the group signal except for the group insert send.

### Group Mono Assign

Assigns the associated Group signal to the Mono bus.

### Group L-R Assign

Assigns the associated Group signal to the Left and Right buses. Exact assignment will be dependent upon the position of the Group Pan control.

### Group LCR Switch

Configures Left/Right and Center/Mono assignments for L-C-R Panning. For L-C-R panning, Group L-R and Group Mono assign switches must be down.

### Matrix Pre/Post

Switches the Matrix send between pre and post-fader settings.

### Fader Reverse w/LED

Swaps functions between the Effect Level control and the group fader; one becomes the other.

### Group PFL

Allows for Pre-fader Listening of the Group signal.

### Group Peak & Signal LED's

The red LED indicates that the group signal is within 3dB of the clipping point. The green LED constantly displays the level of group signal activity by varying in intensity.

### Group Fader

Controls all post-fader group signal outputs.

### EFX Return Scene Mute

### Assignments

Assign the EFX return signal to any of the four scene mute groups. Scene Mute combines with the effect's local Mute button, and actuates the local Mute LED.

### EFX Return Scene Mute Safe Switch

Disables all selected EFX Scene Mute assignments. An associated green LED indicates the return is in a Safe state.

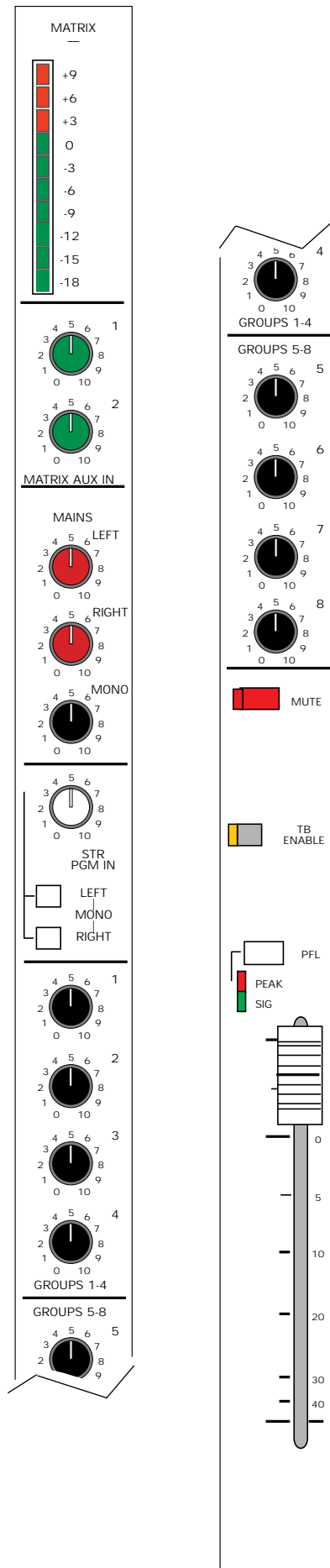

## Matrix Module

The Matrix module allows the creation of an independent mix using the Main outputs and an external inputs as signal sources.

### Matrix Meter

Shows output level of matrix module, 0dB=+4dBu.

### Matrix AUX IN Controls

Controls level of external balanced input signals.

### L & R MAINS Controls

Controls level of post fader L & R signals from main section.

### MONO MAINS Control

Controls the level of post fader Mono signal from main section.

### STR PGM IN Control

Controls level of Stereo Program being input into the matrix from the mono master module circuit.

### LEFT/MONO/RIGHT Switches

Selects which stereo program in signals are introduced into the matrix.

### GROUPS 1-4 Controls

Adjusts the level of Group signals 1-4 introduced into the matrix.

### GROUPS 5-8 Controls

Adjusts the level of Group signals 5-8 introduced into the matrix.

### MUTE Switch with LED

Mutes the output. This switch does not affect the PFL switch or the Peak and Signal Present LED indicators.

### TB ENABLE Control

Injects the talkback signal from the Master section into the matrix.

### PFL Switch

Samples the matrix signal pre-fader and allows for monitoring within the master section of the console. This signal *is not* affected by the Mute switch. When depressed, the signal level can be seen on the Solo meters, and heard via the mixer's headphone or local monitor output. When this PFL switch is depressed, the PEAK LED illuminates at a lower intensity. When used as a status indicator of switch position, the Peak LED indicating circuit remains fully operational by illuminating at a much higher intensity than its use as a PFL status indicator.

## PEAK LED Indicator

Illuminates RED when any of the points monitored come within 3db of the clipping point. Signal is sampled after the summing stage and after the fader. This LED also serves as a PFL ON indicator, but at a much lower intensity than when it is used to indicate clipping.

## SIGNAL PRESENT LED

Constantly displays level activity of the matrix by varying in intensity.

## MATRIX OUTPUT LEVEL

Used for control of the Matrix output of the channel.

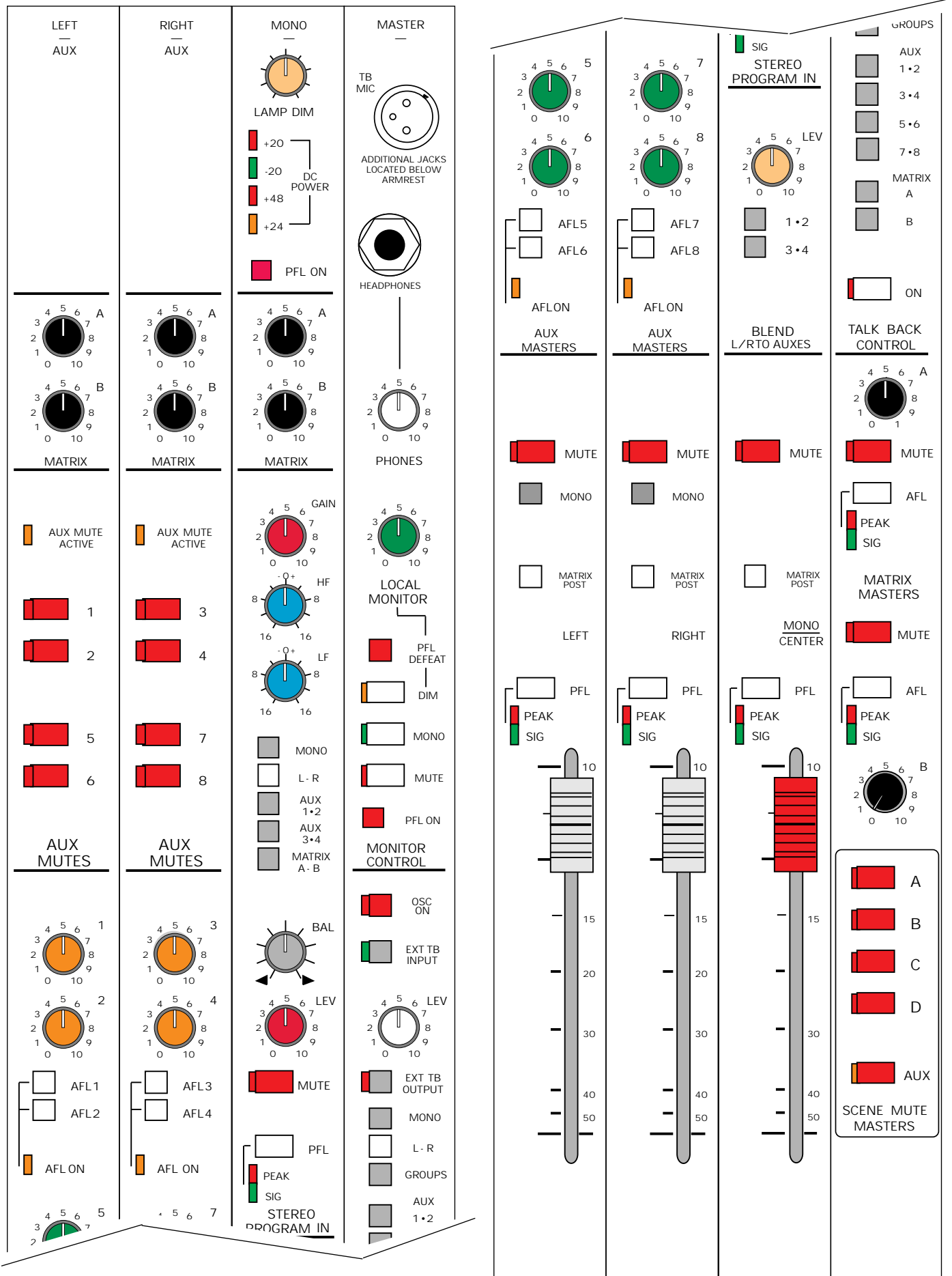

## GTx Master Section

The master section is the control center for the GTx console. Monitoring, talkback, PFL, Stereo Program In, Master Aux & Matrix, L-C-R, internal oscillator and Scene Muting functions are all controlled here.

### Lamp Dim Control

Controls the intensity of the lighting devices plugged into the XLR sockets on the back of the meter bridge.

### Talkback Mic Input

Allows for a microphone to be plugged in for use with the talkback system. An additional Talkback Mic Input jack can be found next to the headphone jack on the front-right of the console under the arm rest.

### Power Indicators

These four LED's indicate the status of the four voltages used by Century Series consoles.

### Headphone Jack

Delivers right and left output, unless a PFL switch is depressed. Whenever any signal is in PFL mode, the headphone jack will deliver that signal. An additional headphone jack is located beneath the hand rest on the right-front part of the console.

### Headphone Level Control

Controls the signal level delivered to the headphone jacks.

### L, R & Mono Matrix Sends

Controls level of Right, Left and Mono signals sent to the two matrices.

### Local Monitor Level Control

Controls level of signal delivered to the monitor outputs.

### Auxiliary Mutes

Mutes the respective auxiliary sends.

### PFL Defeat

Disables PFL function to the local monitor, allowing local monitor output to function as an additional left/right output.

### Dim Switch

This switch introduces a -12 dB attenuation into the local monitor and headphone outputs. It is disabled when PFL defeat is depressed, auto-active when TB is on.

### Mono Switch

Switches the local monitor output from standard stereo mode to a mono mode.

### Stereo Program In Gain

Adjusts the gain of the Stereo Program In signal.

### Stereo Program In EQ

Two-band fixed frequency (10kHz and 80Hz) EQ that affects the Stereo Program In signal.

### Stereo Program In Assignments

Assigns the Stereo Program to the associated buses.

### Local Monitor Mute

Mutes the local monitor signal output.

### Aux Master Controls

Controls final output signal level of the auxiliary outputs.

### Aux AFL Switches

Switch the eight auxiliary outputs to After Fader Listening mode, via normal PFL signal path. Aux outputs can be monitored as stereo pairs if both AFL switches are depressed. If only one is depressed, that AUX is monitored in mono.

### External Oscillator Switch

Turns on the internal oscillator or accepts signal from the 1/4" TRS Oscillator input jack.

### External Talkback Input Switch

Selects the external talkback input XLR as an input signal to the talkback section and overrides the Oscillator.

### Stereo Program Balance

Adjusts balance of stereo signal from Stereo Program input.

### Stereo Program Level

Controls final output signal level of the Stereo Program.

### Talkback Level Control

Controls the level of the selected talkback source.

### External Talkback Output Switch

Turns on the external talkback XLR.

### Stereo Program Mute

Mutes the output of the stereo program.

### Stereo Program PFL

Allows Pre-fader Listening of the Stereo Program signal.

### Talkback Assignment Switches

Assigns talkback signal to outputs, groups and/or auxes.

### Blend Level

Controls level of L & R signal blended to assigned auxes.

### Blend Assignment Switches

Assigns the Left and Right signals to the respective auxes thru blend-level pot.

### Talkback On/Off Switch

Turns the talkback system on and off.

### Matrix Master Levels (A&B)

Controls the final output level of the respective matrix.

### Matrix Master Mutes (A&B)

Mutes the respective matrix signal.

### Matrix Master AFL (A&B)

Allows After-Fader Listening of the respective matrix signal.

Matrices A&B can be monitored as a stereo pair if both AFL's are pressed; if one button is pressed, only one of them is monitored.

### Scene Mute Master Switches

Turn on and off the four Scene Mutes.

### Aux Scene Mute On/Off Switch

Turns the Aux Scene Mute system on and off.

### L/R/Mono Mute Switches

Mute outputs of Left, Right and Mono signals respectively.

### L&R Mono Assignment Switches

Assign the Left and Right signals to the Mono output.

### L/R/Mono Matrix Post Switches

Switches the Left, Right and Mono matrix feed signals between pre and post-fader.

### L/R/Mono PFL Switches

Allow for Pre-Fader Listening of the Left, Right and Mono signals respectively.

### L/R/Mono Peak & Signal LED's

The red LED indicates that the signal is within 3dB of the clipping point. The green LED constantly displays the level of signal activity in the mix bus by varying in intensity.

### L/R/Mono Faders

Adjust final output signal level of Right, Left and Mono outputs.

### GTx Meter Bridge - 52 & 64 Frame Models

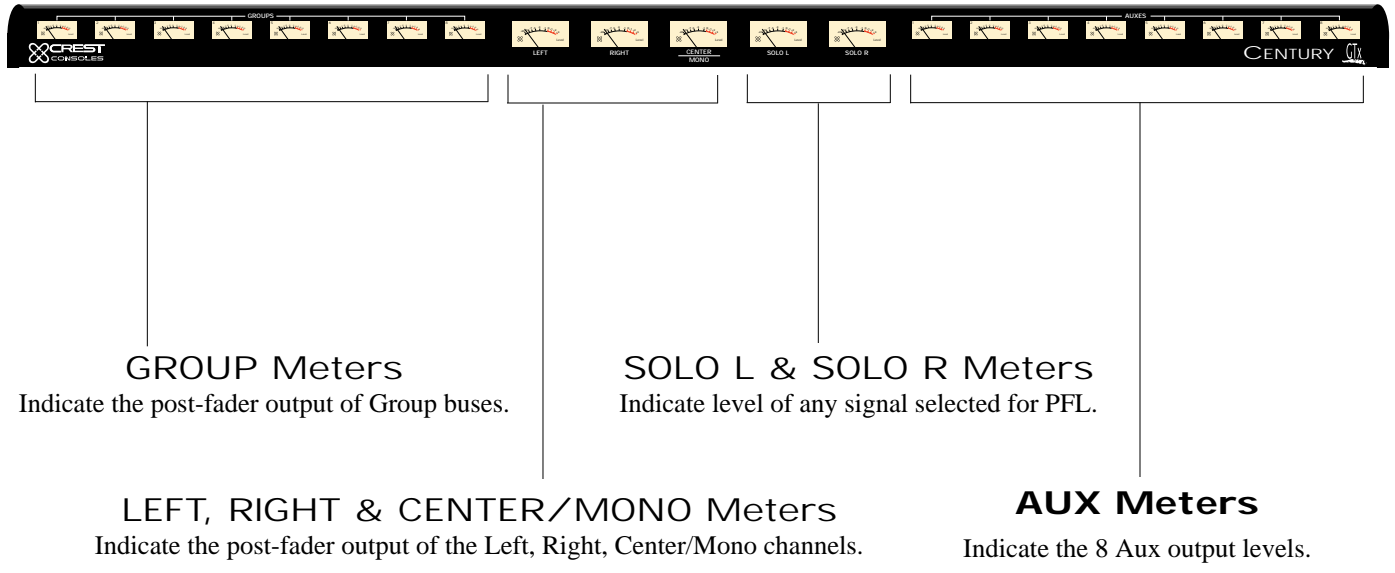

### GTx Meter Bridge - 44 Frame Model

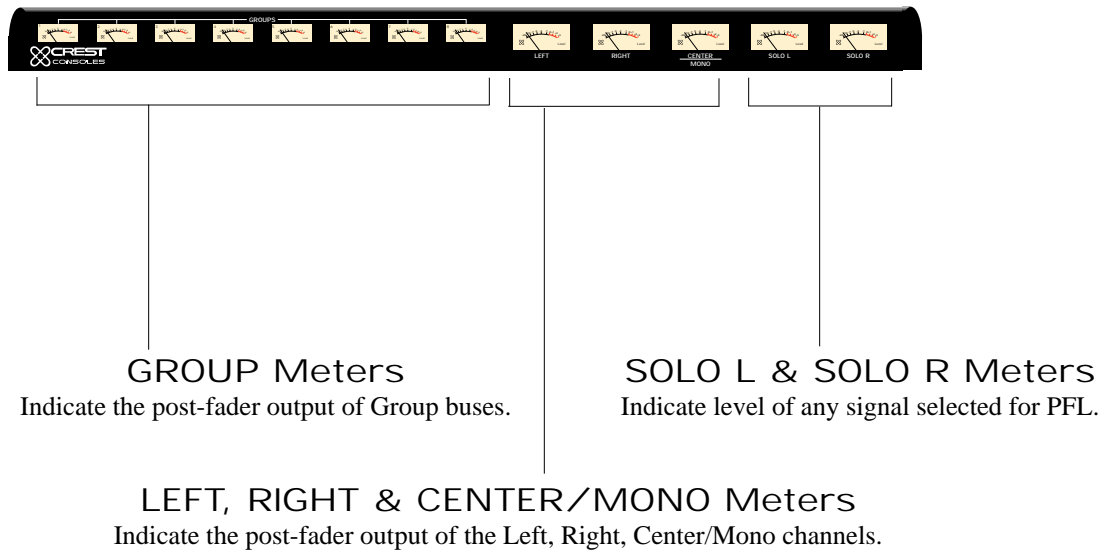





GTx

# Appendix A

## Technical Information

## General Specifications - GTx Console

The following are the technical specifications for the Century GTx console.

<b>Frequency Response</b>	
+0.0, -0.5dB, 20Hz to 20 kHz (referenced to 1kHz)	
<b>Total Harmonic Distortion</b>	
Mic input to Group output	
20Hz to 20 kHz at +15dBu	<0.01%
<b>Noise (22Hz to 22kHz)</b>	
Mic EIN	-129 dBu
Mix bus Output Noise (20 ch routed)	- 80 dBu
Aux bus Output Noise (20 ch routed)	- 80 dBu
<b>Crosstalk (Measured at 1kHz)</b>	
Channel Mute	>102 dB
Channel Fader Attenuation	> 96 dB
Channel Routing	> 85 dB
Channel Aux Send Attenuation	> 93 dB
<b>Input/Output Impedances</b>	
Mic Input	4k $\Omega$ balanced
Line Input	>10k $\Omega$ balanced
Outputs	140 $\Omega$ balanced
<b>Input/Output Levels (0VU = +4 dBu, 1.23V RMS)</b>	
Mic Input Sensitivity	+ 4 to -62 dBu
Line Input Sensitivity	+ 12 to -38 dBu
Input Insertion Point Level	+ 4 dBu
Output Insertion Point Level	- 2 dBu
Nominal Output Level	+ 4 dBu
Maximum Balanced Output Level	+28 dBu

## Configurations

Century GTx consoles are available in the following eight-bus configurations:

- 32 inputs (44 Frame)
- 40 inputs (52 Frame)
- 52 inputs (64 Frame)

All Century GTx consoles are available with stereo input modules and additional matrix modules.

## Architect's & Engineer's Specifications

The following text should be used when specifying a Century GTx in a bid or proposal.

The GTx live sound console shall be constructed in a modular fashion and be housed in a steel frame of (44, 52, 64) module positions. The console shall be usable in either a 'tabletop' set up or with optional stands. A standard output module configuration will occupy 12 module positions including a standard 2 channel output matrix system. The console shall be black with white labeling and utilize XLR lighting device connectors with dimmer system. A meter bridge shall be included that monitors console signals using mechanical meters with solid state illumination. Signals to be monitored include Left output, Right output, Mono (Center) output, Stereo PFL signal and 8 group output signals. On 52 and 64 module position frames, 8 auxiliary output meters are also to be provided. The console shall have a pair of XLR talkback mic and headphone jack connectors, with one set being located beneath the far right side of the armrest and a second pair on the top panel of the console. The GTx live sound console shall feature a defeatable Left-Center-Right (LCR) panning system. On each input channel: All microphone inputs shall be electronically balanced and accessed via 3-pin XLR connectors and have an EIN of -129 dBm. All input channel line inputs shall be electronically balanced and accessed via 1/4" TRS jacks. Input module insert and return points shall be via individual 1/4" jacks and controlled by a front panel switch with LED. Additional input controls include: a +48 volt phantom power switch, a -15 dB pad switch (-20 dB for stereo input channels), adjustable high pass filter control (20-400Hz) with on switch and LED, a polarity reverse switch with LED, and 4-band sweep EQ (LF- 40-800Hz, LMF- 100Hz-2kHz, HMF- 400Hz-8kHz, HF- 1.5k-20kHz) with peak/shelve switches on the high and low EQ bands, switchable bandwidth on low-mid and high-mid bands, and an EQ In switch with LED. Each input channel shall also have a FET controlled (10 millisecond ramp) mute switch with LED, affecting all assigned outputs including auxiliary sends. Assignment switching is provided to the following output sections: Left/Right, Mono, Subgroup 1, Subgroup 2, Subgroup 3, Subgroup 4, Subgroup 5, Subgroup 6, Subgroup 7 and Subgroup 8. An LCR switch reconfigures the Left/Right and Mono assignment system to a true Left/Center/Right mix system. A Pan On switch allows conventional panning between any odd and even subgroup assignment regardless of the position of the LCR configuration switch. A 5-segment signal level LED indicator is provided to monitor signal levels, and a multiple sample point peak LED is provided to monitor potential overload situations. Input modules also include a PFL switch with LED indicator, 4 scene mute preset switches, scene mute safe switch with LED, and a 100mm long throw fader. Each input channel shall have eight auxiliary send level controls. The aux send section shall include three pre/post fader switches: one for auxes 1-4, one for 5&6, and one for 7&8. The aux sends shall be internally selectable pre or post EQ and pre or post mute. There shall be an Aux 8 direct switch that shall allow the Aux 8 rotary knob to directly control the output of the 1/4" direct output connector. Optional stereo input modules will be available. The console shall be configured in an eight bus arrangement. The effect return section of each group module shall have a gain control, a two-band fixed EQ, sub-group assignment switches, L/R and Mono assignment switches with an LCR configuration switch, aux send level controls for Auxes 1 through 4 with 1-2 switchable to 5-6, and 3-4 switchable to 7-8, a pan control, a level control, a dynamic signal present LED and peak LED, and a PFL switch. 4 scene mute switches (A-D) with scene mute safe switch with LED will be available on each return section. The group mix section of the module shall have a pan control, a FET controlled (10 millisecond ramp) mute switch with LED, assignment switches for Left/Right and Mono with an LCR configuration switch. Each group mix section will have balanced (XLR) group insert connections. There will be a send level control for two Matrix mixes (A & B) on each group module with source selection matrix post fader switch. It shall also have a fader reverse switch with LED that allows the group fader to control the level of the modules effect return. A PFL switch, dynamic signal present LED and peak LED, and a 100mm long throw fader shall also be provided on the group module. The master section shall have the following features: eight aux master controls with associated AFL switches and eight aux scene mute switches with LED's, a 100mm long throw fader for each of the Left, Right, and Mono (Center) master outputs, balanced (XLR) insert connections for Left, Right, and Mono (Center) master outputs, an assignable comprehensive talkback system, monitor control (with balanced XLR output), stereo program input section with Stereo EQ, lamp dimming control, and four+two aux scene mute master switch section, each with LED. Two master matrix output sections include level control, Mute switch with LED, AFL monitor switch and peak and signal present LED indicators. The two Matrix output signals are to be derived from the consoles group output signals, left, right, and mono output signals. Additional matrix output modules may be installed in the console frame if unused space is available. The power supply shall be housed in a 14 ga. steel chassis that shall occupy two 19" rack spaces. The power supply shall have the ability to be daisy-chained to additional power supplies to provide a fail-safe operating environment. Connection of two or more power supplies shall not require additional interface hardware other than interface cable. The live sound console shall be: the Crest Audio Century GTx.

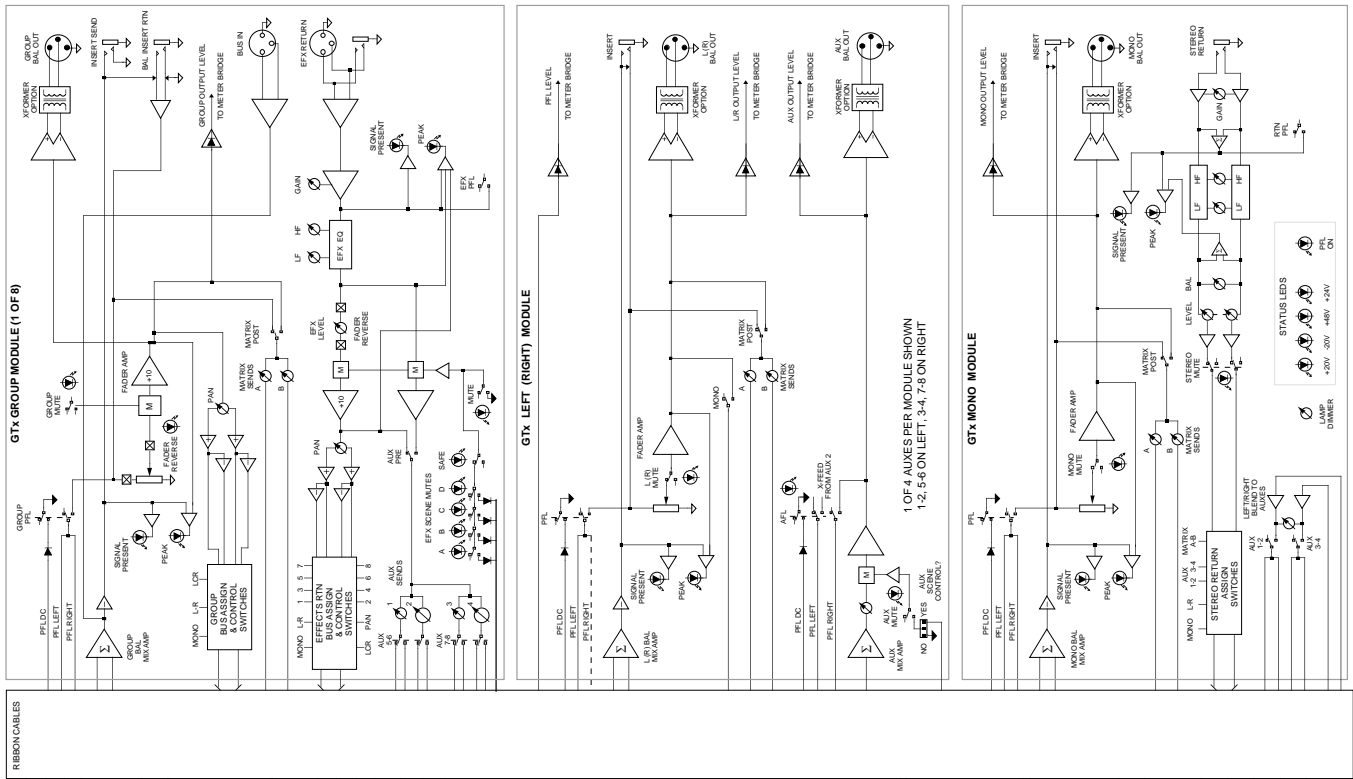

REBSON CABLES

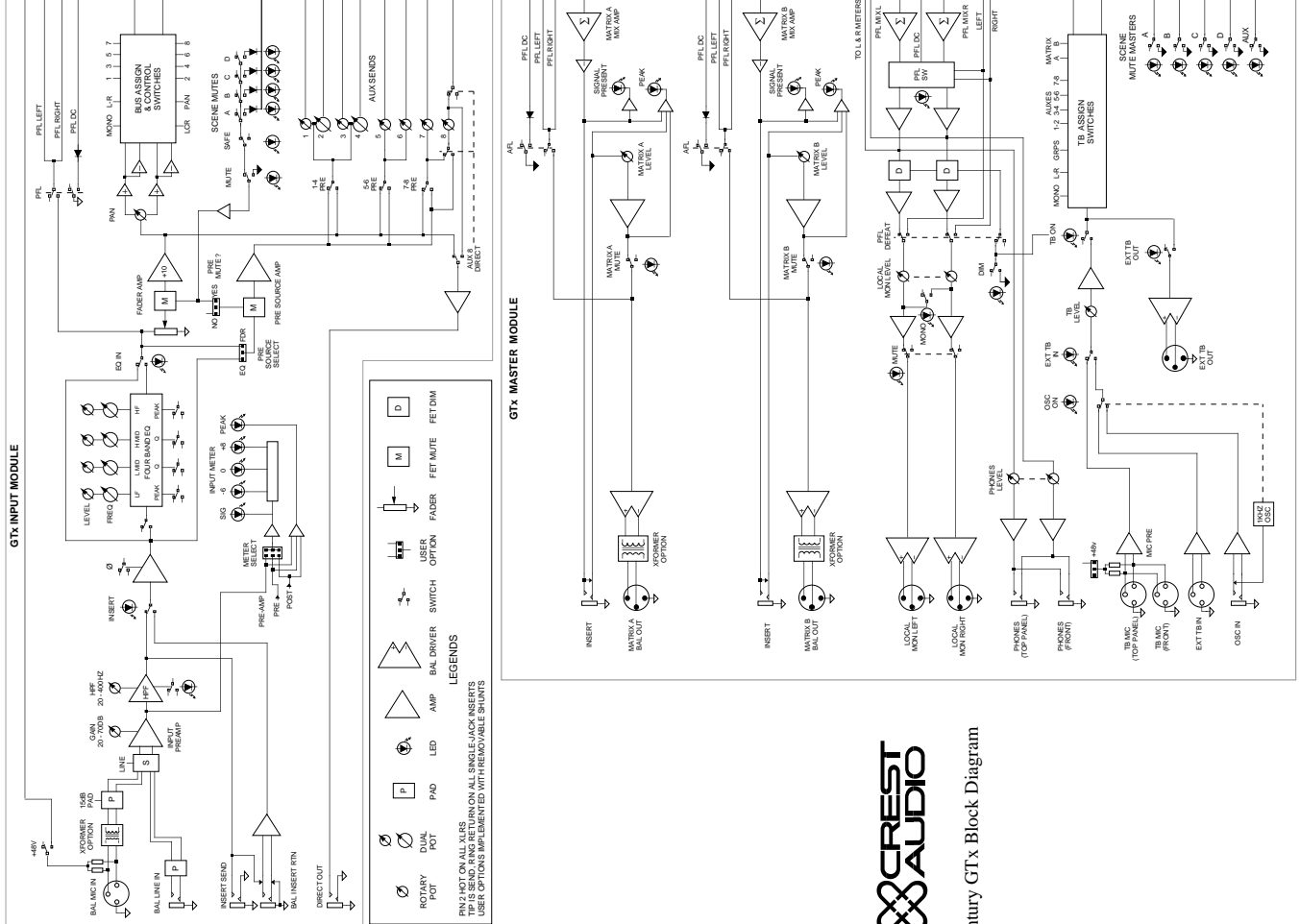

**CREST AUDIO**

Century GTx Block Diagram

### Side Dimensions

The following diagram illustrates the depth and height dimensions (from the side) for all Century GTx consoles.

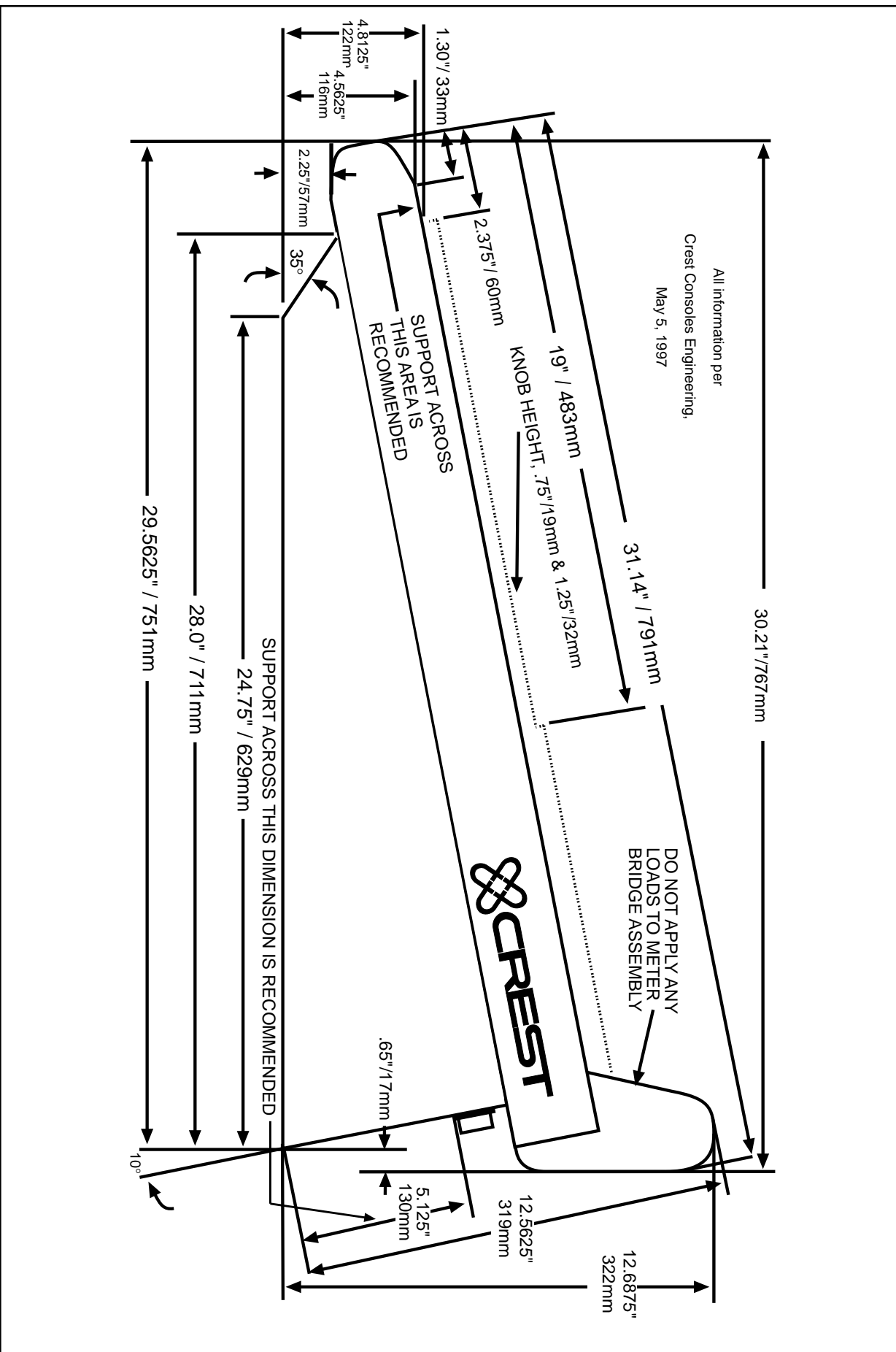

Rear Views & Dimensions

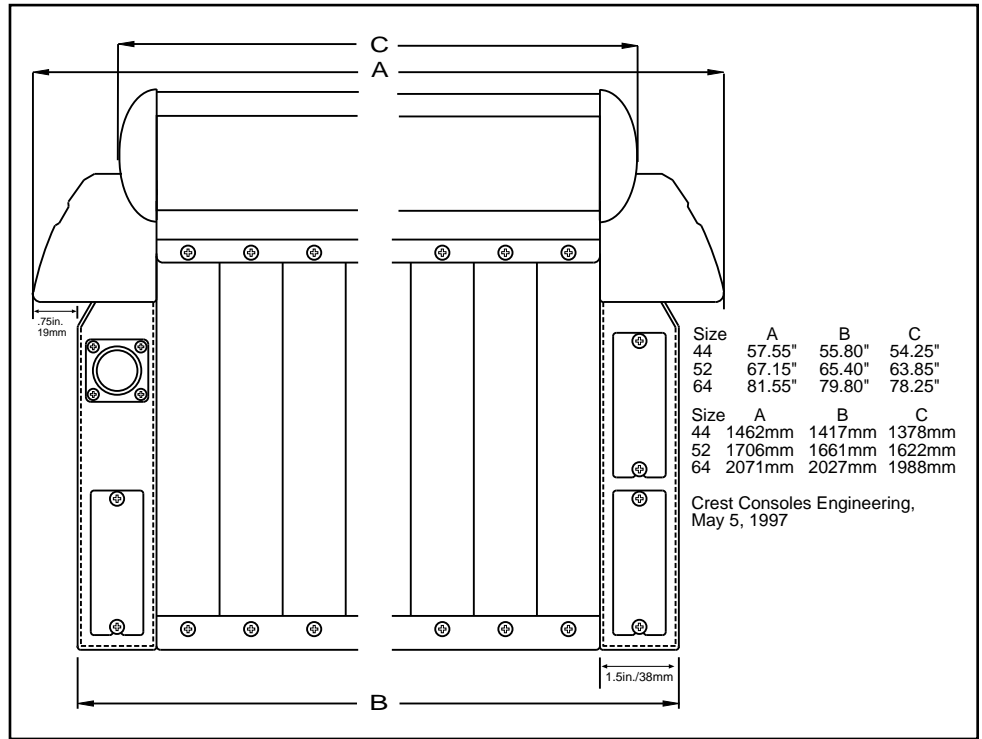
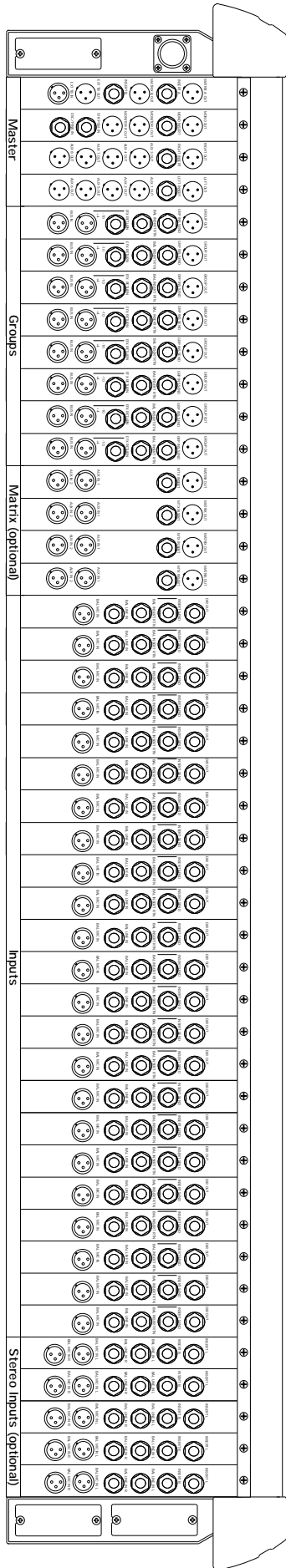

## GTx USER-OPTIONS

GTx consoles are shipped having standard configuration unless specified at time of order. These are ways that the console configuration may be varied after manufacture. The items listed are internal options selected by gold jumper links.

Default is marked with a line on the board and is usually pins 1&2 of the three pin header.

In addition there are links for module function assignment. Take care to not disturb these when using USER OPTION links.

<u>MODULE</u>	<u>LOCATION</u>	<u>OPTION TITLE</u>	<u>FUNCTION</u>
	M = Main board C = Connector		(Shipped with the option underlined)
All Inputs	M M M	Pre Source (SRC)Mute Pre Source Select Input Meter Source	Aux sends <u>with</u> or without Mute Pre & <u>Post</u> EQ Preamp, <u>Prefader</u> , Postfader
Left/Right Out Mono Output	M M	J8, Aux local Mute Matrix Post Mute? Y/N	Fit links to enable Aux local mutes Send Mono Post Mute <u>Y</u> /N
Monitor Master	C	Talkback Phantom Power	<u>On</u> or Off
<b>Optional modules</b>			
GTx Stereo In	C M M M M M	Polarity Reverse J2, L Pre source J3, R Pre source J4, Aux Pre Mute ? Switch 1 Aux 1-4 Select Switch 2 Aux 5-6 Select	L only or <u>L+R</u> Pre EQ or <u>Prefader</u> Pre EQ or <u>Prefader</u> <u>Yes</u> or No ? source: Mono sum or <u>Stereo</u> source always Mono sum, (overrides user switch 'Aux Stereo', Aux 5 & 6 )
Matrix Module	M	Cue (PFL switch)	<u>PFL</u> or AFL



### IMPORTANT



Group, Left and Right modules are pre-assigned at the Crest factory

These modules must always be installed in the correct positions. They are NOT interchangeable without being properly re-assigned. Please contact the Crest Audio Service Department for more information.

## Console Disassembly

Though you shouldn't have to disassemble the console, it is necessary to remove modules to change the jumper and switch settings associated with the internally selectable options. The following steps detail the tasks involved when taking the console apart.

### ONE • Open the armrest.

To properly remove one or many modules, the black painted armrest must first be opened. To do this, the two thumb-screws (see diagram at right) must be loosened from below. Once these screws are loose, slide both of them a few inches to the side (they will only move in one direction). Once the screws have been moved the armrest will easily roll back exposing the module screws beneath.

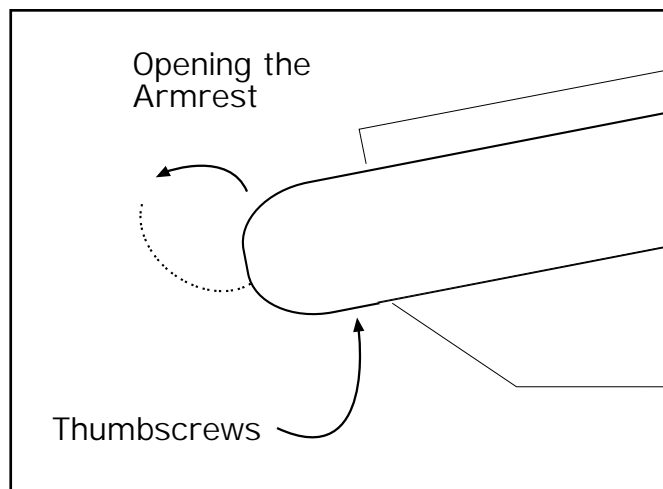

### TWO • Remove front module screw

Once the armrest has been opened, there will be a single screw at the front edge of the module panel holding each module in place. Remove the screw from the module(s) you want to remove.

### THREE • Remove rear screws

On the back panel of the console there are two screws holding each module in place (see diagram at right) Remove both screws from each module you wish to remove.

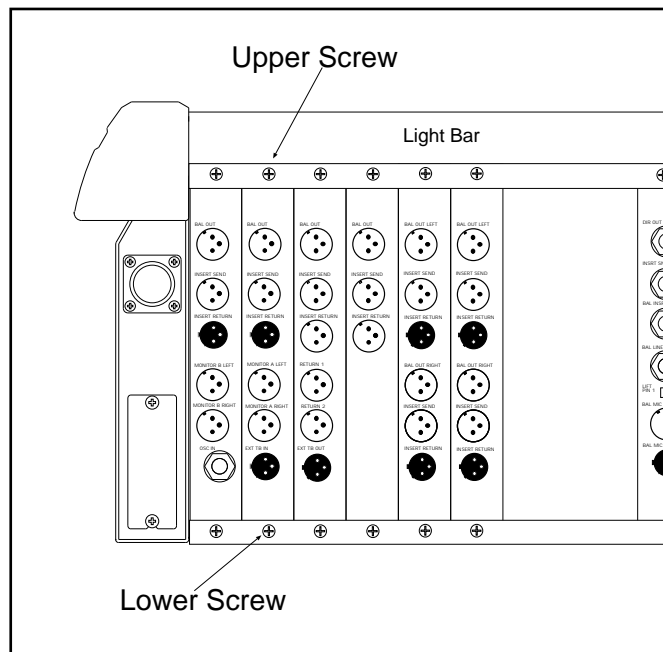

### FOUR • Lift the module(s) out

As you lift the module out of the chassis three wires must be detached before the module can be completely removed: 2 flat-wires (ribbon cables) and one ground wire.

The flat-wires are removed by flipping the latches on the ends of the connectors. Once the tabs have been flipped the connector should pull off easily.

The ground wire (green) is a spade lug which pulls off.

### FIVE • Putting it all back together

Re-assembling a Century Series console is as easy as taking it apart, but only if you know where everything goes. If you are going to be removing a number of modules, consider replacing the first before removing the second. Reversing the above steps should result in the console being as well put together as it was when it left the factory.



#### IMPORTANT



Group, Left, and Right modules are pre-assigned at the Crest factory

These modules must always be installed in the correct positions. They are NOT interchangeable without being properly re-assigned. Please contact the Crest Audio Service Department for more information.





GTx

Appendix B

Glossary

## Glossary

**100mm Fader** See *Fader*

### 48 Volt Phantom Power

This switch turns on the +48V DC used to power some microphones. Always operate the 48V Phantom Power switch with the input channel muted. See XLR Microphone Input for more information.

### 5-Segment LED Array (Input Meter)

This LED array (located next to each input module fader) provides visual monitoring of the input module signal, post EQ, pre fader. (On the GTx Stereo Input module, there are two 5-segment LED arrays.) There are three green LED's (SIGnal present, -6, 0) one yellow LED (+8) and one red LED (PK 'peak' LED). Under normal operation with proper gain setup, the LED array should indicate a level between -6 and +8. When monitoring drum or percussion-type signals, occasional illumination of the red PK LED is generally acceptable.

In encountering distortion or feedback, this array is handy when attempting to isolate the source of any problems that may exist. If the module's GAIN pot is turned all the way down, and distortion is still present (indicated by steadily lit red PK LED), check to see if the PAD switch is pushed down.

Channels which are feeding back show a higher and steadier meter level. Peak LED on all the time = an overloaded channel. Use the PAD switch when a gain pot is already at minimum.

### 2-Segment LED Signal Indicators

This LED array provides simple in-module visual monitoring of the Group, Matrix, and Master module signals. The green LED is the 'signal present' indicator, and the red LED is the 'peak' LED. The 'peak' LED also doubles as a PFL-on indicator. Signal is sampled pre and post fader to reveal any source of overload.

### Adjustable Hi Pass Filter

This input module control (actually two controls: a rotary pot to adjust frequency, and the on/off HPF switch) permits the exclusion of all signals below the dialed-in frequency. An associated yellow LED is illuminated when the HPF switch is down. the rotary pot adjusts the Hi Pass frequency from 20 to 400 Hz, with a slope/roll off of 12 dB per octave. This is useful in dealing with unwanted 'rumble', often encountered in live mixing as a result of microphone movement or bumping. On the GTx Stereo Input module, the Hi Pass Filter acts upon both channels.

### AFL (After-Fader-Listen)

See SOLO

### Aux Meters

Located on the GTx 64-frame and 52 frame meter bridges, these VU-type meters indicate the 8 Aux output levels. On the GTx 44 frame model, Aux monitoring is accomplished via the Solo (AFL) circuit.

### Auxiliary Pre/Post Switches

Configured in three groups (1-4, 5-6, 7-8) these switches permit the associated Aux sends to be either pre-fader or post-fader. A typical application would be to use one group of aux

sends pre-fader as monitor sends, and to use another group post-fader as effects sends. Note that if the Aux 8 Direct switch is pushed, the Aux 8 send will be a pre-fader direct out send, regardless of the Aux 7&8 Pre/Post switch selection. Pre-fader aux sends may be affected by the MUTE switch. Refer to User Options.

### Auxiliary 8 Direct Switch

This switch disconnects the Aux 8 level control from the Aux 8 mix bus and instead is used to control the Direct Output of the channel. Normally the Direct Out jack is post-fader. When the Aux 8 Direct switch is pressed, the Aux 8 level control assumes output control of the direct out signal, and the Aux 8 control is fed pre-fader.

### Auxiliary Bus 1-8

The Aux bus carries signal from the Aux Send controls to the Aux outputs on the rear panel of the Master Section. A typical setup would entail using the Aux 1-4 sends for monitor mixes while Aux 5-8 are used for effect sends. If a separate monitor mixer were being used, Auxes 1-4 could be used for additional effect sends. Effects can be returned via the EFX Return section of the group modules or through spare input modules.

### Auxiliary Master Mute Switch

Enables the four Aux Send Mutes. Associated LED indicates selection.

### Auxiliary Mute Switches

The Master Section of the GTx consoles has mute switches for each Aux output. When pressed, this switch mutes the corresponding Aux Send Master. When the mute is engaged no signal leaves the associated Aux out jack and a red LED illuminates to the left of the switch. These mute switches are active only if the Aux Mute Master switch on the Master module is pressed.

### Auxiliary Send Controls

The GTx console employs eight discrete Aux Sends per input channel which send signal to the Aux bus. These sends are controlled via the eight level controls on each input module. Aux Sends 1-4 (orange colored, dual concentric) are typically used for monitor sends. Aux Sends 5-8 (green) are typically used for effect sends. Each effect return section has Aux 1-4 Send controls, which could be used for adding effect return signal to the monitor mix.

### Balanced Insert Return Jacks (Group Module)

See GROUP INSERT SEND/BALANCED INSERT RETURN JACKS.

### Balanced Insert Return Jacks (Input Module)

See INSERT SEND/BALANCED INSERT RETURN JACKS.

### Blend to L/R Mixes

Permits 'blending' of the Left & Right signals to Auxes 1&2 and/or Auxes 3&4. Two controls are provided: Rotary level control, & two push buttons to select Auxes 1&2 and/or Auxes 3&4. The Blend feature is useful when it is necessary to send the Left & Right bus signals to monitor mixes or remote feeds.

## Bus Assignment Switches

Wherever these switches occur, they connect signals to any or all of the following buses: Group buses, even/odd Group buses, Left bus, Center (Mono) bus, and Right bus. The following list shows the various Bus Assignment switches and their effect upon bus assignment:

M - Signal is sent to the Center (Mono) Bus.

LR - Signal is sent to the Left and Right Buses, via pan.

LCR - Configures Left/Right and Center/Mono assignments for L-C-R panning. To enable L-C-R panning, L-R and Mono assign switches must be down.

PAN Switch / Group Assign Switches (1-8) - With PAN switch down, the PAN control varies the level of the group assignments with odd numbered groups on the left and even numbered groups on the right. With PAN switch up, groups can be individually selected and are unaffected by the PAN control. Group assign switches route signals to the Group buses.

It is a common practice to assign all effect return channels to a group module. This enables the overall amount of effect signal to be controlled from a single fader location. It is then possible to turn off the effects with this group fader or group mute switch or to vary the amount of overall effect return in reference to the dry original signals, using the group fader control.

## CENTER Meter

Located on the meter bridge, this VU-type meter indicates signal level sent to the Center (Mono) bus.

## DC Power Indicators

Each Century Series console uses a variety of electrical voltages which are fed to the console from the power supply. The status of each operating voltage (+20, -20, +48, +24) is indicated by four LED's on the master module. If the console ever behaves abnormally, first check these LED's to make sure that the power supply is providing the proper voltages.

## Dim Switch

This GTx Master Section switch produces a -12dB attenuation in signal to the local monitor. This feature is useful for temporary lowering of local monitor levels without actually adjusting any pots or faders.

## Direct Out Jack

Each input module has an unbalanced 1/4" direct out jack. The output from this jack is post-fader unless the AUXILIARY 8 DIRECT switch is pressed. When this switch is down the output is controlled by the Aux 8 pot. See AUXILIARY 8 DIRECT SWITCH for more information.

## Effect Return EQ

Located in the GTx Master section, each effect return section has a two-band fixed EQ. These High and Low frequency controls are centered at 10kHz and 80Hz respectively. Center position is flat.

## Effect Return Gain

Located in the GTx Master section, this control adjusts the gain on the signal returning from the effect. Use the effect return signal present and peak LED's to set the gain properly.

## Effect Return Subgroup Assignments

These switches assign the corresponding effect return to any or all subgroups. See BUS ASSIGNMENT SWITCHES for more information.

## EQ In Switch

This GTx input module (and stereo input module) switch, when pressed, inserts the EQ section into the signal path and illuminates a green LED to the left of the switch. With the switch in the up position, the input signal bypasses the EQ section and continues unmodified.

## EQ Sections

These controls are used to modify the tonal quality of an audio signal. Within the input modules, the EQ section will affect the signal only if the EQ IN button is pressed.

The GTx standard input module has a four-band sweep EQ section, including concentric adjustment of frequency and boost/cut, selectable peak/shelving EQ on the high and low frequency bands, and selectable Q on the two middle frequency bands, switchable between .8 (Q switch up) and 1.8 (Q switch down).

The GTx stereo input module has a three-band sweep EQ section, with individual controls within each band for adjustment of frequency and boost/cut.

The effect return sections, within the group modules, have two-band EQ sections, with fixed EQ controls.

## External Talkback Inputs

Located at the top of the GTx Master section and under the front right console armrest, the External Talkback Inputs permit connection of talkback microphones to be used with talkback functions. Only one microphone should be connected; using both inputs at once is not recommended. *Note: the internal jumper default for this input is +48V DC!*

## External Talkback Input Switch

Located in the Talkback Control section (Master Section), this switch disconnects the two regular talkback microphone inputs and switches on the external talkback input XLR found on the rear panel of the GTx master section. *Note: the Talkback Control Button must be on for this switch to function.*

## External Talkback Output Switch

Located in the Talkback Control section (Master Section), this switch activates the external talkback output XLR. The signal fed to the connector is the same signal being sent to the talkback assignments. *Note: the Talkback Control Button must be on for this switch to function.*

## Fader

The fader is used for primary level control of the channel, except those Aux output sections selected to a pre-fader position. (The Insert send level is not affected by the fader position.) Optimum noise performance is achieved when the fader is operated near the 0 fader position, with pad switches and all gain controls properly set. This does not mean that all channels should be set at 0. Proper mixing requires varying of at least some of the faders. The 0 point should be considered a reference, with all volume changes taking place between the -10 and +10 reference points at normal desired levels. For effect, faders may be operated below this level, provided no faders within the group or master section are increased in level to compensate for the input's lower fader setting. (See also FADER REVERSE SWITCH).

## Fader Reverse Switch

This switch swaps roles between the Effect Return Level pot and the Group Fader. When pressed, this switch causes the Effect Return Level to be controlled by the group fader, and the group level to be controlled by the Effect Return Level pot. If you want fader control when setting effect returns, this switch is particularly helpful. A red LED indicator is provided to the left of the switch and illuminates when the switch is pressed (reverse mode).

## Gain Control

This knob (-20 to 70 dB) adjusts input gain circuitry for proper electrical operation with any input signal level. Adjust this control by monitoring the input meter LED's for bright intensity, with peak (red) LED flashing only occasionally when the loudest program material is present. When using this method for adjustment of the Gain Control, normal signal level should be adjusted to show a level between -6 and +8. Constant distortion on an input channel could mean that the input channel is being overdriven. Check for improper input gain adjustment first. (When a PFL switch is pressed on an input channel, this signal can also be observed on the Left/Right Solo monitor meters within the GTx meter bridge.)

## Ground

Console chassis and audio ground are connected together. The console power supply includes an external link that connects console ground to AC power ground. This link is provided for user selection when optimizing system ground requirements.

## Group Assignment

(See Bus Assignment)

## Group Insert Send/Balanced Insert Return Jacks (Group Module)

These jacks allow you to access a point in the group module's electrical circuit for inserting an external signal processor. The output level of this connector is designed to drive the inputs of most external signal processing equipment and to accept the resulting output signal. When properly wired TRS plugs are inserted in these jacks, the patched devices are inserted into the signal path immediately pre-fader. See the Connections and Conventions section in the front of the manual for specific information on plug polarity and signal assignments.

## Group Meters 1-8

Located within the meter bridge, these VU-type meters monitor the post-fader output of the groups. Similar meters on the Master Section monitor Left, Center (Mono) and Right outputs. 0 Level = +4dBu output level.

## Headphone Jacks

Located at the top of the master section and under the right side of the arm rest, these jacks provide a stereo headphone level output of the Left, Center (Mono), and Right outputs. When L-C-R panning is enabled, the Center Bus will not be audible in the headphones; the Center Bus must be PFL'd to monitor it audibly.

## Headphone Level Control

This control (marked PHONES and located in the upper right

Master section) adjusts the level of the signal fed to the two headphone jacks; one of these jacks is located next to the PHONES control, and another is just below the armrest on the far right side.

## HF Peak/Shelve Switch

This switch is used for switching the high frequency EQ control between the normal shelving setting to a peak setting. A shelving setting would be used to boost or cut all frequencies *above* the dialed-in frequency. A peak setting would be used to boost or cut the *specific* dialed-in frequency.

## High Pass Filter (Adjustable)

See ADJUSTABLE HIGH PASS FILTER

## Insert Send/Balanced Insert Return Jacks (Input Module)

These jacks allow you to access a point in the channel's electrical circuit for inserting an external signal processor. The output level of the Insert Send jack is designed to drive the inputs of most external signal processing equipment and to accept the resulting output signal. When a properly wired TRS plug is inserted in these jacks and the Insert switch is down, the input signal path is broken after the gain stage and the high pass filter. The Balanced Insert Return jack feeds the return signal to a point just before the EQ section. See the Connections and Conventions section in the front of the manual for specific information on plug polarity and signal assignments. (With the Insert switch down, the insert return jack may be used as a line level input to the channel that bypasses the mic preamp, mic/line switch, pad, gain control, and hi pass filter.)

## Insert Switch w/LED

This switch, located on the GTX Input (and GTX Stereo Input) modules, introduces into the signal path any processing that is patched into the Insert Send and Balanced Insert Return jacks on the rear panel. An associated green LED is illuminated when the Insert switch is down.

## Internal Oscillator

The GTx master section has a 1 kHz internal oscillator. This oscillator can be used as signal source to run tests, diagnostics or calibrations. The oscillator can be assigned to all Groups, Auxes and Matrices via the Talkback assignment switches.

## Lamp Dim Control

This control adjusts the brightness of whatever lighting devices are plugged into the XLR sockets on the meter bridge. (Standard 12V DC power is provided on pins 2 & 3).

## L-C-R Switch

Provides true L-C-R pan to the main mix outputs. When this switch is released, the pan operates on L&R in the normal fashion. See also PAN CONTROL.

## Left Meter

Located on the GTx meter bridge, this VU-type meter indicates the Left output level, post fader.

## LF Peak/Shelve Switch

This switch is used for switching the low frequency EQ control between the normal shelving setting and a peak setting. A shelving setting would be used to boost or cut all frequencies

below the dialed-in frequency. A peak setting would be used to boost or cut the *specific* dialed-in frequency.

## Line Input Jack

This is a balanced, high impedance input which is designed to accept both balanced and unbalanced line level inputs. To select this input source, press the front panel LINE switch. See the Connections and Conventions section for specific information on plug polarity and signal assignments.

## Line Switch

This switch, when pressed, selects the balanced Line Input as opposed to the default balanced XLR Mic input.

## Local Monitor Level Control

This control adjusts the level of the signal to the Local Monitor Outputs on the back of the Master Section. Note that the DIM switch can be used to introduce a -12 dB attenuation to the local monitor.

## Matrix AFL

See SOLO

## Matrix Level Control

These controls adjust the amount of group, L, R or Mono signal fed to the respective matrix.

## Matrix Master Control

These controls adjust the final signal level for the associated matrix output.

## Matrix Post Switch

This button switches the group, L, R or Mono matrix send between pre and post fader. Up position is pre.

## Meter Bridge

The GTx 52 and 64-frame consoles include 21 mechanical moving-magnet type indicators (44 frame: 13 meters) which show the output levels. These indicators are VU-type and are calibrated during manufacturing to 0 = +4dBu, 1.23V RMS 1kHz. The VU-type characteristic averages the signal level over short time periods (about 300mSec) so that the 'beat' is visible. Short duration peaks (snare drum and other signals with similar transient peaks) are under-indicated. Meters are illuminated by amber LED's which do not require attention or adjustment.

When faders are set a '0' calibration positions, then the optimum signal to noise and overload margin conditions are obtained. In this situation, signal peaks up to +3 are usually undistorted. The recommended normal range is between -10 and 0; operation with channel and output levels below -10 is not recommended - headroom is wasted at the expense of signal-to-noise ratio. The solo L - R meter pair shows the PFL or AFL level of the selected source. When no PFL or AFL is selected, the headphone and monitor output is the main stereo output. The solo meter is inactive when no PFL or AFL is selected. For GTx Level Meter calibration information, consult the GTx Service Manual or your Crest Audio dealer/service center. (The range of meter adjustment is approximately +1 / -1dB.)

## Mono Bus Assign Switch

Assigns signal directly to the Mono (Center) bus. This signal is unaffected by the position of the Pan Control, unless L-C-R panning is enabled. (See BUS ASSIGNMENT for more L-C-R information). This is useful when it is necessary to add input signal to the Mono mix without going through the Stereo section of the mixer. (An example would be a center vocal cluster configuration). In addition to the many mono output uses, this output could be used as an additional send.

## Mute Switch

Turns off all send/output functions (except insert send) of the associated module including those being used as monitors. This switch does not affect the PFL switch or the LED indicators, enabling monitoring of input channel activity regardless of mute switch position. The mute LED illuminates when the channel is muted, either from the local mute switch or from any activated mute group. When muting a group, the group meter (on the meter bridge) level will reflect the muting. Note: the Mute switch may not affect pre signals, depending on internal jumper settings. Refer to User Options.

## Oscillator/Pink In Connector

This connector accepts a balanced or unbalanced signal from an oscillator or pink noise generator. This signal is assignable via the talkback assignment switches. Plugging into this jack disables the internal 1kHz oscillator.

## PAD Switch

This -15dB pad (-20dB on Stereo Input module) attenuates the signal presented to the first stage of the input module. It is important to note that the Pad Switch acts only upon the balanced XLR input signal; it has no effect upon the 1/4" input signal. The input GAIN control should be positioned somewhere within its center 80% of travel. In the event that the Gain control is set in its lower 10% of travel, and the Peak LED is indicating more than an occasional short illumination, the PAD Switch should be pressed and the Gain re-adjusted as above. In the case where the GAIN control is set to its upper range of travel (3 o'clock position or above) with the PAD switch pressed, the Gain Control should initially be lowered and the PAD switch released. The gain should then be increased and adjusted as above.

## Pan Control

Pan Control is a dual device having two functions. *Main Mix Pan* operates with Left/Right/Mono assigns. When LCR is selected, then true LCR panning is provided. Otherwise, L-R panning is provided. *Group Pan* operates with the 1-8 group assigns. When PAN is selected, the odd-even assign panning is provided.

With LEFT, RIGHT, and MONO assign switches down, and LCR switch up, LEFT and RIGHT assign signals are proportionally varied by the PAN control, with LEFT and RIGHT signals being equal in level when PAN is in the center. The MONO assign signal is unaffected by the PAN control.

With LEFT, RIGHT, and MONO assign switches down and the LCR switch down, the LEFT and RIGHT assign signals decrease in level as the PAN control is rotated to its center position. The PAN control also governs the post fader MONO

assign level, providing maximum level when in the center position and continuously decreasing in level when turned to the left or right. This makes true LEFT-CENTER-RIGHT (L-C-R) panning possible. (See also BUS ASSIGNMENT, PAN Switch)

### PAN Switch

With the PAN switch up, groups can be individually selected and are unaffected by the PAN control. With PAN switch down, the PAN control varies the level of the group assignments with odd numbered groups on the left and even numbered groups on the right.

### PEAK LED

See 5-SEGMENT LED ARRAY

### PFL (Pre-Fader Listen)

See SOLO

### Phantom Power

See 48V PHANTOM POWER

### Phase

All console connections are in phase with each other, including insertion sends & returns. XLR pin 2 and jack tip are the positive (+) phase connectors.

### Polarity Reverse Switch

This post insert return, pre-EQ switch reverses the phase of the line and microphone input signals in the GTx input modules (on the stereo input module, this switch acts upon one channel only). This feature can be used to adjust phase cancellation between microphones when more than one microphone is picking up the same acoustical signal. See also User Options.

### Pre/Post (Aux) Fader Switches

Switches the Aux signal sources between pre-fader and post-fader positions. The pre-fader position is usually used for monitor sends, so that any movement of fader level does not affect these outputs. When in the post-fader position, signal output level from the Aux sends will proportionally follow the main signal level. The result is maintenance of an effect in proportion to the main signal level. When an input signal is faded to 0dB, the post-fader Aux Send signals are also decreased to 0dB. In some cases, it may be desirable to derive effect sends pre-fader for special effects, such as those generated by a vocal doubler or harmonizer. The choice of switch position should be determined by the actual situation; though as a general rule, choose the pre-fader position for monitor sends and post-fader position for effect sends.

### Q SWITCH (Hi Mid & Lo Mid EQ)

See EQ SECTIONS

### RETURN JACK

(See INSERT/RETURN JACKS)

### Right Meter

Located on the GTx meter bridge, this VU-type meter indicates the Right output level, post fader.

## Scene Mute Assignment Switches

On input modules, the scene mute switches assign the *input* to one or more of the master scene mutes. On the group modules, the scene mute switches assign the *Effects Return* to one or more of the master scene mutes. These mutes are activated via the scene mute master switches found on the master section. Any combination of mutes is allowed.

## Scene Mute Master Switches

Found on the GTx Master Section, these switches activate/deactivate the four scene mutes. Associated red LED's indicate status.

## Scene Mute Safe Switch w/LED

This switch, found on input and group modules beneath the Scene Mute Assignment Switches, disables any selected scene mutes, and is generally used to prevent accidental channel muting. A green LED indicates that the Safe switch has been engaged.

## Signal Present LED's

See 5-SEGMENT LED ARRAY

## SOLO LEFT/SOLO RIGHT Meters

Located on the GTx meter bridge, these VU-type meters indicate PFL/AFL signal level. Inherently, they also reflect the headphone signal level. When PFL or AFL is engaged anywhere on the console, the SOLO LEFT and SOLO RIGHT level meters go from being dimly lit to being the same brightness as the other level meters.

## Soloing (PFL/AFL)

Both methods of soloing allow for monitoring within the master section of the console

When soloing input channels, optional matrix inputs, groups and main outputs, monitoring is done pre-fader, or PFL. The PFL (Pre Fader Listen) switch enables the operator to listen to channel signals before the fader or main channel level control (PFL). This signal IS NOT affected by the Channel Mute Switch.

When soloing Matrix Masters or Aux sends, monitoring is done after-fader (AFL); the associated AFL (After Fader Listen) switches enable the operator to listen to Matrix Master and AUX signals after the rotary Matrix Master /Aux level controls. When soloing a single Matrix Master or Aux signal individually, monitoring is done in 'mono'; when soloing more than one Matrix Master or Aux signal, solo monitoring will be heard as a stereo 'split', odd on left, even on right.

When either an AFL or PFL switch is pressed, the solo signal level can be seen on the Solo Left/Right meters, and can be heard both in the mixer's headphone output and on the rear panel monitor output of the console.

When PFL or AFL is engaged anywhere on the console, the SOLO LEFT and SOLO RIGHT level meters go from being dimly lit to being the same brightness as the other level meters, and two red LED's on the console panel illuminate.

## Stereo Program In

The Stereo Program In section (on the GTx Master section) controls the way in which the Stereo Program In signal is routed through the console. Controls for gain, HF/LF EQ, bus assignment (Mono, L/R, Aux 1/2, Aux 3/4, and Matrix A/B buses), balance, level, muting, and PFL are included. Red Peak and green Signal Present LED's are located next to the PFL switch.

## Stereo Program In Connector

This 1/4-inch jack, usually used for stereo program music, accepts an unbalanced stereo line level signal. Polarity is as follows: Tip=Left, Ring=R, Sleeve=Ground

## Talkback Assignment Switches

These switches assign the talkback signal to the outputs and/or auxes. Switches exist for External Talkback Output, Mono (Center) Bus, Left/Right Buses, Groups, Auxes 1-8 (in pairs), and Matrices A and B. The same routes are also used when the oscillator is selected. This overrides the talkback source.

## Talkback Level Control

This knob controls the final level of the talkback signal.

## Talkback Microphone Input

Found on the top of the master section and under the arm rest on the right side, these balanced XLR inputs allow for a microphone or other balanced mic-level source to be connected to the talkback system. Default for this connector is +48V DC. It is advised to connect only one talkback microphone at a time.

## Talkback Enable Switch

This switch activates the entire talkback system including the internal oscillator.

## XLR Balanced Outputs

These outputs are designed to drive both balanced and unbalanced input devices without adaptation. Signals are normally balanced on this output connector. The output will drive all load impedances from 600 ohms upwards with full performance specifications. The output is designed so that if either pin 2 or pin 3 were intentionally shorted (as in connecting to an unbalanced input of your next stage of electronics) or accidentally shorted, the output level of the non-shortened connector pin increases by 6db. This is an amount equal to the normal loss of a balanced output when one pin of a balanced output is shorted. The result is no need for external gain make up.

## XLR Microphone Input Connector

Balanced XLR Input is designed to receive professional Low Impedance microphone signals. The input Gain controls on the front panel adjust for most input levels. In the event of excessive input levels, the front panel input pad switch should be pressed. Front panel selection of 48 Volt Phantom power enables most types of condenser microphones that require such power to be used. See your device's operating manual for correct operation. (If in doubt that your non-condenser microphone may be damaged by using Phantom Power, please make sure that the front panel phantom power switch on that input channel is in the off [out] position. Operate this switch with the channel muted to avoid sending 'thumps' to your speakers.)

This input may also be used for low level line input signals, provided the source (instrument) is able to drive a 5k Ohm or higher load. (See your instruments or electronics owner's manual for output impedance.) When line output devices such as tape players are plugged into the microphone input, special care should be observed that the phantom power is turned off on that channel, as damage may result. Because of this, it is recommended that the 1/4" line input connector be used when connecting a line level device. 48 Volt Phantom power is not present on these input connectors, and the impedance of the line input connector is high enough to accept any line level device.







# Appendix C

## Schematics

SCHEMATIC NAME	#	NOTES
MODULES		
STANDARD INPUT CONNECTOR PCB	1	GTx INPUT CONNECTOR PCB
STANDARD INPUT MAIN PCB	2	GTx INPUT MAIN PCB
LCR SUB PCB	3	LCRSUB01 GTx LCR SUB PCB
STEREO INPUT CONNECTOR PCB	4	GTx STEREO INPUT CONNECTOR PCB
STEREO INPUT MAIN PCB	5	GTx STEREO INPUT MAIN PCB
GROUP CONNECTOR PCB	6	GTx GROUP CONNECTOR PCB
GROUP MAIN PCB	7	GTx GROUP MAIN PCB
L / R CONNECTOR PCB	8	GTx LEFT/RIGHT CONNECTOR PCB
L / R MAIN PCB	9	GTx LEFT/RIGHT MAIN PCB
MONO CONNECTOR PCB	10	GTx MONO CONNECTOR PCB
MONO MAIN PCB	11	GTx MONO MAIN PCB
MASTER CONTROL CONNECTOR PCB	12	GTx MASTER CONNECTOR PCB
MASTER CONTROL MAIN PCB	13	GTx MASTER CONNECTOR PCB
MATRIX CONNECTOR PCB	14	GTx MATRIX CONNECTOR PCB
MATRIX MAIN PCB	15	GTx MATRIX MAIN PCB
METER BRIDGE		Vx/GTx Power-Dimmer-Demux PCB:
DIM-MUX1	16	DIMMER CIRCUIT
DIM-MUX2	17	POWER - DIMMER CIRCUIT
MTRDMUX1	18	METER DEMUX
MTRINTR1	19	METER DRIVER BOARD
GROUP / AUX METER PCB	20	GTx/Vx GROUP/AUX METER LED PCB
MST-LED1	21	GTx/Vx MASTER METERS LED PCB
POWER SUPPLY		
FRONT MODULE / LED PCB	22	PSU1 FRONT MODULE
REAR MODULE PCB	23	PSU2 REAR POWER MODULE PCB
CHASSIS WIRING	24	PSPLYBLK
CENTURY POWER SUPPLY TRANSFORMER	25	WIRING OPTIONS FOR 100/120, 220, 240V

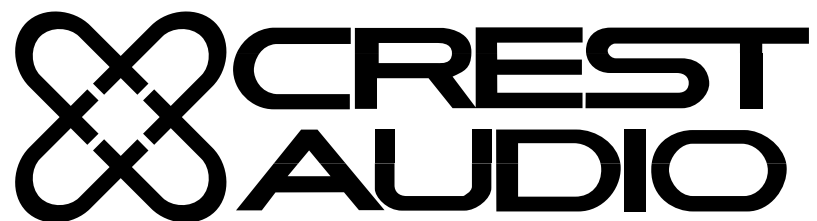

**Crest Audio Inc.**

100 Eisenhower Dr., Paramus NJ 07652 USA

TEL: 201.909.8700 FAX: 201.909.8744

<http://www.crestaudio.com>

Printed in USA



\*D7000003\*

GTx Owner's Manual  
Copyright © 1997 Crest Audio Inc.  
v 2.3 11/3/97 D7000003