



# CENTURY SERIES

---



OWNER'S MANUAL



Congratulations on your purchase of a Century Series console. All of us at Crest Audio in Paramus, New Jersey, USA, support your decision, knowing your console contains the finest combination of design and manufacture in the industry.

While your new Century Series console is one of the most feature-packed available, great effort has been put into making it simple to operate.

This manual explains the functions of your new console, how they operate and how they relate to each other. If properly cared for, your new console will provide you with trouble-free, sonically accurate mixing clear into the next Century and beyond.

Please keep the following contact information on hand:

Crest Audio Customer Service Dept.  
100 Eisenhower Drive  
Paramus NJ 07652 USA  
tel 201.909.8700 fax 201.909.8744  
<http://www.crestaudio.com>

**Crest Audio Inc.**  
100 Eisenhower Dr., Paramus NJ 07652 USA  
TEL: 201.909.8700 FAX: 201.909.8744  
<http://www.crestaudio.com>

Printed in USA

# TABLE OF CONTENTS

---

LMx	Feature Overview	2
	A brief description of the LMx design, features and functions.	
LMx	System Connections	3
	Contains diagrams illustrating conventional system connections.	
LMx	Wiring Conventions	5
	Contains diagrams indicating how connectors for Crest consoles are wired.	
LMx	Power Supply	6
	A brief description of the rack-mountable Century Series consoles power supply.	
LMx	Power Connections	7
	A brief description of Crest console power connections.	
LMx	Console Cooling	7
	A brief description of the dual-fan cooling setup.	
LMx	Input Module	8
	Profiles the LMx input module. The module and rear panel are illustrated and described.	
LMx	Group Module	10
	Profiles the LMx group module. The module and rear panel are illustrated, and described.	
LMx	Stereo 21R/22L Module	12
	Profiles the LMx console stereo 21R/22L module. The module and rear panel are illustrated, and described.	
LMx	Master Module	14
	Profiles the LMx console master module. The module and rear panel are illustrated, and described.	
LMx	Meter Bridge	16
	This section profiles the LMx meter bridge. Each type of meter is illustrated and described.	
LMx	Operation	18
	Describes special features: Global Level/Pan, Solo system, Monitor outputs, Stereo Input, Channel Input Mic split, Line Inputs, Sub-grouping.	
LMx	Technical Information	Appendix A
	Includes dimensions, specifications, console access details, user options, console block diagram, and rear panel layout.	
LMx	Glossary	Appendix B
	The specific details of console operation are described here, alphabetically.	
LMx	Schematics	Appendix C
	Lists available LMx console and power supply schematics.	

## Feature Overview

- **SSM/PMI High quality devices on balanced microphone/line inputs and on all outputs** for uncompromised audio quality and reliability. All IC's within the audio path are socket mounted for easy upgrade or service.
- **A signal path completely free of electrolytic capacitors;** all internal audio connections are gold plated.
- **Pad switches on XLR inputs** allow preamplifiers to accept signals from -62 to +7 dBu on mic and -44 to +10 dBu line.
- **Separate 1/4" insert send and return jacks** are provided for patching outboard equipment.
- **Passive microphone splitters** with ground lift switches on every microphone input.
- **Switchable 48 Volt phantom power** on all microphone inputs; optional transformers available on all microphone inputs and primary outputs.
- **EQ section** includes an EQ ON switch with LED and a 100Hz High Pass filter switch. Four sweepable bands (LF-40-800Hz, LMF-100Hz-2kHz, HMF-400Hz-8kHz, HF-1.5k-20kHz) are supplied with bell curves, providing full frequency control with generous overlap. The HF and LF bands are selectable between Peaking and Shelving via internal jumpers.
- **5-LED display on input modules**, logically placed next to the fader, provides accurate monitoring of pre-fader input levels.
- **Input channels have level sends for the 22 output buses**, with dual concentric controls provided for buses 1-16 and single controls for buses 18-20 and 21L/22R. These controls may function as either 11 stereo sends with level and pan, 22 discrete mono sends, or any desired combination of the two modes. Global mono or stereo configuration for each bus is determined by pushing a single button on the corresponding output module.
- **FET-controlled "soft" Mute switches on each input module**, which cut every selected send and output. Each input may be assigned to any or all of the eight Mute Groups, and assignments are clearly indicated by associated status LEDs. Engaging the Safe switch defeats the module's group mute function without changing the console setup.
- **Output EQ** - Each of the Group Output modules incorporates a dedicated stereo EQ section with three overlapping swept bands (40Hz - 1kHz, 300Hz - 8kHz, 1kHz - 20kHz), odd & even EQ In/Out switching with status LEDs, and switchable High Pass Filters with a corner frequency sweepable from 20Hz to 400Hz.
- **Input for Room Ambience Microphones** - Dedicated Stereo Mic Input section (located on the upper part of the Stereo 21L/22R output module), allows routing of room ambience microphones to in-ear monitoring systems. Includes a low-noise dual preamplifier with gain control, pad, polarity reverse switch, phantom power switch, mic/line input switch, stereo input EQ section with two overlapping swept bands, EQ in/out switching, and a 100Hz roll-off High Pass Filter.

During quieter pauses between performances, an integrated compressor-gate automatically opens the room ambience microphones. When the performance resumes, the auto-control processor gradually engages compression over a wide range, smoothly reducing ambience level in proportion to the increase in stage sound until mics are gated off at nominal performance level. All eleven output modules have individual dual concentric level controls (switchable for mono or stereo mode) to feed the Stereo Mic inputs into the Monitor outputs.

- **The L/R to Group section**, located on each Group Output module, can be used to re-matrix the 21L/22R output's mix back into any or all of the other ten stereo or twenty mono outputs. A second subgroup feature allows any or all signals on the first 20 mono/10 stereo buses to be assigned to the L/R Master module, providing the flexibility required for alternate use as an FOH console. The two subgroup modes are interlocked to prevent inadvertent feedback loops.
- **Line In** with Level controls, On/Off switching and Solo switching on each of the ten Group Output modules. The line inputs can be used as summing inputs or simple effects returns.
- **Full-size meter bridge** with large, sunlight-visible mechanical VU meters. Metering provided for all 22 output buses plus the stereo solo bus. Meters are solid state LED illuminated.
- **Master Section** provides a full bandwidth (20Hz - 20kHz) oscillator, pink noise generator, headphone output level control, monitor on/off switch, and Talkback functions. A 100mm fader is featured for main monitor level. Adjoining the fader are switches to select monitor source. Source options are either external stereo, or summing of the monitor output to mono, and selecting a mix of all input faders for routing to the monitor output.
- **A Volume Foot Pedal** (and rear panel connection jack) are provided. The foot pedal connects in series with the Monitor Output fader.
- **Comprehensive, logic-controlled Solo system.**
  - Normal and input priority modes
  - Choice of summing and 'last pressed' mode
  - Choice of PFL and AFL audio in stereo
- **52 and 64 module position frames**, constructed of pre-plated 14-gauge steel. Any frame size may be ordered short loaded for later expansion.
- **UL/CE-approved external power supply** over-designed with ample current reserves. For the ultimate in fail-safe reliability, a back-up power supply can be linked to the primary supply with only an inexpensive jumper cable. External switching is not needed.

### System Connections

Proper connection and component relationships are vital to assure accurate operation and results. The following diagrams illustrate conventional system connections.

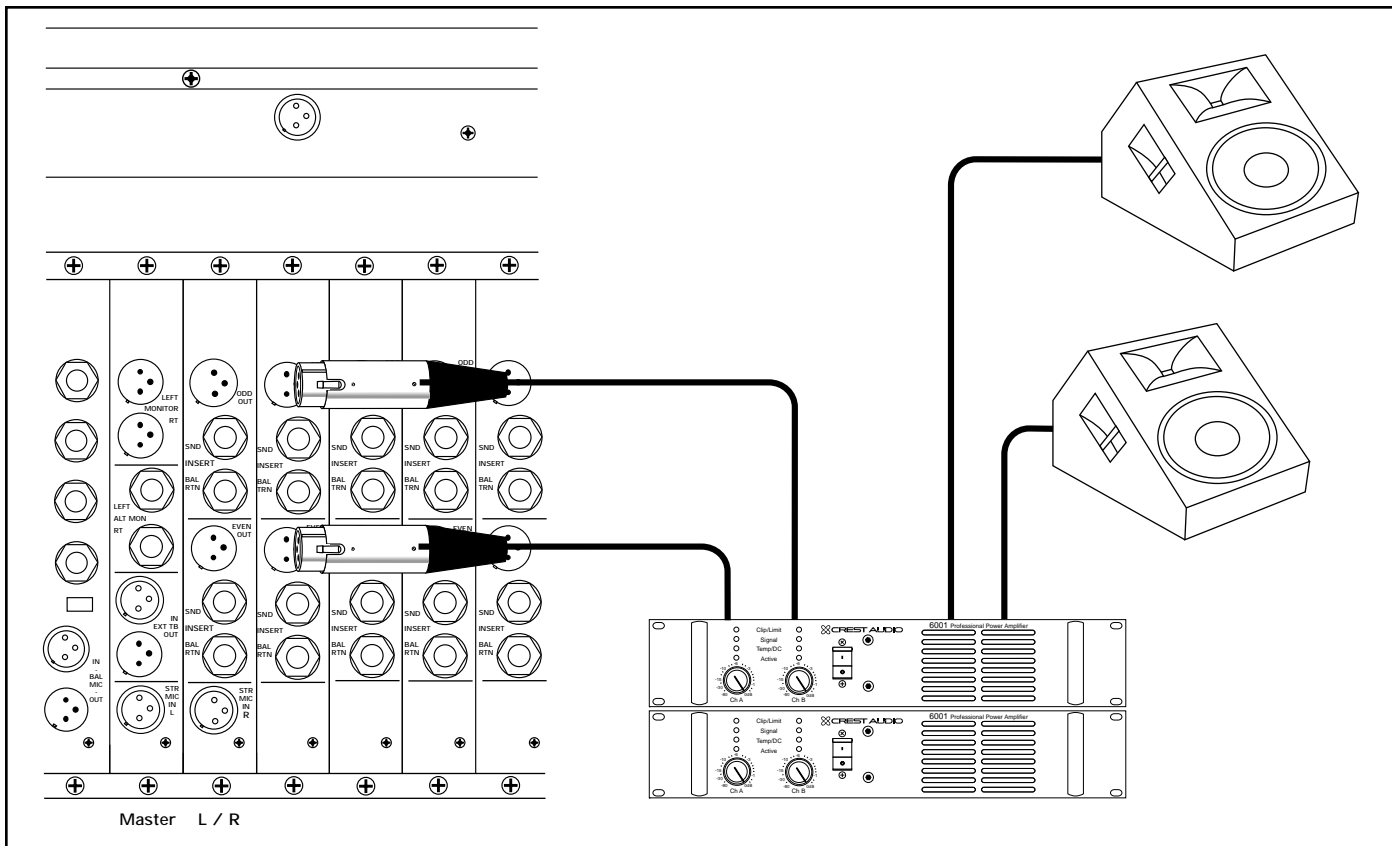

### Floor Wedge Connection

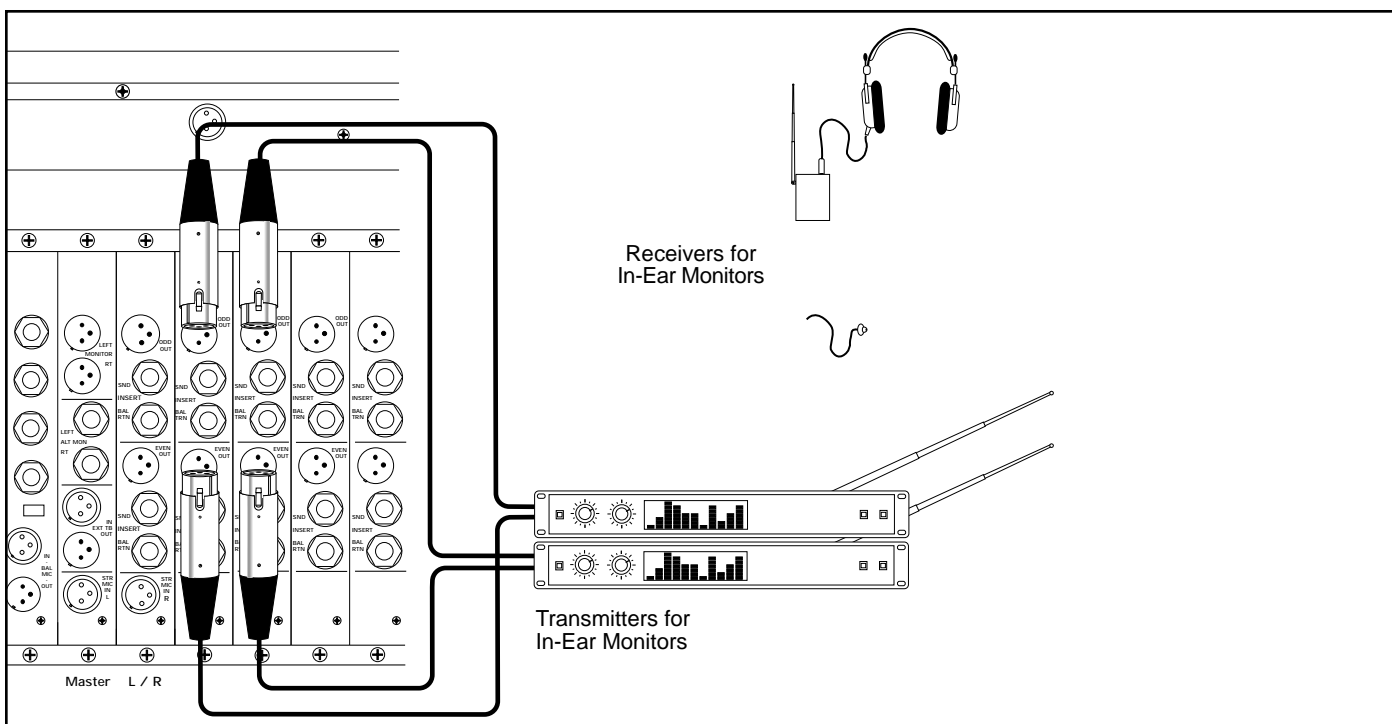

### Stereo In-Ear Monitor Connection

### System Connections (cont'd)

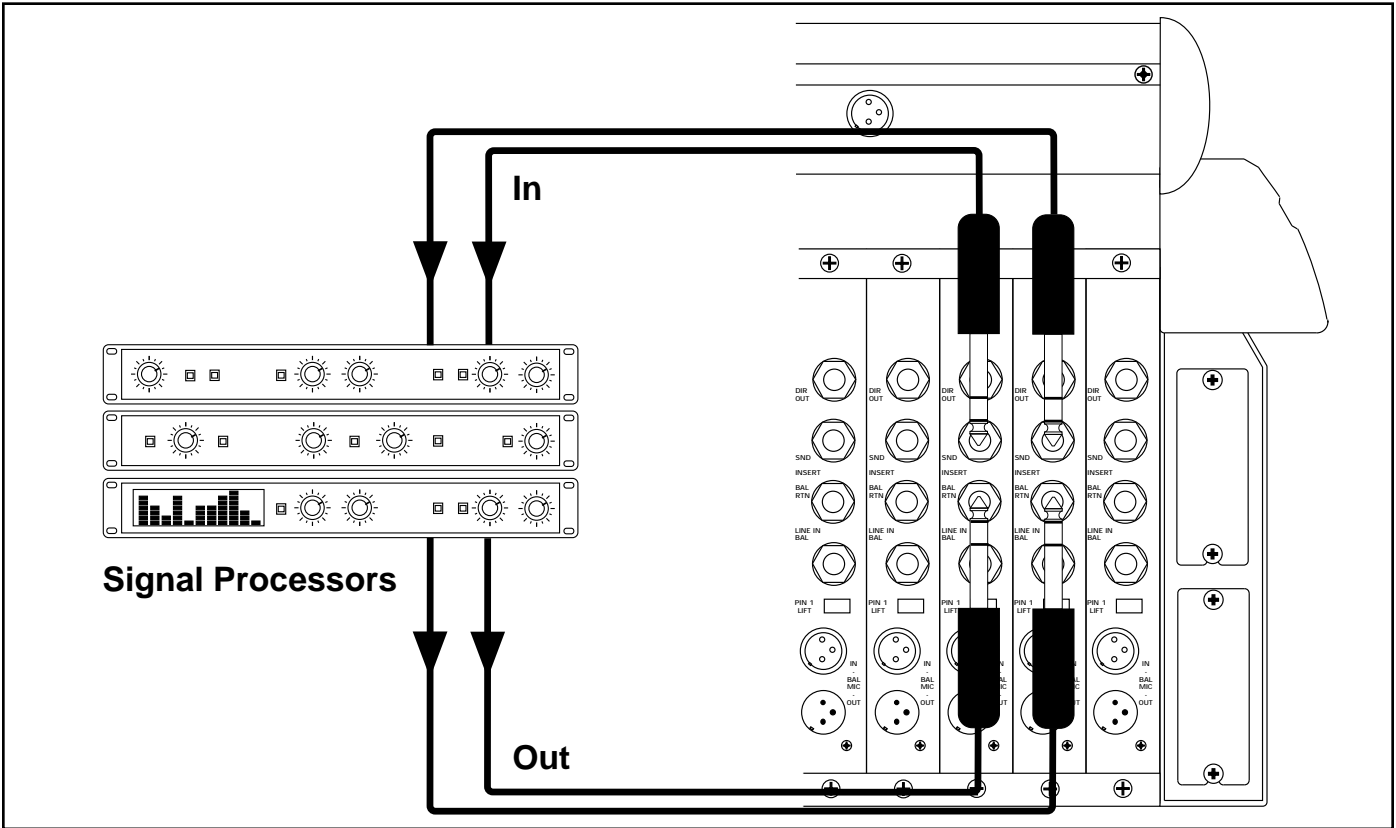

### Insert Send/Return Connection

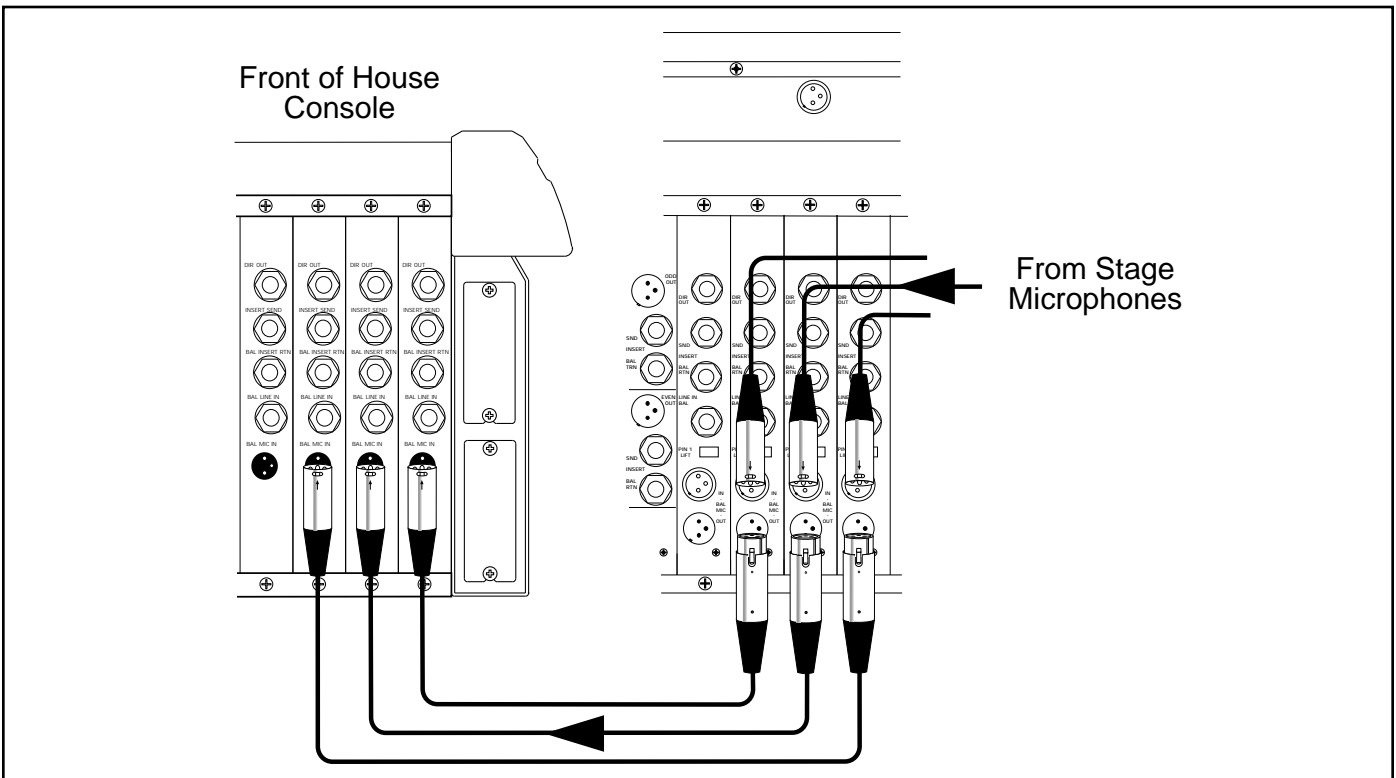

### Microphone Splitting

### Wiring Conventions

Since the same connectors are used throughout the professional audio industry, it is important to know how the connectors for Crest consoles are wired. Wiring is as follows:

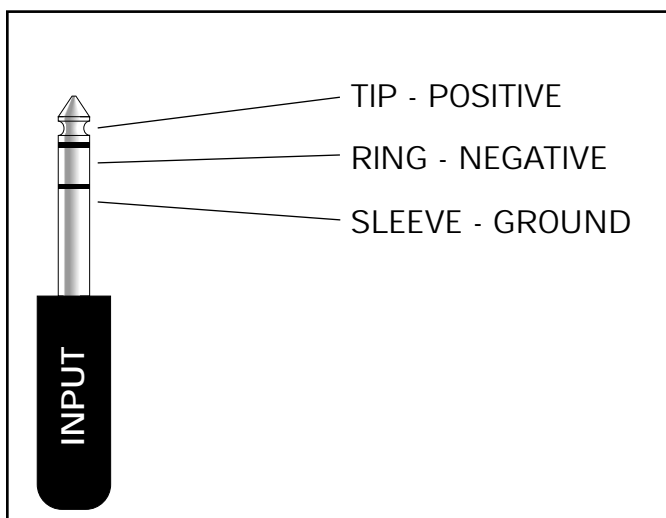
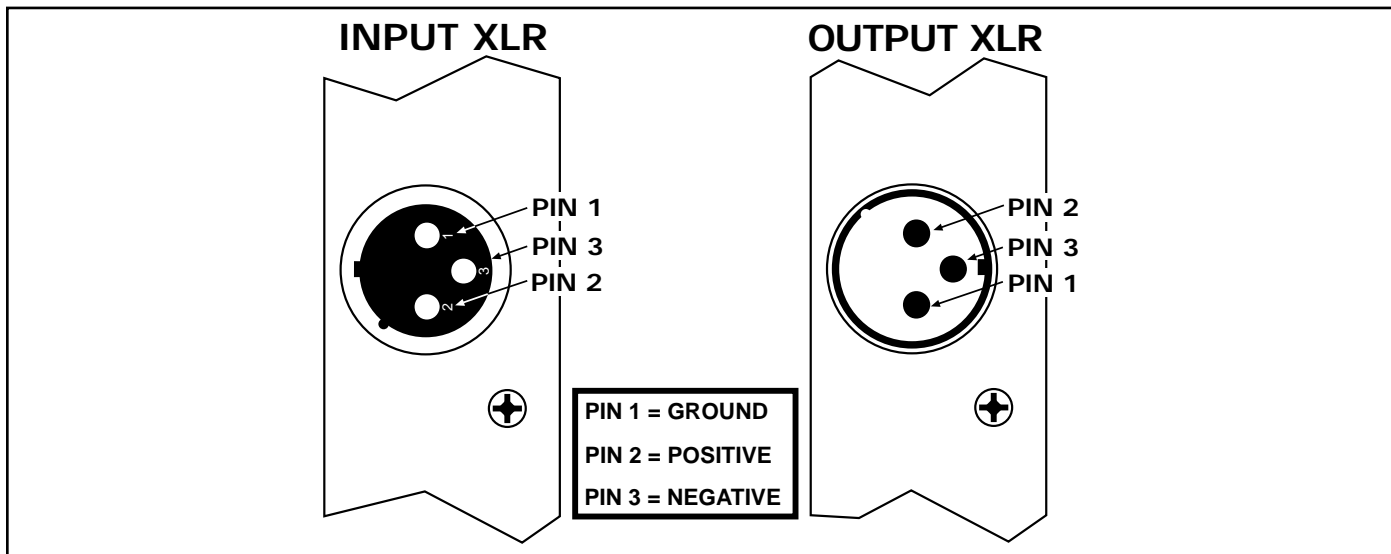

Input / Return Plug Polarities

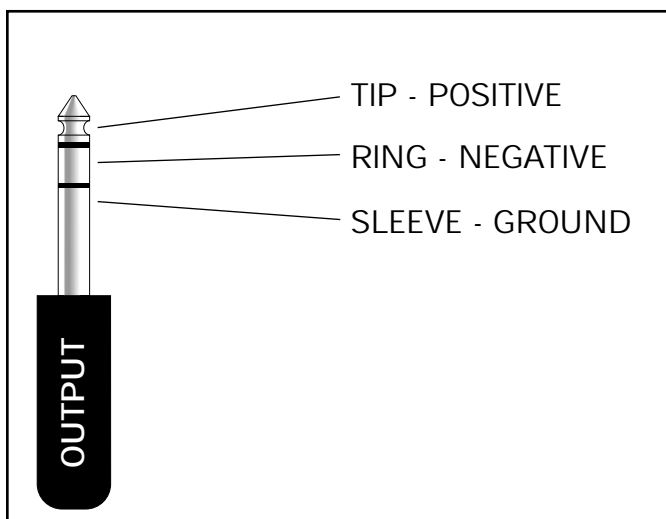

Output / Send Plug Polarities

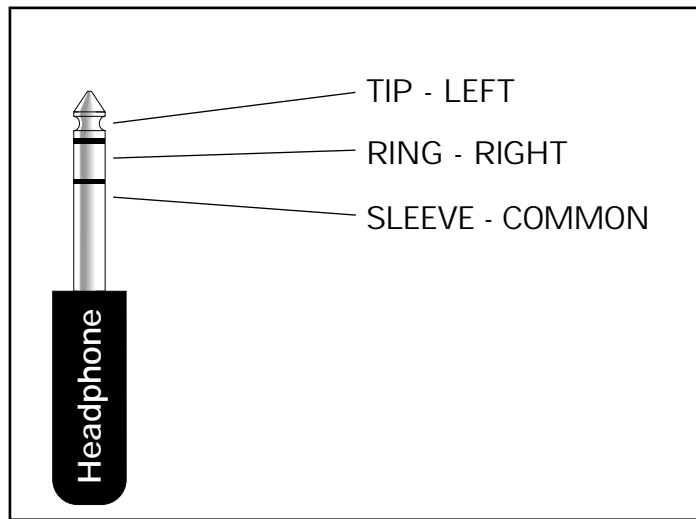

Connector: Headphone Output

# Century Series Console Power Supply

Century Series consoles use a separate rack-mountable power supply which provides the specific voltages used by each console. Crest Audio' Century Series makes use of two different power supplies. Both frame sizes (52 & 64 space) of the LMx console should only be used with the Model XCVA06 Power Supply.

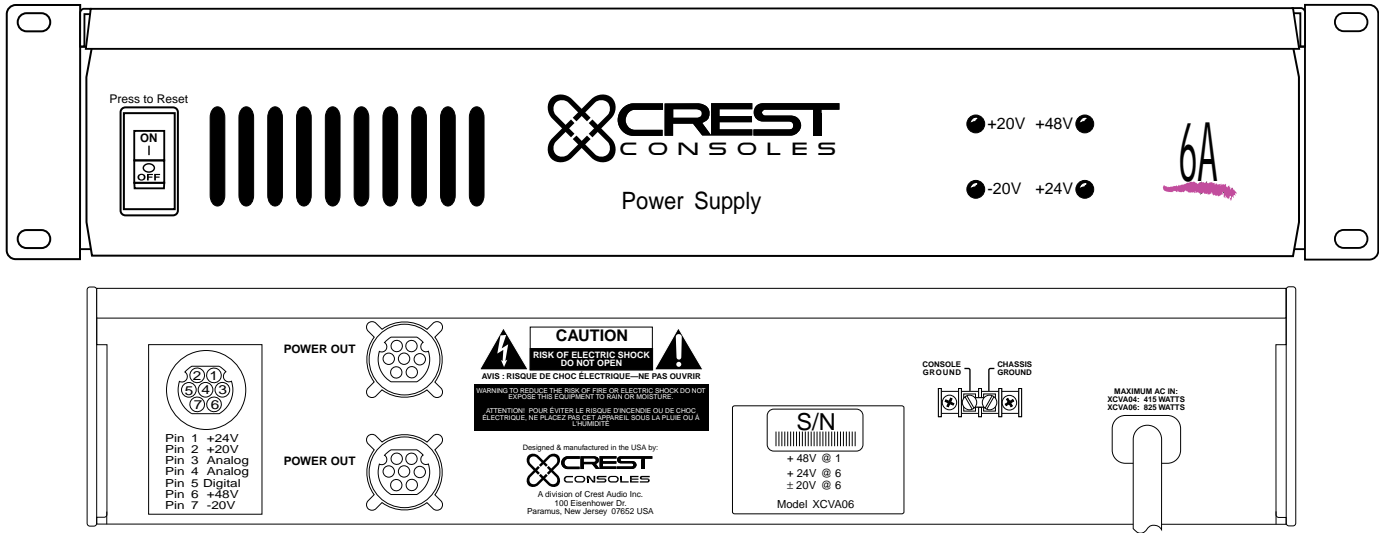

## Supply Identification

The type of power supply can be identified by the model number shown on the back of the chassis and panel label.

## Power Requirements

The Century Series power supplies have certain electrical requirements to operate properly. If possible the power supply should be connected to a dedicated circuit. Should any other appliance on the same circuit draw enough current to overload the circuit, the breaker or fuse will trip causing loss of power to the console. Note the maximum current draw specifications at right. Be sure that the circuit to which you connect the supply can handle the draw.

The power switch on the supply front panel is also a circuit breaker, there is no power fuse. Should the supply ever shut down, or trip at start up, simply push the switch to the off position and then on again.

## Ground Linking



Safety Considerations - Each new power supply is shipped with the AC third wire ground connected to the console chassis ground. The connection is made at the rear of the power supply unit. This is necessary for safety reasons so that exposed metal parts are grounded. In the event of a live conductor making contact with the console chassis or the power supply chassis then the current will flow to ground without a safety hazard arising. Note that when the console is disconnected from the power supply the chassis ground connection to AC third wire ground is broken and safety protection is lost. For uninterrupted grounding, in a fixed installation for example, make a connection directly to the console chassis from the safety ground. Disconnect the ground link on the rear of the power supply. This disconnects console ground from power supply AC third wire ground which would otherwise create a hum-loop.

## Twin Supply Operation

When twin supplies are in use for automatic back-up, then the ground links on both supplies should be fitted.

In a situation where the safety ground to the console chassis has been connected and the ground path via the power supply is causing a hum-loop, then disconnect the ground links on BOTH power supplies.

## Console and Power Supply Grounding

Console chassis ground is electrically connected to audio ground, pin 1 of XLR connectors and 1/4" sockets and to the terminal 'CONSOLE GROUND' at the rear of the power supply. The AC third wire connection in the power supply cable connects the metal chassis of the power supply to safety ground. This connection should never be disturbed. Hazardous voltages exist inside the power supply which require the case to be grounded. When rack-mounted, the power supply ground may transfer to the rack case thru the front fixing screws, though this connection is not reliable. When a console is configured within a complete sound system the grounding requirements may call for the ground link to be disconnected. This is permissible only when an alternative ground path has been provided. If in doubt seek the advice of an experienced electrical engineer.

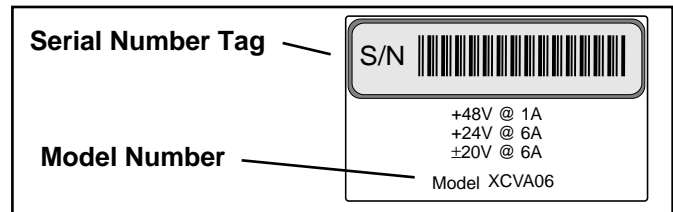

Power Supply Model	Max Current Draw @ 120V	Max Current Draw @ 240V
XCVA06	9 Amps	5 Amps



## Power Connections

The LMx's UL/CE-approved power supply is over-designed with ample current reserves. Multiple power supplies can be daisy-chained to provide fail-safe protection in the event of a supply failure. For the ultimate in fail-safe reliability, a back-up power supply can be linked to the primary supply with only a jumper cable. External switching is not needed. Both power supplies run all the time. In the event of supply failure, the remaining power supply(s) will take over the entire load.

Also, should a console module be accidentally disabled, the LMx power supply is designed to ignore that one module, keeping the rest of the board fully operational.

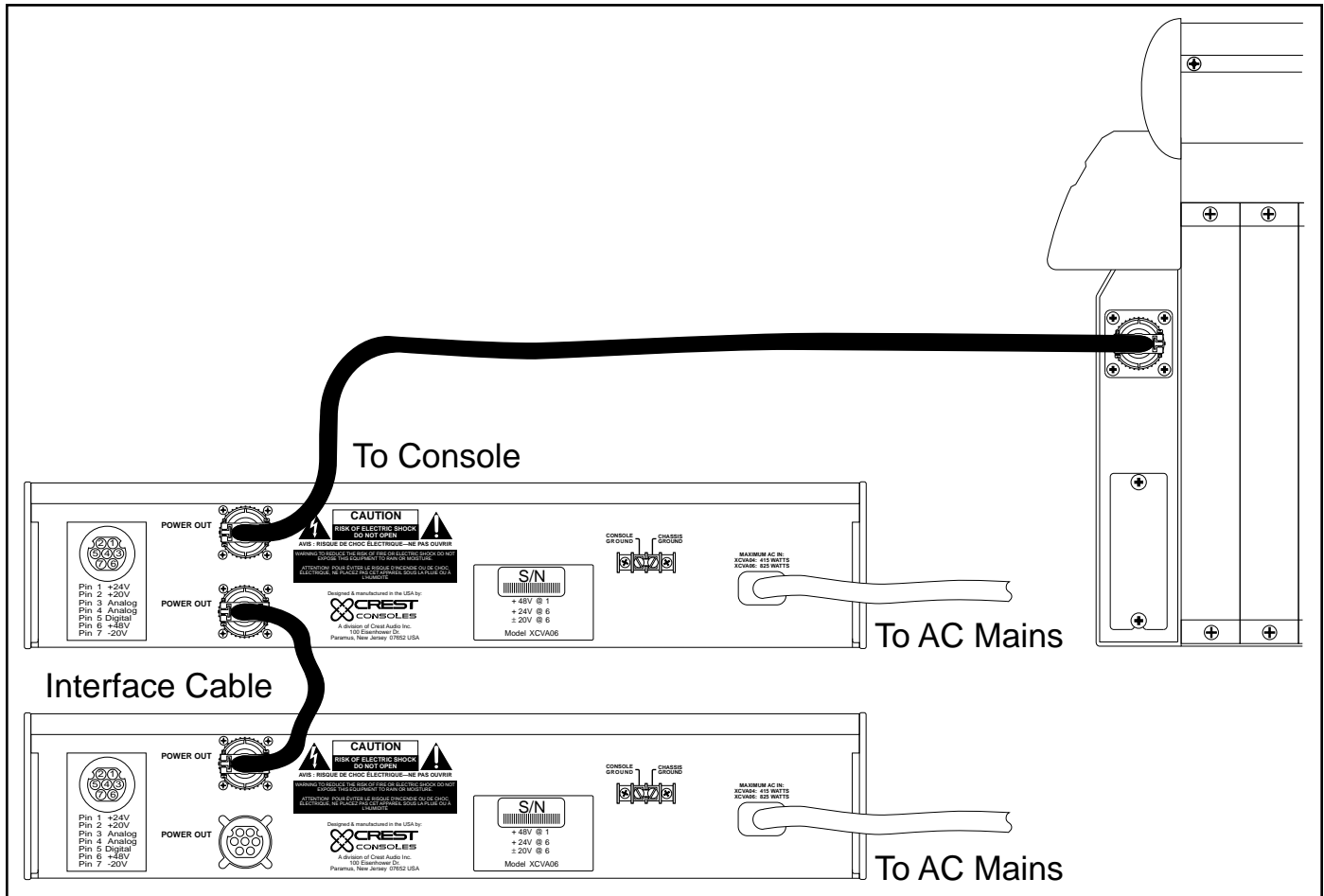

## Console Cooling

A cooling fan configuration is included in all LMx consoles. Two fans (one at each end of the console) draw air in through the sides of the chassis (under the sidebars). Air is distributed through the chassis via a “vortex pan”, then proceeds up through the console modules, where the heated air exits the console chassis.

Once the console is powered up, cooling fans remain on. A rear panel switch permits the fans to be set at low, medium or high speeds.

There are no filters to change or clean. As with any console, use in dusty/unclean environments should be avoided.

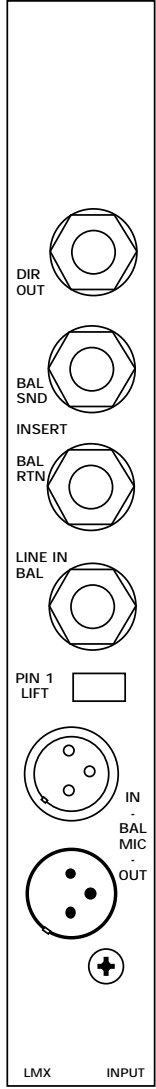
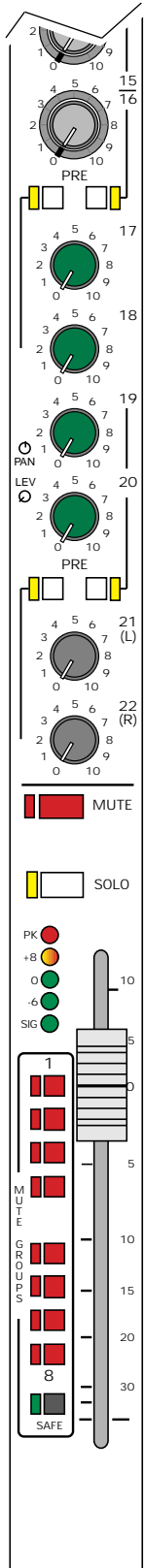
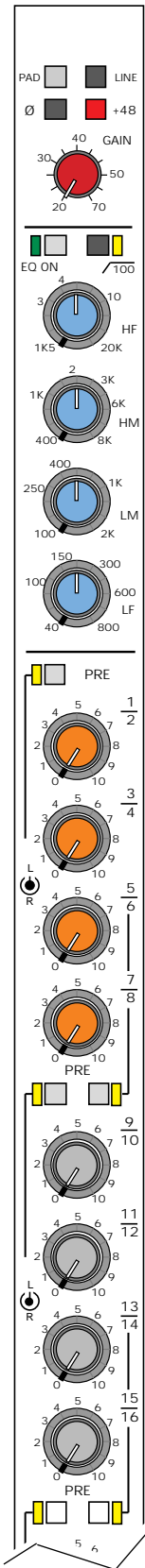

### LMx Input Module

40 or 52 identical input modules are fitted.  
Module features are described 'top down'.

#### PAD switch

Reduces the incoming audio level, before the pre-amp, by approximately 15dB.

#### LINE switch

Input select.  
**Default** is MIC XLR.  
**Press** for LINE 1/4" JACK

#### +48V switch

Press for 48V Phantom power on MIC IN & OUT XLR s. (check also Master 48V switch)

#### Ø switch

Press to invert the phase of the selected input

#### GAIN pot

Range +20 to +70dB.

#### 100 switch

Press for 100Hz high-pass filter

#### (INSERT POINT)

is located in the signal path, before the EQ section.

#### EQ section

- Silent IN - OUT** switch, with green LED indicator
- The EQ section features dual-concentric pots
  - +/- dB adjust on inner control
  - Frequency adjust on outer control
- HF** section, bell curve type (internal shelving option)  
Frequency range 1.5kHz to 20kHz
- HM** section, 'bell' curve type (internal Q option)  
Frequency range 400Hz to 8kHz
- LM** section, 'bell' curve type  
Frequency range 100Hz to 2kHz
- LF** section, bell curve type (internal Q option)  
Frequency range 40Hz to 800Hz.

Refer to USER OPTIONS for EQ filter options.

#### MIX SEND CONTROLS

All MIX sends are with EQ. When PRE sends are desired without EQ refer to USER OPTIONS

8 dual concentric pots for mixes 1 thru 16

**inner section** = odd #

**outer section** = even #

Unity gain at about 2 o'clock position #7.

## MIX SEND CONTROLS (cont'd)

Use the GLOBAL LEVEL/PAN switch on GROUP module to change to stereo mix configuration. There is a LEVEL-PAN switch for each pair of outputs. Each one changes all inputs at the same time.

In stereo mix configuration:       **inner** = level  
   **outer** = pan.

Start with the PAN (outer) set to center position.

## PRE switch

Mix sends are normally post fader. Use the PRE switch to select PRE FADER operation. When PRE is selected the send includes EQ treatment. Refer to USER OPTIONS for alternatives.

## MIX SENDS 17 thru 22

6 single pots for control of 6 mixes. Normally each is a level control. Use GLOBAL LEVEL/PAN to change to stereo mix configuration. There is a GLOBAL switch for each pair of outputs. In 'stereo' mode start with PAN in the center position.

## MUTE switch

Channel audio mute switch with indicator. Audio off = LED on. Normally all mix sends are muted at the same time. For alternatives refer to USER OPTIONS.

MUTE also responds to the MUTE GROUP system.

## SOLO switch

Individual audio check switch with indicator. User choice of AFL or PFL source. Use MODE switch on Master module.

**PFL = pre-fader, post EQ**  
**AFL = post-fader, post-mute,**

Headphones, SOLO meters and operator monitor stereo outputs all switch to follow any SOLO operation. SOLO PRIORITY controls are located on the MASTER module.

## PEAK indicator

Responds 3dB before overload. Senses preamp, EQ and post-fader levels.

## INPUT METER

Shows audio level from -30dB to +8dB. Source normally pre-fader. Refer to USER OPTIONS for alternatives.

## 100mm FADER

controls all outputs except those switched to PRE.

## MUTE GROUPS 1 - 8.

Each switch assigns the channel mute to a common mute bus. The indicator lights when pre-selected. Bus master switches are on the MASTER module. The regular mute switch LED shows the mute condition.

## SAFE switch

Isolates the channel mute from ALL mute group buses.

## Input Module Rear Panel

### DIRECT OUTPUT connector

1/4" unbalanced jack, +4dBu, post fader. Carries the direct output signal (post mute) from the input channel.

### INSERT SEND/RETURN points

**Send 1/4" - balanced jack, +4dBu**  
**Return 1/4" - balanced jack**

Insertion point is located in the signal path, before the EQ section.

### LINE INPUT connector

Audio from the first twenty input modules is connected internally to the GROUP modules. Input 1 to Group 1 etc. This connection is direct, bypassing the Input module source selection and is buffered.

### PIN 1 LIFT switch

This ground lift switch may be used to isolate pin1 of the mic XLR from console ground.

**Unpressed** = pin 1 grounded

**Pressed** = pin 1 lifted

### MIC IN connector

Input to channel preamp. Electronic balanced, 4 kΩ input impedance, +48V phantom power available.

### MIC OUT connector

Split from Mic In, direct connection, for connection to a second console, or other destination.

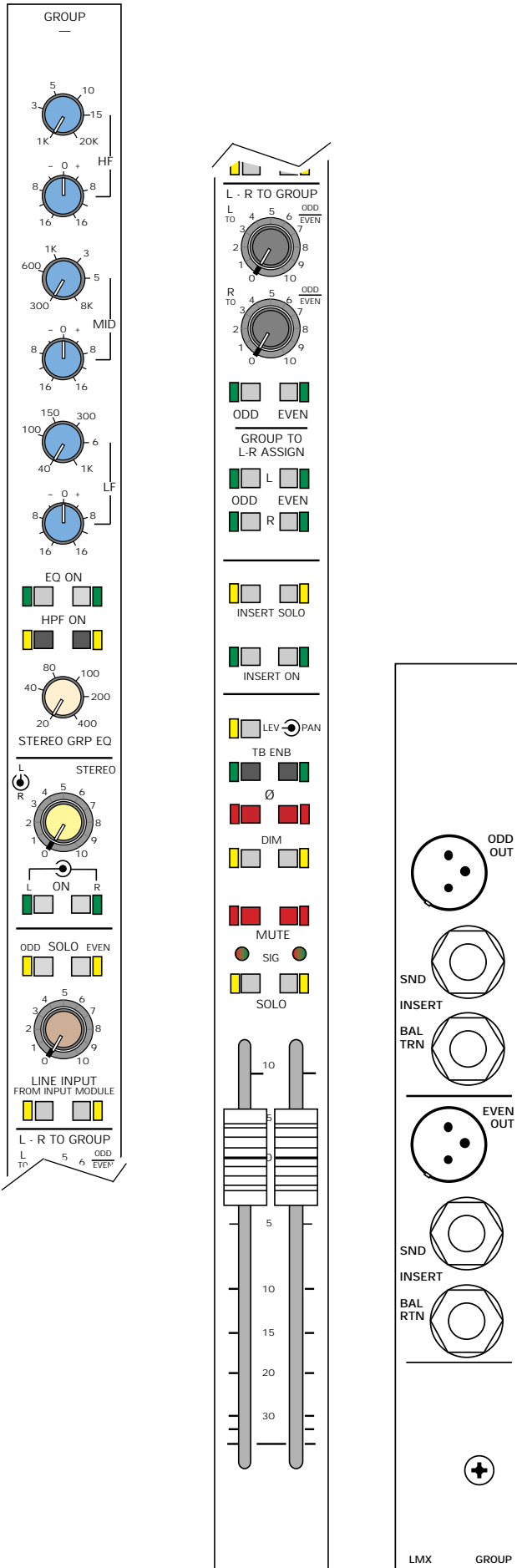

## LMx Group Module

All LMx models include 10 similar GROUP modules that are internally assigned to provide mix outputs 1 - 20 and associated functions. Module features are described 'top down'.

### Stereo EQ

For the mix outputs, +/- 16dB each band.

**HF** bell curve center frequency: range 1k to 20kHz

**HF** cut/boost with center detent

**MID** bell curve center freq.: range 300Hz to 8kHz

**MID** cut/boost with center detent

**LF** bell curve center frequency: range 40Hz to 1kHz

**LF** cut/boost with center detent

### EQ ON switches with indicators

For odd and even group output. Allows EQ of either or both sides.

### HPF (high pass filter) switches

with indicators. For odd and even group outputs.

### Stereo HPF pot

With cut off frequency range 20Hz to 400 Hz. Attenuation 12dB/octave below cut-off frequency.

### STEREO FEED

Stereo input audio comes from the Stereo Master Module. Dual concentric level controls.

**Inner** = STEREO INPUT to Odd # mix

**Outer** = STEREO INPUT to Even # mix

A mono sum of the Stereo source is used. When the groups are in Level-Pan mode then the source is mixed in stereo and the controls are:

**Inner** = Level

**Outer** = Balance.

Start with balance at mid-position.

### ON switches with indicators

For the odd and even side Stereo Input audio.

### LINE INPUT from same # input ch.

These dual concentric level controls add audio from the corresponding # channel Line Input to the group mixes. They are unaffected by adjustments on the channel.

**Inner pot** = Odd # mix, **outer pot** = Even # mix.

### LINE INPUT ON and SOLO switches

with indicators. SOLO is PFL only. These sections are defined as INPUT Solos for priority purposes. Refer to OPERATIONS for more about LINE INPUT.

### L-R TO GROUP

Sub-grouping facility.

Stereo mix 21L/22R is available on each group module.

**Left pots:** Inner = L to Odd # mix

Outer = L to Even # mix

**Right pots:** Inner = R to Odd # mix

Outer = R to Even # mix

Refer to OPERATIONS for examples of subgrouping.

## ODD EVEN switches with indicators

Operate with the level pots immediately above. They turn on or off the L/R audio to the Odd # and Even # groups.

## GROUP TO L-R ASSIGN switches with indicators

**ODD L** switch assigns the Odd # mix to 21L mix

**ODD R** switch assigns the Odd # mix to 22R mix

**EVEN L** switch assigns the Even # mix to 21L mix

**EVEN R** switch assigns the Even # mix to 22R mix

Refer also to STEREO module.

## INSERT SOLO switches with indicators

For the Odd & Even Group Insertion points.

Connects the Group Insert Return audio into the SOLO system.

Provides 'preview' monitoring of the output of an external device such as graphic EQ before the Insert Return is activated. Use AFL mode.

## INSERT ON switches with indicators

Activate the INSERT RETURN input. (Insert Send audio is always on.)

## GLOBAL LEVEL/PAN master switch with indicator

For Odd & Even Groups. Changes all the send pots for that Group # pair from level+level to level+pan configuration for stereo mixing.

Refer to OPERATIONS for more about Global Level-Pan.

## TB ENABLE switches with indicators

For odd and even outputs. Talkback audio from the MASTER module is added to the group mix, after the fader, before the mute switch.

## ∅ switch

Audio phase polarity inversion switches with indicators for odd and even mixes.

## DIM switches with indicators

Drop the level of the mix 6dB. This is an aid to feedback location and control.

## MUTE switches with indicators

For odd and even mixes. The mute turns off all audio from the mix to the output connector and the feed to the stereo mix.

## SIG (signal present) indicators

For the odd and even mixes showing the pre-fader levels. Bi-color LED shows normal level green and overload red. Overload is sampled pre-fader, insert send, insert return & line output.

## SOLO switches with indicators

For odd and even mixes. User choice of AFL or PFL.

**PFL** = pre-fader, post insert, stereo paired.

**AFL** = post-fader, post-mute, stereo paired.

When the module is in the stereo mix configuration and both SOLOs are pressed, then audio is assigned to the appropriate sides.

## 100mm faders

For mix output level to the output connectors and the stereo mix feed. Normal fader position is the "0" mark.

## Group Module Rear Panel

### Group Output XLR (Odd/Even Outs)

Balanced pin 2+. Min recommended load impedance 600Ω.

Output level	<b>nominal</b>	= +4dBu
	<b>max</b>	= +28dBu

### Group Insertion Point (Odd & Even)

Send is always active; return only active when insert on.

**Send 1/4"**, balanced, -2dBu

**Return 1/4"**, balanced, -2dBu

## Not shown:

### Group Output VU meters (Odd & Even #s)

0VU = +4dBu. Meter source is the final Group output immediately prior to the active output balancing circuit.

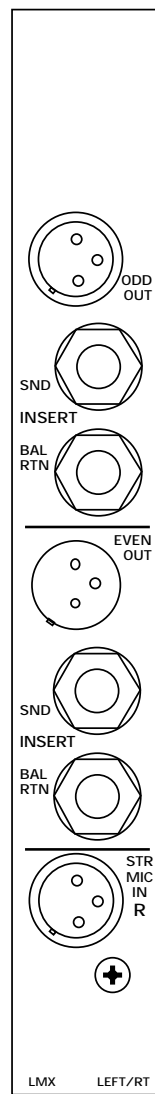
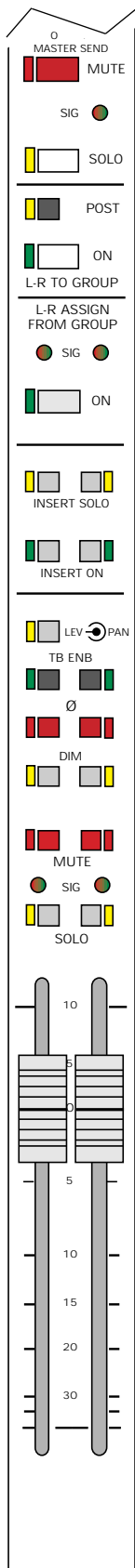
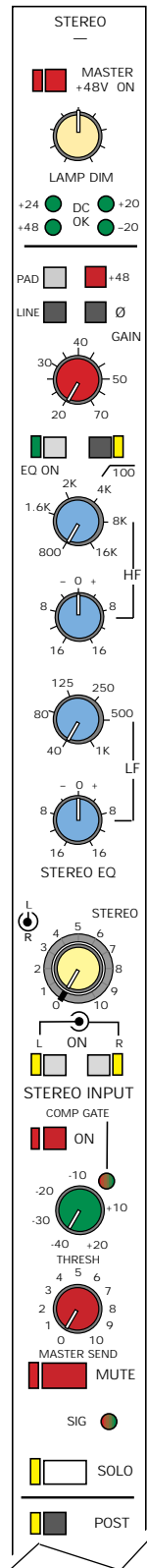

## LMx Stereo 21L/22R Module

Each LMx console includes one STEREO output module that provides mixes 21L & 22R and the Stereo Input. Module features are described 'top down'.

### MASTER 48V ON switch

Switch for phantom power to Input Channel modules.

### LAMP DIM pot (w/ center detent)

for the rear XLR gooseneck illumination system. Use nominal 12V lamps. Pinout is the current 'Littlite' standard.

### DC supply status indicators

For the incoming DC power.

### Stereo Input controls

These accept the audio from two XLR rear panel connectors and produces the STEREO audio for return to mix outputs 1 - 22.

### PAD switch

reduces the incoming audio level, before the pre-amp, by approximately 18dB.

### LINE switch

Inserts 20dB of attenuation between the input XLRs and the stereo preamp. Automatically defeats +48V phantom power.

### +48V switch

Press for 48V Phantom power on Stereo Input XLRs. Defeated automatically when LINE selected.

### Ø switch

Press to invert the phase of both channels.

### GAIN control

Preamp gain pot.

### EQ ON switch with indicator

Activates Stereo EQ on both channels of the input.

### 100Hz switch with indicator

Activates Stereo Input high pass filter.

### Stereo EQ

Two band, +/- 16dB each band.

**HF** center frequency, range 800Hz to 16kHz

**HF** cut/boost with center detent

**LF** center frequency, range 40Hz to 1kHz

**LF** cut/boost with center detent

### STEREO FEED controls

Dual concentric level controls for the STEREO INPUT to be added to output mixes 21L & 22R. The master send must be turned up.

### ON switches with indicators

For the Stereo Input to 21L & 22R.

**COMPGATE switch with indicator**

Activates the automatic audio processor when required for Stereo Input ambience mic mixing.

**THRESHOLD pot**

For the COMPGATE. Sets the activation threshold for the dynamics processor. Refer to OPERATIONS for more about COMPGATE.

**COMPGATE INDICATOR**

**unlit** = no audio; **green** = compression; **red** = gating.

**MASTER LEVEL pot**

Sets the Stereo feed audio level for groups 1 thru 22.

**MUTE switch with indicator**

for the Stereo Input.

**SIGNAL indicator**

Bi-color signal level indicator showing audio level pre-fader and pre-dynamics processor. Mono sum of L & R channels.

**SOLO switch with indicator**

for the Stereo Input. User choice of AFL/PFL, in stereo. AFL is prior to the Master Level so that dynamics processing may be monitored with the channel closed. This is an INPUT solo.

**L-R to Group Master Controls**

The L/R mix (subgroup) available to Groups 1-20 is summed in this module. These switches control the distribution of the stereo mix.

**POST switch with indicator**

Changes the source of L/R mix audio from pre output fader 21L+22R to post output fader 21L+22R.

**ON switch, with indicator**

For master control of mix 21L+22R output to groups 1-20.

**L-R ASSIGN MASTER CONTROLS**

Bi-color SIGNAL indicators show the level of the stereo sub-mix from Groups 1-20 to Groups 21L + 22R.

**Green** = normal                      **Red** = overload.

**ON switch, with indicator**

For the GROUP-TO-L/R sub-mix into 21L+22R. The sends from channels to 21L+22R are unaffected.

**GROUP CONTROLS****INSERT SOLO switches w/indicators**

For 21L & 22R Insertion points. Connects the Group Insert Return audio into the SOLO system. Provides 'preview' monitoring of the output of an external device such as graphic EQ before the Insert Return is activated. Use AFL mode.

**INSERT ON switches w/indicators**

Activate the INSERT RETURN input. (Insert Send audio is always on.)

**GLOBAL LEVEL/PAN master switch**

with indicator; for 21L & 22R Groups. Changes the send pots from level+level to level+pan configuration for stereo mixing. Refer to OPERATIONS for more about GLOBAL.

**TB ENABLE switches with indicators**

for 21L & 22R outputs. Talkback audio from the MASTER module is added to the mixes post fader, pre mute.

**Ø switch with indicator**

Audio phase polarity inversion switches for 21L & 22R mixes.

**DIM switches with indicators**

drop level of the mix 6dB. Aids feedback location and control.

**MUTE switches with indicators**

for 21L & 22R mixes. The mute turns off all audio from the mix to the output connector and the feed to the groups.

**SIG (signal present) indicators**

for 21L & 22R mixes showing the pre-fader levels. Bi-color LED shows normal level green and overload red. Overload is sampled pre-fader, insert send, insert return & line output.

**SOLO switches with indicators**

for 21L and 22R mixes. User choice of AFL or PFL. When the module is in the stereo mix configuration and both SOLOs pressed then audio is assigned to the appropriate sides.

**PFL** = pre-fader, post insert return, stereo paired.

**AFL** = post-fader, post-mute, stereo paired.

**100mm faders**

For mix output level to the output connectors and the group mix feed. Normal fader position is the "0" mark.

**Stereo Module Rear Panel****21Left (Odd) & 22Right (Even) Output XLR**

Main mix output; balanced pin 2+.

Minimum recomm.. load impedance 600 Ω

**Output level**    nominal = +4dBu                      max = +28dBu

**21Left (Odd) & 22Right (Even) Insertion Points**

**Send 1/4"** - Balanced, -2dBu

**Return 1/4"** - Balanced, -2dBu

Pre-fader send output is always active;

pre-fader return active only when insert on.

**STEREO MIC IN R**

Balanced XLR input, 4 kΩ input impedance, +48V phantom power available.

**Not shown:****Output VU meters 21 & 22**

0VU = +4dBu. The meter source is the Group output audio immediately prior to the active output balancing circuit.

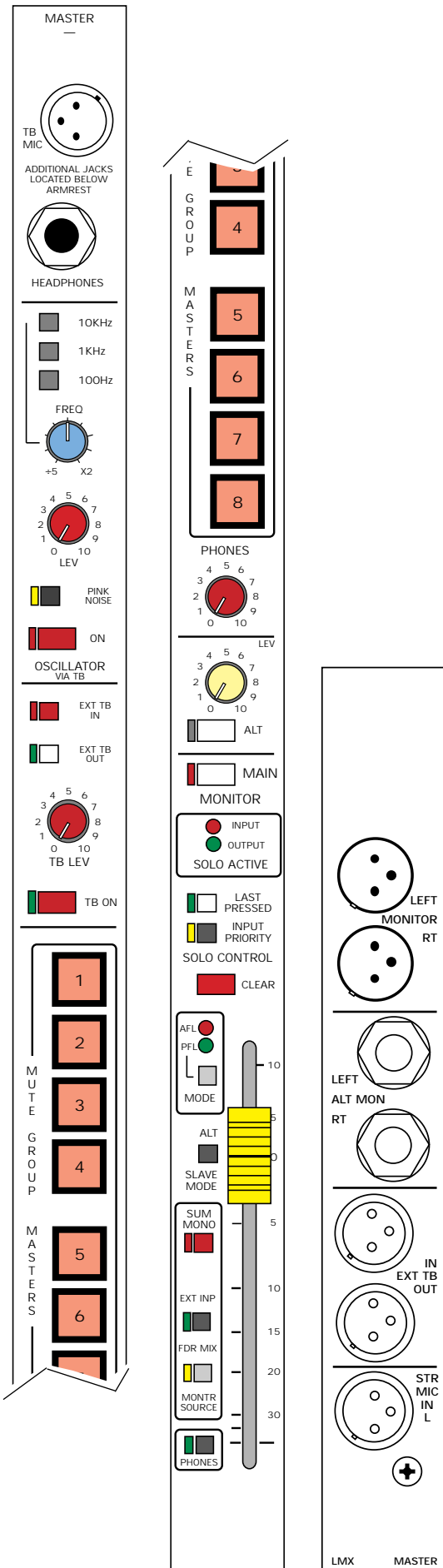

## LMx Master Module

Each LMx console includes a single module providing master control facilities for the Headphone, Main and Alternate monitor outputs, and the Talkback and Mute Group systems. Module features are described 'top down'.

### TB MIC Input connector

For balanced mic with 48V phantom power available. Second socket under armrest is in parallel.

### HEADPHONES output

Stereo 1/4" connector (regular musical instrument type). Internal high gain high power amplifier suits most impedances and sensitivities. Second connector beneath armrest is in parallel.

### OSCILLATOR controls

For **internal test generator**. 10kHz, 1kHz, 100Hz sine wave oscillator nominal frequencies. **FREQUENCY pot** acts with the switches above. Provides range from x0.2 to x2 the nominal frequency ie 20Hz to 20kHz. **LEVEL pot** for adjustment of the output level of the oscillator or Pink noise source. Available range; off to +10dBu.

### PINK NOISE switch and indicator

Changes the test signal from sine wave to pink noise.

### ON switch with indicator

Controls the output from this section.

### TB ON switch with indicator.

Master switch for talkback and oscillator outputs to the Group modules. This is a 'smart-switch'; Press+hold for momentary use; tap to lock on, tap again to cancel.

### TB LEVEL pot

Adjusts the audio level of talkback and oscillator to the Group modules.

### EXT TB IN switch with indicator

Mixes incoming audio into the talkback route via the level pot. The XLR input is suitable for high level balanced audio lines. Ext TB In is active all the time that EXT is switched on. This path bypasses the local TB ON switch.

### EXT TB OUT switch with indicator

Connects local TB/Osc audio to the rear output connector. Ext TB Out is active only when the master TB is ON. TB/Osc output XLR provides balanced audio at about -20VU.

### MUTE GROUP MASTERS 1 - 8

Eight illuminated mechanically-latched switches, each controlling one of the common mute group buses.

To enable a mute group press the switch, which then lights up. Now any channels assigned to that mute group number will mute. (cont'd)

Channels may be un-muted three ways: **1)** Cancel the master mute (press the switch again); **2)** Deselect the channel from the mute group; **3)** press the channel SAFE switch.

Mute Groups work on the active bus principle. Channels pre-selected to the bus only mute when the master mute is on (switch lit). While the bus is



active channels can be added or removed freely and the appropriate muting is immediate.

## Operator Monitor Section

### PHONES control

Level pot for control of both stereo headphone output sockets. (One is located on the master module, and another is underneath the front right end of the console armrest.) Internal high power amps to suit all headphone types.

Headphone outputs are solo, or follow the monitor source selectors (Ext source, Fader mix, Sum Mono) and are independent of all other monitor pots and switches. Note the PHONES ON/OFF switch below. OPTION: Phones follow Monitor fader. Refer to OPTIONS section.

### ALT MONITOR level pot and switch

With bi-color indicator. Control the secondary stereo 1/4" balanced operator monitor output. Normally output is a duplicate of MAIN monitor, unaffected by Monitor fader movements. Alt Monitor may be configured several ways, refer to OPERATIONS and OPTIONS.

### MAIN MONITOR output on-off switch with indicator

Controls audio output from rear panel balanced XLR connectors. Monitor audio source is SOLO with a choice of background-default audio when no SOLO is active. See Monitor Source below.

### SOLO ACTIVE indicators

Identify the location of active SOLO selections. **OUTPUT** refers to SOLOs on the 22 group mix sections. **INPUT** refers to all Input Channels, plus Line In sections of Group modules and Stereo Input section of the Stereo module.

### SOLO CONTROL switches with indicators

**LAST PRESSED:** choice of normal additive solos or auto-cancelling operation (new cancels old).

**INPUT PRIORITY:** choice of either:

Normal Operation: equal priority everywhere  
Input Priority: Input Solo overrides Group

**CLEAR:** cancels all solo selections. Console automatically clears on power-up.

### SOLO TYPE switch and indicators

**PFL**=pre-fader, stereo paired. **AFL** = post-fader, stereo paired.

### ALT SLAVE MODE switch & indicator

Puts Alternate monitor output under monitor fader control. In this mode Main Monitor On-Off switch cuts both the Main & Alt outputs.

**Monitor Sources** [audio default when Solo inactive]

### SUM MONO switch and indicator

Sums L&R audio (incl. SOLO) together for Main, Alt & HP outputs.

### EXT switch and indicator

Connects the EXT Input to all monitor circuits. Use EXT Input for an In-Ear system receiver or other monitor source as required.

### FADER MIX switch with indicator

Connects the Input Fader mix (mono unity gain mix) to all monitor circuits.

### PHONES ON/OFF switch

For the headphone outputs.

### 100mm Monitor fader

Controls the Main stereo monitor outputs. Normal position is the unity gain '0' mark.

### FOOTPEDAL monitor control

The main fader and Crest-supplied footpedal both control the monitor outputs. Footpedal range is from normal level to full attenuation. Normal level is adjusted by the main fader; the footpedal provides hands-free downward changes in level. Connect the footpedal included with the console to the 1/4-inch jack below the power connector at the rear. The footpedal is a custom design, having a passive 20k pot connected as a potential divider between tip (cw) ring (wiper) and sleeve (ccw) at the 1/4" jack. Use only the Crest-supplied footpedal.

## Master Module Rear Panel

### Monitor Left & Right

Balanced XLR outputs, +4dBu.

### Alternate Monitor Left & Right

Balanced 1/4 inch TRS jack outputs, +4dBu.

EXT TB Out - Balanced XLR output, -20dBu.

EXT TB In - Balanced XLR input, +4dBu.

### STEREO MIC IN L

Balanced XLR input, 4 kΩ input impedance, +48V phantom power available.

### Not shown:

#### EXT IN

Monitor source (via Input Channel Line In 1/4" connectors):

**LMx40** Ext In L & R = Line In # 21 & 22

**LMx52** Ext In L & R = Line In # 27 & 28

### SOLO L & R VU meters

Display the level of the current Monitor source: Ext In, Fader Mix, SOLO. 0VU = +4dBu.

### FOOTPEDAL 1/4" Socket

(On chassis below power connector) Potentiometer in pedal is wired to a 'stereo' jack plug. Use only the pedal provided.

## LMX Meter Bridge

22 electro-mechanical VU meters are provided for the mix audio output levels. They are arranged in a single row. Two central larger meters show the selected SOLO L & R audio levels. All meters are illuminated by long-life LEDs.

Meters are calibrated for  $0\text{VU} = +4\text{dBu}$  and do not normally require adjustment. There is provision for internal re-calibration if required.

### Normal Operation

In normal use, indicated audio levels of between  $-10$  and  $0\text{VU}$  give the best performance. The console has a considerable overload margin and occasional peaks to  $+3$  or more will usually be undistorted. However, as with all solid state audio, the change from clean to distorted sound occurs abruptly.

Audio levels persistently below  $-10\text{VU}$  waste the clean high-level capability of the console, and contribute unnecessary noise to the system.

### Illumination

Four XLR type sockets are provided at the rear of the meter-bridge and accept gooseneck type plug in lamps. The 18" long right-angle type is preferred. The connections are to the current Littlite standard (DC on pins 2 & 3, pin 1 NC).

Use 12 volt lamps, each 5 watts maximum. The voltages at the lamp sockets are controlled from the central lamp dimmer pot.

### Cleaning

Use non-abrasive materials to clean the meterbridge window. The meterbridge window is polycarbonate, selected for its strength. However, the material is relatively soft. The exposed face is coated to increase abrasion resistance.

### LMx Meter Bridge - 52 input channels



### LMx Meter Bridge - 40 input channels

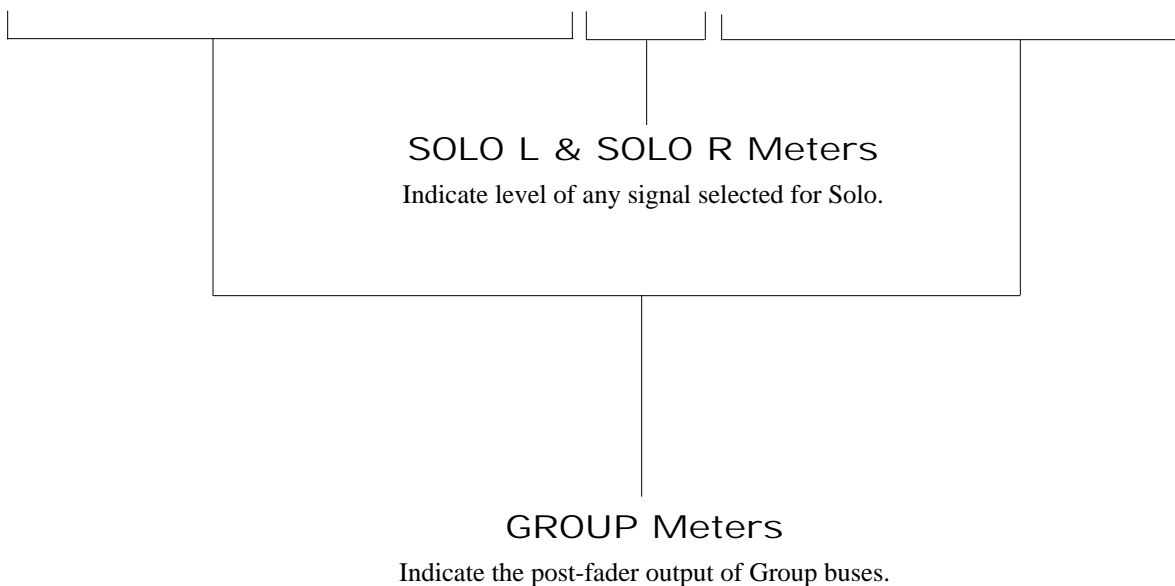

## Operation

### Special Features

- 1) Global Level/Pan
- 2) Solo system
- 3) Monitor outputs
- 4) Stereo Input
- 5) Channel Input Mic split
- 6) Line Inputs
- 7) Sub-grouping

## GLOBAL LEVEL/PAN

### Concept

In live show monitor-mix production the work load is unpredictable. Sometimes you need a console with the maximum number of mono mix outputs. Sometimes you need a console having a combination of stereo mixes and mono mixes, sometimes the customers wants in-ear monitoring, sometimes wedges and fills.

The LMx is easily configured, without module removal, to be any combination of straight mono mixes and stereo mixes, with in-ear monitoring, ambience input and user friendly features.

One key to stereo mixing is input sends on level+pan controls, because sorting out separate level pots for the L & R sides demands too much effort.

All the Input channel sends on LMx are re-configurable as either level pots or level and pan pot pairs for stereo mixing. Sixteen sends are presented as dual concentric pots in eight pairs, 1/2.....15/16. The remaining six sends are each single pots, ideal for straight mono mixing, and that may be reconfigured as three more stereo mixes 17/18.....21/22.

When in 'mono' mode the dual concentric pots work as separate level controls to two mixes.

In 'stereo' mode the inner control works as the send level, the outer control is the pan. Start with this control set at 50% rotation (center position).

### Operation

Changing from mono to stereo configuration is controlled by a single switch on each group module 'GLOBAL LEVEL/PAN'.

In normal operation, for 22 mono mixes, all the global switches are out.

Whenever a stereo mix with level and pan is wanted simply select GLOBAL on the pair of mixes you want to be in stereo. Two changes occur.

First, on all the sends to those groups, the internal pot configurations are switched to create level+pan pairs.

Second, the output module group mix sections are internally stereo-paired so that use of both group SOLOs at the same time gives a stereo mix to the operator monitor outputs.

The send pot configurations are engineered to be transparent in use. The level control 'taper' is the same for the inner and outer sections, which permits settings to be copied. In 'stereo' mode, the center pan gain is -3dB.

Start with the "pan" pot at 50% rotation.

## STEREO INPUT

The Stereo Input feed to group mixes is also under Global control for the same reason. In mono (not Global level/pan) mode the Stereo Feed pots on a group module receive a mono sum of the L & R sides of the Stereo Input. This allows each of the two mono mixes to hear both sides of the stereo input.

When a pair of groups are put into Level/Pan mode, the Stereo Feed pots are reconfigured to Level+Balance, allowing easy adjustment of the stereo feed to the stereo mix.

## SOLO SYSTEM

### Solo Types

Selection of PFL or AFL source is made by remote switching from the MASTER module. One stereo solo mix is summed in the MASTER module.

PFL is pre-fader audio. Mono sources are reproduced in both sides, Stereo sources are automatically assigned in stereo.

AFL is post-fader, post-mute. Mono sources are reproduced in both sides, Stereo sources are automatically assigned in stereo.

The SOLO TYPE switch (Master module) controls the selection of AFL or PFL source.

### Solo Response

Starting with a clear console, when the first SOLO is selected three things occur at the same time:

1. Audio from Solo source(s) is added to the Solo audio mix buses.
2. The Solo control bus is activated and switches over the stereo monitor output section from the user selected default source, Silence, External Input or Fader Mix, to Solo audio. The system recognizes the location of the active Solo(s) and lights the appropriate INPUT or OUTPUT indicators.
3. The SOLO meters are also switched and show the Solo audio level instead of the default source level.

When all Solos are cleared then the system reverts to default audio.

### Solo Priorities

MASTER SOLO CONTROL		SOLO RESPONSE	SOLO PRIORITY
'Last Pressed'	'Input Priority'		
no	no	Solos add	none
yes	no	New cancels old	none
no	yes	Solos add	Input overrides
Output			
yes	yes	New cancels old	Input overrides
Output			

### Solo Active

Indicators show SOLO ACTIVE and identify the location of the Solo.

INPUT is indicated for: Input Channel SOLO  
Group Line Input SOLO 1-20  
Stereo Input SOLO

OUTPUT is indicated for: Group Mix SOLO 1-22  
Group Insert SOLO 1-22

## METER CALIBRATION & SIGNAL LEVELS

SOLO meters show the audio level at that point. The console gain structure is calibrated for optimum performance when faders are set at the nominal '0' points and level pots are set to about 2/3 rotation, 2 o'clock. When these conditions are true then the console output level and the Solo meter level agree.

### Meter levels

<u>NORMAL INDICATIONS</u>	<u>QUIET</u>	<u>SHOW LEVEL</u>	<u>PEAKS</u>
Input Signal LEDs	flickering	steady green	red
Group mix Signal LEDs	flickering	steady green	red
Input LED meter	flickering	steady '0'	yellow/red
Solo meter Input PFL	-20 to -10VU	-10 to 0VU	> +3
Solo meter AFL	depends on fader setting		

### Monitor Outputs

Main, Alternate and Headphone outputs each receive the same high quality stereo audio program. Facilities have been provided to allow the user freedom of choice about the way the outputs are used.

Starting from the factory standard product these are the facilities and variations available.

**Headphones:** Internal high power stereo amplifiers, two outputs in parallel, one level control, one on-off switch. Independent from Main and Alternate outputs.

OPTION phones level controlled by Main fader.

**Main Monitor:** Stereo balanced XLR line output for operator's amp + loudspeaker. On-off switch. Level control by full length fader.

OPTION foot-pedal volume control in addition to fader.

Use only the Crest-supplied footpedal

**Alt Monitor:** Stereo balanced 1/4" line output for second amp + loudspeaker, spectrum analyzer, etc. Same audio source as Main. On-off switch. Level control pot, with user choice of independent level control or slaved to Main fader (Alt Slave mode)..

OPTIONS In SLAVE MODE

(a) Alt on-off switch normal (in series with Main on-off)

(b) Alt on-off switch becomes Main/Alt output toggle switch, only one being on at a time, the other silent.

The Alt On-Off LED is controlled intelligently to show the audio status.

When in SLAVE mode:

<u>LED</u>	<u>Alt Monitor audio</u>
OFF	OFF, local switch off.
GREEN	ON, local switch on.
RED switch	ON, but muted by Main On-Off switch

When in SLAVE mode AND option (b) is used:

<u>LED</u>	<u>Alt Monitor audio</u>
OFF	OFF, Main output ON
GREEN	ON, Main output muted
RED switch	ON, but muted by Main On-Off switch

Refer to OPTIONS for the procedure to change internal options.

## STEREO INPUT

This special section of the Master module provides input and stereo control for mic or line level audio such as music playback, echo return, or ambience audio for 'in-ear monitoring' system operation. The Stereo Input is provided with a full set of channel controls with the benefit of stereo adjustment on single controls for gain, EQ, solo, mute, and master level.

### In-Ear Ambience mixing

Unique controls are included that make the engineers job a little easier. In particular, the engineer has the choice to allow automatic compressor-gate audio control take over the ambience audio fade in and out between show segments. The auto system (COMP-GATE) fades the ambience audio in when the sound level in the room falls, then fades it out when the sound level rises again. Threshold sensitivity for the fades is adjustable and the system can be switched back to manual control at any time.

### Comp-Gate

The principal of operation is that the ambience audio is processed by a variable gain stage (a VCA) and the control signal is the ambience audio itself. There are two thresholds: the first is preset manually and the second is 12dB above the first. Incoming audio starts to be compressed as it exceeds the first threshold, and the indicator lights green.

When the uncompressed input has increased about 12dB, the circuit becomes an inverse-gate or ducker. The increasing control voltage is used to decrease gain, ambience audio level is cut and drops in level further and further as the input level increases. The indicator shows red during this process. When the ambience input starts to fall, the second threshold is reached again (control voltage decreasing) and ambience audio is faded back up.

Translated into show terms, the ambience audio is a mixture of show sound and audience sound. The automatic system presumes that the show sound is louder than the audience and uses the swell in level when the show resumes to duck the audience sound out of the mix. When the show fades down, the audience sound fades up again.

### Compgate SOLO

Compgate SOLO PFL is pre-dynamics. AFL is post dynamics, but before the master level pot, so that the dynamics can be checked with the Master Level closed.

### Ambience Set Up & Operation

The ambience mic input XLR's should be treated exactly the same as regular input channels. Note that when LINE is selected the +48V is automatically defeated. Gain should be preset to about 40dB with high output mics at a loud show and about 60dB with low output mics at a quiet show. It is important that the input gain is adjusted so that there is normal level signal in the ambience channel during performance. Use SOLO and adjust gain for -10VU to 0VU at full show level. (cont'd)

## Ambience Set Up & Operation (cont'd)

The Compgate circuit introduces no gain. It operates solely by attenuation. Gain and level setting should be made with Compgate OFF, using the Master Stereo Level pot and group Stereo Feed pots. At soundcheck with the COMPGATE off, set the threshold maximum clockwise. Verify that ambience audio is available at the Stereo Input SOLO PFL and can be added to the output mixes as required.

Select COMPGATE.

Experiment with the THRESHOLD setting, turn it counter-clockwise, while the performance is in progress and being amplified by the house system. At a certain setting (depending on local conditions) the first threshold will be signalled by the Compgate indicator showing green and compression being applied to the ambience audio. With Master Level closed use AFL to check the effect of compression and gating on the audio.

Back-off the threshold further counter-clockwise, and note the second threshold, ambience audio is cut from the mix, the indicator shows red.

This setting can be used as a starting point. When the show sound level drops between numbers, the Compgate will automatically fade up the ambience input.

(The threshold setting used for the show will depend on the show dynamics and should be found by experiment.)

Now turn up the master level and use the 'STEREO' pots on each group to add ambience audio to individual mix outputs.

### Override

In the course of a show there may be occasions when only manual ambience control will give the balance that the performers want. Simply cancel the COMPGATE by releasing the switch, use the master level pot, or the local STEREO FEED pots to balance the ambience in the mix.

### CHANNEL MIC INPUT SPLIT

The twin XLRs provided on every input channel provide a passive mic split to another part of the system.

The XLRs are hard-wired pin-to-pin, including pin 1. The ground lift switch isolates XLR pins 1 from the console audio ground. Isolation of Output XLR pin 1 from the input pin 1 is possible by internal modification of the module rear connector board.

The input impedance of the channel preamp is about 4k $\Omega$ , sufficiently high that the loading effect of the console input on the source mic is negligible. The input is electronically balanced and the input capacitor DC rating is 100V.

### PHANTOM POWER

+48V phantom power is available for each input and is switched locally at the module and in the center control area for all channels. This phantom +48V supply is distributed to pins 2 and 3 of the XLRs via 6.8k $\Omega$  resistors locally. Phantom voltage is present on both the IN and OUT XLRs.

Deliberate unbalanced operation or accidental shorting of pin 2 or 3 to ground with phantom power on may cause a temporary fault condition and cause full modulation of the console input channel and any split from it. The local isolation resistors limit the effect to only the channel directly affected. The console will not be harmed; however, low frequency loudspeakers in particular are vulnerable to the full output levels that phantom power mismanagement can produce. If problems occur turn down the output and check all connections.

Temporary damage can occur to any audio transformers in the line when phantom power is disturbed by grounding one phase. While the short persists, the sound is grossly distorted. After removal of the short circuit, sound quality may be affected by residual magnetization of the transformer core, especially noticeable on high levels. If the sound quality does not return to normal replace the transformer and have it demagnetized.

### GROUP LINE INPUTS

The audio for the LINE IN sections of the group modules comes from the 1/4" connectors for channel line inputs. The audio is buffered and split internally on each input channel. Channel Line Input 1 is split to Group Line In 1 .....etc to Channel Line Input 20 and Group Line In 20.

### Line Input Mixing

The LINE INPUT dual concentric level pot on each output module controls the level of incoming audio to the Odd and Even number mixes in the module. Inputs 1 & 2 are available to group mixes 1 & 2. Inputs 3 & 4 to mixes 3 & 4....etc.

The pots are arranged as follows:

**Odd#** = top/inner section, **Even#** = lower/outer section.

Line Input SOLO is provided separately for Odd and Even inputs, and is signalled as Input Solo.

### SUBGROUPING

#### A.) Introduction

There are sub-grouping paths from Groups to L-R, and from L-R to Groups. The potential for inadvertent feedback is minimized by the interlock on each Group section. Priority is given to the forward path 'Group to L-R'. When this is in use then the 'L-R to Group' path is interrupted.

#### B.) Bringing audio into Group Mixes

The Line Input on each Group can be used to bring audio into group mixes. (For example, signals from an external sub-mixer, an effects device, or another mix patched from insert send etc). Hard-patch the signals into Line Inputs as required.

### C.) Return of a mix to any number of mixes.

Create the master mix, eg drum mix, on groups 21L & 22R either in stereo (select Global Level/Pan) or separate mono mixes:

In the center of 21/22 module select 'L-R TO GROUP ON'.

On the mixes that want the drum mix, use the level pots 'L-R TO GROUP' to fade up the complete mix from 21/22 into the individual monitor mixes. For example, stereo mix 3/4 wants the drum submix from 21L/22R.

On Group module 3/4, select 'L-R to GROUP' 'ODD' and 'EVEN'. This turns the audio path on.

On mix 3, turn up 'L to ODD' (inner pot section), leave the outer pot closed.

On mix 4, turn up 'R to EVEN' (outer pot section), leave the inner pot closed.

Now, there is stereo copy of mix 21L/22R in stereo mix 3/4.

### D.) Adding Group Mixes to the L-R mix

Mixes 21 and 22 are configured to receive a sub-mix from the groups.

To add group mixes to 21L/22R, use the switches on each group 'GROUP ASSIGN TO L-R'

For example to add mix 5 in mono to the stereo mix 21L/22R, select 'ODD L & R'

To add stereo mix 7/8 in stereo to the stereo mix, select 'ODD L' only and 'EVEN R' only. Leave Odd R and Even L unassigned.

To add stereo mix 11/12 in mono to mix 21L, select only 'ODD L' and 'EVEN L'; leave Odd R and Even R unassigned.

Use the On-Off switch to control the Group submix added to the L-R mix. With this switch OFF, the Group submix is turned off; only the sends from channels to 21L and 22R are heard.







# Appendix A

## Technical Information

## General Specifications - LMx Console

The following are the technical specifications for the Century LMx console.

<b>Frequency Response</b> (referenced to 1kHz)	+0.0, -0.5dB, 20Hz to 20 kHz
<b>Total Harmonic Distortion</b> (Mic input to Group output) 20Hz to 20 kHz at +15dBu	<0.01%
<b>Phase Response</b> 20Hz to 20 kHz	+20°, -20°
<b>Noise</b> (22Hz to 22kHz) Mic EIN (150Ω, 60dB gain) Group Output Noise (40 inputs)	-129 dBu - 80 dBu
<b>Crosstalk</b> (Measured at 1kHz) Channel Mute Channel Fader Attenuation	>100 dB > 85 dB
<b>Input/Output Impedances</b> Mic Input Line Input Outputs	4kΩ balanced >10kΩ balanced 120Ω balanced
<b>Input/Output Levels</b> (0VU = +4 dBu, 1.23V RMS) Mic Input Sensitivity Line Input Sensitivity Input Insertion Point Level Output Insertion Point Level Nominal Output Level Maximum Balanced Output Level	+ 4 to -62 dBu + 12 to -38 dBu + 4 dBu + 4 dBu 4 dBu +28 dBu

### Overall Dimensions

The following table contains net dimensions for all Century LMx consoles. (L x W x H)

Frame Size	Imperial	Metric
52	67" x 30.2" x 12.7"	1700 x 767 x 322mm
64	82" x 30.2" x 12.7"	2070 x 767 x 322mm

## Configurations

The Century LMx Console is available in the following configurations:

Century LMx Consoles feature 10 dual group modules, 1 left/right module, 1 master module, available in the following input configurations:

**40 MONO INPUTS (52 FRAME)**

**52 MONO INPUTS (64 FRAME)**

## Architect's & Engineer's Specifications - LMx Console

The following text should be used when specifying a Century LMx console in a bid or proposal.

The sound mixing console shall be constructed in two sizes and be suitable for both fixed installation and touring operations. Audio modules shall be individual for service and addition purposes. Audio connections shall be accessible from the console rear. Mic In and Group Out connections shall be XLR 3-pin balanced types. Insertion points shall be accessible via separate Send & Return 1/4 inch TRS connectors. Primary Inputs & Outputs may be transformer isolated as a chargeable option. The nominal audio level shall be +4dBu, and the maximum output level +28dBu. The console shall operate from AC mains via the external rack mount power unit included. Optional connection of a second power supply for automatic back-up shall require only a link cable. The 40 channel console shall measure 67x30.2x12.7 inches (1700x767x322mm). The 52 channel console shall measure 82x30.2x12.7inches (2070x750x322mm). Input Channels shall accept Mic (XLR) or Line (1/4inch) input by selector switch. The Mic Input shall be passively split with output XLR connector provided. There shall be a ground lift switch and +48v phantom power control for each channel. Input Gain shall be continuously adjustable between 20dB and 70dB by gain pot and -15dB by Pad switch. There shall be a phase invert switch active on Mic or Line Input. Each channel shall include switches with indicators for: 100Hz high pass filter; EQ On ; Mute (solid-state soft turn-on); Solo; Mute Scene select 1-8; Mute Scene Safe. There shall be 4-band EQ, each band having +/- 15dB variable gain and adjustable filter center-frequency. The ranges shall be: LF 40-800Hz; LM 100Hz-2kHz; HM 400Hz-8kHz; HF 1.5k-20kHz. Five segment channel signal level LED indicators and overload indicator shall be provided. Each channel shall have a total of 22 independent sends to the Group Outputs; eight being dual concentric rotary controls (sends 1-2,3-4,....15-16) and six single rotary controls (sends 17-22). Seven Pre switches with indicators shall control the choice of Pre or Post fader audio source. These switches shall be grouped as follows: sends 1-4, 5-8, 9-12, 13-16, 17-18, 19-20, and 21L-22L. Each send level pair may be configured dual mono or stereo operation by a single global Level/Pan switch associated with each output pair. Channel output level shall be controlled by a 100mm travel slide fader. The output section shall contain ten Group Modules, each providing two Group Outputs, each output including: mix Insertion send and Return connections; 100mm fader; balanced output with XLR connector; bi-color signal indicator and electro-mechanical VU meter. Each Group shall have switches with indicators for Solo; Mute; Dim; Phase Reverse; Talkback Enable; Insert Solo; Insert On-Off. Each pair of Group Outputs (an individual Group module) shall include: the Global Level-Pan master selector, with indicator; three bands of stereo output EQ with variable frequency and gain; independent EQ In-Out selectors with indicators; high pass filter with variable frequency from 20Hz to 400Hz and independent In-Out selectors for each output. For each Group there shall be independent Level controls and On-Off switches from L and R to each Group. Any or all signals on the 20 Group buses shall be assignable to the L-R Stereo mix. These two subgroup modes shall be interlocked to prevent inadvertent feedback loops. In addition each Group module shall include Level, Pan and On-Off controls from the Master Stereo Input. Each Group shall include Level, Solo and On-Off switches with indicators from the corresponding Channel Line Input. One Stereo Output module shall provide Group Outputs 21L and 22R, each with Insertion Send and Return connections; 100mm fader; balanced output with XLR connector; bi-color signal indicator and electro-mechanical VU meter. Each Group shall have switches with indicators for Solo; Mute; Dim; Phase Reverse; Talkback Enable; Insert Solo; Insert On-Off; and there shall be one Global Level-Pan master selector for sends 21L & 22R. A Master On-Off switch shall be included for the sum of the Group signals assigned to L-R, which shall not affect the channel send L-R mix. The L-R output to the Group sections shall have an On-Off switch, and normally be pre L-R fader. There shall be a switch with indicator to connect this output Post fader. Within the Stereo Output module a dedicated Stereo Input channel shall be provided for stereo mic or line sources with stereo two-band sweep EQ. Switches with indicators shall be provided for EQ In-Out, High pass filter In-Out, Mute and Solo. The channel output shall be available to all Groups via the Stereo sections. Dynamics processing shall be available for in-ear monitor mixing. Above the user-set threshold, audio shall be compressed. When compression exceeds 12dB the audio output level automatically drops, such that the manual function of riding a room-ambience mic between numbers is achieved hands-free. One Master module shall provide Main, Alternate and Headphone monitor outputs. All outputs shall be stereo. The audio source for all outputs shall be the Solo bus, defaulting to the operator's choice of silence or an External stereo input or a mono straight-line Input Fader mix. A Mono switch shall convert stereo sources to dual channel mono. The Solo system shall normally sum multiple Solos, with the option to hear only the last selected Solo. It shall be possible to engage the Solo Priority system so that Input Solo overrides Output Solo. The Solo bus audio shall be either PFL or AFL of any Input or Output, as selected by the Solo Mode switch. Groups in 'Stereo Level-Pan' mode, and the dedicated Stereo Input, shall be monitored in stereo. Each output shall have an independent level control and On-Off switch with indicator. The Main level control shall be a 100mm slide fader with parallel footpedal (supplied) operation. The Main fader may be switched to affect the Alternate output also. The Main and Alternate outputs shall have the option to be switched exclusively. The Headphone output shall include two sockets and be unaffected by the Main and Alternate channels. There shall be eight illuminated Mute Group master switches, one for each Scene Mute bus. There shall be facilities to generate sine wave and pink noise test signals, and a dedicated input and preamp for Talkback mic operation. The sum of speech and test-tone shall pass to the Groups (postfader) via the Main Talkback On-Off switch and Group Talkback Enable switches. The Main TB switch shall be touch sensitive and either latch-on for test-tone or press-hold-release for speech. A dedicated switch shall control the connection of an External Talkback source to the Groups, which shall not be affected by the Main TB On-Off switch. Indicators shall be provided for the system DC power supply status. There shall be a dimming control for the optional rear mounted lamps. A Master 48V phantom power switch shall be provided. The console shall have a full-size meter bridge with sunlight-visible mechanical VU meters provided for all 22 output buses and the stereo Solo bus. Meter illumination shall be LED. The live monitor console shall be the Crest Audio Century LMx40 (LMx52).

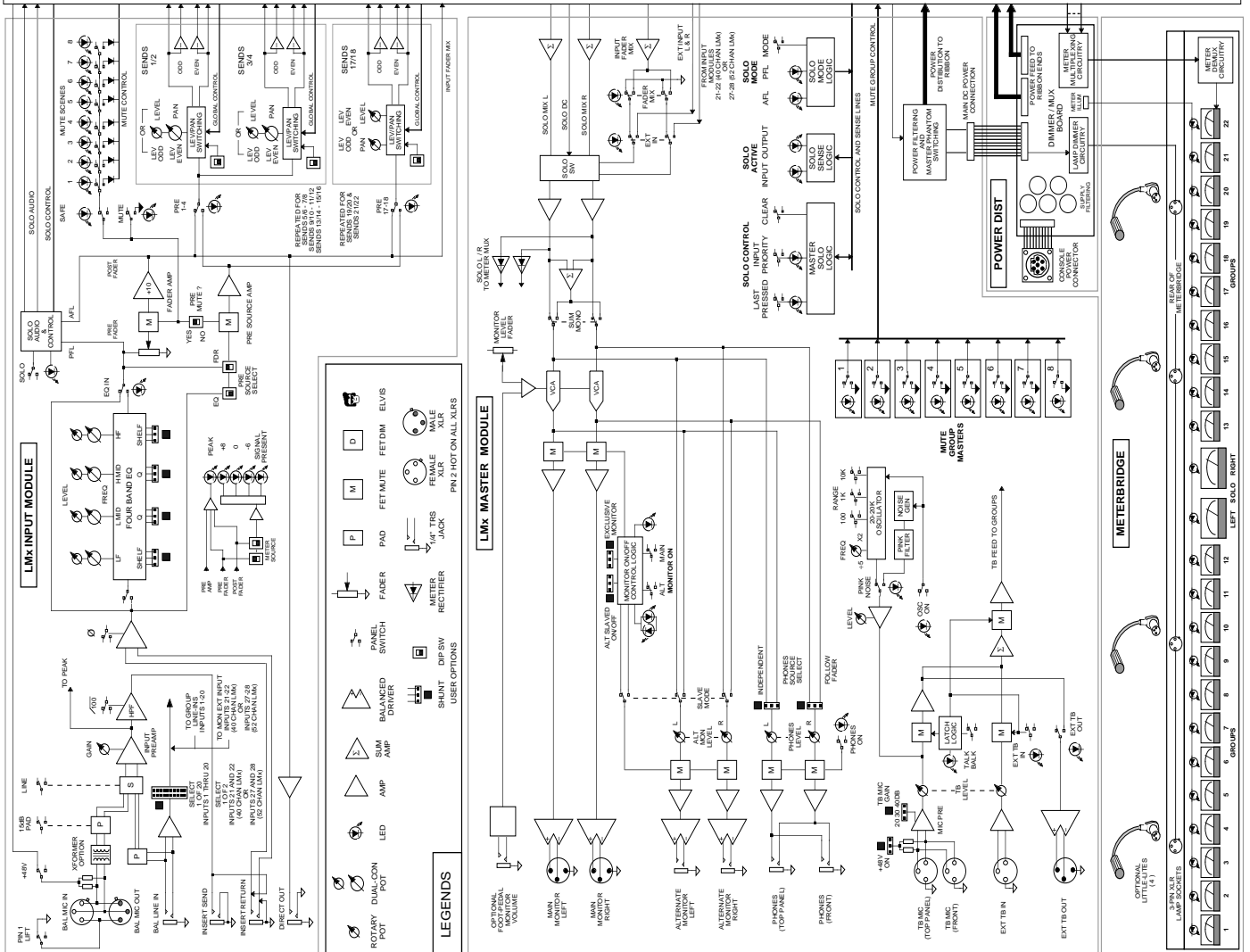
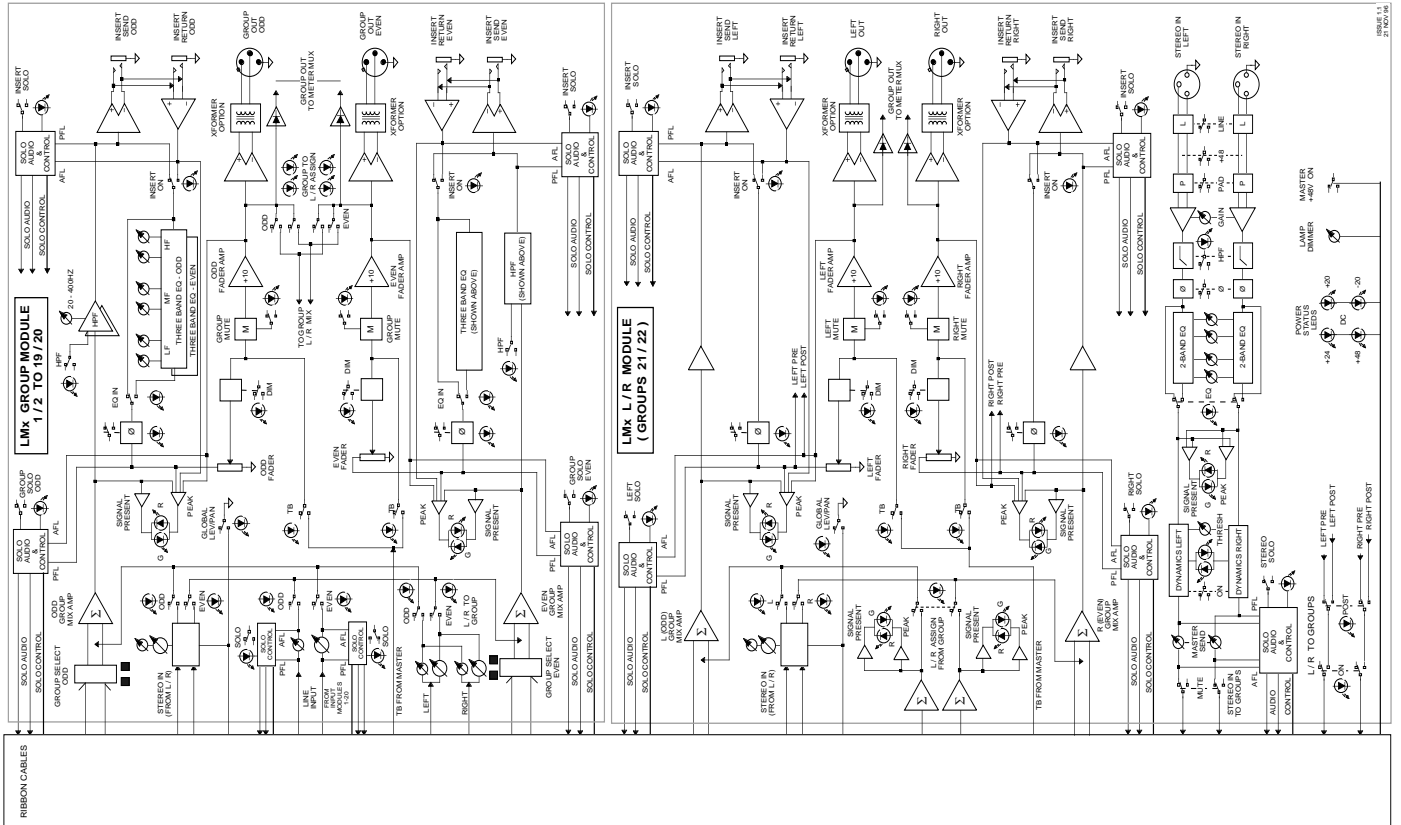

**LEGENDS**

- OPTIONAL MONITOR VOLUME
- OPTIONAL MONITOR VOLUME
- MONITOR LEFT
- MONITOR RIGHT
- ALTERNATE MONITOR LEFT
- ALTERNATE MONITOR RIGHT
- PHONES (TOP PANEL)
- PHONES (BOTTOM)
- EXT TB IN
- EXT TB OUT
- EXT TB IN
- EXT TB OUT
- OPTIONAL UTILITY LAMP SOCKETS
- 3-PIN XLR LAMP SOCKETS
- METER BRIDGE
- REAR OF METER BRIDGE
- LEFT SOLO RIGHT
- GROUPS 1-22

**CREST AUDIO**

Side Dimensions

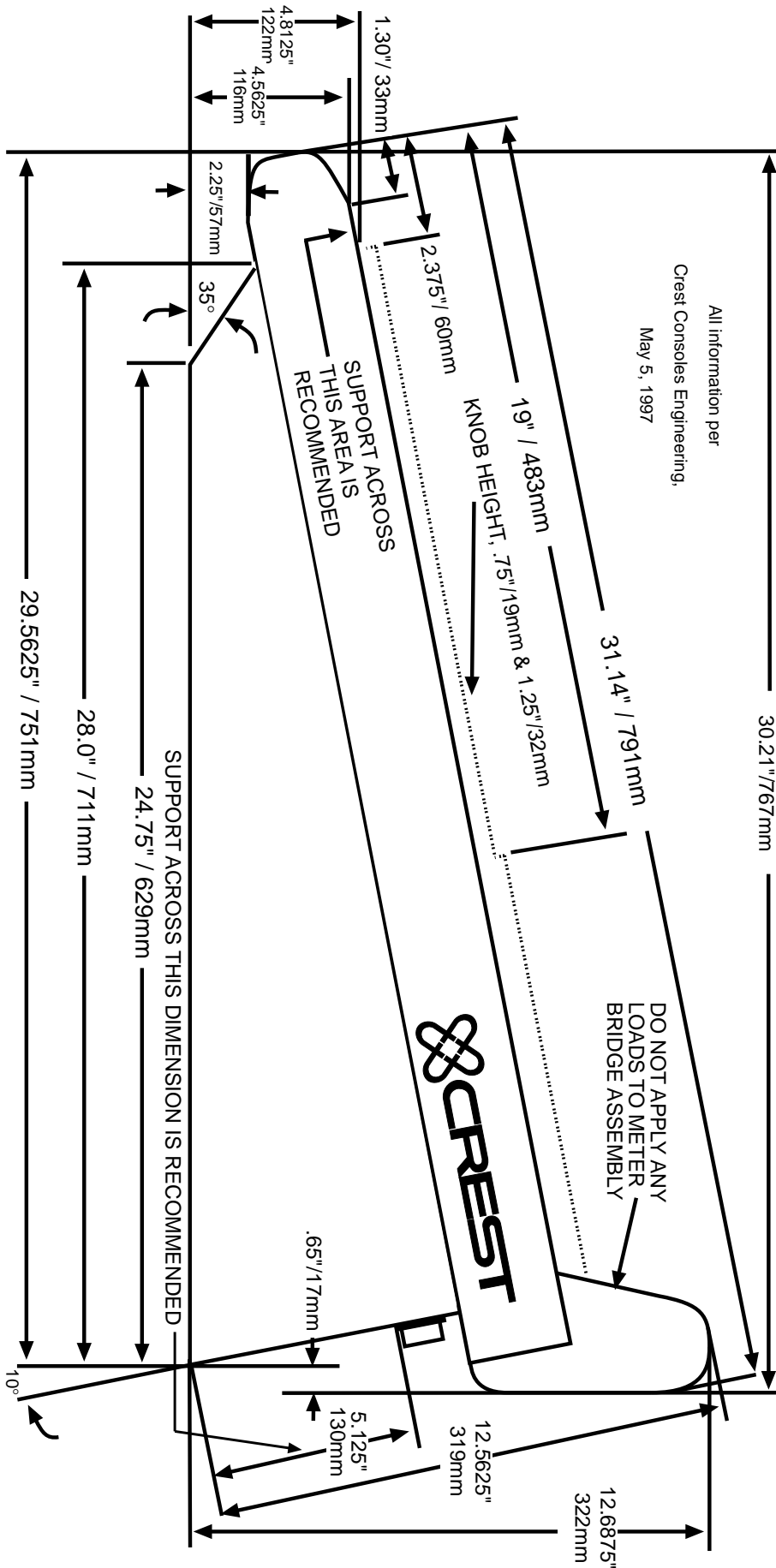

All information per  
Crest Consoles Engineering;  
May 5, 1997

Rear Views & Dimensions

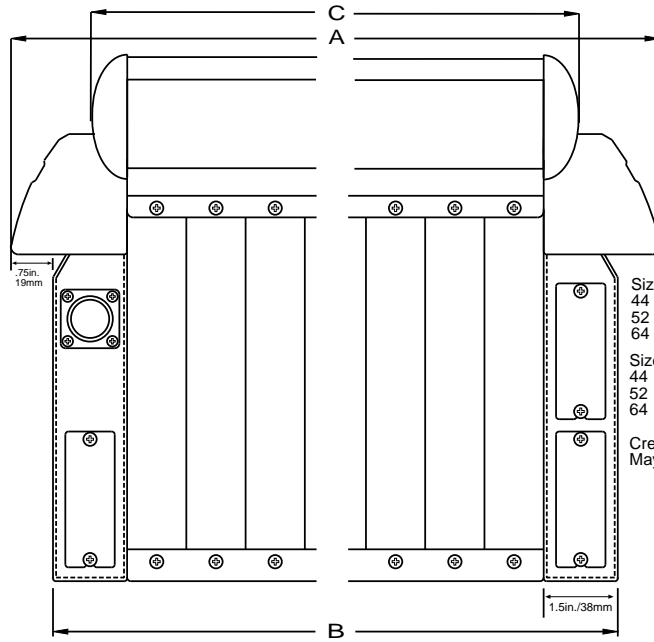
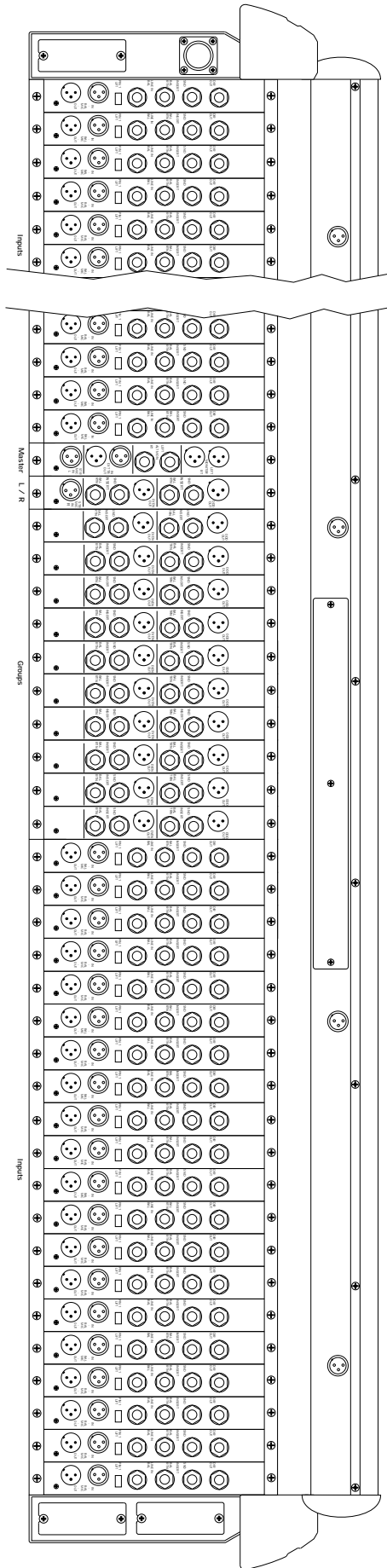

Size	A	B	C
44	57.55"	55.80"	54.25"
52	67.15"	65.40"	63.85"
64	81.55"	79.80"	78.25"

Size	A	B	C
44	1462mm	1417mm	1378mm
52	1706mm	1661mm	1622mm
64	2071mm	2027mm	1988mm

Crest Consoles Engineering,  
May 5, 1997

## LMX User Options

LMX consoles are shipped having standard configuration unless specified at time of order. These are ways that the console configuration may be varied after manufacture. The items listed are internal options selected by gold jumper links or using pcb DIP switches. Jumper link default is marked on the board with a line and is usually pins 1&2 of the three pin header. *Please note that Group Outputs and Stereo Master have no user options.*

In addition, there are links for module function assignment. Take care to not disturb these when using USER OPTION links.

DIP switches: switch ON is 'down', switch OFF is 'up' when viewing the switch body numbers.



<u>MODULE</u>	<u>LOCATION</u>	<u>OPTION TITLE</u>	<u>FUNCTION</u>
	[M=Main board C=Connector]		Shipped with option underlined
<b>Input</b>	C OPT 1	EQ HF select	<u>Peak</u> or Shelf curve
<b>Input</b>	C OPT 2	EQ HM (high mid) select	Q high or <u>low</u>
<b>Input</b>	C OPT 3	EQ LM (low mid) select	Q high or <u>low</u>
<b>Input</b>	C OPT 4	EQ LF select	<u>Peak</u> or Shelf curve
<b>Input</b>	M switch 16/1	GRP1/2, force Level/Pan mode	ON or <u>OFF</u>
<b>Input</b>	M switch 16/2	GRP3/4, force Level/Pan mode	ON or <u>OFF</u>
<b>Input</b>	M etc	etc	
<b>Input</b>	M switch 16/8	GRP15/16, force Level/Pan mode	ON or <u>OFF</u>
<b>Input</b>	M switch 17/1	GRP17/18, force Level/Pan mode	ON or <u>OFF</u>
<b>Input</b>	M switch 17/2	GRP19/20, force Level/Pan mode	ON or <u>OFF</u>
<b>Input</b>	M switch 17/3	Left/Right, force Level/Pan mode	ON or <u>OFF</u>
<b>Input*</b>	M switch 17/4	Pre-source to Groups: with EQ	ON *
<b>Input*</b>	M switch 17/5	Pre-source to Groups: pre EQ	OFF *
<b>Input</b>	M switch 17/6	Pre source to Groups: Mutable	<u>ON</u> or OFF
<b>Input*</b>	M switch 17/7	Pre-fader to Channel meter:	ON *
<b>Input*</b>	M switch 17/8	Post-fader to Channel meter:	OFF *
<b>Master</b>	M SEL1(R)+SEL2(L)	HP level follows Mon Fader	YES or <u>NO</u>
<b>Master</b>	C SEL1 TB	Phantom Power	<u>ON</u> or OFF
<b>Master</b>	C SEL2 TB	Gain select	20, <u>30</u> , 40dB
<b>Master†</b>	M SEL3	'Exclusive Monitor' Alt Monitor ON-OFF switch option. Default = Alt ON-OFF switch normal.	
<b>Master†</b>	M SEL4	'Alt Slave ON-OFF' Alt Monitor ON-OFF switch option. Default = Normal, Alt ON-OFF switch independent.	

\* these switches operate in pairs to select either of two possible choices. Change both switches.

†These two jumper links should be changed as a pair. Other combinations are not meaningful.

Consoles are shipped with SEL3 & 4 in the default settings. Alternate and Main outputs have independent ON-OFF switches. When in SLAVE mode the Alt output level is controlled by the Main monitor output fader.

When SEL3 & 4 are BOTH selected then when Alt SLAVE mode is selected the Alt level is controlled by the fader, the Main ON-OFF switch controls both the Main and Alternate outputs, and the Alt ON-OFF switch becomes an exclusive either-or switch for the 1/4" (Alt) and XLR (Main) outputs. The Alternate LED indicator is intelligently controlled by the Main switch to show 'OFF' (no light) or 'ON+mute' (red) or 'ON' (green).

	<b>IMPORTANT</b>	
Output modules are pre-assigned at the Crest factory		
These modules must always be installed in the correct positions. They are NOT interchangeable without being properly re-assigned. Please contact the Crest Audio Service Department for more information.		

## Console Disassembly

Though you shouldn't have to disassemble the console, it is necessary to remove modules to change the jumper and switch settings associated with the internally selectable options. The following steps detail the tasks involved when taking the console apart.

### ONE • Open the armrest.

To properly remove one or many modules, the black painted armrest must first be opened. To do this, the two thumb-screws (see diagram at right) must be loosened from below. Once these screws are loose, slide both of them a few inches to the side (they will only move in one direction). Once the screws have been moved the armrest will easily roll back exposing the module screws beneath.

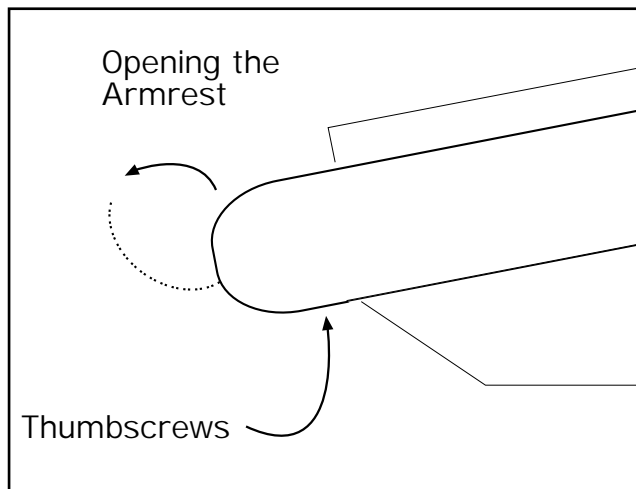

### TWO • Remove front module screw

Once the armrest has been opened, there will be a single screw at the front edge of the module panel holding each module in place. Remove the screw from the module(s) you want to remove.

### THREE • Remove rear screws

On the back panel of the console there are two screws holding each module in place (see diagram at right) Remove both screws from each module you wish to remove.

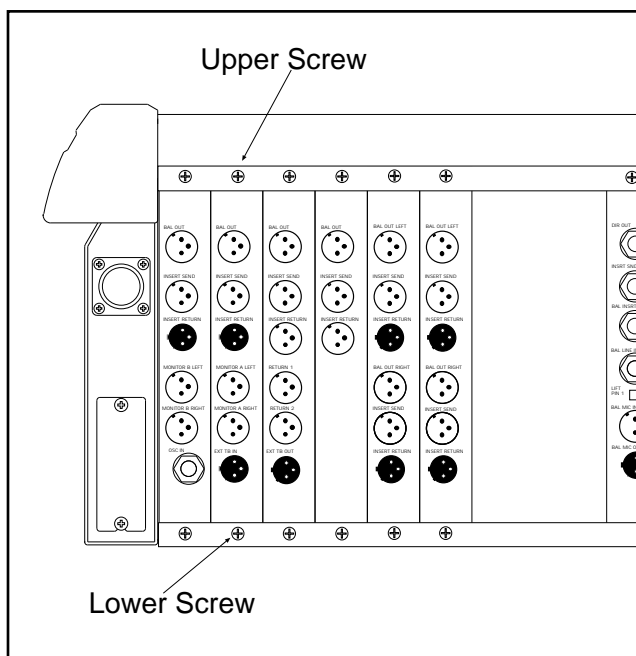

### FOUR • Lift the module(s) out

As you lift the module out of the chassis three wires must be detached before the module can be completely removed: 2 flat-wires (ribbon cables) and one ground wire.

The flat-wires are removed by flipping the latches on the ends of the connectors. Once the tabs have been flipped the connector should pull off easily.

The ground wire (green) is a spade lug which pulls off.

### FIVE • Putting it all back together

Re-assembling a Century Series console is as easy as taking it apart, but only if you know where everything goes. If you are going to be removing a number of modules, consider replacing the first before removing the second. Reversing the above steps should result in the console being as well put together as it was when it left the factory.



#### IMPORTANT



Output modules are pre-assigned at the Crest factory

These modules must always be installed in the correct positions. They are NOT interchangeable without being properly re-assigned. Please contact the Crest Audio Service Department for more information.







# Appendix B

## Glossary

## Balanced

Symmetrical audio input with three connections: signal +, signal -, and screen ground.

## Balanced Insert Return

See Insert Return

## Balanced Line In

See Line Input

## Balanced Mic In

See Microphone Input

## Balanced Mic Out

See Microphone Output

## Balanced Out

See Outputs

## DIM Switch

Introduces a -6dB drop to the output signal. This is a push on/push off switch, and allows the operator to temporarily drop the level of a monitor without actually changing any settings.

## Direct Out

This jack carries the direct output signal (post fader & post mute) from each input channel. This signal can be used for connection to recording devices or routing of the post fader signal.

## EQ IN Switch

Inserts the EQ section into the input/output channel signal. An associated LED illuminates when the switch is down.

## Equalizer Controls (Input)

There are two knobs for each of the four bands. The inner knob controls the boost or cut; while the outer knob controls the center frequency adjusted by the inner knob. These center frequencies are printed on the chassis around the outer knob. This EQ is active only when the EQ In switch is depressed.

## Equalizer Controls (Output)

Controls the equalization of the output mix signal through three bands, via six controls. The upper knob of each band determines the center frequency (high-1kHz-20kHz, mid-300Hz-8kHz, low-40Hz-1kHz), while the lower knob adjusts the amount of boost or cut.

## External Talkback Input

In addition to the mic connections on the console surface, an additional Talkback input connection is provided on the rear of the master section. Signal connected to this jack appears on the Talkback bus whenever the External TB Input switch is depressed.

## External Talkback Output

This allows the TB signals from the local mic only to be routed to an external destination such as a link to the FOH console. Signal appears on this jack when both the External TB Output switch and talkback master switches are depressed.

## Fader

Used for final output control of an input/output channel except those sends selected pre fader. (Insert Output levels are not affected by the fader position.)

## Gain Control

Adjusts input gain for proper signal level on the input. To set the gain to the best position, make sure there is signal present at the input. Depress the PFL switch on that input channel and make sure that no other PFL switches are depressed. Adjust the gain control until the SOLO meter is peaking no more than +3 level.

## Headphone Jack

Allows for connection of headphones via a 1/4" TRS plug. There are two headphone jacks: one on master module, and one underneath the armrest on the right front corner of the console. Suitable for all headphone impedances.

## Headphone Level Control

Controls the output level of both headphone jacks.

## High Pass Filter Switch

This switch inserts the High Pass Filter into the output signal. The output HPF is adjustable via the HPF frequency control.

## HPF Frequency Control

This knob adjusts the high pass filter frequency from 20Hz to 400Hz. The filter operates at a -12 dB per octave rate.

## 100 Hz High Pass Filter (Input)

Reduces all Input signal low frequency content at a 12db per octave rate referenced to 100Hz (-3db point).

## Insert

All LMx inputs and outputs have insert loops which facilitate the patching of external processing equipment into the input or output signal.

On the inputs, signal is always present at the Insert Send connection and the loop is complete when the proper connector is plugged into the Insert Return. The Insert Return can also be used as a line input when by-passing the preamp is desired.

On the outputs, signal is always present at the Insert Send connection; the loop is controlled by the Insert On switch. Depressing this switch inserts the loop into the output signal. Since this a true insert, if an incomplete loop exists, depressing the switch will mute the output.

## Input/Output Solo Indicators

These LEDs indicate what type of signal (input or output) is SOLO'd at any given time.

## Lamp Dim Control

Controls the brightness of any 12 volt lighting devices attached to the XLR connectors on the meter bridge.

## LINE Switch

Selects the input signal connected to the Balanced Line Input 1/4" TRS connector. When the switch is released the source is the XLR mic input.

## Line Input

This jack accepts balanced and unbalanced line level inputs and delivers it into the associated input channel. The input impedance is high, typically 10k $\Omega$  or more, so that the load on sources is negligible.

## Microphone Input

This connector accepts balanced microphone inputs for the associated input channel. Suitable for low output impedance dynamic and condenser microphones.

## Microphone Output

This connector is in parallel with the Balanced Mic In connector, and allows easy connection of the monitor board to the FOH console.

## Monitor

These are stereo local monitor outputs. Level is controlled via the Monitor Level control and the signal is found on balanced output connectors (two per monitor) on the rear of the master section. Each Monitor can be muted with the Monitor Mute switch..

## MUTE Switch with LED

On all inputs and outputs where this switch is present, depressing it will mute all sends. The LED illuminates when the channel is muted either from the switch or via the scene mute system.

## Output Insert - See Insert

Output EQ - See Equalizer Controls (Output)

## PAD Switch

Introduces a -15 dB drop to the mic input signal.

## PEAK LED Indicator

Illuminates RED when any of the points monitored come within 3db of the clipping point. Signal is sampled after the input preamplifier stage, after the EQ section, and after the fader.

## Phantom Power Switch

Turns on 48V Phantom Power as required by some condenser microphones for proper operation. This switch delivers +48V only when the Phantom Power Master Switch is engaged.

## Phantom Master Switch w/LED

Switches +48V phantom power on and off for the entire console.

## Power Indicators

Shows the status of the four voltages (+24, +48, +20, -20) used by the console.

## Polarity Reverse Switch

Electrically inverts the polarity of associated signal.

## Pre

Connects before the associated control. (For example: pre-fader - before the fader and therefore unaffected by fader movements.)

## Scene Mute Assignments

Assign the input channel to any of the eight scene mute groups. Scene mute combines with the module's local mute button, and actuates the local mute LED.

## Scene Mute Masters

These eight switches turn the eight scene mutes on and off for the entire console.

## Scene Mute Safe Switch

Disables any selected scene mute assignments. An associated green LED indicates the channel is in a safe state.

## Signal Present LED

This green LED constantly displays level activity of the input/output channel by varying in intensity.

## Solo

Monitoring function, combines audio with level meter checking.

## Talkback Master On/Off

Switches the internal Talkback system on and off

## TB Enable Switch

Injects the talkback signal from the master section into the associated output.

## Talkback Level Control

Adjusts the final level of all Talkback signals.

## Talkback Mic Input

Allows for connection of a gooseneck or other XLR type microphone to the Talkback system.





# Appendix C

## Schematics

LOCATION	DESCRIPTION	SCHEMATIC #	DWG #	REV #
INPUT MODULE	INPUT CONNECTOR / MIC PRE SUB	1	76D274 6/7	01
	INPUT MAIN (1 OF 2)	2	76D2744	02
	INPUT MAIN (2 OF 2)	3	76D2744	02
	INPUT MAIN SUB BOARD	4	76D2745	02
GROUP MODULE	GROUP CONNECTOR / SUB (1 OF 2)	5	76D275 0/1	01
	GROUP CONNECTOR / SUB (2 OF 2)	6	76D275 0/1	01
	GROUP MAIN (1 OF 2)	7	76D2748	02
	GROUP MAIN (2 OF 2)	8	76D2748	02
	GROUP MAIN SUB (1 OF 2)	9	76D2749	01
	GROUP MAIN SUB (2 OF 2)	10	76D2749	01
LEFT / RIGHT MODULE	L R CONNECTOR	11	76D2754	01
	L R CONNECTOR SUB	12	76D2755	01
	L R MAIN (1 OF 2)	13	76D2752	01
	L R MAIN (2 OF 2)	14	76D2752	01
	DYNAMICS SUB BOARD	15	76D2891	00
	L R MAIN SUB (1 OF 2)	16	76D2753	01
	L R MAIN SUB (2 OF 2)	17	76D2753	01
MASTER MODULE	MASTER CONNECTOR (1 OF 2)	18	76D2757	01
	MASTER CONNECTOR (2 OF 2)	19	76D2757	01
	MASTER MAIN (1 OF 2)	20	76D2756	01
	MASTER MAIN (2 OF 2)	21	76D2756	01
METER BRIDGE	DIMMER BOARD	22	N/A	N/A
	LMX METER DEMUX	23	76D2758	01
	TWO GROUP LED	24	76D2817	00
	TWO SOLO LED	25	76D2818	00
	FIVE GROUP LED	26	76D2816	00
	REMOTE VOLUME CONTROL BOARD	27	76B2942	00
RIBBON CABLE PINOUT DIAGRAMS	RIBBON PIN OUTS	28	N/A	N/A



**Crest Audio Inc.**

100 Eisenhower Dr., Paramus NJ 07652 USA

TEL: 201.909.8700 FAX: 201.909.8744

<http://www.crestaudio.com>

Printed in USA



\*D7000005\*

LMx Owner's Manual  
Copyright © 1997 Crest Audio Inc.  
v 2.5 11/3/97 D7000005