

maximum allowable wire resistance is  $(0.008 \text{ ohms} \times 1,000) \div (10 \text{ ft} \times 2) = 0.4 \text{ ohms}$  per 1,000 ft. Next, check the table to find the corresponding wire gauge. It shows that 6-gauge wire is very close with a resistance of 0.403 ohms per 1,000 feet. Answer: Use 6-gauge wire or larger.

**Tip:** If the required gauge is too large you can use more than one cable. A rule of thumb is that every time you double the number of conductors of equal gauge, you subtract 3 from the apparent gauge. In the previous example you could reduce the wire gauge to 9 by doubling the number of conductors. Or you could use four 12-gauge conductors.

### SOLVING OUTPUT PROBLEMS

Sometimes **high frequency oscillations** occur which can cause your amplifier to prematurely activate its protection circuitry and result in inefficient operation. The effects of this problem are similar to the effects of the RF problem described on page 15. To prevent high frequency oscillations from occurring:

1. Lace each loudspeaker conductor pair together. (Do NOT lace loudspeaker cables from different amplifiers together.) This minimizes the chance of them acting like an antenna to transmit or receive the high frequencies which can cause oscillation.
2. Avoid using shielded loudspeaker cable.
3. Avoid long cable runs where the loudspeaker cables from different amplifiers share a common cable tray or cable jacket.
4. Never connect the amplifier's input and output grounds together.
5. Never tie the outputs of multiple amplifiers together.
6. Keep loudspeaker cables well separated from input cables.
7. Install a low-pass filter on each input line (similar to the RF filters described in the Input Connection Section).
8. Install the input wiring according to the instructions in the Input Connection Section.

Another problem to avoid is the presence of large **subsonic currents** when primarily inductive loads are used. Examples of inductive loads are 70-V step-up transformers and electrostatic loudspeakers.

Inductive loads can appear as a "short" at low frequencies, causing the amplifier to produce large low-frequency currents and unnecessarily activate its protection circuitry. Always take the precaution of installing a high-pass filter at the inputs to the amplifier when a predominantly inductive load is used. A 3-pole (18 dB per octave) filter with a  $-3 \text{ dB}$  frequency of 50 Hz is recommended. (Depending upon your application, it may be more desirable to use a filter with an even higher  $-3 \text{ dB}$  frequency.) Such a filter should eliminate the subsonic frequency problems mentioned in the Input Connection Section.

Another way to prevent the amplifier from activating its protection systems early and also protect inductive loads from large low-frequency currents is to connect a 590 to 708 mF nonpolarized capacitor and 4 ohm, 20 watt resistor at the output of the amplifier and in series with the positive (+) lead of the transformer. This is depicted in Figure 3.14 below.

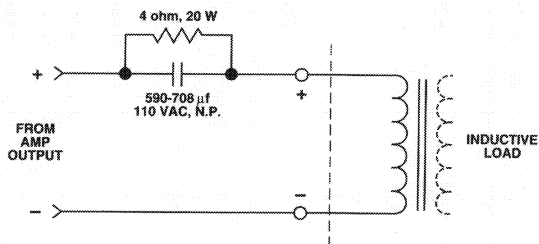

Fig. 3.14 Inductive Load (Transformer) Network

Note: The components shown in Figure 3.14 are commonly available from most electronic supply stores.

**3.3.6 Additional Load Protection**

Because the amplifier generates enormous power, it may be desirable to protect loudspeakers (or other sensitive loads) from damage due to excessive power. A common way to do this is to put a fuse in series with

the load. The fuse may be single, fusing the overall speaker system or it may be multiple, with one fuse on each driver. The nomograph in Figure 3.15 shows fuse size versus loudspeaker peak power rating. It can be used to determine what size fuse to use.

Fuses help prevent damage due to prolonged overload, but provide essentially no protection against damage from large transients. To minimize this latter problem, use high-speed instrument fuses such as the Littlefuse 361000 series. If the loudspeaker is only susceptible to damage caused by prolonged overload (such as overheating), use a fuse or circuit breaker having the same slow thermal response as the loudspeaker itself (such as a slow-blow fuse).

**3.3.7 AC Mains Power Requirements**

Each *Macro Reference* amplifier is furnished with a three-wire AC plug. Use an isolated power receptacle whenever possible with adequate current (see Section 8 for more details). Excessive line voltages 10% or higher above the rated voltage of the amplifier may cause damage. For example, do not exceed a line voltage of 132 VAC for models rated for 120 VAC operation.

All specifications in this manual are referenced at 120 VAC mains unless otherwise noted. Specifications are derived using a peak mains voltage equal to the true peak of 120 VRMS sine wave with both output channels fully loaded. Performance variations will occur at other AC mains voltages and frequencies. Line regulation problems can reduce the available power.

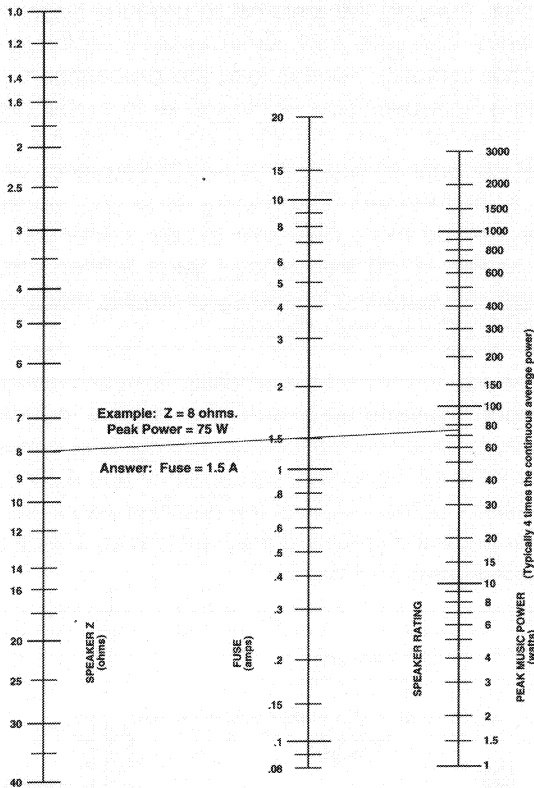

Fig. 3.15 Loudspeaker Fuse Selector Nomograph

## 4 Operation

### 4.1 Precautions

Although the *Macro Reference*, itself, is protected from external faults, the following precautions should be followed for safety and optimum operation:

1. There are important differences among the Stereo, Bridge-Mono and Parallel-Mono operating modes (see Section 3.3).



2. **WARNING: Do not change the position of the Stereo-Mono switch unless the amplifier is first turned off.**



3. **CAUTION: In Parallel-Mono mode, a jumper is used between the Ch.1 & 2 red binding posts (amplifier outputs). Be sure to remove this jumper for Bridge-Mono or Stereo mode; otherwise inefficient operation, high distortion and excessive heating will definitely occur.** Check the Stereo-Mono switch on the back panel for proper position.



4. Turn the amp off and unplug it from the AC mains before removing a *P.I.P.* module.
5. Use care when making connections, selecting signal sources and controlling the output level. The load you save may be your own.
6. Do not short the ground lead of an output cable to the input signal ground. This may form a ground loop and cause oscillations.
7. Operate the amplifier from AC mains of not more than 10% variation above or below the selected line voltage and only the specified line frequency.
8. Never connect the output to a power supply output, battery or power main. Damage incurred in this way is not covered by the warranty.
9. Tampering with the circuit by unqualified personnel, or making unauthorized circuit changes invalidates the warranty.

*Remember: Crown is not liable for any damage resulting from overdriving components in your system.*

### 4.2 Indicators

The front panel has several helpful indicator LEDs.

The **Enable indicator** is provided to show the amplifier has been turned on (or enabled) and that its low voltage power supply and on-demand forced air cooling system are working. It does not indicate the status of the high voltage power supplies. For example, the Enable indicator will stay on in the improbable event that

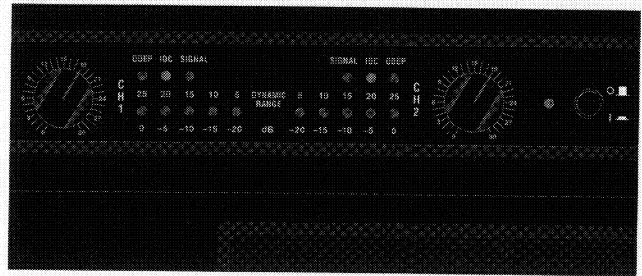

Fig. 4.1 Indicators

one or both channels overheat causing an internal shut down of the high voltage supplies.

The **ODEP indicators** glow brightly to confirm the normal operation of Crown's patented Output Device Emulation Protection circuitry. They glow brightly to show the presence of thermal-dynamic energy reserve under the present operating conditions. They dim proportionally as the energy reserve decreases. In the rare event that there is no reserve, the indicators will turn off and *ODEP* will proportionally limit the drive level of the output stages so the amplifier can continue safe operation even when the operating conditions are severe. (For a more detailed description of *ODEP*, see Section 4.3.1.)

The *ODEP* indicators also turn off if the high voltage power supplies are put in "standby" mode or the amplifier's circuit breaker is tripped. The standby mode is activated if excessive voltage, DC or heavy common-mode current is detected at an output or if the thermal protection system of the power transformer is activated. (For more information see the table in Figure 4.2 and Section 4.3.3.)

The **IOC indicators** serve as sensitive distortion meters to provide *proof of performance*. The *IOC* (Input/Output Comparator) circuitry compares the incoming signal's waveform to that of the outgoing signal. Any difference between the two is distortion. The *IOC* indicators flash if there is a difference of 0.05% or more. Because transient distortion happens quickly, a 0.1 second (approximate) "hold delay" keeps the indicators on long enough to be easily noticed. It is normal for them to light momentarily when the amplifier is first turned on. *Note: The Channel 2 IOC indicator will stay on in Parallel-Mono mode.*

The *IOC* indicators also serve as overload indicators, flashing brightly with a 0.5 second (approximate) hold delay when an excessive input signal begins to cause early clipping distortion at an input.

In abnormal situations where one or both of the amplifier's high voltage power supplies temporarily go into standby mode, the *IOC* indicators will stay on with full brightness. They resume normal operation when the amplifier is no longer in standby mode.

The **Signal presence indicators** flash synchronously with the output audio signals. A flashing indicator shows that the signal source is both at the input and output of the amplifier because it indicates that audio is present in the signal path after the input gain stages and level controls. *Note: The Signal presence indicators may not flash if the input level is low.*

The **Dynamic Range/Level meters** are five-segment

output meters which can be set to monitor either the dynamic range or the relative level of the output signal. They are initially set as dynamic range meters at the factory. A switch, located behind the front panel, selects the mode of operation (see Section 4.4 for full instructions on changing the switch). As dynamic range meters they show the ratio of the peak to average power of each channel in dB. The dynamic range may be high for some audio sources, like live audio or a quality digital or analog recording, or it may be low for other sources, like typical AM or FM radio. As output level meters they show how high the output levels are in dB relative to full power. At 0 dB the unit is at full power or 760 W into 8 ohm loads (stereo).

Indicator Status	Amplifier Condition
<p><b>ODEP IOC SIGNAL</b></p> <p>● ● ●</p> <p>OFF OFF OFF</p>	<p><b>There is no power to the amplifier.</b> Possible reasons: (1) The amplifier Enable switch is off. (2) The amplifier is not plugged into the power receptacle. (3) The AC mains circuit breaker has been tripped. (4) The amplifier rear panel reset switch has been tripped.</p>
<p><b>ODEP IOC SIGNAL</b></p> <p>○ ● ●</p> <p>ON OFF OFF</p>	<p><b>Normal operation with NO input signal.</b> Possible reasons: (1) There is no input signal. (2) The amplifier level control(s) are turned down.</p>
<p><b>ODEP IOC SIGNAL</b></p> <p>● ○ ●</p> <p>OFF ON OFF</p>	<p><b>No output: The amplifier is in standby mode.</b> Possible reasons: (1) A <i>P.I.P.</i> module like an <i>IQ-P.I.P.</i> has turned the high voltage supplies off. (2) The amplifier has just been turned on and is still in the 4 second mute delay. (3) The DC protection circuitry has been activated. (4) The fault protection circuitry has been activated. (5) The transformer thermal protection circuitry has been activated. (6) The over-voltage protection circuitry has been activated.</p>
<p><b>ODEP IOC SIGNAL</b></p> <p>● ● ○</p> <p>OFF OFF Flash</p>	<p><b>ODEP limiting is about to begin.</b> Possible reasons: (1) The amplifier air filters are blocked and need to be cleaned. (2) There is insufficient cooling—inadequate air flow and/or the air is too hot. (3) The amplifier is driving too many loudspeakers for the selected stereo-mono mode—the load impedance is too low. (4) The amplifier is continuously operating at a high level with a high input signal.</p>
<p><b>ODEP IOC SIGNAL</b></p> <p>○ ● ○</p> <p>ON OFF Flash</p>	<p><b>Normal operation with an input signal.</b> The <i>ODEP</i> indicator will stay on at full intensity to show that there is reserve thermal-dynamic energy and the Signal presence indicator will flash to show that an audio signal is present.</p>
<p><b>ODEP IOC SIGNAL</b></p> <p>● ○ ○</p> <p>OFF ON Flash (ON)</p>	<p><b>Distorted output: ODEP limiting has been activated.</b> Possible reasons: (1) The amplifier air filters are blocked and need to be cleaned. (2) There is insufficient cooling—inadequate air flow and/or the air is too hot. (3) The amplifier is driving too many loudspeakers for the selected Stereo-Mono mode—the load impedance is too low. (4) The amplifier is continuously operating at a high level with a high input signal.</p>
<p><b>ODEP IOC SIGNAL</b></p> <p>○ ○ ○</p> <p>ON (Flash) (Flash)</p>	<p><b>The output is exceeding 0.05% distortion.</b> Possible reason: The input signal level is too high.</p> <p style="text-align: center;">OR</p> <p><b>Channel 2 only: The amplifier is in Parallel-Mono mode.</b> The Channel 2 Signal/<i>IOC</i> always turns on to full brightness whenever the amplifier Stereo-Mono switch is moved to the Parallel-Mono position.</p>

Fig. 4.2 ODEP, IOC and Signal Presence Indicator Status

## 4.3 Protection Systems

The *Macro Reference* includes several protection systems that enable it to weather harsh operating environments. The preceding chart in Figure 4.2 shows how their operation can be observed with the indicators.

### 4.3.1 ODEP

Crown invented *ODEP* to solve two long-standing problems in amplifier design: To prevent amplifier shutdown during demanding operation and to increase the efficiency of output circuitry.

To do this, Crown established a rigorous program to measure the *safe operating area* (SOA) of each output transistor before installing it in an amplifier. Next, Crown designed intelligent circuitry to simulate the instantaneous operating conditions of those output transistors. Its name describes what it does: Output Device Emulation Protection or *ODEP*. It not only simulates the operation of the output transistors but it also compares their operation to their known SOA. If it sees that more power is about to be asked of them than they are capable of delivering under present conditions, it immediately limits their drive level until it falls within their SOA. The limiting is proportional and is kept to an absolute minimum—only what is required to prevent output transistor damage.

This level of protection enables Crown to increase output efficiency to never-before-achieved levels while at the same time greatly increasing amplifier reliability.

This on-board intelligence is monitored two different ways. First, there are *ODEP* indicators provided on the front panel to show that everything is functioning perfectly and to alert if limiting begins. Second, *ODEP* data is fed to the *P.I.P.* connector at the back of the amplifier so advanced *P.I.P.* modules like the *IQ-P.I.P.* can use it to make decisions and control the amplifier.

With *ODEP* the show won't stop because you get the maximum power with the maximum protection.

### 4.3.2 Standby Mode

At the heart of the protection systems is the standby mode which removes power from the high voltage supplies to protect both the amplifier and the loads connected to it.

The standby mode can be activated by four different situations. First, if dangerous subsonic frequencies or direct current (DC) are detected in the amplifier's output, the unit will activate its **DC / low frequency protection** circuitry and cause the affected channel(s) to go into standby mode. This protects the loads and

prevents oscillations. The unit resumes normal operation just as soon as the amplifier no longer detects dangerous low frequency or DC output. Although it is extremely unlikely that you will ever activate the amplifier's DC / low frequency protection system, improper source materials such as square waves or input overloads that result in excessively clipped signals can activate this system.

The amplifier's **fault protection** system will place an amplifier channel into standby mode in rare situations where heavy common-mode current is detected in the channel's output. The amplifier should never output heavy common-mode current unless its circuitry is damaged in some way. Going into standby mode prevents further damage.

The amplifier's **transformer thermal protection** circuitry is activated in very unusual circumstances where the unit's transformer temperature rises to unsafe levels. Under these abnormal conditions, the amplifier will place both channels into standby mode. The amplifier will return to normal operation after the transformer cools to a safe temperature. See Section 4.3.3.

The amplifier's **overvoltage protection** circuitry will also place the amplifier into standby mode whenever excessive voltage is detected. Remember that the unit should not be operated with AC mains that are over 10% above the rated voltage of your unit.

### 4.3.3 Transformer Thermal Protection

All *Macro Reference* amplifiers have transformer thermal protection. It protects the power supplies from damage in the rare event that the temperature of the power transformer rises too high.

A thermal switch embedded in the power transformer removes power to the high voltage power supplies if it detects excessive heat. If this happens, the *ODEP* and Signal indicators will turn off and the *IOC* indicators will turn on. The switch automatically resets itself as soon as the transformer has cooled to a safe temperature. After it resets, the amplifier returns to normal operation.

It is extremely unlikely that you will ever see a *Macro Reference* amplifier activate transformer thermal protection as long as the amplifier is operated within rated conditions (see the specifications in Section 7). *ODEP* is designed to keep the amplifier working under very severe conditions. Even so, higher than rated output levels, excessively low impedance loads and unreasonably high input signals can generate more heat in the transformer than in the output devices and cause this protection system to activate.

Macro Reference amplifiers are designed to keep working long after other amplifiers would have failed. But even when the limits of a Macro Reference are exceeded, it will still protect itself—and your investment—from damage.

**4.3.4 Circuit Breaker**

A circuit breaker is provided on the back panel to prevent excessive current being drawn by the high voltage power supplies. Units rated for 100-120 VAC power have a 30 amp circuit breaker. Units rated for 220-240 VAC power have a 15 amp circuit breaker.

**4.4 Controls**

The **Enable switch** is located on the front panel so you can easily turn the amplifier on or off. If you ever need to make any wiring or installation changes, don't forget to disconnect the power cord also. Please follow these steps when first turning on your amplifier:

1. Turn down the level of your audio source. Example: Turn down the master volume of your mixer.
2. Turn down the Level controls of the amplifier (if they are not already down).
3. Turn on the Enable switch. The Enable indicator beside the switch should glow. During the four second mute delay which immediately follows, the *IOC* and Signal presence indicators may flash unpredictably and the *ODEP* indicators will stay off. After the mute delay, the *ODEP* indicators should come on with full brilliance and the *IOC* and Signal

presence indicators should function normally. Remember, the Channel 2 *IOC* indicator will remain on when the amplifier is in Parallel-Mono mode.

4. After the mute delay, turn up the level of your audio source to the maximum desired level.
5. Turn up the Level controls of the amplifier until the maximum desired sound level is achieved.
6. Turn down the level of your audio source to its normal range.

For ease of use, the **Level controls** are also located on the front panel. Each control has 31 detents to help you repeat an exact setting. Important: In either Bridge-Mono or Parallel-Mono mode turn down the Channel 2 Level control and use only the Channel 1 control.

The **Meter Mode switch** is located behind the front panel. Use it to select the operating mode of the meters. To change it follow these steps:

1. Turn the amplifier off and disconnect its power cord from the AC mains power receptacle.
2. Remove the front panel (four Phillips-head screws).
3. Locate the Meter Mode switch as shown in Figure 4.3. Slide it to the left if you want the meter to function as an output level meter. Slide it to the right if you want it to indicate the dynamic range of the output signal.
4. Replace the front panel and reconnect the power cord.

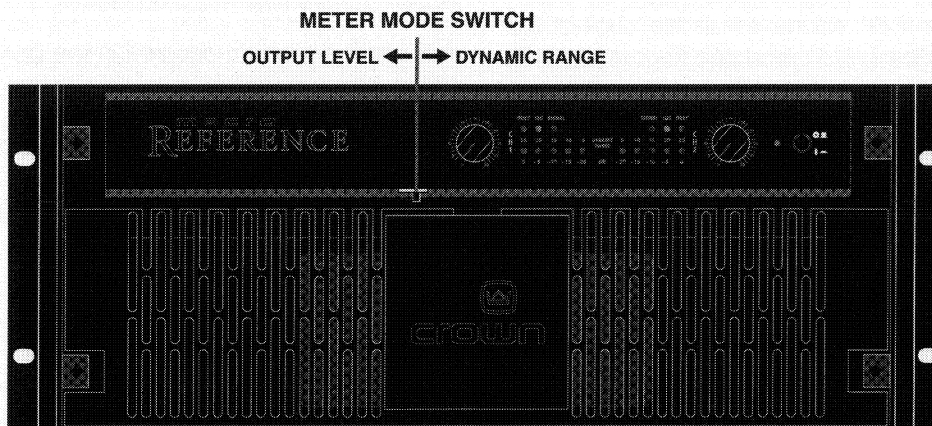

Fig. 4.3 Meter Mode Switch

The **Input Sensitivity switch** is located inside the rear of the amplifier and is factory-set to a fixed voltage gain of 26 dB. This is equivalent to an input sensitivity of 3.9 V for rated output into 8 ohms. If desired, it can be switched to a sensitivity of 0.775 V or 1.4 V. Here is the procedure:

1. Turn off the amplifier and disconnect its power cord from the AC mains power receptacle.
2. Remove the *P.I.P.* module (two screws).
3. Locate the sensitivity switch access hole inside the chassis opening as shown in Figure 4.4. It is located just above the phone jack inputs.
4. Set the switch to the desired position noted on the access-hole label.
5. Replace the *P.I.P.* module and reconnect the power cord.

#### INPUT SENSITIVITY SWITCH INSIDE ACCESS HOLE

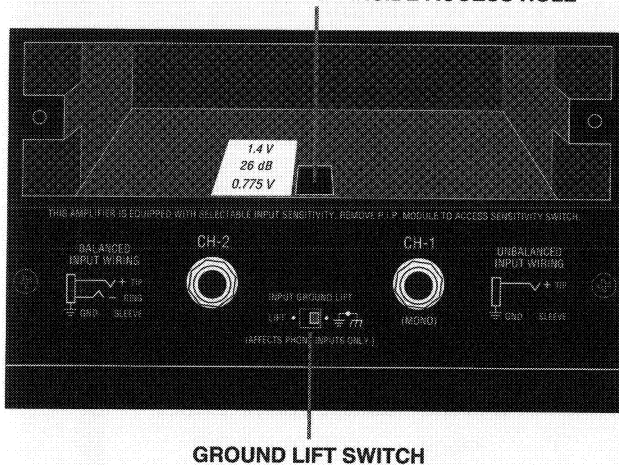

Fig. 4.4 Input Sensitivity and Ground Lift Switches

The **Ground Isolation switch** is located on the rear panel and can provide isolation between the phone jack input signal ground and the AC ground. It affects only the phone input jacks and has no effect on the input connectors on the *P.I.P.* module. Sliding the switch to the left isolates or “lifts” the grounds by placing an impedance between the sleeve of each phone input jack and the circuit ground.

*Note: When a P.I.P. module is plugged into the amplifier, only the noninverted and inverted signal lines are connected in parallel with the corresponding lines of the input phone jacks. The signal grounds are not parallel. For example, XLR pins 2 and 3 are connected in parallel with the tip and ring of the corresponding phone jack. However, pin 1 of the XLR is not connected in parallel with the sleeve of the phone jack.*

The **Reset switch** is located on the rear panel to protect the power supplies against overload. Switching it to the left disconnects the power cord from the power supplies. Switching it to the right reconnects the power cord to the power supplies. If the reset switch trips, the Enable indicator will turn off. If this should ever happen, turn off the Enable switch and flip the Reset switch back to the on position. Then turn the Enable switch back on. If it trips again or the amplifier fails to operate properly, contact an authorized service center or Crown's Technical Support Group.

#### 4.5 Filter Cleaning

Dust filters are provided on the air intakes to the cooling system. If this filter becomes clogged, the unit will not cool as efficiently as it should and may produce lower-than-normal output levels due to high heat diffuser temperature. The cleaning instructions for the dust filter vary slightly depending upon the type of front panel your *Macro Reference* has.

To clean, remove the front panel (four Phillips-head screws). The filters are permanently attached to the front panels of engraved electroluminescent units.

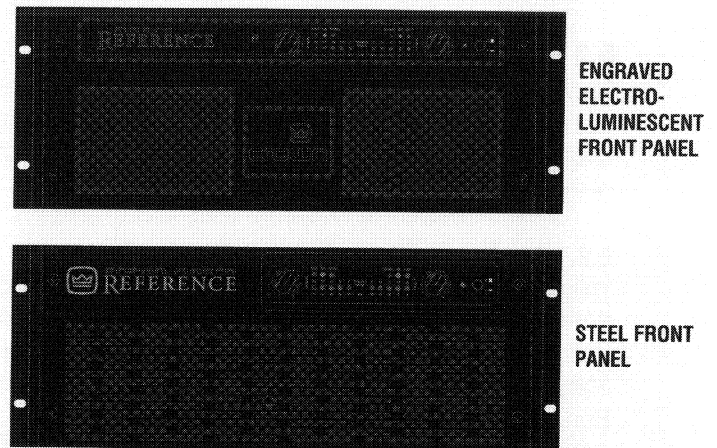

Fig. 4.5 Macro Reference Front Panels

Clean their filters and front panel as a unit. Units with steel front panels have a single separate filter element behind the front panel that can be easily removed and cleaned separately. Use mild dishwashing detergent and warm water to clean the filter(s) and dry them thoroughly before reassembly.

Dust filters are not 100% efficient—long term this may require that the internal heat diffusers be cleaned by a qualified technician. Internal cleaning information is available from our Technical Support Group.

## 5 Service

This unit has very sophisticated circuitry which should only be serviced by a fully trained technician. This is one reason why each unit bears the following label:



**CAUTION: TO PREVENT ELECTRIC SHOCK DO NOT REMOVE COVERS. NO USER SERVICEABLE PARTS INSIDE. REFER SERVICING TO A QUALIFIED TECHNICIAN.**

### 5.1 Worldwide Service

Service may be obtained from an authorized service center. (Contact your local Crown/Amcron representative or our office for a list of authorized service centers.) To obtain service, simply present the bill of sale as proof of purchase along with the defective unit to an authorized service center. They will handle the necessary paperwork and repair.

Remember to transport your unit in the original factory pack. We will pay the surface shipping costs both ways **for warranty service** to the authorized service center nearest to you after receiving copies of all shipping receipts. You must bear the expense of all taxes, duties, and customs fees when transporting the unit.

### 5.2 North American Service

Service may be obtained in one of two ways: from an authorized service center or from the factory. You may choose either. It is important that you have your copy of the bill of sale as your proof of purchase.

#### 5.2.1 Service at a North American Service Center

This method usually saves the most time and effort. Simply present your bill of sale along with the defective unit to an authorized service center to obtain service. They will handle the necessary paperwork and repair. Remember to transport the unit in the original factory pack. A list of authorized service centers in your area can be obtained from our Technical Support Group.

#### 5.2.2 Factory Service

To obtain factory service, fill out the *Service Information Card* in the back of this manual and send it along with proof of purchase and the defective unit to the Crown factory. Enclose a letter explaining the nature of the problem and what service you would like. Include your return shipping address and telephone number.

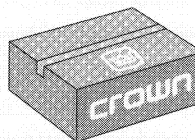

**Always use the original factory pack to transport the unit.**

**The unit must be shipped in the original factory pack.** If you don't have the original shipping container, contact us and a replacement will be sent promptly.

Crown will pay ground shipping costs both ways in the United States **for warranty service** upon receiving copies of all shipping receipts. Shipments should be sent "UPS ground." (If the unit is under warranty, you may send it C.O.D. for the cost of shipping via UPS ground.) The factory will return the unit via UPS ground. Please contact us for other arrangements.

#### **Crown Audio Division**

Tech. Support / Factory Service  
57620 County Road 105  
Elkhart, Indiana 46517 U.S.A.

Phone: 1-219-294-8200

U.S.A.: 1-800-342-6939

Fax: 1-219/294-8301



## 6 Technical Information

### 6.1 Overview

The *Macro Reference* incorporates several new technological advancements including real-time computer simulation, low-stress output stages, and an advanced thermal diffuser embodiment.

Extra circuitry limits temperature and current to safe levels—making it highly reliable and tolerant of faults. Unlike many lesser amplifiers, it can operate at its voltage and current limits without damage.

The *Macro Reference* is protected against all common hazards that plague high-power amplifiers, including shorted, open or mismatched loads; overloaded power supplies; excessive temperature, chain-destruction phenomena, input-overload damage, and high-frequency blowups. The unit protects loudspeakers from DC in the input and output signal and from turn-on/turn-off transients.

Real-time computer simulation is used to create an analog of the junction temperature of the output transistors (herein referred to as the output devices). Current is limited only when the device temperature becomes excessive—and just by the minimum amount necessary. This patented approach maximizes the available output power and eliminates overheating—the major cause of device failure.

The four-quadrant topology used in the *Macro Reference* output stages is called the *grounded bridge*, and makes full use of the power supply at all times. This patented topology also provides peak-to-peak voltages available to the load that are four times the voltage the output devices are exposed to.

The *grounded bridge* topology is ground-referenced. Composite devices are constructed to function as gigantic NPN and PNP devices, since the available currents exceed the limits of available devices. Each output stage has two of these composite NPN and PNP devices.

The devices connected to the load are referred to as “high-side NPN and PNP” and the devices connected to ground are referred to as “low-side NPN and PNP.” Positive current is delivered to the load by increasing conductance simultaneously in the high-side NPN and low-side PNP stage, while decreasing conductance of the high-side PNP and low-side NPN in synchrony.

The two channels may be used together to double the voltage (bridge-mono) or the current (parallel-mono) presented to the load. This feature gives the user flex-

ibility in maximizing the power available to the load.

A wide-bandwidth multiloop design is used for state-of-the-art compensation. This produces ideal behavior and ultra-low distortion values.

Aluminum extrusions have been widely used for heatsinks in power amplifiers due to their low cost and reasonable performance. However, measured on a watts per pound or watts per volume basis, the extrusion technology doesn't perform nearly as well as the thermal diffuser technology developed for the *Macro Reference*.

Our thermal diffusers are fabricated from custom convoluted fin stock that provides an extremely high ratio of area to volume, or area to weight. Since all the output devices are mounted directly to the diffusers they are electrically “live.” Making them electrically live allows improved thermal performance by eliminating the insulating interface underneath the output devices. The chassis itself is used as part of the thermal circuit, maximizing available cooling resources.

### 6.2 Circuit Theory

Power is provided by low-field toroidal power transformer T1. The secondaries of T1 are full-wave rectified by D17, D18, D1-4 and filtered by large computer-grade capacitors. A thermal switch embedded in the transformer protects it from overheating. Monolithic regulators provide a regulated  $\pm 15$  volts.

#### 6.2.1 Stereo Operation

For simplicity, the discussion of stereo operation will refer to one channel only. Mono operations will be discussed later. Please refer to the block diagram in Figure 6.1 and the schematics provided.

The input signal at the phone jack passes directly into the balanced gain stage (U104-A). Use of a *P.I.P.* module for input signal causes the input signal to pass through the *P.I.P.* and then to the balanced gain stage.

The balanced gain stage (U104-A) causes balanced-to-single-ended conversion to take place using a difference amplifier. From there, gain is controlled with the front-panel level controls and the internal input sensitivity switch. (The input sensitivity switch is located through the *P.I.P.* opening in the rear panel. See page 23.) The error amp (U104-C) amplifies the difference between the output signal and the input

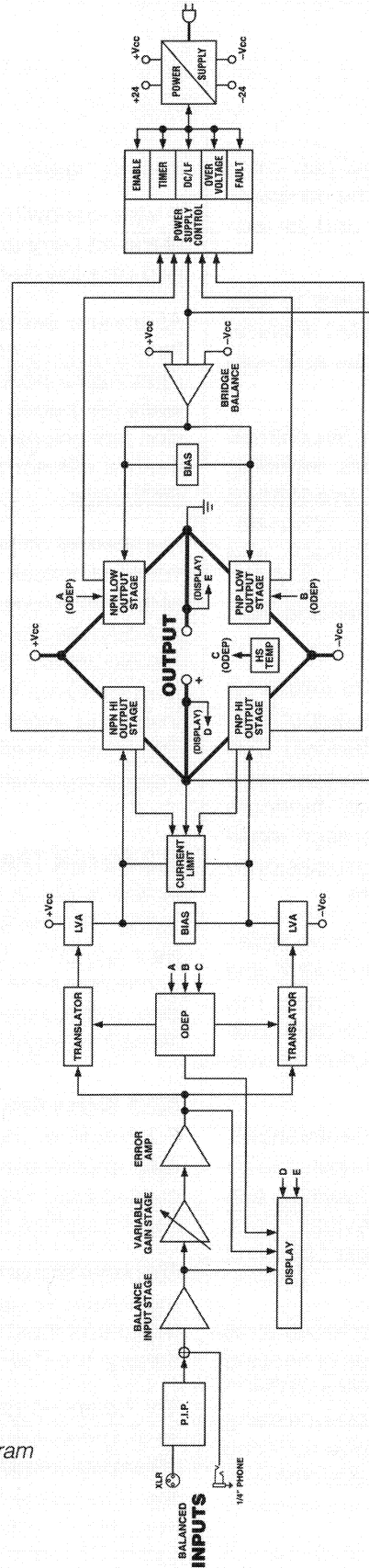

ONLY ONE CHANNEL SHOWN

Fig. 6.1 Circuit Block Diagram

signal from the gain stage, and drives the voltage-translator stage.

The voltage-translator stage channels the signal to the Last Voltage Amplifiers (LVA), depending on the signal polarity, from the error amp U104-C. The +LVA (Q104,Q105) and the -LVA (Q110,Q111), with their push-pull effect through the bias servo Q318, drive the fully complementary output stage.

The bias servo Q318 is thermally coupled to the thermal diffuser, and sets the quiescent bias current in the output stage to lower the distortion in the crossover region of the output signal.

With the voltage swing provided by the LVAs, the signal then gains current amplification through the triple Darlington emitter-follower output stage.

The bridge-balanced circuit (U104-D) receives a signal from the output of the amplifier, and differences it with the signal at the VCC supply. The bridge-balanced circuit then develops a voltage to drive the bridge-balanced output stage. This results in the VCC supply having exactly one-half of the output voltage added to their quiescent voltage. Bias servo Q300 sets the quiescent current point for the bridge-balanced output stage.

The protection mechanisms that affect the signal path are implemented to protect the amplifier under real-world conditions. These conditions are high instantaneous current, excessive temperature, and operation of the output devices outside safe conditions.

Q107 and Q108 act as a conventional current limiter, sensing current in the output stage. When current at any one instant exceeds the design criteria, the limiters attenuate the drive from the LVAs, thus limiting current in the output stage to a safe level.

To further protect the output stages, a specially developed *ODEP* circuit is used (Output Device Emulation Protection). It produces an analog output proportional to the always-changing *safe operating area* margin of the output transistor. This output controls the translator stage previously mentioned, removing any further drive that may exceed the *safe operating area* of the output stage.

Thermal sensor S100 gives the *ODEP* circuits vital information on the operating temperature of the thermal diffusers on which the output devices are mounted.

A DC protection circuit continuously monitors the outputs. If it senses the presence of DC across the output leads and shuts down the power supply until the DC is removed. This protects the load from DC no matter what the cause.

### 6.2.2 Bridge-Mono Operation

By setting the rear panel Stereo-Mono switch to Bridge-Mono, the user can convert the amplifier into a bridge-mono amplifier. With a signal applied to the Channel 1 input jack, and the load between the red banana posts on the back panel, a double-voltage output occurs.

The Channel 1 output feeds the Channel 2 error amp U204-C. Since there is a net inversion, Channel 2 output is out of polarity with Channel 1. This produces twice as much voltage across the load. Each of the channel's protection mechanisms work independently if a fault occurs.

### 6.2.3 Parallel-Mono Operation

With the Stereo-Mono switch set to Parallel-Mono, the output of Channel 2 is paralleled with that of Channel 1. A suitable high-current-handling jumper must be connected across the red banana posts to gain the benefits of this mode of operation.

The signal path for Channel 1 is the same as previously discussed, except that Channel 1 also drives the output stage of Channel 2. The balanced input, error amp, translators, and LVAs of Channel 2 are disconnected and no longer control the Channel 2 output stage. The Channel 2 output stage and protection mechanisms are also coupled through S1 and function as one.

In Parallel-Mono mode, twice the current of one channel can be obtained. Since the *ODEP* circuit of Channel 2 is coupled through S1, this gives added protection if a fault occurs in the Channel 2 output stage. The *ODEP* circuit of Channel 2 will limit the output of both output stages by removing the drive from the Channel 1 translator stages.

## 7 Specifications

### Performance

*Note: The following applies to 120 VAC units in Stereo mode with 8 ohms loads and an input sensitivity of 26 dB gain unless otherwise specified.*

**Frequency Response:**  $\pm 0.1$  dB 20 Hz to 20 kHz at 1 watt.

**Signal to Noise Ratio:** Greater than 120 dB (A-weighted) below rated output at 26 dB gain.

**Bandwidth:** 3 Hz to 100 kHz.

**IM Distortion (IMD):** Less than 0.005% from 760 W through  $-10$  dB, increasing smoothly to a maximum of 0.025% at  $-40$  dB, measured at 26 dB gain.

**Damping Factor:** Greater than 20,000 from 10 Hz to 200 Hz. 1,800 at 1 kHz.

### Power

#### Power Bandwidth:

- 10 Hz to 25 kHz  $-1.0$  dB.
- 7 Hz to 27 kHz  $-1.5$  dB.
- 5 Hz to 28 kHz  $-2.0$  dB.
- 4 Hz to 30 kHz  $-3.0$  dB.

#### Output Power:

*Note: Watts per channel in Stereo mode with 0.025% or less THD while both channels are driven.*

- 760 watts into 8 ohms.
- 1,160 watts into 4 ohms.

**Load Impedance:** Rated for 4–16 ohm usage only. Safe with all types of loads, even reactive ones.

**Required AC Mains:** 50/60 Hz, 120 VAC  $\pm 10\%$ . (Also available for 100, 200, 220/230 and 240 VAC.) Draws less than 90 watts at idle. With a continuous 760 watt 1 kHz sinewave output into 8 ohms in Stereo mode, as many as 26 amps are drawn from a 120 VAC source.

*It is extremely important to have adequate AC power for the amplifier. Power amplifiers cannot create energy—they must have the required **voltage and current** to deliver the undistorted rated power you expect.*

### Controls

**Enable:** A push-button located on the front panel to turn the amplifier on and off.

**Level:** A signal level control with 31 detents for each channel, located on the front panel.

**Stereo-Mono:** A three-position switch located on the back panel which selects between Stereo, Bridge-Mono, and Parallel-Mono modes of operation.

**Input:** A three-position switch located inside the amplifier selects between three input sensitivities: 1) A sensitivity of 0.775 V for full rated output; 2) A fixed voltage gain of 26 dB; or 3) A sensitivity of 1.4 V for full rated output.

**Meter Mode:** A two-position switch located behind the front panel which sets the output display meter on the front panel a either a dB Dynamic Range meter or a dB Level meter.

**Ground Lift:** A two-position switch located on the back panel which can be used to isolate the audio signal ground from the chassis (AC) ground.

**Reset:** 30-amp circuit breaker located on the back panel which protects the power supplies.

### Indicators

**Enable:** This indicator is on while the amplifier is on to show that the low-voltage power supply is operating.

**ODEP:** Two multifunction indicators that show the thermal-dynamic reserve energy status of each channel. Normally they are brightly illuminated to show that reserve energy is available. In the rare event there is no reserve, they will dim in proportion to ODEP limiting. They remain off if a tripped breaker, blown fuse or thermal shutdown occurs. (In the case of a thermal shutdown, the amplifier will automatically return to normal operation after cooling.)

**IOC:** Normally off, these two indicators flash in the unlikely event the output waveform differs from that of the input by 0.05% or more. In this way, they act as sensitive distortion indicators to provide dynamic proof of performance. *Note: It is normal for the Channel 2 IOC indicator to remain on in Parallel-Mono mode.*

**Signal:** Two Signal presence indicators flash in sync with the audio signal to show its presence.

**Dynamic Range / Level Meter:** Two five-segment meters (one per channel) display either the output dynamic range in dB or the output level in dB. (Your unit comes factory-set to display dynamic range.) As dynamic range meters they show the ratio of the peak to average power of each channel. As output level

meters they show how high the output levels are relative to full power.

### Input/Output

**Input Connector:** Balanced phone jacks on chassis and internal *P.I.P.* connector. (Balanced 3-pin XLR connectors are provided on P.I.P.-FX which is a standard feature.)

**Input Impedance:** Nominally 10 K ohms, balanced. Nominally 5 K ohms, unbalanced.

**Input Sensitivity:** Switchable between 0.775 V or 1.4 V for rated output or a fixed voltage gain of 26 dB. (See Section 4.4 for more information.)

**Output Connector:** Two pair of color-coded 5-way dual binding posts (banana jacks) for each channel.

**Output Impedance:** Less than 10 milliohms in series with less than 2 microhenries.

**DC Output Offset:** (Shorted input)  $\pm 2$  millivolts.

### Output Signal

**Stereo:** Unbalanced, two-channel.

**Bridge-Mono:** Balanced, single-channel. Channel 1 controls are active; Channel 2 controls are inactive and not removed from operation.

**Parallel-Mono:** Unbalanced, single-channel. Channel 1 controls are active; Channel 2 controls are inactive but not removed from operation.

### Protection

If unreasonable operating conditions occur the protection circuitry limits the drive level to protect the output transistor stages, particularly in the case of elevated temperature. Transformer overheating will result in a temporary shutdown. Controlled slew-rate voltage amplifiers protect the unit against RF burnouts. Input overload protection is furnished at the amplifier input to limit current.

**Turn On:** No dangerous transients. Four second turn-on delay. *Note: This may be changed by resistor substitution. Contact Crown's Technical Support Group for details.*

### Construction

Black splattered-coat steel chassis. The chassis utilizes specially designed "flow-through" ventilation from front to side. Two front styles are available. One has a deluxe engraved electroluminescent backlit front panel and the other has a steel front panel.

**Cooling:** Convection cooling with computerized, on-demand proportional fan assist. Includes custom heat diffusers and patented circuitry for uniform dissipation.

**Dimensions:** 19 inch (48.3 cm) standard rack mount (EIA Std. RS-310-B), 7 inch (17.8 cm) height, 16 inch (40.6 cm) depth behind mounting surface, 2.75 inch (7 cm) in front of mounting surface.

**Weight:** 56.5 lbs (25 kg). Center of gravity is approximately 6 inches (15 cm) behind front mounting surface. Shipping weight is approximately 70 lbs (31 kg).

## 8 AC Power Draw & Thermal Dissipation

This section provides detailed information about the amount of power and current drawn from the AC mains by a *Macro Reference* and the amount of heat produced under various conditions. The calculations presented here are intended to provide a very realistic and reliable depiction of the amplifiers. The following assumptions were made:

- The amplifier efficiency at full rated power is estimated to be 65%.
- Quiescent power draw is assumed to be 90 watts (an almost negligible amount for full-power calculations). Actually, the *Macro Reference* is less than 90 watts.
- Quiescent thermal dissipation equals 105 btu/hr at 90 watts.
- Amplifier output power is the maximum average rating at the specified load.
- Duty cycle of pink noise is 50%.
- Duty cycle of highly compressed rock n' roll midrange is 40%.
- Duty cycle of rock n' roll is 30%.
- Duty cycle of background music is 20%.
- Duty cycle of continuous speech is 10%.
- Duty cycle of infrequent, short duration voice paging is 1%.

Here are the equations used to calculate the data presented in Figure 8.1:

$$\text{AC Mains Power Draw (watts)} = \frac{\text{Rated amplifier output with both channels driven (watts)} \times \text{Duty Cycle}}{\text{Amplifier Efficiency (.65)}} + \text{Quiescent Power Draw (90 watts)}$$

The ambient power draw of 90 watts is a maximum figure, and assumes the cooling fan is running.

$$\text{Thermal Waste (btu/hr)} = \left[ (1 - \text{Power to Loads}) + \frac{\text{Ambient Power Draw (90 watts)}}{\text{Draw (90 watts)}} \right] \times 3.415$$

OR

$$\text{Thermal Dissipation (btu/hr)} = \left( \frac{\text{Rated amplifier output both channels (watts)} \times \text{Duty Cycle} \times .35}{\text{Amplifier Efficiency (.65)}} + \text{Quiescent Power Draw (90 watts)} \right) \times 3.415$$

The constant 0.35 is the inefficiency (1.00-0.65) and the factor 3.415 converts watts to btu/hr. Thermal dissipation in btu is divided by the constant 3.968 to convert to kcal.

To change the power draw in watts to current draw in amperes, use the following equation:

$$\text{Current Draw (amperes)} = \frac{\text{AC Mains Power Draw (watts)}}{\text{AC Mains Voltage} \times \text{Power Factor (.83)}}$$

The current draw values shown in Figure 8.1 depend on the AC mains voltage (power draw and thermal dissipation are typical for any AC voltage).

**Macro Reference**

Duty Cycle	LOAD														
	8 Ohm Stereo				4 Ohm Stereo / 8 Ohm Bridge-Mono / 2 Ohm Parallel-Mono				2 Ohm Stereo / 4 Ohm Bridge-Mono / 1 Ohm Parallel-Mono						
	AC Mains Power Draw (Watts)	Current Draw (Amps)		Thermal Dissipation		AC Mains Power Draw (Watts)	Current Draw (Amps)		Thermal Dissipation		AC Mains Power Draw (Watts)	Current Draw (Amps)		Thermal Dissipation	
	100-120 V	220-240 V	btu/hr	kcal		100-120 V	220-240 V	btu/hr	kcal		100-120 V	220-240 V	btu/hr	kcal	
50%	205	2.1	1.1	445	115	270	2.7	1.4	520	130	320	3.2	1.6	585	145
40%	325	3.3	1.7	585	150	445	4.5	2.3	735	185	550	5.5	2.8	860	215
30%	440	4.4	2.2	725	185	625	6.3	3.2	945	240	780	7.9	4.0	1135	285
20%	560	5.6	2.8	865	220	805	8.1	4.1	1160	293	1015	10.2	5.1	1410	355
10%	675	6.8	3.4	1005	255	980	9.9	5.0	1375	345	1245	12.5	6.3	1685	425

Fig. 8.1 Power Draw, Current Draw and Thermal Dissipation at Full Rated Power for the Listed Duty Cycles

## 9 Accessories

### 9.1 P.I.P. Modules

One advantage of using a *Macro Reference* is the ability to customize it using *P.I.P.* (Programmable Input Processor) modules. Each *Macro Reference* is equipped with a *P.I.P.* card edge connector inside the back panel. The modules install easily:

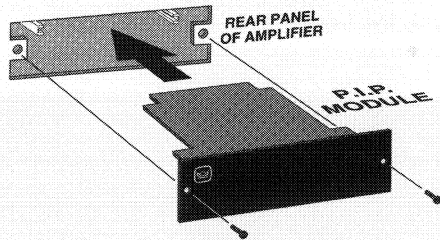
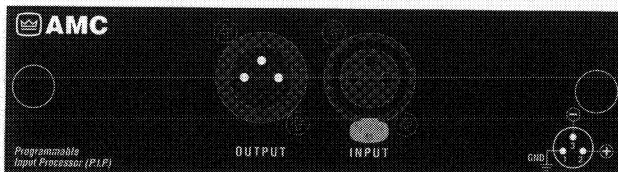

Fig. 9.1 Installing a P.I.P. Module

**WARNING: Disconnect power to the amplifier when installing or removing a P.I.P. module.**

Here are some of the available *P.I.P.* modules:



**P.I.P.-AMC** unites many features of the *P.I.P.*-XOV and *P.I.P.*-CLP. It offers a variable 4th-order Linkwitz-Riley and an *IOC*-driven, variable threshold compressor. In addition, it provides “constant-directivity” horn equalization and filter-assisted  $B_6$  vented box equalization. Biamping and triamping capabilities are provided via XLR connectors.

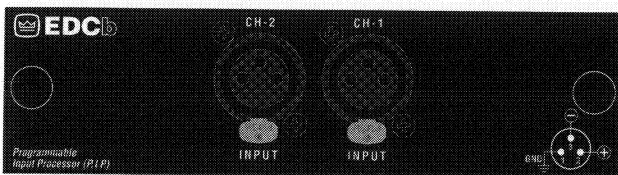

**P.I.P.-EDCb** combines a sophisticated error-driven compressor and smooth limiter with a subsonic filter on each channel. The compressors have adjustable attack and release times and can be set to track each other. The compressors activate when an input signal is large enough to clip the input, an *IOC* error occurs, or the output exceeds its threshold. The subsonic filters have corner frequencies of 24, 28, 32 and 36 Hz.

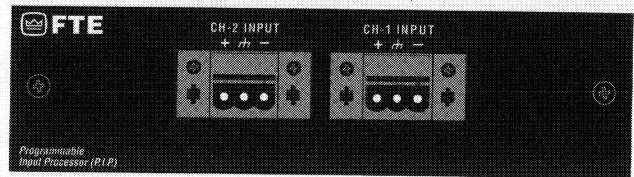

**P.I.P.-FTE** includes all *P.I.P.*-FXT features, and adds 12 dB/octave RFI filters, variable 18 dB/octave high-pass filters, and 6 dB/octave 3 kHz shelving networks for “constant-directivity” horn equalization. Quick-connect barrier blocks are provided for input.

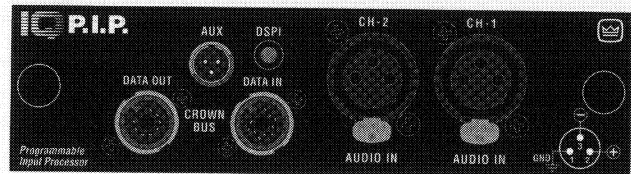

**IQ-P.I.P. v1.3** integrates the amplifier into Crown’s patented *IQ System*®. The *IQ System* provides centralized computer control of 1 to 2,000 amplifiers. Each amplifier channel can be monitored and controlled from an inexpensive personal computer. Mic and/or line level signals can also be controlled and routed with optional *MPX-6*™, *SMX-6*™ or *AMB-5*™ mixer/multiplexers, as well as the *MRX* series matrixers.

**IQ-P.I.P. v1.4 Smart Amp**™ offers the monitoring and control features of the *IQ-P.I.P. v1.3* plus the capability to function as a stand-alone unit as a part of *IQ System’s distributed intelligence*™. Features include a smooth output limiter for “transparent” loudspeaker protection, power supply gates for reduced energy consumption, *ODEP* conservation that protects the output devices with precision input signal control, interrupt-driven reporting that lets you define the error conditions and configurable electrical short detection.

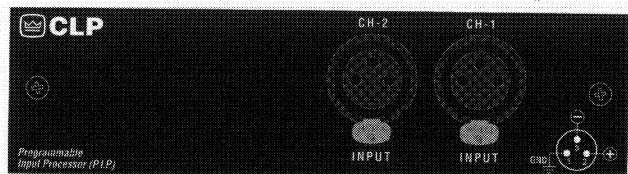

**P.I.P.-CLP** is designed to detect and prevent overload. Its compressor is driven by the amplifier’s built-in *IOC* error detection circuitry. Unlike typical signal-driven compressors, it only compresses the signal to prevent overload. It can deliver up to 13 dB of additional headroom without being noticed.

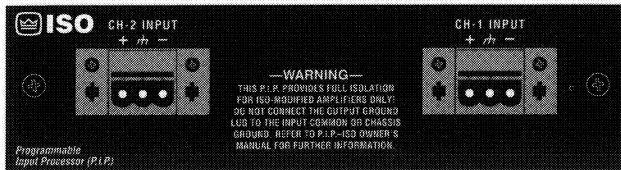

**P.I.P.-ISO** is designed especially for 25 to 140 V distribution systems where UL®-listed isolation is required. Using it (along with minor amplifier modifications) the amplifier outputs are safely isolated from both the input terminals and the chassis.

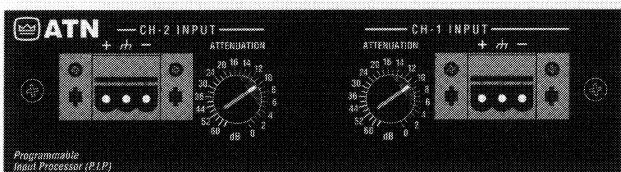

**P.I.P.-ATN** includes all the P.I.P.-FTE features plus a 32-step precision attenuator for each channel.

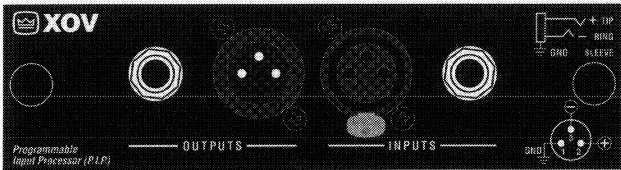

**P.I.P.-XOV** is a versatile 18 dB/octave mono cross-over/filter with biamping and triamping capabilities.

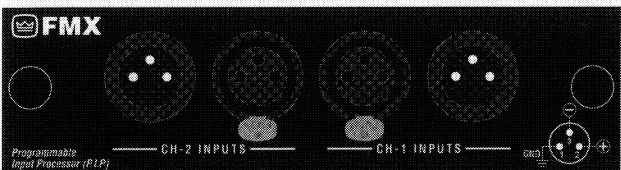

**P.I.P.-FMX** facilitates "daisy-chaining" of balanced amplifier inputs. Female to male 3-pin XLR connectors are used to passively bridge the inputs.

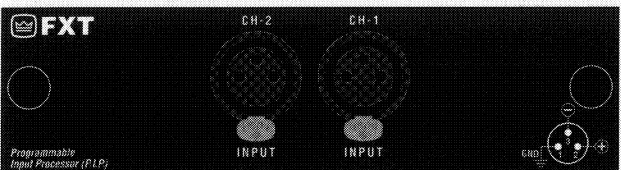

**P.I.P.-FXT** uses balanced 1:1 transformers to isolate the amplifier from the input signal. It has balanced female 3-pin XLR connectors.

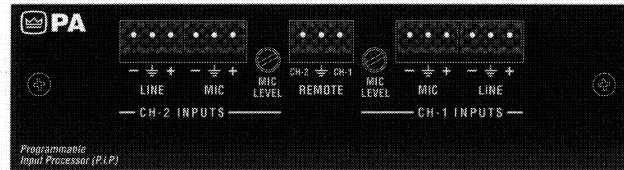

**P.I.P.-PA** adds a switchable balanced low-Z microphone input and a balanced line-level input to each channel. Timed fader circuitry with remote switching provides fades from mic to line and back.

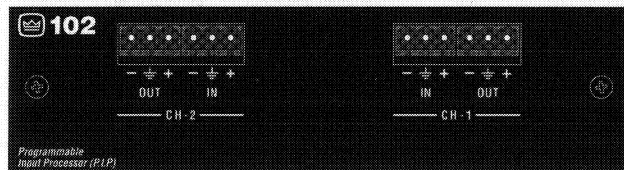

**P.I.P.-102** is a two-channel module providing equalization based on the BOSE® 102 controller. It has balanced Phoenix® removable barrier block connectors. Each input and daisy-chain output channel can be configured for straight-through operation, 102 equalization or 102 equalization with bass-cut.



**P.I.P.-RPA** adds many features of a 4x2 mixer to your amplifier. Its four inputs accept mic-level or line-level input. It offers priority switching ("voice-over") of each input and remote level control with the RPA-RMT. Other features include bus inputs and outputs, adjustable input sensitivity, phantom power and RFI suppression. Input isolation transformers are optional.

For more information on these or other P.I.P.s under development, contact your local dealer or Crown's Technical Support Group.