

dbx 165A Initial Test Procedure

OCT 11 1990

1. Preliminary Setup

- 1.1 Connect the dbx 165A under test to the 165A test box using the appropriate cables.
- 1.2 Insure that the "THRESHOLD", "COMPRESSION", "db/MSEC ATTACK" and "db/SEC RELEASE" pots all have the correct travel. (E.G. Insure that each of these pots travels just as far past the most CCW calibration mark as they do past the most CW calibration mark.

2. Power Supplies

- 2.1 Connect the dbx 165A to the proper AC power (120 or 240VRMS). Place the "POWER" switch to it's "IN" (ON) position. Note that the "POWER" LED lights.
- 2.2 Measure the voltage on the left side of R14 with a DVM. Adjust R8 for a reading of $+15.00 \pm .01$ VDC.
- 2.3 Measure the voltage on the far side of R15 with a DVM. This must read $-15.00 \pm .15$ VDC.
- 2.4 Measure the voltage on the collector (metal can) of Q5. This must read $+20.00 \pm .2$ VDC.
- 2.5 Measure the voltage on the collector (metal can) of Q12. This must read $-20.00 \pm .4$ VDC.

NOTE: The stop level pot must be fully CW for all tests except test 10.A.

3. RMS ADJUSTMENTS

- 3.1 Place the "STEREO COUPLER" switch to it's "IN" (SLAVE) position. Note that the "SLAVE" LED is lit.
- 3.2 Lift one side of Y20. (Between R39 and C17). Apply 100HZ at "0" dBV (1.00VRMS) to test box. Set the "INPUT" switch on the 165A test box to "J25 Pin 1".
- 3.3 Place the "AUTO" switch to it's "OUT" (MANUAL) position. Note that the "AUTO" LED is lit. (NOTE: The "AUTO" LED should be lit when the "STEREO COUPLER" switch is in "SLAVE" regardless of the position of the "AUTO" switch).
- 3.4 Observe the waveform on QA2 PIN 1. It should be a fullwave rectification pattern. Adjust R45 for equal positive alternations. These alternations should have an amplitude of approximately 80MV.
- 3.5 Place the "INPUT" switch on the 165A test box to "J25 PIN 2". Observe the waveform on QA2 PIN 1. It should be a full wave rectification pattern. Adjust R59 for equal positive alternations. These alternations should have an amplitude of approximately 80MV.
- 3.6 Place the "AUTO" switch to it's "IN" (AUTO) position. The waveform at QA2 PIN 1 should now be a symmetrical sinewave with an amplitude of not more than 3MV P/P.
- 3.7 Place the "INPUT" switch on the 165A test box to "J25 PIN 1" and repeat step 3.6.
- 3.8 Apply 1KHZ at "0" DB and measure the DC voltage at QA2 PIN 1 (far side of R48). Note this reading.
- 3.9 Place the "INPUT" switch on the 165A test box to "J25 PIN 2" and measure the DC voltage at QA2 PIN 1. Adjust R52 for the same voltage noted in step 3.8.
- 3.10 Install the lifted end of Y20. Place the "INPUT" switch in the 165A test box to "NORMAL". Measure the DC voltage at QA2 PIN 1. This voltage should read: Add -38 mvdc to the voltage measured in step 3.8. This is the voltage you should read for step 3.10 ± 6 mvdc.

4. Threshold LED Indicators

- 4.1 With the "STEREO COUPLER" switch still to it's "IN" (SLAVE) position, place the "REMOTE" switch on the 165A test box to "POSITION 4".
- 4.2 Measure the DC voltage at the "DVM Banana Jacks" on the 165 test box and adjust the "OUTPUT GAIN" pot on the dbx 165A for .00VDC. Note that the "BELOW" (GREEN) LED is lit.
- 4.3 While still pressing the "THRESHOLD TEST" switch, adjust the "OUTPUT GAIN" pot until the point where the "BELOW" LED has just gone "COMPLETELY" out and the "YELLOW" LED is lit brightly. The DVM must read $+140 \pm 5$ MVDC.
- 4.4 While still pressing the "THRESHOLD TEST" switch, adjust the "OUTPUT GAIN" pot until the point where the "YELLOW" LED has just gone "COMPLETELY" out and the "ABOVE" (RED) LED is lit brightly. The DVM must read $+380 \pm 5$ MVDC.

5. Threshold Calibrate

- 5.1 Place the "STEREO COUPLER" to it's "OUT" (master) position. Note that the slave LED is no longer lit.
- 5.2 Place the "AUTO" switch to it's "OUT" (manual) position. Note that the "AUTO" LED is not lit, place the "AUTO" switch back to it's "IN" (AUTO) position.
- 5.3 Apply 1KHZ at +10DB. Place the threshold pot fully CW. Adjust R65 until the red threshold LED is on and then back off on R65 until the yellow threshold LED just comes on.
- 5.4 Apply 1KHZ at -40DB. Place the threshold pot fully CCW. The yellow threshold LED must be on.
- 5.5 Place compressor knob to "4".
- 5.6 Place R140 fully CW then CCW slightly.
- 5.7 Apply 1KZ 0DB (1.00VRMS). Note: Reading on DB meter (adjust gain pot for reading).
- 5.8 Apply 1KHZ +20DB (10.VRMS). Meter reading should increase 5DB. Adjust R140 until the requirements of 5.7 and 5.8 are met.
- 5.9 Repeat steps 5.7 and 5.8 until no adjustment of R140 is necessary.
- 5.10 Set the "COMPRESSION" pot fully CW. Apply 1KHZ at "0"DB and set the "OUTPUT GAIN" pot for a convenient reading on the external DB meter. (e.g. -20DB). Apply 1KHZ at +20DB. The reading on the external DB meter must not change more than $\pm .5$ DB.

6. System Bypass and Compression Test

- 6.1 Apply 1KHZ at "0" DB and place the "SYSTEM BYPASS" switch to it's "IN" (SYSTEM BYPASS) position. The external DB meter should read "0"-.2DB. Note that the "OUTPUT GAIN" pot on the DBX 165A has no effect on this reading. Place the "SYSTEM BYPASS" switch to it's "OUT" position.

7. Meter Calibration - Input Mode

- 7.1 Shut the power off and set the mechanical zero on the dbx 165A meter for "PRECISELY" "0". Set the power back on.
- 7.2 Apply 1KHZ at "0"DB. Place the "THRESHOLD" pot fully CW. Place the "METER" switch on the dbx 165A to "INPUT". Insure that R125 (R.P.) will vary the reading on the dbx 165A meter from -11.5 to +10DB. Set R125 for "PRECISELY" "0". You might have to change R169 to a value between 1Mohm and 680K ohm to meet this spec.
- 7.3 Apply 1KHZ at -20DB. The dbx 165A meter must read -20 ± 1 DB.

8. Meter Calibration - Output & Gain Change Mode
 - 8.1 Apply 1KHZ at "0"DB. Place the "METER" switch to "OUTPUT". Set the "COMPRESSION" pot fully CCW.
 - 8.2 Place the "REMOTE" switch on the 165A test box to "POSITION 7" and measure the DC voltage at the DVM Banana Jacks with a DVM. Install the knob on the "OUTPUT GAIN" pot so that when the slot in the knob is lined up "PRECISELY" with the "0" calibration mark, the DVM reads less than +.200vdc.
 - 8.3 With the "OUTPUT GAIN" pot set "PRECISELY" on "0".
Adjust R77 for minimum 2nd harmonic distortion.
Adjust R138 for "PRECISELY" "0" on the external DB meter.
Adjust R172 for "PRECISELY" "0" on the dbx 165A meter.
 - 8.4 Place the "METER" switch to "GAIN CHANGE". The dbx 165A meter must read "0" +/-1dB.
 - 8.5 Place the "THRESHOLD" pot fully CCW. Vary the "COMPRESSION" pot until the external DB meter reads -10DB. The reading on the dbx 165A meter must be -10+1.5DB. Place the "METER" switch in "OUTPUT". The dbx 165A meter must read -10+1.5DB.
 - 8.6 Place the "THRESHOLD" pot fully CW and the "COMPRESSION" pot fully CCW. Insure that the "OUTPUT GAIN" pot will vary the reading on the external DB meter from approximately -19DB to approximately +19DB. Total swing must be not less than 38DB.

9. Noise
 - 9.1 With the "COMPRESSION" pot still fully CCW and the "OUTPUT GAIN" pot set to "0", short the input to the dbx 165A by placing all of the attenuator switches on the K-H oscillator to their "OUT" positions. The noise reading on the external DB meter must be -78DB or better. (unweighted).

- 9A. Frequency Response
 - 9A.1 Apply 1KHZ at "0"DB and adjust the "OUTPUT GAIN" pot on the dbx 165A for "PRECISELY" "0"Db on the external DB meter. Sweep the K-H oscillator from 20HZ to 20KHZ. The output should not vary more than +.5DB or -1.0DB.

10. Peak Stop Adjust
 - 10.1 Set KH to 1KHZ at 1.00vrms
 - 10.2 Place the "SYSTEM BYPASS" switch to it's "IN" position. Note that the external DB meter reads "0" + .2DB.
 - 10.3 Adjust the "volts" pot on the K-H oscillator until the external DB meter reads -2.2DB (e.g. .775vrms).
 - 10.4 Place the "SYSTEM BYPASS" switch to it's "OUT" position.
 - 10.5 The front panel switches should be as follows:
Threshold - Fully CW
Compression - Fully CCW
Stop Level - "0"
Output Gain - "0"

- 10.6 Adjust R165 fully CW. Note the waveform on the scope. No clipping should be evident. The 2nd harmonic distortion should be less than .032%.
 - 10.7 Adjust R165 CCW until the 2nd harmonic distortion reads .1%.
 - 10.8 The peak stop LED should be on.
 - 10.9 Increase the output of the K-H oscillator to +10DB. The external DB meter should read +3DB+1DB. Note that the waveform on the scope is "soft" clipped. (E.g., the corners of the waveforms are rounded).
 - 10.10 Rotate the "Stop level" fully CW. The "peak stop" LED should be off. Rotate the "stop level" pot until the "peak stop" LED lights. This should occur when the "stop level" knob on the 165A reads 10+3.
 - 10.11 No clipping should be observed on the scope.
 - 10.12 Rotate the "Stop level" pot slightly CCW until "soft" clipping is observed on the scope. This should occur when the "stop level" knob reads 10+3DB.
 - 10.13 Rotate the "stop level" pot fully CW.
 - 10.14 Reset the KH oscillator to 1.00vrms.
11. Maximum Output - 600 Ohms
 - 11.1 Apply 1KHZ at +20Db and place the "NORMAL/600 OHM" switch on the 165A test box to "600 OHMS". Adjust the "OUTPUT GAIN" pot until clipping is observed on the scope. Clipping must be symmetrical and must occur at not less than +23DB (11.00vrms). Return the "NORMAL/600 OHM" switch to "NORMAL".
12. Clamping Circuit
 - 12.1 Apply 1KHZ at "0"DB. Set the "COMPRESSION" pot fully CCW. Set the "OUTPUT GAIN" pot to "0" on the front panel.
 - 12.2 Observe the waveform on the scope. Place the "POWER" switch off and note that the waveform on the scope collapses without any DC shifts occurring above or below the P/P level of the sinewave.
 - 12.3 Note that when the "POWER" switch is turned on, the waveform on the scope goes to an intermediate level for a short period of time, and then to it's final level.
13. Remote Test
 - 13.1 Apply 1KHZ at "0" DB.
Place the "STEREO COUPLER" switch to "OUT" (MASTER).
"THRESHOLD" pot fully CCW.
"COMPRESSION" pot fully CCW.
"AUTO" switch to "IN" (AUTO).
"OUTPUT GAIN" pot fully CW.
"STOP LEVEL" pot fully CW.
 - 13.2 Measure the voltage at the "DVM Banana Jacks" on the 165A test box. The voltages should read as follows:

Position of test box stereo coupler switch
 1. Press "LED TEST" switch. Note LED is lit.-
 2. 0VDC
 3. Voltage reads +1.8VDC. Rotate the "THRESHOLD" pot fully CW.
The voltage reads .1VDC.

4. 0VDC
5. Place the "COMPRESSION" pot fully CW. The voltage reads greater than $-.09\text{VDC}$ (in a negative direction). Rotate the "THRESHOLD" pot fully CCW. The voltage now reads $+.06\text{VDC}$.
6. 0VDC.
7. $>+14\text{VDC}$
8. 0VDC
9. $>+14\text{VDC}$
10. 0VDC
11. 0VDC
12. Press the "LED TEST" switch. Note LED is lit.
- 13.3 Place the "STEREO COUPLER" switch to it's "IN" (SLAVE) position.
Position of test box stereo coupler switch.
 6. Place the "COMPRESSION" pot fully CCW. Place the "METER" switch to "GAIN CHANGE". Note the reading on the dbx 165A meter. Press the "THRESHOLD TEST" switch. Note that the reading decreases 2-4DB.
 8. Note the reading of the dbx 165A meter. Press the "THRESHOLD TEST" switch. Note that the reading decreases .5-10DB.
14. Attack/Release Time Test
 - 14.1 Set the "THRESHOLD" pot fully CCW.
Set the "COMPRESSION" pot fully CW.
Set the "db/MSEC RELEASE" pot to "40".
Set the "db/SEC RELEASE" pot fully CW.
Set the "AUTO" switch to it's "OUT" (MANUAL) position.
Set the "STEREO COUPLER" switch out.
 - 14.2 Measure the DC voltage at the far side of R92 with DVM. Set R93 for a reading of approximately -3vdc .
 - 14.3 Apply a 200HZ Toneburst signal. Set the scope vertical pot to $.1\text{V/CM}$. Set the scope horizontal pot to 50MSec/CM . Observe the waveform at S3 PIN 9. Adjust R93 until a slew rate of -300MV per $1/2$ second is obtained, as shown in figure A. The scope should be DC coupled. If the waveforms offset is too much for scope, see addendum 14.2A.

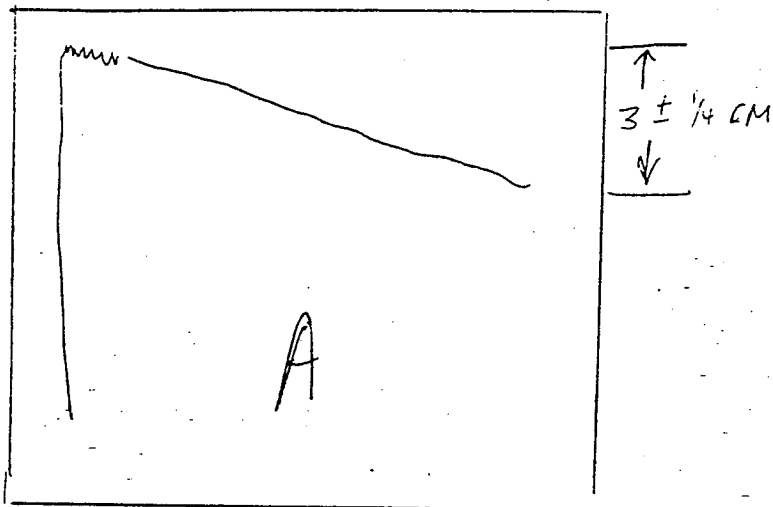

- 14.4 Set the scope vertical pot to ".5v/cm(DC)" and adjust the vertical position pot so that the bottom line is "0" VDC.
- 14.5 Set the "db/SEC RELEASE" pot fully CCW. The waveform on the scope should look like that shown in figure B.

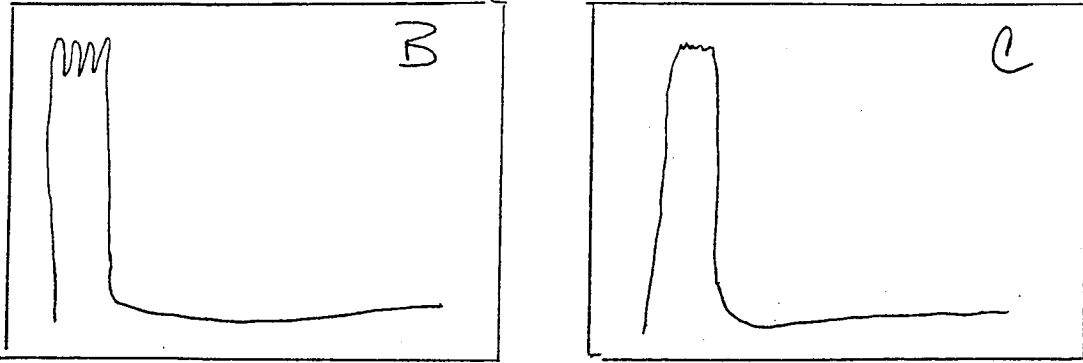

- 14.6 Set the "db/MSEC ATTACK" pot fully CCW. The waveform should still look like that shown in the left diagram above. Set the "db/MSec ATTACK" pot fully CW. The waveform should look like that shown in figure C.
- 14.7 Apply a 3KHZ Toneburst signal and observe the output of the dbx 165A on the scope. Place the scope vertical pot to ".2V/CM" and set the scope horizontal pot to "5 MSEC/CM". Adjust the "OUTPUT GAIN" pot on the dbx 165A until the first cycle of the waveform covers approximately 8 vertical centimeters. The waveform should look like that shown in figure D.

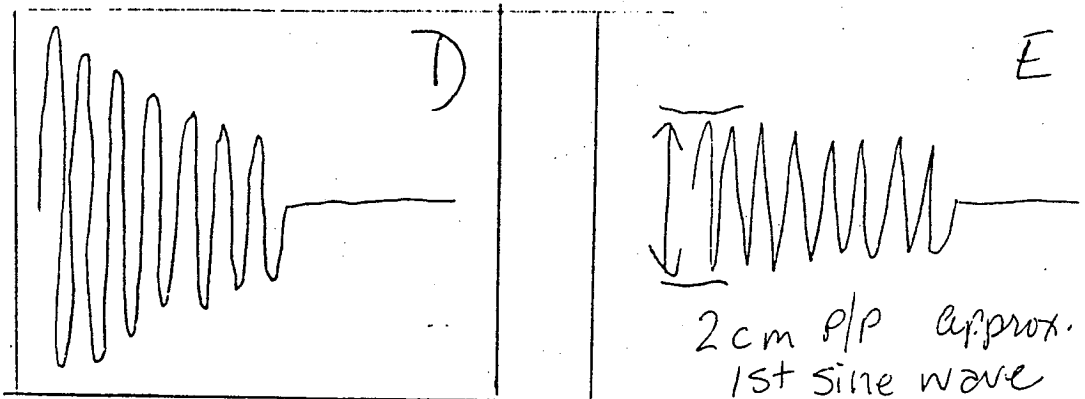

- 14.8 Place the "AUTO" switch to it's "IN" (AUTO) position. The waveform should look like that shown in figure E.
- 14.9 Place the "AUTO" switch to it's "OUT" position.
- 14.10 Rotate the release pot "CW" until the P/P voltage of the first sine-wave of the toneburst waveform is approximately 2 cm.
- 14.11 The release pot knob should point to approximately 100.

15. Detector Separation

- 15.1 With an ohmmeter, check between the detector and input and the signal and input on the rear terminal strip. This must measure more than 100K ohms. Measure between the detector - input and signal - input. This must also measure more than 100K ohms.

~~14.2A~~/dbx 165A ADDENDUM 14.2A

A. Add Test 14.2A as follows:

14.2A.. Connect the test lead from the "Bias" test jack on the 3BX test box to the junction of R48 and pin 1 of QA2 on the dbx 165 or dbx 165A under test.

B. The reason for adding test 14.2A is as follows:

In step 14.3, we are trying to monitor a signal that looks like that shown in figure #1 below, on the .1vDC scale (YA) of a Philips Scope.

To do this there must be enough range in the position pot of channel A to allow a 2.3vDC level to appear on the 8cm (high) screen of the scope. On some Philips Scopes this can be done, on some Philips scopes this cannot be done.

To enable this signal to be monitored on all Philips Scopes, a test lead has been added to the 3BX test box. This lead goes to the -5vDC supply in the 3BX test box, through a 22K resistor. During step 14 (in the 165/165A test procedure) this lead is connected to the junction of R48 and pin 1 of QA2. This voltage biases the output of the RMS chip (QA2) slightly negative, and changes the signal at pin 9 of S3 to look like that shown in figure #2 below (approximately). This signal can now be monitored on all Philips Scopes, on the .1vDC scale.

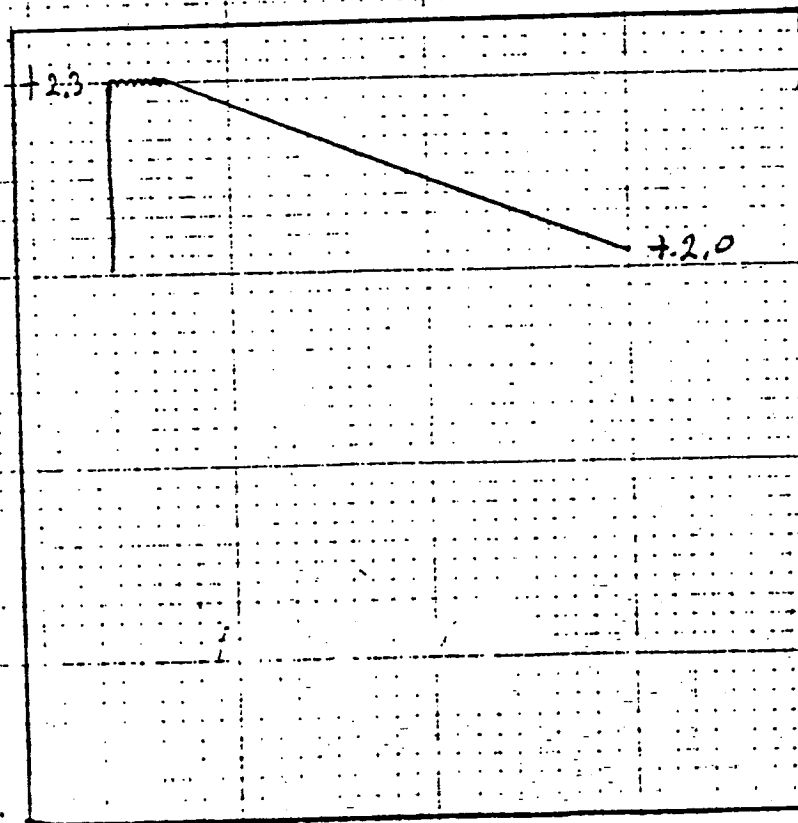

FIGURE # 1

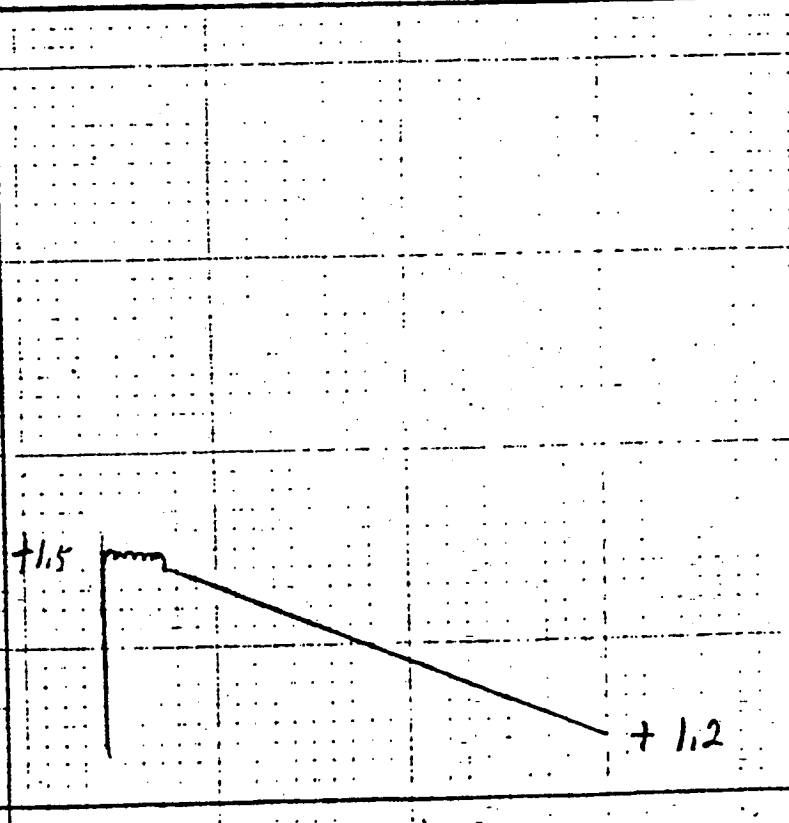
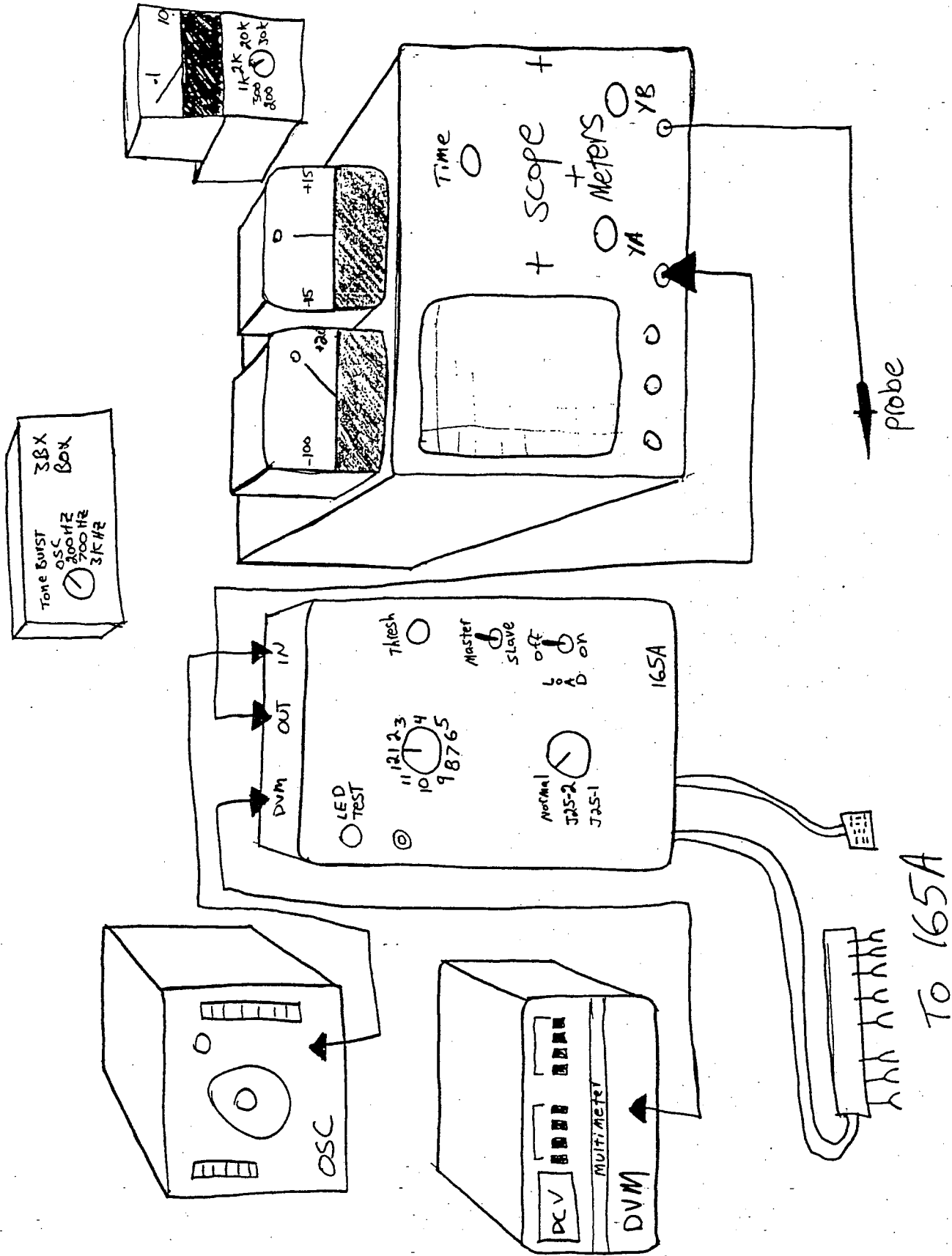

FIGURE # 2

165A Test Set up



165A FINAL TEST PROCEDURE

1. Check that the dbx 165A meter can be mechanically zeroed.
2. Connect the 165A to the proper power source (120vRMS or 240vRMS). Press the POWER switch in and observe that the POWER LED is lit.
3. Observe that all three (3) meter lamps are lit.
4. Press the STEREO COUPLER in. Observe that the SLAVE LED is lit. Place the STEREO COUPLER switch to its out position. Observe that the SLAVE LED is not lit.
5. Place the AUTO switch to its out position. Observe that the AUTO LED is not lit. Place the AUTO switch to its in position. Note that the AUTO LED is lit.
6. Apply 1kHz at 0dB (1.00vRMS). Place the stop level pot fully CW. Place the SYSTEM BYPASS switch to its out position.
7. Rotate the THRESHOLD pot fully CCW and observe that the red threshold LED is lit. Observe that as you rotate the threshold pot towards fully CW the yellow threshold LED lights. Rotate the threshold pot to its fully CW position and note that the green threshold LED is lit.
8. With the THRESHOLD pot still fully CW, apply 1kHz at +10dB. Observe that the yellow threshold LED is lit.
9. Rotate the THRESHOLD pot fully CCW. Apply 1kHz @ -40dB. Observe that the yellow threshold LED is lit.
10. Rotate the COMPRESSION pot to 4. Apply 1kHz @ 0dB (1.00vRMS) and adjust the output gain pot on the 165A until the output of the 165A reads -30dB on the external dB meter. Apply 1kHz @ +20dB (10vRMS). The output of the 165A should read -25 ± 1 dB.
11. Rotate the COMPRESSION pot fully CCW. Apply 1kHz @ 0dB. Press the meter INPUT switch. Adjust the METER CALIBRATION pot on the rear panel until the 165A meter reads PRECISELY zero.
12. Press the meter OUTPUT switch. Rotate the knob of the OUTPUT GAIN pot until it lines up mechanically with the 0 on the front panel. Observe that both the dbx 165A meter and the external dB meter read 0 ± 1 dB.
13. Press the meter GAIN CHANGE switch. observe that the 165A meter reads 0 ± 1 dB.
14. Press the meter input switch. Apply 1kHz @ -10dB. Observe that the 165A meter reads -10 ± 1 dB.
15. Place all of the attenuator switches on the K-H oscillator to their out positions. Observe that the external dB meter reads less than -80dB.

- ~~16.~~ Apply 1kHz @ 0dB. Place the power switch to its OUT position while observing the action of the clamping circuit on the scope. Place the power switch to its IN position and observe the action of the clamping circuit on the scope. There should be no transients that exceed the final P/P amplitude of the sinewave, with power on.
- ~~17.~~ Rotate the STOP LEVEL pot CCW until the red STOP LED just lights. This should occur when the stop level pot reads $+5 \pm 2\text{dB}$. At this time no clipping should be observed on the scope. Rotate the STOP LEVEL pot to 0. Observe that the waveform on the scope is clipped softly. Rotate the STOP LEVEL pot fully CW.
- ~~18.~~ Apply 1kHz @ +20dB. Place the load switch on the 165A test box to ON. Rotate the OUTPUT GAIN pot on the 165A until clipping is observed on the scope. Clipping must be symmetrical and occur at an amplitude greater than +21dBV (+23DVM). Place the load switch on the 165A test box to off. 11.28 R.M.S
- ~~19.~~ Apply 1kHz @ 0dB. Rotate the knob of the OUTPUT GAIN pot until it lines up mechanically with the 0 on the front panel. Observe that 2nd harmonic distortion is less than .05%.
- ~~20.~~ Apply a 3kHz toneburst from the 3bx test box. Rotate the THRESHOLD pot fully CCW. Rotate the COMPRESSION pot fully CW. Rotate the ATTACK pot fully CW. Rotate the RELEASE pot fully CCW. Place the AUTO switch to its OUT position. Place the STEREO COUPLER switch to its OUT position. Place the Scope Vertical pot to .2V/CM and set the scope Horizontal pot to .5MSEC/CM. Adjust the OUTPUT GAIN pot on the dbx 165 until the first cycle of the waveform covers approximately 8 vertical centimeters. The wave form should look like that shown in the left diagram below.

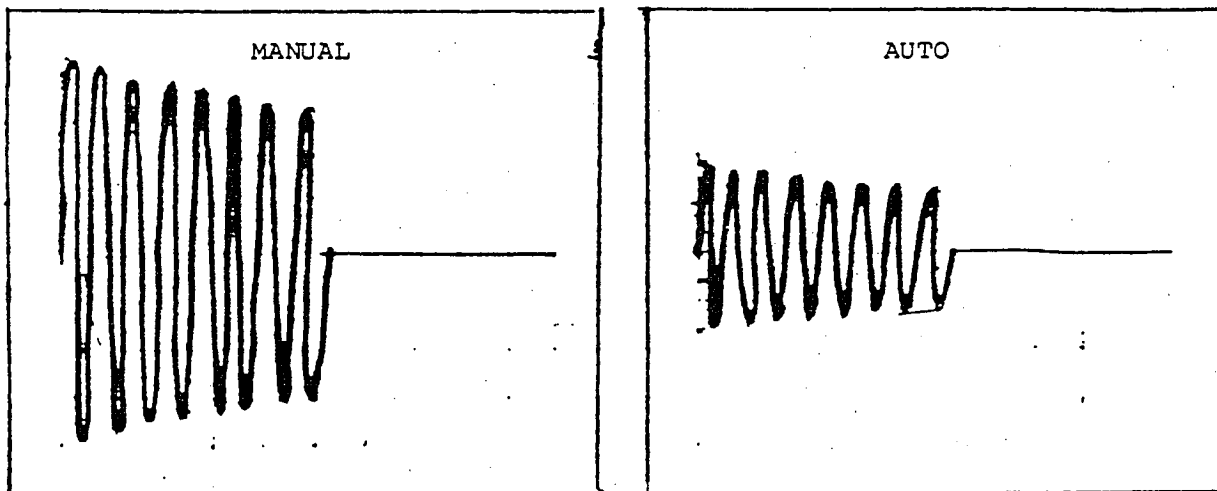

Place the AUTO switch to its IN (AUTO) position, The waveform should look like that shown in the above right diagram.

- ~~21.~~ Place the AUTO switch to its OUT position. Rotate the release pot CW until the wave form on the scope measures 2cm P/P. The release pot should read approximately 100.
- ~~22.~~ Apply 1kHz @ 0dB. Adjust the METER CALIBRATION pot on the rear panel until the 165A meter reads approximately -1.8dB.

165A Tone Burst Notes

The Two Tone Burst signals used for Testing the 165A are 200 Hz 8 cycles on 128 cycles off, and 3 KHz 8 cycles on 128 cycles off.

All 3 BX Test Boxes have these generators built in, but some have Feed through in the 128 off cycles.

The waveforms shown in the 165A Test Procedures were taken with a 3 BX Test Box without any Feed through

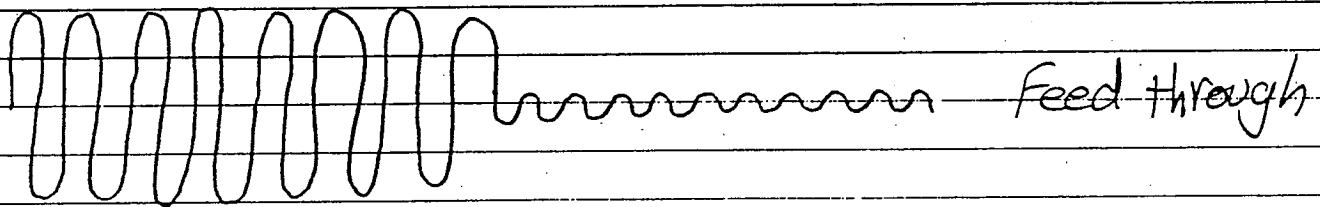
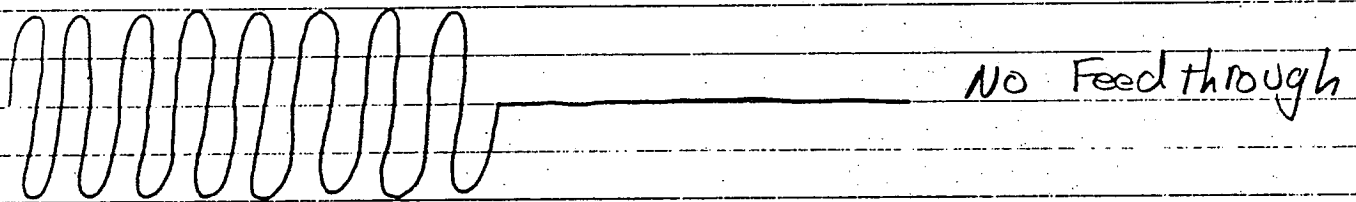

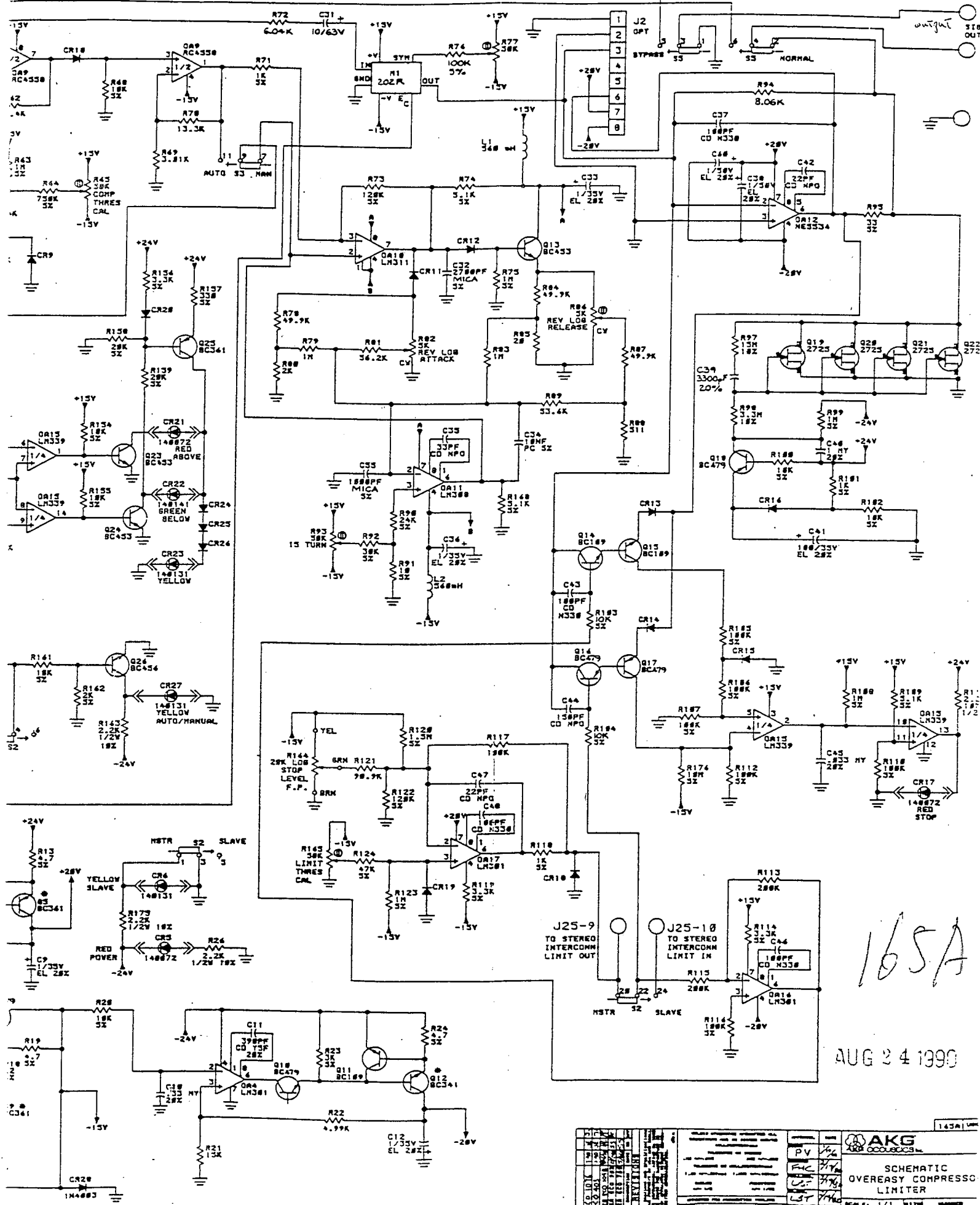

165A

AUG 24 1990

REV	1	DATE	10/1/89	BY	...
REV	2	DATE	...	BY	...
REV	3	DATE	...	BY	...
REV	4	DATE	...	BY	...
REV	5	DATE	...	BY	...
REV	6	DATE	...	BY	...
REV	7	DATE	...	BY	...
REV	8	DATE	...	BY	...
REV	9	DATE	...	BY	...
REV	10	DATE	...	BY	...
REV	11	DATE	...	BY	...
REV	12	DATE	...	BY	...
REV	13	DATE	...	BY	...
REV	14	DATE	...	BY	...
REV	15	DATE	...	BY	...
REV	16	DATE	...	BY	...
REV	17	DATE	...	BY	...
REV	18	DATE	...	BY	...
REV	19	DATE	...	BY	...
REV	20	DATE	...	BY	...

AKG
AKG ACOUSTICS

SCHEMATIC
OVEREASY COMPRESSOR
LIMITER

SCALE: 1/1 WITH
SHEET 1 OF 1 0348182

