

AMP LEFT

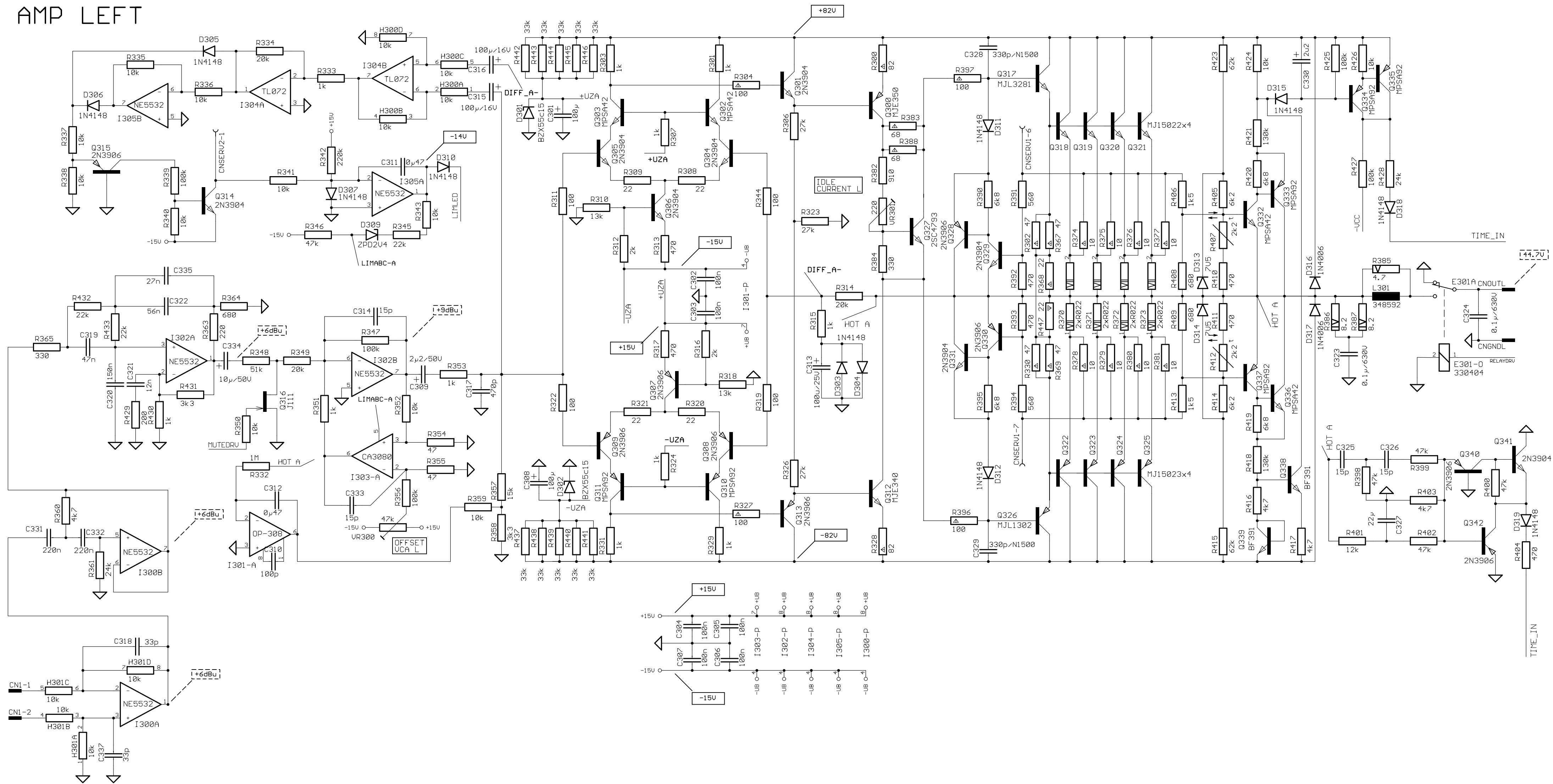

- POWER RESISTOR 5 WATT
- POWER RESISTOR 4 WATT
- DC VOLTAGE MEASURED WITH VOLTMETER 100kOHM/V
- AC VOLTAGE 1000 HZ, MEASURED WITH UTVM
- SAFETY COMPONENT, FLAMEPROOF RESISTOR (MUST BE REPLACED BY ORIGINAL PART)

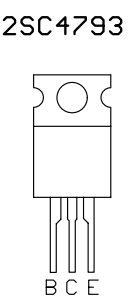
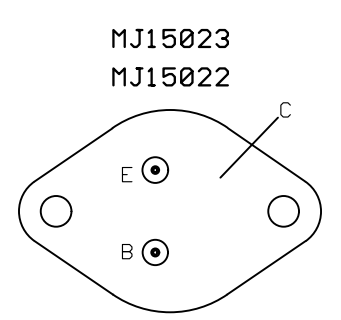
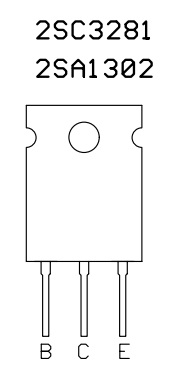
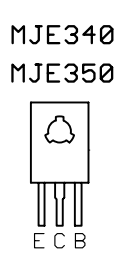
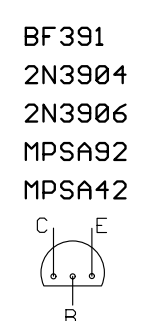
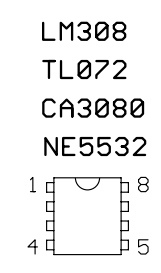
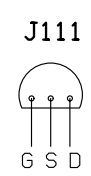

ALTERATIONS RESERVED!

ISSUE	REVISION	DATE	NAME
K	157/99	13.12	Lang
I	145/99	24.11	Lang
H	85/99	13.07	Lang
G	18/99	02.99	csc
F	6/99	22.01	Stangl
E	72/97	11.97	Lang
D	62/97	10.97	Taffner
C	57/97	09.97	Lang
B	47/97	09.97	Lang
A	NULLSERIE	09.97	Lang

13.12.1999 10:48:34
 03.07.2000 10:21:57
 DATE NAME
 06.97 Taffner
 APP'D

84169H
Power Amplifier Left

CIRCUIT DIAGRAM 1/3

354 011

PM1000/1600/PSX1000/1600

2-

EVI AUDIO