

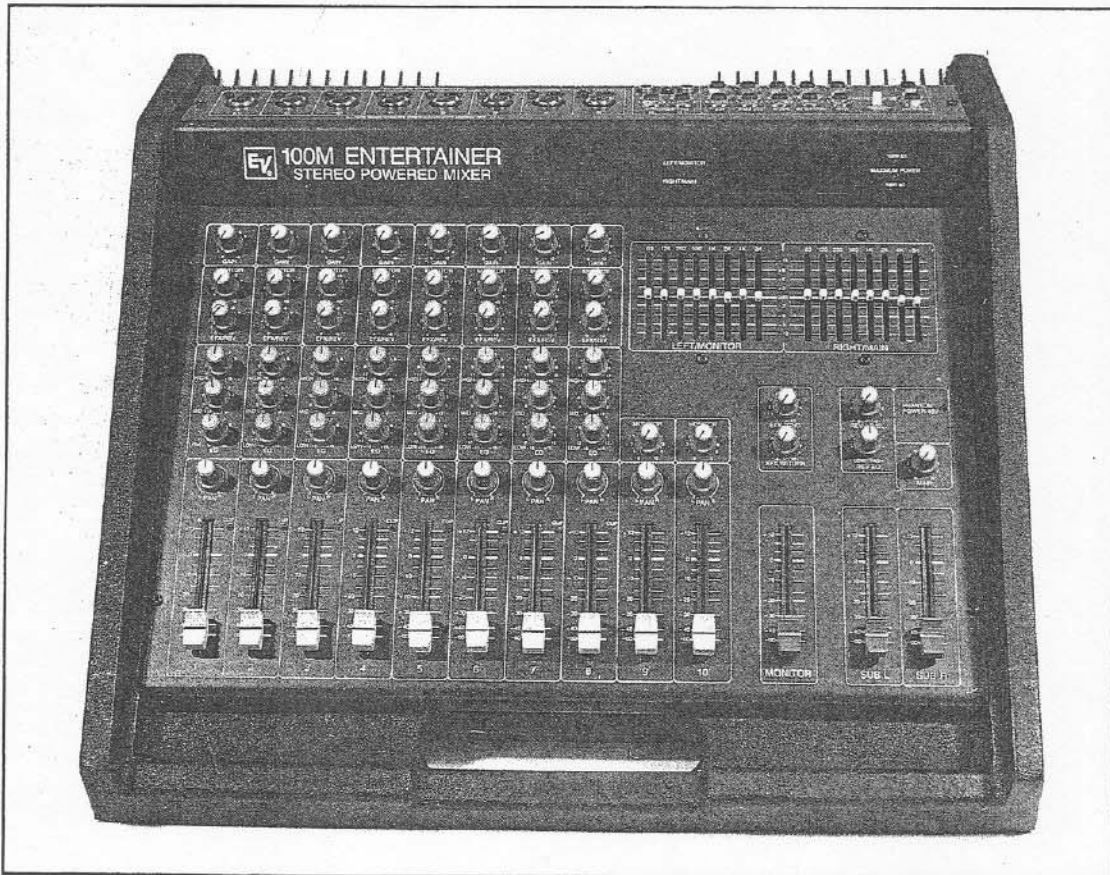

Electro-Voice®

STEREO POWERED MIXERS

OWNER'S MANUAL



100M ENTERTAINER

TABLE OF CONTENTS

FEATURES AND DESCRIPTION.....	2
SPECIFICATIONS.....	3
BLOCK DIAGRAM.....	4
OPERATION.....	6
FRONT PANEL CONTROLS.....	6
INPUT CHANNELS.....	6
MASTER SECTION.....	7
EQUALIZER SECTION.....	7
METER SECTION.....	8
REAR PANEL CONNECTIONS.....	9
INSTALLATION.....	13
STEREO PA.....	13
MONO PA.....	14
USING A TAPE RECORDER.....	15
USING A TAPE PLAYER OR TURNTABLE.....	16
HOOKING UP INSTRUMENTS DIRECTLY.....	18
EXTERNAL EFFECTS.....	18
RE-PATCHING THE EQUALIZERS.....	19
RE-PATCHING THE AMPLIFIERS.....	19
MONITORS.....	19
SCHEMATIC DIAGRAMS.....	25
SERVICE/WARRANTY INFORMATION.....	34

WARNING: TO REDUCE THE RISK OF FIRE OR ELECTRIC SHOCK, DO NOT EXPOSE THIS EQUIPMENT TO RAIN OR MOISTURE.

FEATURES**INPUTS 1 THROUGH 8**

- Transformerless balanced mic/line input
- High-impedance mic input
- Gain control with overload LED
- Independent monitor send
- Effects-reverb send
- Three-band EQ

INPUTS 9 AND 10

- Aux inputs for high-impedance or line-level sources
- Independent monitor send

MASTER SECTION

- Two independent power amplifiers
- Two eight-band graphic equalizers
- Fluorescent bargraph meters
- Peak-limited spring reverb
- Master reverb level and contour controls
- Reverb footswitch jack
- 48-volt phantom power for condenser microphones
- Patented Maximum Power circuitry - prevents amplifier clipping
- Mono output master control
- Patching access jacks for mixer, equalizers and amplifiers
- Effects send and return system for external effects
- Stereo/Mono mode switch
- Switch between normal stereo operation and mono with monitors

DESCRIPTION

The 100M Entertainer Mixer is a stereo mixer with ten inputs and two built-in 150-watt (peak) per channel power amplifiers. The unit has a balanced, lightweight and durable chassis with a recessed front panel for control knob protection.

The mixer consists of eight channel inputs which may be used as either a balanced mic input or a high-impedance mic input. Each of these channels have a gain control with an overload LED, independent monitor sends, a three-band equalizer, effects-reverb sends, and slide faders.

The mixer also contains two auxiliary input channels for high-impedance or line-level sources. These channels have independent monitors sends, pan pots and slide faders.

The master section of the mixer is made up of two power amplifiers, two eight-band equalizers, peak-limited spring reverb and master reverb level controls. A stereo/mono mode switch allows switching between normal stereo operation and mono with monitors. The mode switch assigns amplifiers and equalizers with no patching required.

SPECIFICATIONS

CONDITIONS

1. All noise measurements are made through mic inputs with: 150-ohm source, 20 Hz - 20 kHz noise bandwidth.

2. 0 dBu = 0.775 V rms across any impedance.

POWER OUTPUT, SINGLE CHANNEL(average continuous power into 8 ohms, 1 kHz)

100 W

POWER OUTPUT, SINGLE CHANNEL(4-ohm load, IHF dynamic headroom test signal, 1 kHz)

150 W (peak)

MINIMUM LOAD IMPEDANCE(per channel)

4 ohms

THD

Mixer Output: <0.02% at +4 dBu

Amplifier Output: <0.02% at 100 W at 8 ohms, 1 kHz

SIGNAL-TO-NOISE RATIO

-100 dB, all faders down

OUTPUT NOISE, ABSOLUTE

Mixer Output: -70 dBu, all faders at nominal setting, 44 dB gain

EQUIVALENT INPUT NOISE

-12 dBu, measured at preamp output (maximum gain)

MAXIMUM INPUT LEVEL

Low Z +6 dBu/1.5 V rms

High Z +26 dBu/19.95 V rms

Inputs 9 and 10 +10 dBu/3.16 V rms

Eq Points

Low ± 15 dB at 100 Hz

Mid ± 12 dB at 3 kHz

High ± 15 dB at 10 kHz

EFFECTS SEND OUTPUT LEVEL

nominal line level (+4 dBu)

High nominal guitar

Low (instrument) level (-16 dBu)

PHANTOM POWER VOLTAGE

+48 V dc

DIMENSIONS

Height: 20.3 cm (8 in.)

Width: 50.8 cm (20 in.)

Depth: 48.3 cm (19 in.)

WEIGHT

16.3 kg (36 lb)

POWER REQUIREMENTS

120 V ac, 60 Hz, 400 W

100, 220, 240 V ac, 50 Hz available

BLOCK DIAGRAM

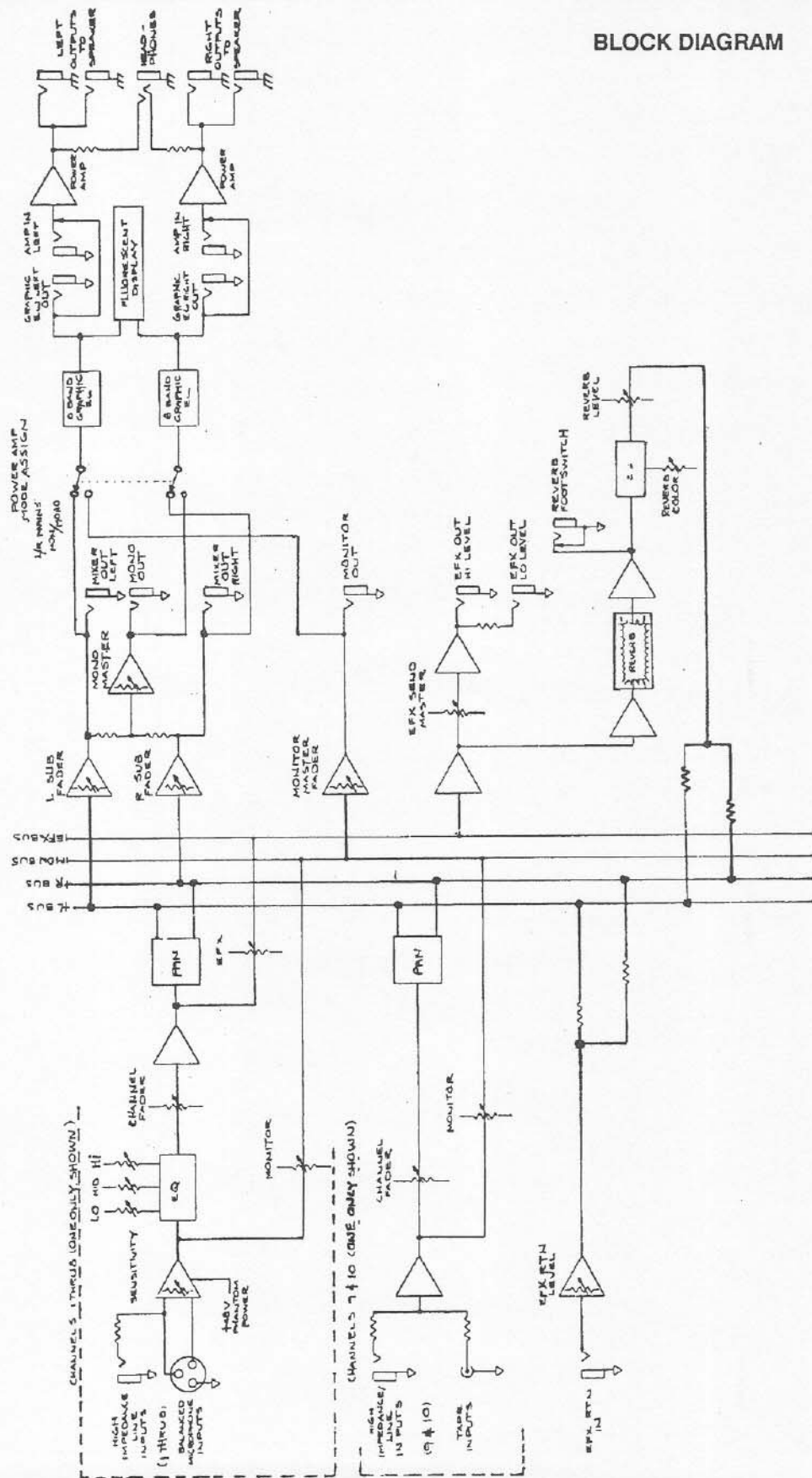

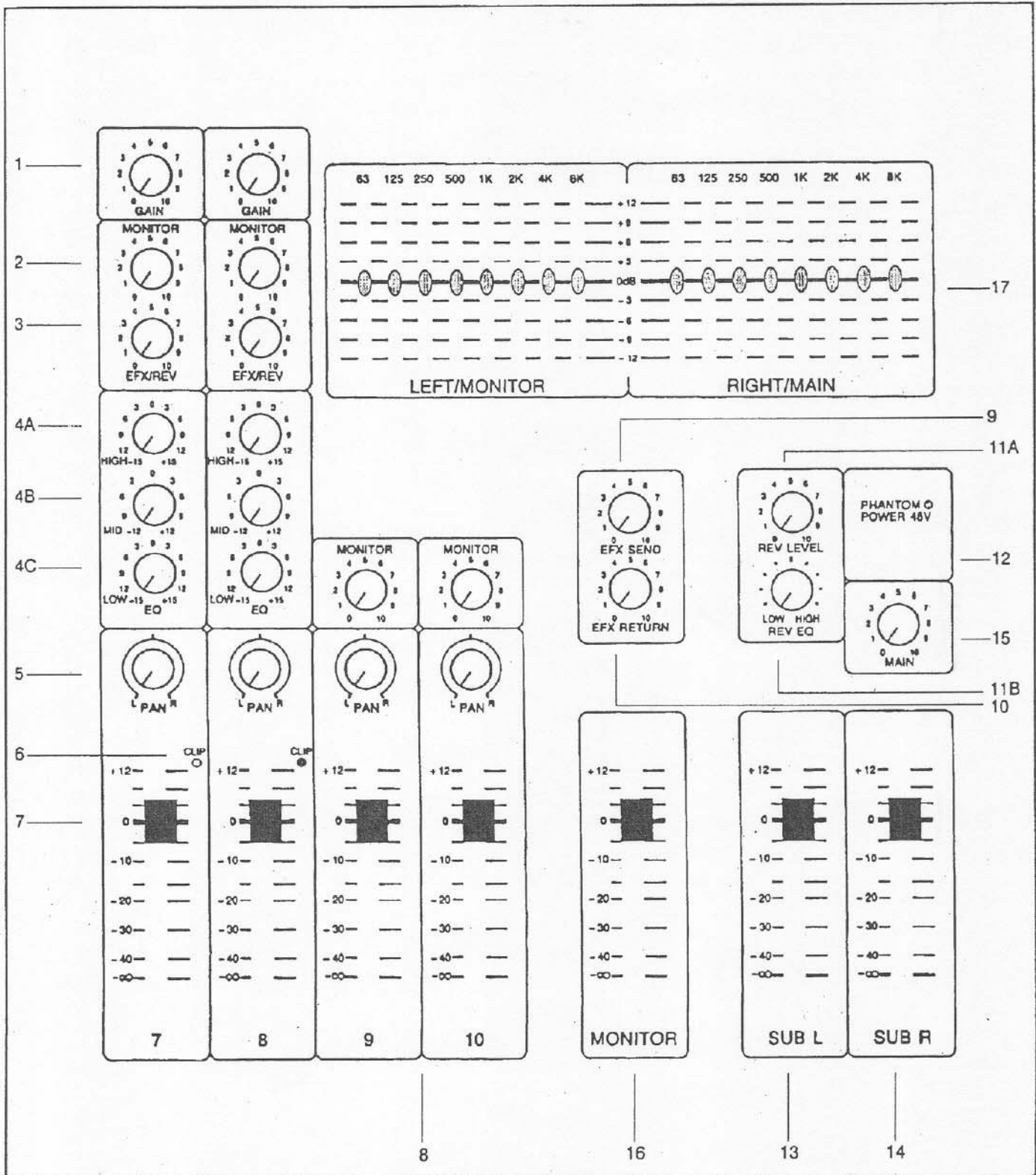

Pictorial 1 - Front Panel Diagram

OPERATION

Front Panel Controls (refer to Front Panel Diagram, Pictorial 1)

INPUT CHANNEL CONTROLS

The input channel is the beginning of the mixer. Each input channel will accept one signal source which may then be equalized, have reverb or other effects added, sent to a monitor system, and sent to the main system for the audience to hear. Each input has a low-impedance mic input (the 3-pin female XLR-type connector) and a high-impedance mic/line input (1/4-inch phone jack). The line input will accept signals from an instrument, high-impedance microphone, tape deck, drum machine, or almost any other audio source. Always be sure that the channel fader or master faders are down before plugging or unplugging input sources.

1. GAIN: This control adjusts the gain or amplification of the input amplifier. This is necessary to accommodate the wide variation in signal strength presented to the mixer by the variety of signal sources. The GAIN control allows the amplification for each input source to be optimized. This results in the best signal-to-noise ratio and at the same time, best freedom from overload distortion.

2. MONITOR SEND: The MONITOR SEND control sets the level of that input signal in the monitor mix. It is independent of all input channel controls except the GAIN control. It is not affected by the channel tone (EQ) controls or the channel fader. Thus, it is not affected by changes in the main mix.

3. EFX/REV SEND: The EFFECTS/REVERB SEND control determines how much reverb from the internal spring and/or external effects is added to that input signal. It is affected by the channel tone controls and the channel fader.

4. EQ CONTROLS: Equalization can be more simply described as tone control. The EQ circuits used in the 100M have a tremendous amount of boost and cut capability.

This extreme range can be a bonus when dealing with instrument signals, bad acoustics or other problems. Use them sparingly for best results.

A. HIGH EQ: 10 kHz Shelving Type ± 15 dB

This control adjusts the treble content of the input signal. Turning the control counter-clockwise decreases the amount of treble, clockwise increases it.

B. MID EQ: 3 kHz Peak/Dip ± 12 dB

This control adjusts the midrange content of the input signal. Turning the control counter-clockwise decreases the amount of midrange, clockwise increases it.

C. LOW EQ: 100 Hz Shelving Type ± 15 dB

This control adjusts the bass content of the input signal. Turning the control counter-clockwise decreases the amount of bass, clockwise increases it.

Since each channel has its own EFX/REV SEND, some channels can have reverb or effects and others none. Note that since the internal reverb and external effects share a common send, they will always have the same sources. That is, it is not possible to have reverb on one input source and effects on another input source at the same time. It is possible to have reverb and effects simultaneously on both input channels, however.

The EFX/REV SEND may also be used as a mono send. This might be useful for a tape recorder send, for instance.

5. PAN: This control allows the channel's input signal to be placed within the stereo image by assigning more or less of the signal to the left or right main volume controls (SUB L and SUB R).

Turning the PAN control to the left of the center moves the apparent source toward the left speaker, turning it to the right moves the source to the right speaker. Centering the control makes the apparent source centered between the speakers. If all inputs are panned center, the result is mono. Proper use of the PAN control can sometimes help to control acoustic feedback in a sound reinforcement system by "panning" a mic away to the loudspeaker on the opposite side of the stage.

6. CHANNEL CLIP INDICATOR: The CHANNEL CLIP indicator monitors the entire input channel circuit for clipping or overload. If it lights, the signal is bordering on distortion. A harsh, blaring noise will

sound on volume peaks. This might be caused by excessive equalization on the channel tone controls, a gain control setting that is too high for the input signal, or a channel fader that is set too high. Generally, readjusting the GAIN control will suffice.

7. CHANNEL FADER: This control adjusts the input level in the main mix. The normal setting for this control is around the 0-dB mark on the scale.

8. TAPE INPUTS (CHANNELS 9 AND 10): The Tape inputs are high-impedance line inputs. They may be used for a tape deck, keyboard, drum machine, high-impedance microphone or other instrument.

OUTPUT SECTION CONTROLS (refer to Front Panel Diagram, Pictorial 1, page 5)

9. EFX SEND MASTER: The EFFECTS SEND MASTER control sets the level of the signal appearing at the EFFECTS SEND output jack going to any type of outboard effects devices such as a delay. It does not affect the signal being sent to the internal reverb system. The source for this signal is via the individual EFX/REV SEND level controls on input channels 1 through 8.

10. EFX RETURN LEVEL: The EFFECTS RETURN level control determines the loudness of externally-generated effects signals in the main mix. This signal is mixed equally into the left and right stereo main outputs. It also appears at the mono output.

11. REVERB SECTION: Reverberation is the natural decay of sound in a closed space (room). The reverb system in the 100M simulates this effect. The reverb section gets its input signals from the EFX/REV SEND control on the input channel.

A. REV LEVEL: This control adds reverberation to the main (stereo and mono) outputs from any input channel signal (inputs 1 through 8) whose EFX/REV control is turned up.

Turning the control to the right increases the amount of reverb present in the main (stereo and mono) outputs.

B. REV EQ: This control varies the timbre of the reverb. Turning the knob to the left emphasizes the lower frequencies in the reverb sound, giving a warmer tonal quality. Turning the knob to the right emphasizes the higher frequencies in the reverb sound.

12. PHANTOM POWER INDICATOR: This LED indicates the presence of 48 V phantom power at the microphone inputs (XLR connectors only). Phantom power is turned on and off via a switch on the rear panel. Phantom power allows the simultaneous use of dynamic and condenser microphones, while eliminating the need for the batteries sometimes associated with powering condenser microphones.

MASTER SECTION CONTROLS (refer to Front Panel Diagram, Pictorial 1, page 5)

The master section controls affect the overall operation of the 100M.

13. SUB L: The LEFT SUBMASTER control adjusts the volume of the left stereo output channel. In mono mode, it is used as a subgroup master.

14. SUB R: The RIGHT SUBMASTER control adjusts the volume of the right stereo channel. In mono mode, it is also used as a subgroup master.

15. MAIN MASTER: The MAIN output is a mix of the left and right stereo outputs. The Main Master controls the volume of the main output.

16. MONITOR MASTER: This control adjusts the volume of the monitor output signal. The monitor output is a mix of the individual channel monitor sends.

EQUALIZER CONTROLS (refer to Front Panel Diagram, Pictorial 1, page 5)

17. DUAL 8-BAND GRAPHIC EQUALIZERS: Each of the graphic equalizers can boost or cut any (or all) of the 8 frequencies by 12 dB.

The equalizers are connected to the 100M's mixer section output via the Power Amplifier Assign Mode switch. The mode switch determines the usage of each channel of the equalizer section. The equalizers may also be used to extend the bass response of the 100S speaker system by an additional 1/3 octave. Adjust the 63-Hz slider of the appropriate graphic equalizer to a setting of +3 dB. This setting results in the overall flattest bass response and extends the low-frequency cutoff to approximately 60 Hz. In some situations the additional low-frequency response may be neither desirable nor beneficial. The extra low-frequency boost places additional demands on the 100M's power amplifiers. This may cause premature activation of the anti-clipping circuitry. If this is the case, using less boost might be considered.

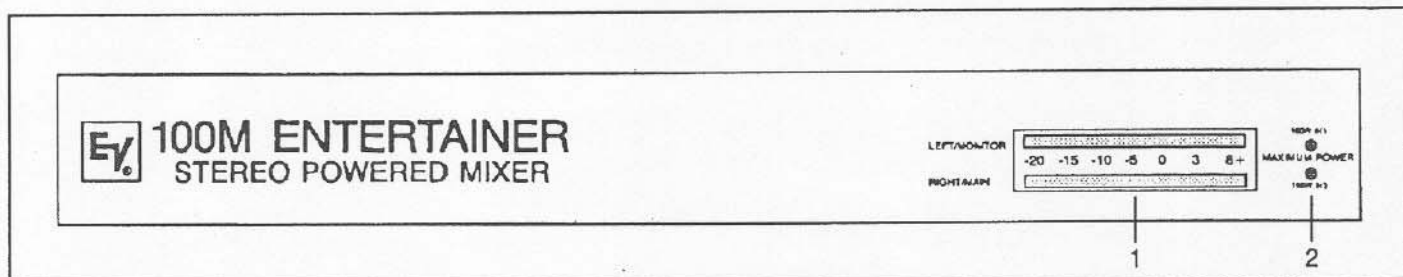

Pictorial 2 - Dual-Display Meter Diagram

METER SECTION (refer to the Dual-Display Meter Diagram, Pictorial 2)

1. LEFT AND RIGHT BARGRAPH DISPLAY: The meter section uses a dual-channel fluorescent bargraph display. The display is calibrated so that 0 VU on the display corresponds to +4 dBu (1.23 V rms) at the Stereo or Monitor outputs (depending on the setting of the MODE switch) and +3 VU on the display corresponds to the 100-watt (8-ohm) output from the internal power amplifiers.

The meters monitor the output of the graphic equalizers. The actual sources monitored depend on the setting of the MODE switch.

Depending on the setting of the MODE switch, the meter will indicate two different situations:

If the **MODE switch is in the In position**, the left bargraph will indicate the main output level, while the right bargraph will indicate the monitor output level.

If the **MODE switch is in the Out position**, the left bargraph will indicate the left stereo output level, while the right bargraph will indicate the right stereo output level.

2. LEFT AND RIGHT MAXIMUM POWER INDICATORS: These indicators signal the activation of the anti-clipping circuit. The output of each amplifier is monitored individually for clipping (distortion) conditions. When clipping is detected, the amplifier gain is automatically reduced just enough to keep the amplifier output from clipping. If the input signal should increase further, the gain is reduced further, but just enough to prevent clipping.

Occasional blinking of the indicators is normal. Sustained operation of the indicators, while not harmful in itself, is an indication of amplifier overdrive (operating the system beyond its limits) and should be adjusted. With the indicators on continuously or most

of the time, the 100M will not get significantly louder, regardless of how much travel is left on any of the volume controls. One possible cure is to simply turn the master volume down. Another possibility is to obtain additional power amplifiers and speakers if more volume and/or coverage are needed.

Remember, the **MAXIMUM POWER LEDs** do not indicate amplifier clipping, rather, they indicate the activation of the protection circuitry. If it weren't for the protection circuitry, the signal would have been clipped, causing distortion.

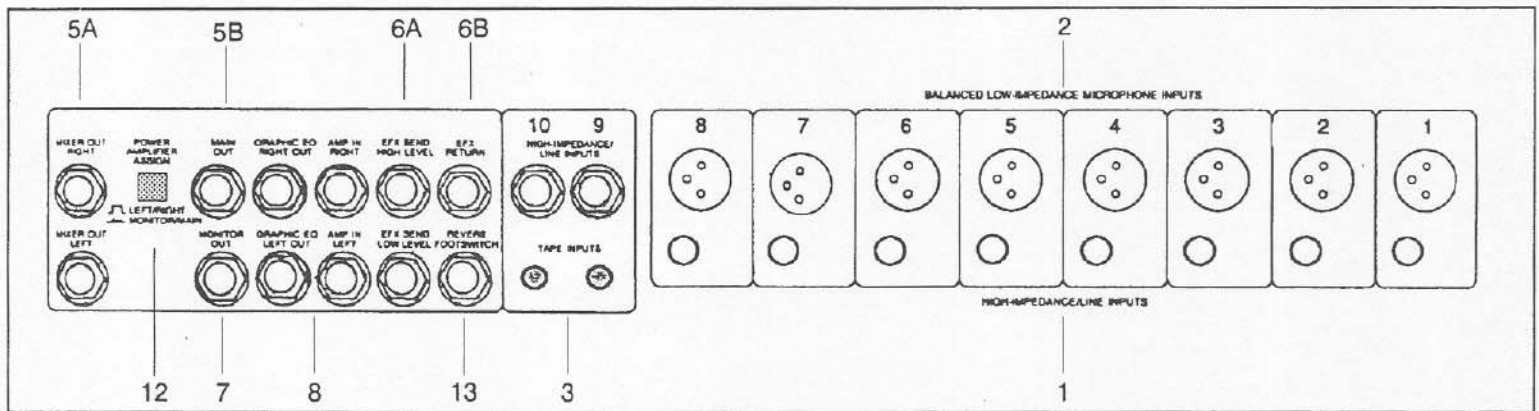

Pictorial 3 - Rear Panel Diagram

OPERATION

Rear Panel Connections (refer to Rear Panel Diagram, Pictorial 3)

1. HIGH-IMPEDANCE/LINE INPUTS: The HIGH-IMPEDANCE/LINE inputs (channels 1 through 8) accept a 1/4-inch standard phone plug. Use shielded cable for these connections. The inputs may be used for any of the sources:

- a. high-impedance microphones
- b. CD player
- c. keyboards or synthesizers
- d. drum machines
- e. tape machines (playback)
- f. turntables (with external RIAA preamp)
- g. signals from another mixer
- h. any source with an output level from -40 to +26 dBu or .01 to 15 volts

2. BALANCED LOW-IMPEDANCE MICROPHONE INPUTS: The MICROPHONE input jacks (channels 1 through 8) are designed to accept signals from a balanced, low-impedance source, such as a microphone. Be careful not to connect or disconnect microphones with the volume (channel or master) controls turned up. Loud noises will result. Shielded cable must be used for all microphone connections. These inputs will accept any of the following sources:

- a. balanced, low-impedance dynamic microphones
- b. balanced, low-impedance condenser microphones
- c. phantom power compatible condenser microphones
- d. balanced, low-impedance outputs from instru-

ments

e. the balanced, low-impedance output of a direct box

f. any balanced, low-impedance microphone-level source

Each of these inputs has phantom power available for powering certain condenser microphones. Dynamic microphones (or any of the above sources) may be used simultaneously without damage. Since phantom power is a compatible system, one switch is provided for all inputs.

3. TAPE INPUTS: The TAPE Inputs (channels 9 and 10) will accept inputs of about -10 dBu or 200 to 300 mV. Each input is provided with a RCA phono jack and a standard 1/4-inch phone jack. These inputs can be used for:

- a. CD or tape player
- b. turntables (with suitable RIAA preamp)
- c. effects returns
- d. some keyboards (if they have enough output)
- e. another mixer's output signal
- f. the output signal from a movie projector
- g. drum machines
- h. a line-level input

Like the other mixer inputs, shielded cable must also be used here.

4. OUTPUT TO SPEAKERS (see Pictorial 4, page 10): These jacks are the outputs of the two internal 100-watt (8-ohm) power amplifiers. The total load presented to each amplifier must be no lower than 4 ohms, however the 8-ohm load is recommended (for example, two Electro-Voice 100S speakers). Any of

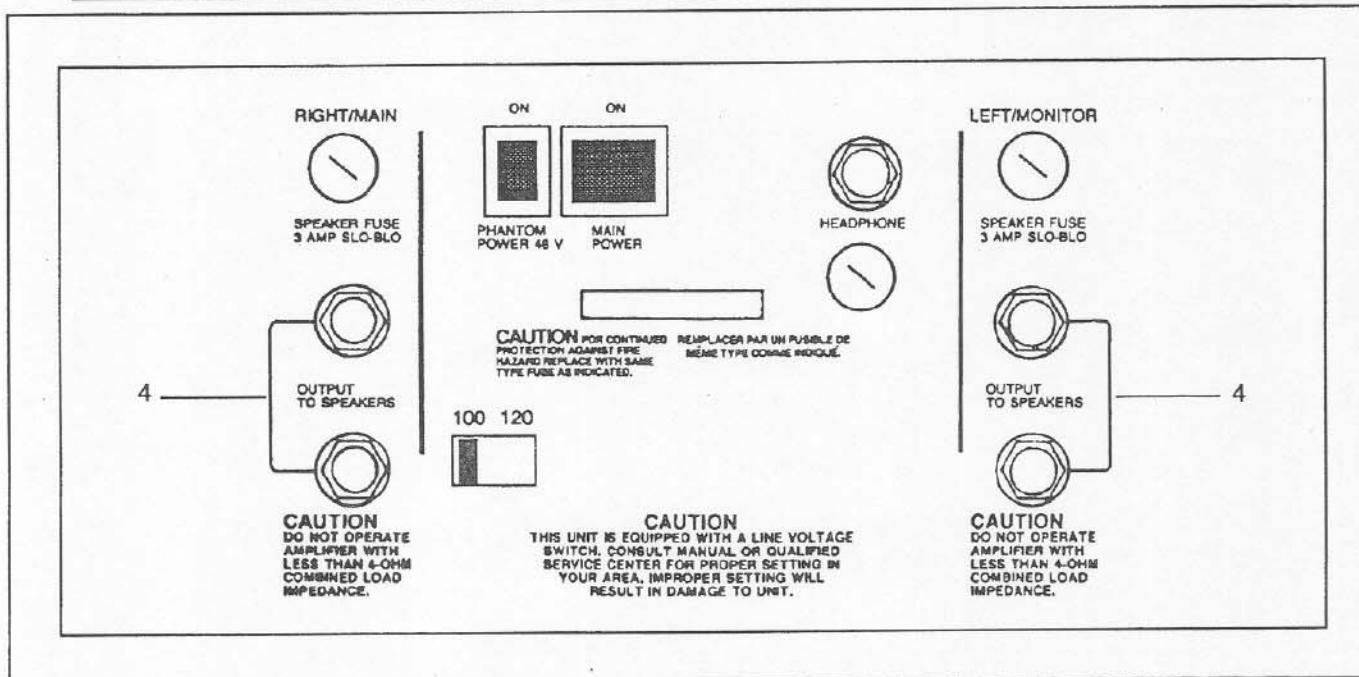

Pictorial 4 - Speaker Output Panel

the following combinations will work (examples refer to ONE of the two amplifiers):

- a. one 8-ohm speaker
- b. one 4-ohm speaker
- c. two 8-ohm speakers
- d. two 4-ohm speakers (wired in series)
- e. four 16-ohm speakers
- f. any combination of speakers whose total impedance is 4 ohms or more

Operation of the internal amplifiers with loads below the 4-ohm minimum (i.e. 2 ohms) may damage the amplifiers. Such damage is not covered by the warranty.

Use high-quality cable and plugs (Switchcraft #280) to connect your speakers to the 100M. For most purposes, 18-gauge "zip cord" is sufficient. For long runs (more than 50 feet) heavier wire is recommended (16 or 14 gauge). For heavy-duty applications, consider using type SVT or SJ portable cordage. It is much better suited to putting up and tearing down than zip cord. Shielded cable is neither necessary nor desirable.

CAUTION

DO NOT USE COILED GUITAR CABLES FOR SPEAKER CONNECTIONS. THEY ARE UNRELIABLE AND WILL WASTE AMPLIFIER POWER.

5. STEREO AND MONO MIXER OUTPUTS: The STEREO and MONO outputs are the outputs of the mixer section of the 100M. They may be used for tape recording, external amplifiers, broadcast feeds, and other external equipment.

Each of these jacks are line-level outputs. The signal level is +4 dBu or 1.23 V rms when the fluorescent bargraph display reads 0 VU. These outputs are not affected by the graphic equalizers or the Mode switch. The jacks may be used at any time without interrupting the signal flow through the 100M. If plugging into one of these does interrupt the signal, the cable is bad.

A. MIXER OUT, LEFT AND RIGHT: These are the 100M's stereo mixer outputs. Use them for simultaneous recording or any of the other uses suggested above. If external power amplifiers are connected here and recording is desired, use a Y cord to connect them all.

NOTE: Do not connect the outputs together with a Y cord at any time.

B. MAIN OUTPUT: The MAIN output is a mix of the left and right stereo outputs. It is affected by the settings of the SUB L and SUB R controls. The level of this mix is adjusted by the MAIN control. This output may be used simultaneously with the stereo mixer outputs (see above) or any of the other outputs.

The MAIN output can also be used to advantage where the 100M has to drive an external sound system. For example:

- a. the 100M is used in a large room and the "house system" could be used for additional coverage
- b. the 100M is used for a keyboard mixer/amplifier with a large PA system

Both of these situations can be covered by the use of the mono output, via a direct box or a high-impedance to low-impedance transformer. Plug the Hi-Z side of the transformer into the Mono output of the 100M. Plug the Lo-Z side of the transformer into the house PA. Adjust the output level to house PA with the mono master. A relatively low setting will be required.

5. EFX SEND AND EFX RTN: The EFFECTS SEND and EFFECTS RETURN jacks allow external effects devices such as echo machines, chorus units and digital delay devices to be connected to the 100M.

A. SENDS: To facilitate the connection of the various types of devices available to the musician, two send jacks are provided:

HIGH LEVEL 1/4" phone jack +4 dBu level

LOW LEVEL 1/4" phone jack -16 dBu level

Use the EFX SEND HIGH-LEVEL jack for studio-type effects devices capable of operating at line levels (about 1 volt).

Use the EFX SEND LOW-LEVEL jack for guitar-type devices. These are units that are normally patched between an instrument and its amplifier. The low-level send allows the guitar-type device to operate at its optimum level for low distortion and yet still be hot enough to be relatively noiseless.

Both the high- and low-level jacks may be used simultaneously.

B. RETURN: Once the signal has been sent to an effects unit for processing, it must be returned to some point within the mixer. The EFX RETURN jack accepts a standard 1/4-inch phone plug and will accept signals from both high- and low-level effects. The signal from this jack appears at the EFX RETURN control.

Regardless of the effects used with the 100M, it is extremely important that any "Blend" control on the effects unit be set at 100% or full effect. If not, expect overall volume changes when the effects return control is varied. Since most "pedal"-type effects lack this control, their use with the 100M (or any other effects send/return system) is not recommended.

7. MONITOR OUT: The MONITOR SEND output is the mix of all the individual monitor send controls. It is not affected by the graphic equalizers regardless of the setting of the MODE switch.

This is a line-level output (+4 dBu nominal) and is capable of driving power amplifiers or other line-level inputs. It can also be used for making a recording that is not affected by the other mixer controls or as a send to an external sound system.

8. AMPLIFIER AND EQUALIZER PATCHING JACKS

These jacks allow the amplifiers and/or equalizers in the 100M access to the outboard equipment. The jacks may be used to:

- a. patch both internal amplifiers to one graphic EQ output
- b. patch either graphic EQ output to an external amplifier(s)
- c. separate the internal amplifiers completely from the 100M's mixer circuitry
- d. patch from the graphic EQ output directly to a tape recorder for recording, where the effect of the EQ is desired
- e. patch in external equalizers

The Equalizer output jacks (GRAPHIC EQ OUT) and the Amplifier input jacks (AMP IN) are "normaled." That is, they don't require patch cords for operation. The equalizer output jack may be patched into any time without disrupting the signal flow to the internal power amplifiers. The amplifier input jacks interrupt the signal coming from the graphic EQ section when a plug is inserted into them.

The signals at the GRAPHIC EQ OUT jacks are line level to drive power amplifiers and other line-level devices.

The AMP IN jacks require line-level signals (+8 dBu for amplifier clipping).

Use shielded cable for all connections at this point.

9. AC POWER REQUIREMENTS AND FUSE INFORMATION

CAUTION

Hazardous voltages and currents may be encountered within the chassis. The service information contained within this document is for use by Electro-Voice authorized warranty stations and qualified service personnel only.

The 100M can operate on 100, 120, 220 or 240 V ac, 50/60 Hz.

For 90-110 V, 60 Hz, use the 100-V setting (Japan). For 108-126 V, 60 Hz, use the 120 V setting. For 198-231 V, 50/60 Hz, use the 220-V setting. For 216-252 V 50/60 Hz, use the 240-V setting.

Replace the ac mains fuse with a 3-A Slo-Blo, type MDL3 fuse only (Export models, refer to the fuse data label on rear of the unit). Repeated fuse blowing is a sign of internal trouble and will only be aggravated by replacing the blown fuse with one of larger value.

10. POWER ON/OFF SWITCH: Turns the entire 100M on and off.

11. PHANTOM POWER SWITCH: The PHANTOM POWER switch controls the internal 48 V phantom power supply. Phantom powering is a compatible system, that is, normally used dynamic microphones may be used along side phantom powered condenser microphones without damage.

Phantom powering imposes certain demands on cables and microphones used. Since microphone cables carry the electrical power that operates the microphones, all solder connections within the mic connectors must be of the highest quality. Otherwise, extraneous noise may occur.

Some microphones may exhibit random noise (cracking, sputtering or popping) when used in a phantom-powered system. This problem is due to

the transformer or the microphone cartridge developing a leak to the case. The leakage causes the noise, not the phantom power. Possible solutions:

- A. Turn off the phantom power.
- B. Replace the mic.
- C. Repair the mic.

Be careful not to plug in or unplug microphones with phantom power present. Always turn the channel fader or the master down before plugging in or unplugging microphones to avoid loud, unpleasant noises which could be harmful to speakers.

12. POWER AMPLIFIER ASSIGN MODE SWITCH:

This switch controls the assignment of the 100M's internal graphic equalizers (and amplifiers, if not re-assigned by patching). In the Stereo mode, the Left equalizer is assigned to the Left stereo output, while the Right equalizer is assigned to the Right stereo output. In the MONITOR/MONO mode, the Left equalizer is assigned to the MONITOR output, while the Right equalizer is assigned to the MONO output.

13. REVERB FOOTSWITCH JACK: The REVERB Footswitch jack allows the internal reverb to be switched on and off remotely from the 100M. Use any footswitch that connects the phone plugs hot wire to ground (this includes 99% of all standard footswitches). The footswitch cable does not need to be shielded. The reverb is switched on when the hot wire is grounded.

14. HEADPHONE JACK: The HEADPHONE jack is located on the rear panel. It monitors the outputs of the internal power amplifiers. It is suitable for stereo phones with a rated impedance of 8 to 20,000 ohms.

INSTALLATION

This section will deal with some of the more common setups for the 100M. Each one will begin with the basics and end with additional refinements or special situations.

STEREO PA

The 100M is ideal as a stereo mixer-amplifier. Its versatility allows it to stand alone, or be the nucleus of a much larger system. In this system, each microphone feeds one input on the 100M. One speaker is driven from each amplifier output. The MODE switch is set to the L/R MAINS (stereo) position.

The mono mixer output could be used to drive an external system. An external amplifier is needed for monitors, if used.

Procedure:

1. The following equipment is needed: the 100M, two 100S speakers and microphone(s).
2. Set the speakers up on each side of the stage area.
3. Place the 100M in a convenient location.
4. Plug the 100M's power cord into an ac outlet, but **do not** turn the unit on.
5. Plug the 100S speakers into the LEFT and RIGHT

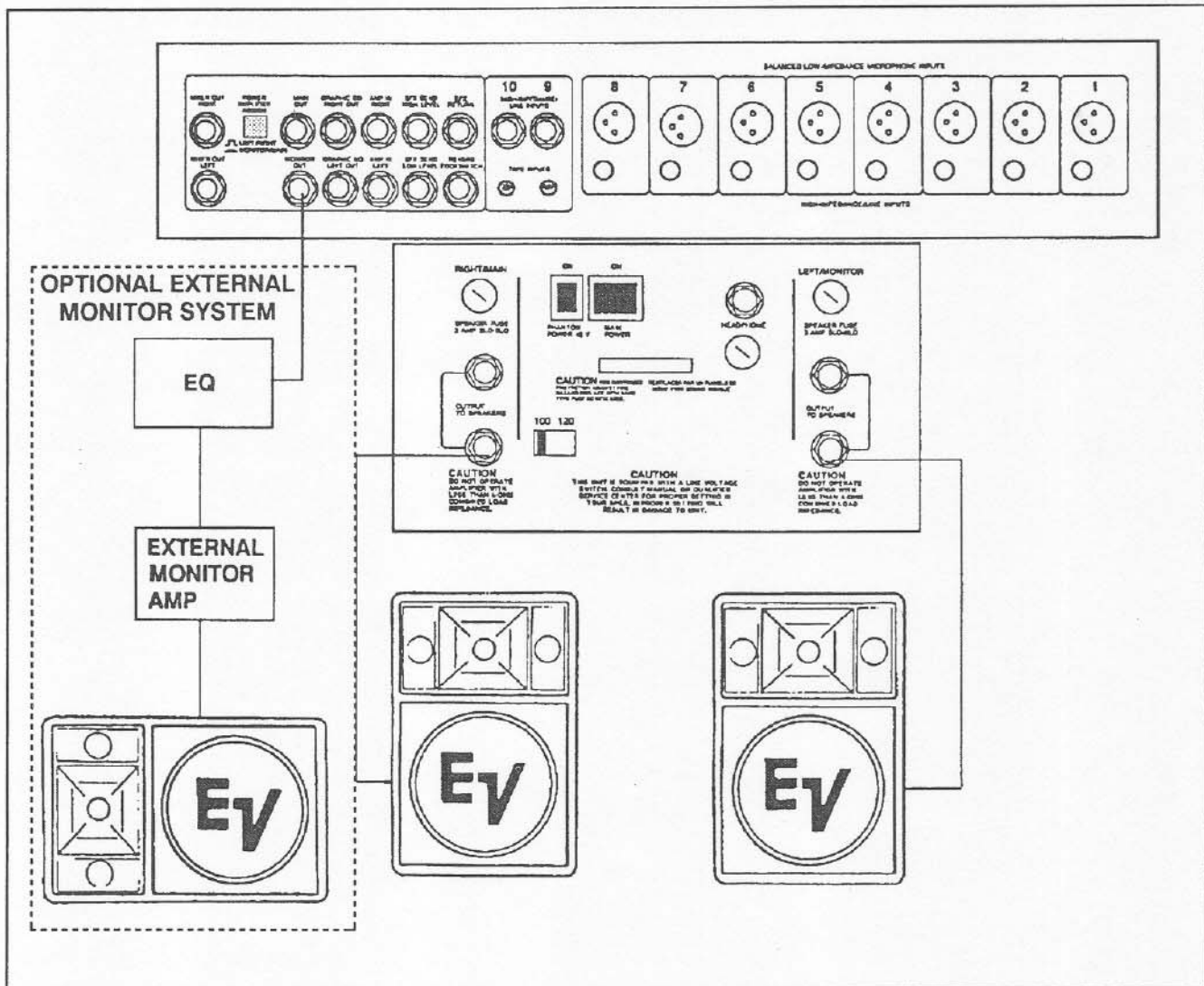

Figure 1 - Stereo PA Installation

- amplifier output jacks.
6. Set the SUB L and SUB R controls to their lowest setting and both graphic equalizers' controls to the 0-dB mark (centered).
7. Set the MODE switch to the L/R MAINS position.
8. If condenser microphones are connected, turn the PHANTOM POWER switch on.
9. Turn on the 100M.
10. Adjust the GAIN controls to the 12 o'clock position.
11. Set the channel PAN and EQ controls to about the 12 o'clock position.
12. Set the channel FADERS to the 0-dB setting on their scale.
13. Bring up the SUB L and SUB R slowly while speaking into one of the microphones until sound is heard.
14. If the CLIP indicators on any channel illuminate,

- use a lower GAIN control setting.
15. If feedback is heard before sufficient volume is reached, use the equalizers to minimize it.
16. Monitors will require an external equalizer (optional) and amplifier.

MONO PA

The 100M is also ideal as a mono mixer-amplifier. Again, its versatility allows it to stand alone, or be the nucleus of a much larger system.

Use the mono mode of the 100M in situations where seating or other physical constraints prevent audience members from hearing both loudspeaker systems. Use of the stereo mode in this situation might cause some listeners to only hear part of the material.

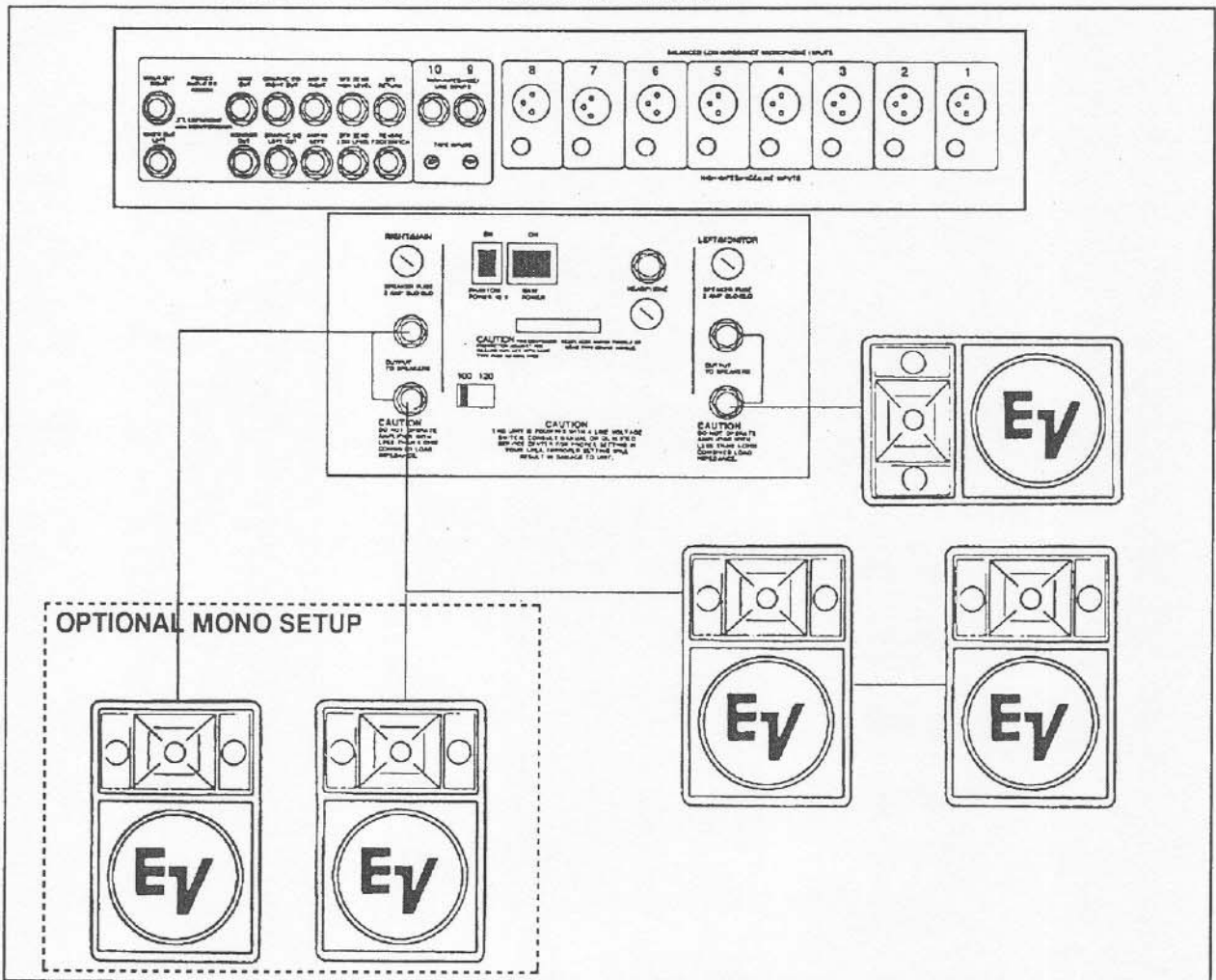

Figure 2 - Mono PA Installation

In mono use, the two stereo mixing channels of the 100M may be used as subgroups, allowing the various inputs to the mixer to be grouped; for example, the vocals and instruments.

To group the vocals and instruments:

1. Assign vocals to the left submaster (SUB L) bypanning all vocal sources to the left using the input channel pan control.
2. Assign all instrument sources to the right stereo master by panning all instrument sources to the right using the input channel pan control.
3. The left submaster (SUB L) is now the vocals master and the right submaster (SUB R) is the instruments master. Control the overall level using the MONITOR master control.

In this system, stage monitors are shown. They are driven from one of the internal power amplifiers. The Monitor/Main mode switch on the back panel must be activated. No additional patching is required.

The monitor speakers used with the 100M can be any high-quality monitor speaker. The 100S speakers make excellent monitors. Remember, any of the following combinations of monitors may be used: one 4-ohm monitor, two 8-ohm monitors or four 16-ohm monitors driven from one channel of the 100M. More monitors or more powerful amplifiers can be connected.

Procedure:

1. The following equipment is needed: the 100M, two 100S speakers and microphones. Monitor speakers are optional.
2. Set up the speakers on each side of the stage area.
3. Place the 100M in a convenient location.
4. Plug the 100M's power cord into an ac outlet, but **do not** turn the unit on.
5. Plug the 100S speakers into the RIGHT AMPLIFIER outputs.
6. Set the LEFT and RIGHT Submasters to their lowest setting. Set both graphic equalizers to the 0-dB mark (centered).
7. Put the MODE switch in the MONITOR/MAIN position.
8. If condenser microphones are connected, turn the PHANTOM POWER switch on.

9. Turn the 100M on.
10. Adjust the GAIN controls to about the 12 o'clock position.
11. Set the PAN and EQ controls to about the 12 o'clock position.
12. Set the channel FADERS and the LEFT and RIGHT SUBMASTERS to the 0-dB setting on their scales.
13. Turn up the MONITOR MASTER slowly while speaking into one of the microphones until sound is heard.
14. If the CLIP indicators on any channel light, use a lower GAIN control setting.
15. If feedback is experienced before a sufficient volume is reached, use the graphic equalizer to minimize it.
16. Connect monitors to the LEFT AMPLIFIER output. Set up a monitor mix using the individual monitor pots. Slowly bring up the MONITOR MASTER control. Use the left graphic EQ to minimize feedback.

USING A TAPE RECORDER

There are several points at which a tape recorder can be hooked up to the 100M in order to record:

1. stereo outputs
2. mono output
3. equalizer outputs
4. monitor and effects sends

The stereo and mono outputs are not affected by the graphic equalizers in the 100M. Use these outputs for the majority of recording hookups, especially when the equalizers are being used to correct a feedback problem or poor room acoustics.

The equalizer outputs can be used for a tape recording. Best results from these outputs are obtained when the equalizer is not being used, or when it is used for general response shaping.

For specialized applications, the monitor and/or effects outputs may be used. The MONITOR output has the attribute of being independent of nearly all the mixer's controls. Conversely, the EFFECTS SEND is affected by nearly all the input channels' controls. Use either of these when you want a spe-

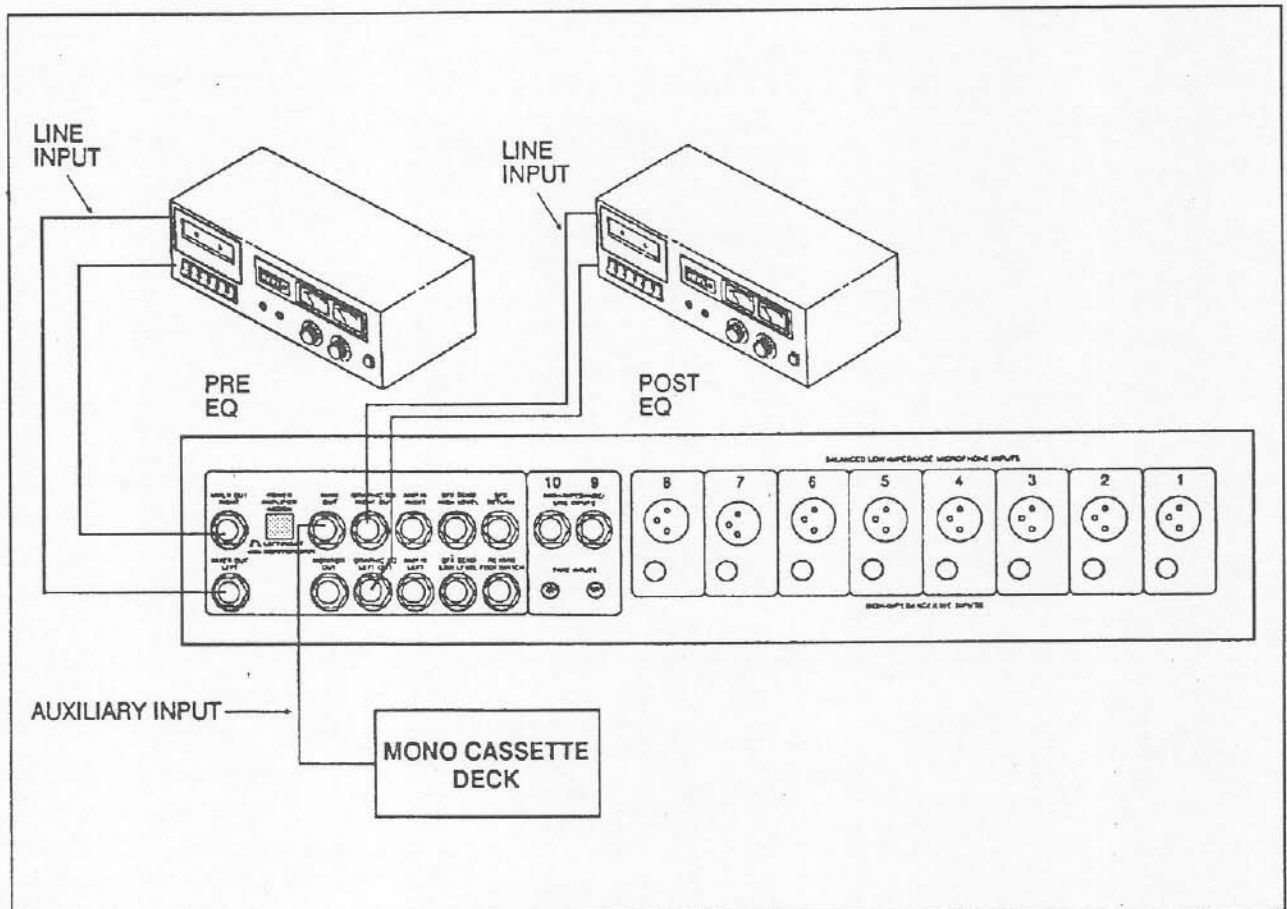

Figure 3 - Tape Recorder Hookup

cial mono mix to go to the tape recorder. For example:

1. A conference is being recorded and all microphones connected to the 100M need to go to the tape recorder regardless of the settings of the individual faders. For this, choose the MONITOR SEND, since its signal source is pre fader, pre EQ.

2. A recording of the board output is desired, but for one reason or another, the mix available at the mono output just isn't quite right (some things are too loud, other things aren't loud enough). Use the EFFECTS SEND and the individual EFX/REV Sends to balance out the various inputs. Do this once everything is relatively set in the mains. Since the EFFECTS SEND is post fader, post EQ, the recording will follow any changes made in the main mix, but with the altered perspective given it by the EFX/REV send controls.

If any of the above outputs are being used to drive an additional device, use a Y cord to connect the tape

machine. There's plenty of drive available from the mixer's output.

CAUTION

DO NOT HOOK UP A TAPE RECORDER TO THE AMPLIFIER OUTPUTS.

USING A TAPE PLAYER OR TURNTABLE

There are several points at which a tape machine or turntable (with RIAA preamp) may be connected to play back through the 100M.

- A. via an Input Channel Line input.
- B. via High-Impedance/Line inputs 9 and 10
- C. via the Effects Return

If an input channel is used, the following can be done to the tape machine signal:

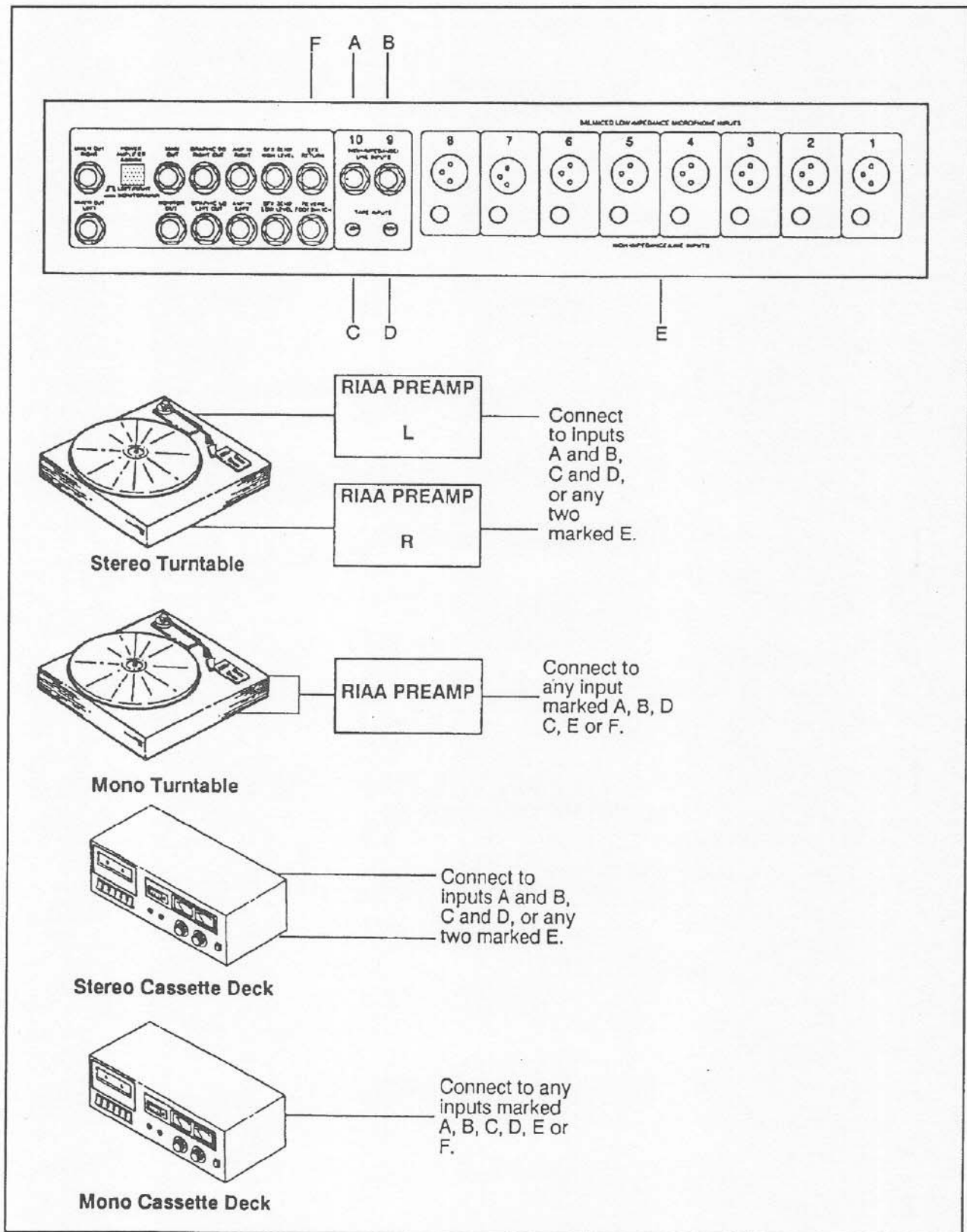

Figure 4 - Turntable/Tape Recorder Hookup (Play Mode)

1. Send the signal to the MAIN outputs pan between the speakers.
2. Send the signal into the monitors.
3. Equalize the signal with the tone controls.
4. Add reverb to the signal.

If the LINE/AUX inputs 9 and/or 10 are used, the following can be done:

1. Send the signal to the MAIN outputs and pan it between the speakers.
2. Send the signal to the monitors.

If the EFFECTS RETURN is used, the following can be done:

1. Send the signal to the main outputs.

If the source is stereo, separate inputs must be used (one panned left, the other right) to maintain stereo separation. Otherwise, the sound is MONO!

HOOKING UP INSTRUMENTS DIRECTLY

Instruments are best connected to the 100M through one of the 8 High-Impedance/Line inputs or to one of the Balanced Low-Impedance Microphone inputs

via a direct box or matching transformer (EV #502CP).

Instruments having high output levels may be connected to inputs 9 or 10. If sound levels aren't high enough, use inputs 1 through 8.

EXTERNAL EFFECTS

External effects are easily connected to the 100M. Be sure to select the proper EFFECTS SEND jack for your particular device.

Several points in the 100M's mixer section may be used for effects returns beside the EFFECTS RETURN input. These are:

1. Line inputs 1 through 8
2. Line inputs 9 and 10

Using either of these inputs allows the effects signal into your monitors as well as the mains. Simply turn up the monitor send control.

Be certain that the blend or mix control in the external effects device is set to the maximum or 100% position. Failure to do this may result in overall volume changes as the effect is brought in and out.

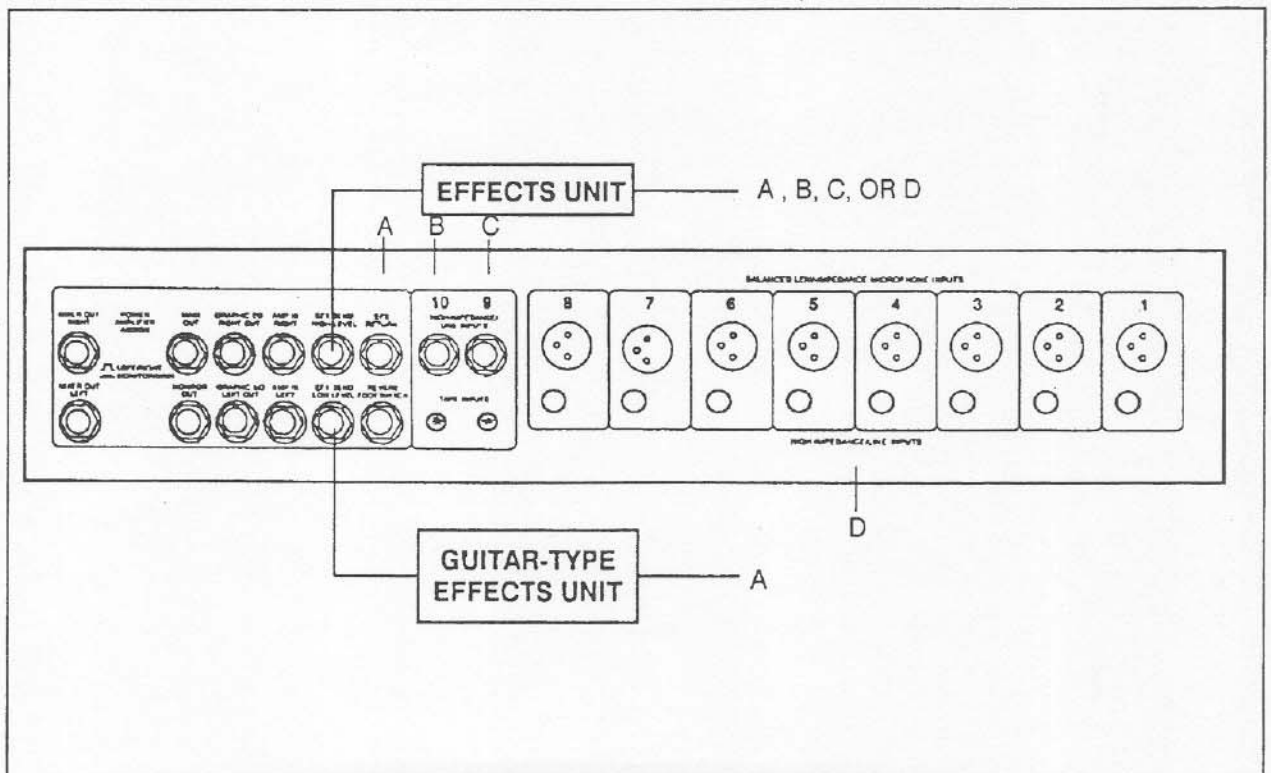

Figure 5 - External Effects Hookup

"Pedal"-type effects are especially prone to this type of problem.

RE-PATCHING THE EQUALIZERS

Figures 6 and 7 illustrate the various ways that the equalizer outputs may be used.

1. Driving external monitor amplifier (monitor-mono mode).
2. Driving external amplifier for a stereo system.
3. Driving an electronic crossover for bi-amplified system.

RE-PATCHING THE AMPLIFIERS

Figures 8 and 9 illustrate the various ways that the amplifier input jacks can be used.

1. Both amplifiers can run the monitors.
2. Both amplifiers from the mono output.
3. Amplifiers separated from 100M mixer section.

MONITORS

If monitors are used, consider the following:

1. Cardioid (unidirectional) microphones are essential for vocal and acoustic instrument use.
2. Consider using a pickup for acoustic guitar instead of a mic that would be more susceptible to feedback.
3. The sound source must be very close to the microphone if loud monitors are essential.
4. Position the monitor speaker at the null (dead zone) of the cardioid microphone. For single-D microphones, this is usually at 180° (the rear of the microphone) for maximum feedback rejection.
5. Position the main speakers so as to minimize spill into the mikes that feed the monitor speakers.
6. Be careful when using equalization on the monitor system with a graphic or other equalizer.

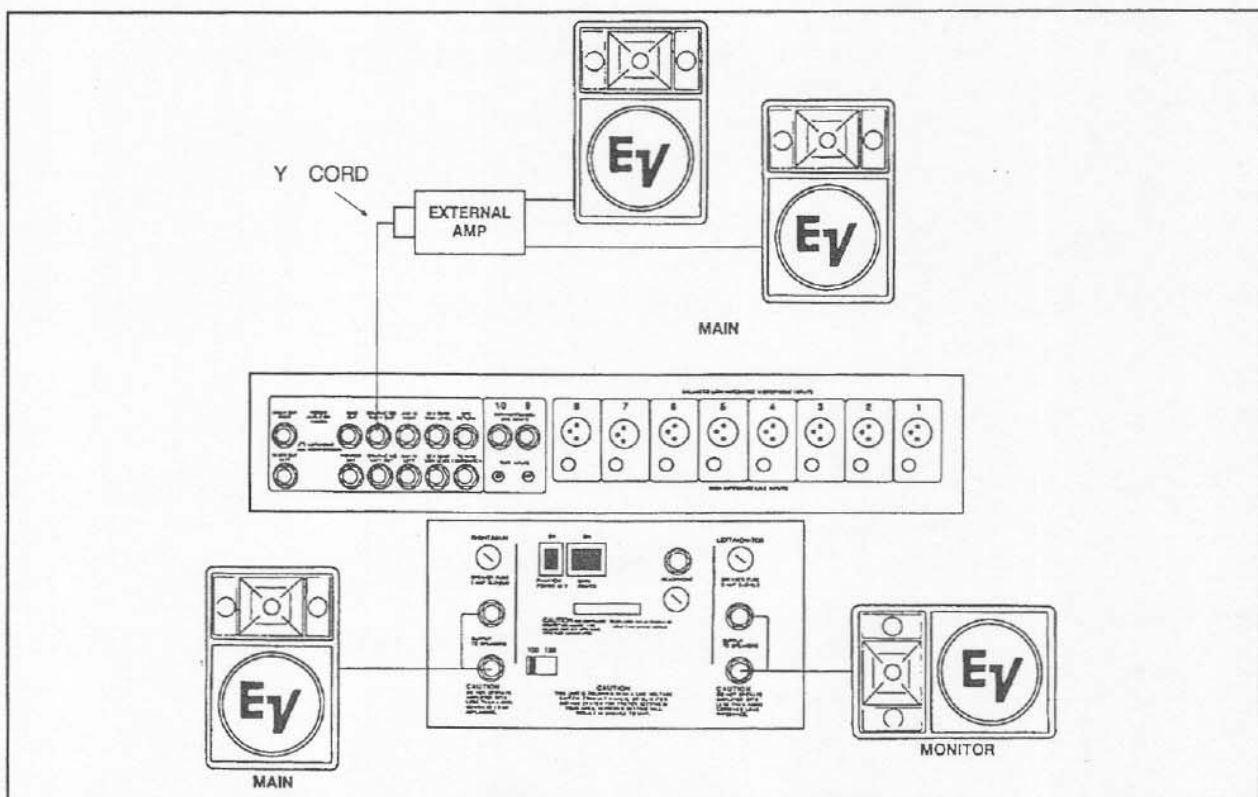

Figure 6 - Monitors Using External Amplifier

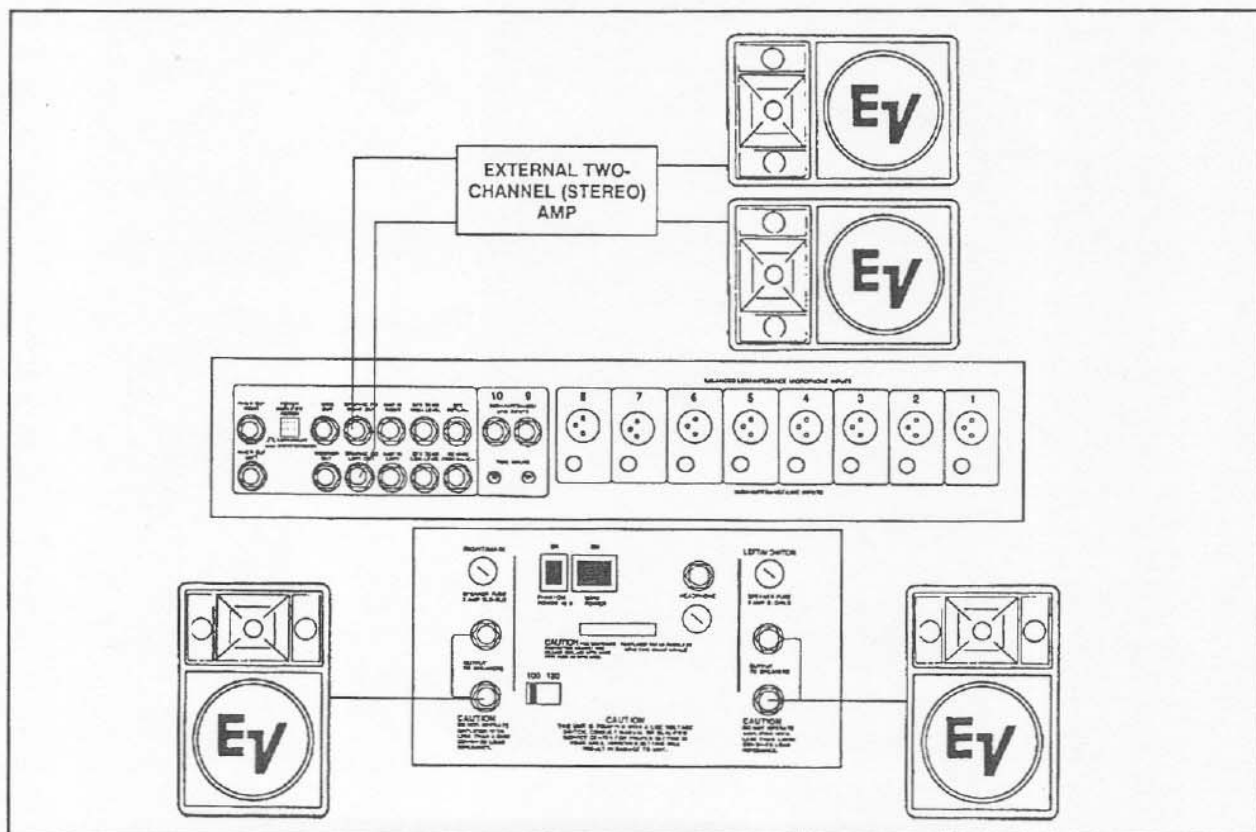

Figure 7 - External Amplifier for Stereo

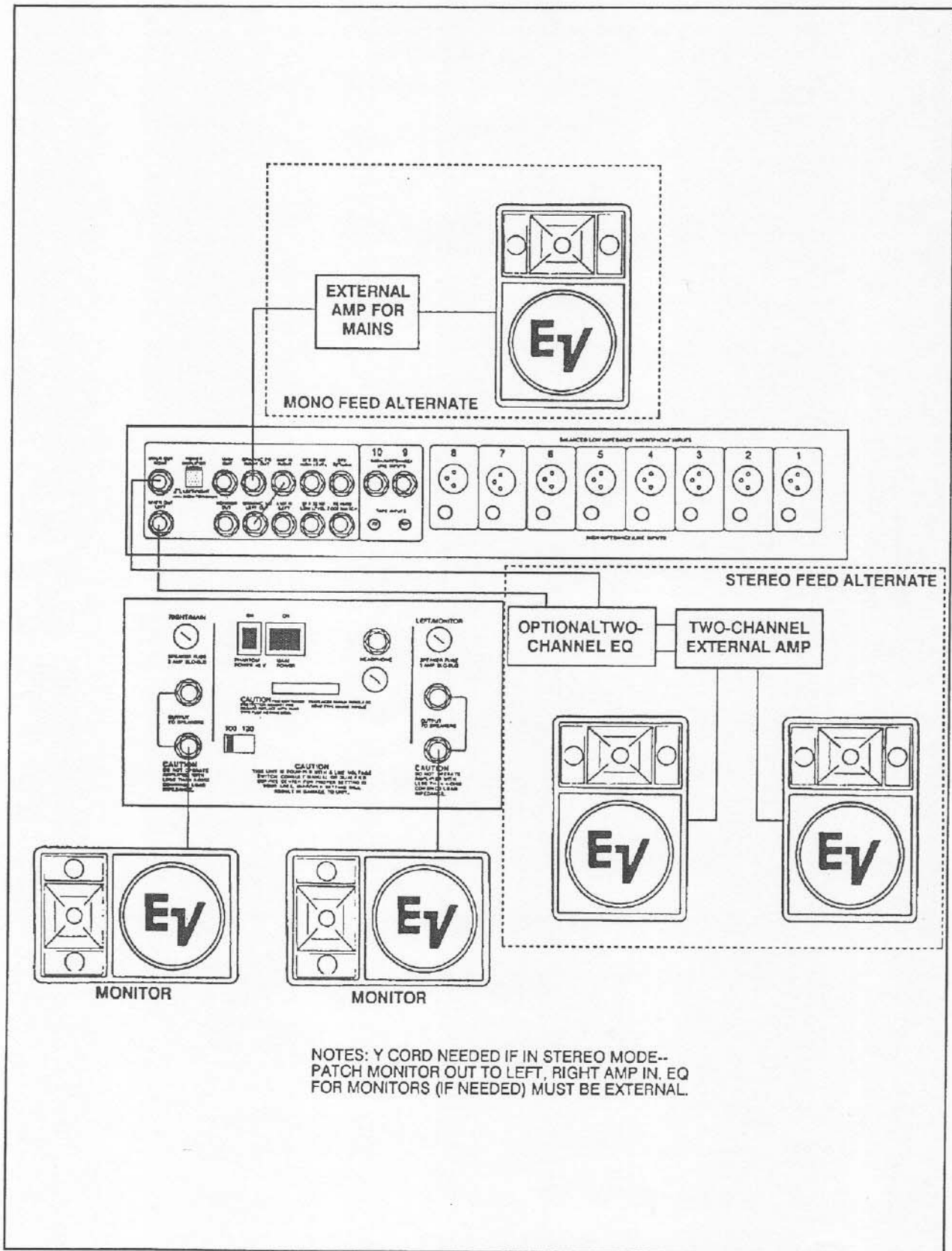

Figure 8 - Internal Amps Running Monitors

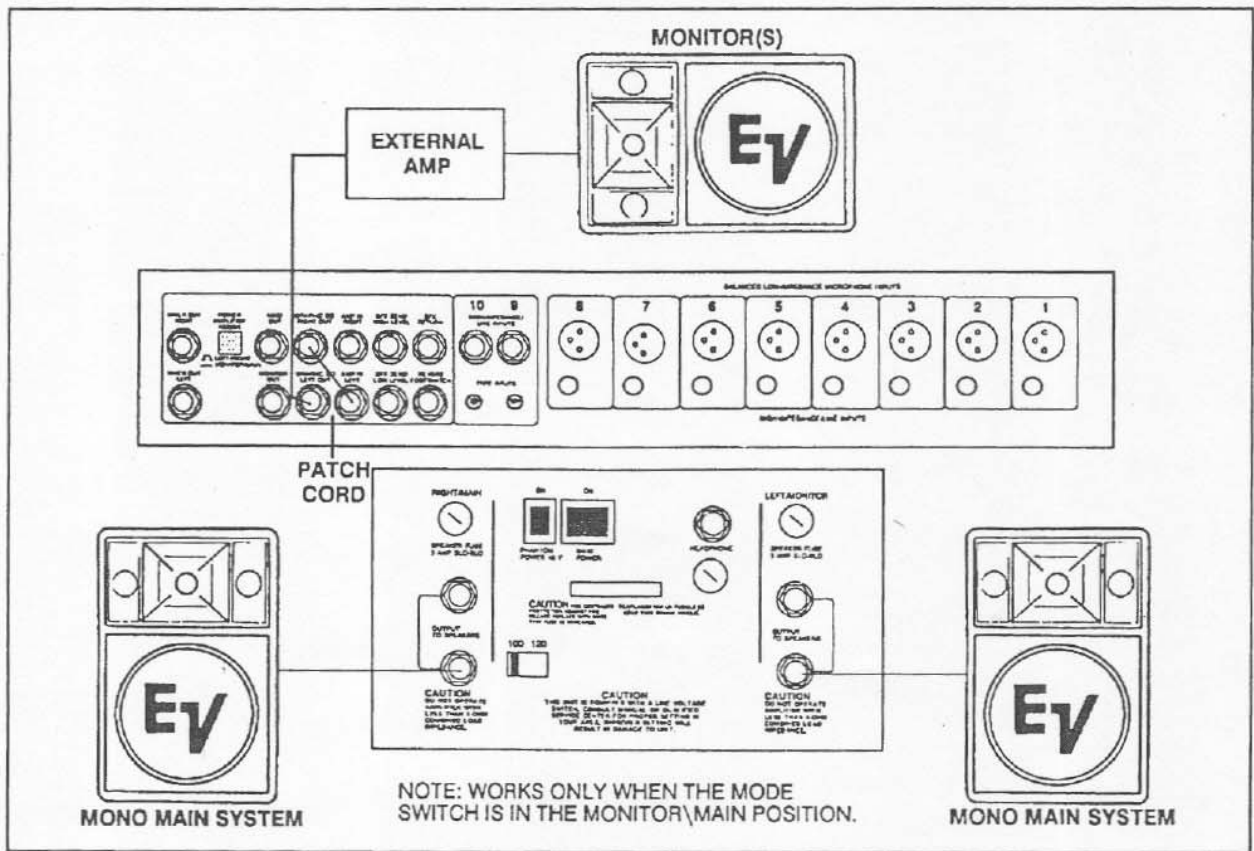

Figure 9 - Both Amps Used for Mono