



OWNER'S MANUAL

**MIXING
CONSOLE**

TABLE OF CONTENTS

PAGE	
	INTRODUCTION3
	PRECAUTIONS3
	MONO INPUT SECTION4-5
	STEREO INPUT SECTION6-7
	AUX RETURN SECTION8
	AUX SEND SECTION8
	GROUP SECTION9
	MASTER SECTION10
	TALKBACK/MONO SECTION11-12
	LED METER SECTION13
	REAR PANEL CONNECTORS
	Input section connectors.....14-15
	Master section connectors.....15-16
	GENERAL WIRING PROCEDURES17
	AUDIO WIRING17
	RADIO-FREQUENCY INTERFERENCE17
	SPECIFICATIONS18
	BLOCK AND LEVEL DIAGRAM19
	SCHEMATIC DIAGRAM20-29
	WARRANTY30

M4 MIXING CONSOLE

INTRODUCTION

Thank you for your purchase of the Electro-Voice M4 4-Buss mixing console. The M4 has been designed to give you years of trouble-free use with excellent performance. Although it is relatively easy to use, you will find hookup and operation simpler if you spend some time reading this manual to familiarize yourself with the M4's many features.

FEATURES

- 16 or 24 mono input channels that can route signals to 4 subgroups, 6 aux sends, stereo and mono master outputs. Each channel has balanced XLR microphone inputs and balanced TRS 1/4-inch line jacks.
- 4 stereo input channels provide stereo input routing to the four subgroups, 6 aux sends (2 pre/4 pre or post) and to the stereo master outputs. Each stereo input channels has a fixed 2-band EQ.
- Each mono input channel is equipped with 6 aux sends (2 pre-fader/EQ, 4 switchable pre or post-fader/EQ). A selector switch on each channel allows a choice of signal routing to aux 3 / 4 or to Aux 5 / 6. Four stereo aux returns allow excellent signal routing potential. 100-mm faders are provided for more precise mix control.
- Each mono input channel has 3-band EQ with semi-parametric mid range that provides excellent sound tailoring capabilities.
- 4 subgroup mixing busses, each with its own 100 mm fader, signal routing and mute switches, gives additional routing and mix capabilities.
- Each mono input channel is equipped with insert input/output allowing connection of signal processors independently on each channel. A separate direct output allows signal routing for recording.
- Each subgroup and the master stereo outputs have insert input/outputs and balanced TRS inputs allowing connection of sub-mixers or other processors independently on each output.
- After-Fade Listen (AFL) allows monitoring of the output signal from each subgroup output and aux send through headphones at any time.
- Separate tape inputs and record outputs allow easy connection of CD players and tape decks for playback and recording.
- Universal 48 V phantom power is provided for powering condenser microphone and direct boxes.

- A BNC-type Littlelite[®] connector is provided for connection of a lamp to illuminate the panel.

PRECAUTIONS

1. **AVOID EXCESSIVE HEAT, HUMIDITY AND DUST**
Keep the mixer away from locations where it is likely to be exposed to high temperatures, oppressive humidity and dust. These elements are potentially harmful to any piece of electronic equipment.
2. **VENTILATION**
The mixer has ventilation slots on the side and bottom panels. Do not block these vents or prohibit airflow into them.
3. **AVOID STRONG PHYSICAL SHOCKS AND VIBRATION**
Although the M4 is designed to handle the rigors of transportation, strong shocks and vibrations can cause damage. Care in handling during transportation will improve operational reliability.
4. **DO NOT OPEN THE CHASSIS OR PERFORM MODIFICATIONS**
The M4 contains no user-serviceable parts. Refer all maintenance to qualified service personnel. Opening the case and tampering with the circuitry will void the warranty (see the warranty statement at the end of this manual for details).
5. **TURN THE POWER OFF BEFORE MAKING CONNECTIONS**
Turning the power off before connecting or disconnecting cables will eliminate potentially harmful and annoying hums and buzzes. Handle cables carefully and grip them by the connector, not the cable.
6. **CLEAN WITH A SOFT, DRY CLOTH**
Avoid cleaning the mixer with solvents such as benzine or thinners. Wipe the panel clean with a soft, dry cloth.

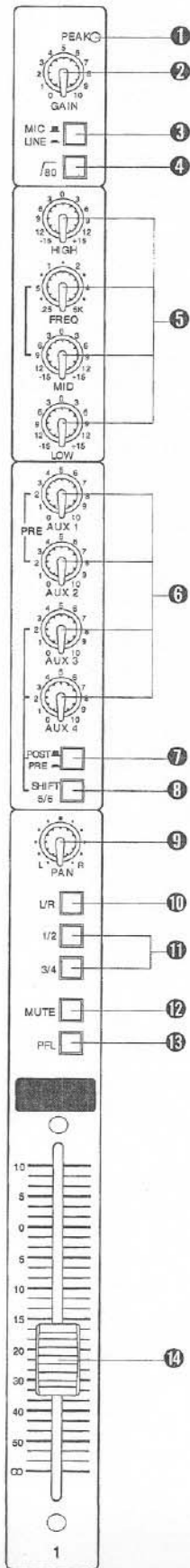

1. MONO INPUT SECTION

1. PEAK INDICATOR

This indicator detects peak signal level after the EQ and will light red 3 dB before clipping to warn of the onset of clipping distortion. This light is useful in setting the gain control optimally.

2. GAIN CONTROL

This control is used to adjust the input signal to the appropriate level. The best balance of dynamic range and signal-to-noise ratio can be achieved if the level is adjusted so that the peak indicator flashes occasionally on the loudest passages.

3. INPUT SELECTOR

This switch selects the appropriate input for the channel. When the switch is in the up position, the 3-pin XLR-type microphone input is selected. When the switch is depressed, the 1/4-inch line input is selected.

4. HIGH-PASS FILTER

This switch controls a high-pass filter that rolls off signals below 80 Hz at 12 dB-per-octave. By engaging the high-pass filter, you can minimize stage rumble, wind noise, p-pops and other unwanted low-frequency noise.

5. EQ SECTION

The EQ section is a 3-band equalizer with the following properties:

HIGH: Shelving-type, ± 15 dB at 12 kHz

MID: Peaking-type, ± 15 dB, variable from 250 Hz – 5 kHz

LOW: Shelving-type, ± 15 dB at 80 Hz

The frequency response is flat when the controls are in their center (detented) positions.

6. AUX 1 – 6 CONTROLS

These controls regulate the amount of the channel's input signal that is sent to each respective aux sends for further routing.

Aux 1 and Aux 2: These controls regulate the amount of pre-fader, pre-EQ signal (typically used for monitors) routed to the Aux 1 and Aux 2 busses.

Aux 3 and Aux 4: These controls regulate the amount of post-fader, post-EQ signal (typically used for effects) sent to the Aux 3 and Aux 4 busses.

Aux 5 and Aux 6: Depressing the Shift 5/6 switch (#8 on the panel drawing) changes Aux 3 into Aux 5 and Aux 4 into Aux 6. When the switch is depressed, these controls become active and provide further signal routing capability.

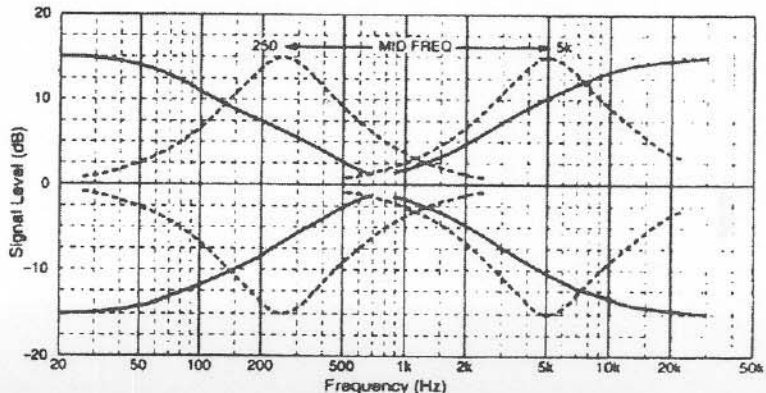

M4 MIXING CONSOLE

7. Aux 3 – 6 PRE/POST SELECTOR SWITCH

This switch determines whether the channel's signal sent to the Auxs is pre-fader/EQ or post-fader/EQ. If the switch is in the up position, the signal will be post-fader and post-EQ. If the switch is depressed, the signal will be pre-fader, pre-EQ and unaffected by the channel's fader and EQ settings.

8. AUX 3 – 6 SIGNAL SELECT SWITCH

This switch, as noted above, connects the Aux 3 and Aux 4 controls to either the Aux 3 and 4 or to Aux 5 and 6 sends. When the switch is depressed, Aux 5 and Aux 6 are selected as the sends.

9. PAN CONTROL

This control adjusts the position of the signal in the stereo mix and also between odd and even subgroups if that routing is selected. Turning the pan control to the left moves the input signal toward the left channel and/or the Aux 1 and Aux 3 Subgroups. Turning the pan control to the right moves the input signal to the right channel and/or the Aux 2 and Aux 4 Subgroups. Centering the control moves the inputs to the center and if all inputs are panned center, the result is mono. Moving different inputs around can result in better imaging and sound quality. It can also be useful in minimizing feedback.

10. L/R (STEREO) SWITCH

When this switch is engaged, the channel's signal will be routed to the main stereo outputs of the console. When the switch is off, the channel's routing to the main left/right outputs is muted.

11. GROUP SELECTOR (BUSS ASSIGN SWITCH)

When these switches are engaged, the channel's input signal can be routed to the 4 group busses. In conjunction with selecting

the group routing, the position of the channel's pan control determines if a signal is routed to Group 1 or 2 and/or Group 3 or 4. If the pan control is panned left, it will be routed to Group 1 and/or 3; if the pan control is panned right, the signal will appear at Group 2 and/or 4.

12. CHANNEL MUTE SWITCH

When this switch is engaged, the channel's output to all subgroups, post-fader aux sends, the record outputs and the master stereo outputs are muted. The mute control is useful during breaks or scene changes in a performance when no output is required. The mute switch allows all the other control settings to remain in place. The channel's mute switch does not affect the channel's insert output, direct output and the pre-fader Aux sends.

13. CHANNEL PFL SWITCH

PFL (Pre-Fader Listen) allows the operator to monitor any pre-fader signal individually or in combinations, through the headphone output. In the "normal" position (all PFLs off), the headphone output tracks the Left/Right stereo mix. When the mixer is in the PFL mode, the headphone levels are controlled by their level control.

14. CHANNEL FADER

The 100-mm audio-taper fader controls the output level of the channel that is fed to the Stereo Master and the Subgroups. The channel fader should optimally be set near the "0" level when all other controls are set to their nominal levels. Assuming that the gain control is set properly, keeping the fader within ± 6 dB of 0 dB will insure the lowest distortion, the highest signal-to-noise ratio and the greatest amount of headroom.

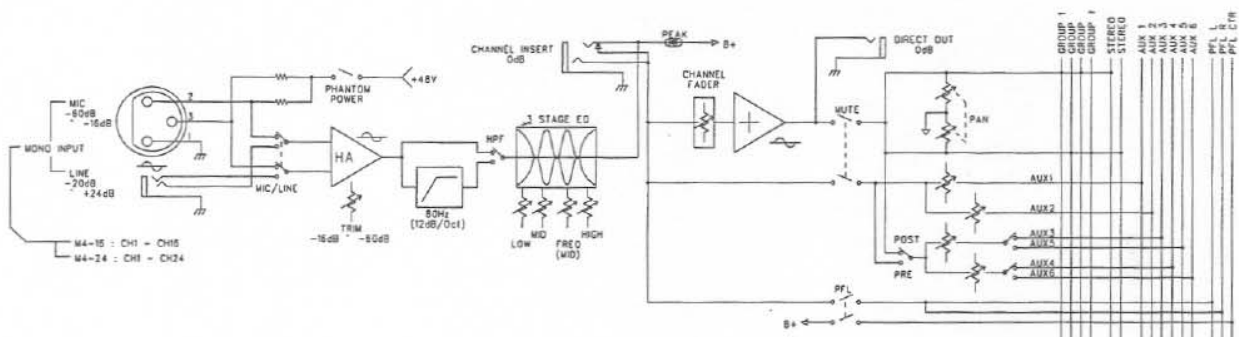

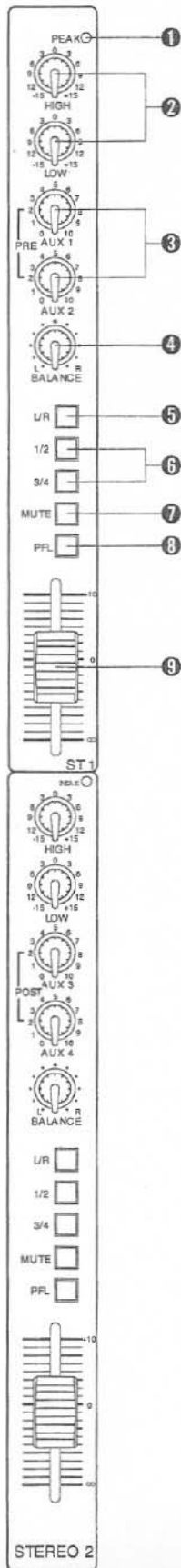

2. STEREO INPUT SECTION

1. PEAK INDICATOR

This indicator detects peak signal level after EQ. It will light red 3 dB before clipping to warn of the onset of distortion. If the indicator shows continuous overload with nominal level signal, the channel's input sensitivity can be switched either -10 dBv or + 4 dBv.

2. EQ SECTION

The stereo channel EQ is a 2-band, fixed frequency equalizer with the following properties:

HIGH: Shelving type, ±15 dB at 12 kHz

LOW: Shelving type, ±15 dB at 80 Hz

3. AUX SEND CONTROLS

These controls regulate the amount of signals sent to the Aux busses.

Stereo Channels 1 and 3 have controls that send a signal to Aux1 and Aux 2. These controls are pre-fader and the signal level sent to those busses are unaffected by the channel fader setting.

Stereo Channels 2 and 4 have controls that send a signal to Aux 3 and Aux 4. These controls are post-fader and the signal levels sent to the Aux 3 and Aux 4 are independent of the channel's fader setting.

4. BALANCE CONTROL

This control adjusts the balance or Left/Right position of the stereo input signal. Turning the BALANCE control to the left of center moves the apparent source toward the left channel and the Groups 1 and 3 busses. Turning the control to the right of center moves the sound toward the right channel and Groups 2 and 4 busses.

5. L/R (STEREO) SWITCH

When this switch is engaged (in), the signal of each channel will be sent to the Stereo (left/right) masters. When this switch is off (out), the output to the Stereo masters will be muted.

6. GROUP ASSIGN SWITCHES

When these switches are on, the signal of each channel will be sent to the respective group busses. The switches allow a signal to be routed to Groups 1 / 2 and/or 3 / 4. A signal sent to Groups 1 and 3 will be routed to the left master output and a signal sent to Groups 2 and 4 will be routed to the right master output.

7. STEREO CHANNEL MUTE SWITCH

When this switch is engaged, the signal of each stereo channel will be muted in the main stereo outputs, Auxes 3 and 4 and to the sub-group busses. The signal can still be monitored with PFL and can be heard in the monitors if it is routed to Aux 1 and Aux 2.

8. CHANNEL PFL SWITCH

This switch allows monitoring of the pre-fader channel input signal through headphones. The PFL is useful in checking the sound of a source or in troubleshooting a specific channel.

M4 MIXING CONSOLE

9. STEREO CHANNEL FADER

This fader controls the output level of the stereo channel's signal to the Master Stereo Outputs and the Subgroups. Although these faders have a shorter "throw" than the ones in the mono input channels, they should ideally be operated ± 6 dB of nominal level for the lowest distortion and best signal-to-noise ratio and dynamic range. The faders should be lowered for all unused inputs.

10. STEREO CHANNEL INPUT SENSITIVITY CHANGE

The input sensitivity of the stereo input channels is set at the factory to +4 dBu level that is compatible with the inputs from keyboards, drum machines, effects units etc. If your needs require the stereo channel to handle

inputs from consumer-grade CD players and tape decks, the input sensitivity can be switched to -10 dBu level.

To make this change, the bottom panel of the mixer must be removed. Locate the PC board of the stereo input channel(s) by tracing the board attached to the channel controls. Locate switches #R206 and #R306 at the bottom side of the PC board and slide these switches to the -10 dB position. Take special care not to pull any connectors loose and to re-secure the bottom panel when you are done.

If you aren't capable of making this change, please consult your authorized Electro-Voice dealer or the factory for the name of an EV service center near you.

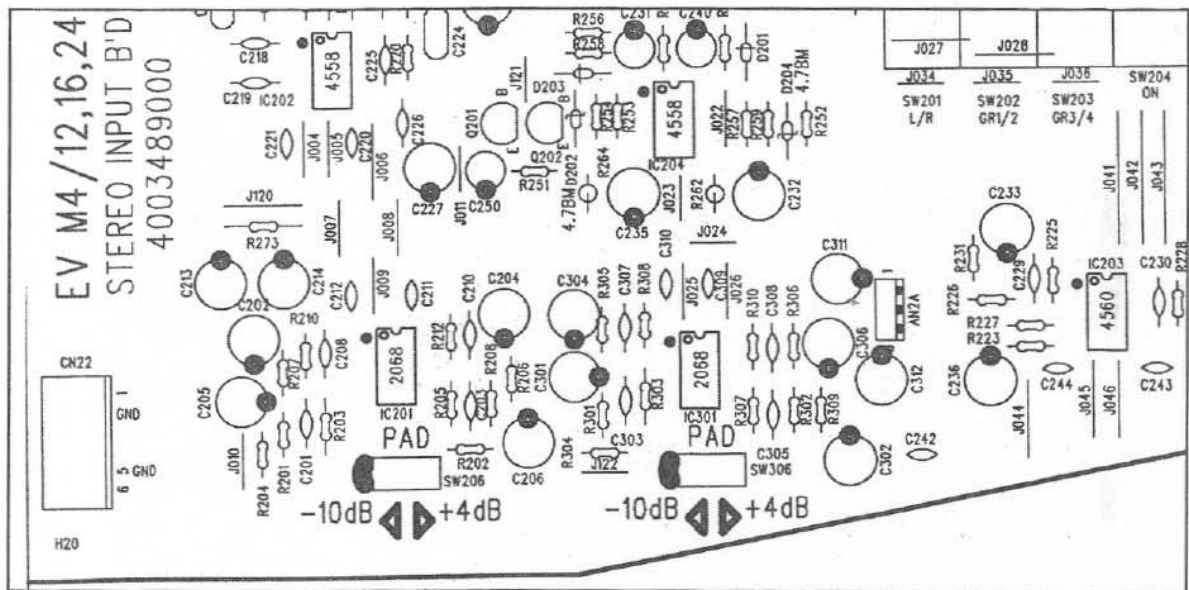

The select position of the PAD switch is at the bottom side of M4 Bus mixer.

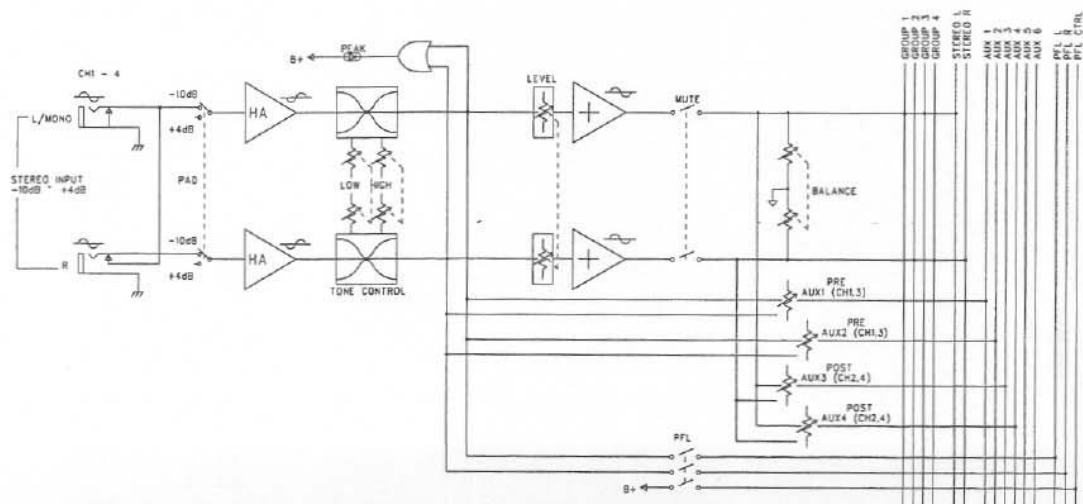

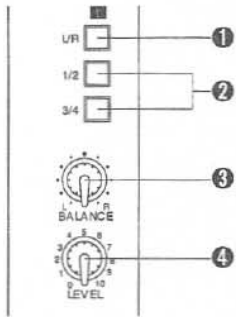

3. AUX RETURN SECTION

1. L/R STEREO SWITCH

When this switch is depressed, the signal of each AUX RETURN will be sent to the STEREO L/R buss. When this switch is off, the signal to the STEREO L/R buss will be muted.

2. GROUP ASSIGN SELECTOR SWITCH

When these switches are engaged, the signal of each aux return can be sent to the Group busses. When the 1 / 2 and/or the 3 / 4 switches are depressed, the signal will be sent to the respective busses for further routing.

3. BALANCE CONTROL

This control directs the signal coming from the Aux Return into the left and/or right channels. Turning the balance control to the left of center will route the signal toward the left channel and turning it to the right of center will move the image to the right channel. Centering the control will divide the signal evenly between the two stereo channels.

4. LEVEL CONTROL

This control adjusts the input levels from connected effects units, etc. into the main stereo mix and the 4 Subgroups.

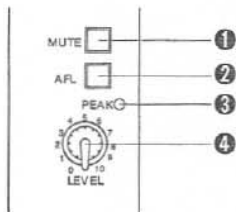
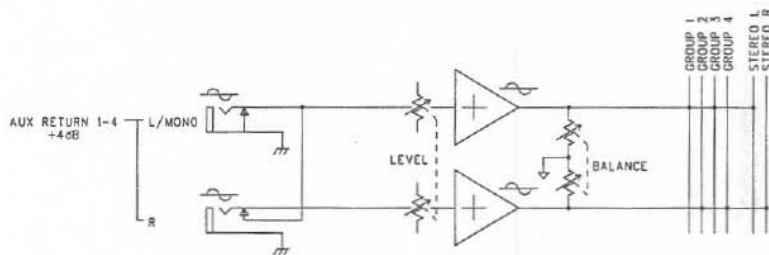

4. AUX SEND SECTION

1. MUTE SWITCH

When this switch is engaged, the signal from each respective Aux send will be muted to the corresponding Aux Send connector.

2. AFL SWITCH

The After-Fade Listening switch on each Aux Send allows convenient monitoring of the output signal that is being routed to each Aux Send connector. The AFL signal is routed to the headphone circuit and the level can be monitored via the LED meter (see section 8)

3. PEAK INDICATOR

This indicator detects the level of signal immediately before the Aux Send connector. It will light red 3 dB before clipping to warn that overload distortion level has nearly been reached.

4. LEVEL CONTROL

The Aux Send master adjusts the overall mix level on each respective Aux buss. The signal sent is the summed total of the individual sends on each input channel routed to a particular Aux Send.

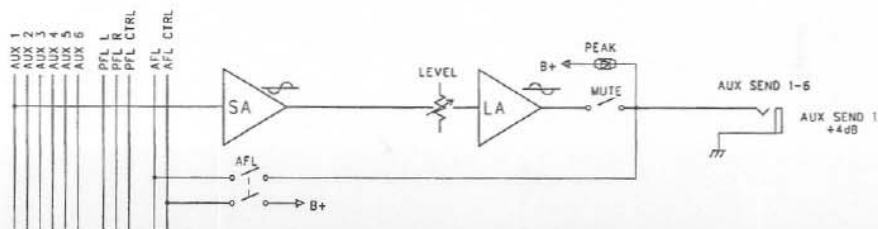

M4 MIXING CONSOLE

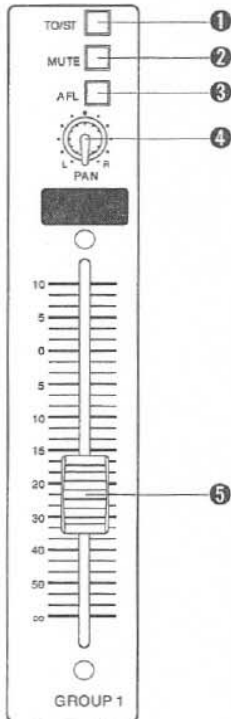

5. GROUP SECTION

1. "TO ST" SWITCH

When this switch is engaged, the signal of each Group will be sent to the Master Stereo buss.

2. MUTE SWITCH

When this switch is engaged, the output signal from each Group will be muted.

3. AFL SWITCH

Engaging this switch allows monitoring of the post-fader output of each Group individually. The AFL circuit will send the Group's signal to the headphone circuit for monitoring.

4. PAN CONTROL

This control adjusts the position of the Group's signal within the Master Stereo mix.

5. LEVEL CONTROL FADER

These 100-mm faders control the level of the combined signals from all channels that are to be routed to each respective Group buss. The output signal level can be monitored by the Group LED meters.

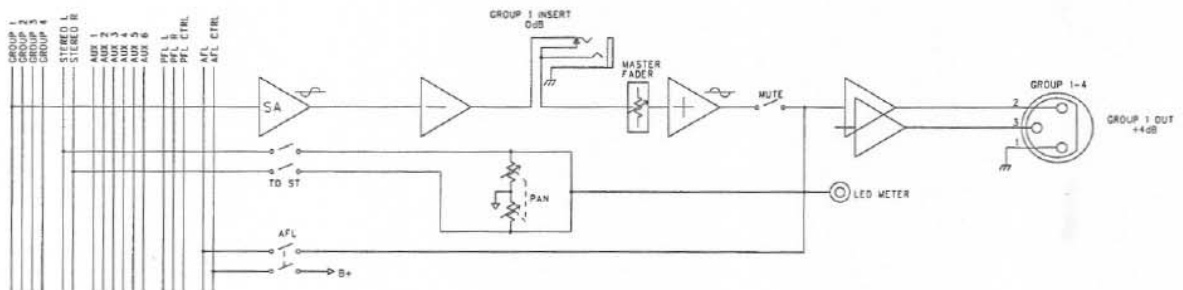

M4 MIXING CONSOLE

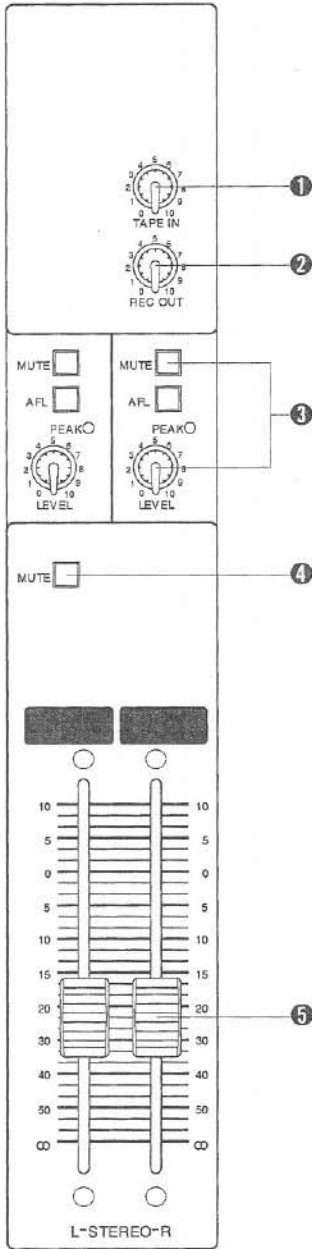

6. MASTER SECTION

1. TAPE IN CONTROL

This control adjusts the level of the tape or CD input signal to the desired level.

2. REC OUT CONTROL

This control adjusts the level of signal sent to a recorder hooked to the REC OUT jacks to its optimum level.

3. AUX SEND SECTION

4. STEREO MASTER MUTE SWITCH

When this switch is engaged, the Master Left/Right outputs will be muted. PLEASE ENSURE THAT THIS SWITCH IS SET CORRECTLY, OTHERWISE THERE WILL BE NO OUTPUT!

5. STEREO MASTER FADERS

These 100-mm faders control the final stereo output from the mixing console. The signal level may be monitored at the LED meters and the headphone circuit will track these outputs unless another signal is selected.

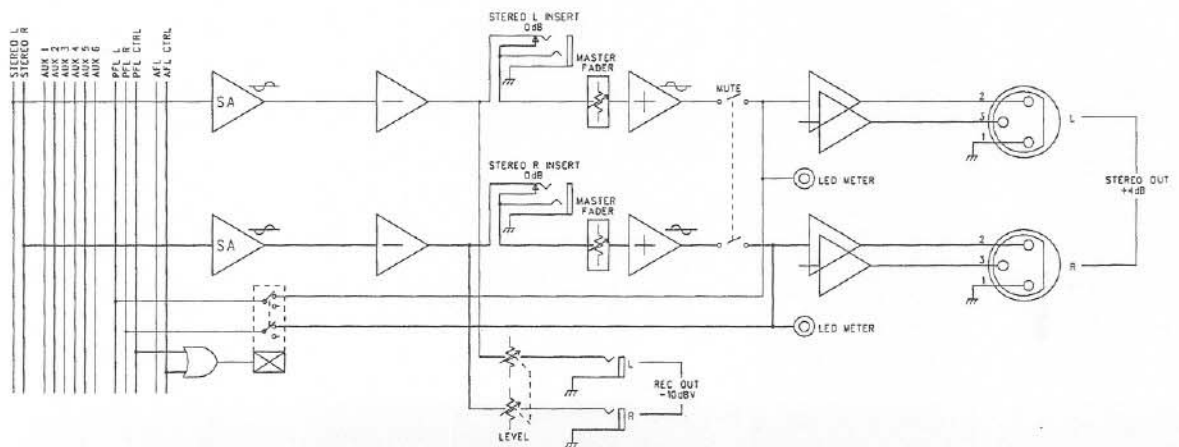
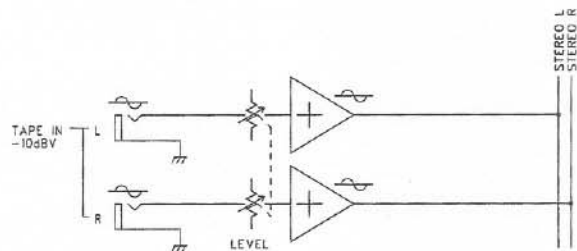

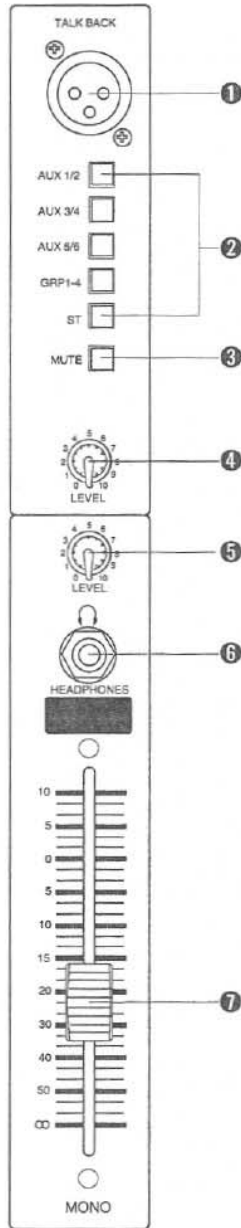

7. TALKBACK/MONO SECTION

1. TALKBACK MICROPHONE INPUT CONNECTOR

This input connector is used to input microphone signals for announcements from the mixer operator. The nominal input signal level is -50 dB and is designed for dynamic microphones. Please note that this input has no phantom power connection and will not operate condenser microphones that require it.

2. ASSIGN SWITCHES (AUX 1 / 2, AUX 3 / 4, AUX 5 / 6, Group 1 - 4, STEREO)

These switches select the buss routing of the talkback microphone's signal. These switches will stay engaged once the buttons are pushed, so it is necessary to disengage them if a different signal routing is required.

3. MUTE SWITCH

Engaging this switch turns off the talkback microphone input so that it can be routed to the desired mix buss.

4. LEVEL CONTROL

This control adjusts the signal level of the talkback microphone.

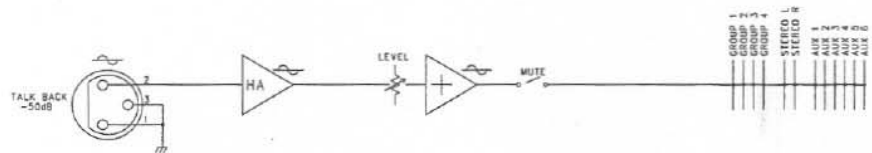

5. HEADPHONE GAIN CONTROL

The headphone gain control adjusts the signal level to the connected headphones. This circuit monitors the left/right stereo outputs unless an AFL/PFL signal is selected.

6. HEADPHONE OUTPUT JACK (1/4" TRS STEREO JACK)

This connector is designed for connection of stereo headphones (Tip = left, ring = right, sleeve = ground). It may also be used for connecting external power amplifiers to this output for monitor speakers.



(1/4" phone 3 section connector)

CAUTION! THIS CONNECTOR MUST BE USED WITH A STEREO (3-wire) HEADPHONE OR STEREO LOAD. USING MONO HEADPHONES OR A MONO CONNECTION WILL CAUSE THIS CIRCUIT TO FAIL.

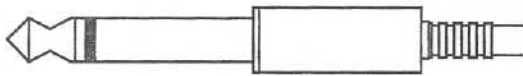

(X)

(1/4" phone 2 section connector)

When a mono connector is plugged into the stereo connector, it connects both sides of the headphone amplifier to a single load. In any professional audio system, accidents can happen and we have built in protection circuits to assure that momentary problems will not cause instant failure. However, this circuit will fail in 2 - 3 minutes if this caution is not observed.

7. MONO FADER

This fader adjusts the output level of the mono out connector.

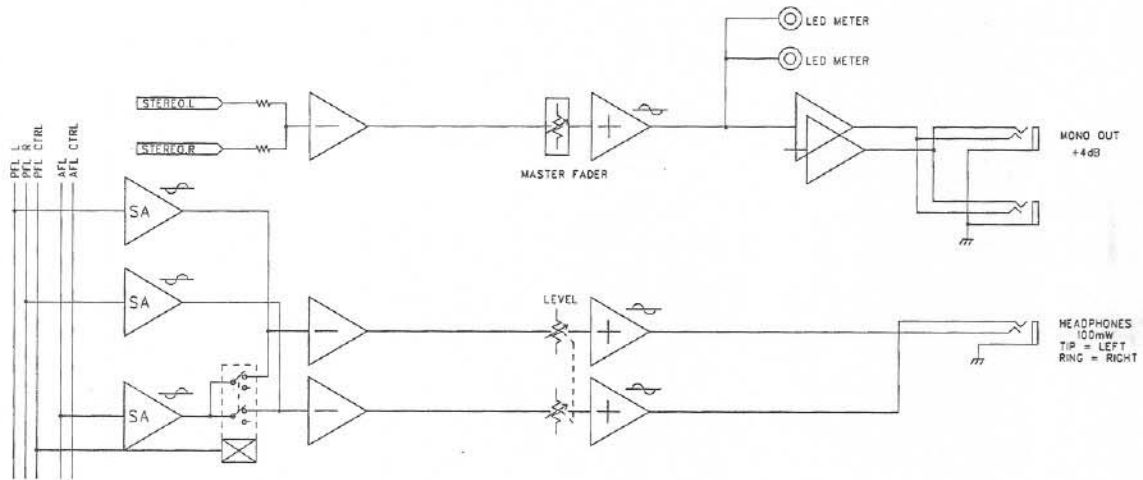

8. LED METER SECTION

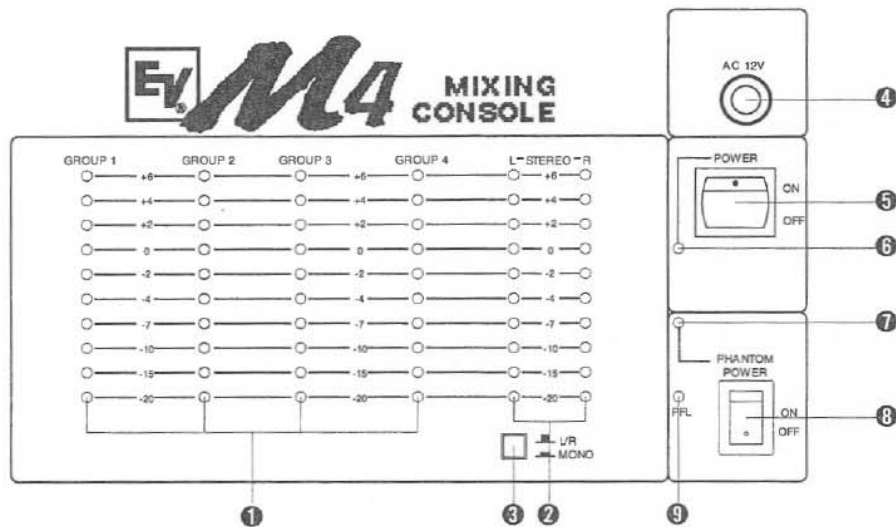

1. GROUP OUTPUT LEVEL INDICATORS

A vertical row of ten LEDs indicates the continuous average output level of each respective Group output. Although this type of meter can display actual signal peaks, these are designed to monitor average signal levels like an analog VU meter. For optimum signal-to-noise ratio, the signal level should be adjusted so that these displays average around 0 VU, with occasional peaks to +3 dB or so.

2. LEFT/RIGHT OR MONO OUTPUT INDICATORS

Two vertical rows of ten LEDs monitor the continuous average output level of the Stereo Left and Right or the mono outputs. As noted above, these meters show the average output level and are easily visible in poor lighting conditions. A 0-dB indication corresponds to an output of 1.23 volts (+4 dBu).

3. METER SELECT SWITCH

This switch selects whether the two meters on the right of the display show the Stereo Left/Right or the Mono levels. If the switch is in the "up" position, the meters monitor the Left and Right outputs. If the switch is depressed, the Mono output level is displayed.

4. LAMP CONNECTOR

A BNC-type socket is provided on the right side of the console's control panel that ac-

commodates Littlelite[®] and other gooseneck lamps to illuminate the panel in dim light. The voltage available for powering the lamp is 12.5 V ac and 0.1 ampere of current.

5. POWER SWITCH

This switch turns the power on and off. To avoid annoying thumps, the M4 should be turned on before the power amplifiers and turned off after the power amplifiers.

6. POWER INDICATOR

This indicator lights when the power switch is turned on and ac current is received.

7. PHANTOM POWER INDICATOR

This indicator illuminates when the phantom power switch is turned on and indicates that it is being supplied to all **XLR-type microphone jacks**.

8. PHANTOM POWER SWITCH

This switch turns the internal phantom power supply on/off. When activated, it supplies 48V-dc power between pins 2 and 3 of the XLR-type microphone jacks. If phantom power isn't needed, this switch should be turned off.

9. PFL INDICATOR

This indicator lights when the PFL switch of one or more channels is turned on.

9. REAR PANEL CONNECTORS

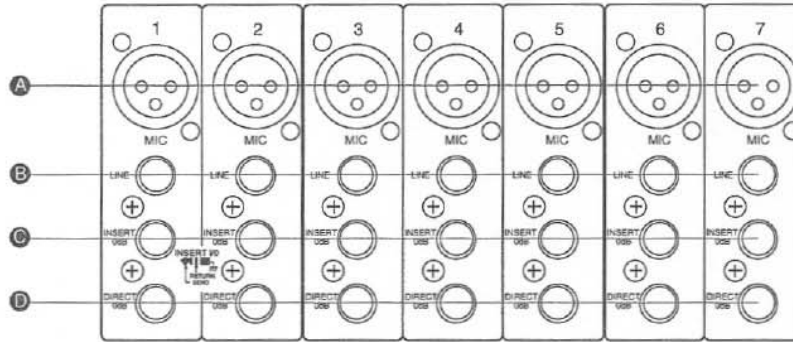

1. INPUT SECTION CONNECTORS

A. BALANCED LOW-IMPEDANCE MIC INPUT CONNECTORS

A 3-pin XLR-type connector is used for balanced low-impedance microphone inputs. These are wired according to IEC Standard #268 (Pin 1 = ground, pin 2 = +, pin 3 = -). Microphones with impedances of 50 – 600 ohms or 600-ohm line-level devices can be connected here. When the phantom power is turned on, 48-volts will be supplied to pins 2 and 3. These microphone inputs are actively balanced which maintains good hum rejection and RF suppression. It is important during operation and/or testing of the mixer that all channel faders re-

main down unless their inputs are properly terminated with a microphone or other 150-ohm source. An open mic input invites the introduction of noise that could degrade sound quality or produce incorrect test measurements.

B. BALANCED LINE INPUT CONNECTORS

1/4-inch input connectors are used for both balanced and unbalanced line level signals such as electronic keyboards, drum machines, sound modules, tape decks, CD players and the line outputs from other mixers. These connectors are wired tip = +, ring = -, sleeve = shield for balanced connections. Maximum input level before clipping is 12V or +24 dB.

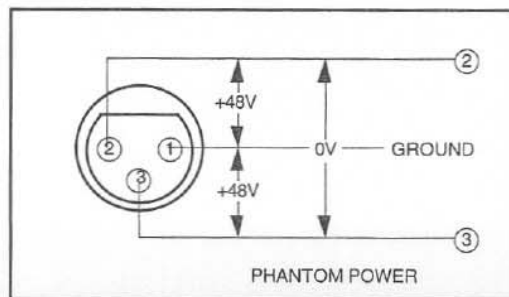
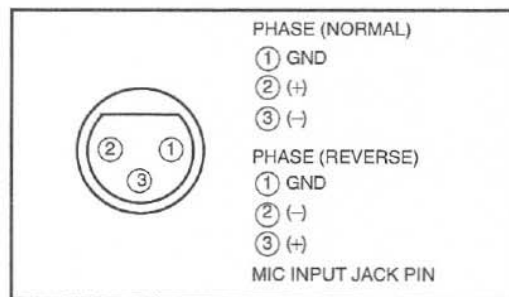

M4 MIXING CONSOLE

C. INPUT CHANNEL INSERTS

There are input/output connections located between the equalizer and the fader on each input channel. The nominal input level and impedance is 0 dB/600 ohms and the nominal output level and impedance is 0 dB/10 Kiloohms. These jacks allow insertion of signal processors or effect units on each input channel.

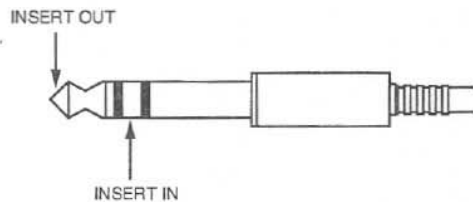

D. DIRECT OUTPUT CONNECTORS

The direct output connectors on each channel sends the post-fader signal to a signal processor or recording device. This connection does not interrupt the signal flow through the channel and uses unbalanced 1/4-inch connectors.

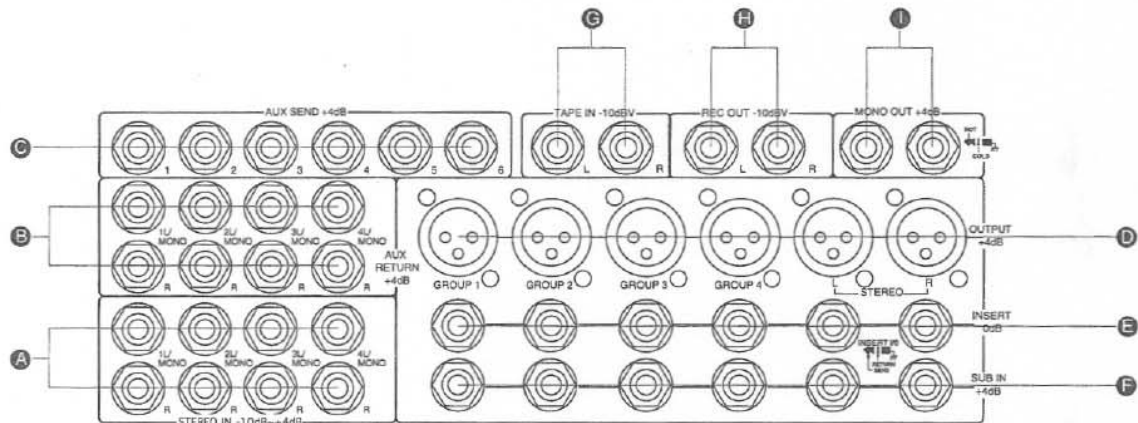

2. MASTER SECTION CONNECTORS

A. STEREO CHANNEL INPUT CONNECTORS

The stereo channel inputs are unbalanced 1/4-inch phone jacks with a nominal input level of -10 dB or +4 dB (depending on the position of the switch on the stereo input PC board) and an impedance of 600 ohms. If a plug is inserted into the L/MONO input, the signal will be sent to both channels.

B. AUX RETURN CONNECTORS (1 - 4)

These are unbalanced 1/4-inch phone jacks designed to receive a stereo signal with a nominal level of +4 dB and impedance of 10,000 ohms. These connectors typically receive the audio signal from an effect processor, but they can also be used as supplementary inputs. If a plug is inserted into

the L/MONO input, the signal will be sent to both channels. If these inputs come from a stereo effects unit, both sides should be connected so the stereo integrity of the signal is maintained.

C. AUX SEND CONNECTORS (1 - 6)

These are unbalanced 1/4-inch phone jacks with a nominal level of +4 dB and impedance of 600 ohms. Each Aux Send is the sum of the signal from all the inputs into that buss.

D. GROUP OUTPUT JACKS AND MAIN STEREO OUTPUTS

These connectors transmit the Group and the Main L/R outputs to the power amps and/or the processing gear. These XLR-type outputs have a rated level of +4 dB and impedance of 600 ohms.

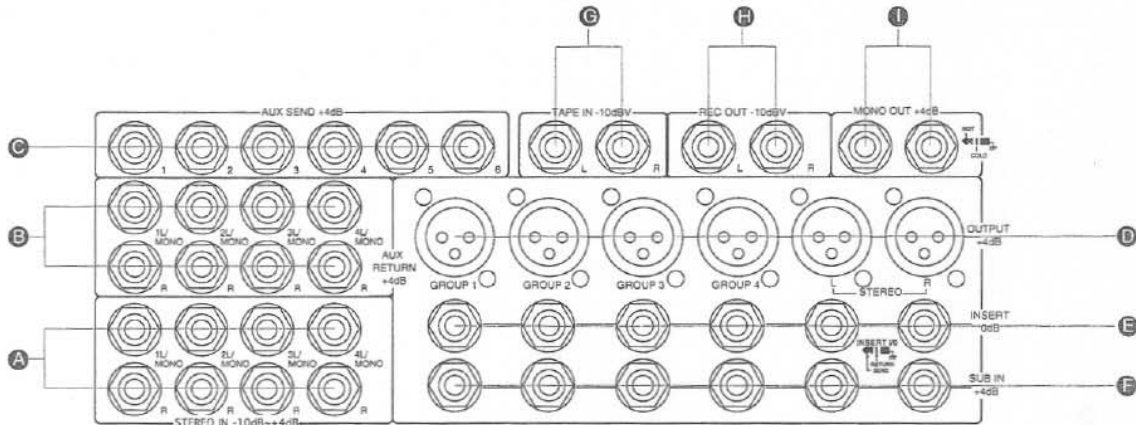
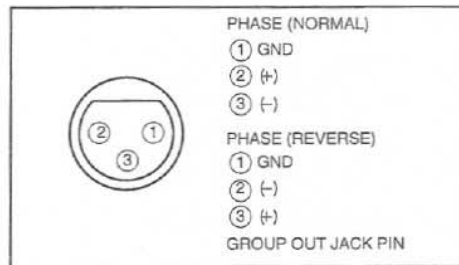

E. GROUP AND MAIN OUTPUT INSERT CONNECTORS

These ¼-inch TRS connectors provide an unbalanced insert before the Group and the Master faders. The insert input accepts a 0-dB signal with 600-ohm impedance and the output delivers a 0-dB signal capable of driving 10,000-ohm impedance. These insert connectors are a convenient way of patching in a signal processor such as a compressor/limiter on an entire group of instruments or a mix.

F. GROUP AND MAIN STEREO SUB INPUTS

These unbalanced ¼-inch connectors have a nominal level of +4 dB and impedance of 600 ohms. They can be used to patch in a signal from a sub-mixer or other effects processor.

G. TAPE INPUT JACKS

These are unbalanced ¼-inch connectors with a nominal level of -10 dBV and impedance of 600 ohms. Any line level source, including DAT machines, CD players, keyboards and computers can be connected to these inputs.

H. RECORD OUTPUT JACKS

These unbalanced ¼-inch connectors are designed to handle nominal inputs of -10 dBV and 10,000 ohms. Any cassette deck or DAT can be connected here to record the pre-fader audio signals from the Stereo Masters.

I. MONO OUTPUT JACKS

These are balanced ¼-inch phone jacks with a nominal output of +4 dB and impedance of 600 ohms. The following signals can be monitored: The MONO OUT can be used for simple recordings of a live performance, for driving a sub power amp, or to check for phase cancellation. An internal jumper can be reconnected to change the location of the MONO OUT to post-ST fader. If this is done, the MONO OUT signal will be affected by the STEREO ON switch. Internal jumper wires can be changed to move the MONO OUT signal so that it is taken after the ST fader. If you would like this change to be made, consult with your dealer.

GENERAL WIRING PROCEDURES

To take full advantage of the excellent signal-to-noise ratio of the M4, care must be taken to ensure that electrical interference and wiring problems don't degrade its performance. Hums, buzzes and radio frequency interference can usually be traced to ground loops, ac problems and various wiring difficulties.

To ensure successful, noise-free use, some forethought and ground rules must be established and adhered to during installation and use.

1. For optimum performance, it is essential that the electrical ground be clean and noise-free since all signals are referenced to it. In portable situations, it may be difficult to always control the quality of the ground and the ac system, but having a good ground is absolutely necessary.
2. Install/use separate electrical circuits for the audio system and others for the lighting and other things such as vending machines, computers, air conditioning etc. Never mix the systems.
3. If necessary, consider an isolation transformer to prevent interference from electrical sources. A good transformer will include a Faraday shield, which must be separately grounded.
4. Never locate the audio system in close proximity with a building's incoming ac distribution box.
5. Ensure that all rack-mounted equipment is connected to a good ground since it can transmit noise via interconnect cables. Equipment that has unbalanced inputs and outputs may need to be isolated from the rack to prevent ground loops.
6. The use of ground lift switches and ac ground lifts/adapters are essential in eliminating ground problems encountered in portable use.

AUDIO WIRING

The use of low impedance sources, such as good quality professional microphones or the outputs of most modern audio equipment can significantly improve noise immunity. Avoid high impedance microphones and equipment with unbalanced outputs which can pick up interference over long cable runs, even with well-made cables,

After ensuring that all connected pieces of equipment are receiving good power and ground connections, you can proceed with hookup in a logical sequence that helps avoid problems and pin-points sources of trouble.

1. Connect the monitor speakers and amplifier (or use good quality headphones) and check

for any hum, buzzes or radio frequency interference within the console. If you are satisfied with the results of this test, then proceed.

2. Connect any tape decks or other unbalanced sources and make sure that the system is still clean and noise free.
3. Connect all other peripheral devices (including their aux sends) one at a time and check for performance problems after each one is hooked up.
4. Connect all microphone inputs one at a time and check for performance problems after each one.

Although this process may seem slow and cumbersome, you will save time if you have a problem instead of having to go back and find it. A quiet, stable system will ensure the best possible performance.

RADIO-FREQUENCY INTERFERENCE

Radio-frequency interference problems (RFI) can be some of the most difficult problems to solve in sound system troubleshooting. In areas with high amounts of RFI, additional steps may be required to minimize these problems.

One of the most effective techniques is to connect a 0.01-microfarad capacitor between the cable shield and the ground pin on the connector. This will present a short circuit at radio frequencies and lowers the effective shield impedance to ground.

Placement of cables can also affect pickup of RFI and experimentation with this aspect of hookup can help minimize problems too. Ensuring that all cables have good connections and that the shield is only hooked on one end is another good step towards improving immunity to RFI.

All equipment hooked to an ac power source are potential carriers for many forms of RFI generated by electric motors, air conditioning units, light dimmers, etc. Good electrical grounds and the use of ground lifts and adapters can help minimize many of these problems.

As with other noise problems, identifying the source of a RFI problem can help lead to a solution.

M4 MIXING CONSOLE

SPECIFICATIONS

Total harmonic distortion	<0.1% at +14 dB, 20 – 20 kHz
Frequency response	20 – 20 kHz, +1 dB, - 2 dB
Maximum output level	+24 dB (Main stereo outputs @ 600 ohms) +24 dB (Groups 1 – 4 @ 600 ohms) +24 dB (Mono output @ 600 ohms) +20 dB (Aux send 1 – 6 at 600 ohms)
Hum and noise(Typical)	-127 dB equivalent input noise -95 dB residual noise at Stereo masters and subgroups -95 dB residual noise at Aux sends and mono output -88 dB master fader at nominal level, channels off -64 dB master fader and channels at nominal level
Maximum voltage gain	84 dB Mic input to Stereo Master, Group outputs 1 – 4 76 dB Mic input to Aux sends 1 – 2 86 dB Mic Input to Aux sends 3 – 6 44 dB Line input to Stereo Master, Group outputs 1 – 4 34 dB Stereo input to Stereo Master, Group outputs 1 – 4 16 dB Aux return to Stereo Master, Group outputs 1 – 4 28 dB Tape input to Stereo Master 10 dB Stereo inserts to Stereo Master 10 dB Group inserts to Group outputs 70 dB Talkback microphone to Stereo Master
Crosstalk at 1 kHz	>-70 dB between input channels >-70 dB between output channels
Gain control at input channels	44 dB variable (-60 dB - -16 dB)
Input channel equalization	+15 dB Maximum boost or cut High: 12 kHz shelving Mid: 250 Hz – 5 kHz (variable) peaking Low: 80 Hz shelving
LED meters	10-segment LED meters x 2 for Left/Right or Mono 10-segment LED meters x 4 for Groups 1 – 4
Phantom power	+48V dc
Power Consumption	120 V/ 60 Hz 16-channel: 51 watts 24-channel: 69 watts 230 V/ 50 Hz: 16-channel: 51 watts 24-channel: 69 watts
Dimensions (H x W x D)	16-channel: 128 x 796 x 623 mm (5.04 x 31.3 x 24.5 in) 24-channel: 128 x 1020 x 623 mm (5.04 x 40.1 x 24.5 in)
Weight	16-channel: 21 kg / 46.2 lb. 24-channel: 26 kg / 57.2 lb.

M4 MIXING CONSOLE

BLOCK AND LEVEL DIAGRAM

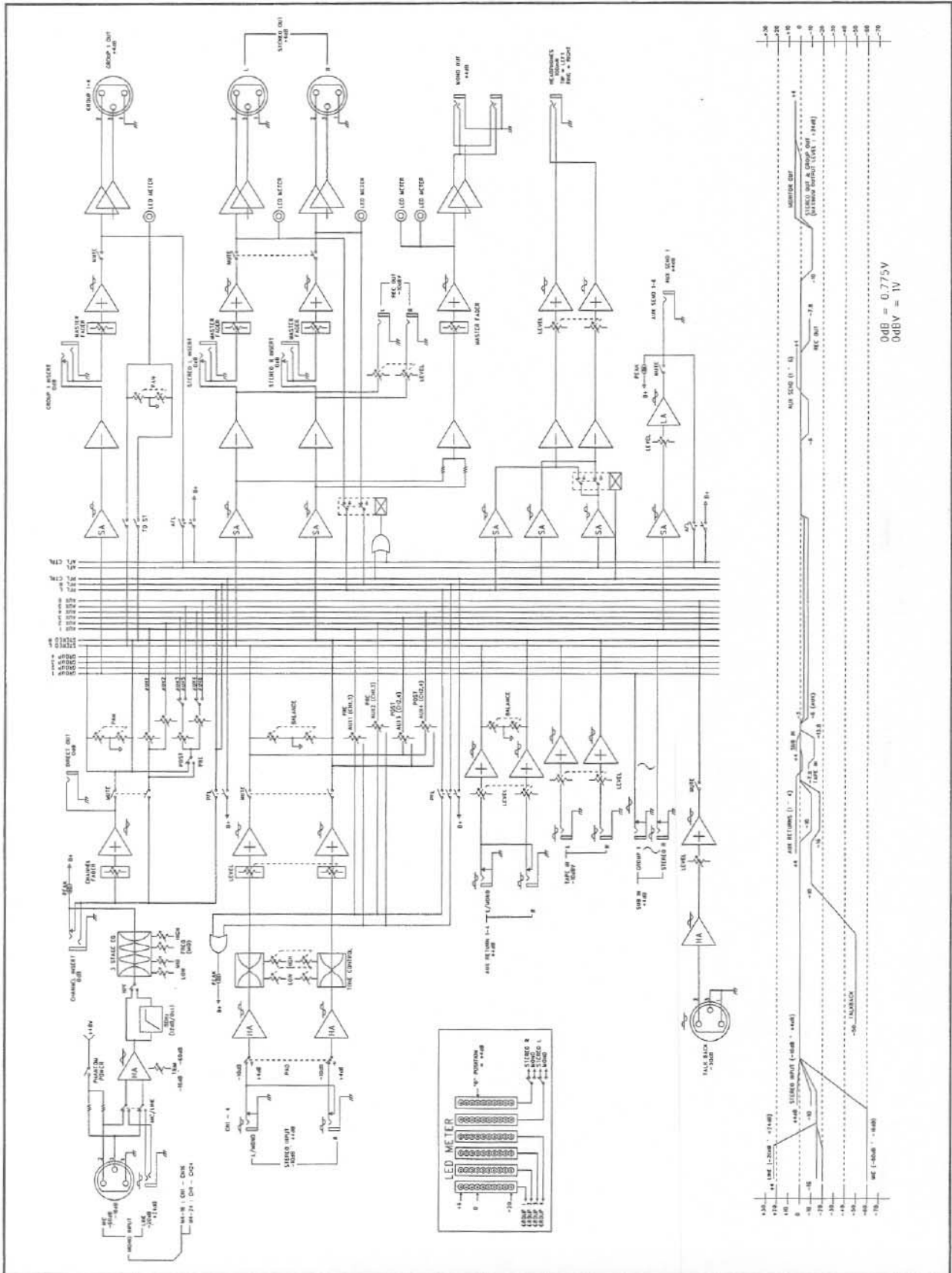

M4 MIXING CONSOLE

SCHEMATIC DIAGRAM

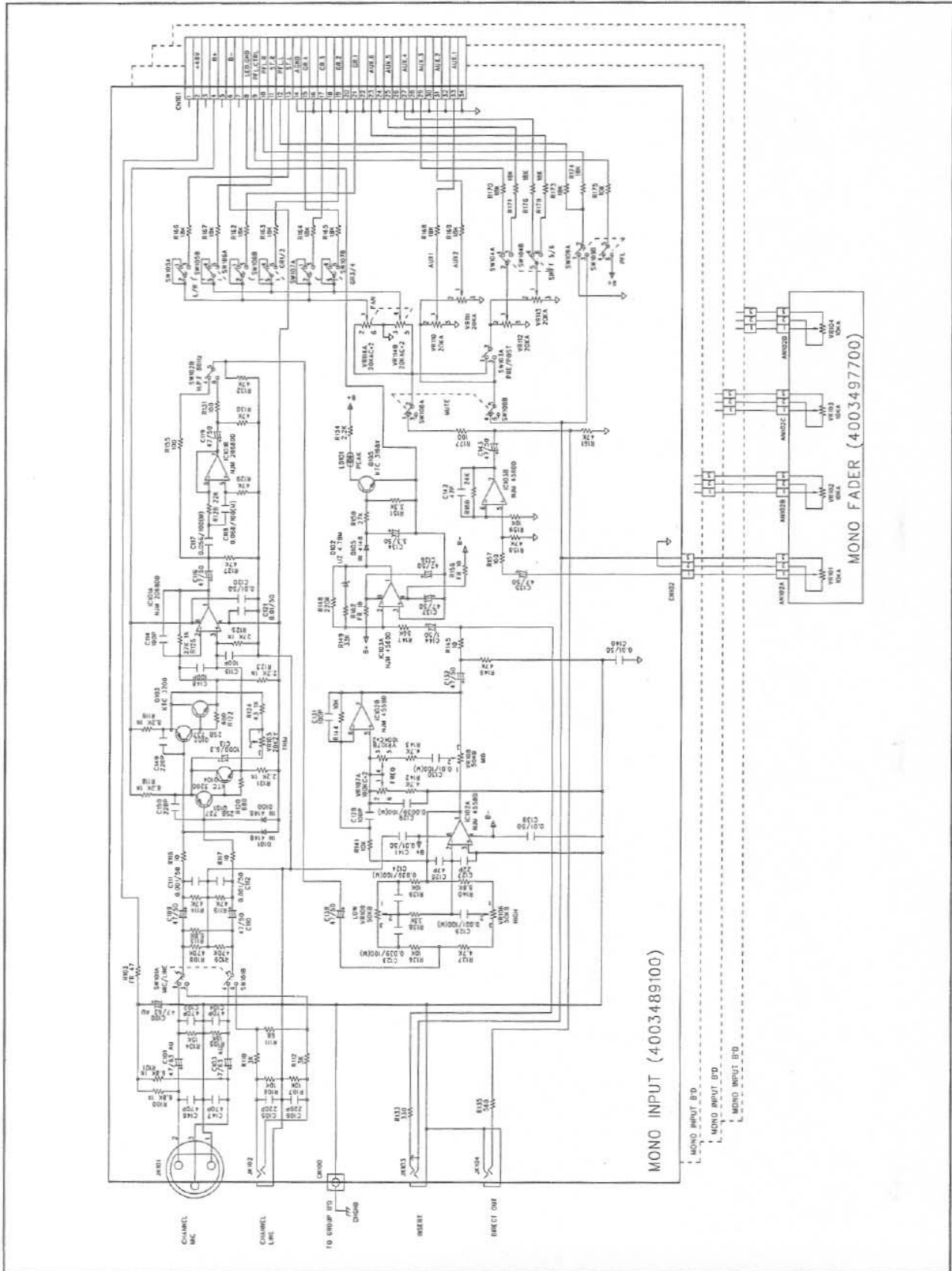

M4 MIXING CONSOLE

SCHEMATIC DIAGRAM

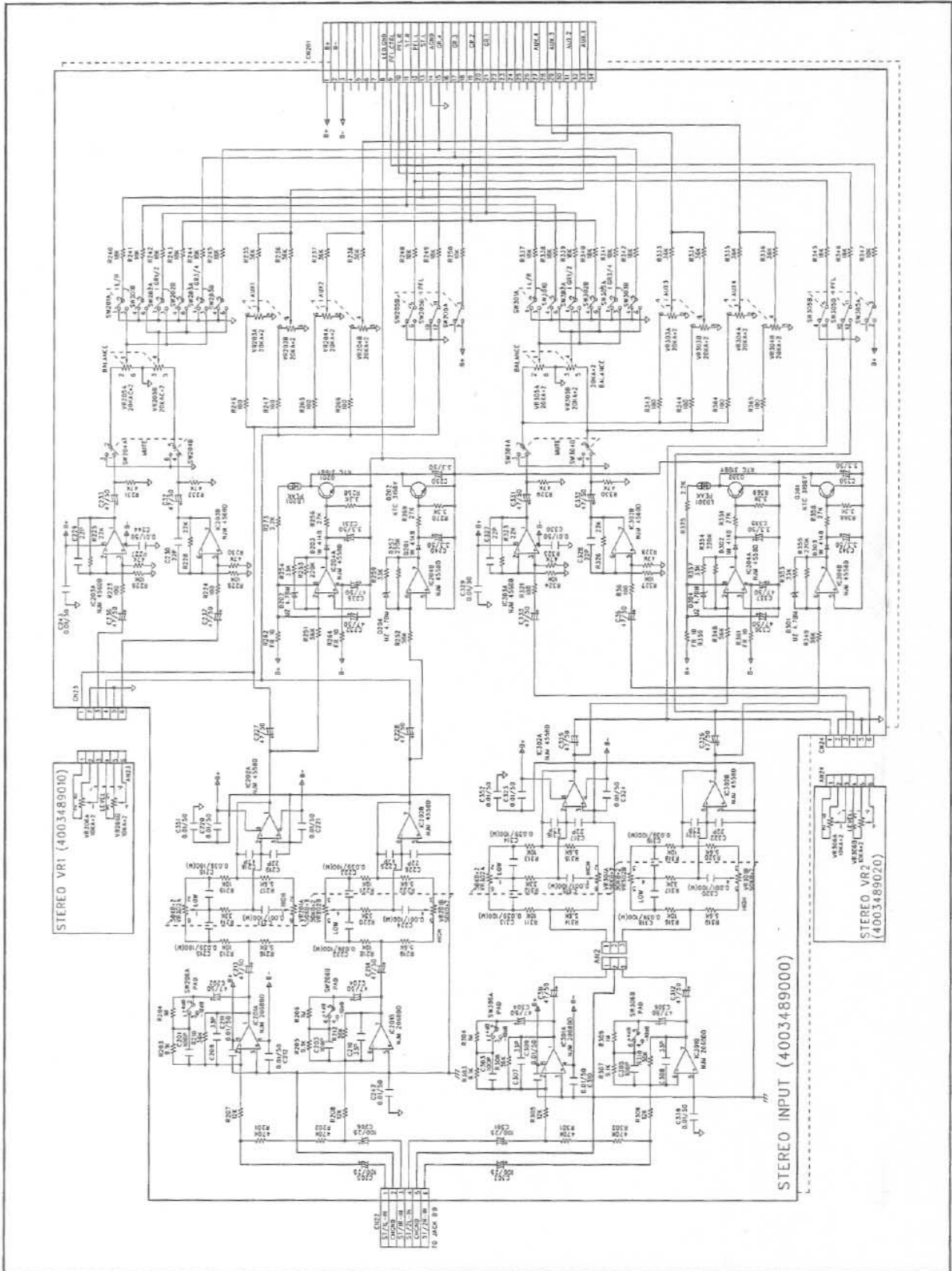

M4 MIXING CONSOLE

SCHEMATIC DIAGRAM

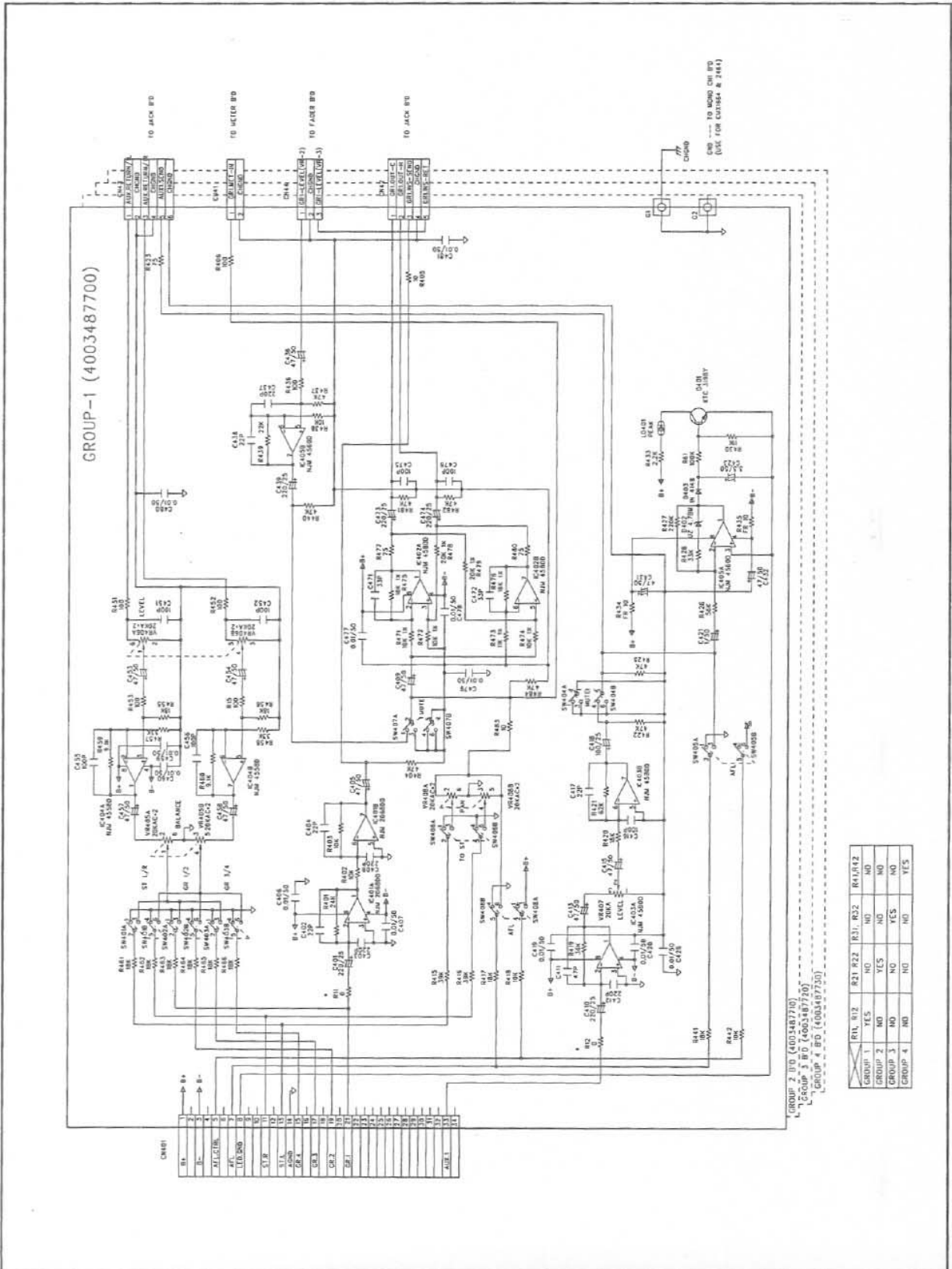

M4 MIXING CONSOLE

SCHEMATIC DIAGRAM

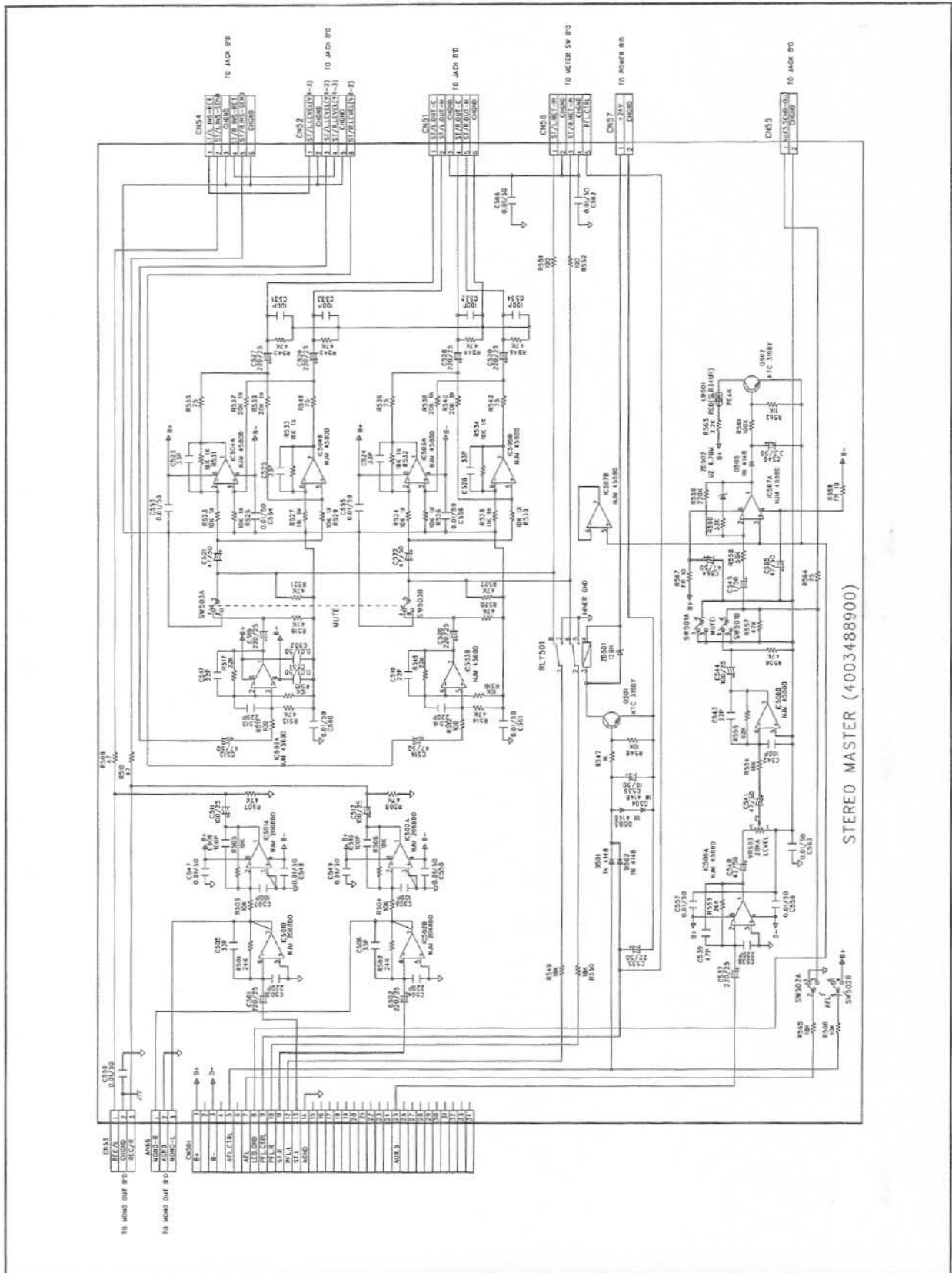

STEREO MASTER (4003488900)

M4 MIXING CONSOLE

SCHEMATIC DIAGRAM

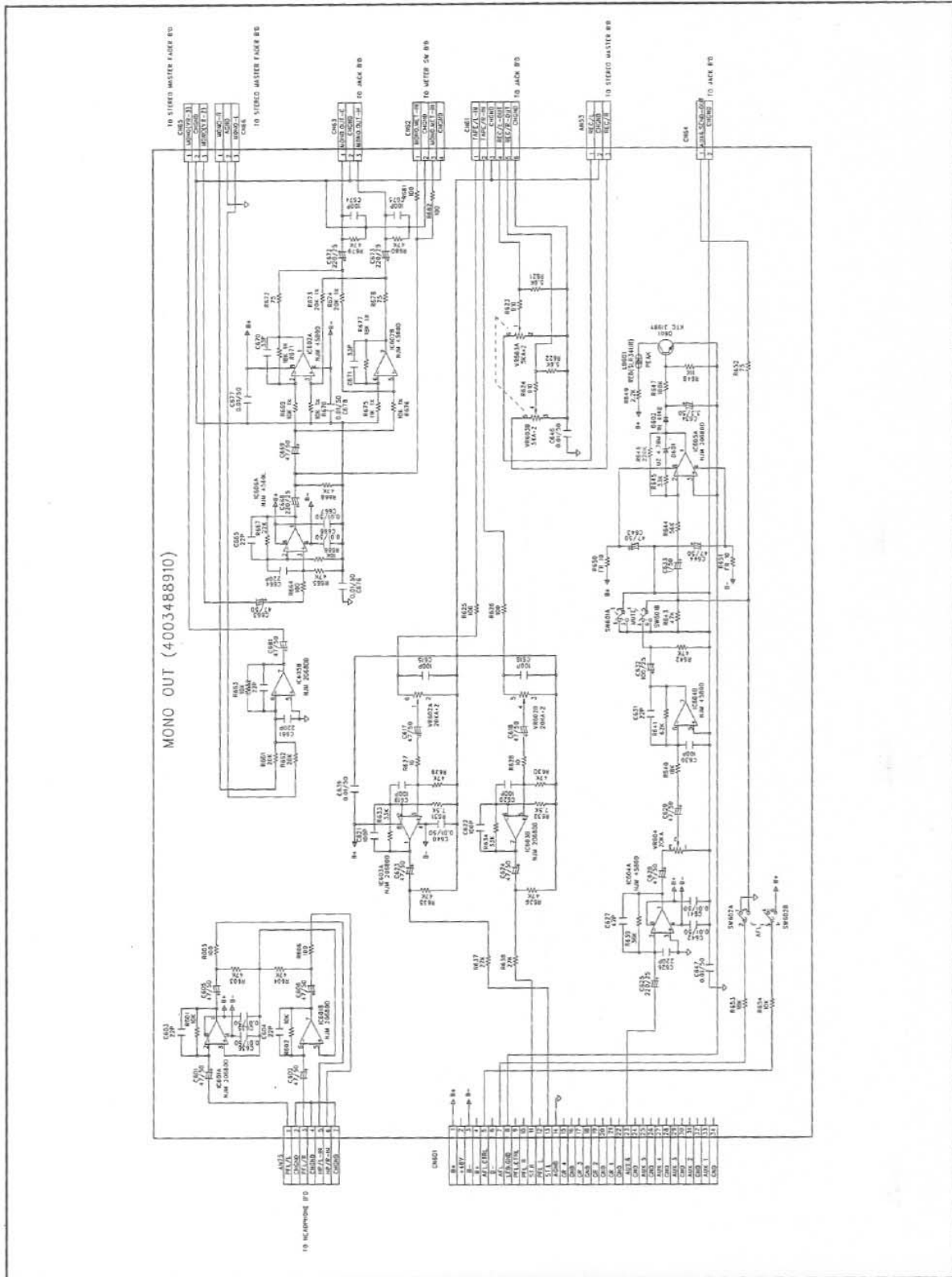

M4 MIXING CONSOLE

SCHEMATIC DIAGRAM

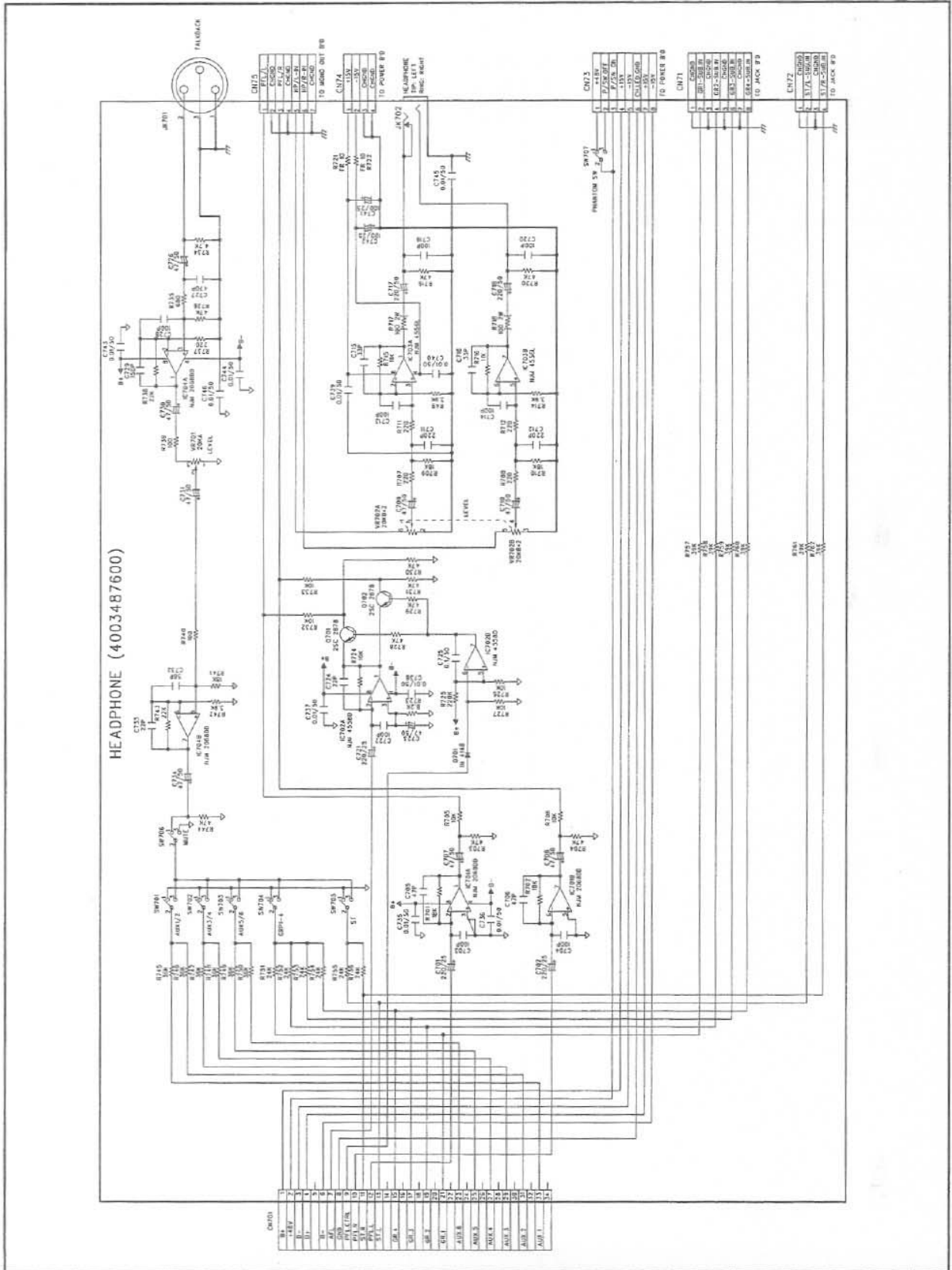

M4 MIXING CONSOLE

SCHEMATIC DIAGRAM

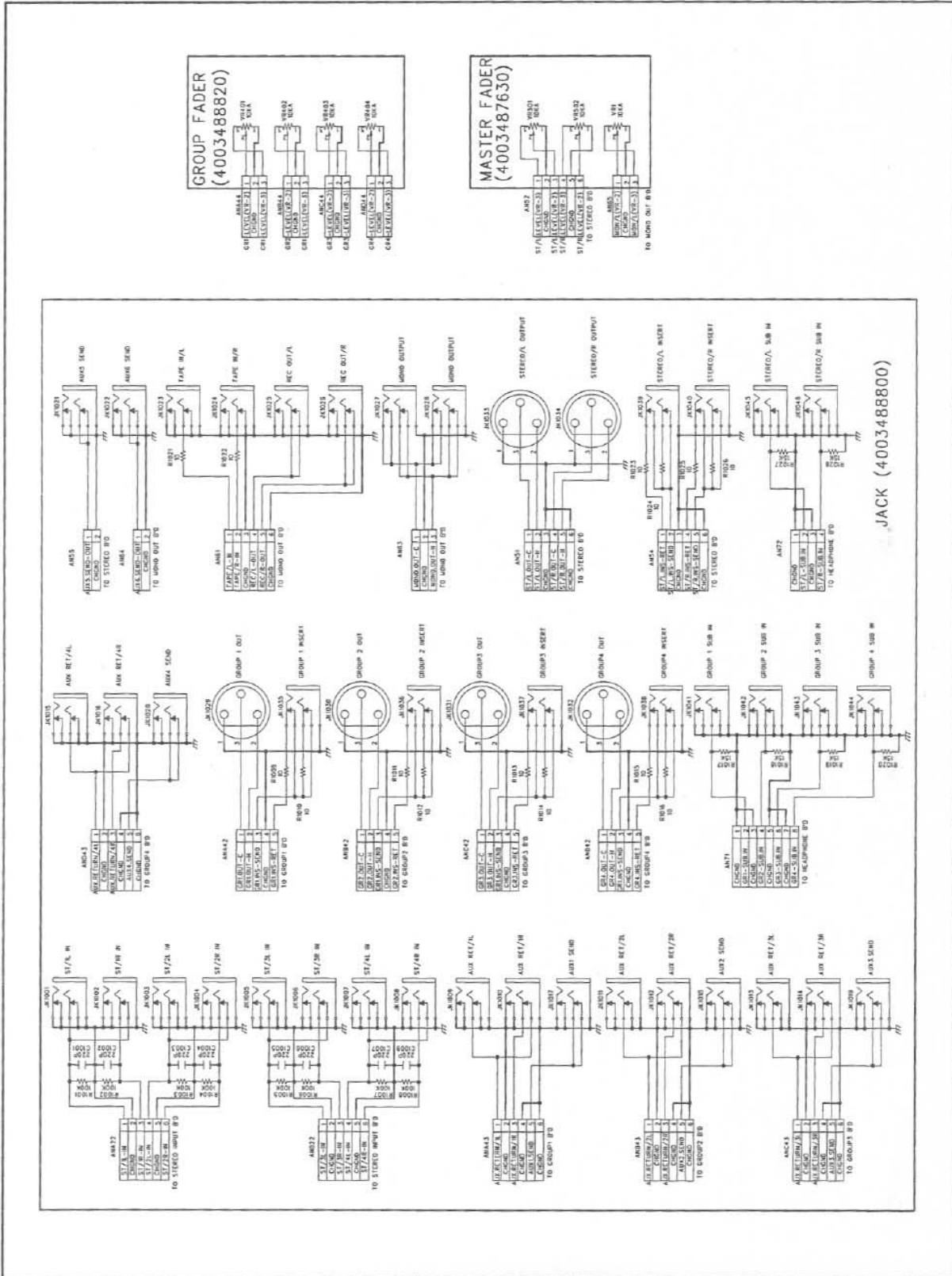

M4 MIXING CONSOLE

SCHEMATIC DIAGRAM

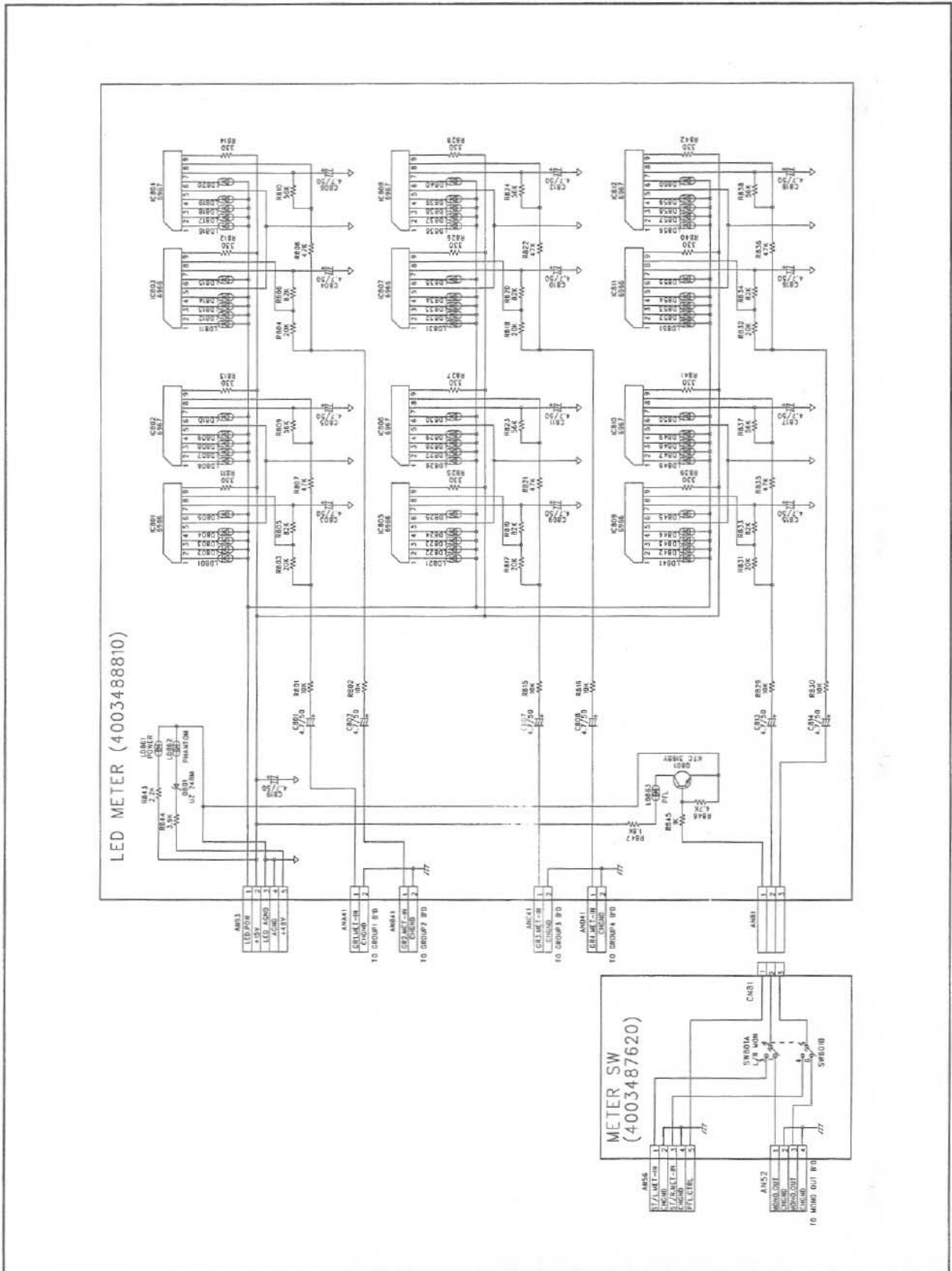

M4 MIXING CONSOLE

SCHEMATIC DIAGRAM

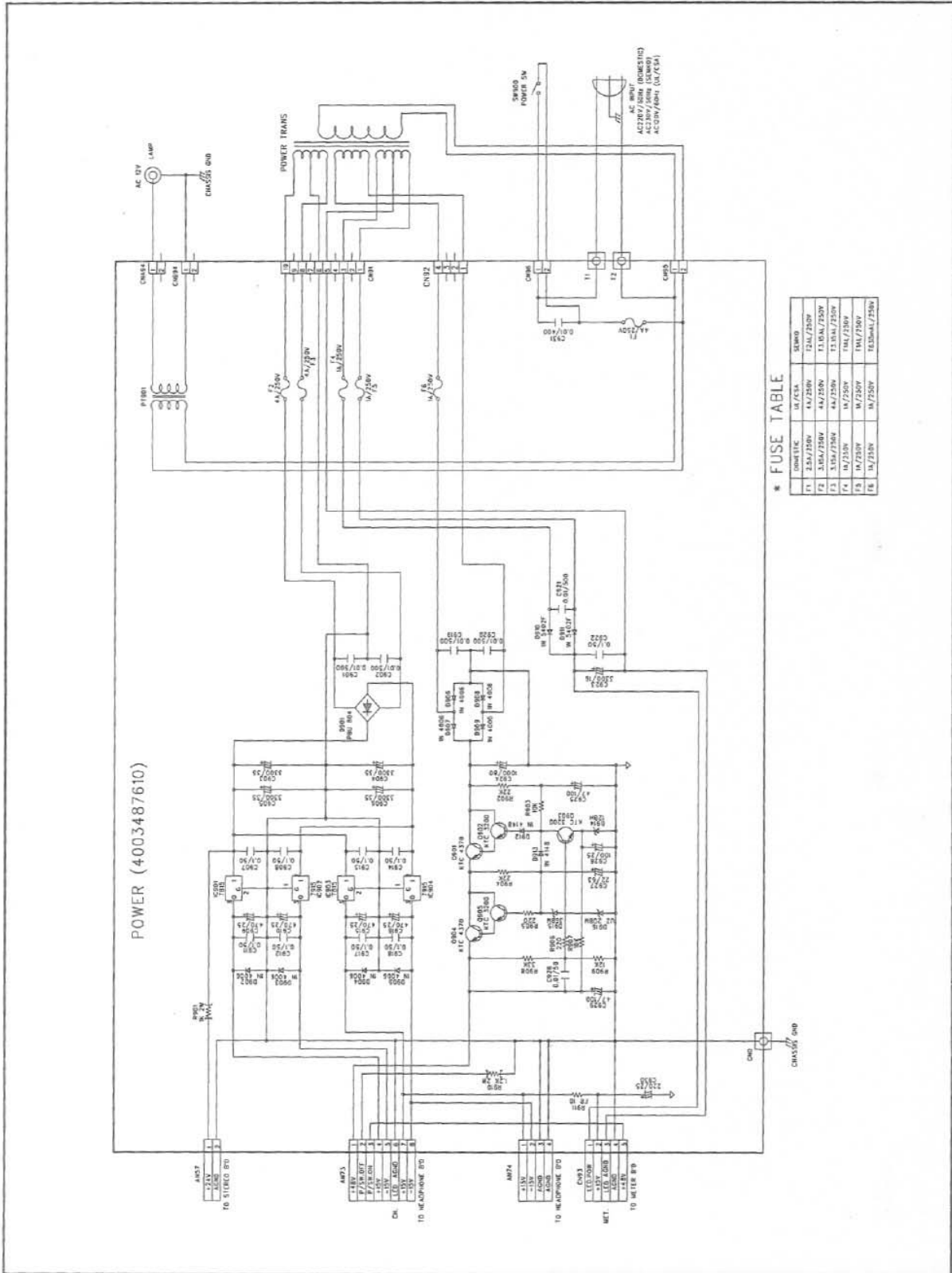

SCHEMATIC DIAGRAM



* BUS LINE ASSIGNMENT (MASS CONNECTOR)

33	AUX 1	29	AUX 3	27	AUX 4	25	AUX 5	23	AUX 6	21	GR 1	19	GR 2	17	GR 3	15	GR 4	13	ST L	11	ST R	9	PFL CTRL	7	AFL CTRL	5	B-	3	B+	1
34	GND	30	GND	28	GND	26	GND	24	GND	22	GND	20	GND	18	GND	16	GND	14	GND	12	PFL L	10	PFL R	8	LED GND	6	B-	4	B+	2
	GND	GND	GND	GND	GND	GND	GND	GND	GND	GND	GND	GND	GND	GND	GND	GND	GND	GND	GND	GND	GND	GND	GND	GND	GND	GND	GND	GND	GND	+48V

CF) PIN 1,3 FOR STEREO INPUT & MASTER
PIN 4,6 FOR MONO INPUT