

# MusicParts.Com

## Technical Document Distribution

---

<b>Brand:</b>	<b>Ensoniq</b>
<b>Model</b>	<b>DP/4</b>
<b>Product:</b>	<b>Parallel Effects Processor</b>
<b>Description:</b>	<b>Diagnostics And Troubleshooting Guide</b>

---

Musicparts Document Number: 51635      TechTips: No      Pages: 32      Dated: 1993

Hello,

Welcome to MusicParts.Com, Inc. your online resource for technical documents and service information. This PDF package may contain information, schematics, parts lists, images, engineering changes, previous versions, circuit descriptions, and many other unique features about the product you have chosen. This document was assembled from a variety of sources and is the result of our many years in the music repair business.

NOTE: Large original over-sized drawings will need to be taped together. We feel this is better than reducing them and losing the fine details.

VIEWING: This document is utilizing PAGE-ON-DEMAND downloading. This will let you navigate to any page without waiting for the entire file to download. Just click ON the thumbnails.

### **PRINTING: Very Important!**

When the print dialog appears, please make sure "**REDUCE TO PAPER SIZE**" OR "**SHRINK OVERSIZED PAGES**" is checked, otherwise you may cut off the edge of the page. This will compensate for your printer's margins and produce a great looking printout. Also please stay online while printing this document to make sure you get all the pages.

Visit us on the web at: <http://www.musicparts.com/>  
Email us at: [customerservice@musicparts.com](mailto:customerservice@musicparts.com)

# Service Manual

---

MusicParts.Com

## DP/4

Parallel Effects Processor

P/N 9312001601 - A  
June 1993



THE TECHNOLOGY THAT PERFORMS

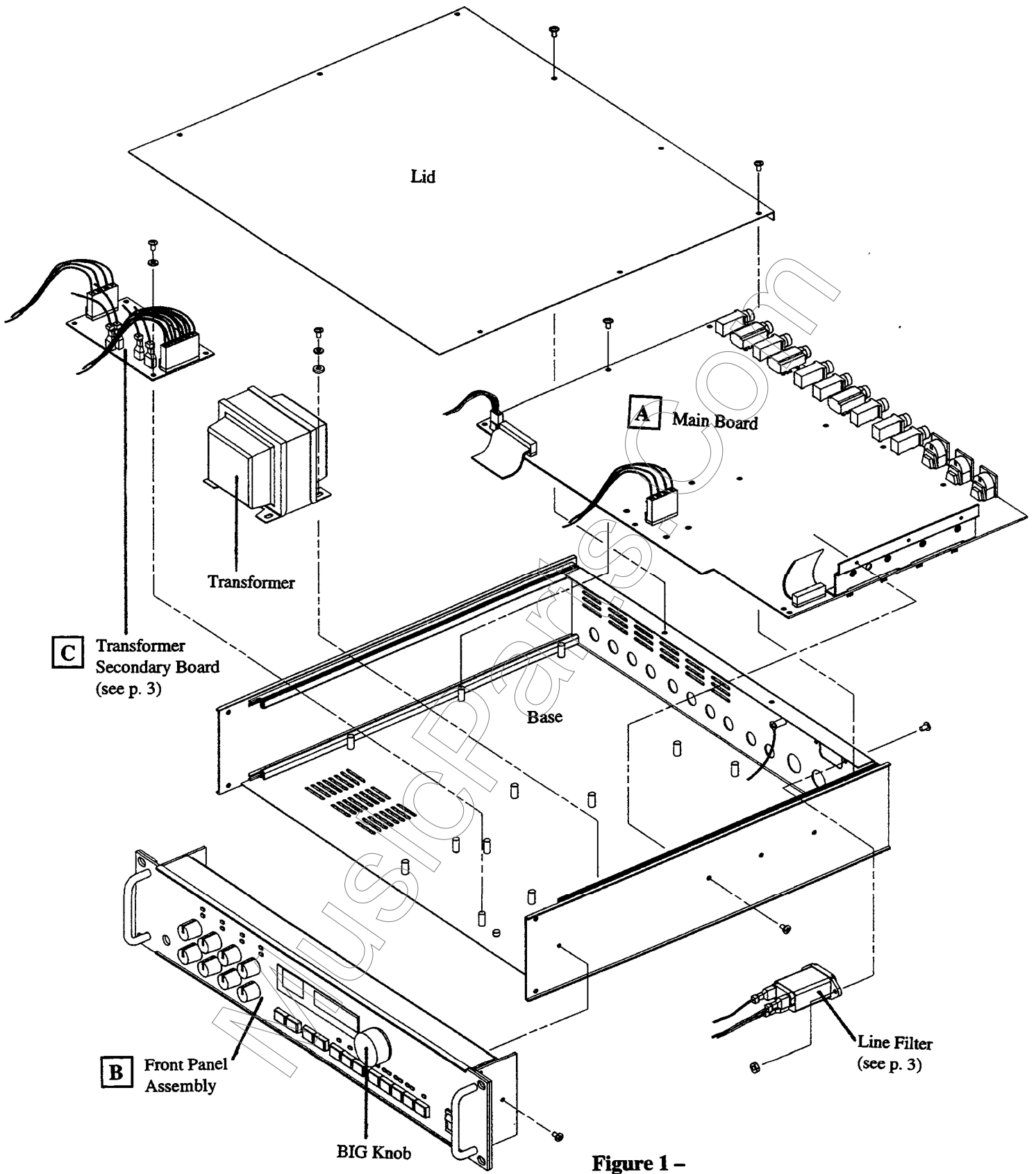

**Figure 1 -**  
**DP/4 Exploded View**

**TABLE OF CONTENTS**

	<b>Page</b>
Figure 1 — DP/4 Exploded View . . . . .	inside cover
<b>Important Things to Know About the DP/4:</b>	
Reinitialization . . . . .	1
System Reset Sequence and Hard Reset . . . . .	1
DP/4 Case . . . . .	2
Noise When Using The DP/4 . . . . .	2
Figure 2 — Mono cables and Tip, Ring, Sleeve (TRS) cables . . . . .	2
Cables . . . . .	2
DON'T GET SHOCKED! . . . . .	3
<b>Power Supply</b>	
Checking the Power Supply Circuitry . . . . .	3
DP/4 Transformer and Transformer Secondary Boards . . . . .	3
Figure 3 — DP/4 Transformer Secondary Boards . . . . .	3
Figure 4 — AC Power Connections . . . . .	3
Power Supply Voltage Chart . . . . .	4
Figure 5 — DP/4 Main Board Test Points . . . . .	4
Figure 6 — Testing a Transformer Secondary Board Unloaded . . . . .	5
<b>Display</b>	
Display Self-Test Mode . . . . .	6
Figure 7 — DP/4 with No Display or Display is in Self-Test . . . . .	6
<b>Unexpected Event Messages</b> . . . . . 7	
<b>Low Battery Message</b> . . . . . 8	
Figure 8 — DP/4 with a Low Battery Message when you turn it on . . . . .	8
<b>Audio Problems</b>	
Figure 9 — DP/4 with an Audio Problem . . . . .	9
Checking Audio Signals between Main and Keypad/Display Boards . . . . .	10
<b>Test Procedure</b>	
1. Setup . . . . .	11
2. Turn on the DP/4 and Reinitialize . . . . .	11
3. Display/Keypad Test . . . . .	11
4. Analog Page . . . . .	12
5. Mute Test, Battery Backup Test . . . . .	12
Figure 10 — DP/4 System Block Diagram . . . . .	12
<b>DP/4 Burn-in Test Procedure</b> . . . . .	13
<b>DP/4 Software Notes</b> (version 1.06 thru 1.14) . . . . .	15
To Check the DP/4 Software Version . . . . .	15

**Replacing DP/4 Modules**

Section A — Replacing the DP/4 Main Board . . . . .	16
Figure 11 — Main Board Mounting Screw Locations . . . . .	16
Figure 12 — Looking Down into the DP/4 . . . . .	16
Section B — Replacing the Front Panel Assembly . . . . .	17
Figure 13 — Removing the Front Panel Assembly . . . . .	17
Section C — Replacing the Transformer Secondary Board . . . . .	18
Section D — Replacing the O.S. EPROMs . . . . .	19

**Saving DP/4 Data – MIDI System Exclusive Storage**

Sending DP/4 Data Out via MIDI System Exclusive Dump . . . . .	20
Receiving MIDI System Exclusive Dumps with the DP/4 . . . . .	21

Battery Cautions . . . . .	22
Glossary . . . . .	22
ENSONIQ Part Numbers for DP/4 Parts . . . . .	22

**List of Drawings**

Figure 1 — DP/4 Exploded View . . . . .	inside cover
Figure 2 — Mono cables and Tip, Ring, Sleeve (TRS) cables . . . . .	2
Figure 3 — DP/4 Transformer Secondary Boards . . . . .	3
Figure 4 — AC Power Connections . . . . .	3
Figure 5 — DP/4 Main Board Test Points . . . . .	4
Figure 6 — Testing a Transformer Secondary Board Unloaded . . . . .	5
Figure 7 — DP/4 with No Display or Display is in Self-Test . . . . .	6
Figure 8 — DP/4 with a Low Battery Message when you turn it on . . . . .	8
Figure 9 — DP/4 with an Audio Problem . . . . .	9
Figure 10 — DP/4 System Block Diagram . . . . .	12
Figure 11 — Main Board Mounting Screw Locations . . . . .	16
Figure 12 — Looking Down into the DP/4 . . . . .	16
Figure 13 — Removing the Front Panel Assembly . . . . .	17

---

## IMPORTANT THINGS TO KNOW ABOUT THE DP/4

As with every ENSONIQ product, all DP/4 product service will be handled through the ENSONIQ Module Exchange Program. Rather than diagnose and exchange individual components, you will replace complete modules. We feel that this is the most time and cost effective method of repair, both for you and your customers. **If you don't read any other part of this manual, read this section.**

### 1. REINITIALIZATION

The DP/4 is essentially a computer with 32K of RAM. It is possible for the DP/4 to become confused if bad data is loaded into this memory. This can result from a bad MIDI Sys-Ex transfer, or a power glitch. If the memory does get scrambled, it will be necessary to reinitialize the system. Scrambled software can cause problems that at first glance appear to be hardware-related, reinitialization is recommended as a first step in troubleshooting.

When reinitializing a DP/4, all the current data will be lost. However, the 80 ROM presets are automatically loaded back into the internal memory after reinitializing. **It is highly recommended that the internal memory be saved by the customer before servicing.** See p. 20 for instructions on saving data.

**IMPORTANT! Unplug all audio cables before reinitializing. The audio outputs of the DP/4 may make a pop when reinitializing.**

### TO REINITIALIZE THE DP/4 FROM THE FRONT PANEL

- Save all Preset data (see p. 20).
- While holding down **System/MIDI**, press the **B** button.
- **Press the right arrow button once.**
- The display should read, "Hit <WRITE> To Reinitialize!!!!" Press **Write** to reinitialize (or **Cancel** to exit). The DP/4 erases its internal memory and then starts up just as it does when you turn the power on, and reinitialization is complete. ROM presets are automatically placed in the internal memory after reinitialization.

If the system is so scrambled that the front panel isn't working, try the following reset sequence:

### SYSTEM RESET SEQUENCE

- Turn the unit off and then on slowly (at 2 second intervals) seven times.
- The eighth time you turn it on, the unit will automatically reinitialize itself and should show the wake-up screen. If it doesn't then there is another problem.

If the unit is open, you can try the following Hard Reset:

### HARD RESET

- **Make sure the power is off and the power cable is unplugged!**
- Short the negative (or minus) side of the battery (corner of the main board) to pin 28 of U58 for a few seconds (see Figure 5 for location).

If the above methods do not return the system to normal operation then there is a problem in one of the modules.

## 2. DP/4 CASE (Avoid Stripping Screws)

Care should be exercised when assembling or disassembling any part of the DP/4. **Avoid over-tightening screws when executing any repair procedure! Use no more than 8 inch/lbs of torque when tightening any screw.**

The case of the DP/4 is made from aluminum extrusions and steel. Various parts are held in place by screws that tighten into aluminum mounting rails that are part of the case. When replacing any of these screws, it is possible to over-tighten the screws and strip out a hole.

## 3. NOISE WHEN USING THE DP/4

The DP/4 has unbalanced outputs that are designed to be used with 1/4" Mono shielded audio cables only. Mono shielded audio cables are cables that have one or more wires connected to the tip of the plug that carries audio signal information, surrounded by a braided wire connected to the sleeve of the plug (ground) that acts as a shield against interference. If the DP/4 outputs are going to be plugged into balanced inputs, use 1/4" Mono shielded audio cables only. If for some reason three conductor tip, ring, sleeve cables are used, noise will be introduced into the system. Tip, ring, sleeve (TRS) cables have a 1/4" plug composed of three segments for three wires, one wire is for ground, one wire is for the signal in phase, and one wire is for the same signal 180 degrees out of phase. TRS cables also should have braided wire surrounding the other three wires to shield against interference. These cables may be present in studios that own some equipment with balanced inputs and outputs. If a DP/4 customer calls and complains about noise when they use the DP/4 in their signal chain, ask the customer to check their cables, make sure they are not using TRS cables with their DP/4.

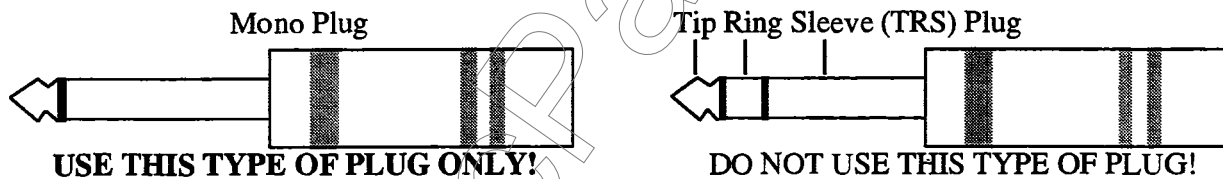

Figure 2 – What Plugs to Use

## 4. CABLES

Inside the DP/4 there is a warning/information label just for you. We just wanted to let you know that we are using a high retention force connector on the transformer. This means it will be very difficult to remove this connector by just pulling. We recommend the use of a scribe, screwdriver or similar object when disconnecting cables. Watch out for them, and please don't pull on the wires!

We have found that some units develop further problems once a module has been changed. This may be a result of improper handling of cables, **especially the 20-pin and 30-pin ribbon cables** between the keypad board and the main board. We suggest removing all cable connectors using the angled end of a scribe (see below).



These can be found in the following catalogs:

- Techno-Tool catalog 43, page 103, part number 400PR144
- Newark catalog 112, page 1115, part number 76-1510

### 5. DON'T GET SHOCKED!

When disassembling, reassembling or updating the EPROMs, make sure that the DP/4 power cord is unplugged. The EPROMs and main board screws are very close the AC line filter.

### CHECKING THE POWER SUPPLY CIRCUITRY

Some DP/4 problems may be related to a fault in the power supply circuitry. You should check this before troubleshooting the rest of the unit. **Check all the fuses to make sure they are not blown.** Plug the DP/4 in and turn it on. After it has warmed up for five minutes, begin to test the voltages. It is normal for Line Voltage to vary +/- 10%.

### DP/4 TRANSFORMER AND TRANSFORMER SECONDARY BOARDS

The DP/4 has a transformer and a transformer secondary board (see Figure 3). There is a different transformer for each line voltage (the line voltage is listed on the top of the transformer):

<u>Voltage</u>	<u>Transformer Part Number</u>
100V	1450000622
120V	1450000242
230V	1450000252
240V	1450000632

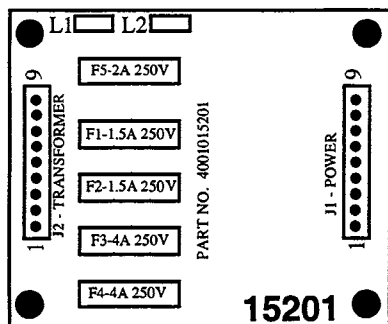

Used with CORCOM 3EEA1 Line Filter (p/n 1480000201)

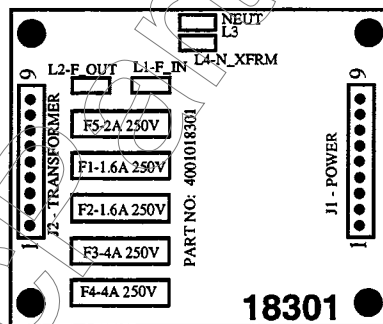

Used with CORCOM 3EAH1 Line Filter (p/n 1480000401)

The Transformer Secondary Boards and Line Filter Modules are NOT interchangeable. Replace the defective part with the same type.

Figure 3 - DP/4 Transformer Secondary Boards

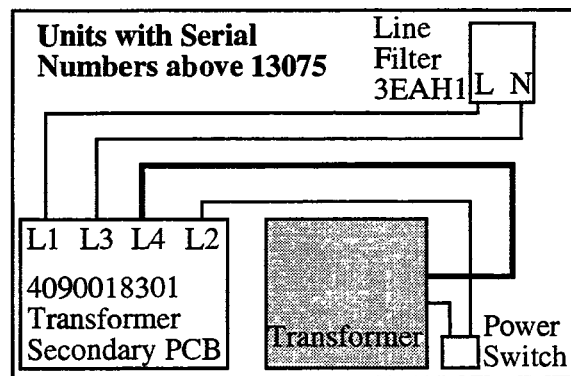
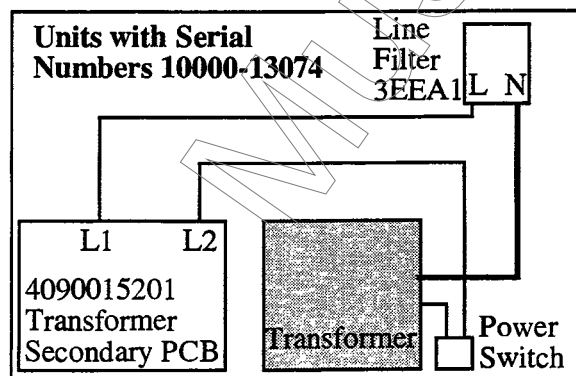

Figure 4 - AC Power Connections



**POWER SUPPLY VOLTAGE CHART**

The DP/4 is similar to the SQ products in that the power supply is integrated onto the main board. Therefore, all the power supply voltages are measured at test points on the main board. The following chart lists the voltage ranges for proper operation of each supply (fully loaded) and the appropriate points to read across with the voltmeter:

<u>Designation</u>	<u>Terminals</u>		<u>Allowable range</u>		<u>Units</u>
transformer and transformer secondary board, J1 connector (see Figure 3)					
Analog Supply	4	6	34.2	to 41.8	VACrms
Digital Supply	1	3	16.2	to 19.8	VACrms

main board (measure with respect to ground; positive (or plus) side of C83)

	+	-			
+VD	unbanded side CR71	+C83	+8.00	to +11.00	VDC
+5V	+C182	+C83	+4.75	to +5.25	VDC
-5V	-C186	+C83	-4.75	to -5.25	VDC
+15V	+C183	+C83	+14.25	to +15.75	VDC
-15V	-C187	+C83	-14.25	to -15.75	VDC
-5V	-C202	+C83	-4.75	to -5.25	VDC
+5.25*	+C225	+C83	+5.23	to +5.27	VDC
+5.25*	+C248	+C83	+5.23	to +5.27	VDC
+5V	+C258	+C83	+4.75	to +5.25	VDC
+5V	+C255	+C83	+4.75	to +5.25	VDC
+5V	+C251	+C83	+4.75	to +5.25	VDC

\* for Rev 6 ESP chips

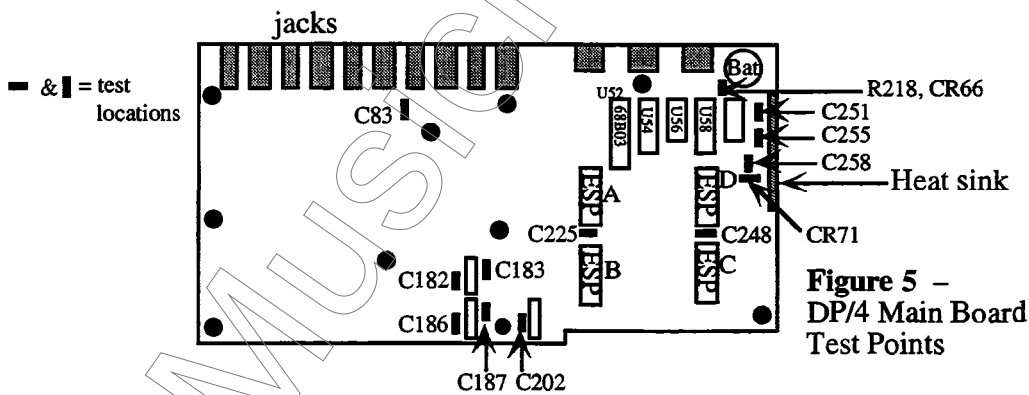

**Figure 5 – DP/4 Main Board Test Points**

## TESTING A TRANSFORMER SECONDARY BOARD UNLOADED

If voltage levels shown on p. 4 are incorrect or a fuse blows, is replaced and then blows again:

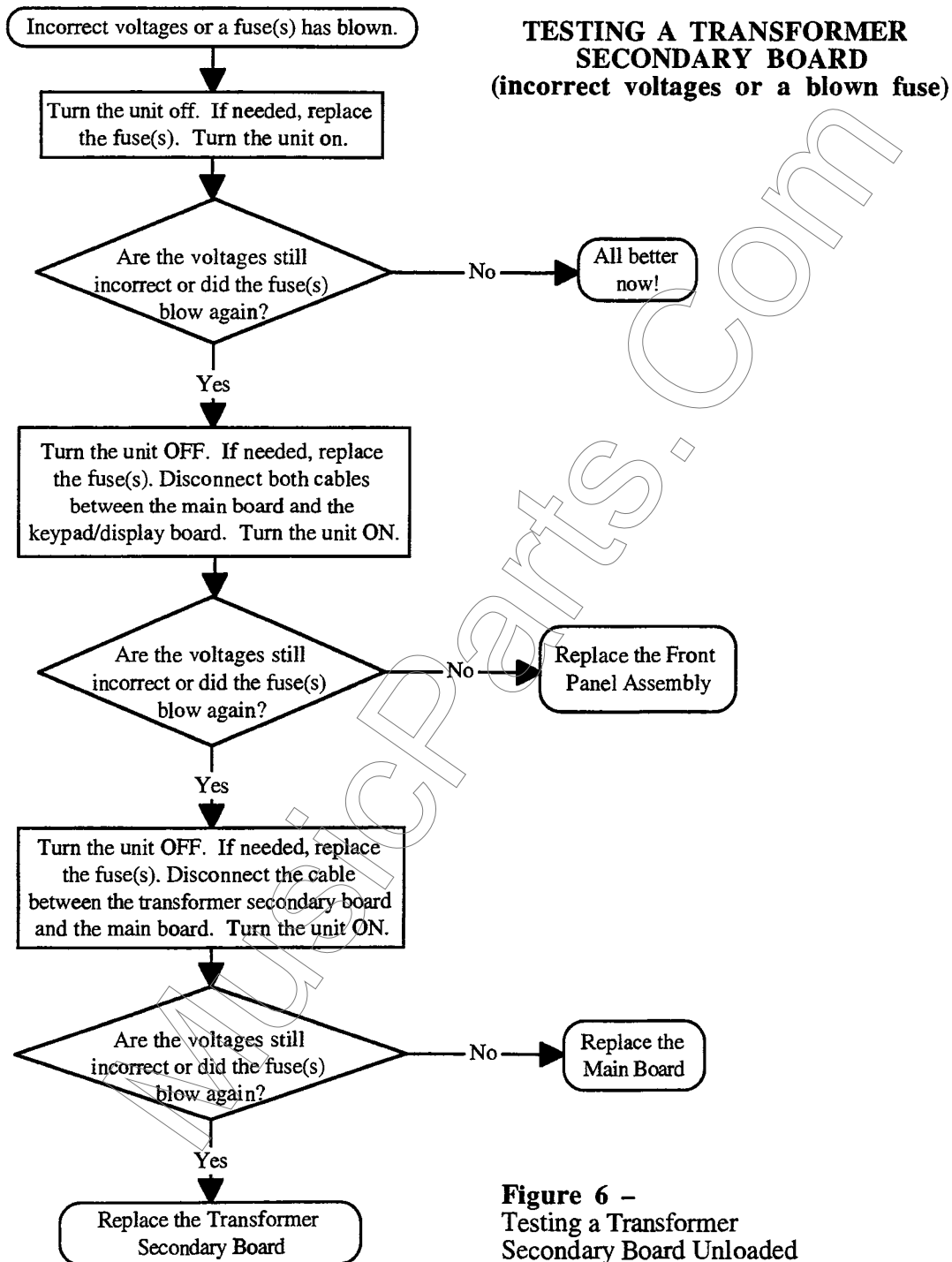
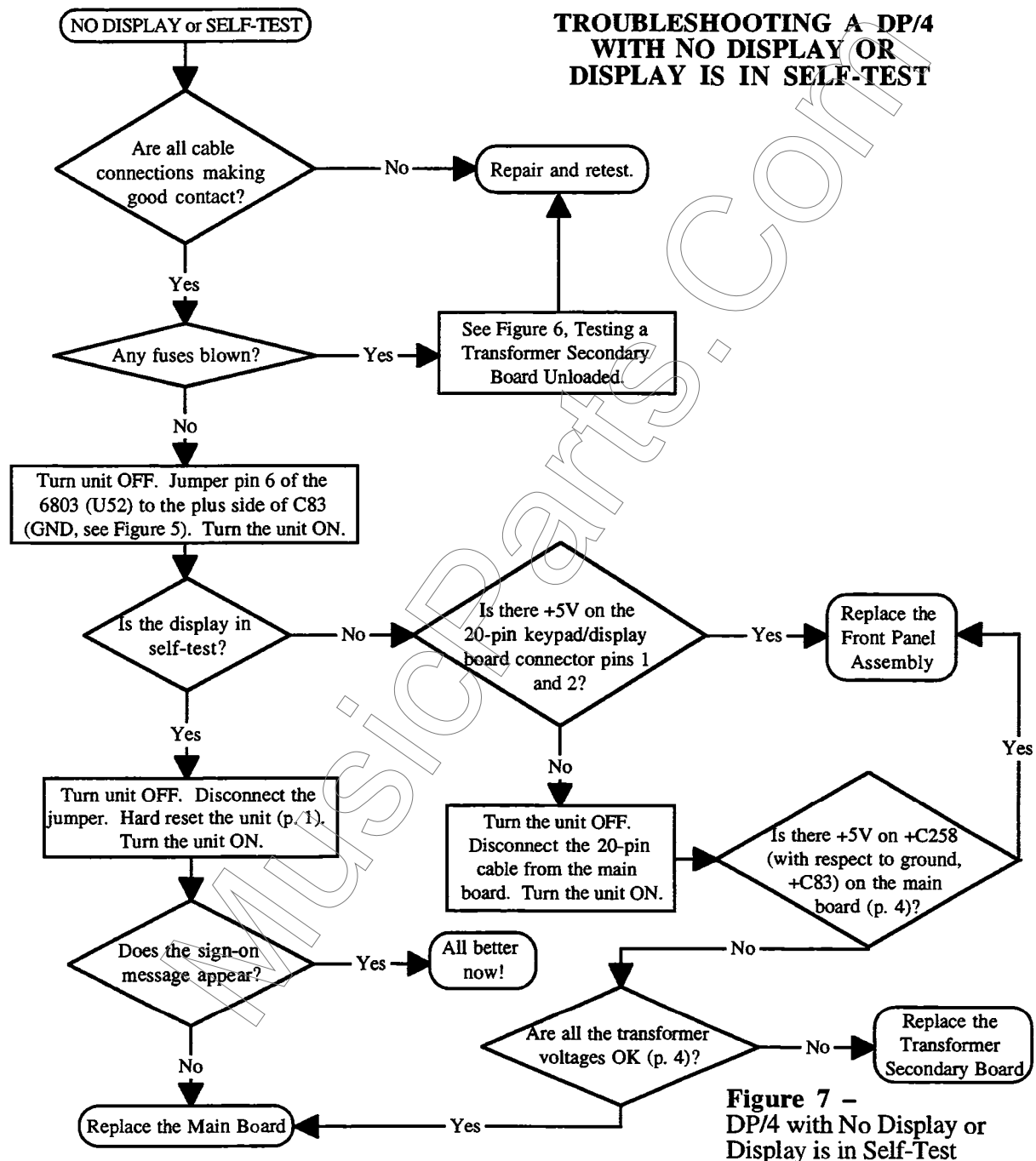

**Figure 6 –  
Testing a Transformer  
Secondary Board Unloaded**

The above method also can be used to determine the defective module if the voltages are incorrect when fully loaded.

## DISPLAY SELF-TEST MODE

When the keypad/display is receiving power from the main board but is not in proper communication with the main board, the DP/4 enters **Self-test mode**. In Self-test mode, the display remains blank until you press the buttons on the front panel. Pressing various front panel buttons will cause the display to show "BUTTON," then a number.



## UNEXPECTED EVENT MESSAGES

Occasional unexpected event messages are not unusual, and unless they become chronic, they are not a cause for concern. These messages are diagnostics and do not necessarily indicate a problem. They were designed to help our software engineers in the development of the software, not as hardware diagnostics. It is possible that chronic unexpected event messages could result from scrambled memory. Be sure to reinitialize the system (see p. 1) before troubleshooting any further.

The following unexpected event messages could be caused by a problem on the main board:

<u>Type #</u>	<u>Description</u>	<u>Type #</u>	<u>Description</u>
00	system reset error	07	routine argument out of range
01	pool head value illegal	08	unit argument out of range
02	bad buffer pointer	09	DC offset out of range
03	buffer pool depleted past limit	10	string byte count exceeded limit
04	spurious IRQ interrupt	11	attempt to display illegal byte
05	unidentified byte from display	12	byte count disagrees with pointers
06	illegal parameter type	13	incompatible version of UCODE EPROM

<u>Type #</u>	<u>Description</u>	<u>ESP A</u>	<u>ESP B</u>	<u>ESP C</u>	<u>ESP D</u>
3x	bad ucode tag	30	31	32	33
3Y	ESP not halted error	35	36	37	38
4x	ESP never ready	40	41	42	43
4Y	ESP sync error	45	46	47	48
5x	GPR verify error	50	51	52	53
6x	Inst verify failure	60	61	62	63
7x	both verify failure	70	71	72	73
8x	table verify failure	80	81	82	83
8Y	DRAM write error	85	86	87	88
9x	download verify failure	90	91	92	93

75-78 Some early units exhibited these messages. This was fixed in O.S. version 1.10 (see Software Note, p. 15).

Check the DP/4 Software Version:

- Press **System•MIDI** repeatedly until the LED display shows 63.
- The display should read "ENSONIQ \* DP/4 OS Revision X.XX".
- If the unit has version 1.14 or higher, and still has these message, reinitialize the unit (see p. 1).
- If the unit still has these messages, replace the main board.

## LOW BATTERY MESSAGE

Several things could cause this message to appear when the *unit is turned on*: "WARNING! Battery low. See manual." Press any button to continue. Sometimes the unit in question can wake up in a state of mild confusion and this message might appear. The battery level is only checked when the unit is turned on.

- Save Data (see p. 20)
- Reinitialize (see p. 1)
- Turn off then on again

### IMPORTANT!

A Low Battery Message does not necessarily mean that you have a low battery! Follow the flow chart below!

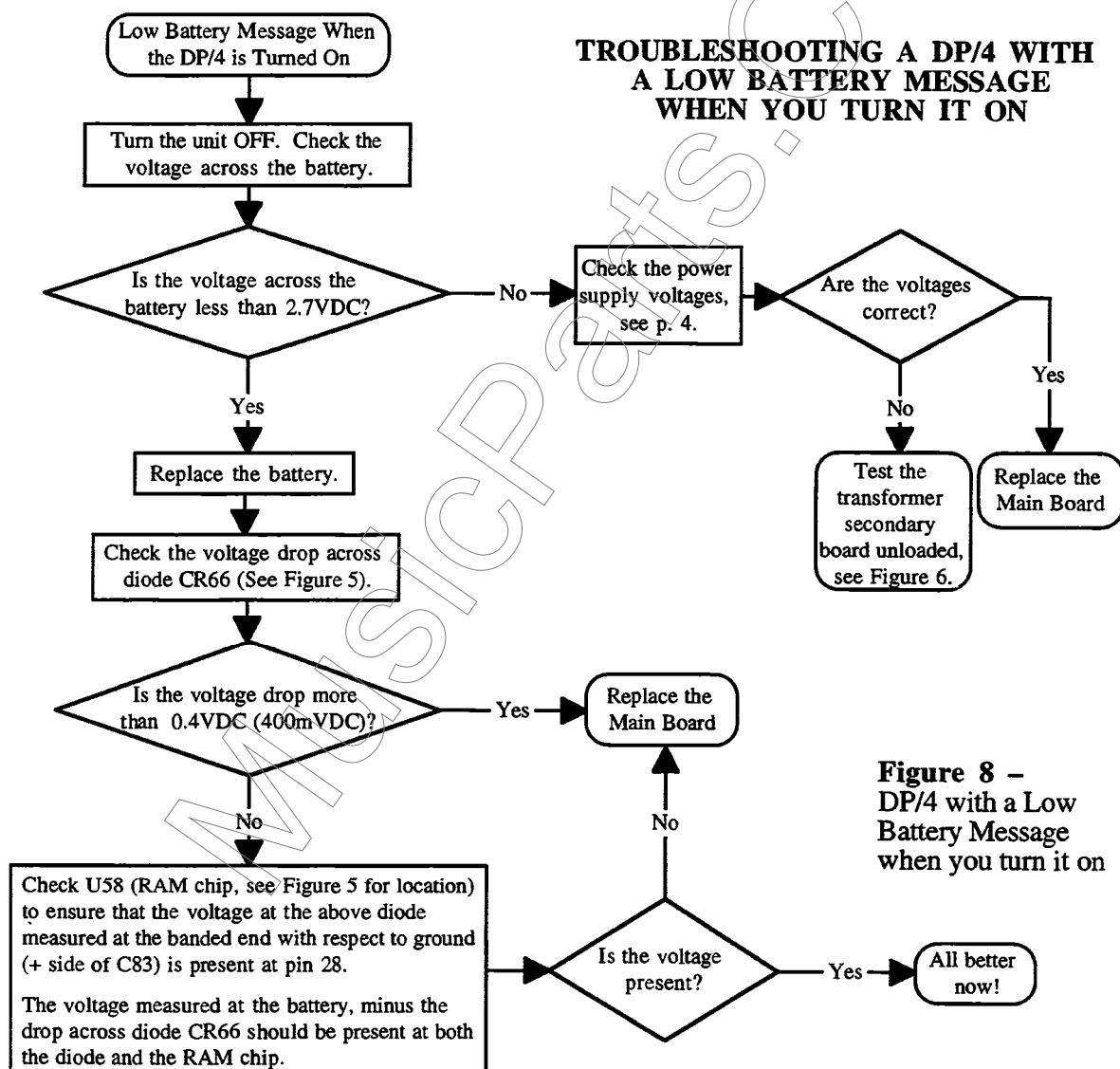

**Figure 8 – DP/4 with a Low Battery Message when you turn it on**

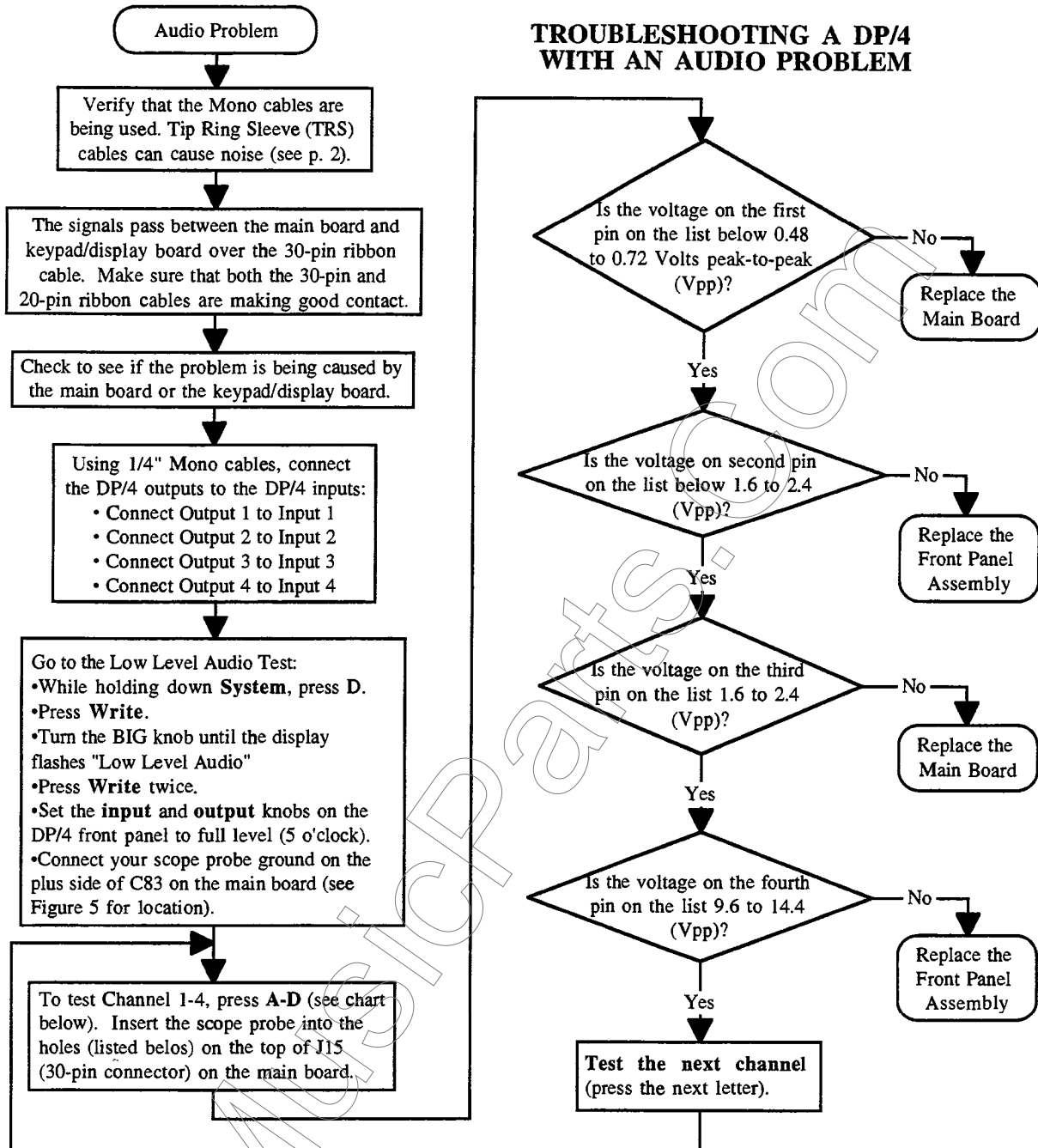

Ch 1, A	Ch 2, B	Ch 3, C	Ch 4, D	Volts peak-to-peak	Probable Cause
Pin	Pin	Pin	Pin	Vpp	if Incorrect
15	16	13	12	0.48 to 0.72	Main Board
10	8	6	4	1.6 to 2.4	Keypad/Display
24	22	20	18	1.6 to 2.4	Main Board
30	29	27	26	9.6 to 14.4	Keypad/Display

**Figure 9 – DP/4 with an Audio Problem**

### Checking Audio Signals between Main and Keypad/Display Boards:

1. Using 1/4" cables, connect the outputs to the inputs:
  - a. Connect Output 1 to Input 1
  - b. Connect Output 2 to Input 2
  - c. Connect Output 3 to Input 3
  - d. Connect Output 4 to Input 4
2. Set the input and output knobs on the DP/4 front panel to full level (5 o'clock).
3. While holding down **System**, press **D**. The display shows "Alert! Test Mode <Cancel> to Exit"
4. Press **Write**. The display shows "Select Test:" with the bottom line flashing the test name.
5. Turn the **BIG knob** until the display is flashing "Low Level Audio" on the bottom line.
6. Press **Write**. The display shows "Alert! Loud Tone <Cancel> to Exit."
7. Press **Write** again. The display shows "-20dB 1KHz Sine at DP/4 Output 1"
8. Connect the scope probe to ground. On main board J15 (the 30-pin connector), you should see:

<u>Pin</u>	<u>Volts peak-to-peak (Vpp)</u>	<u>Probable Cause if Incorrect</u>
15	0.48 to 0.72	Main Board
10	1.6 to 2.4	Display
24	1.6 to 2.4	Main Board
30	9.6 to 14.4	Display

9. To see channel 2, press **B**. The display shows "-20dB 1KHz Sine at DP/4 Output 2"
10. On the 30-pin connector, you should see:

<u>Pin</u>	<u>Volts peak-to-peak (Vpp)</u>	<u>Probable Cause if Incorrect</u>
16	0.48 to 0.72	Main Board
8	1.6 to 2.4	Display
22	1.6 to 2.4	Main Board
29	9.6 to 14.4	Display

11. To see channel 3, press **C**. The display shows "-20dB 1KHz Sine at DP/4 Output 3"
12. On the 30-pin connector, you should see:

<u>Pin</u>	<u>Volts peak-to-peak (Vpp)</u>	<u>Probable Cause if Incorrect</u>
13	0.48 to 0.72	Main Board
6	1.6 to 2.4	Display
20	1.6 to 2.4	Main Board
27	9.6 to 14.4	Display

13. To see channel 4, press **D**. The display shows "-20dB 1KHz Sine at DP/4 Output 4"
14. On the 30-pin connector, you should see:

<u>Pin</u>	<u>Volts peak-to-peak (Vpp)</u>	<u>Probable Cause if Incorrect</u>
12	0.48 to 0.72	Main Board
4	1.6 to 2.4	Display
18	1.6 to 2.4	Main Board
26	9.6 to 14.4	Display

For reference:

<u>Ch 1, A</u>	<u>Ch 2, B</u>	<u>Ch 3, C</u>	<u>Ch 4, D</u>	<u>Volts peak-to-peak</u>	<u>Probable Cause</u>
<u>Pin</u>	<u>Pin</u>	<u>Pin</u>	<u>Pin</u>	<u>Vpp</u>	<u>if Incorrect</u>
15	16	13	12	0.48 to 0.72	Main Board
10	8	6	4	1.6 to 2.4	Display
24	22	20	18	1.6 to 2.4	Main Board
30	29	27	26	9.6 to 14.4	Display

## TEST PROCEDURE

The following test procedure will ensure the thorough testing of a DP/4 and also will help qualify customer complaints about: MIDI malfunctions, audio quality, footswitch or pedal problems, and memory problems.

The DP/4 should be connected in stereo to a sound system. To perform the following tests you will need:

- a short MIDI cable
- a CV Pedal (model CVP-1)
- a dual pedal Footswitch (model SW-5)

The DP/4 is heavily software dependent, and like all computers, certain events can cause the unit to glitch and contract a severe case of amnesia. Sometimes these units merely require reinitialization (see p. 1). Be sure to save the customer's presets before reinitializing (see p. 20).

### 1. Set Up

- a) Plug the CV Pedal into the "CV•Pedal" jack (make sure that the CV Pedal is fully depressed, i.e. FULLY ON!)
- b) Plug a Dual Footswitch into the Ft. Sw. jack.
- c) Plug the short MIDI cable in, connecting the MIDI Out and MIDI In jacks.

### 2. Turn on the DP/4 and Reinitialize

- a) Turn ON the DP/4. The LCD display momentarily shows: "ENSONIQ \* DP/4 OS Version x.xx" (x.xx = current OS version)
- b) While holding down **System**, press **B**.
- c) Press the **Right arrow** button until the DP/4 LCD display shows: "Hit <Write> To Reinitialize!!!!"
- d) Press **Write**. The DP/4 should reinitialize and the display should momentarily blank, then display the initial start up screen that it normally displays after you turn the DP/4 on.

### 3. Display/Keypad Test

- a) While holding down **System**, press **Cancel**. Both displays go blank and all LEDs turn off.
- b) Press every button and verify that the correct button number is displayed: "BUTTON#xx"
 

Write/Copy	BUTTON#10	System/MIDI	BUTTON#5
Cancel/Undo	BUTTON#8	A	BUTTON#4
<	BUTTON#12	B	BUTTON#3
>	BUTTON#11	C	BUTTON#2
Select	BUTTON#13	D	BUTTON#1
Edit/Compare	BUTTON#6	Config	BUTTON#0
- c) Press each pedal of the dual footswitch and verify that the correct numbers are displayed.
 

Left Footswitch Pedal	BUTTON#15
Right Footswitch Pedal	BUTTON#7
- d) To light all the front panel leds: While holding down **Config**, press **A**. All of the LEDS should light and all of the segments in the LED display (8.8.) should be on.
- e) Turn the DP/4 OFF then back ON.



#### 4. Analog Page

- a) While holding down **System**, press **C**.
- b) The LCD display shows: "CV pedal A/D=xxx"
  - 1) With the CV pedal fully **DOWN**, the reading should be between 152 and 225.
  - 2) With the CV pedal fully **UP** the reading should be 0.
  - 3) With the CV pedal **DISCONNECTED** the reading should be 255.
  - 4) Unplug the CV pedal to verify this then **leave it unplugged**.
- c) Press the **Right arrow** button until the LCD display shows: "Footswitch1=xx  
Footswitch2=xx" where XX =Up or Down
  - 1) Press the **LEFT** footswitch. The LCD display shows: "Footswitch1=Up  
Footswitch2=Down"
  - 2) Press the **RIGHT** footswitch. The LCD display shows: "Footswitch1=Down  
Footswitch2=Up"
  - 3) Press **Cancel** to exit the analog test page.

#### 5. Mute Test, Battery Backup Test

- a) Turn the DP/4 **OFF** then back **ON** again.
- b) Press **Write**, then press **Write** again. You should be on the DP/4 edit name page with the first character in the edited name underlined.
- c) Turn the **BIG knob** in either direction to change the first character of the name.
- d) Press **Write** to write the edited name to memory. The LCD display temporarily shows: "\*\*\* WRITE \*\*\* \*\* OK \*\*\*"
- e) The DP/4 display then shows: "\*<name> (config map)", where \* is the new first character.
- f) Turn the unit **OFF** and **ON** 4 times then, listening for pops, clicks, and squeals (there shouldn't be any), then turn the unit off. Wait 10 seconds.
- g) Turn the unit on.
- h) Verify that the edited name didn't change from what you changed it to.

### DP/4 SYSTEM BLOCK DIAGRAM

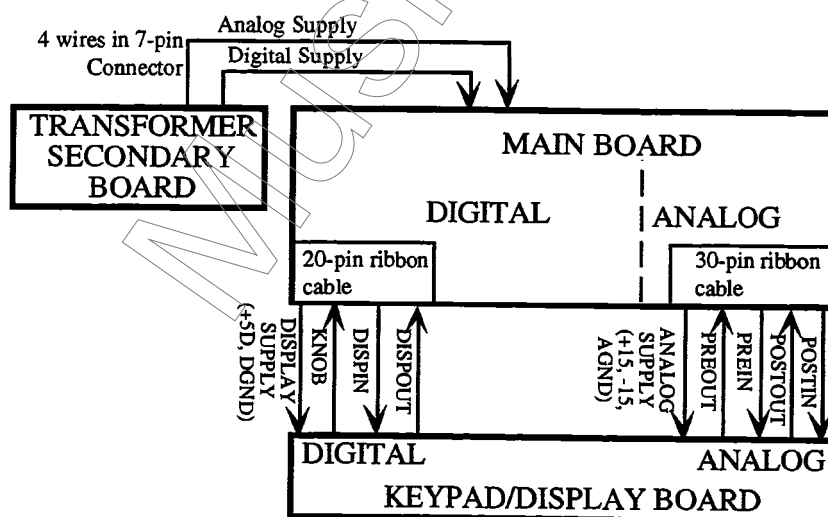

Figure 10 - DP/4 System Block Diagram

## DP/4 BURN-IN Test Procedure

The DP/4 has it's own burn-in tests in the EPROM. Here is how to run the test and what it means!

### 1. Setup

- a. Connect MIDI OUT to MIDI IN using a short MIDI cable.
- b. Make the following connections on the rear panel of the DP/4 using 1/4" MONO Male to 1/4" MONO Male phone plug cables:
  - 1) OUTPUT 1 to INPUT1
  - 2) OUTPUT 2 to INPUT2
  - 3) OUTPUT 3 to INPUT3
  - 4) OUTPUT 4 to INPUT4

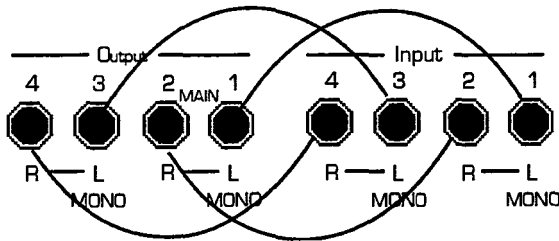

### 2. Turn on the DP/4 and Reinitialize

- a. Turn ON the DP/4. The LCD display shows: "ENSONIQ \* DP4 OS Revision x.xx" (where x.xx = Current OS Version).
- b. While holding down **System**, press **B**.
- c. Press the **Right arrow** button. The LCD display shows: "Hit <Write> To Reinitialize!!!"
- d. Press **Write**. The DP/4 reinitializes then shows the start up screen.

### 3. Set Channel Volume Pots

- a. Set all four of the Input Channel Volume pots to a 3 o'clock position.
- b. Turn all four of the Output Channel Volume pots all the way up (5 o'clock position).

### 4. Start burn-in code

- a. While holding down **System**, press **Config**. The LCD display shows: "Alert! Test Mode <Cancel> to Exit"
- b. Press **Write**. The LCD display shows: "Alert! Loud Tone <Cancel> to Exit"
- c. Press **Write**. The LCD display shows: "Alert! Starting Auto Test Cycle" The DP/4 will then begin to run through the burn-in tests and display the status of each test after it has been performed.

**NOTE:** If any test fails, the LED display will flash: *Er*. See Test Result Pages on the following page.

- | <u>Test</u>  | <u>Passing Display shows</u>      |
|--|-----------------------------------|
| 1) ROM Checksums<br>Verify that the checksum on the screen matches checksum on the EPROM label (OS=U56 and UC=U54)   | "ROM Checksums: OS=xxxx UC=xxxx"  |
| 2) MIDI LOOPBACK<br>* <b>If there is a failure</b> , check the MIDI cable to make sure it is in the correct location and fully inserted. If this test still fails, then it indicates a Main Board problem.   | "MIDI Loopback Test Status=PASS"  |
| 3) TESTING DRAM<br>* <b>Failure indicates Main Board problem.</b>  | "Testing DRAM .....PASS"          |
| 4) TESTING ESP DRAM<br>* <b>Failure indicates Main Board problem.</b>  | "ESP DRAM Test A=P B=P C=P D=P"   |
| 5) TESTING O.S. RAM<br>* <b>Failure indicates Main Board problem.</b>  | "Testing OS RAM PASS"             |
| 6) AUDIO LOOP TEST<br>* <b>If there is a failure</b> , check the audio cables to make sure they are in the correct locations and fully inserted. Check that the front panel input knobs are at 3 o'clock and that the output knobs are at 5 o'clock. If this test still fails, follow the flowchart in Figure 9. | "Audio Loop Test 1=P 2=P 3=P 4=P" |
| 7) ESP MAC TEST<br>* <b>Failure indicates Main Board problem.</b>  | "ESP MAC Test A=P B=P C=P D=P"    |

### Test Result Pages

Page 1, the LCD display shows the error counts:

"T:0001 R:0000" (Where T is the total test loop count, and R is the OS RAM Test error count.)

"M:0000 D:0000" (Where M is the MIDI Loop test, and D is the DRAM Test.)

Press the **right arrow** button to view page 2. The test result page will be displayed after the current test is completed. The LCD display shows the error counts:

"A:0000 E:0000" (Where A=Audio Loop Test and E=ESP DRAM.)

"X:0000 C:0000" (Where X=ESP MAC Test, and C=ROM Checksum.)

### To Stop the Burn-in Test:

- Press **Cancel•Undo**. This **ALWAYS** reinitializes the DP/4.

## DP/4 SOFTWARE NOTES

### To Check the DP/4 Software Version:

- Press **System•MIDI** repeatedly until the LED display shows 63.
- The display should read "ENSONIQ \* DP/4 OS Revision X.XX".

**Version 1.06** contains some performance improvements and fixes for problems that have been discovered since the version 1.00 release. Note that \* indicates a new feature added in this release.

#### Algorithms:

- **VCF-DISTORTION** — Changes were made to correct a problem which caused the envelope follower release time to work incorrectly over the 5-10 second range. This change affects the documentation in that the parameter limits are now actually 1msec to 10sec instead of 50µsec to 10sec. The sound of existing presets is not affected and the displayed values will now be correct. Existing presets which were set in the range of 6 to 10msec did not and will not now sound correct.
- **FASTPITCHSHIFT, EQ-DDL-WITH LFO AND EQ-CHORUS-DDL** — Polyphase interpolation was added to these algorithms to improve performance and reduce high frequency anomalies associated with LFO modulation.
- **PITCH SHIFTER, FASTPITCHSHIFT AND PITCH SHIFT 2U** — Modifications were made to these algorithms to eliminate a problem which caused excessive splicing at pitch ratios of zero and at non-zero LFO widths. These changes should reduce transport delay and eliminate clicking with extreme LFO widths.

#### General System:

- **FOOT SWITCH PRESET INC/DEC** — A problem was corrected which could cause the system to get confused if the foot switch was used to increment the current preset "past" 99 or decrement the current preset "past" 00. In addition, the Show 100 Config Preset switch limited the range of available presets for *all* preset types when it was set to NO. This limited range now applies only to Config presets as originally intended.
- \* **DOWNLOAD VERIFY DISABLE SWITCH** — a new switch was added on a new page available in System Diagnostic mode (accessed via "System-C"). The default state of this switch is "Disabled" and in this state the redundant download verification is bypassed to speed up the download process. The switch can be set to "Enabled" if the user experiences any download problems or desires the extra level of checking.

**Version 1.10** contains some minor improvements and fixes for problems that have been discovered since the version 1.06 release.

#### General System:

- **SHOW 100 CONFIG PRESETS DEFAULT** — The default state of the "Show 100 Config Presets" switch has been changed to "Yes" in response to suggestions that users will find this more consistent with the overall design while learning about the system.
- **DC OFFSET WINDOW** — The acceptable range of DC offsets has been increased by a factor of two to eliminate production and field problems which resulted when inaudible minor DC Offset variations triggered the warning message display mechanism.
- **ESP HALT RELEASE** — The halt lines of the four ESP chips are now released for a brief time during system reset to allow the chips to run momentarily before the DRAM clearing procedure is initiated. **This change is intended to reduce the incidence of Unexpected Event 75-78 messages.**

**Version 1.14** (released 12/1/92) contains some minor improvements and fixes for problems that have been discovered since the version 1.11 release.

#### General System:

- **DELAY TIME IN 2U DELAY PRESETS** — Presets employing the 2 Unit "3.3 Second Delay" algorithm in Continuous mode will now install the correct delay time when they are saved or selected. In previous versions, an incorrect delay time was always installed even though the correct delay time was displayed.
- **SWAP/COPY PROBLEM** — This software release corrects a problem that occurred when the Swap/Copy Unit function was invoked and the two involved units each had a different edit buffer status. The unit(s) would temporarily be in a confused state until the Edit button was used to toggle the units in/out of their respective edit buffers.

#### Algorithms:

- **PITCHSHIFT - DDL** — Several changes were made to improve the operation of this algorithm. The delay line regeneration will now operate correctly on both the left and right sides (as described in the manual). The regeneration was improved to allow higher values without distortion or loss of sound.

#### Presets:

- Presets employing the "PitchShift - DDL" algorithm were updated to correct previously out-of-range Regeneration parameter values that would be displayed as invalid data. The following presets required adjustment: RAM 1U-47, 1U-49, 2U-29, 2U-49, 4U-48.

**SECTION**  
**A**

## Replacing the Main Board

Removing

1. Remove all cables connected to the DP/4, especially the power cord.
2. Remove the eight (8) screws from the lid.
3. Remove the lid by sliding it towards the back of the unit and then lifting up.
4. Cut the wire ties (**be very careful not to cut the wire insulation**): one on the transformer and one over the edge-mounted main board heat sink.
5. Disconnect all cables from the Main Board:
  - a) the 30-pin front panel ribbon cable (J15),
  - b) the 20-pin front panel ribbon cable (J17),
  - c) the 7-pin power cable (J16) NOTE that it is keyed,
  - d) the 4-pin channel 1 In (from the front panel) jack cable (J14), and
  - e) the ground cable (transformer secondary board soldered to main board or lug)
6. Remove the ten (10) nuts from the rear panel jacks marked Ft. Sw., Pedal•CV, four (4) Outputs and four (4) Inputs.
7. Remove the main board mounting screws (see Figure 11 for locations):
  - a) Remove ten (10) screws from the main board.
  - b) Remove the three (3) screws that go from the side of the unit to the main board heat sink.

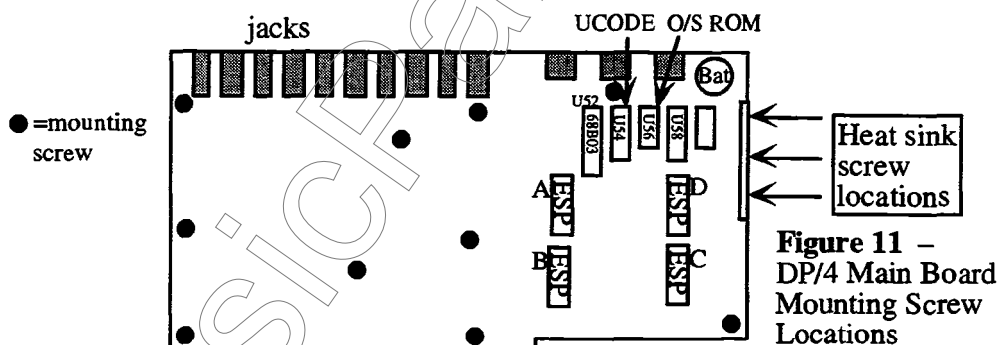

**Figure 11 -**  
DP/4 Main Board  
Mounting Screw  
Locations

8. Disconnect the three (3) wires from the line filter.
9. Slide board toward the front panel to clear jacks from their holes in the rear panel.
10. Slide board to left (front panel closest to you) to clear the main board heat sink on the right side of the main board.
11. Lift the front of the main board and slide it toward you and out, see Figure 12.

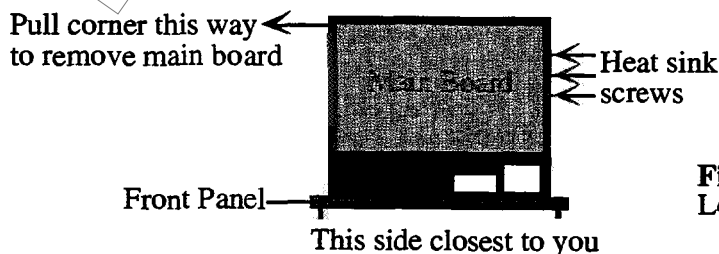

**Figure 12 -**  
Looking down into the DP/4

- Installing
12. With the board tilted on a slight angle, insert the jacks into the holes in the rear panel. Make sure that no wires are trapped under the board.
  13. Reinstall the ten main board screws and the three heat sink screws.
  14. Secure the jacks with the nuts.
  15. Connect the front panel cables, power cable, ground wire, and line filter wires (see Figure 4).
  16. Power up, test the unit. Reinstall the eight screws on the lid (**use no more than 8 in/lbs of torque**).

<b>SECTION</b>
<b>B</b>

## Replacing the Front Panel Assembly

- Removing
1. Remove all cables connected to the DP/4, especially the power cord
  2. Remove the eight (8) screws from the lid.
  3. Remove the lid by sliding it towards the back of the unit and then lifting up.
  4. Disconnect the 4-pin cable (NOTE that it is keyed) from J14 on the main board.
  5. Disconnect the 20-pin and 30-pin cables from J17 and J15 on the main board.
  6. Remove three (3) screws on each side of the unit that fasten the ears to the unit. The nuts will drop inside the unit, be sure to retrieve them.

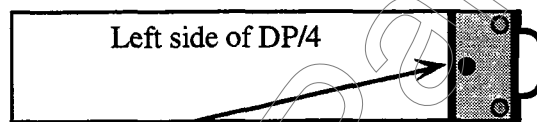

Flat head screw fastened with KEPS nut inside unit

**Figure 13 –**  
To remove the front panel assembly, remove these three screws on both sides of unit.

7. Disconnect L2 from the transformer secondary board. Two wires are still attached to the switch on the front panel.
  8. Holding the handles on the front panel, pull the front panel towards you. You may need to give it a substantial tug to get it started.
  9. Disconnect the green transformer wire from the top lug of the switch. Disconnect the black wire from the bottom lug of the switch.
- Installing
10. Attach the small end of the black wire to the bottom lug of the switch on the replacement assembly. Attach the green transformer wire to the top lug of the switch.
  11. Slide front panel into unit as far as it will easily go. Note where the silver clip is attached to the top and bottom front rails. This clip holds the front panel assembly together.
  12. Turn the unit up side down.
  13. Press on the base right where the silver slip is. Slide the front panel assembly and base together (until dimples on base are in rail).
  14. Turn unit right side up. You can tell if the front panel assembly is all the way on if the three screw holes on each side line up.

15. Put screws on left side first (front panel closest to you).
16. To put flat head screw and KEPS nut on right side (transformer side) you will need to hold the nut with long needlenose pliers while you screw the screw in.
17. Connect the 20-pin and 30-pin cables to the main board.
18. Connect the other end of the black wire to L2 on the transformer secondary board.
19. Power up, test the unit. Reinstall the eight screws on the lid (**use no more than 8 in/lbs of torque**).

---

<b>SECTION</b>
----------------

<b>C</b>
----------

## Replacing the Transformer Secondary Board

**IMPORTANT!** Two different versions of the transformer secondary boards were used in the DP/4 and they are **NOT interchangeable**. Make sure that you order the same version that is currently in the unit. See Figures 3 and 4 for more information and AC power connections.

Removing

1. Remove all cables connected to the DP/4, **especially the power cord**.
2. Remove the eight (8) screws from the lid.
3. Remove the lid by sliding it towards the back of the unit and then lifting up.
4. Disconnect the two cables from the transformer secondary board (note that these connectors are keyed):
  - a) the 7-pin power cable (J1),
  - b) the 9-pin transformer cable (J2).
5. Disconnect all wires from the transformer secondary board:
  - a) L1 wire from the line of the line filter
  - b) L2 wire from the power switch
  - c) if it is a 18301 board, disconnect L3 (wire from neutral of the line filter) and L4 (wire from the transformer).
6. Remove the four (4) machine screws and one star washer that secure the transformer secondary board to the base.

Installing

7. Insert the replacement transformer secondary board.
8. Reinstall the transformer secondary board screws and star washer (on the ground pad). **Use no more than 8 in/lbs of torque**.
9. Carefully connect the cable and wires, see Figure 4 for connections.
10. Power up, test the unit.
11. Reinstall the eight screws on the lid (**use no more than 8 in/lbs of torque**).

**If you must replace a 15201 with a 18301, you must:**

- a) order one 3EAH1 line filter (ENSONIQ part number 1480000401)
- b) order one 18AWG 16.5" black wire (ENSONIQ part number 2020016001).
- c) Make the connections as shown in Figure 4.

## SECTION

## D

**Replacing the O.S. EPROMs**

The DP/4 operating system can be updated by replacing the O.S. EPROMs. Each DP/4 has two EPROMs located on the main board near the line filter. After replacing these EPROMs, the DP/4 must be reinitialized (see p. 1). The internal presets are automatically replaced by presets in the ROM during reinitialization.

**All DP/4 data must be saved before starting this procedure!**

(For more information on saving data, see p. 20).

- |            |  |
|------------|--|
| Removing   | 1. <b>Remove all cables connected to the DP/4, ESPECIALLY the power cord.</b>  |
|            | 2. Remove the eight (8) screws from the lid.   |
|            | 3. Remove the lid by sliding it towards the back of the unit and then lifting up.  |
| Installing | 4. The two EPROMs, UCODE ROM (U54) and O/S ROM (U56), are located near the line filter (see Figure 11 for location). Carefully remove the two EPROMs and insert the replacement EPROMs into their respective sockets. Be sure the notch in each EPROM is facing away from the jacks. |

**IMPORTANT! Make sure all audio cables are unplugged BEFORE turning the unit on. The first time you turn on the DP/4 after updating the software, the unit may make a pop.**

5. Power up, and reinitialize:
  - a) While holding down **System•MIDI**, press **B** and then release both buttons.
  - b) **Press the Right arrow button once.**
  - c) The display should read: "Hit <WRITE> To Reinitialize!!!!"
  - d) Press **Write** to reinitialize.
6. Check the software version: press **System•MIDI** repeatedly until the LED display shows 63. The version number should be the same as that printed on the label of the newly installed EPROMs.
7. Test the unit (see p. 11).
8. Reinstall the eight screws on the lid (**use no more than 8 in/lbs of torque**).
9. Reload the Presets that were saved before replacing the EPROMs (see p. 20).



## Saving DP/4 Data – MIDI System Exclusive (Sys-Ex) Storage

This section is for repair technicians who may not have access to a *DP/4 Musician's Manual*.

### Sending DP/4 Data Out via MIDI System Exclusive Dump

- Connect a MIDI cable from the DP/4 MIDI Out jack to the MIDI In jack of the Sys-Ex Recorder.
- Press **System** to enter System mode (System LED should be on).
- Press **Write•Copy** at any time while in System mode to engage the system exclusive dump utility. The display will look something like this:

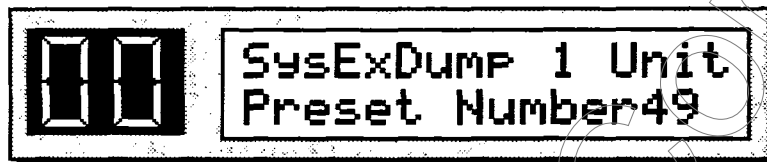

This two-parameter page allows you to select and send various kinds of MIDI System Exclusive dump messages from the DP/4. When you first enter this page, the dump type defaults to the preset belonging to the currently active unit, whose preset type and number are displayed.

- Turn the **BIG knob** to the right until the display shows "SysExDump All PsetBanks+System." (You can press **Cancel•Undo** to exit this page without sending any data.)
- Make sure that the receiving device is ready to accept data.
- Press **Write•Copy** once to start transmission of MIDI data. The display will show the following message for a brief time, which depends on the amount of information being transmitted.



When the dump is complete, the following message will appear for a moment to indicate that the transmission occurred without errors: "\*\*\*\* WRITE \*\*\* \*\* OK \*\*\*\*".

**Remember!**

The System Exclusive ID number (system parameter 50) is embedded in every message, so it must be set correctly on the transmitting and receiving units if dumps are to be recognized.

**Receiving MIDI System Exclusive Dumps with the DP/4**

Connect a MIDI cable from the DP/4 MIDI In jack to the MIDI Out jack of the Sys-Ex Recorder.

System Exclusive message reception is "automatic" and does not have to be enabled by any actions other than making sure that System Exclusive reception is enabled and that the ID number setting matches the ID embedded in the dump to be received (System•MIDI parameters 50 and 51). The MIDI LED (the right period of the LED display) will light while the dump is being received. A confirmation message is displayed when the dump reception is complete to indicate what type of dump has been received and where the new data has been stored.

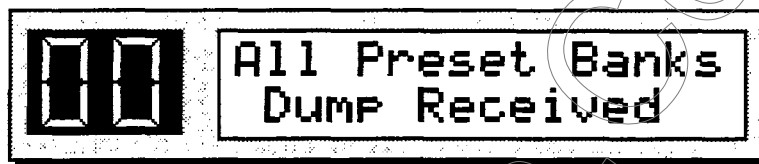

The top line of this message will describe the type of dump received. The preset type and number are shown for single preset dumps. Only the type is shown for preset bank dumps. Dumps containing system parameters will have an additional message that follows the confirmation message to indicate that the previous settings of the system parameters have been replaced by new data.

**Problems?**

An error message will be displayed instead of the confirmation message if there was a problem with the incoming data. If no message appears after the MIDI LED goes off, then the dump was ignored. Make sure the Receive enable is set to "On" and the ID number is set correctly.

**The Preset Memory Protect Switch**

Before you can copy or write presets the Preset Memory Protect switch needs to be set to the "Off" position. If it is not set to "Off" before trying to write or copy a preset, the display will read "MEMORY PROTECTED." The DP/4 defaults to this setting so that you don't accidentally erase any previously saved presets.

To set the Preset Memory Protect Switch to the "Off" position:

- Press **System•MIDI** repeatedly until the LED display shows 52.
- The LCD display shows "Preset Memory Protect="
- If the word "On" is flashing, move the **BIG knob** counterclockwise to the "Off" position. If the word "Off" is flashing, RAM preset data can be changed.

Once this switch has been set to the "Off" position, you can save presets.

## Battery Cautions

In order to comply with safety agency requirements, translations of the warning on the battery label inside the DP/4 are listed here.

English	<b>CAUTION!</b> Danger of explosion if battery is incorrectly replaced. Replace only with the same or equivalent type recommended by the equipment manufacturer. Discard used batteries according to manufacturer's instructions.
Denmark	<b>ADVARSEL!</b> Litiumbatteri - Eksplosionsfare ved fejlagtig handling. Udskiftning må kun ske med batteri af samme fabrikat og type. Lever det brugte batteri tilbage til leverandøren.
Finland	<b>VAROITUS!</b> Paristo voi räjähtää, jos se on virheellisesti asennettu. Vaihda paristo ainoastaan laitevalmistajan suosittelemaan tyyppiin. Hävitä käytetty paristo valmistajan ohjeiden mukaisesti.
Sweden	<b>WARNING!</b> Explosionsfara vid felaktig batteribyte. Använd samma batterityp eller en ekvivalent typ som rekommenderas av apparattillverkaren. Kassera använt batteri enligt fabrikantens instruksjon.

## Glossary

KEPS nut	Nut with a star washer attached
SEMs screws	Screw with a star washer attached
TRS Plug	Tip ring sleeve plug, DON'T use these with the DP/4

## ENSONIQ Part Numbers for DP/4 parts

1450000622	100V transformer
1450000242	120V transformer
1450000252	230V transformer
1450000632	240V transformer
1480000201	Line Filter, CORCOM 3EEA1, used in units with serial numbers 10000-13074
1480000401	Line Filter, CORCOM 3EAH1, used in unit with serial numbers above 13075
2020016001	Black Wire, 16" 18AWG, 0.250 lug to 0.187 lug
2050202001	20-pin Ribbon Cable
2050300701	30-pin Ribbon Cable
4090015201	Transformer Secondary Board, used in units with serial numbers 10000-13074
4090018301	Transformer Secondary Board, used in unit with serial numbers above 13075
4090015001	Main Board
9710003801	Service Kit, Front Panel Assembly

---

**NOTES**

MusicParts.Com

## ENSONIQ Customer Service

Hours: Monday through Friday 9:30 AM to 6:30 PM Eastern Time  
Closed for lunch 12:15 PM to 1:15 PM

Parts ordering: U.S. ☎1-800-441-1003      Canada ☎1-514-331-8420

Customer Tech Support: 215-647-3930

ENSONIQ Fax: 215-647-8908

When contacting ENSONIQ Customer Service, please have the following information ready:

- ☛ Model Number,
- ☛ Serial Number,
- ☛ Operation System Version (see page 15),
- ☛ Warranty Status, and
- ☛ Your Purchase Order Number when ordering parts.



THE TECHNOLOGY THAT PERFORMS

Worldwide Headquarters:  
155 Great Valley Parkway • Malvern, Pennsylvania 19355 U.S.A.

In Canada: Kaysound Imports, Inc.  
2165 46th Avenue • Lachine • Quebec, Canada H8T2P1



## Replacing the DP/4 EPROMs

Updating the DP/4 operating system simply requires saving the customer's presets (see page 3), removing some chips on the main board, replacing them with the enclosed chips, and reloading the customer's presets (see page 4). Each DP/4 has two EPROMs located on the main board near the line filter. After installing these chips, the unit must be reinitialized. The internal presets are automatically replaced by presets in the ROM during reinitialization.

1. **Save the customer's presets (see page 3).**
2. **Remove all cables connected to the DP/4, ESPECIALLY the power cord.**
3. Remove the eight (8) screws from the lid.
4. Removing the lid: lift the back edge of the lid to a 45 degree angle to the unit and slide it toward the back of the unit and then up.
5. The two EPROMs, VCODE ROM (U54) and O/S ROM (U56), are located near the line filter (see Figure 1 for location). Carefully remove the two EPROMs and insert the replacement EPROMs into their respective sockets. Be sure the notch in each EPROM is facing away from the jacks.

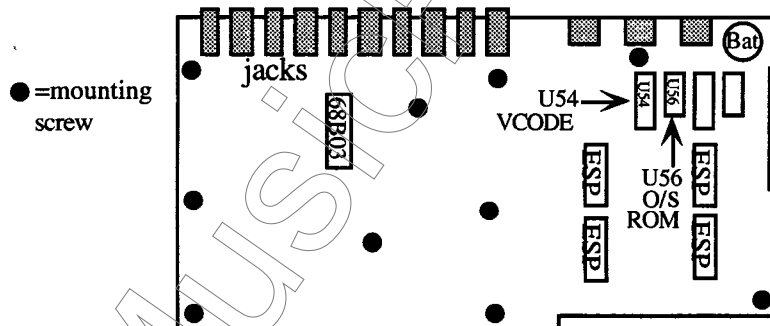

**Figure 1 –  
DP/4 Main Board  
EPROM Locations**

**IMPORTANT!** Make sure all audio cables are unplugged **BEFORE** turning the unit on. The first time you turn on the DP/4 after updating the software, the unit may make a pop.

(over)

- 
6. Power up, and reinitialize:
    - a) While holding down **System/MIDI**, press the **B** button.
    - b) **Press the right arrow button once.**
    - c) The display should read, "Hit <WRITE> To Reinitialize!!!!"
    - d) Press **Write** to reinitialize (or **Cancel** to exit).The DP/4 erases its internal memory and then starts up just as it does when you turn the power on, and reinitialization is complete. ROM presets are automatically placed in the internal memory after reinitialization.
  7. Check the software version: press **System•MIDI** repeatedly until the LED display shows 63. The version number should be the same as that printed on the label of the newly installed EPROMs.
  8. Replacing the lid: with the lid at a 45 degree angle to the unit, place the front edge of the lid into the front panel slot. You may have to use some force to make sure that the lid is fully seated in the slot.
  9. Move the lid down into place. Replace all the screws in the lid (**use no more than 8 in/lbs of torque**).
  10. Load the customer's presets that were saved in step 1 (see page 4).

---

## Sending MIDI Sys-Ex Messages to a Storage Device

- Connect a MIDI cable from the DP/4 MIDI Out jack to the MIDI In jack of the Sys-Ex Recorder (such as the ENSONIQ ASR-10, TS-10, EPS Series, or SD-1 Series).
- Press **System•MIDI** repeatedly until the LED display shows 50. Make sure that "MIDI SysEx ID=01." If not, move the **data entry knob** (big knob) until it does.
- Press **Write•Copy** while in System mode (System•MIDI LED on) to engage the system exclusive dump utility. The display shows:

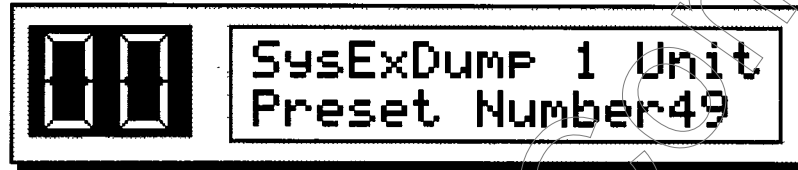

- Turn the **data entry knob** (big knob) to the right until the display shows "All PsetBanks+System." This will save the 200 RAM presets and all the system parameters (such as program change-to-preset maps and user preference switch settings). You can press **Cancel•Undo** to exit this page without sending any data.
- Make sure that the receiving device is ready to accept data, and then press **Write•Copy** to start transmission of MIDI data. The display will show the following message for a brief time, which depends on the amount of information being transmitted.



When the dump is complete, the following message will appear briefly to indicate that the transmission occurred without errors.

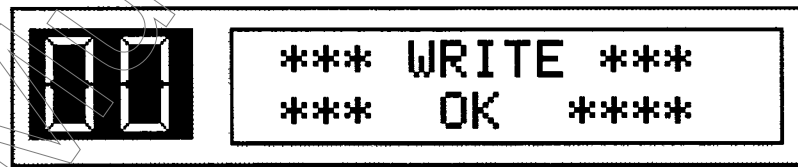

### Remember!

The System Exclusive ID number (system parameter 50) is embedded in every message, so it must be set correctly on the transmitting and receiving units if dumps are to be recognized.



---

## Receiving MIDI System Exclusive Dumps with the DP/4

System Exclusive message reception is "automatic" and does not have to be enabled by any actions other than making sure that System Exclusive reception is enabled and that the ID number setting matches the ID embedded in the dump to be received (System•MIDI parameters 50 and 51). The MIDI LED will light while the dump is being received. A confirmation message is displayed when the dump reception is complete to indicate what type of dump has been received and where the new data has been stored.

- Connect a MIDI cable from the DP/4 MIDI Out jack to the MIDI In jack of the Sys-Ex Recorder.

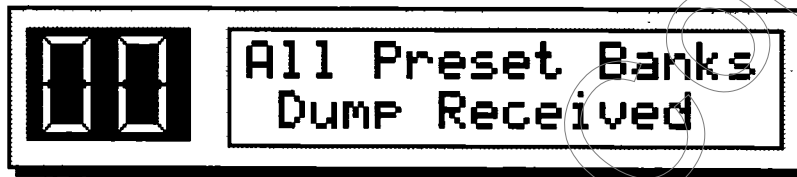

The top line of this message will describe the type of dump received. The preset type and number are shown for single preset dumps. Only the type is shown for preset bank dumps. Dumps containing system parameters will have an additional message which follows the confirmation message to indicate that the previous settings of the system parameters have been replaced by new data.

### Problems?

An error message will be displayed instead of the confirmation message if there was a problem with the incoming data. If no message appears after the MIDI LED goes off, then the dump was ignored. Make sure the Receive enable is set to "On" and the ID number is set correctly.

### The Preset Memory Protect Switch

Before you can copy or write presets the Preset Memory Protect switch needs to be set to the "Off" position. If it is not set to "Off" before trying to write or copy a preset, the display will read "MEMORY PROTECTED." The DP/4 defaults to this setting so that you don't accidentally erase any previously saved presets.

To set the Preset Memory Protect Switch to the "Off" position:

- Press **System•MIDI** repeatedly until the LED display shows 52.
- The LCD display shows "Preset Memory Protect="
- If the word "On" is flashing, move the **data entry knob** (big knob) counterclockwise to the "Off" position. If the word "Off" is flashing, RAM preset data can be changed.

Once this switch has been set to the "Off" position, you can save presets.