

TOSHIBA PHOTOCOUPLER GaAs IRED & PHOTO-TRIAC

# TLP3041(S),TLP3042(S),TLP3043(S)

- OFFICE MACHINE
- HOUSEHOLD USE EQUIPMENT
- TRIAC DRIVER
- SOLID STATE RELAY

Unit: mm

The TOSHIBA TLP3041 (S), TLP3042 (S), TLP3043 (S) consist of a zero voltage crossing turn-on photo-triac optically coupled to a gallium arsenide infrared emitting diode in a six lead plastic DIP package.

All parameters are tested to the specification of TLP3041, TLP3042, TLP3043.

- Peak Off-State Voltage : 400 V (min)
- Trigger LED Current : 15 mA (max) (TLP3041)  
10 mA (max) (TLP3042)  
5 mA (max) (TLP3043)
- On-State Current : 100 mA (max)
- UL Recognized : UL1577, File No. E67349
- Isolation Voltage : 5000 Vrms (min)
- Option (D4) Type VDE Approved : DIN VDE0884 / 06.92  
Certificate No. 68329

Maximum Operating Insulation Voltage : 890 Vpk  
Highest Permissible Over Voltage : 8000 Vpk

**Note:** When a VDE0884 approved type is needed, please designate the "Option (D4)"

Device Construction	7.62mm pich standard type	10.16 mm pich (LF2) type
Creepage Distance	7.0 mm (min)	8.0 mm (min)
Clearance	7.0 mm (min)	8.0 mm (min)
Insulation Thickness	0.5 mm (min)	0.5 mm (min)

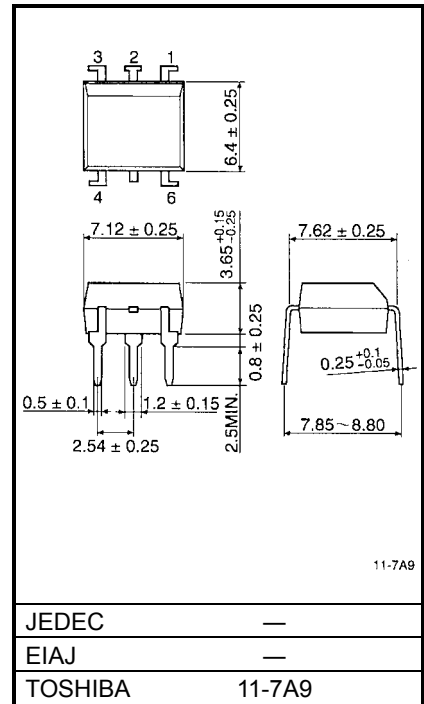

weight: 0.39g

## PIN CONFIGURATION (Top view)

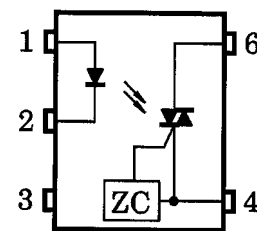

- 1: ANODE
- 2: CATHODE
- 3: N.C.
- 4: TERMINAL 1
- 6: TERMINAL 2

## MAXIMUM RATINGS (Ta = 25°C)

CHARACTERISTIC		SYMBOL	RATING	UNIT
LED	Forward Current	$I_F$	50	mA
	Forward Current Derating (Ta ≥ 53°C)	$\Delta I_F / ^\circ\text{C}$	-0.7	mA / °C
	Peak Forward Current (100 $\mu\text{s}$ pulse, 100pps)	$I_{FP}$	1	A
	Power Dissipation	$P_D$	100	mW
	Power Dissipation Derating (Ta ≥ 25°C)	$\Delta P_D / ^\circ\text{C}$	-1.0	mW / °C
	Reverse Voltage	$V_R$	5	V
	Junction Temperature	$T_j$	125	°C
DETECTOR	Off-State Output Terminal Voltage	$V_{DRM}$	400	V
	On-Stage RMS Current	$I_{T(RMS)}$	100	mA
	Ta = 25°C			
	Current		50	
	Ta = 70°C			
	On-Stage Current Derating (Ta ≥ 25°C)	$\Delta I_T / ^\circ\text{C}$	-1.1	mA / °C
	Peak On-Stage Current (100 $\mu\text{s}$ pulse, 120pps)	$I_{TP}$	2	A
	Peak Nonrepetitive Surge Current (PW = 10ms, DC = 10%)	$I_{TSM}$	1.2	A
	Power Dissipation	$P_D$	300	mW
	Power Dissipation Derating (Ta ≥ 25°C)	$\Delta P_D / ^\circ\text{C}$	-4.0	mW / °C
Junction Temperature	$T_j$	115	°C	
Storage Temperature Range	$T_{stg}$	-55 ~ 150	°C	
Operating Temperature Range	$T_{opr}$	-40 ~ 100	°C	
Lead Soldering Temperature (10s)	$T_{sol}$	260	°C	
Total Package Power Dissipation	$P_T$	330	mW	
Total Package Power Dissipation Derating (Ta ≥ 25°C)	$\Delta P_T / ^\circ\text{C}$	-4.4	mW / °C	
Isolation Voltage (AC, 1 min., R.H. ≤ 60%) (Note 1)	$BV_S$	5000	Vrms	

Note 1: Device considered a two terminal device: Pins 1, 2 and 3 shorted together and pins 4 and 6 shorted together.

## RECOMMENDED OPERATING CONDISTIONS

CHARACTERISTIC	SYMBOL	MIN	TYP.	MAX	UNIT
Supply Voltage	$V_{AC}$	—	—	120	Vac
Forward Current	$I_F^*$	15	20	25	mA
Peak On-Stage Current	$I_{TP}$	—	—	1	A
Operating Temperature	$T_{opr}$	-25	—	85	°C

\* : In the case of TLP3042

## INDIVIDUAL ELECTRICAL CHARACTERISTICS (Ta = 25°C)

CHARACTERISTIC		SYMBOL	TEST CONDITION	MIN	TYP.	MAX	UNIT
LED	Forward Voltage	$V_F$	$I_F = 10\text{mA}$	1.0	1.15	1.3	V
	Reverse Current	$I_R$	$V_R = 5\text{V}$	—	—	10	$\mu\text{A}$
	Capacitance	$C_T$	$V = 0, f = 1\text{MHz}$	—	10	—	pF
DETECTOR	Peak Off-State Current	$I_{\text{DRM}}$	$V_{\text{DRM}} = 400\text{V}$	—	10	100	nA
	Peak On-Stage Voltage	$V_{\text{TM}}$	$I_{\text{TM}} = 100\text{mA}$	—	1.7	3.0	V
	Holding Current	$I_H$	—	—	0.6	—	mA
	Critical Rate of Rise of Off-State Voltage	$dv / dt$	$V_{\text{in}} = 120\text{Vrms}, T_a = 85^\circ\text{C}$ (Fig.1)	200	500	—	$\text{V} / \mu\text{s}$
	Critical Rate of Rise of Commutating Voltage	$dv / dt(c)$	$V_{\text{in}} = 30\text{Vrms}, I_T = 15\text{mA}$ (Fig.1)	—	0.2	—	$\text{V} / \mu\text{s}$

## COUPLED ELECTRICAL CHARACTERISTICS (Ta = 25°C)

CHARACTERISTIC		SYMBOL	TEST CONDITION	MIN	TYP.	MAX	UNIT
Trigger LED Current	TLP3041	$I_{\text{FT}}$	$V_T = 3\text{V}$	—	—	15	mA
	TLP3042			—	5	10	
	TLP3043			—	—	5	
Inhibit Voltage	$V_{\text{IH}}$	$I_F = \text{Rated } I_{\text{FT}}$	—	—	40	V	
Leakage in Inhibited State	$I_{\text{IH}}$	$I_F = \text{Rated } I_{\text{FT}}$ $V_T = \text{Rated } V_{\text{DRM}}$	—	100	300	$\mu\text{A}$	
Capacitance Input to Output	$C_S$	$V_S = 0, f = 1\text{MHz}$	—	0.8	—	pF	
Isolation Resistance	$R_S$	$V_S = 500\text{V}$ (R.H. $\leq 60\%$ )	$5 \times 10^{10}$	$10^{14}$	—	$\Omega$	
Isolation Voltage	$BV_S$	AC, 1 minute	5000	—	—	Vrms	
		AC, 1 second (in oil)	—	10000	—		
		DC, 1 minute (in oil)	—	10000	—	Vdc	

Fig. 1  $dv / dt$  TEST CIRCUIT

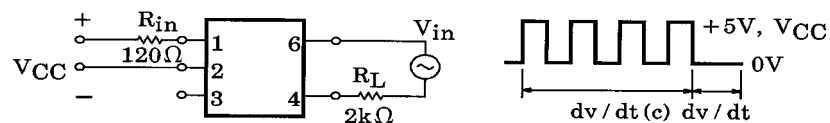

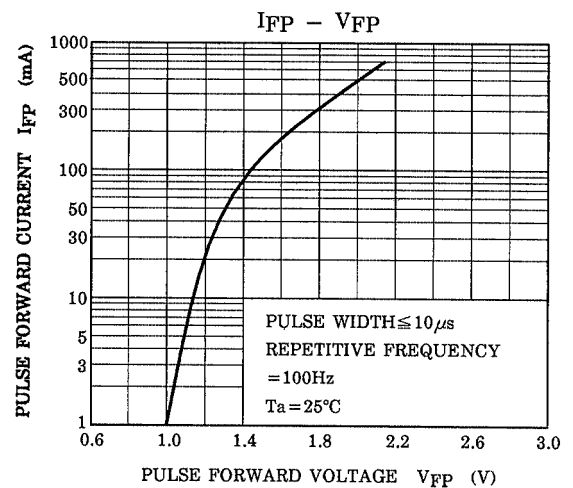
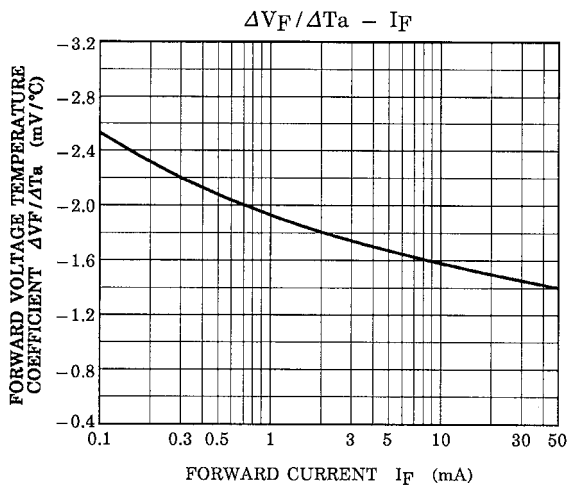
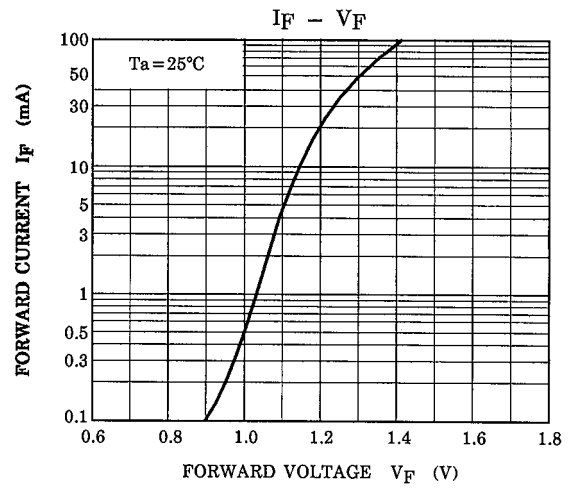
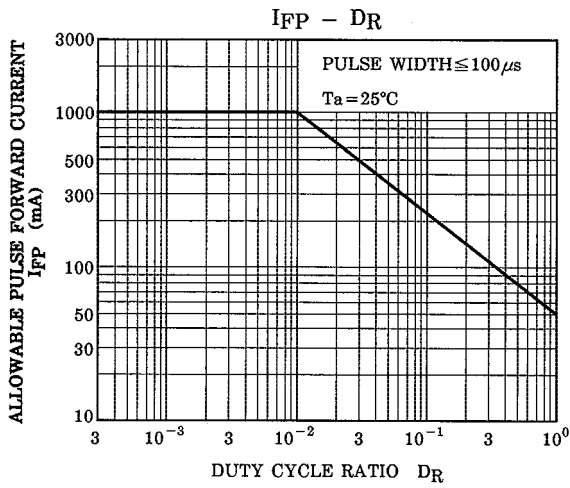
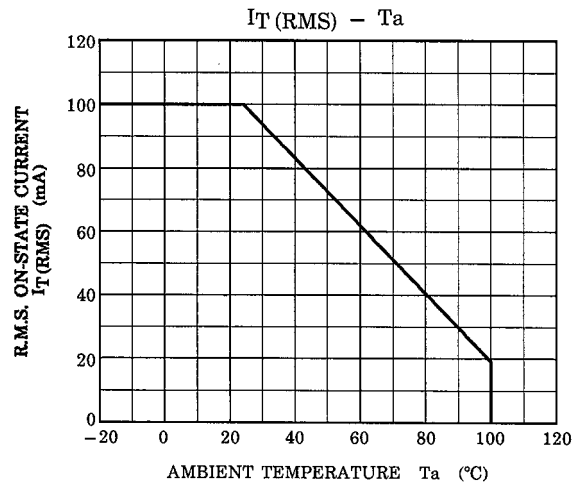
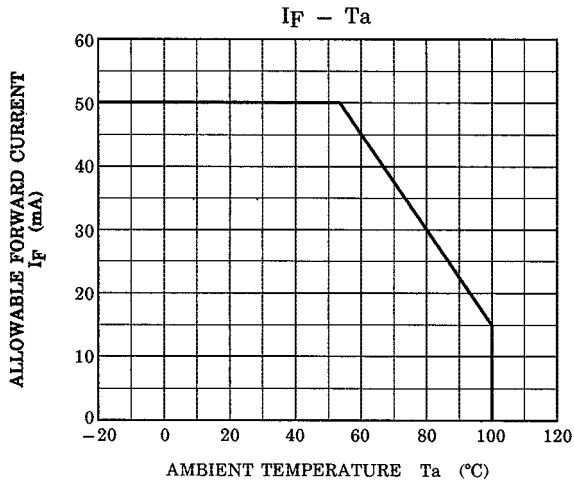

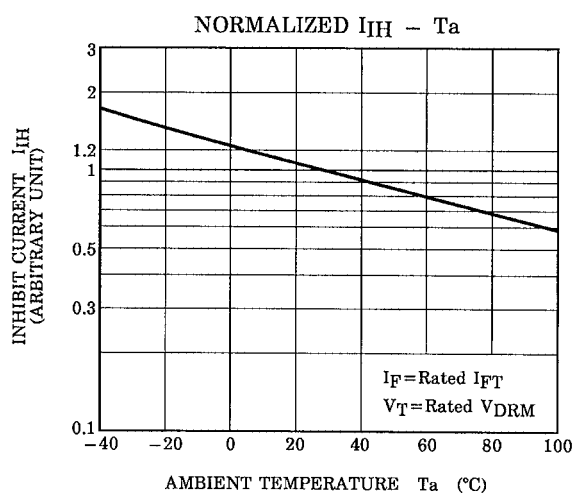
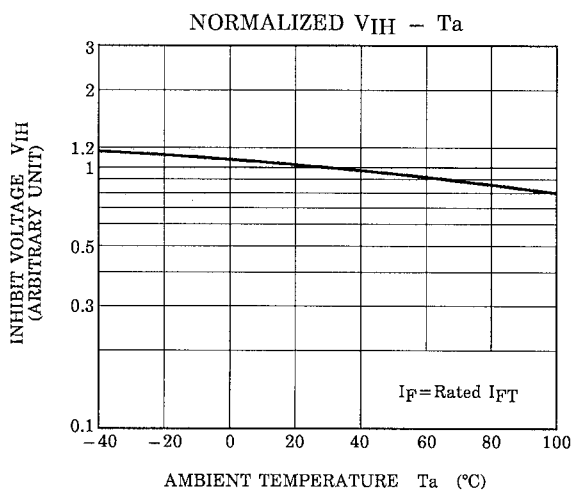
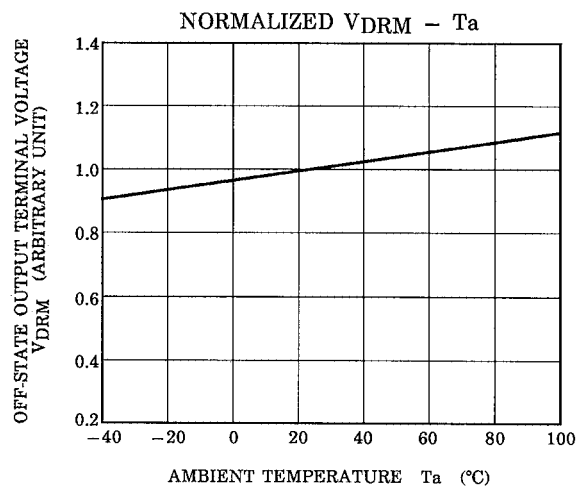
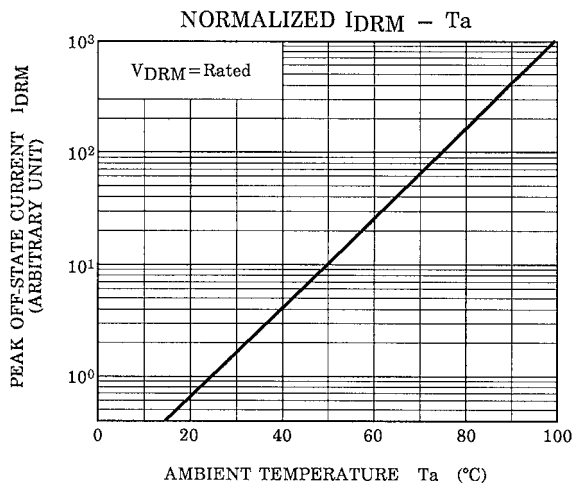
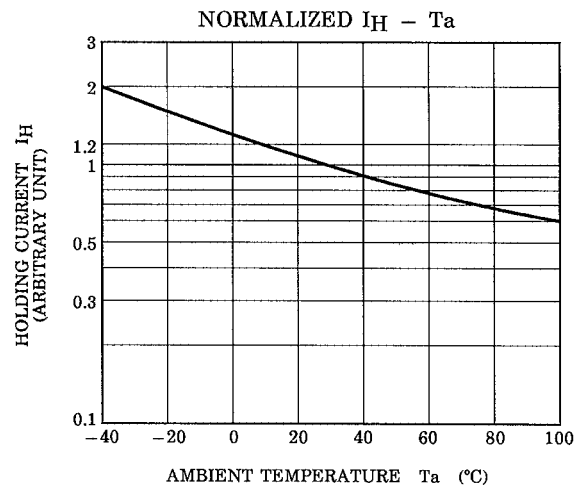
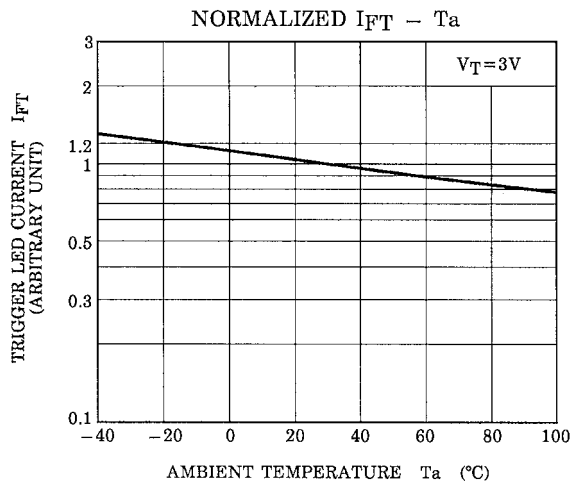

**RESTRICTIONS ON PRODUCT USE**

000707EBC

- TOSHIBA is continually working to improve the quality and reliability of its products. Nevertheless, semiconductor devices in general can malfunction or fail due to their inherent electrical sensitivity and vulnerability to physical stress. It is the responsibility of the buyer, when utilizing TOSHIBA products, to comply with the standards of safety in making a safe design for the entire system, and to avoid situations in which a malfunction or failure of such TOSHIBA products could cause loss of human life, bodily injury or damage to property.  
In developing your designs, please ensure that TOSHIBA products are used within specified operating ranges as set forth in the most recent TOSHIBA products specifications. Also, please keep in mind the precautions and conditions set forth in the "Handling Guide for Semiconductor Devices," or "TOSHIBA Semiconductor Reliability Handbook" etc..
- The TOSHIBA products listed in this document are intended for usage in general electronics applications (computer, personal equipment, office equipment, measuring equipment, industrial robotics, domestic appliances, etc.). These TOSHIBA products are neither intended nor warranted for usage in equipment that requires extraordinarily high quality and/or reliability or a malfunction or failure of which may cause loss of human life or bodily injury ("Unintended Usage"). Unintended Usage include atomic energy control instruments, airplane or spaceship instruments, transportation instruments, traffic signal instruments, combustion control instruments, medical instruments, all types of safety devices, etc.. Unintended Usage of TOSHIBA products listed in this document shall be made at the customer's own risk.
- Gallium arsenide (GaAs) is a substance used in the products described in this document. GaAs dust and fumes are toxic. Do not break, cut or pulverize the product, or use chemicals to dissolve them. When disposing of the products, follow the appropriate regulations. Do not dispose of the products with other industrial waste or with domestic garbage.
- The products described in this document are subject to the foreign exchange and foreign trade laws.
- The information contained herein is presented only as a guide for the applications of our products. No responsibility is assumed by TOSHIBA CORPORATION for any infringements of intellectual property or other rights of the third parties which may result from its use. No license is granted by implication or otherwise under any intellectual property or other rights of TOSHIBA CORPORATION or others.
- The information contained herein is subject to change without notice.