

B+ current = 320mA

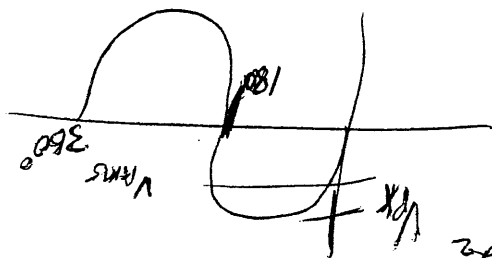
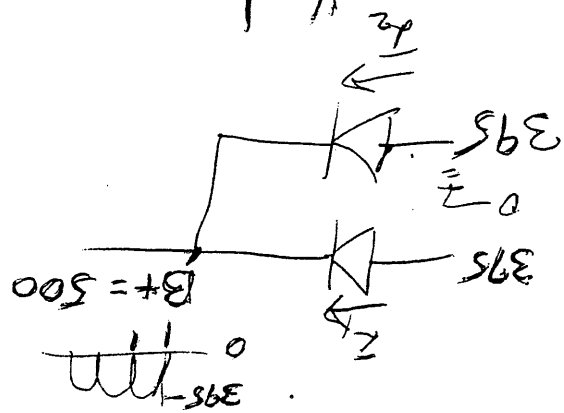

TO 180°
 $V_{RMS} = 375$

B+ Power = $P = I \cdot E = (320 \times 10^{-3}) (500) = 160W$

TO 180° $P = I \cdot E = 160W = I (375V)$

$I = \frac{160W}{375V} = 426mA_{RMS}$

Bedrock 600 Series Power Section

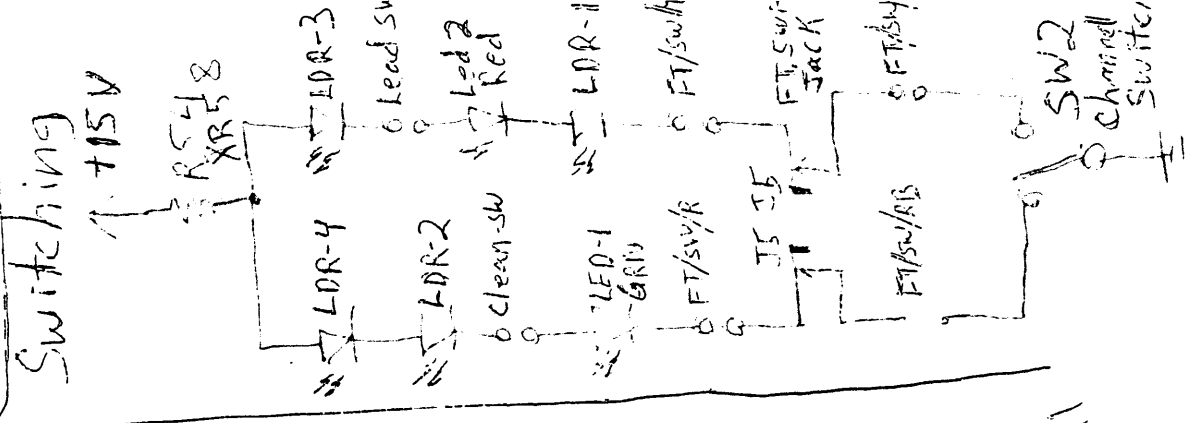
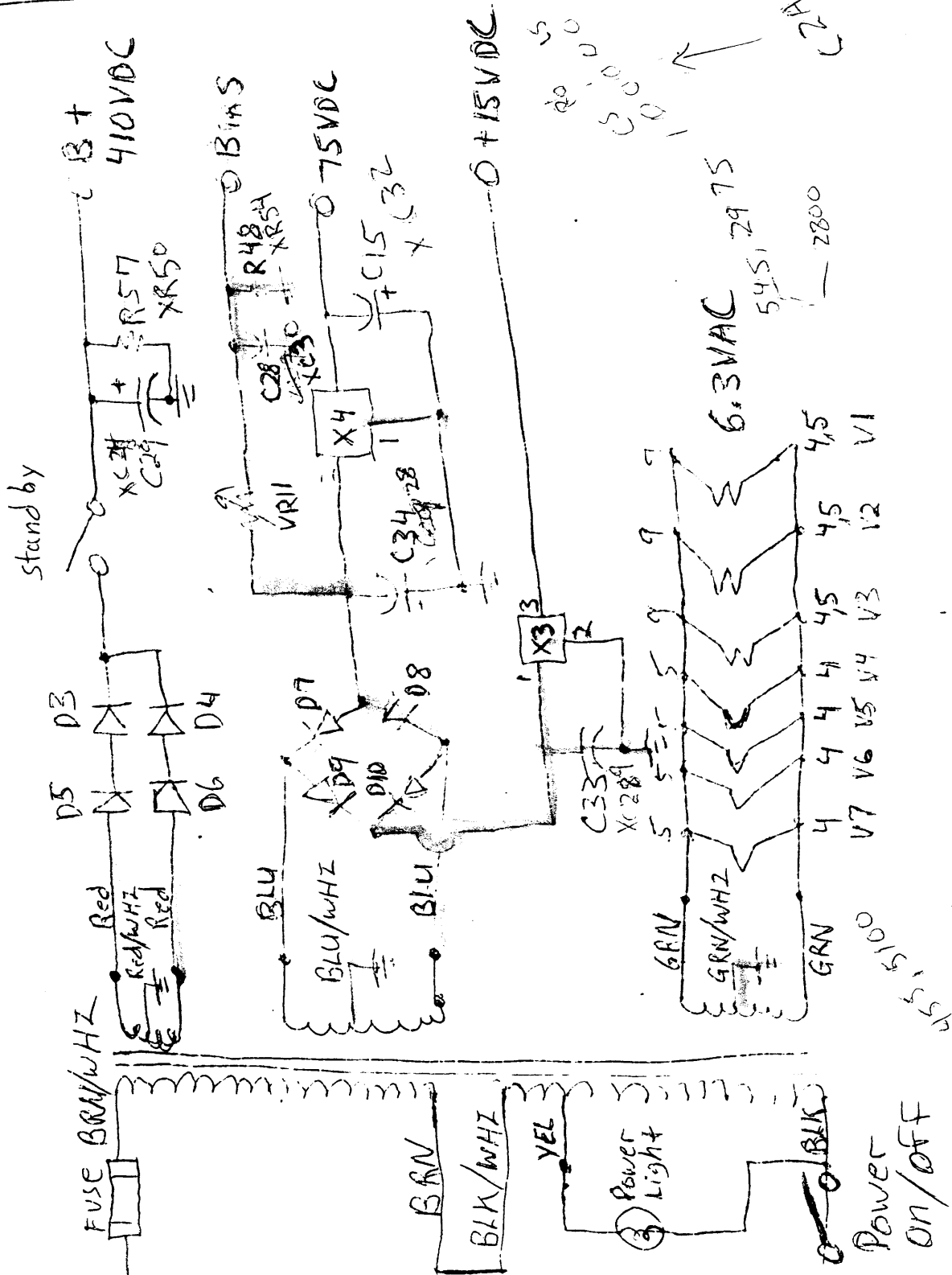

1145, 5100
 4639
 7335
 12250
 5350

Bedrock 600 Pre-amp

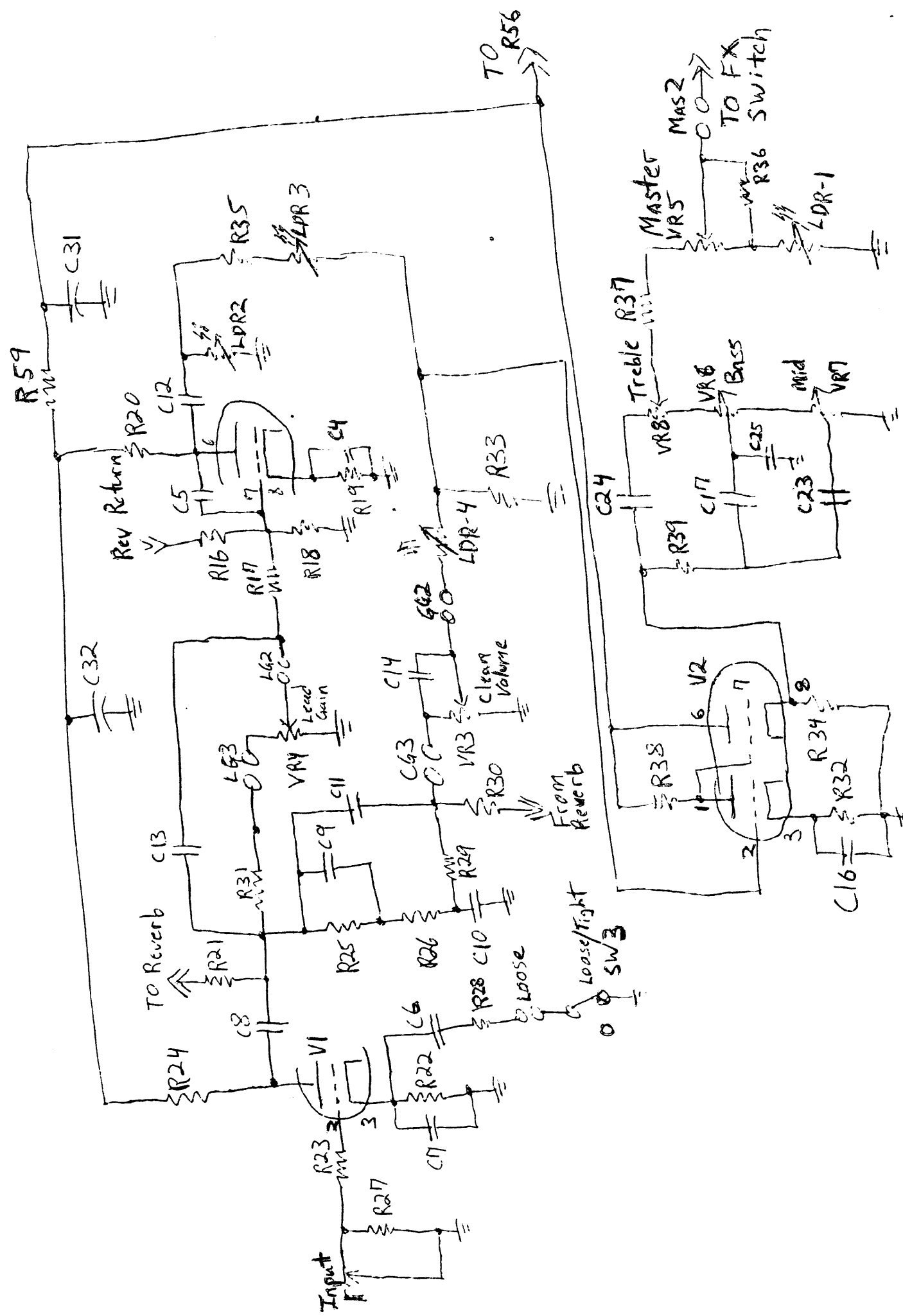

Bedrock 600 Pre-Amp

MAR RB - TB

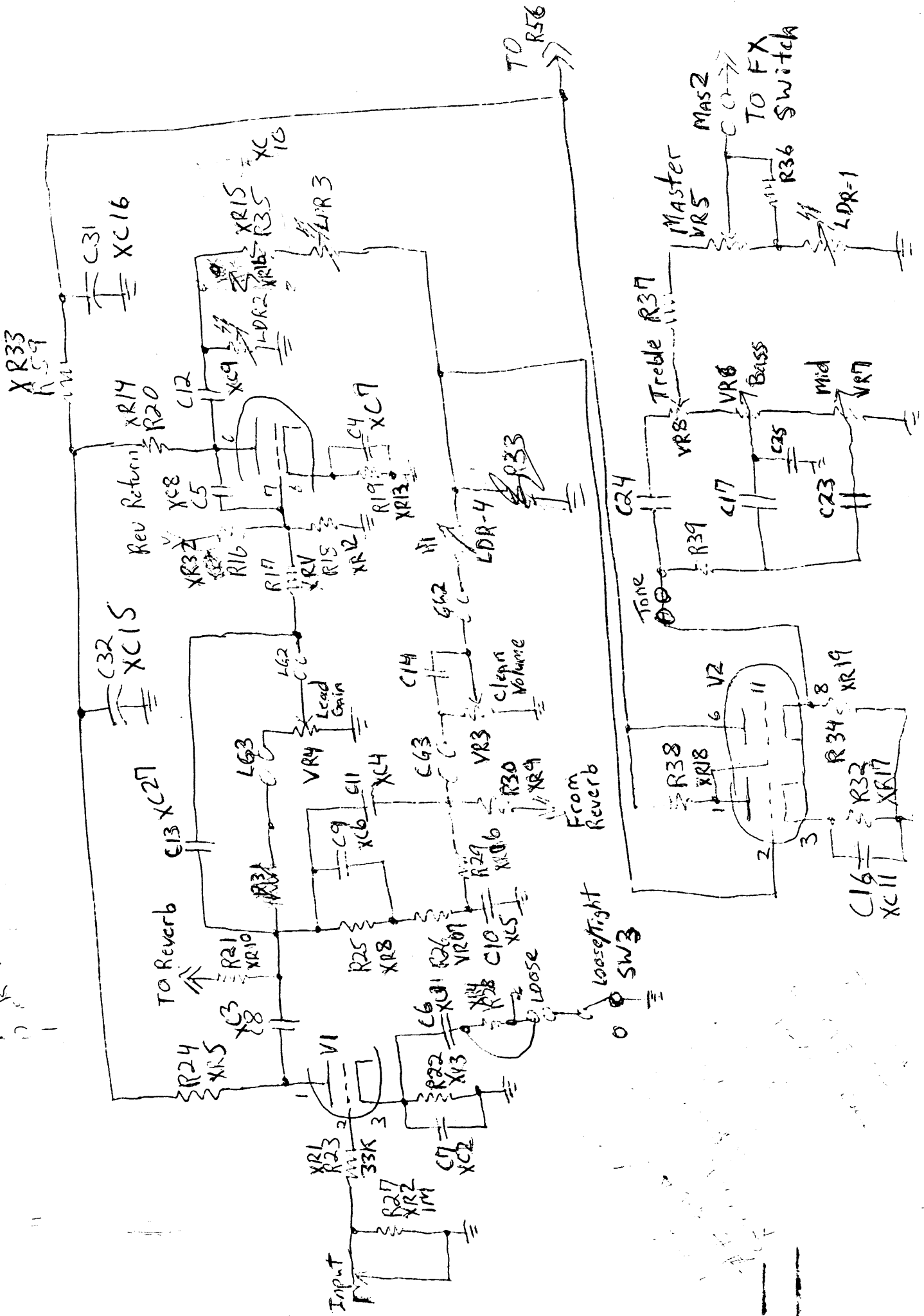

Bedrock 600

6BQ5 x(4)

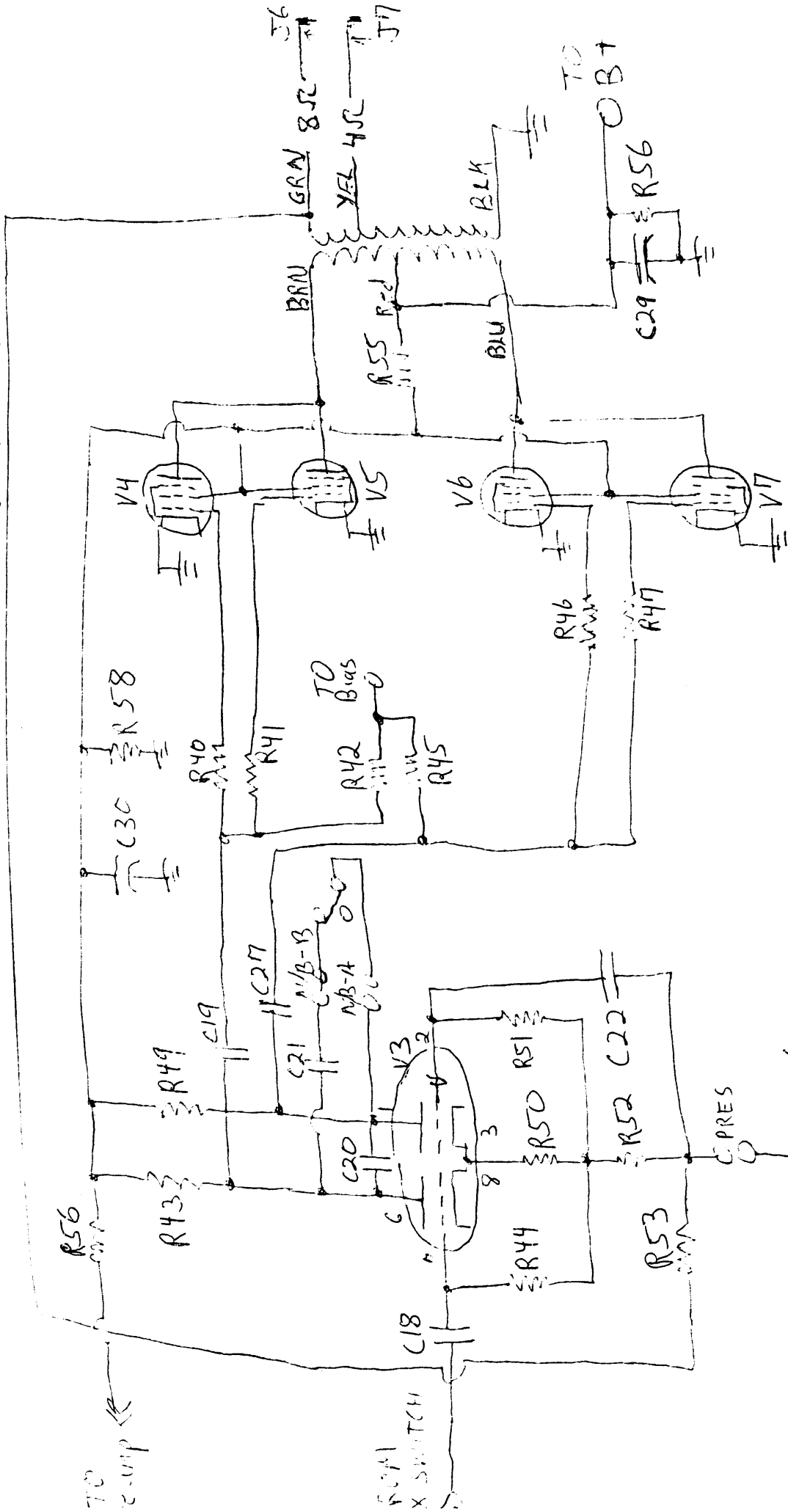

POWER AMP

PHASE INVERTER

Bedrock 600

68Q5 x(4)

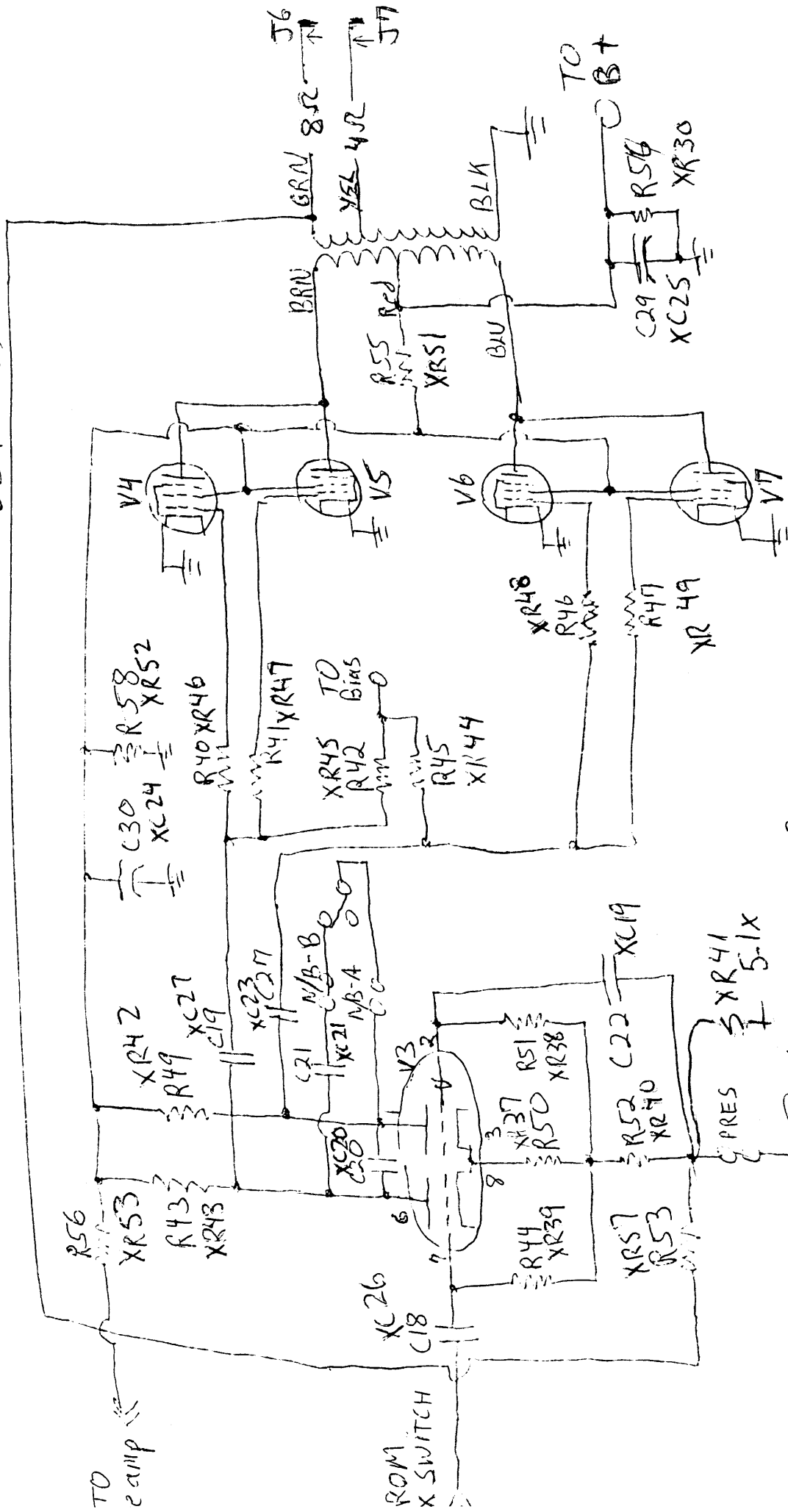

POWER AMP

9125

XC1827
110 22 NR9
PRES

PHASE INVERTER

12V 1240 VR9
100 1240 VR9
PRES

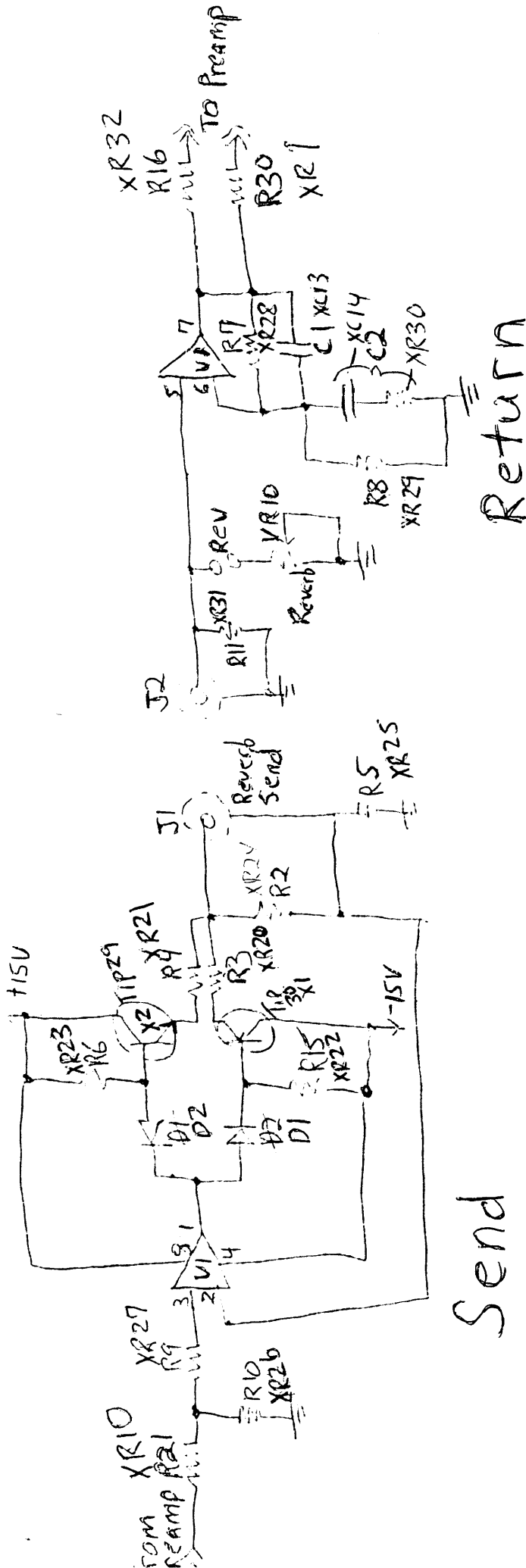

Send

Bedrock 600 Reverb

Return

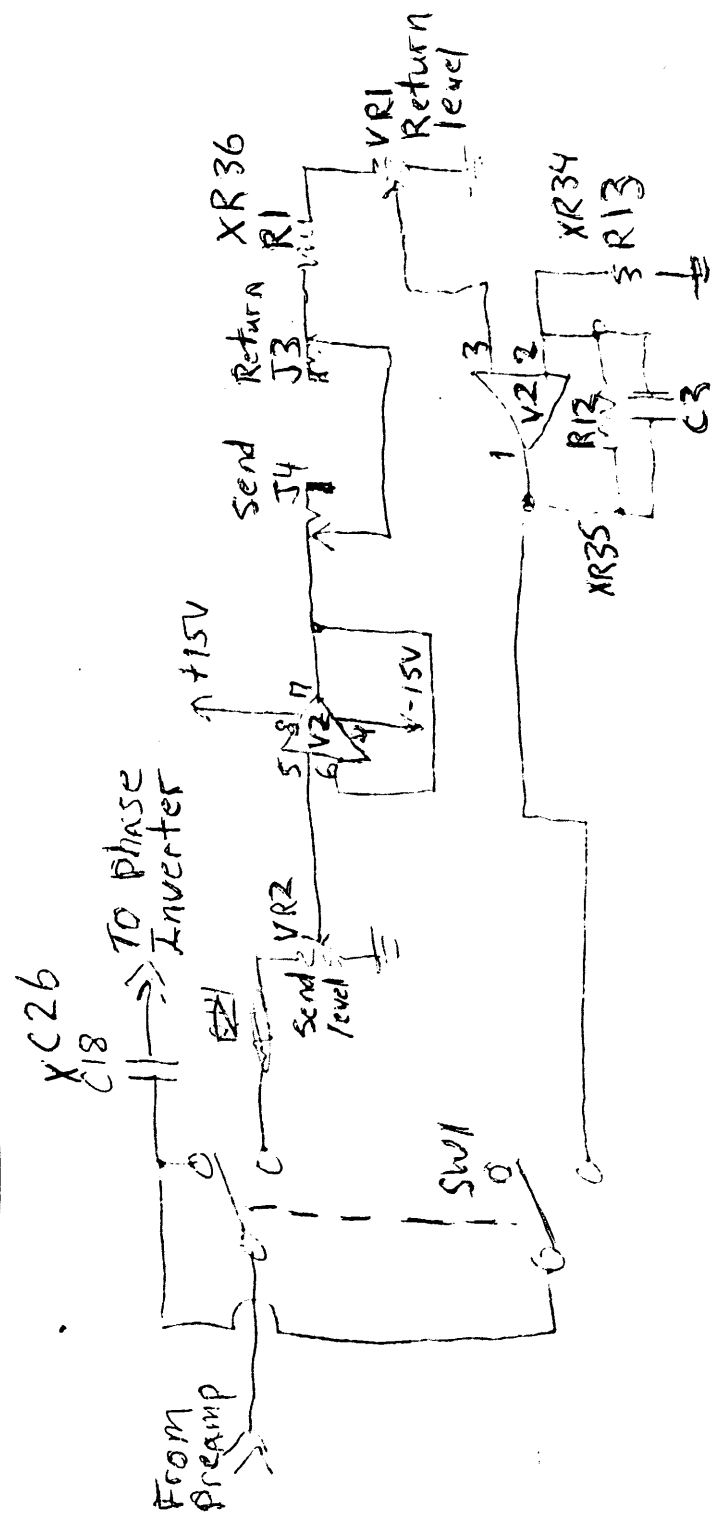

Bedrock
600
FX LOOP

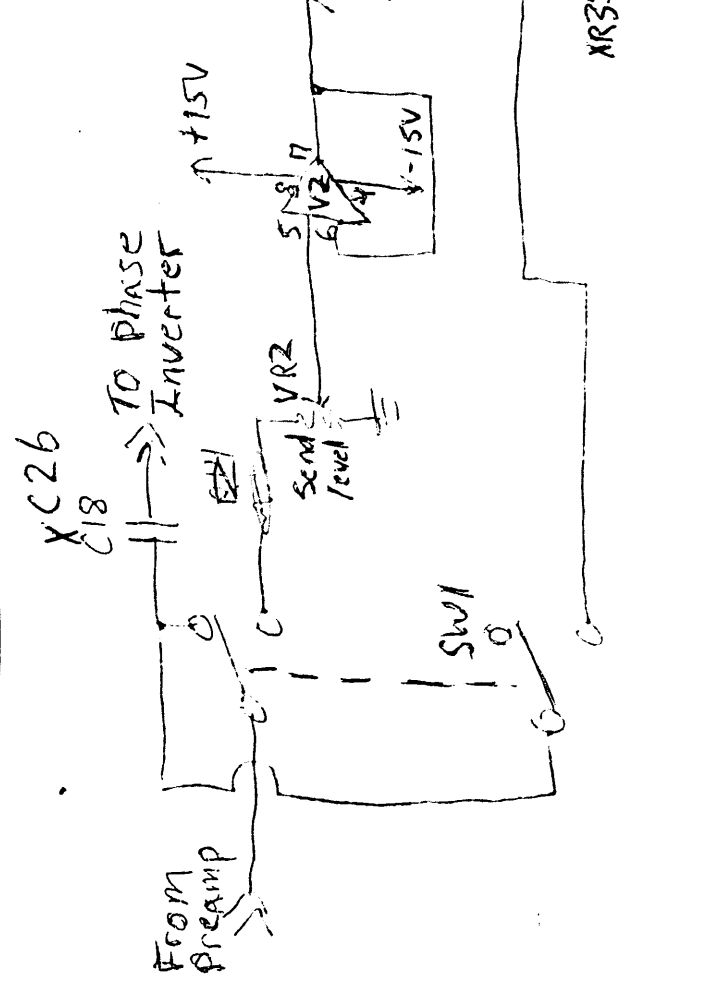

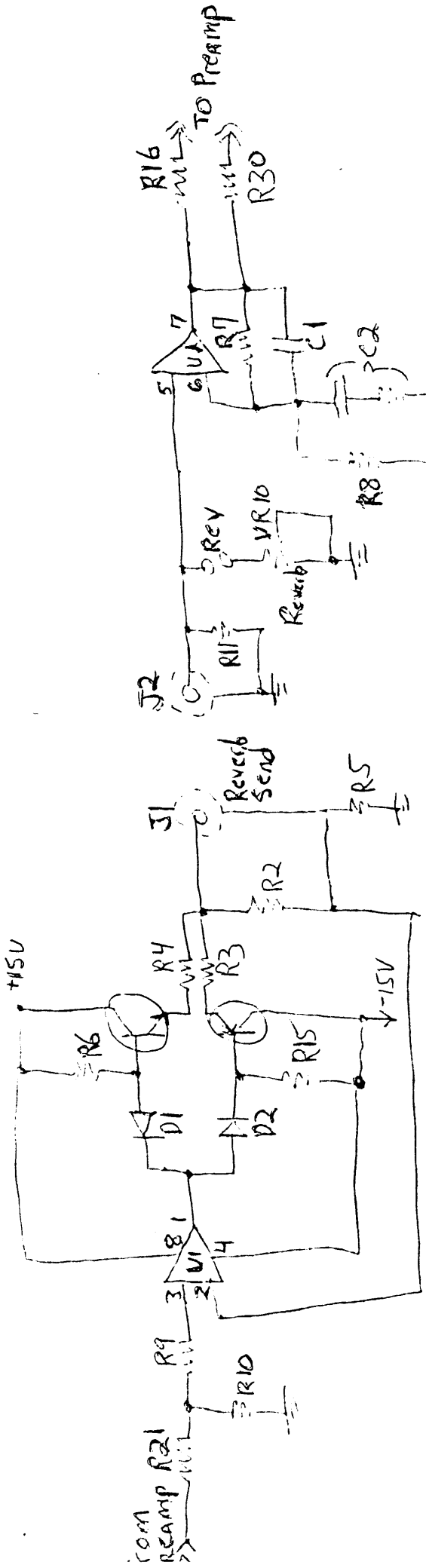

Send Bedrock 600 Reverb Return

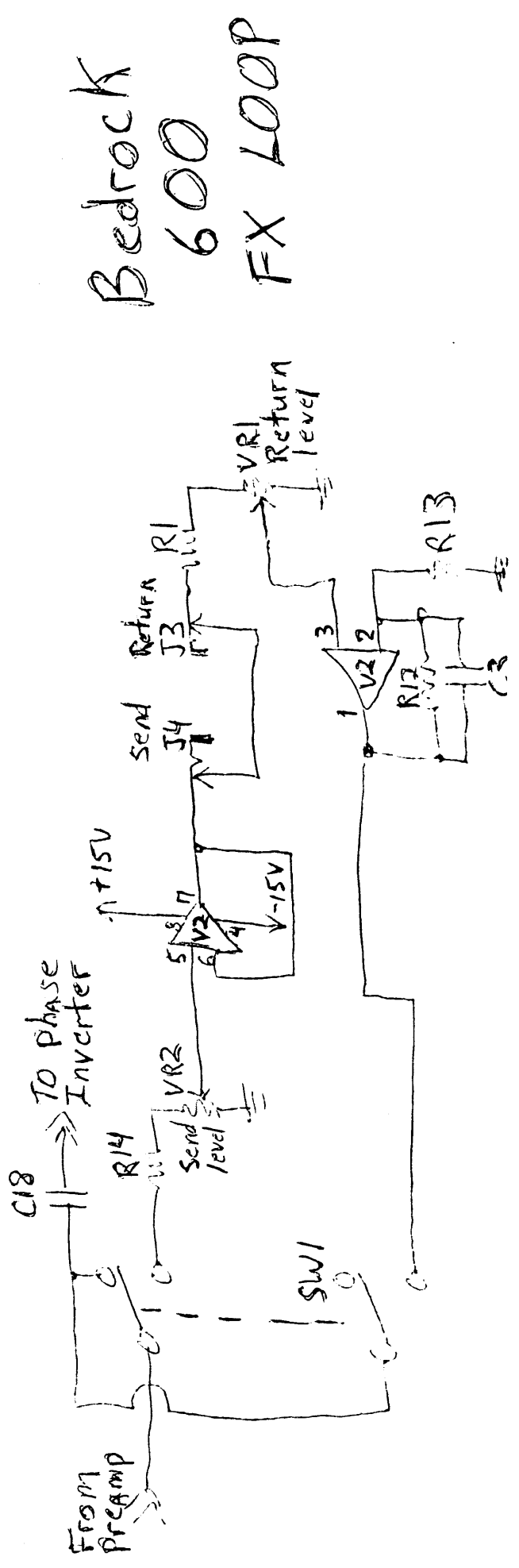

Bedrock 600 FX LOOP

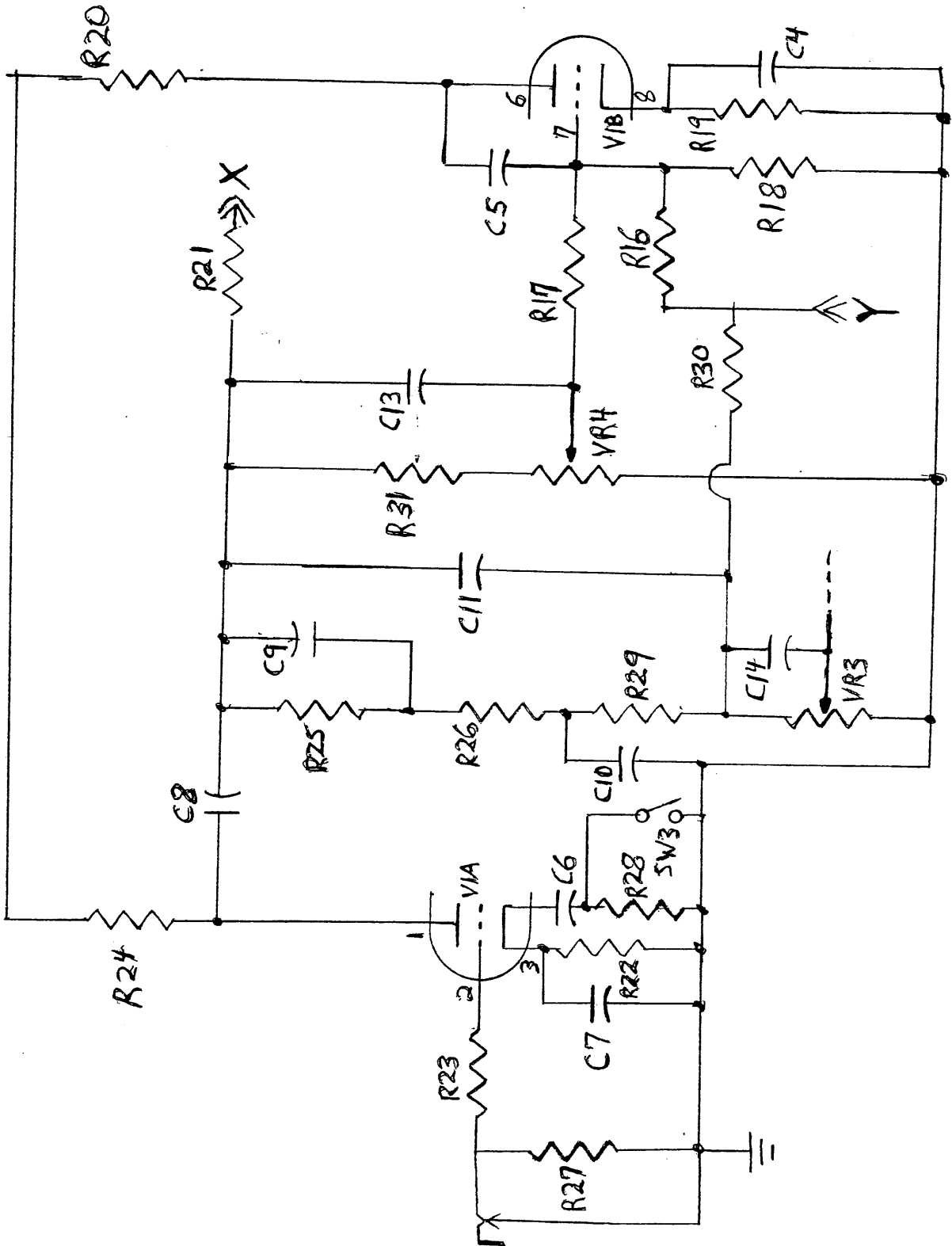

Pre-Amp up to Reverb Send/Return
 BOARD A REV B

Bedrock 600

6BQ5 x(4)

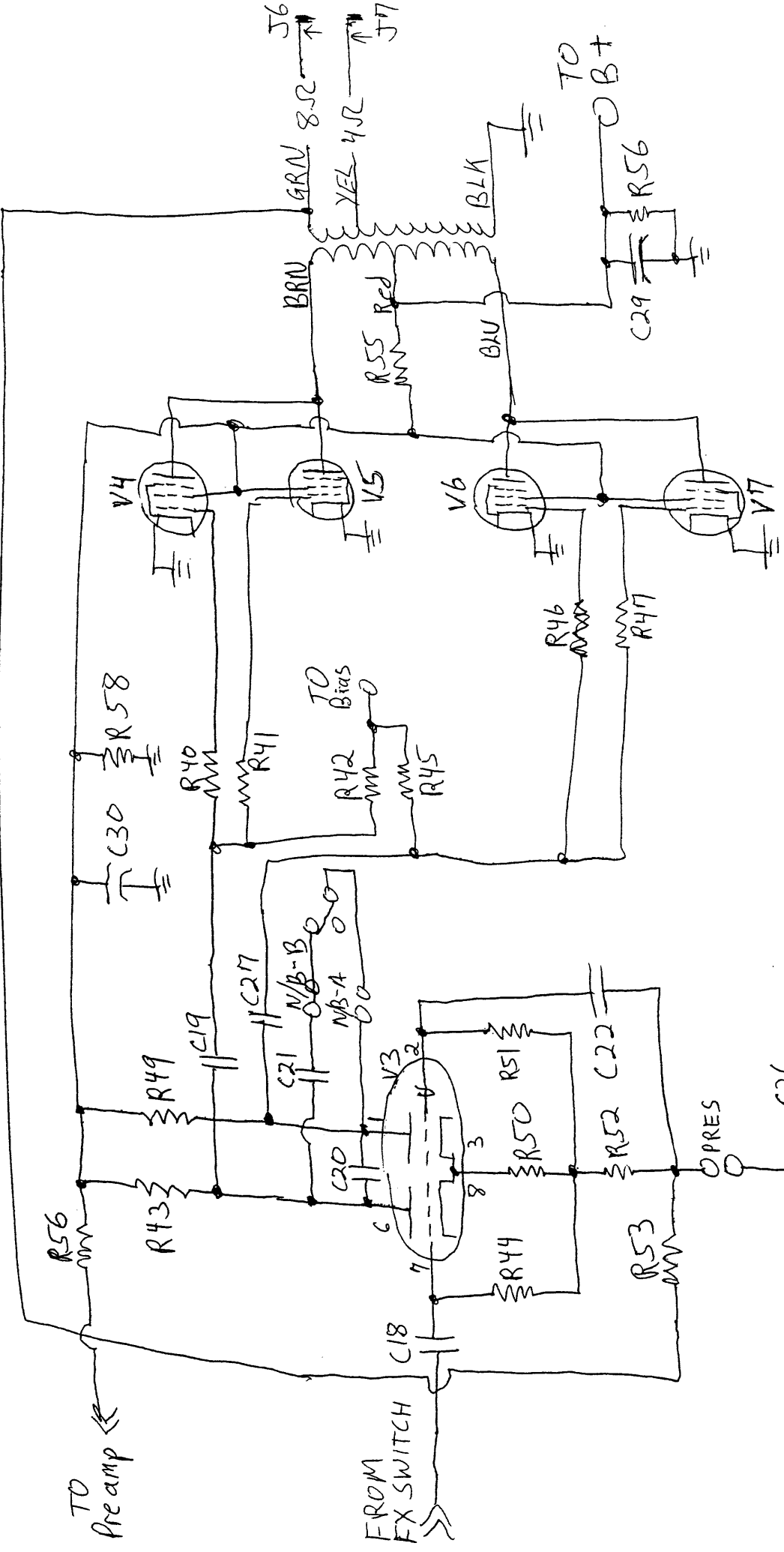

POWER AMP

PHASE INVERTER

TO Pre amp

FROM EX SWITCH

TO B+

Presence

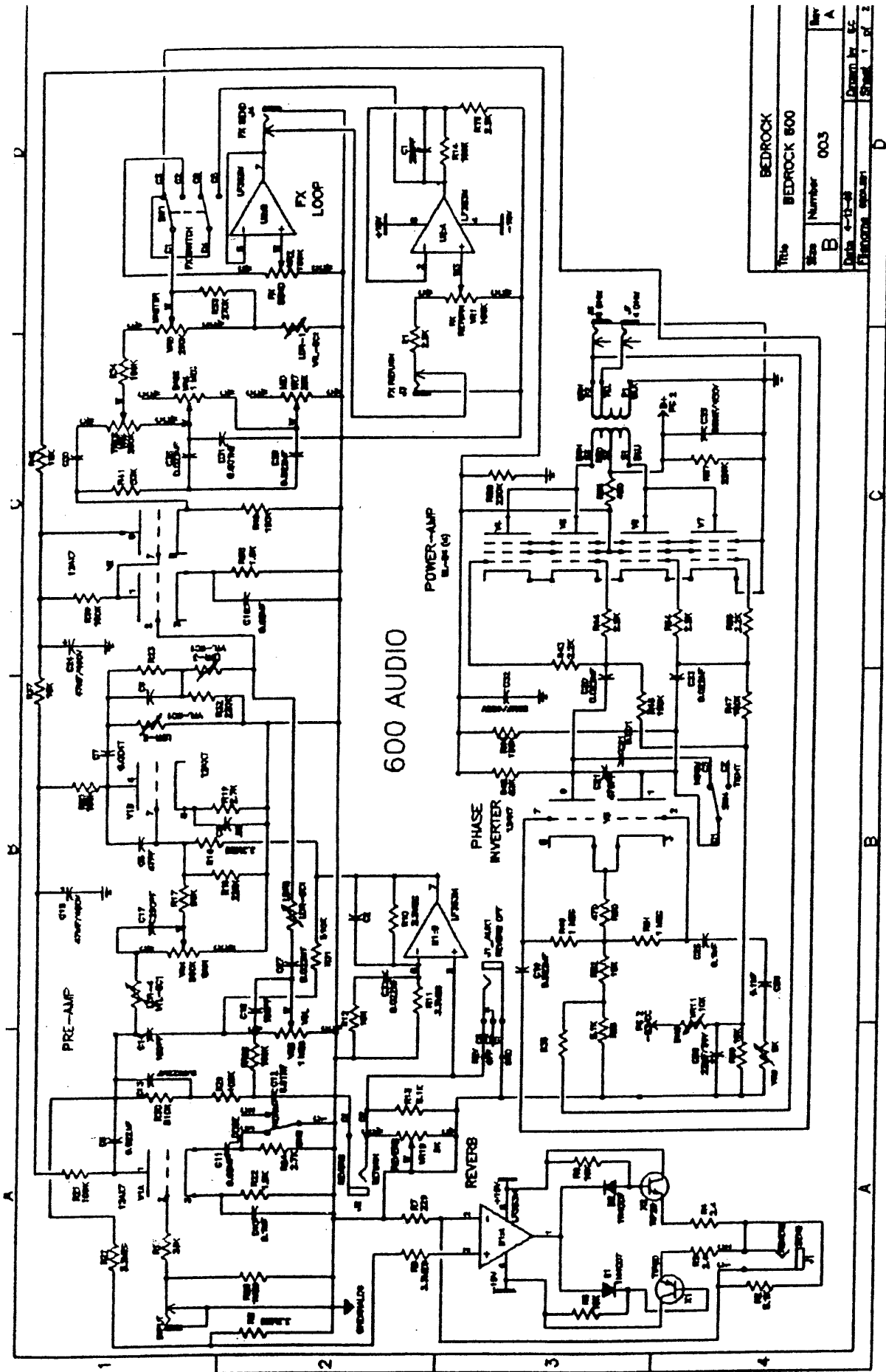

BEDROCK	
Title	BEDROCK 600
Size	Number 003
Rev	A
Date	6-13-68
Drawn by	GC
Checked by	D
Sheet	1 of 2

Ref Designator	Pattern	Type	Value
----------------	---------	------	-------

R43	RES600		82K/1/2W
R44	RES600		1MEG/1/2W
R45	RES600		150K/1/2W
R46	RES600		2.2K/1/2W
R47	RES600		2.2K/1/2W
R48	RES600		10K/1/2W
R49	RES600		100K/1/2W
R50	RES600		470/1/2W
R51	RES600		1MEG/1/2W
R52	RES600		10K/1/2W
R53	RES600		82K/1/2W
R54	RES600		270/1/2W
R55	RES1200		470/5W
R56	RES1200		1K/5W
R57	RES800		220K/1W
R58	RES800		220K/1W
R59	RES800		10K/1W
SW1	DPDT_ON-ON_RTAN		FX_SWITCH
SW2	SPDT_SW_STRAIGH		CHANNEL_SW
SW3	SPDT_SW_STRAIGH		NORM/LOOSE
SW4	SPDT_SW_STRAIGH		NORM/TIGHT
U1	DIP8		TL072
U2	DIP8		TL072
V1	9PINTUBE		
V2	9PINTUBE		
V3	9PINTUBE		
V4	9PINPOWER		
V5	9PINPOWER		
V6	9PINPOWER		
V7	9PINPOWER		
VR1	POT/1000/600/PC	FX RETURN	100KB
VR2	POT/1000/600/PC	FX SEND	100KB
VR3	POT_RT_ANGLE	CLEAN GAIN	1MEGA
VR4	POT_RT_ANGLE	LEAD DRIVE	1MEGA
VR5	POT_RT_ANGLE	MASTER	250KB
VR6	POT_RT_ANGLE	BASS	1MEGA
VR7	POT_RT_ANGLE	MID	25KB
VR8	POT_RT_ANGLE	TREBLE	250KB
VR9	POT_RT_ANGLE	PRESENCE	5KB
VR10	POT_RT_ANGLE	REVERB	5KB
VR11	POT/PCB/SMALL		10K/VAR
X1	TO_220		TIP_30
X2	TO_220		TIP_29
X3	TO_220		LM340+15
X4	TO_220		LM320-15