

SCHEMATIC DIAGRAM K-20

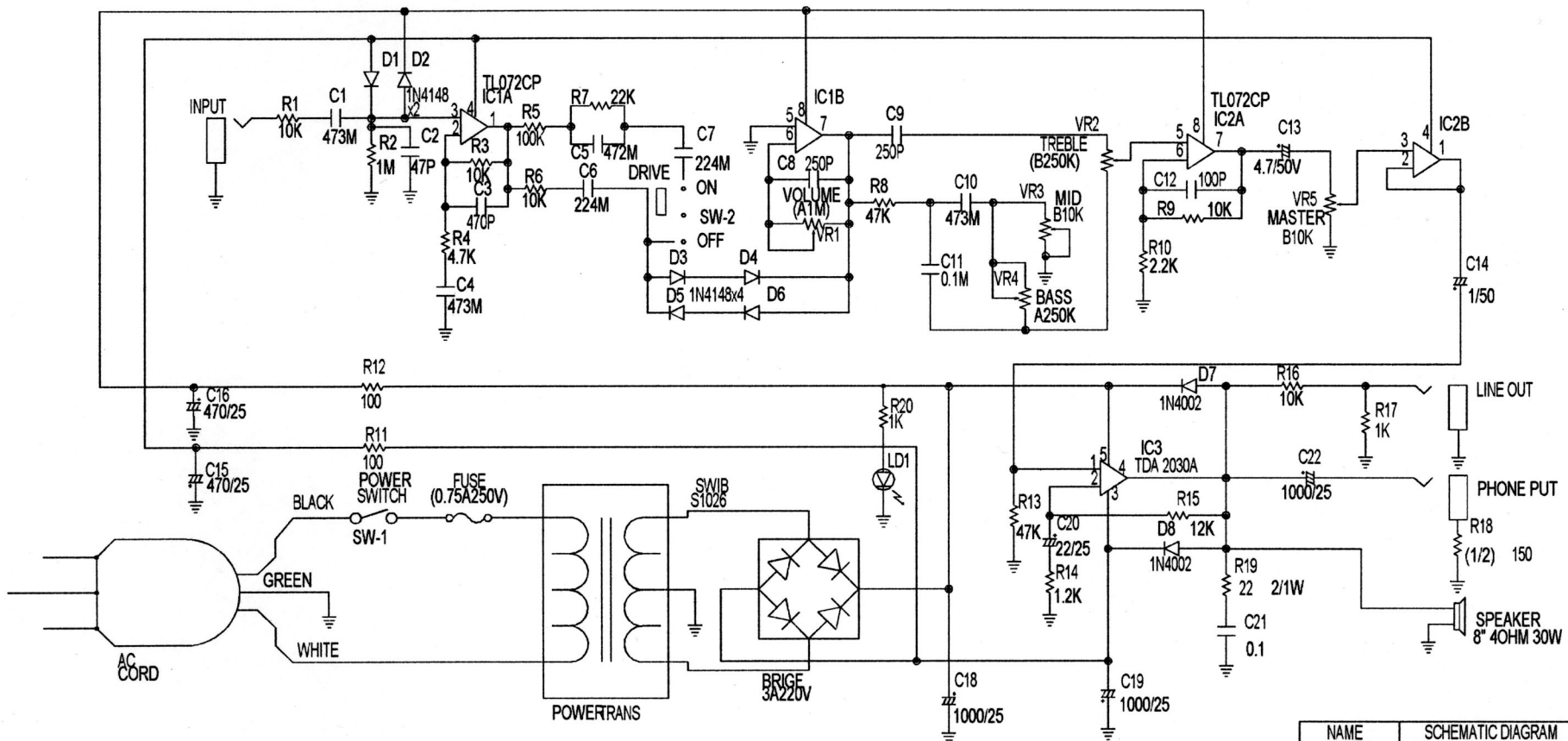

NAME		SCHEMATIC DIAGRAM	
MODEL NO.		K-20	
DRAWN		CHECKED	APPROVED