

SCHEMATIC DIAGRAM K-20B

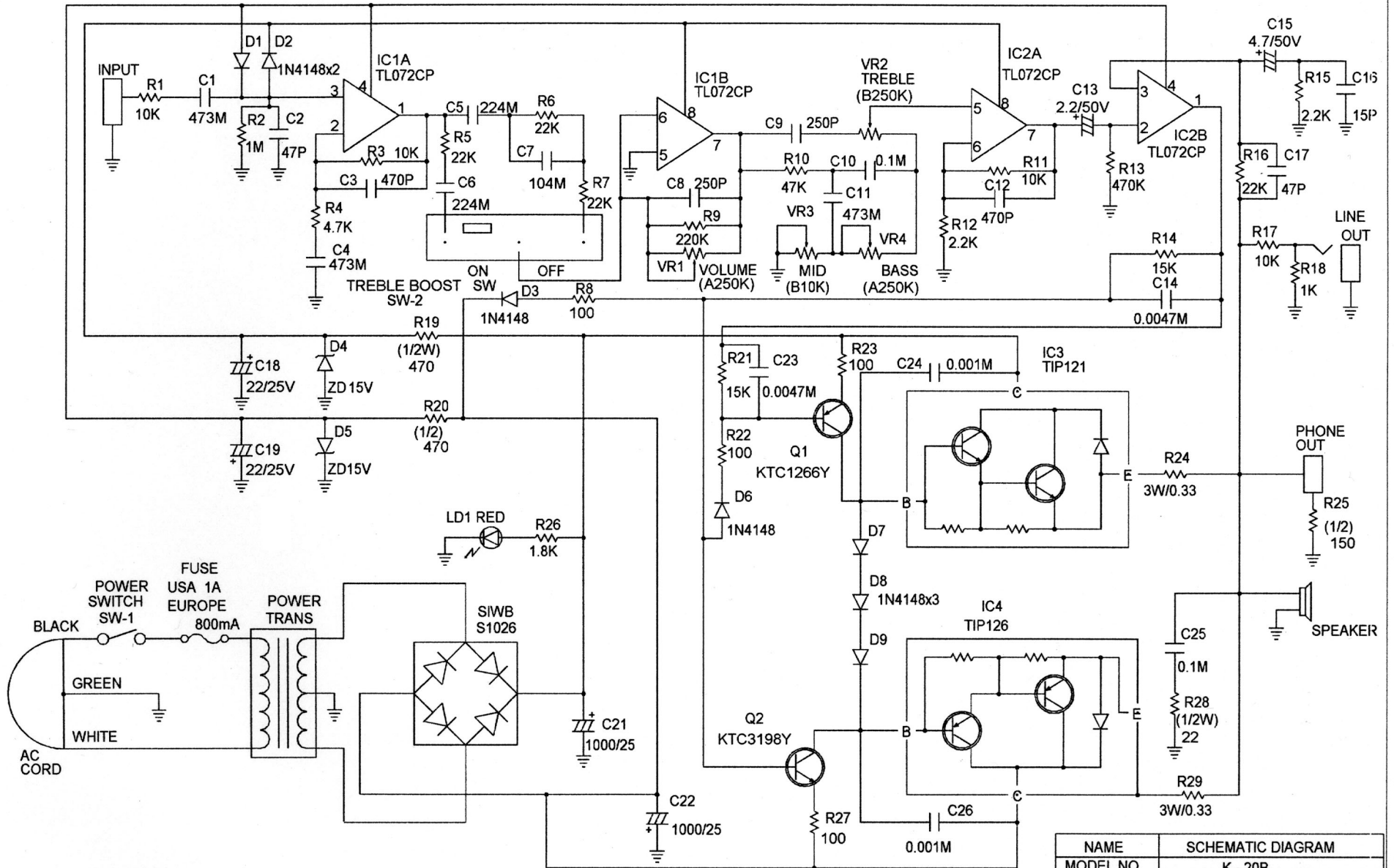

NAME		SCHEMATIC DIAGRAM	
MODEL NO.	K - 20B		
DRAWN	CHECKED	APPROVED	