

SCHEMATIC DIAGRAM K-300B

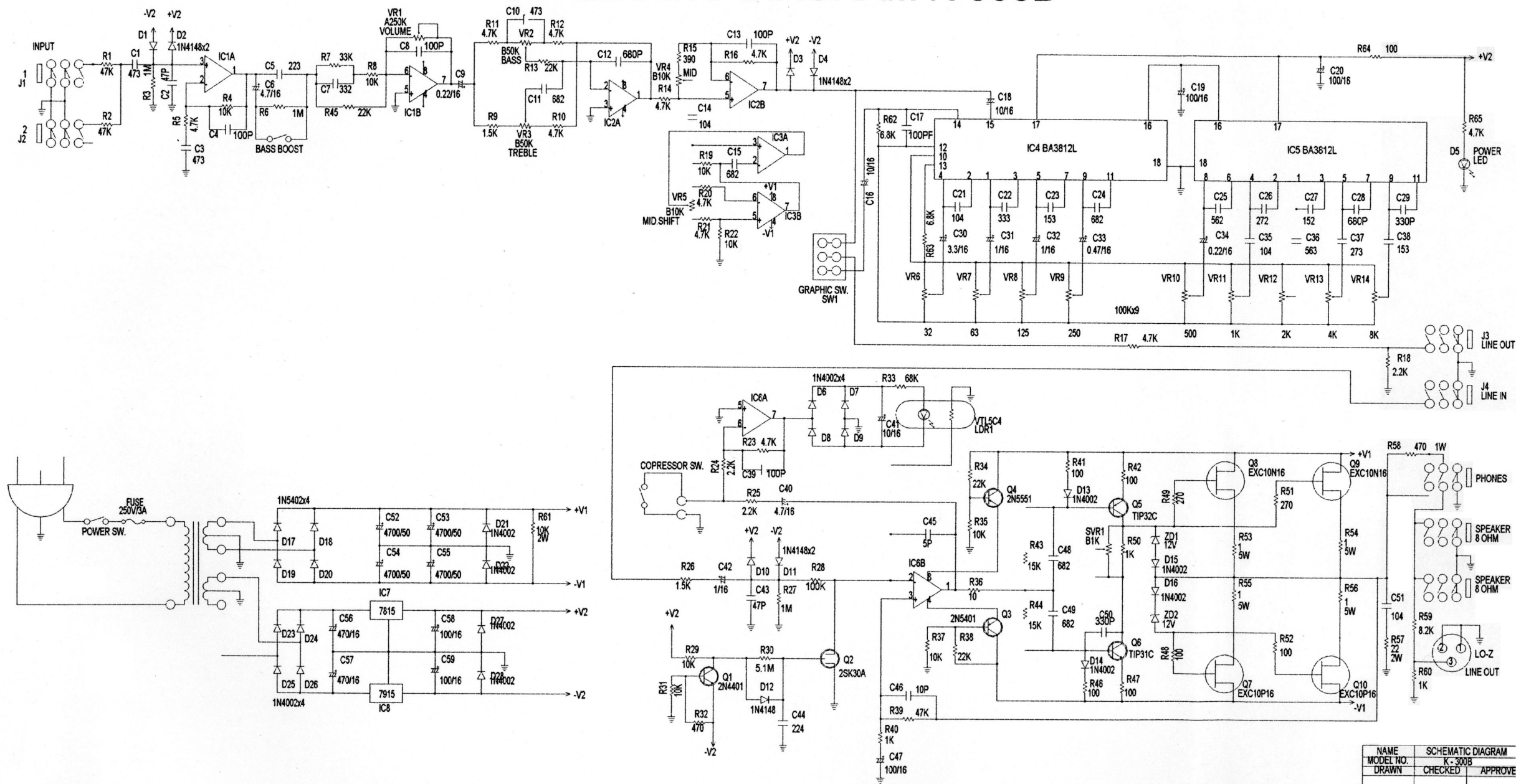

NAME	SCHEMATIC DIAGRAM	
MODEL NO.	K-300B	
DRAWN	CHECKED	APPROVED