

Ludwig

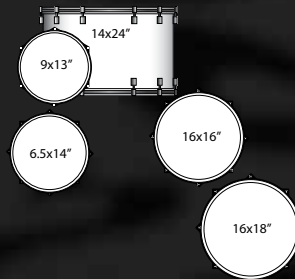

Legacy Exotic Black Limba Oliveburst w/ brass hardware*

14x24" bass drum, Classic lugs, Curved Spurs, no mount (LLB444XXL4WCB)
16x18" floor tom, Classic lugs, Classic Brackets (LLF468LXL4WCB)
16x16" floor tom, Classic lugs, Classic Brackets (LLF466LXL4WCB)
9x13" tom, Vibraband with Classic Bracket (LLT493XXL4WCRB)
6.5x14" snare, Millennium Strainer, Tube lugs (LLS464TDL4WMB)

*Brass hardware availability is a custom option and is limited by size and option type. Consult your Ludwig Dealer for more details.

AV8142

Ludwig

Ludwig Drum Company
P.O. Box 110, Elkhart, IN 46515
www.ludwig-drums.com

DRUMS & HARDWARE



Alex Van Halen photo credit © John Douglas.

Welcome, once again, to the world of Ludwig Percussion. Inside this catalog, you will find a wide variety of drums to suit the needs of every drummer. Last year we were fortunate enough to celebrate Ludwig's 100 years of drum making, and now, we enter into our second century with an even greater enthusiasm!

We work hard to live up to the standards set by William F. Ludwig, Sr. and William F. Ludwig, II. The Ludwig legacy was built on exceedingly high standards in craftsmanship, innovation, and a commitment to surpass the needs of every percussionist. The Ludwig staff is a group of drummers and percussionists who are 100% committed to these same, time-tested ideals. We focus daily on improving instrument designs, acoustics, manufacturing process, quality and, most importantly, customer satisfaction.

We welcome you to the "Ludwig Family" and encourage you to take a tour of the products we offer. Whether you are searching for a starter drum set, or for that one snare that has eluded your collection for years, we are confident that Ludwig has something for you. Now, a century after it all began, we remain proud to be an American company competing in a global market, and we thank you, the Ludwig customer!

Thanks for keeping us *The Most Famous Name On Drums!*

Sincerely,

Grant Henry

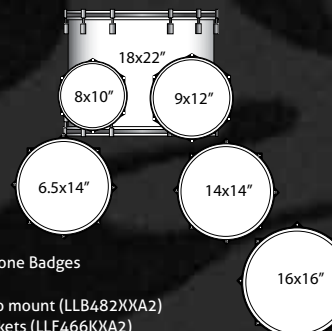

THIS PAGE

Legacy Exotic Sumauma Black/Natural Burst, Keystone Badges

- 18x22" bass drum, Mini-Classic lugs, Elite Spurs, no mount (LLB482XXA2)
- 16x16" floor tom, Mini-Classic lugs, Keystone Brackets (LLF466KXA2)
- 14x14" floor tom, Mini-Classic lugs, Keystone Brackets (LLF444KXA2)
- 9x12" tom, Mini-Classic lugs, Vibraband with Keystone Bracket (LLT492XXA2WR)
- 8x10" tom, Mini-Classic lugs, Vibraband with Keystone Bracket (LLT480XXA2WR)
- 6.5x14" snare, Millennium Strainer, tube lugs LL5464TXA2WM

LEGACY EXOTIC

SERIES DRUMS

TOMORROW'S VINTAGE, TODAY

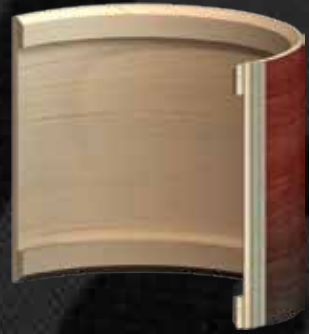

SHELL

Exotic Veneer over 1/32" Maple Outer Ply, 1/8" American Poplar Core Ply, 1/16" Maple Inner Ply, 1/8" Solid Maple Reinforcement Rings.

By applying many of the same shell-making properties we have refined over the past century, Ludwig is proud to introduce Legacy Exotic, a stunning rethink to a modern classic. This flagship professional drum line employs the 3-ply combination of inner and outer North American Maple and the traditional single Poplar core ply with solid Maple reinforcement rings; forging a rich sonic warmth that is unheard of in the tonal spectrum.

COMPONENT DRUMS (snare drums on next page)

BASS DRUMS		
Diameter	Depth	Model
18"	14"	LLB348XX
	16"	LLB368XX
20"	14"	LLB340XX
	16"	LLB360XX
	18"	LLB380XX
	20"	LLB300XX
22"	14"	LLB342XX
	16"	LLB362XX
	18"	LLB382XX
	20"	LLB302XX
24"	14"	LLB344XX
	16"	LLB364XX
	18"	LLB384XX
	20"	LLB304XX
26"	14"	LLB346XX
	16"	LLB366XX

FLOOR TOMS		
Diameter	Depth	Model
14"	12"	LLF324XX
	14"	LLF344XX
15"	13"	LLF335XX
	14"	LLF345XX
16"	13"	LLF336XX
	14"	LLF346XX
	15"	LLF356XX
	16"	LLF366XX
18"	16"	LLF368XX

TOMS		
Diameter	Depth	Model
10"	7"	LLT370XX_WR
	8"	LLT380XX_WR
12"	9"	LLT390XX_WR
	8"	LLT382XX_WR
	9"	LLT392XX_WR
13"	10"	LLT302XX_WR
	12"	LLT322XX_WR
	9"	LLT393XX_WR
	10"	LLT303XX_WR
14"	11"	LLT313XX_WR
	12"	LLT323XX_WR
	10"	LLT304XX_WR
	11"	LLT314XX_WR
15"	12"	LLT324XX_WR
	13"	LLT334XX_WR
	14"	LLT344XX_WR
	12"	LLT325XX_WR
16"	13"	LLT335XX_WR
	14"	LLT345XX_WR
	13"	LLT336XX_WR
	14"	LLT346XX_WR
15"	15"	LLT356XX_WR
	16"	LLT366XX_WR

ROUNDED BEARING EDGE

Legacy's rounded bearing edge draws full, focused lows from inner and outer Maple plies and cuts unwanted overtones for superior tone and clarity.

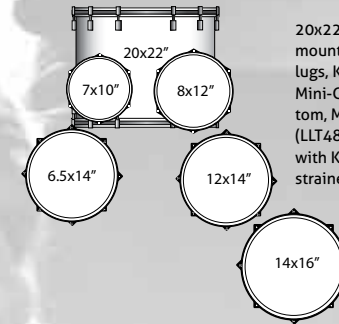

Legacy Exotic Sumauma Deep Brown Fade, 100th Anniversary Badges

20x22" bass drum, Mini-Classic lugs, Curved Spurs, no mount (LLB402XXA4WB), 14x16" floor tom, Mini-Classic lugs, Keystone Brackets (LLF446KXA4), 12x14" floor tom, Mini-Classic lugs, Keystone Brackets, (LLF424KXA4), 8x12" tom, Mini-Classic lugs, Vibraband with Keystone Bracket (LLT482XXA4WR), 7x10" tom, Mini-Classic lugs, Vibraband with Keystone Bracket (LLT470XXA4WR), 5x14" snare, P-85 strainer, tube lugs (LLS464TXA4)

© Matt Sorum photo credit © Clay Greene.

*Outfits shown do not include cymbals or hardware

LEGACY EXOTIC

SERIES DRUMS

Legacy Exotic Black Limba Supernatural, 100th Anniversary Badges

18x22" bass drum, Classic lugs, Curved Spurs, no mount (LLB462XXL1WC8)
 16x16" floor tom, Classic lugs, Classic Brackets (LLF466LXL1WC)
 9x13" tom, Classic lugs, Vibraband with Classic Bracket (LLT493XXL1WR)
 6.5x14" snare, Millennium strainer, Classic lugs (LLS464XXL1WM)

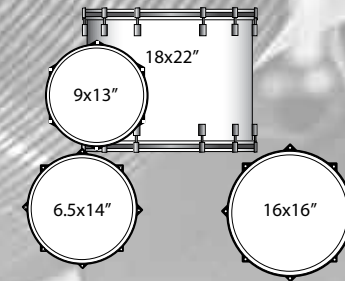

Legacy Exotic Black Limba Natural Mahogany, Keystone Badges

16x22" bass drum, Classic lugs, Curved Spurs, no mount (LLB462XXL1WC8)
 16x16" floor tom, Classic lugs, Classic Brackets (LLF466LXL1WC)
 9x13" tom, Classic lugs, Vibraband with Classic Bracket (LLT493XXL1WR)
 6.5x14" snare, Millennium strainer, Classic lugs (LLS464XXL1WM)

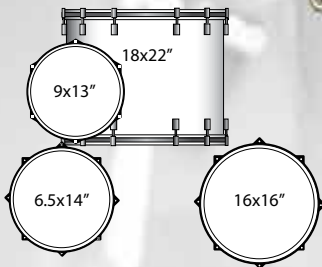

*Outfits shown do not include cymbals or hardware

BLACK LIMBA

Origin: Africa

The most complex of the Legacy veneers, African black limba's vertical grain is offset by its vibrant diagonal quilting pattern.

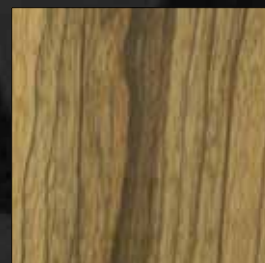

LEGACY EXOTIC BLACK LIMBA FINISHES



Tequilla Sunrise



Supernatural



Oliveburst



Natural Mahogany Burst

LEGACY EXOTIC SNARE DRUMS

SNARE DRUMS		
Diameter	Depth	Model
14"	3.5"	LLS334XX
	5"	LLS354XX
	6.5"	LLS364XX
	8"	LLS384XX

LEGACY EXOTIC

SERIES DRUMS

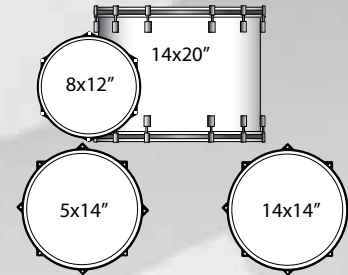

Legacy Exotic Sumauma Supernatural, Keystone Badges

14x20" bass drum, Mini-Classic lugs, Elite Spurs, no mount (LLB440XXA1), 14x14" floor tom, Mini-Classic lugs, Keystone Brackets (LLF444KXA1), 8x12" tom, Mini-Classic lugs, Vibraband with Keystone Bracket (LLT482XXA1WR), 5x14" snare, Millennium strainer, Classic lugs (LLS454XXA1WM)

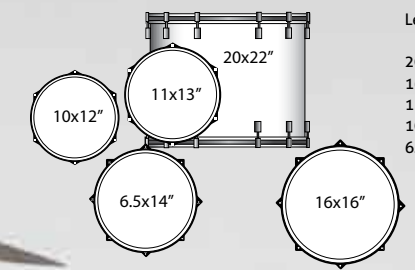

Legacy Exotic Lacewood Supernatural, 100th Anniversary Badges

20x22" bass drum, Mini-Classic lugs, Elite Spurs, no mount (LLB402XXS2), 16x16" floor tom, Mini-Classic lugs, Keystone Brackets (LLF466KXS2), 11x13" tom, Vibraband with Keystone Bracket (LLT413XXS2WR), 10x12" tom, Vibraband with Keystone Bracket (LLT402XXS2WR), 6.5x14" snare, Millennium strainer, Classic one-piece lugs (LLS464XXS2WM)



*Outfits shown do not include cymbals or hardware

SUMAUMA

Origin: Brazil
A dark Amazon hardwood with a deep horizontal grain, Sumauma's marbled textural figuring compliments its complex visual variation.

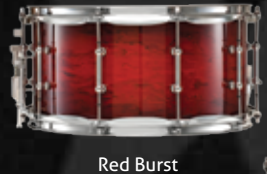
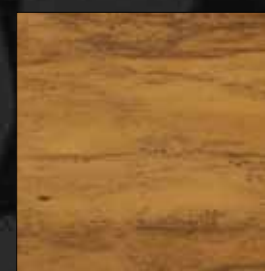

Red Burst



Supernatural



Deep Brown Fade



Natural Burst

LACEWOOD

Origin: Australia
A hardwood with orange and brown hues and a complex, shifting quilted nature. The heavy grain in Lacewood is likened to fish scales, in that it appears to "move" when light catches it.



Gatorfade



Supernatural



Mahogany Fade



Honey Burst

LEGACY CLASSIC

SERIES DRUMS

A TRUE AMERICAN CLASSIC

Tradition, Craftsmanship and Visionary Excellence; these are the values at the center of Ludwig's classic legacy. With these values comes a commitment as true as the care and pride that goes into each drum, hand-crafted at Ludwig's manufacturing facility in Monroe, North Carolina.

Combining the benefits of today's most advanced manufacturing processes with the experience that comes with a century of drum making, Ludwig's Legacy Classic Series revive the distinctive sound of the world's most famous drums. These custom-built American-made drums are a modern interpretation of the legendary Ludwig shells that set the standard for popular music throughout the 20th Century.



Vintage-style wrap over 1/16" Maple Outer Ply, 1/8" American Poplar Core Ply, 1/16" Maple Inner Ply, 1/4" Solid Maple Reinforcement Rings.

Legacy Classic shells are made from choice cuts of hand-selected North American hardwoods. A core ply of premium Poplar yields warmth and resonance while cross-laminated inner and outer plies of Maple deliver power and clarity. This proven design is then augmented with 1/4" single-ply Maple reinforcement hoops and rounded classic-cut bearing edges for thundering lows and pronounced articulation, suitable for any musical style.

Not merely a blast from the past, Legacy drums take full advantage of state-of-the-art manufacturing techniques with rigorous attention to detail. The Legacy Classic Series are now available in expanded sizes and finish options for the consummate professional.

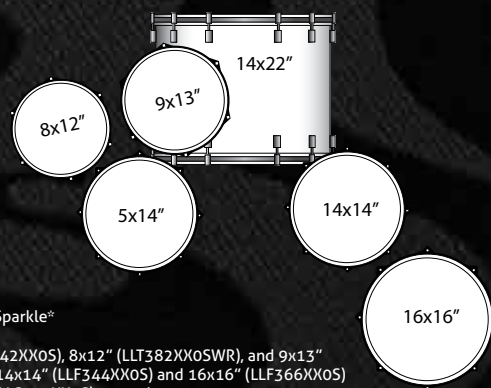

Legacy Classic in Silver Sparkle*

14x22" bass drum (LLB342XX0S), 8x12" (LLT382XX0SWR), and 9x13" (LLT393XX0SWR) toms, 14x14" (LLF344XX0S) and 16x16" (LLF366XX0S) floor toms and a 5x14" (LLS354XX0S) snare drum

Jason McGarr photo credit © Jason McGarr.



*Outfits shown do not include cymbals or hardware

THE BUN E. CARLOS LEGACY CLASSIC SIGNATURE DRUM KIT

Since 1909, Ludwig has been making exceptionally crafted percussion products for drummers of all styles. In our 101st year, we pay tribute to an artist that helped make us great.

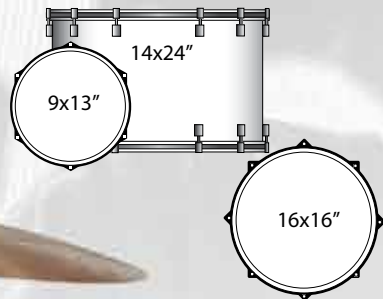

BASS DRUMS		
Diameter	Depth	Model
18"	14"	LLB348XX
	16"	LLB368XX
20"	14"	LLB340XX
	16"	LLB360XX
	18"	LLB380XX
	20"	LLB300XX
22"	14"	LLB342XX
	16"	LLB362XX
	18"	LLB382XX
	20"	LLB302XX
24"	14"	LLB344XX
	16"	LLB364XX
	18"	LLB384XX
	20"	LLB304XX
26"	14"	LLB346XX
	16"	LLB366XX

FLOOR TOMS		
Diameter	Depth	Model
14"	12"	LLF324XX
	14"	LLF344XX
15"	13"	LLF335XX
	14"	LLF345XX
16"	13"	LLF336XX
	14"	LLF346XX
	15"	LLF356XX
18"	16"	LLF366XX
	16"	LLF368XX

SNARE DRUMS		
Diameter	Depth	Model
14"	3.5"	LLS334XX
	5"	LLS354XX
	6.5"	LLS364XX
	8"	LLS384XX

TOMS		
Diameter	Depth	Model
10"	7"	LLT370XX_WR
	8"	LLT380XX_WR
	9"	LLT390XX_WR
12"	8"	LLT382XX_WR
	9"	LLT392XX_WR
	10"	LLT302XX_WR
	12"	LLT322XX_WR
13"	9"	LLT393XX_WR
	10"	LLT303XX_WR
	11"	LLT313XX_WR
	12"	LLT323XX_WR
14"	10"	LLT304XX_WR
	11"	LLT314XX_WR
	12"	LLT324XX_WR
	13"	LLT334XX_WR
15"	14"	LLT344XX_WR
	12"	LLT325XX_WR
	13"	LLT335XX_WR
	14"	LLT345XX_WR
16"	13"	LLT336XX_WR
	14"	LLT346XX_WR
	15"	LLT356XX_WR
	16"	LLT366XX_WR

VINTAGE PEARL AND SPARKLE WRAPS

Also available: Original Black Oyster Pearl (10)



NEW! BROKEN GLASS GLITTERS

Also available:
Citrus Mod Glass Glitter (CM),
see opposite page



*Outfits shown do not include cymbals or hardware

A companion shell set to his signature snare released in 2009, the Bun E. Carlos Signature drum kit features our new Citrus Glass Glitter finish, Bun E's personal badge, the Ludwig 100th Anniversary badge and is personally signed and numbered on the inner shell label. With only 50 being made, this very special Legacy Classic set will only be available for a limited time.



BUN E. CARLOS
BADGE



BUN E. CARLOS
SIGNED SIGNATURE
LABEL

STAINLESS STEEL

limited edition drums

VISION. TRADITION. PRECISION. POWER.

The 1970's were a time of great innovation at Ludwig's Damen Ave. facility. True to Ludwig's tradition of innovation, Stainless Steel kits were forged for unprecedented volume, sustain, and power in heavy music. Ludwig's new Anniversary Edition Stainless Steel Pro Beat outfit is a true testament to our timeless roots. Only 100 kits will be made available, all of them hand-rolled and tooled by Drumsmith Ronn Dunnett.

Ultra-thin 1.5mm stainless steel shells produce crystalline resonance throughout the drum. Together with precision-cut, pin-point bearing edges, enormous tone and volume is attained without brash overtones.

Choose from polished chrome steel finish with brass hardware or brushed stainless finish and chrome hardware.

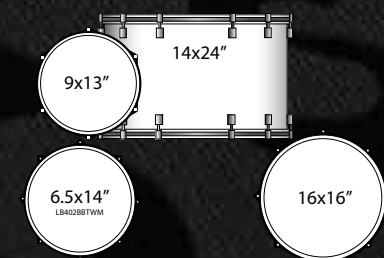

Anniversary Edition Stainless Steel 3-pc. Pro Beat Kit w/ Brass Hardware*

14x24" bass drum (LB844XXSSB), 16x16" floor tom (LF866XXSSB) and 9x13" tom (LT893LMSSB), shown with optional chrome plated brass snare (LB402BBTWM)

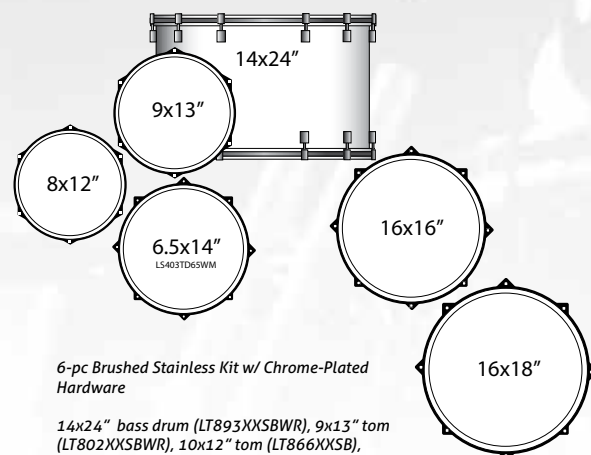

6-pc Brushed Stainless Kit w/ Chrome-Plated Hardware

14x24" bass drum (LT893XXSBWR), 9x13" tom (LT802XXSBWR), 10x12" tom (LT866XXSB), 16x16" floor tom (LF868XXSB) and 16x18" floor tom, shown with optional 6.5x14" snare drum LS403TD65WM



*Outfits shown do not include cymbals or hardware

Patrick Keeler photo credit © Ronn Dunnett.

Inspired by the drum construction from Ludwig's golden era, Classic Maple options are limited only by your imagination. With dozens of configurations, component sizes, current or classic hardware choices and finish possibilities, the player is completely in control of how the drum looks, plays and performs.

No matter the playing style or preference, Classic Maple takes the options that discerning players demand and puts them right in the pocket of the player. Each Classic Maple outfit or component drum can be custom configured to include hardware options to best suit any playing environment.



Proudly made in Monroe, North Carolina, Ludwig takes great care in selecting only the finest quality materials for Classic Maple drums.

This process starts with select North American maple. The maple is cut into panels. The outside panel is 1.8 mm thick, two ply, cross laminated maple. Cross lamination is the process in which the panels are made of two glued plies of wood, with the grain direction of one ply at 90 degrees in relation to the grain direction of the adjacent ply. The outside grain runs circumferential with the shell.

The center panel is 2.4 mm thick, three ply, cross laminated maple. The middle ply runs circumferential with the shell and the outer plies are at 90 degrees. The inside panel is 1.8 mm thick, two ply, cross laminated maple. The inside grain runs circumferential with the shell. This gives the 7-ply shells a total thickness of 6 mm.

The bearing edges are cut to a 45 degree angle within 1/16" from the outside edge. The sharp edges are rounded by light sanding for a smooth even surface. This process results in what is the unmistakable signature Ludwig sound.

CLASSIC MAPLE

COMPONENTS & FINISHES

BASS DRUMS			TOMS			
Diameter	Depth	Model	Diameter	Depth	Model	
18"	14"	LB848	6"	6"	LT886	
	16"	LB868		8"	7"	LT878
20"	14"	LB840	8"		8"	LT889
	16"	LB860		10"	7"	LT870
	18"	LB880			8"	LT880
22"	14"	LB842	12"	9"	LT890	
	16"	LB862		8"	LT882	
	18"	LB882		9"	LT892	
	20"	LB802		10"	LT802	
24"	14"	LB844	13"	12"	LT812	
	16"	LB864		9"	LT893	
	18"	LB884		10"	LT803	
	20"	LB804		11"	LT813	
26"	14"	LB846	14"	12"	LT823	
	16"	LB866		10"	LT804	
			14"	11"	LT814	
				12"	LT824	
				13"	LT834	
			15"	12"	LT825	
				13"	LT835	
			16"	14"	LT845	
				13"	LT836	
			16"	14"	LT846	
				16"	LT866	

FLOOR TOMS		
Diameter	Depth	Model
14"	12"	LF824
	14"	LF844
15"	13"	LF835
	14"	LF845
16"	14"	LF846
	16"	LF866
18"	16"	LF868

Choose from 25 eye-catching finishes varying from Vintage Pearl and Sparkle Wraps, Gloss Lacquers and exclusive Exotic Veneers, all of which demand attention.

EXOTIC VENEERS



Waterfall Bubinga (53) Birdseye Maple (50) Quilted Makoré (68)



Arctic Glitter (70) Ruby Glitter (71)

VINTAGE PEARL AND SPARKLE WRAPS

Also available: Original Black Oyster Pearl (1Q)



White Marine Pearl (0P) Black Oyster Pearl (0Q) Black Diamond Pearl (0B) Sunset Diamond Pearl (77) Silver Sparkle (0S) Black Sparkle (0R) Red Sparkle (27)



Gold Sparkle (33) Green Sparkle (54) Blue Sparkle (32) Champagne Sparkle (0C) Indigo Sparkle (88) White Cortex (0F) Black Cortex (0G)



Green (1E) Blue (1S) Red (1R) Orange (1F) Gold (1G)



Silver (1V) Black (1B) Burgandy (1D) Deep Blue (2S) Psychedelic Red (1P)

NEW! BROKEN GLASS GLITTERS

Also available: Citrus Mod Glass Glitter (CM), see page 11

GLOSS LACQUERS FINISHES



Cherry Stain (0L) Charcoal Shadow (0Y) Purple Shadow (0A) Sable (0T) Natural Maple (0N) Mahogany Stain (0M)

CLASSIC MAPLE

SERIES DRUMS

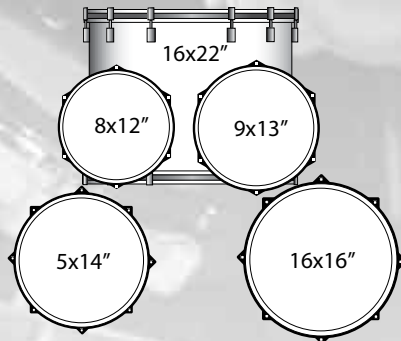

BIG BEAT

L8625EM (w/ hardware)
L8625EX (shell pack)

Features: Elite floor tom legs and brackets, Mini-Classic lugs, Elite spurs, Elite tom brackets with add-on tom holders, 900 Series stands, LM815FPR Pro bass pedal, Supra-Phonic snare drum

Shown in Quilted Makoré with optional Vibra-Bands.

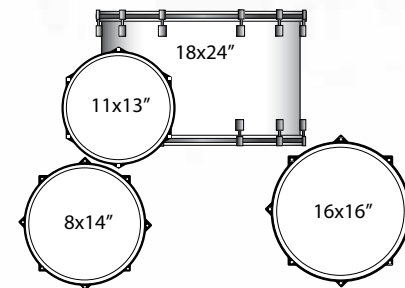

POWER 4

L8444LM (w/ hardware)
L8444LX (shell pack)

Features: Classic floor tom legs and brackets, heavy duty curved spurs, 900 Series double braced stands, LM815FPR Pro bass pedal, vintage logo bass head, matching snare drum

Shown in Indigo Sparkle with optional Classic lugs.

BASS DRUM LEGS

Choose from Classic Curved spurs or Elite Telescoping spurs.



LUGS

Choose from Mini-Classic, Classic or single-piece "Long" lugs.



BADGES

The Keystone, Ludwig's Company Icon, is standard on all Classic Maple Drums and Components.



The oval badge replicates one of Ludwig & Ludwig's earliest badge designs from the 1920's and comes standard on Classic Maple drums with exotic finishes.



DRUMHEADS

All Legacy and Classic Maple drums come standard with Ludwig WeatherMaster heads. Made in the USA since 1959, WeatherMaster features our exclusive Headlock System and low-profile collar for even tuning and high-impact durability.

CLASSIC MAPLE

SERIES DRUMS

2 UP 2 DOWN

L8646EM (w/ hardware)
L8646EX (shell pack)

Features: Elite floor tom legs and brackets, Mini-Classic lugs, Elite spurs, Elite tom brackets with add-on tom holders, 900 Series stands, LM815FPR Pro bass pedal, matching snare drum

Shown in Gold Sparkle with optional Vibra-Bands.

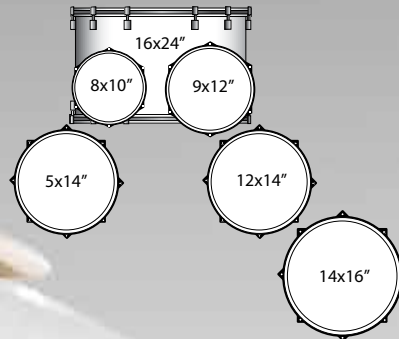

FAST 5

L8725EM (w/ hardware)
L8725EX (shell pack)

Features: Elite floor tom legs and brackets, Mini-Classic lugs, Elite spurs, Elite tom brackets with add-on tom holders, 900 Series stands, LM815FPR Pro bass pedal, matching snare drum

*7x10" tom available with Mini-Classic lugs only

Shown in Sunset Diamond Pearl with optional Vibra-Bands.

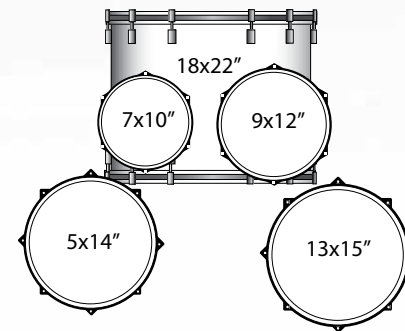

BASS DRUM MOUNTS

Choose a virgin mount bass drum (not shown), Modular Double, Classic Double, Single Rocker or NEW Rail Console mounts.



VIBRA-BAND TOM MOUNTING SYSTEM

Introducing Ludwig's new Vibra-Band tom mounting system, featuring a sleek, small profile mounting plate. The Vibra-Band allows the drum to "float" freely for maximum uninhibited resonance. Shown with an Elite bracket.

Available sizes and model numbers:

- L084R - 8"
- L106R - 10"
- L126R - 12"
- L136R - 13"
- L148R - 14"
- L168R - 16"

In addition, Ludwig Vibrabands can be fitted with Classic and Keystone brackets to compliment floor tom hardware.



Ludwig VISTALITE

Original. Explosive. Legendary.

There are many imitators but none compare to the original Ludwig Vistalite Plexiglas® drums. Originally introduced in 1972, the tradition of outstanding sound projection and power along with the renowned see-through appeal transcends time.

Custom set shown with 16x22" bass drum, 16x16", 14x14" floor toms, 8x12" tom, 6.5x14" snare

Features: Classic tom legs and brackets, Mini-Classic lugs, (large Classic lugs can be ordered as option), single tom holder, vintage blue/olive badges

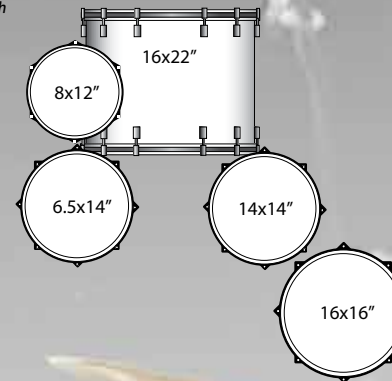

Vistalite drums are available in 4 colors: Amber (47), Blue (55), Yellow (56) and Clear (38)

VISTALITE COMPONENTS

BASS DRUMS			FLOOR TOMS			TOMS**			SNARES		
Diameter	Depth	Model	Diameter	Depth	Model	Diameter	Depth	Model	Diameter	Depth	Model
22"	16"	LB944V	14"	14"	LF944V	8"	10"	LT980V	14"	5"	LS901V
24"	14"	LB962V	16"	16"	LF966V	12"	8"	LT982V		6.5"	LS903V
			18"	16"	LF968V	13"	9"	LT993V			
						14"	10"	LT904V			

*With or without bass drum mounting plate

**Vibra-Bands with classic tom brackets are an option

*Outfits shown do not include cymbals or hardware

JASON BONHAM
VISTALITE
THE DRUMS
REMAIN
THE SAME

While preparing for the Zeppelin Reunion in 2007, Jason Bonham requested a kit, with his own personal imprint, that would carry the legendary spirit of his father's playing forward. The result was the inspiration behind Jason's Limited Edition Signature kit. A true Ludwig first, this yellow Vistalite in John Bonham's own Zep set configuration features black powder-coated hardware and fittings on all drums, for a truly unique look. To further authenticate these limited-number production kits, Jason personally signed each drum head, emblazoned with the iconic imagery from his father's first masterpiece.

ZEP SET

L8264LM47 (w/ hardware)
L8264LX47 (shell pack)

Features: Classic tom legs and brackets, Classic lugs, bass drum T-rods and Gold Sparkle inlay bass hoops, vintage blue/olive badges, 900 Series stands, LM815FPR Pro bass pedal

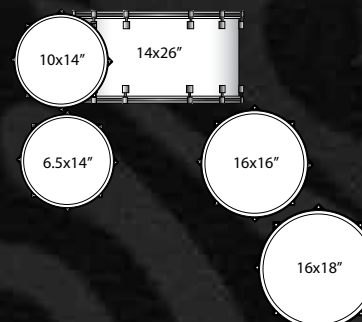

BIG BEAT (not shown)

L9125LM (w/ hardware)
L9125LX47 (shell pack)

Features: Classic tom legs and brackets, Mini-Classic lugs, (large Classic lugs can be ordered as option) Vibra-Band mounts standard, LR2980MT double tom holder with 9.5mm arms, vintage blue/olive badges, 800 Series single braced stands, Speed King Pedal

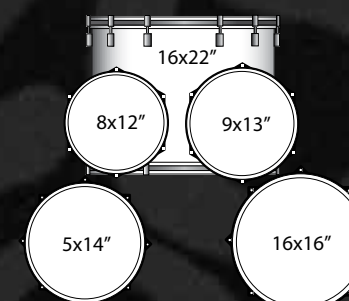

BLUE/OLIVE BADGE

All Vistalite drums come standard with the "parallelogram" Blue/Olive badge. Having debuted in 1969, this iconic emblem is a piece of Ludwig's history.



Centennial

series drums

BUILT FOR THE ROAD

With the touring player's demands in mind, Ludwig presents the Centennial Series. Combining the warmth and projection of quality North American Maple shells with a choice of 4 custom configurations, Centennial delivers reliability and the legendary Ludwig sound in one exceptional package.



EPIC

MODULAR

SERIES DRUMS

Any drum set can be flexible in its set-up, but how many kits can be so flexible that they are completely different every time? Epic Modular's 6-ply, all birch shells fit the bill, coming standard with two rack toms, two floor toms and two 8x20" kick drums that connect together for one massive sound.



Arranging the included rack and floor toms in a myriad of patterns created multiple creative set-ups for gigging drummers.



Epic Modular can even be played as two separate kits for smaller club performance or interactive education.

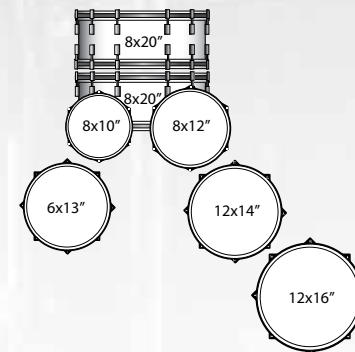

Epic Series Modular kit (LCEP20MX)*
Shown in Blue Fade (BL)

Also available in Tobacco Fade (TB)



*Outfit shown do not include cymbals or hardware

CENTENNIAL COMPONENT DRUMS

BASS DRUMS		
Diameter	Depth	Model
20"	20"	LRC2020B
22"	22"	LRC2222B
24"	20"	LRC2024B

FLOOR TOMS		
Diameter	Depth	Model
18"	16"	LRC1618F
14"	13"	LRC1314F

FLOOR TOMS		
Diameter	Depth	Model
14"	10"	LRC1014T
13"	9"	LRC0913T
10"	7.5"	LRC7510T
8"	7"	LRC0708T

SNARE DRUMS		
Diameter	Depth	Model
13"	6.5"	LRC6513S
14"	6.5"	LRC6514S

*Outfit shown do not include cymbals or hardware

SHELL

6-ply North American Maple (8-ply on bass and snare drums)



FINISHES

Choose from two Sparkle Lacquer finishes (Shown in Silver Sparkle), or two high-gloss Transparent Lacquers for stellar appearance.



AVAILABLE CENTENNIAL CONFIGURATIONS

GROOVER LRC20

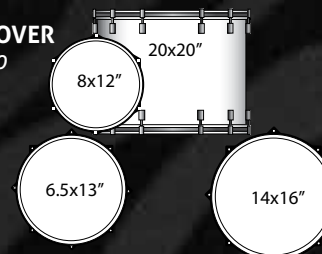

POWERDRIVE LRC22

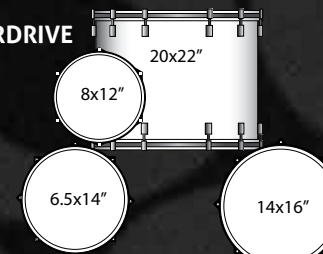

ARENA LRC24

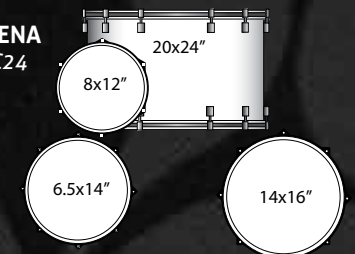

EPIC X-OVER

The hallmark of the Ludwig sound has always begun with the shell. As we enter a new phase of our manufacturing history, Ludwig returns to its roots with Epic X-Over, a new series of drums crafted for every player from the gigging workhorse to the seasoned pro.

Epic X-Over Arena Shell Pack with optional 13"x14" Floor Tom (LRX1314FRB) Shown in Redburst (RB)

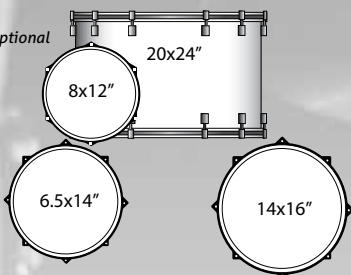

CLASSIC MICRO LUG

This low-contact, shorter version of our Classic Lug allows for further vibration in the shell. (Shown in Natural Burst Finish)



NEW RAIL CONSOLETTE

The original rail-mount was introduced in 1961 as a flexible tom mounting solution. This sturdy update features universal ball-in-socket positioning, height adjustment and a knurled rail for solid performance and hold.



BASS DRUM LIFT

For better tone and response from the 18" bass drum on the Jazzette outfit, the hoop on the X-Over Jazzette is fitted with this unique lift.



EPIC X-OVER STRIPED

SHELL: Walnut/Maple/Walnut Inner and Outer, Poplar Core, 3-ply Birch Reinforcement Rings

Segmented shell crafting is an exciting concept that incorporates the dark quality of Walnut inner/outer plies fused with the warmth of North American Maple inner/outer plies to create a whole new tonal as well as visual experience. This magic combination combined with 3-ply Birch reinforcement rings and Poplar core plies results in a sound and look that is unparalleled in drum making. The perfect balance between rumbling lows and sparkling highs is achieved with the Epic X-Over Striped Series.

Epic X-Over Striped New Hollywood kit (LRS22FXN)* Shown in Natural

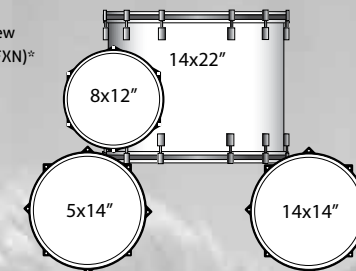

*Outfits shown do not include cymbals or hardware

SHELL

Walnut Inner/Outer, Poplar Core, 3-ply Birch Reinforcement Rings

American Walnut is known not only for its dark color and grain, but also for its deep tonality and warmth. The new Epic X-Over expands on darker overtones by employing a Poplar core to an inner and outer Walnut shell. 3-ply Birch reinforcement rings are added for extra definition and focus, resulting in a sound that speaks in the lower register with power and clarity



OTHER CONFIGURATIONS AVAILABLE

GROOVER LRX20GX

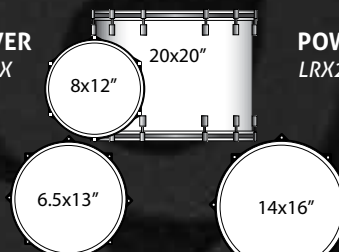

POWERDRIVE LRX22PX

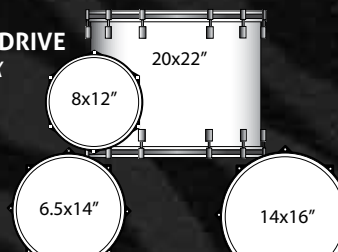

KEYSTONE TOM BRACKET

Taking on the shape of our company icon, the new Keystone Bracket takes up less space on the shell for added resonance and stable tom and floor mounting. (Shown in Purple Passion Finish)

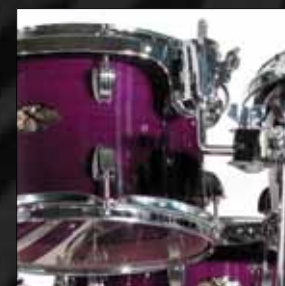

OTHER AVAILABLE EPIC X-OVER CONFIGURATIONS

DOWNBEAT LRS20DXN

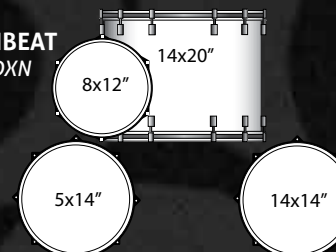

JAZZETTE LRS18JXN

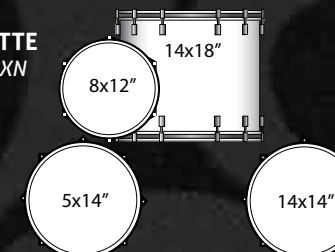

EPIC

Sculpting a rich, vibrant balance between subtlety and sonic punishment, Epic Series drums are truly at home in the Ludwig Legacy. These drums produce a wet, powerful sound that is at home in high-volume situations, as well as the club and studio environments.

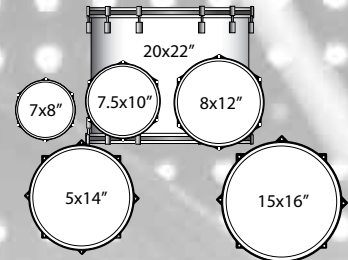

AVAILABLE FINISHES



Attic White (AW)



Red Fade (DR)

Opposite Page:
Epic Series Funk Kit (LCEP22FX)*
Shown in Mahogany Burst (MF)

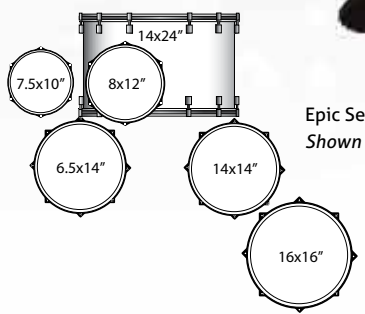

Epic Series ProBeat kit (LCEP24BX)*
Shown in Natural/Blackburst (BB)



Extended for a limited time. Qualifying Epic, Element Lacquer and Element Series 5-pc. drum sets will included an additional tom at no extra cost. Offer subject to change without notice, pricing and participation may vary. See www.ludwig-drums.com for details.

*Outfits shown do not include cymbals or hardware

SHELL

Birch Inner and Outer, Maple Core, Thin 6-ply Shell

Taking the focused, cutting tone of Birch and fusing it with the warmer qualities of Maple. Epic's new ultra-thin ply shell vibrates at a more even rate for a better tone.



CLASSIC KEYSTONE LUG

The newly designed Classic Keystone lug is a low-mass, minimal contact lug with the features that made the originals instantly recognizable but updated with sleek styling for maximum performance.



VINTAGE BRONZE HARDWARE & VIBRA-BAND TOM MOUNTS

This new, pre-antiqued plating gives Epic Series a strikingly unique look and feel.



OTHER CONFIGURATIONS AVAILABLE

POWER LCEP22RX

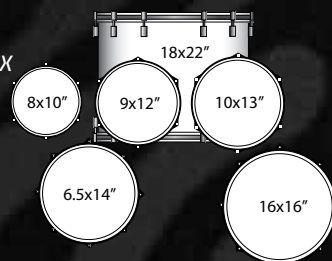

DOWNBEAT LCEP20DX

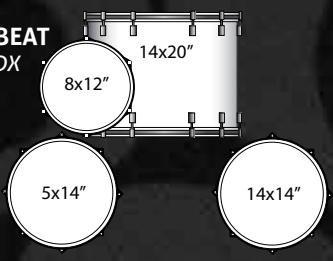

JAZZETTE LCEP18JX

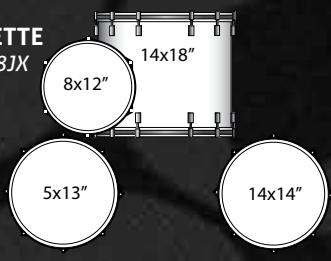

Ludwig ELEMENT SE Cherry / Gum Wood RETRO SERIES DRUMS

Element SE Cherry/Gum Shell Pack in New Hollywood Configuration (LRR22FX) Shown in Mod Orange (MO) finish.

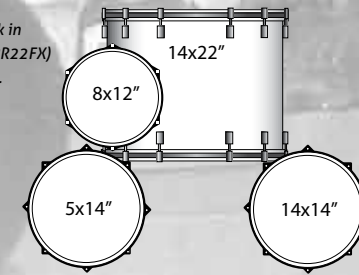

Element SE is a destination for specialized, limited production kits showcasing an evolving array of customized features for the gigging player.

For the perfect sonic compliment to three infamous Ludwig finishes, the latest addition to the Element SE collection fuses Cherry and Gum woods for proper vintage flair. With more density in each drum, these limited production kits produce a dry, focused sound that speaks quickly with the right amount of overtone. A true modern classic from the Psychedelic Era.



NEW! Keystone Brackets



Classic Micro Lugs



Rail Console Mount



Corey Miller photo credit © Robert Downs.

*Outfits shown do not include cymbals or hardware

FINISHES

Available in Ludwig Retro finishes



Psychedelic Red



Citrus Mod



Mod Orange

OTHER CONFIGURATIONS AVAILABLE

DOWNBEAT
LRR20DX

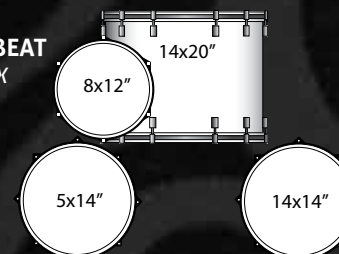

2 UP 2 DOWN
LRR22X

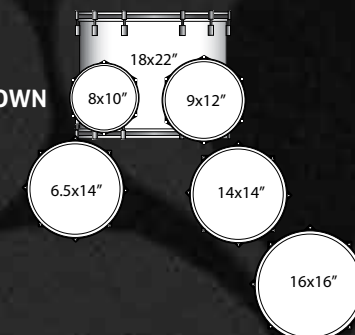

ELEMENT SERIES DRUMS

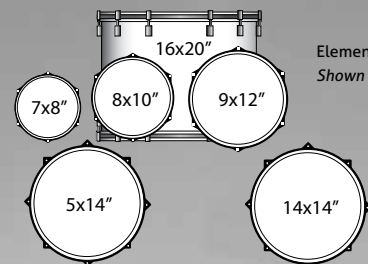

Element Series Fusion Kit (LCB20FX)*
Shown in Red Reverse (RO) w/ chrome hardware

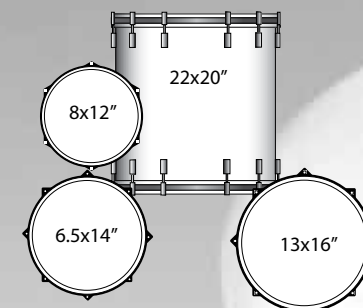

Element Series Emo Kit (LCB20GX)*
Shown in Natural Burst (NB) w/ chrome hardware

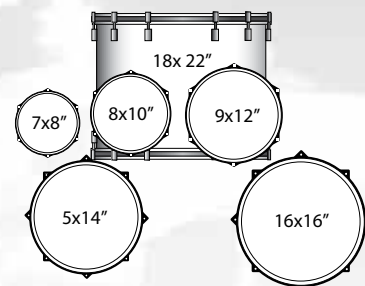

Element Lacquer Series Power Fusion Kit (LCB22PX)*
Shown in Black/Grey Burst (BF) with black hardware



*Outfits shown do not include cymbals or hardware

For the up and coming player, there are a lot of choices for next-level gear. The demands are simple: pure tone, durable functionality and the right custom touches. That is what Element Lacquer is all about. High-end features like gloss lacquer finishes, Birch hybrid shells and a unique array of configurations put the drummer in control. All the pieces are in place, all that remains is you.

FEATURES

Black powder-coated hardware (available on select finishes), Vibra-band tom mounts and 2mm tom hoops (shown in Green Fade finish)



CLASSIC KEYSTONE LUG

The newly designed Classic Keystone lug is a low-mass, minimal contact lug with the features that made the originals instantly recognizable but updated with sleek styling for maximum performance.



SHELL

Marbled Birch Inner and Outer, thin 6-ply shell with Poplar core



OTHER CONFIGURATIONS AVAILABLE

POWER LCB22RX

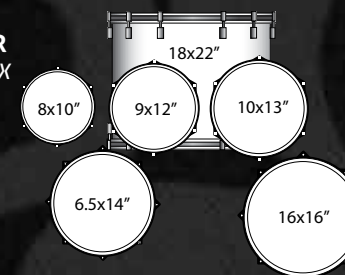

*OPTIONAL 400 SERIES HARDWARE PACKS AVAILABLE

Includes durable, double-braced cymbal, boom, hi-hat, snare stand and a chain-drive pedal. A perfect compliment to Element's high impact features.

ELEMENT

SERIES DRUMS

Steve Misamore photo credit © Ben Enos.

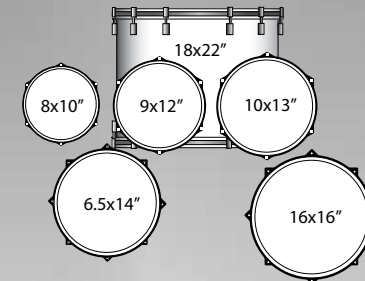

Element Series Power (LCE22RX) configuration shown in Orange (5), Black (1), White (3) and Wine Red (4)*



*OPTIONAL 400 SERIES HARDWARE PACKS AVAILABLE

Includes durable, double-braced cymbal, boom, hi-hat, snare stand and a chain-drive pedal. A perfect compliment to Element's high impact features.

*Outfits shown do not include cymbals or hardware

Right out of the gate, Element Series drums offers a dazzling array of custom inspired options to the student-level player. Vibra-Band suspension mounts, our new Classic Keystone lug and two new finishes are only the beginning and combine to make Element Series the perfect choice for the next step.

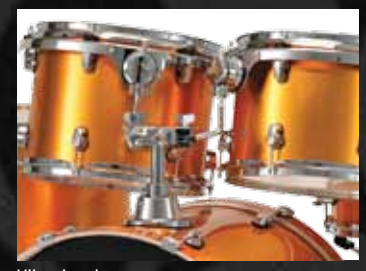

Vibra-band tom mounts



Classic Keystone lug

SHELL

Thin 6-ply select hardwood shells



OTHER CONFIGURATIONS AVAILABLE

FUSION LCE22FX

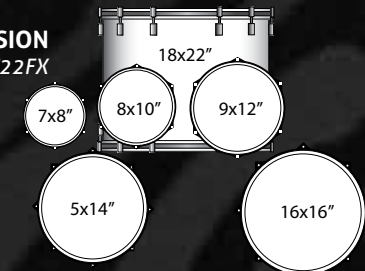

POP LCE20PX

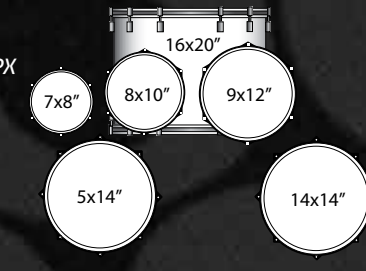

JAZZETTE LCE18JX

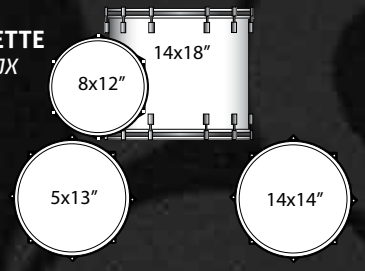



ACCENT CS 100 SERIES

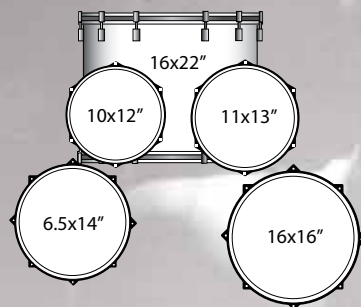

POWER

Accent CS Combo Power - LC1251

16x22" kick, 16x16" floor tom, 11x13" tom, 10x12" tom, 6.5x14" snare drum

Shown in Black (1)

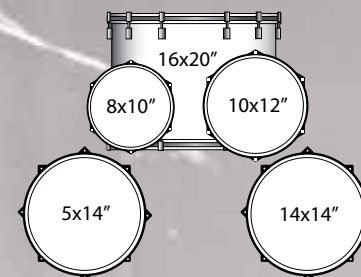

JAZZ

Accent CS Combo Jazz - LC105

16x20" bass drum, 14x14" floor tom, 8x12" tom, 8x10" tom, 5x14" snare drum

Shown in NEW White (8) w/ black hardware



Ludwig offers three fantastic options in our most affordable line for the young drummer: the Accent Nomad outfit for the early beginner, the Accent CS Combo Jazz and the CS Combo Power for drummers needing a full-sized drum set-up.

Features 9-ply, 8mm select hardwood veneers with the choice durable PVC finishes, including Black (1) and Wine Red (4,) both with chrome hardware, and NEW White (8) and Metallic Purple (6) both with black hardware. Outfit comes with a lightweight, sturdy double braced hardware package and single braced throne. Cymbals not included.



NOMAD

Accent CS Combo - LC135

14x18" bass drum, 12x14" floor tom, 8x12" tom, 8x10" tom, 5x13" snare drum

Shown in Black (1)

Available only in Black and Wine

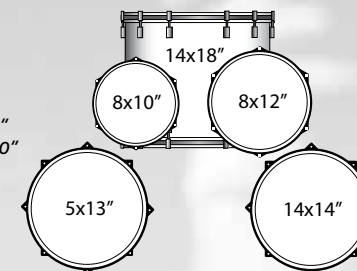

JUNIOR KIT

The Junior Kit (LJR106) has all the features of a full-sized outfit, sized for drummers 4-8 years old.

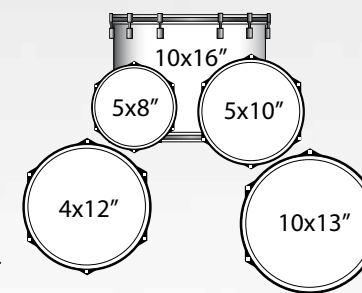

10x16" bass drum, 10x13" floor tom, 5x10" tom, 5x8" tom, 4x12" snare drum

Throne & cymbals included

Available in Wine Red (shown), Black and Blue

For assembly instructions please visit, www.ludwig-drums.com/literature.

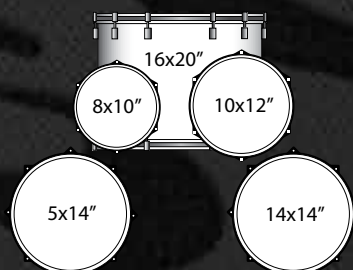

JAZZ

Accent CS Combo Jazz - LC105

16x20" bass drum, 14x14" floor tom, 8x12" tom, 8x10" tom, 5x14" snare drum

Shown in NEW Metallic Purple (6) w/ black hardware



One of the primary reasons Ludwig is "the most famous name on drums" is the legendary Black Beauty Snare Drum. The brass shell is constructed of a single sheet of brass that is machine drawn and spun into a seamless beaded drum, then black nickel plated with a beautifully exquisite finish. The shell provides a warm, round metallic tone.

Brass on Brass Black Beauty - LB416BT
 Features: brass plated P86 Millennium snare strainer, brass plated P33 butt plate, brass tube lugs, brass die cast batter and snare hoops



With any of the three strainer options of P85 Supra-Phonic, P86 Millennium or P70 Super-Sensitive strainers, the Black Beauty responds with excellent sensitivity at all volumes. Choose from Imperial or tube lugs, die cast or triple-flanged hoops and a smooth or hand hammered shell. The 70 year tradition of the Ludwig Black Beauty carries on as the ultimate snare drum in the industry.



LB553B - 3.5x13"



LB416 - 5x14"



LB417KT - 6.5x14"
 Features: hammered shell, tube lugs, P85 Supra-Phonic strainer



LM400 - 5x14"



LM402 - 6.5x14"



LM411 - 6.5x14"
 Features a Super Sensitive strainer



Performance proven to be the sound that fueled the most hit recordings in history, the Ludwig LM400 and LM402 are the snare drum choice of the pros.

The Memorial Edition "Chief" Supraphonic's .035" tick Titanium shell (prepared exclusively for Ludwig by drumsmith Ronn Dunnett) offers a wide tuning range and crisp, amplified tone. As the only Supraphonic available in 5.5"x14", the Chief also features a piston throw-off, adjustable air-vent, Imperial Lugs, and a specially-minted badge featuring the drum's namesake, William F. Ludwig II.



From Jazz to Metal, Ludwig 400 Series Snare Drums provide the perfect sound in the studio or on stage. The USA made chrome plated seamless aluminum shells produce a bright, crisp cutting sound, with the perfect balance of full resonant tone and snare crack.

The LM400 and LM402 are available with Imperial lugs or tube lugs, smooth or hammered shells as well as the P85 or P86 snare strainer.



BRASS SNARE DRUMS

The Ludwig Snare Drum pedigree was built on the foundation of Brass. Now available in a variety of sizes and options, Ludwig Brass Snares project with bright, soaring highs and a crisp sensitivity essential for capturing every stroke.



Chrome-plated Brass Snare - LB402BBTWM
Features: spun seamless brass shell, brass plated P86 Millennium snare strainer, brass plated P33 butt plate, brass tube lug, brass die cast batter and snare hoops



NEW! Hammered Brass - LB422BKT
Hammered using the same process as Ludwig Timpani. 5x14" and 6.5x14" models are similar in tone to the Black Beauty but higher in pitch. Features seamless brass shell with tube lugs and 2.3mm hoops.



Rocker Brass Snare - 6.5x14" - LM306
Ludwig snare tone at player-friendly pricing, featuring Classic lugs and 1.5mm triple-flanged hoops. Also available in 5x14" - LM305.

BRONZE SNARE DRUMS

A softer, darker alloy generally used for cymbal making, bronze presents a unique blend of metal snare projection and the warmer tones of a wood drum. Options include standard 2.3mm triple-flanged or die-cast hoops, Imperial or tube-style lugs and Classic P85 or Millennium P86 snare strainers. Bronze snares are also available with Super-Sensitive snare strainer.



LB5252KT - 6.5x14"
Hammered bronze snares deliver a unique, drier tone and a broad sonic range.



Bronze - 5x14" - LB550
Features Ludwig's seamless bronze shell with smooth finish for ultimate resonance.



Rocker Bronze Snare - 6.5x14" - LM306
Deep, throaty snare tonality with an affordable price-tag. Features Ludwig Classic lugs and 1.5mm triple-flanged hoops. Also available in 5x14" - LM305.



ACROLITE SNARE DRUMS

Once perceived as a student-level snare drum, the sound of the Ludwig Acrolite Snare has become an artist favorite for bright, dry response and articulate play. Featuring the signature "Black Galaxy" finish, Classic lugs and unique black/white vent badge, Acrolite's seamless aluminum shell reflects Ludwig excellence in quality and leaves no question that it is simply a tremendous snare drum at any level.



LM404 - 5x14"



LM405 - 6.5x14"

ROCKER AND ACCENT SNARE DRUMS

From beginner to gigging player, Ludwig's Rocker and Accent Snares offer variety and value for all types of playing styles. It's all here and it's all Ludwig.



Rocker Metal Snare
LR719 - 6.5x14", LR720 - 5x14"



Chrome Steel Snare
LM302 - 6.5x14", LM300 - 5x14"



Accent CS Steel Shell - Chrome plated
LC054S - 5x14"

CLASSIC MAPLE SNARE DRUMS

Ludwig's wood snares have remained popular throughout the company's 100-year history and were the drums that helped establish the fat backbeat and deep grooves of pop and R&B music in the 1970's and 80's.

The Classic Maple 7-ply all-maple shell features the clarity and warmth players have come to expect from maple drums, plus the projection and musicality that has maintained Ludwig's reputation for snare drum innovation and excellence.

Available in a wide selection of sounds, sizes and styles, from piccolo, standard and deep models. From lacquer, exotic and wrapped finishes, Ludwig Classic Maple snares are the new Classics of today. Sizes not shown: 6x13", 3x13" and 3.5x14".



LS403TD - 6.5x14"
Brass die-cast hoops, brass tube lugs, brass plated P86 Millennium strainer and butt plate
Shown in Cherry Lacquer Stain

EXOTIC WOOD SNARE DRUMS

Ludwig's exotic wood snare drum line offers a stunning array of exclusive veneers selected from Steinway Piano in Boston, MA. From figured woods like Birdseye Maple and Waterfall Bubinga, to quilted woods like Makoré and Sapele, all exotic snares feature 7-ply of maple with an outer ply of exotic veneer. Available options include tube-style lugs, die-cast hoops and brass hardware.



LS403TD50WMB
Birdseye Maple



LS403TD65WMB
Sapele Pomele



LS403TD53WMB
African Waterfall Bubinga



LS403TD62WMB
Makoré (African Cherry)



LS403TD67WMB
Santos Rosewood



LS403TD70WMB
Arctic Glitter



Further pushing the Epic shell hybrid concept, the Centurian line consists of three snare models; each with a different exotic wood shell and unique tonal distinction. Coming standard with tube-style lugs and 2.3mm hoops, Epic Centurian Snares are a unique destination for the discerning collector.



LCEX6514TXBU: 6.5"x14" African Bubinga - More at home in a live setting, the harder nature of Bubinga wood is brought up a notch in tone with a thicker, 10-ply shell. Ideal for louder situations where more articulate play might otherwise be lost.



LCEX6514TXWA: 6.5"x14" American Walnut over Maple - This drum was made for the studio environment. Harnessing a deeply resonant tonal quality, the 8-ply Canadian Maple shell is accentuated by a deeply figured, American Walnut outer ply for stunning look and feel.



LCEX6514TXSA: 6.5"x14" African Sapele - Similar in appearance to Mahogany but harder than Red Oak, this is a drum that speaks at a medium-to-high pitch with fierce attack and cut. The thick 12-ply shell is made even louder thanks to 4-ply Maple reinforcement rings at both ends of the shell. Very sensitive and made to project without sacrificing depth.



LS462 - 6x12"
Shown in Red Sparkle



LS403 - 6.5x14"
Shown in Green Sparkle



LS401 - 5x14"
P86 Millennium Strainer
Shown in Champagne Sparkle



LS484 - 8x14"
Shown in White Marine Pearl



Natural Finish Only
LRS313EC - 3x13"

Black Magic SNARE DRUM

Legendary, player-approved sound. Ludwig pioneered the black-nickel over brass shell concept in the early 1920's, setting a standard that all other would follow. Black Magic Snare Drums bring that signature sound and quality to a whole new playing spectrum, with four models to satisfy any playing situation. Accentuated with matching tube lugs and die-cast hoops, Black Magic snares deliver classic tone that drummers have come to expect from Ludwig.

LW0713 - 7x13": Built to focus on tight, crisp projection, the 7" depth on this 13" model adds full-bodied sonic elements to its powerful attack.

LW5514 - 5x14": A standard model for everything from Pop to Jazz, the 5x14" produces pure, articulate snare tone with bright overtones.

LW6514 - 6.5x14": For higher-volume situations, the 6.5x14" has a fat, open sound without sacrificing tone or sensitivity.

LW0814 - 8x14" (NEW): Inspired by the Ludwig Coliseum, the new 8x14" is the ultimate in low-bodied power and projection.



Black Magic STAINLESS STEEL SNARE DRUM

Yet another in a series of Ludwig firsts, NEW Black Magic Stainless models incorporate a mirror-polished, 1.5mm stainless steel shell for bright, cutting attack and mid-range overtone. Black Magic's black-nickel tube-lugs and appointments provide, sharp visual contrast, and tonal range is broadened with 2.3mm power-hoops.



LW5514S - 5x14"



LW6514S - 6.5x14"

JIM RILEY Signature SNARE DRUM

Noted Clinician and Rascal Flatts Drummer Jim Riley has always relied on a variety of Ludwig snares to get the job done. Jim's new Signature Snare combines the best elements of his favorite models in one, reliable workhorse. Its 1.5mm Stainless Steel shell produces plenty projection and SNAP, while its 8" depth lends the balanced warmth of a wood drum. Ornamented with a laser-engraving that is true to Riley's roots, its visual brilliance is offset by black-nickel tube-lugs and die-cast hoops.

"This drum has been tested from Nashville studios to the arena stage and sounds fantastic every step of the way." - Jim Riley





900, 800 & 700 SERIES

From the student-level percussionist to the professional touring and recording drummer, Ludwig offers a full line of hardware designed to fit the needs of every player.

900 SERIES HARDWARE

Ludwig's 900 Series hardware presents a full line of road ready stands to equip the gigging drummer with versatility and stability. 900 Series hardware offers functions such as the disappearing cymbal boom arm of the LM935BCS stand and the smooth action and flexible spur leg of our LM918HH Pro Float hi-hat stand. Snare drum positioning is a breeze with the low-profile, nylon ball positioning system of our LM922SSL snare stand.

Featuring nylon inner linings for smooth operation, the Ludwig Collar Clamp for stress-free height positioning and triple chrome plating, 900 Series Modular Hardware is made to stand up to the challenge of the road.

The LM918HH Pro Float stand features a smooth floating action pedal mechanism with six possible tension adjustments. The cam lever system allows for easy pedal action. The additional spur leg can be positioned on either side of the stand, or removed completely. The Pro Float stand is also equipped with a Velcro-lined rock plate for added stability.

LM936MBS
Modular mini-boom
double braced

LM931BCS
Modular boom
with weight
double
braced

LM917HH
Modular with swivel
base double braced

LM935BCS
Modular disappearing
mini-boom double
braced

LM926CS
Modular straight
double braced

LM922SSL
Modular low
profile double
braced

LM921SS
Modular
double
braced

800 SERIES HARDWARE

Sturdy and reliable, 800 Series stands feature the same cymbal, hi-hat and snare drum support as the 900 Series, but with single braced legs for reduced weight. Ideal for repeated set-up and tear-down, 800 Series is heavy in function, but lighter for the load."

LM817HH
Modular with swivel
base single braced

LM831BCS
Modular boom
with weight

LM836MBS
Modular
mini-boom
single
braced

LM826CS
Modular straight
single braced

LM822SSL
Modular
low profile
single braced

700 SERIES HARDWARE

When the gig calls for a light-weight alternative to the normal bulkiness of tour-class stands, 700 Series cymbal, cymbal boom, snare and hi-hat stands offer the durability and rigid strength of double braced hardware, with thinner diameter piping and fixtures.

LC716HH
Classic
double
braced

LC736MBS
Classic
mini-boom
double
braced

LC726CS
Classic
straight
double
braced

LC722SSL
Classic
low profile
double
braced

LT126CS
Flat base
lightweight
straight single
braced



300, 400 & 200 SERIES

300 SERIES HARDWARE

Pro features don't always have a high price tag attached. Ludwig 300 Series hardware features the functionality, heavy tubing and sturdy, double braced legs that are normally only found on high-end stands. From the disappearing boom arm on the L336MBS cymbal stand, to the multi-tension control on the L316HH hi-hat stand, 300 Series hardware puts tour-strength gear in the hands of the drummer at an astonishing price.

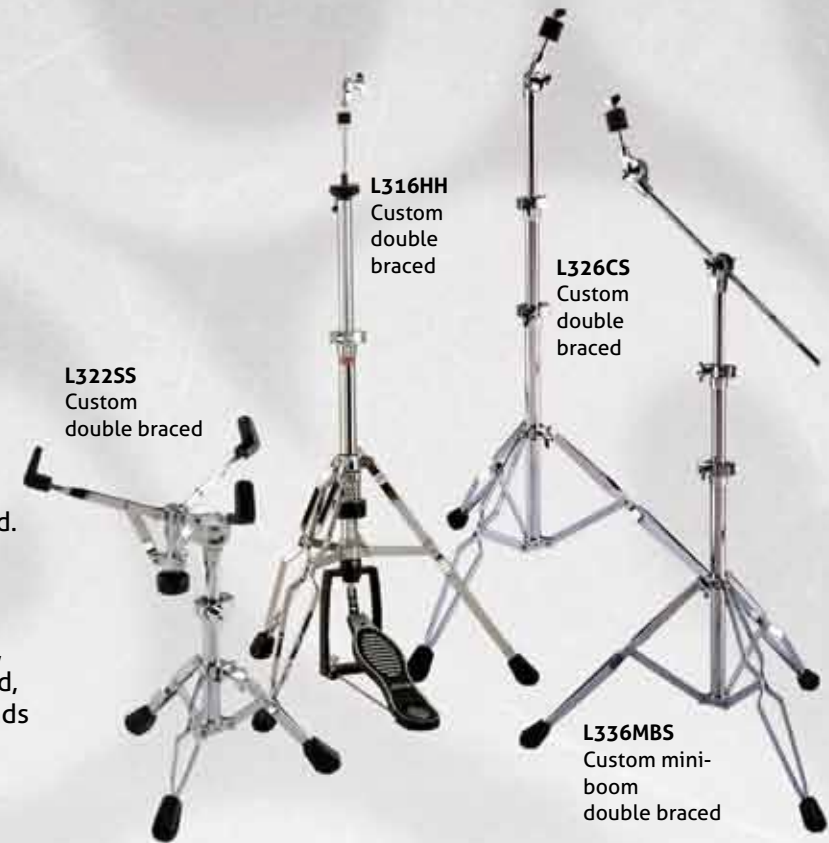

L322SS
Custom
double braced

L316HH
Custom
double
braced

L326CS
Custom
double
braced

L336MBS
Custom mini-
boom
double braced

400 SERIES HARDWARE

For the up-and-coming drummer, 400 Series stands are made to be accessible without sacrificing the elements needed to take real punishment. Performance-proven features include hide-away boom tilters, double-braced legs, basket-style snare stand adjustments and reinforced locking mechanisms for secure positioning.



L416HH
400 Series
double
braced

L436MBS
400 Series
boom
double
braced

L422SS
400 series
double
braced

L426CS
400 Series
straight
double
braced

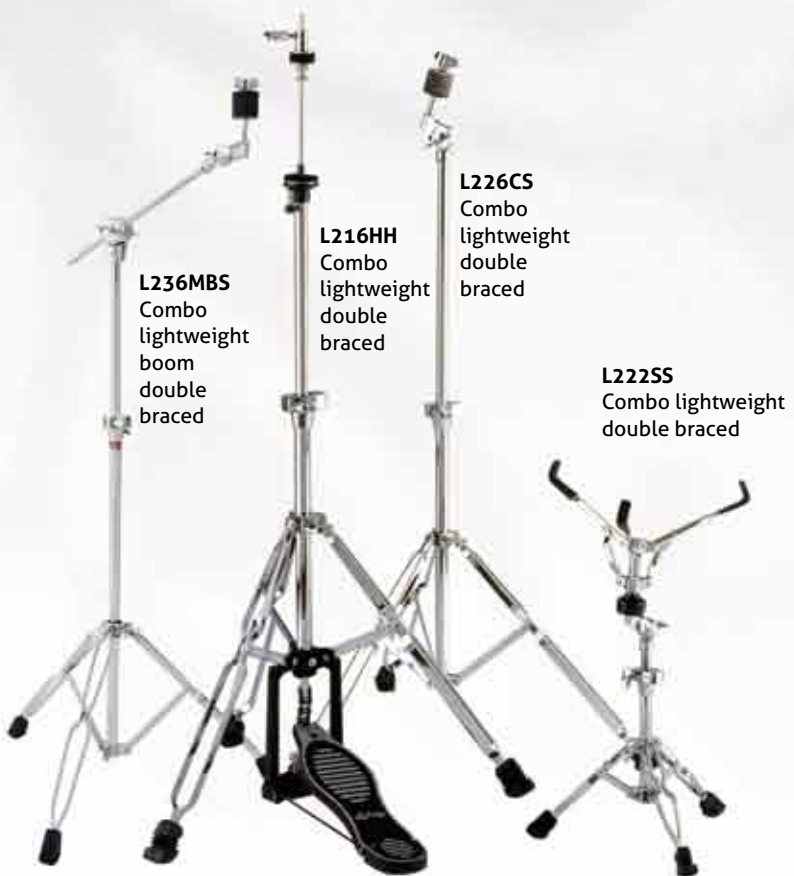

L236MBS
Combo
lightweight
boom
double
braced

L216HH
Combo
lightweight
double
braced

L226CS
Combo
lightweight
double
braced

L222SS
Combo lightweight
double braced

THRONES

Not Shown:

LM448TH
Seat Case - Specify Finish
(Classic Wrap Only)



L351TH
Saddle style - wide
double braced
with fabric top



LM450TH
Modular - wide
double braced
with fabric seat



L348TH
Round - double braced
with fabric top



L347TH
Custom - double
braced



LR246TH
Rocker - double
braced



LM446TH
Modular - double braced



L350TH
Round - wide
double braced
with fabric top



L349TH
Saddle style - standard
double braced with fabric top



LM449THB
Modular bicycle style
with back double braced

200 SERIES HARDWARE

A standard hardware package for the beginning player, 200 Series stands combine form and function with sturdy construction. A great start for drummers of any age.



TOM STANDS & HOLDERS

LC344TSR
Low double tom stand for 9.5mm with L-arm mounts single braced



LM442TSR
Tall double tom stand for 9.5mm with L-arm mounts double braced



L345TS
Custom double tom stand double braced



LC342TSR
Tall double tom stand for 9.5mm with L-arm mounts single braced



LM543TSE
Low double tom stand for 10.5mm Elite mounts double braced



LR255STH
Rocker single tom add-on holder with 9.5mm L-arm/ball



LR254STH
Elite single tom holder with 10.5 mm L-arm/ball



LR257STH
Elite single tom add-on holder with 10.5mm L-arm/ball



LR2980MT
Rocker double tom holder with 9.5mm L-arm/ball



LR2981MT
Rocker single tom holder w/ 9.5mm L-arm/ball



LR256STH
Rocker single tom add-on holder with 9.5mm L-arm/ball



LR2992MT
Classic double tom holder with 10.5mm L-arm/ball

LM3002MT
Modular double tom holder with tube style



LM451CH
Modular add-on cymbal holder



LM463AXH
Stationary Hi-Hat



L1372
Shell mount cymbal holder



LR251CH
Rocker add-on cymbal holder



LM472SPH
Stackable cymbal arm attachment



LM471SPH
Splash cymbal holder 10.5mm post



LM470SPH
Splash cymbal holder



LM473CBH
Add-On Cowbell Holder Attaches to Cymbal Stand



LM474CBH
Add-On Cowbell Holder Attaches to Bass Hoop



Ludwig offers a full line of replacement and component parts and accessories for replacement and restoration. For complete information, log on to www.ludwig-drums.com.

SPEED KING PEDAL

The Speed King pedal revolutionized the drumming industry and enabled drummers to play more fluently. Famous for speed and precision, some of the most legendary names in drumming use the Speed King for its smooth feel and powerful response. Designed with a reverse double compression spring mechanism, solid metal construction, direct link drive and a classic felt beater. Speed King. Experience what legends play.



L201
Speed King

LUDWIG PRO PEDAL

Ludwig Pro Pedals are the next generation of design. The LM815FPR Single and LM812FPR Double Pedals offer rock plate technology for the ultimate in stability. Pro pedals feature a double chain drive, reversible pedal beater, a side adjustment hoop mount, a stylish footboard and fast, smooth cam action mechanics. These Pro Pedals also include Pedal Bags for the gigging drummer.

Not Shown:

LM811RP
Rock Plate Add-On



LM815FPR
Ludwig Pro pedal with Rock Plate (includes bag)



LM812FPR
Ludwig Pro double pedal (includes bag)



L312FPR
Ludwig Pro double pedal



LC614FP
Classic



L415FPR
400 Series



L315FP
Custom pedal with Rock Plate



L215FP
Combo

Ludwig ACCESSORIES

DRUMHEADS

Whatever playing situation you're in, Ludwig has a drumhead made just for you. All Ludwig WeatherMaster® Drumheads feature our exclusive Headlock System and low profile collar, designed for even tuning and "no pull out" tensioning.



Vintage Front Bass Drum Head

Ludwig's re-issue of the stylish Vintage Logo Drumheads are an exact replica of the heads that adorned the famous drum sets of the sixties. These heads are smooth white and feature the black "script" logo at the top.



Black Heavy Bass Drum Head

Ludwig Black Bass drum heads offer excellent response and durability for any concert setting indoor or outdoor. These heads are ideal for extra projection.



White Coated Heavy Bass Drum Head

These 10ml heads are heavy coated for extra depth, as well as warmth and focus. Ludwig's Heavy Coated Heads provide the sound and durability you've come to expect from Ludwig Weather Master Heads.



Power Collar Clear Bass Drum Head

Reduce unwanted overtones with Ludwig's Power Collar Head. These heads feature a clear heavy weight 10ml single ply material with an outer tone ring.



Silver Dot Heavy Bass Drum Head

A heavy clear one ply head with a silver reinforced center dot. Ludwig's Silver Dot Heads are a favorite amongst marching percussionist and heavy hitters alike.

DRUM STICKS & BRUSHES

Drumsticks

Model No.	Wood Tip	Nylon Tip	Description
L-7A		L-7AN	Small Olive Bead, 15-3/8" & .500 diameter
L-Jazz			Small Barrel Bead, 16-1/8" & .550 diameter
L-Rock	L-Rock-N		Large Acorn Bead, 16-3/8 & .550 diameter
L-5A	L-5AN		Medium Olive Bead, 15-3/8 & .575 diameter
L-5B	L-5BN		Large Acorn Bead, 16-1/8 & .600 diameter
L-SD1			Large Barrel Bead, 16-3/8 & .630 diameter
L-2B	L-2BN		Large Acorn Bead, 16" & .650 diameter
L-MS1			Large Ball Bead 16" & .700 diameter
L-3S			X-Large Barrel Bead, 16-1/2" & .700 diameter

Wire Brushes

Model No.	Description
L-194	Red-Grooved Handle w/ Ball End
L-206	Clear Plastic Handle w/ Loop End
L-191	Red-Grooved Handle w/ Loop End
L-195	White Plastic Handle w/ Loop End
L-190	Red-Ribbed Handle w/ Loop End

P4 PRACTICE PAD



Ludwig has taken the practice pad to new levels...three levels to be exact. Introducing the Ludwig P4 Practice Pad designed by Drummers Collective Instructor and Ludwig artist Pat Petrillo.

The P4 pad consists of 3 different playing levels with 4 distinctly different pad surfaces. Each pad emulates the feel and response of a snare drum, tom or cymbal surface. It allows drummers to practice hand movements around the pad as if playing behind an actual drum kit. The pad conveniently screws into the top of an 8mm cymbal stand, or rests perfectly in a snare basket. Finally a single practice pad that is designed with the drum set in mind is now available courtesy of Pat Petrillo and Ludwig Drums.

PADDED GIG BAGS



Ludwig offers high quality gig bags at competitive prices with value added features that will provide the gigging drummer a good investment in protecting their drums.

Ludwig's Padded Gig Bags feature a sturdy handle for lifting, heavy duty zippers, adjustable shoulder strap for easy carrying, a metal snap hooks and rings, as well as double stitched webbed handles with black rubber tubing comfort grips. The snare drum bags also include a handy detachable shoulder strap. All Gig Bags are black.

SIDE PROTECTION SYSTEM BAGS



Ludwig's Side Protection System Bags feature durable plush lining and padded shoulder straps. Side Protection Bags also have the size stitched on the front.

Other features of Ludwig Gig Bags include metal snap hooks and rings, as well as double stitched webbed handles with black rubber tubing comfort grips. The snare drum bags also include a handy detachable shoulder strap. All SPS bags are black.

Gig Bags	Gig Bags "SPS"	Description
LXC1G	LXCSP	Gig Bag Cymbal 22"
LXC2G		Gig Bag Cymbal 22" w/ Stick Bag
LXS3G		Gig Bags Drum Set - Fits 18x22", 16x16", 11x13", 10x12", 6.5x14"
LX510G	LX510SP	Gig Bag Snare 5x10"
LX512G	LX512SP	Gig Bag Snare 5x12"
LX613G	LX613SP	Gig Bag Snare 6.5x13"
	LX514SP	Gig Bag Snare 5.5x14"
LX614G	LX614SP	Gig Bag Snare 6.5x14"
LX814G	LX814XP	Gig Bag Snare 8x14"
LX08G		Gig Bag Tom 8x8"
LX10G		Gig Bag Tom 9x10"
	LX10SP	Gig Bag Tom 10x10"
LX12G	LX12SP	Gig Bag Tom 10x12"
LX13G	LX13SP	Gig Bag Tom 11x13"
LX14G	LX14SP	Gig Bag Tom 14x14"
LX15G	LX15SP	Gig Bag Tom 13x15"
LX16G	LX16SP	Gig Bag Tom 16x16"
LX18G		Gig Bag Tom 16x18"
	LX18SP	Gig Bag Tom 18x18"
LX20G		Gig Bag Tom 18x20"
LX18BG		Gig Bag Bass 18x18"
	LX20SP	Gig Bag Bass 18x20"
LX22G	LX22SP	Gig Bag Bass 18x22"
LX24G	LX24SP	Gig Bag Bass 18x24"
LX25G	LX25SP	Gig Bag Hardware 36"
LX29G	LX27SP	Gig Bag Double Pedal
	LX31SP	Gig Bag Bongo 9x7"
LX30G		Gig Bag Drum Sticks, Economy
LX31G		Gig Bag Drum Sticks, Premium





John Fred Young
Black Stone Cherry



Marty Richards
The Joe Perry Project



Alex Rodriguez
Saosin



David Goodstein
Daniel Powter



Brad Morgan
The Drive-By Truckers



Joey Cassata
ZO2



Brian St. Clair
Local H



Cliff Sarcona
As Tall As Lions



Chad Kinner
John McLaughlin



Ira Elliot
Nada Surf



Michael D'Amico
Brian Wilson



John Eriksson
Peter, Bjorn and John



Fab Moretti
The Strokes



Steve Fidyk



Jason Boesel
Rilo Kiley



Scott Churilla
The Supersuckers



Clive Deamer
Robert Plant



Daxx Nielsen
Cory Chisel and
the Wandering Sons



Scott Reeder
Fu Man Chu



Steve Riley
LA Guns



Dusty Watson
Agent Orange



Kurt Dahle
The New Pornographers



Fred Eltringham
The Wallflowers



Erik Skodis
Roger Joseph Manning, Jr.



Jason Sutter
Chris Cornell



Jeff Freidl
Ashes Divide



Paul Simmons
Reverend Horton Heat



Ron Gannaway
Gretchen Wilson



Steve Misamore
Dierks Bentley



John Cowstill
The Beach Boys



Pat Petrillo



John Spittle
Trace Adkins



Tony Snow
Dramarama



Jess Margera
CKY



Alex Noyes
Honor Society



David Parks
LoCash Cowboys



Ben Sesar
Brad Paisley



Anthony Buruclich
The Bravery



Chris Deaner
plus/minus



Alicia Warrington
LA Studio
All Girl Boy's Choir



Mario Calire
Ozomatli



Ralph Castelli
RAIN



Sam Fogarino
Interpol



Tony Hammons
Montgomery Gentry



Al Wilson
Taylor Swift



JJ Johnson
John Mayer



Jon "Bermuda" Schwartz
"Weird Al" Yankovic



Ned Brower
Rooney



Gary Stanionis



Franklin Vanderbilt
Lenny Kravitz



Ryan Hoyle
LA Studio



Carl Palmer
Asia/ELP



Matt Sorum
Velvet Revolver



Alan White
Yes



Steve Gorman
The Black Crowes



Patrick Keeler
The Raconteurs



James Heatley
The Answer



Bobby Rondinelli
Over The Rainbow



Corey Miller



Butch Miles



Ringo Starr



Jason Bonham
Led Zeppelin



Bun E. Carlos
Cheap Trick
Tinted Windows



Alex Van Halen
Van Halen



Ed Shaughnessy



Jason McGerr
Death Cab For Cutie



Clayton Cameron



Frankie Banali
Quiet Riot



Bryan Hitt
REO Speedwagon



Jim Riley
Rascal Flatts

Ludwig

BE A LEGEND. JOIN THE FAMILY.