

# **Service Manual**

# OBSX

# **Polyphonic Synthesizer**

**First Edition  
September 1979**

**Oberheim Electronics, Inc.  
1455 19th Street  
Santa Monica, Ca 90404**

CALIBRATION PROCEEDURES

- Control Board Calibration
- Voice Card Replacement and Calibration
- Power Supply Calbiration
- Mother Board Calibration

DIAGRAMS

- Wiring Block Diagram
- Sub-Assembly and Connector Placement Diagram
- Control Board and Voice Card Trimmer Placement Diagram
- Power Supply and Mother Board Trimmer Placement Diagram

SCHEMATICS

- Power Supply Schematic
- Processor, Control, Pots and Keyboard Schematic (4 Sheets)
- Mother Board Schematic
- Voice Card Schematic
- Bend Assembly Schematic
- Rear Panel Schematic

PRINTED CIRCUIT COMPOSITES

- Control Board Composite
- Processor Board Composite
- Mother Board Composite
- Power Supply and Voice Card Composites

ENGINEERING CHANGE ORDERS (5 Sheets)

INTERCONNECT LISTS

- Control Board Interconnect List
- Power Supply Board Interconnect List
- Pot Board Interconnect List
- Mother Board Interconnect List

## CONTROL BOARD CALIBRATION

---

This document describes the procedure for calibrating the OB-X Control board. The following equipment is required:

Digital voltmeter (4 1/2 digits minimum)  
Oscilloscope  
Audio amplifier with speaker or headphones  
(Note: Headphones may be plugged directly into the OB-X providing they are wired monophonically and have an input impedance of at least 600 ohms.)

This procedure makes reference to notes C0 through C4. C0 is low C on the keyboard, and C4 is high C. Refer to the Control Board and Voice Card Trimmer Placement Diagram for locations of trimmers to be adjusted.

Set the following front panel controls as indicated:

Manual	-	On
Unison	-	On
Portamento	-	Minimum (full CCW)
VCO1 Frequency	-	Minimum (full CCW)
VCO2 Frequency	-	Minimum (full CCW)
VCO2 Detune	-	Center (LED off)
Volume	-	As desired

All voltage measurements should be referenced to ground at connector pin A8.

### DAC CALIBRATION

Using the DVM, monitor KEYCV1 at connector pin M9. Depress key C0 and note the voltage; this is the offset voltage and it should be 0.000 v +/- 15 mv. Depress C1 and adjust trimmer T9 so that KEYCV1 is 1.000 v +/- 2 mv more than the offset voltage. Repeat this procedure for each octave (C2, C3, and C4) to obtain KEYCV1 voltages of 2.000 v, 3.000 v, and 4.000 v +/- 2 mv more than the offset.

### BEND CIRCUIT CALIBRATION

Turn Unison off, and set the switches on the Bend assembly as follows:

Up Octave/Down Octave	-	Down Octave
Narrow/Broad	-	Broad
VCO2 Only/Both	-	Both

Monitor the voltage at pin 1 of the 324 at location A1, and adjust trimmer T4 for 0.000 v +/- 20 mv.

Measure the VCO1 Frequency control voltage, VCO1F, at connector pin N1. This voltage, which should be 0.000 v +/- 25 mv, is the Bend pot offset voltage. This offset voltage must be added to (or subtracted from) the voltages stated for the following Bend circuit adjustments; e. g., if the offset voltage is -20 mv, T1 would be adjusted for 0.980 v and T2 would be adjusted for -1.020 v.

Move the Bend lever fully towards the front of the unit, and adjust trimmer T1 for 1.000 v +/- 2 mv.

Move the Bend lever fully towards the rear of the unit, and adjust trimmer T2 for -1.000 v +/- 2 mv.

Set the Narrow/Broad switch to Narrow, move the Bend lever fully to the front, and adjust trimmer T3 to 0.167 v +/- 2 mv.

Set the Octave switch to its center position, and adjust trimmer T6 for 1.000 v +/- 2 mv.

Set the Octave switch to the Up position, and adjust trimmer T7 for 2.000 v +/- 2 mv.

#### LFO RATE CALIBRATION

Set the LFO Rate pot to maximum (full CW). Observe the triangle wave with an oscilloscope at pin 7 of the 324 at location A11, and adjust trimmer T5 to obtain a period of 50 +/- 5 msec.

#### PORTAMENTO CALIBRATION

Set the Portamento pot to maximum (full CW). While alternately playing two keys one octave apart, adjust trimmer T8 to obtain maximum portamento; i. e., the maximum time period for the oscillators to change from one pitch to the other after a key is depressed. With T8 adjusted for maximum portamento, this time period may be anywhere from 1 to 2 1/2 seconds for a one octave change, and the variation among voices may be as much as a 2 to 1 ratio between the shortest and longest periods.

## VOICE CARD REPLACEMENT AND CALIBRATION PROCEDURE

---

This document describes the procedure for replacing and calibrating voice cards in the OB-X. The following equipment is necessary for calibration:

- Digital voltmeter (3 1/2 digits minimum)
- Oscilloscope (optional)
- Audio amplifier with speaker or headphones  
(Note: Headphones may be plugged directly into the OB-X provided they are wired monophonically and have an input impedance of at least 600 ohms.)

This procedure makes reference to notes C0 through C4. C0 is low C on the keyboard, and C4 is high C. Refer to the Control Board and Voice Card Trimmer Placement Diagram for locations of the trimmers to be adjusted.

### VOICE CARD REPLACEMENT AND PRELIMINARY CONTROL SETTINGS

Locate the defective voice card, and replace it with a new card.

**CAUTION: A.C. POWER MUST BE OFF DURING CARD REMOVAL AND REPLACEMENT.**

As an aid in determining which card in a unit is defective, it should be realized that touching the "tempco" resistors (refer to the Trimmer Placement Diagram) on a voice card which is gated on will cause a significant change in pitch of the oscillators on that card. With Unison off, a defective card can thus be located by stepping through the voices, using the keyboard, until the defective voice is gated on. While holding this voice on, touch the tempco resistors on each card until a pitch change is heard, thus identifying the bad card.

With a new voice card installed, close the cover, turn on power, and wait 15 minutes to allow the unit to warm up. Plug the amplifier or headphones into the Left Output jack. Set the following switches and controls as indicated:

- Manual - On
- Unison - On
- Volume - As desired
- Master Tune - Center (dead zone)
- Test 1 - Down (the Test switches are located inside the unit at the bottom of Pot Board No. 2)

Set the Pan pots on the Mother Board to full Left (full CCW) position for the new voice and for one known, calibrated voice to be used as a reference; set all other Pan pots to full Right. (Refer to the Power Supply & Mother Board Trimmer Placement Diagram for locations of the Pan pots.)

## VCO1 CALIBRATION

### Initial Frequency Adjustment

Set switches and controls as follows:

VCO1	- On
VCO2	- Off
VCO1 Waveform	- Pulse
VCO2 Waveform	- Pulse
VCO2 Detune	- Center (LED off)
Filter Frequency	- Maximum (full CW)
Loudness Sustain	- Center or more CW
All other parameters not otherwise set - Full CCW or Off	

Hold note C3 and adjust trimmer T4 until the frequency of the new voice is beatless with the reference voice.

NOTE: The following two adjustments, Volt/Octave and Hi-Track, are performed at the factory and normally do not require readjustment upon installation of the card in a unit. However, they should be performed if the voice does not sound right after the rest of the adjustment procedure has been performed.

### Volt/Octave Adjustment

Hold note C0 and adjust trimmer T8 until the voice is beatless with the reference. Hold note C3 and determine if still beatless; if not, repeat the Initial Frequency adjustment. It is sometimes necessary to repeat the Initial Frequency and Volt/Octave adjustments a few times in order to obtain proper tracking of the voice card to the keyboard.

### Hi-Track Adjustment

Hold note C5 and adjust trimmer T5 until beatless. Recheck the Initial Frequency and Volt/Octave adjustments, and repeat if necessary.

### Pulse Width Adjustment

Set the Pulse Width pot on the front panel to full CCW, and adjust trimmer T6 for a 50% duty cycle. If an oscilloscope is available, the voice output can be monitored at connector pin G2; if the adjustment is being made by ear, adjust T6 for the most "hollow" sound. (The reference voice can be eliminated during this adjustment by turning its Pan pot fully CW.)

## VCO2 CALIBRATION

VCO2 is calibrated by repeating the above procedure, with VCO1 off and VCO2 on, and adjusting the following trimmers:

Initial Frequency - T1  
Volt/Octave - T7  
Hi-Track - T2  
Pulse Width - T3

#### FILTER CALIBRATION

Set the front panel controls and switches as follows:

VCO1 - Off  
VCO2 - Off  
Noise - Full  
KBD Track - On  
Filter Frequency - Minimum (full CCW)  
Modulation - Minimum (full CCW)  
Resonance - Maximum (full CW)

#### Initial Frequency Adjustment

Hold note C3 and, using the Pan pots to control the audio, listen to the two voices (new card and reference) alternately. Adjust trimmer T9 to tune the card being calibrated to the same pitch as the reference.

#### Volt/Octave Adjustment

Hold note C2 and adjust trimmer T10 until the voice is the same pitch as the reference. Hold note C3 and check the Initial Frequency adjustment; repeat these two adjustments as necessary. Hold note C4 and again adjust trimmer T10 until the two voices have the same pitch. Recheck the Initial Frequency at C3 and readjust as necessary. (Note: the filter will track the keyboard over only an approximately three octave range.)

#### VCA OFFSET

With both oscillators off, gate the voice on (depress any key). Measure the voltage at pin 6 of the TL081 at location A17 with a DVM, and adjust trimmer T11 for 0.000 v +/- 10 mv.

CAUTION: AT THE CONCLUSION OF THIS PROCEDURE  
BE SURE TO DO THE FOLLOWING:

TURN OFF THE TEST 1 SWITCH (SET TO THE UP POSITION)

RETURN THE PAN POTS TO THEIR ORIGINAL POSITIONS

ON 6- AND 8-VOICE UNITS, RECONNECT THE CABLES TO  
MOTHER BOARD NO. 2 AND REINSTALL THE RETAINING SCREWS

## POWER SUPPLY CALIBRATION

---

This document describes the procedure for calibrating the OB-X Power Supply board. The only two voltages requiring calibration are +19 v and -19 v; all other voltages are developed by 3-terminal regulators having no adjustment capability.

Using connector pin F2 as the ground reference, monitor the voltage on pin F1 and adjust trimmer T102 for +19.0 v +/- 200 mv. Monitor the voltage at pin F4 and adjust trimmer T101 for -19.0 v +/- 200 mv.

The other voltages generated on the Power Supply board should also be checked to assure that they are within tolerance, as follows:

E1	- 5.0 v +/- 250 mv	-5.05
- E3	+12.0 v +/- 600 mv	-0.64
E4	+ 4.8 v +/- 250 mv	4.49
E6	+ 5.0 v +/- 250 mv	5.05
- E7	+15.0 v +/- 750 mv	-1.03
E9	-15.0 v +/- 750 mv	-15.04

Note: Pin E4 should measure a minimum of 2.3 v with power off (this is the backup battery voltage for the program memory).

- 20

0.09



This document describes the procedure for calibrating the OB-X Mother board. Calibration consists of adjusting the two distortion trimmers, T201 and T202. For this procedure the front panel Volume pot must be set to maximum (full CW), and no keys on the keyboard should be depressed.

Using a DVM, monitor the output (pin 6) of the final TL081 in the right channel and adjust trimmer T201 for 0.00 v +/- 20 mv. Repeat this procedure for the left channel, adjusting trimmer T202.

As an alternative, an audio method of calibration can be used. Plug an amplifier with a speaker or headphones into the Right Output jack, hold down the Auto Tune switch on the front panel, and adjust T201 for minimum loudness of the "thump". Repeat for the left channel.

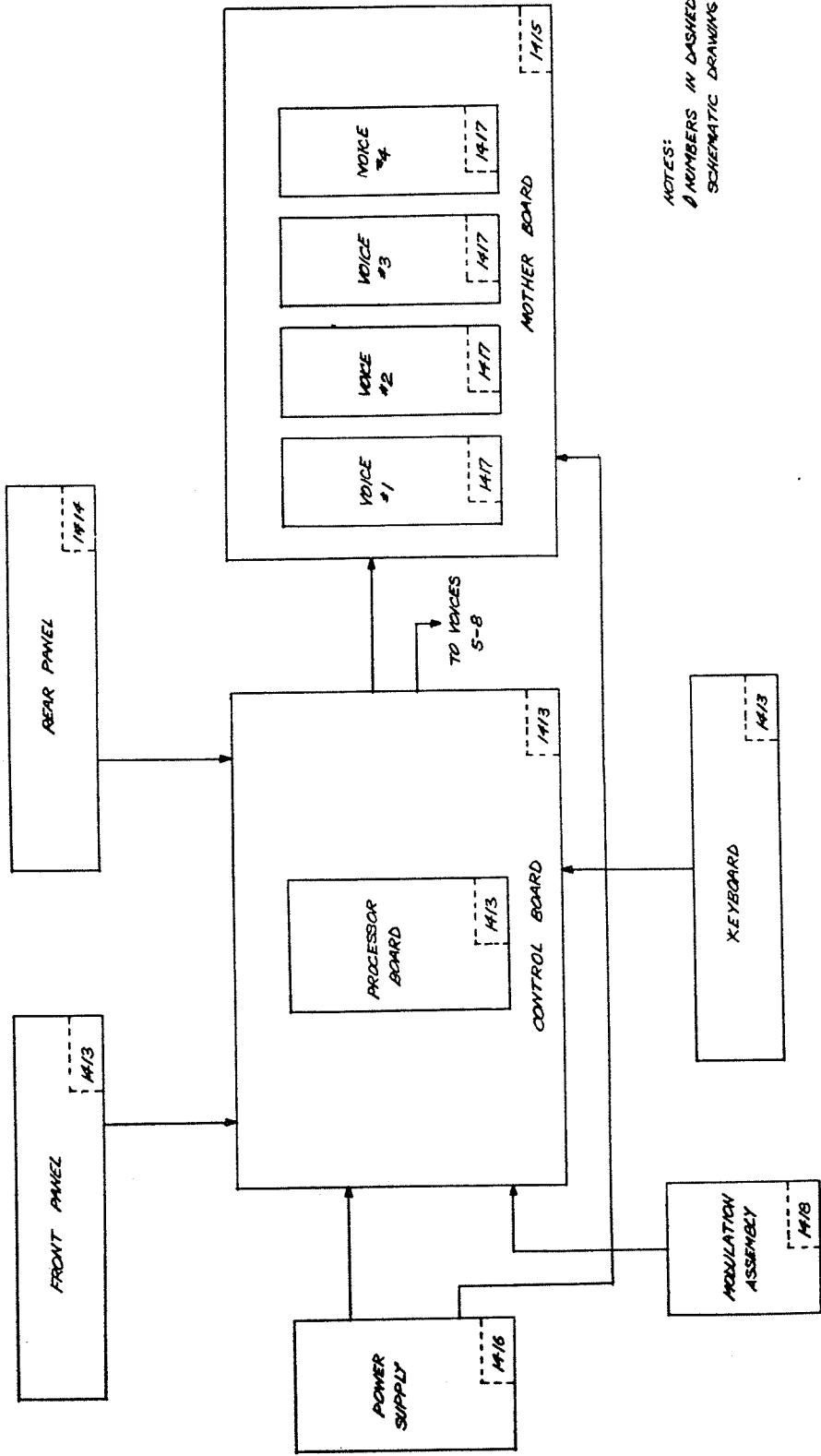

NOTES:  
 Ø NUMBERS IN DASHED BLOCKS INDICATE  
 SCHEMATIC DRAWING NUMBERS

OBERHEIM ELECTRONICS, INC.  
 OB-X WIRMS BLOCK DIAGRAM  
 9-7-79



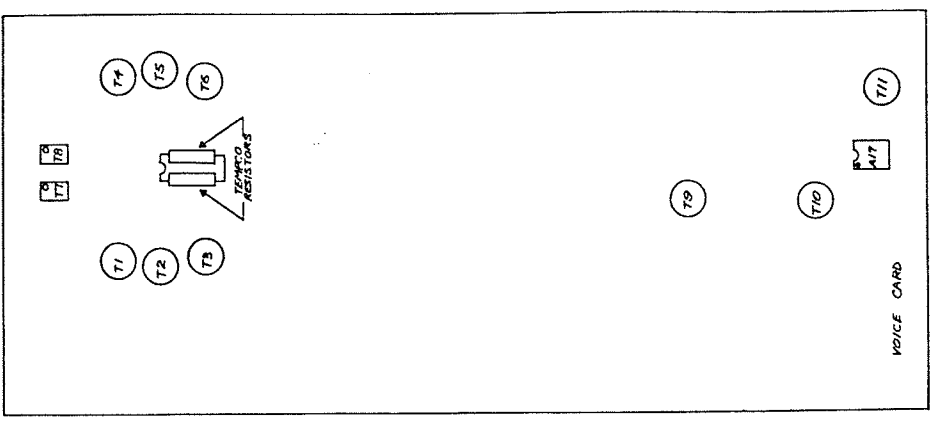
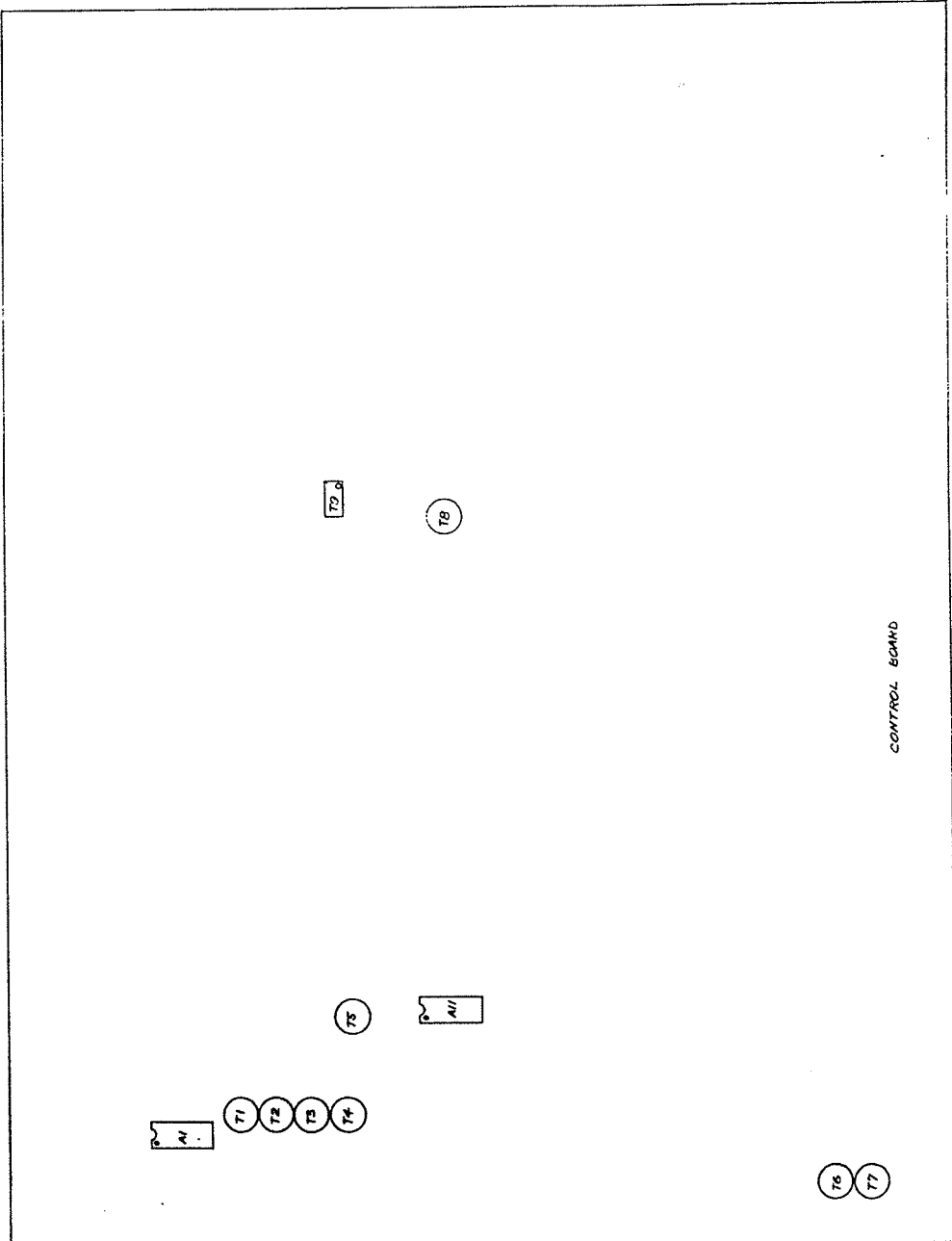

OBERHEIM ELECTRONICS, INC.  
 ON-X CONTROL BOARD & VOICE CARD  
 TRIMMER PLACEMENT DIAGRAM  
 9-18-78  
 1425

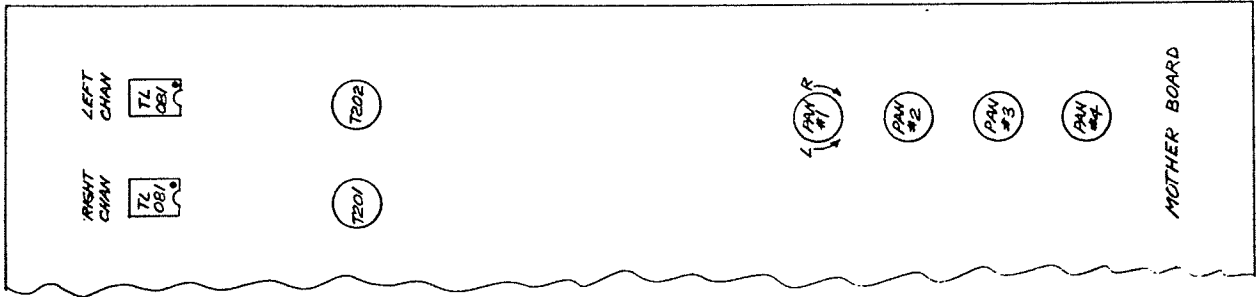
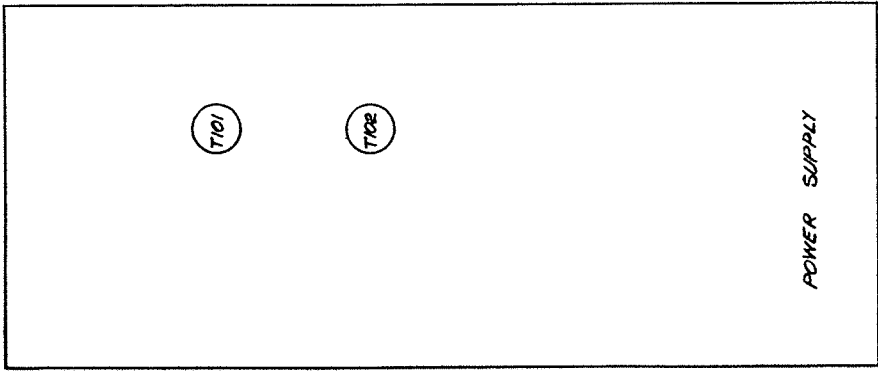

OBERHEIM ELECTRONICS, INC.

OS-X POWER SUPPLY & MOTHER BOARD  
TRIMMER PLACEMENT DIAGRAM

9-19-79

1426









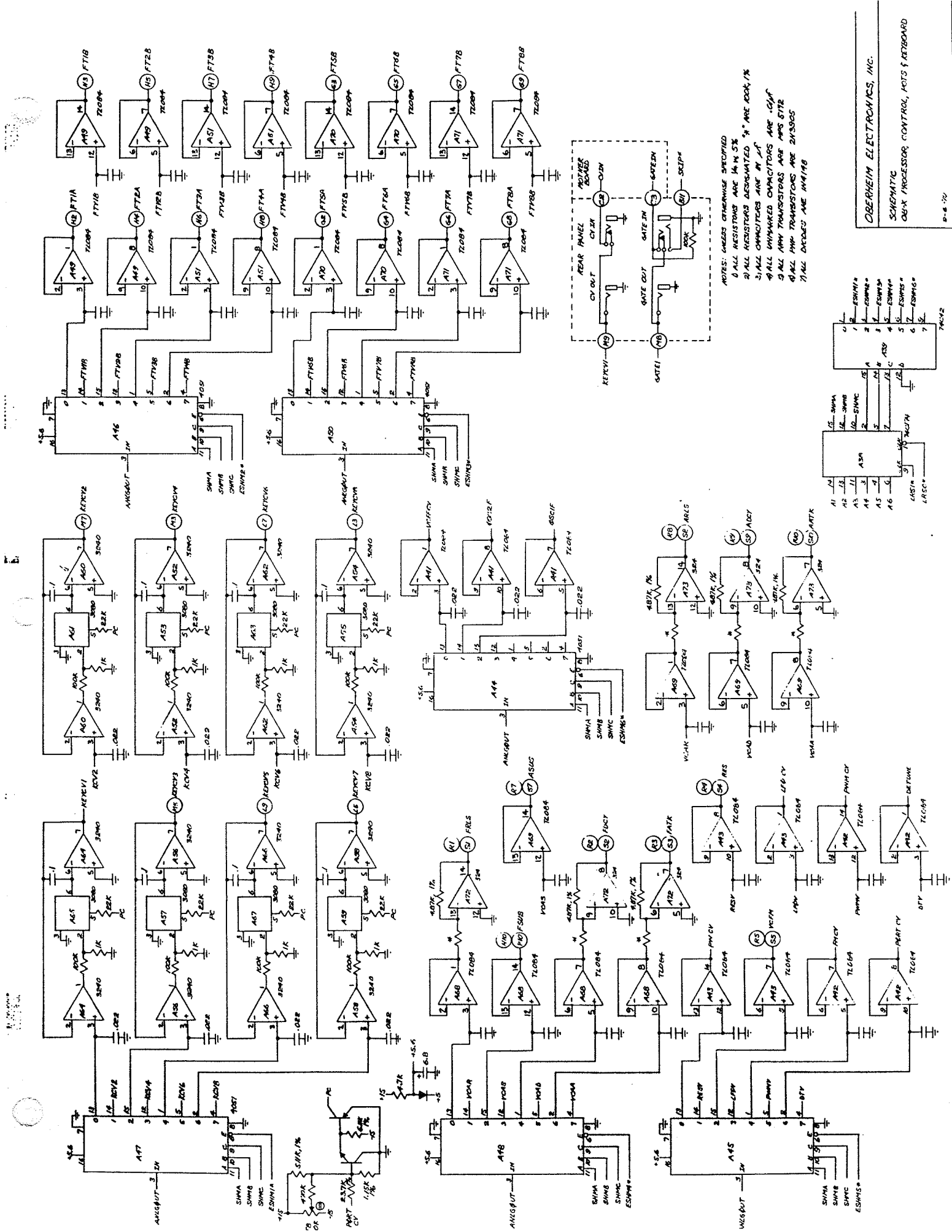

- NOTES: UNLESS OTHERWISE SPECIFIED  
 1. ALL RESISTORS ARE 1/4 W. 5%  
 2. ALL RESISTORS DESIGNATED "K" ARE 1000 Ω  
 3. ALL UNMARKED CAPACITORS ARE .01 μF  
 4. ALL PNP TRANSISTORS ARE MPS 6712  
 5. ALL NPN TRANSISTORS ARE 2N3906  
 6. ALL DIODES ARE 1N4148

OBERHEIM ELECTRONICS, INC.  
 SCHEMATIC  
 CPUX PROCESSOR CONTROL, KOTS & KEYBOARD



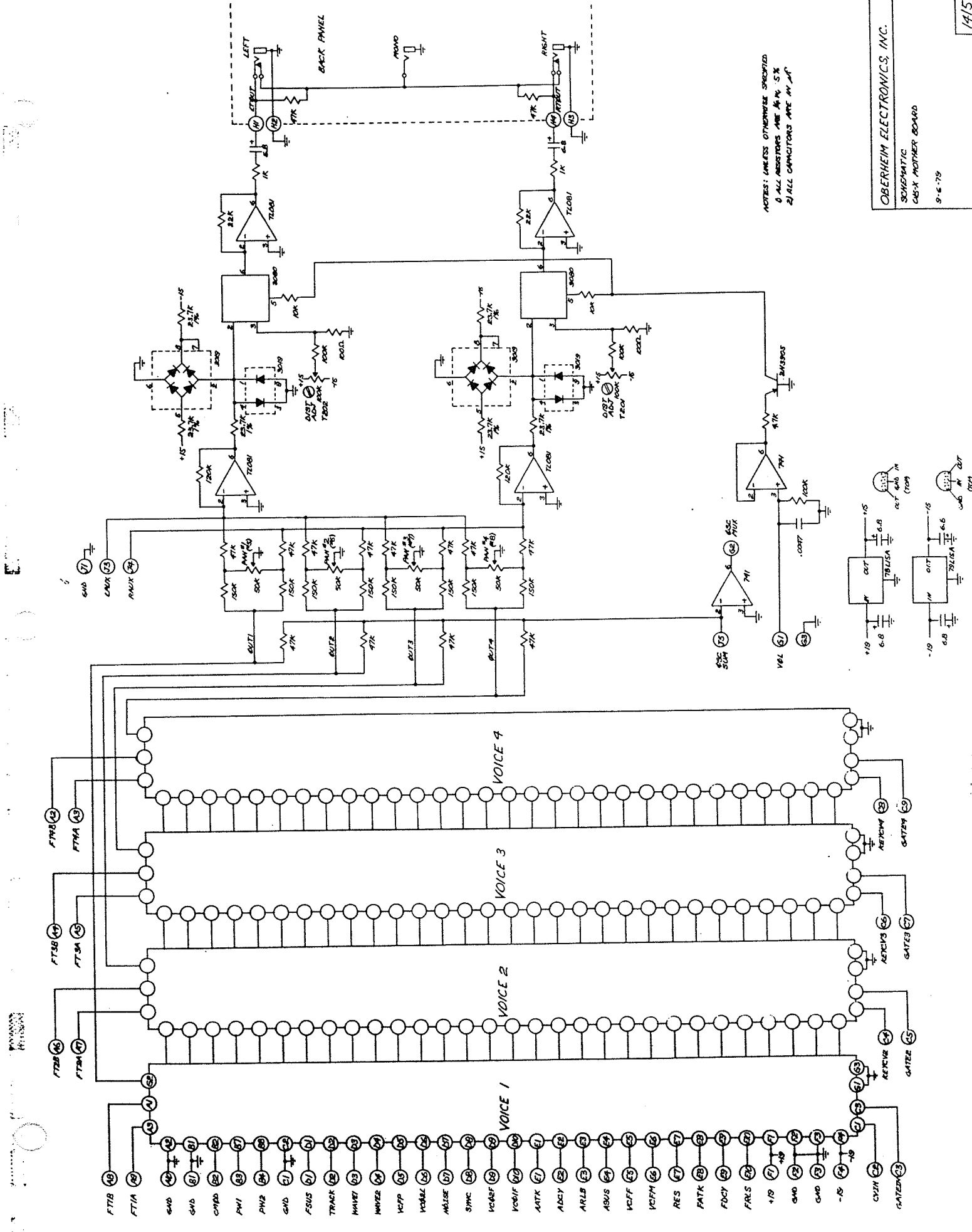

NOTES: UNLESS OTHERWISE SPECIFIED  
 1) ALL RESISTORS ARE IN  $\Omega$ , K, M, S, X  
 2) ALL CAPACITORS ARE IN  $\mu$ F

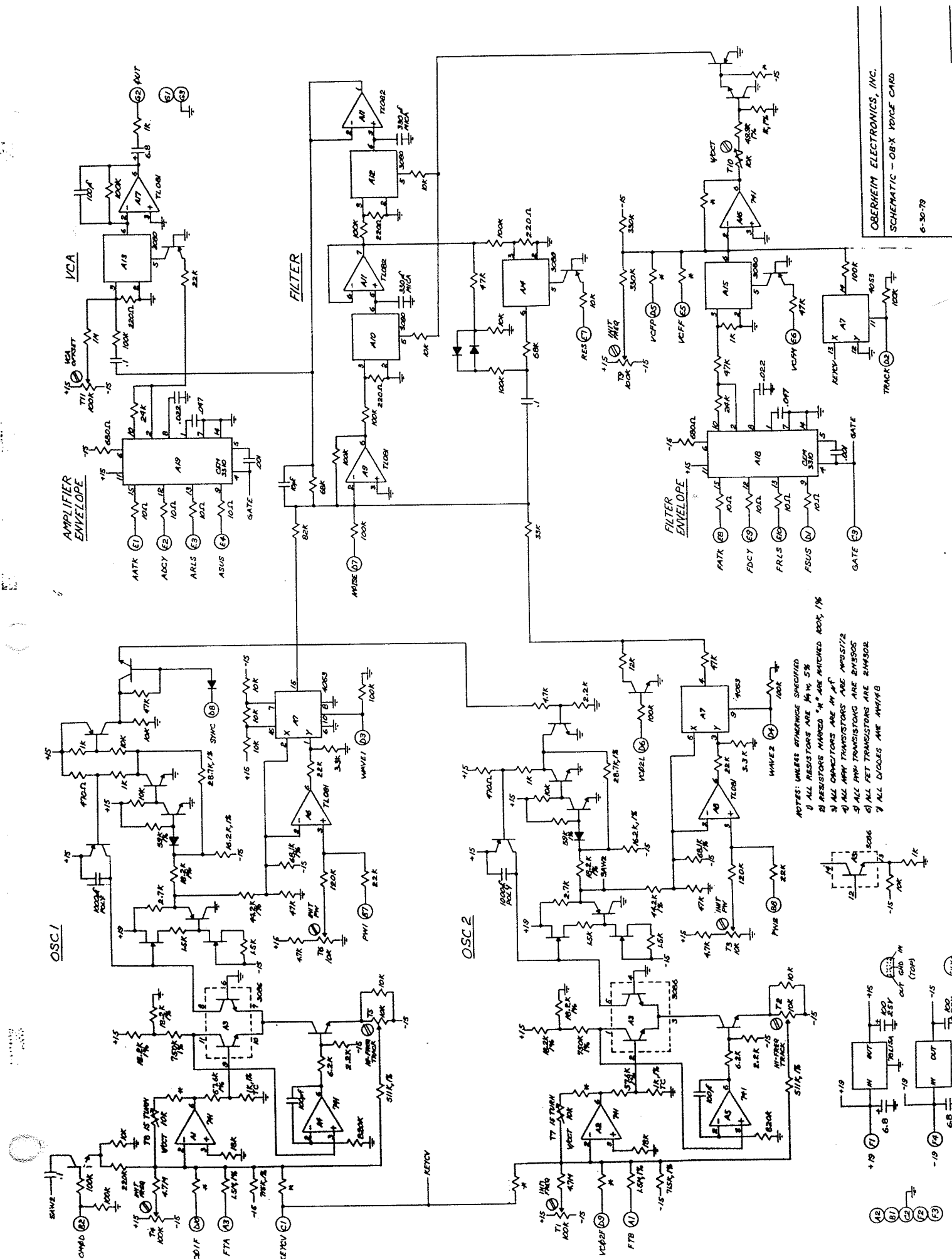

- NOTES: UNLESS OTHERWISE SPECIFIED
- 1) ALL RESISTORS ARE 1/4 W 5%
  - 2) RESISTORS MARKED "M" ARE MATCHED 100K 1%
  - 3) ALL CAPACITORS ARE MFD
  - 4) ALL PNP TRANSISTORS ARE MPS4272
  - 5) ALL PNP TRANSISTORS ARE 2N4302
  - 6) ALL PNP TRANSISTORS ARE 2N4302
  - 7) ALL DIODES ARE 1N4148

OBERHEIM ELECTRONICS, INC.  
SCHEMATIC - OBX VOICE CARD  
6-30-79