ProTone

MIDI Analog Synthesizer

Service Manual

Copyright © 1996-2001 by Spectral Audio, Switzerland

CAUTION!

All instructions in this manual must be carried out by a professional who observes the valid safety regulations. In operation, they have got dangerous voltages in the instrument. Spectral Audio GmbH accepts no liability for personal injury or material damage.

1	Description of the Operating Elements	3
1.1	Sockets on the Rear of the Housing	3
1.2	Front Panel Controls	4
2	Functional Description	5
3	History of Series	7
4	Improvements and explanations	7
4.1	Sense of R174 and R175	7
4.2	Sense of C63 – C65	7
4.3	Sense of R174 and R175	8
4.4	Hum Problems	8
4.5	Increasing the Gate voltage to +12V	8
5	Adjustment of the ProTone	9
5.1	Digital PCB (MIDI to CV converter)	9
5.2	Analog PCB (VCO1 and VCO 2)	9
5.2.1	VCO1	9
5.2.2	VCO2	9
6	Digital PCB	11
6.1	Assembly plan	11
6.2	Part list	11
7	Analog PCB	13
7.1	Assembly plan	13
7.2	Part list	15
8	Mechanical part list	20

1 Description of the Operating Elements

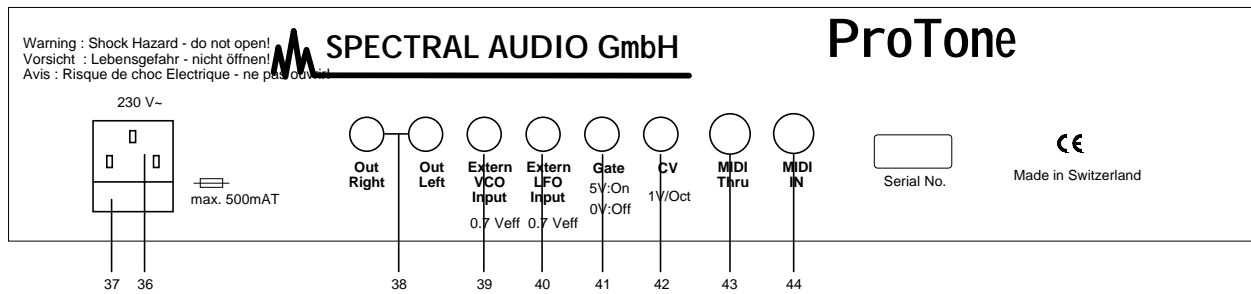

1.1 Sockets on the Rear of the Housing

- 36. Power socket
- 37. Fuse compartment, fuse max. 500 mA, 250V type
- 38. Audio outputs right / left
- 39. External VCO input, switched on with switch (7)
- 40. External modulation input, selected with selector switch (22)
- 41. Gate input/output (dependent on the jumper setting inside the unit, standard setting: output)
- 42. CV input / output (dependent on the jumper setting inside the unit, standard setting: output)
- 43. MIDI Thru socket
- 44. MIDI IN socket

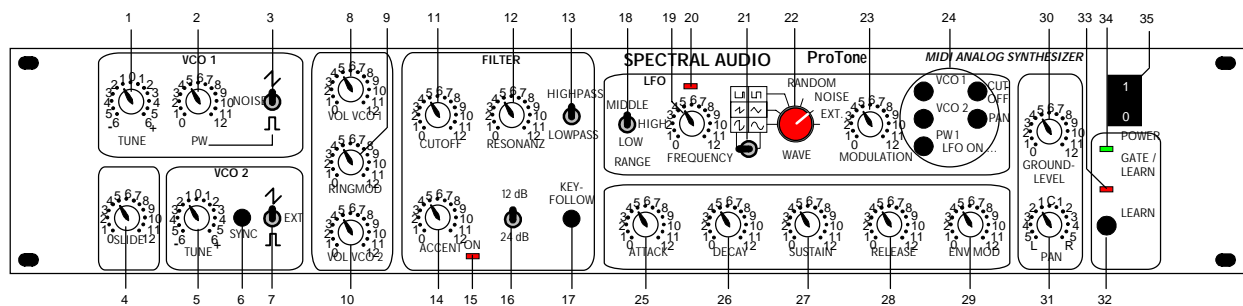

1.2 Front Panel Controls

VCO 1:

1. TUNE: Regulates the pitch of the VCO 1
2. PW: Pulse width of the rectangular pulse
3. Changeover between the signal types saw tooth, noise and rectangle
4. SLIDE: regulates the time balance of VCO 1 and VCO 2

VCO 2:

5. TUNE: Regulates the pitch of the VCO 2
6. SYNC: Synchronises VCO 2 with VCO 1
7. Changeover between the signal types saw tooth, external (input on rear of housing) and rectangle

Mixer:

8. VOL VCO 1: Volume of VCO 1
9. RINGMOD: Volume of the ring modulation of VCO1 and VCO2
10. VOL VCO 2: Volume of VCO 2

VCF:

11. CUTOFF: Cut-off frequency of the filter
12. RESONANCE: increases the harmonics at the cut-off point
13. Changeover between lowpass and highpass
14. ACCENT: Pulsed increase of the cut-off frequency and the volume
15. ACCENT ON Indicator: Lights when the accent function is switched on (MIDI Controller 65)
16. Determines the edge steepness of the filter: 12 or 24dB / octave
17. KEYFOLLOW: The cut-off frequency is influenced by the actual note

LFO:

18. RANGE: Changeover between three LFO frequency ranges
19. FREQUENCY: Setting the LFO frequency
20. LFO Indicator: Indicates each positive half wave of the LFO.
Note: The eye recognises frequencies larger than 60 Hz as being static.
21. Changeover between symmetrical and asymmetrical LFO waveforms
22. Selector switch for different LFO waveforms. By means of the matrix presentation, there are a total of 9 signal forms available: sinus, asymmetrical sinus, triangle, saw tooth, rectangle, pulse, random, noise and external (input on the rear of the housing)
23. MODULATION: Determines the strength of the LFO influence
24. LFO ON...: LFO assignment possibilities: VCO 1, VCO 2, PW 1, cut-off, pan (any combination possible)

Envelope:

25. ATTACK: Rise time
26. DECAY: Decay time
27. SUSTAIN: Hold level
28. RELEASE: Release time
29. ENV MOD: Influences the cut-off frequency with the envelope

Stereo VCA:

30. GROUNDLEVEL: Ground level of the unit. This also includes the volume increase influenced by the accent.
31. PAN: Regulates the relationship of the volume from the left and right-hand channel

Various:

32. LEARN Key; Switches the ProTone to the learn mode
33. GATE / LEARN indicator
34. Switch-on indicator
35. Main switch

2 Functional Description

The basic principle of the ProTone corresponds to the tried and tested analog synthesizer principle with VCO, VCF, VCA, envelope generator and LFO. This principle is called subtractive synthesis.

In order that the ProTone is suitable for MIDI, an additional MIDI to CV converter is necessary which converts the MIDI signals into analog signals with which the VCOs, the filter, as well as the envelope generator are controlled.

The raw material for the sound is offered by the VCOs (Voltage Controlled Oscillator) in the form of a sawtooth or rectangular signal as well as the noise generator (for effects such as wind and thunder sounds). The width of the rectangular signal from VCO1 can be changed with the PW regulator (2). The narrower the rectangular signal (regulator turned to the right), the 'sharper' the sound. VCO2 is synchronised from VCO1 with the SYNC switch (6). The tone will be interesting in this case when the TUNE regulator (5) of VCO2 is turned (or by modulating with the LFO VCO 2), which results in a typical "Sync-Sound".

By means of the external VCO input, other sounds can also serve as raw material. The ring modulator multiplies the signals of the two VCOs which markedly amplifies the beat (frequency difference).

Note: When the SYNC switch (6) is switched on, no beats are developed and the ring modulator has therefore no effect.

The SLIDE regulator (4) determines the time balance from one note to another and is valid for both VCOs.

Afterwards, the signal flows through the voltage controlled filter (VCF=Voltage Controlled Filter), within which certain frequency ranges are suppressed. The lowpass filter allows low frequencies to pass and suppresses the high ones, the highpass filter lets high frequencies through and suppresses the low ones. The frequency from which the signals are suppressed is called the limit or cut-off frequency. With the ProTone, this is formed from various sources:

1. CUTOFF frequency regulator (11)
2. ENV MOD regulator (29) (influence of the envelope on the cut-off frequency)
3. LFO
4. ACCENT regulator (14)
5. KEYFOLLOW switch (17).

With the KEYFOLLOW switch (17), the cut-off frequency increases on higher notes so that audible frequency bands always remain the same. The resonance forms a feedback of the output to the input of the filter and causes an amplification of the frequencies around the cut-off frequency.

The ACCENT regulator (14) sets the share of the second envelope and affects the cut-off frequency as well as the volume. It is only active when the ACCENT indicator (15) lights, i.e., when the accent function is switched on via the MIDI controller 65. The accent function is always active when the unit is switched on. By means of the MIDI controller 65, it is now possible, as with the TB 303, to give individual notes an accent (value 127) or to take an accent away (value 0). For this purpose, the corresponding control value must be sent in the sequencer, timed either before or with the note.

Before the signal leaves the ProTone, it arrives at the VCA (Voltage Controlled Amplifier) which is available in the ProTone in stereo form. Here the input signal is multiplied with a control signal. In this way, the volume can be influenced by a control signal which comes from the envelope generator and the MIDI converter. The volume of the ProTone is controlled with the GROUND LEVEL regulator (30) as well as via the MIDI controller EXT (7). Additional to this level is the short-term increase through the accent function. The panorama (volume relationship of the left-hand to the right-hand signal) can be set with the PAN regulator (31).

The LFO is particularly developed with the ProTone. Using its signal, the pitch from VCO1 and VCO2, the pulse width of the rectangular signal from VCO1, the cut-off frequency of the filter as well as the panorama can be modulated with the LFO ON ... switches (24).

With switches (21) and (22) selection can be made between 9 different signal forms. By means of the external LFO input on the rear of the housing, it is also possible to use any other signal for modulation. To do this, switch (22) must be turned completely to the right. A microphone, etc, must be connected via a pre-amplifier as this is a high level input. When the external inputs of the ProTone are used, the ProTone must simultaneously receive a note command (the same MIDI channel) in order that something is audible.

The envelope generator determines the chronological sequence of the volume after receiving a note command. The MIDI to CV converter then gives out a gate signal (+5V) with which the sequence of the envelope generator begins. The gate signal remains at +5V until the 'note off' command comes, i.e., the key is

released. The parameters of the envelope can be set with regulators (25) to (28). How the envelope should be imagined is described later on in the glossary.

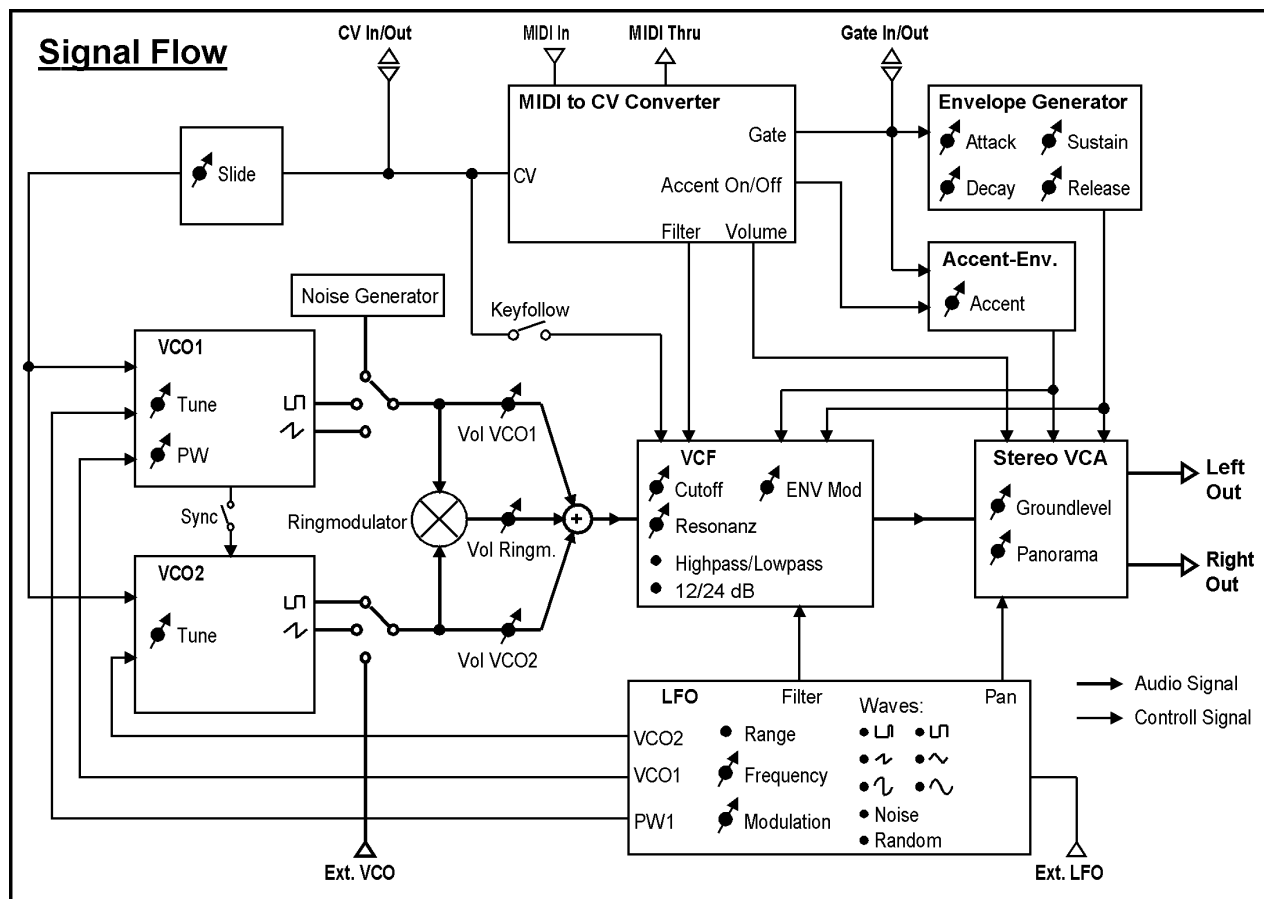

3 History of Series

There were 3 different series made:

Serie # 1 : 960000 .. 960020 with golden front panel

Serie # 2 : 960021 .. 960161 with red front panel, C66 and C67 added

Serie # 3 : 960162 .. 960470 with red front panel, now with switch and trafo for 115V / 230V; R173, R174, C63-C65 inbuilt; R174 and R175 (NTCs) added (by hand); GND Connection to case

This manual describes the last series.

This manual contains no the hole schematics. Spectral Audio may send it to you for important reasons, please write to info@spectralaudio.ch.

4 Improvements and explanations

4.1 Sense of R174 and R175

These two resistors help to increase the lower limit of the cutoff frequency. Otherwise a ploop-noise may occur when reaching 0 Hz cutoff frequency with a high resonance. You may reach the 0Hz using the LFO.

They are in series connected from U20 pin 16 to GND.

4.2 Sense of C63 – C65

With time, the pots may become noisy. You may hear this effect especially at the Cutoff pot. Using the C63 – C65 solve this problem.

They are connected from the middle pin (+) of the pot to GND (-). Resonance has negative voltage, so middle pin is (-) and GND is (+):

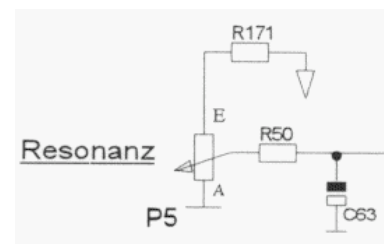
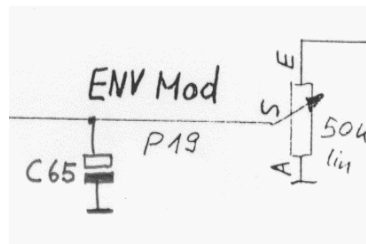
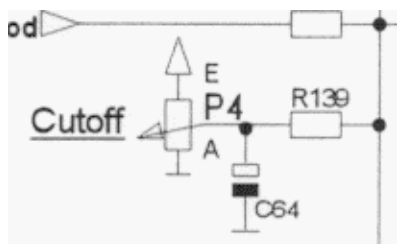

4.3 Sense of R174 and R175

These NTC resistors improves the temperature stability of the two VCOs a lot. It is important that, if you add these NTCs, also change the resistors R81 and R86 to 5k1. Use hot glue to glue them onto U16. Solder them parallel to R81 and R86:

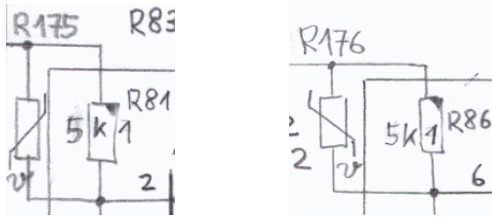

After this change, a readjustment must be done.

4.4 Hum Problems

In some circumstances, the internal connection from GND to the metal case creates a hum noise because of closed earth loops.

In this case it may help to cut this internal GND connection.

You will find it (on later Proton's series only) on the digital pcb, a pretty wide track to one screw. Cut it with a sharp cutter.

4.5 Increasing the Gate voltage to +12V

To increase the Gate voltage from +5V to +12V, two additional resistors and one NPN transistor are necessary.

Apart from this, port 1.3 (pin 4) of the microprocessor must be connected to GND that the gate signal output from the microprocessor is inverted.

The circuit change appears as follows:

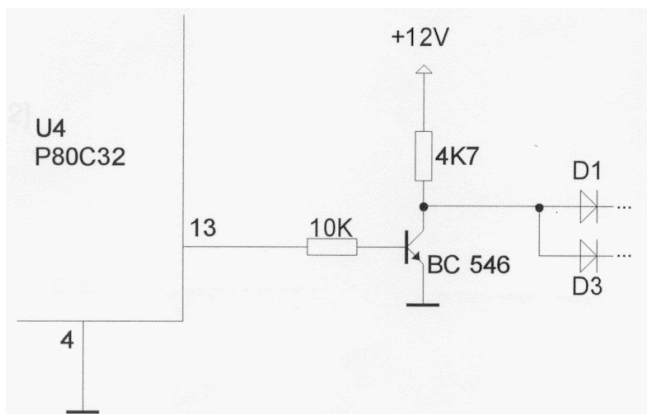

5 Adjustment of the ProTone

5.1 Digital PCB (MIDI to CV converter)

The slope of the control voltage CV is set with trimmer R10. Octave jumps which are initiated via MIDI-IN, must result in a 1.00 V change.

For this purpose, an accurate voltmeter must be connected to the CV socket J3 and the reference note (default: 36=C1) initiated and the voltage value noted (some mV). Now initiate the MIDI note four octaves higher (C4) and adjust R10 so that the voltage is 4.00 V higher. Check the reference note again and repeat the adjustment if necessary.

5.2 Analog PCB (VCO1 and VCO 2)

In order to tune the VCOs, the analog PCB must first be separated from the front panel (6 screws with spacers). The analog PCB must then be reconnected to the digital PCB and started.

After disassembly, the Tune VCO1 and Tune VCO2 knobs must be replaced and positioned exactly in the centre (Tune setting = 0).

Before adjustment, the unit should be in operation for approximately one hour. The adjustment should be made at room temperature.

Before adjusting the VCO, check the CV slope (chapter above). The setting of R10 in the MIDI to CV converter is valid for both VCO of course.

5.2.1 VCO1

The frequency of the oscillator can be taken from pin 8 of U11 or at the unit output, whereby the filter must be open and set to Lowpass. Only VCO1 must be audible (set the mixer correctly). Make sure that no LFO modulation take place.

The offset for VCO1 is set with R21 and the slope with R157. Nonlinearity in the upper frequency range is adjusted with R29.

Proceed as follows to make the adjustment:

1. Set trimmers R21, R157 and R29 to the base settings shown below.
2. Set the ProTone **MIDI reference note** to C1 by pressing the learn-key.
3. Press key A3 and set the VCO1 frequency with R21 to 220.00 Hz, measured with an exactly frequency meter.
4. Press key A1 and set the frequency to 55.00 Hz with R157.
5. Repeat steps 3 and 4 until frequency values are stable.
6. Press the key A5 and set the frequency to 880.0 Hz with R29.
7. Repeat steps 3 to 6 and re-adjust if necessary.

5.2.2 VCO2

The offset for VCO2 is set with R131 and the slope with R156. Nonlinearity in the upper frequency range is adjusted with R132.

Proceed as follows to make the adjustment:

8. Set trimmers R131, R156 and R132 to the base settings shown below.
9. Set the ProTone **MIDI reference note** to C1 by pressing the learn-key if not done yet.

10. Press key A3 and set the VCO2 frequency with R131 to 220.00 Hz, measured with an exactly frequency meter.
11. Press key A1 and set the frequency to 55.00 Hz with R156.
12. Repeat steps 3 and 4 until frequency values are stable.
13. Press the key A5 and set the frequency to 880.0 Hz with R132. Check here if no beats are audible with VCO1 open, too. If so, adjust R132 in that way that no beats are audible.
14. Repeat steps 3 to 6 and re-adjust if necessary.
15. done!

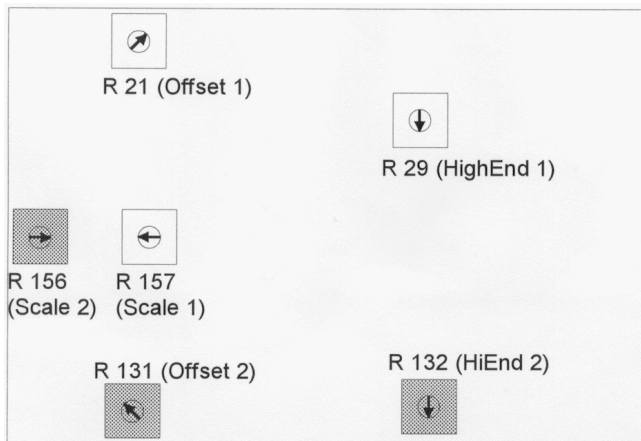

6 Digital PCB

6.1 Assembly plan

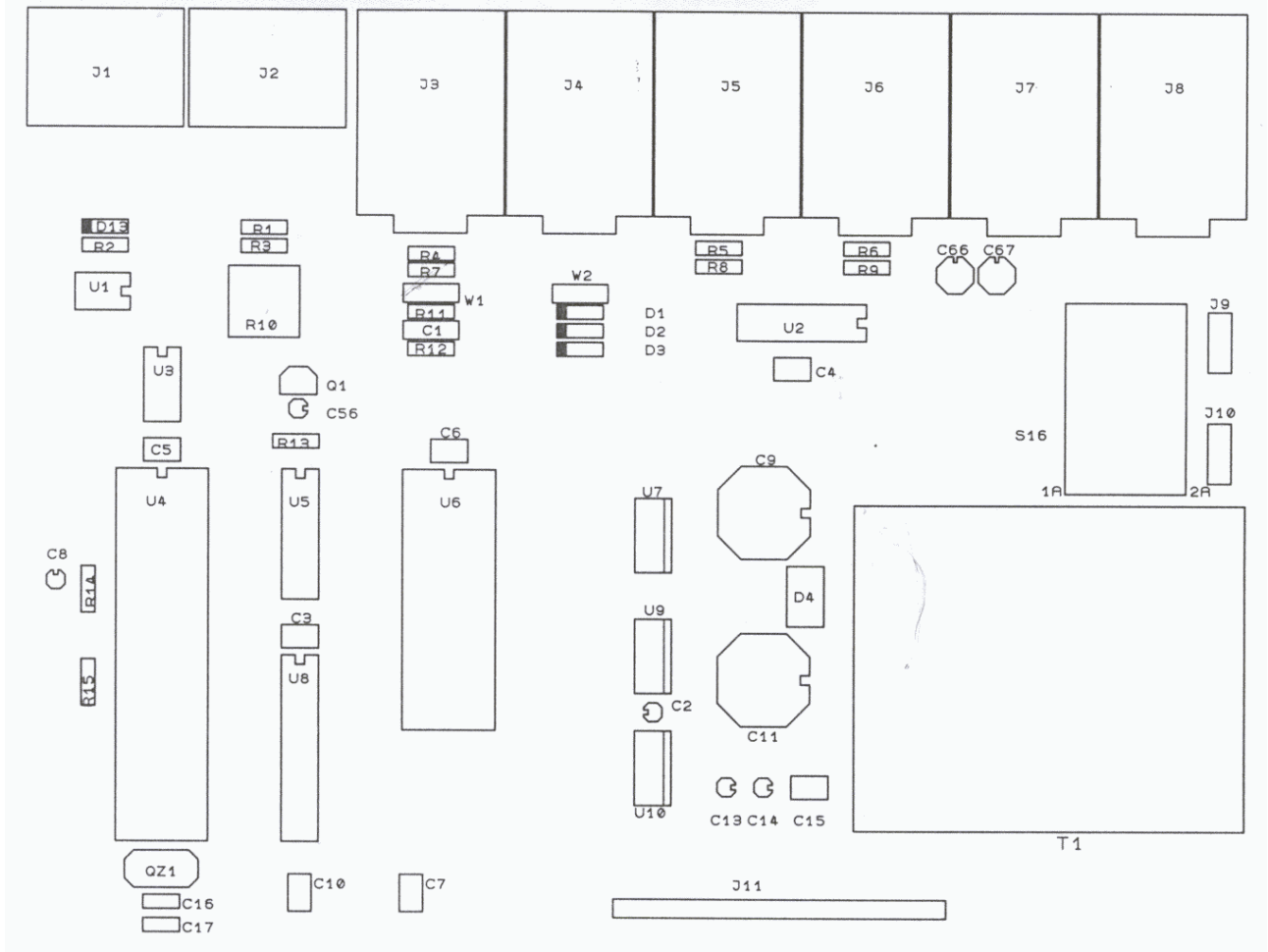

6.2 Part list

Resistors

R1	220	
R2	220	
R3	220	
R4	1k	
R5	10k	
R6	10k	
R7	1k	
R8	47k	
R9	47k	
R10	2k	Trimmer
R11	10k	
R12	10k	
R13	220	
R14	10k	
R15	1K	

Metal Film Resistor, 1%:

100R
4k7
24k
30k
62k
91k
100k
300k
1M

Capacitors		Kind	Gird [mm]	Dimensions [mm]
C1	100p	Foil	5	2.5 x 7.2
C2	10u	Elko	2	d=5
C3	100n	Ker	2.54	3.2 x 5.1
C4	100n	Ker	2.54	3.2 x 5.1
C5	100n	Ker	2.54	3.2 x 5.1
C6	100n	Ker	2.54	3.2 x 5.1
C7	100n	Ker	2.54	3.2 x 5.1
C8	10u	Elko	2	d=5
C9	1000u/25V	Elko	5	d=12.5
C10	100n	Ker	2.54	3.2 x 5.1
C11	1000u/25V	Elko	5	d=12.5
C13	10u	Elko	2	d=5
C14	10u	Elko	2	d=5
C15	100n	Ker	2.54	3.2 x 5.1
C16	22p	Ker	2.54	2 x 5
C17	22p	Ker	2.54	2 x 5
C56	10u	Elko	2	d=5
C66	2.2u	Elko	2	d=5
C67	2.2u	Elko	2	d=5

Semiconductors

Q1	TL 431 CLP
D1	1N4148
D2	1N4148
D3	1N4148
D4	DF 02 M
D13	1N4148
U1	CNY17-3 / SFH 601-3
U2	TL 074 CN
U3	24C01/02 CB
U4	P80C32 / SAB-C501-LP
U5	MAX 512 CPD
U6	27C64 Q200
U7	LM 2940CT-12
U8	74HC573 N
U9	LM 7805
U10	LM 7912

Various

Socket for U6	28 pin	assemble with EPROM "ProTone V1.04"
QZ1	12 MHz (HC 49)	
T1	BV 030-7010.0 L	Transformer
S16	V20212MS02Q C&K	
J1	DIN 5pol Socket	
J2	DIN 5pol Socket	
J3	Jack Socket 6,3mm	
J4	Jack Socket 6,3mm	
J5	Jack Socket 6,3mm	
J6	Jack Socket 6,3mm	
J7	Jack Socket 6,3mm	
J8	Jack Socket 6,3mm	
J9	PCB-Plug 4.8 x 0.8 mm	
J10	PCB-Plug 4.8 x 0.8 mm	
J11	Plug Connector 18 pole angular	

W1 Plug Ledge 3 pole
W2 Plug Ledge 3 pole

Jump1 Jumper 2.54 mm assemble on W1 "Out"
Jump2 Jumper 2.54 mm assemble on W2 "Out"

7 Analog PCB

7.1 Assembly plan

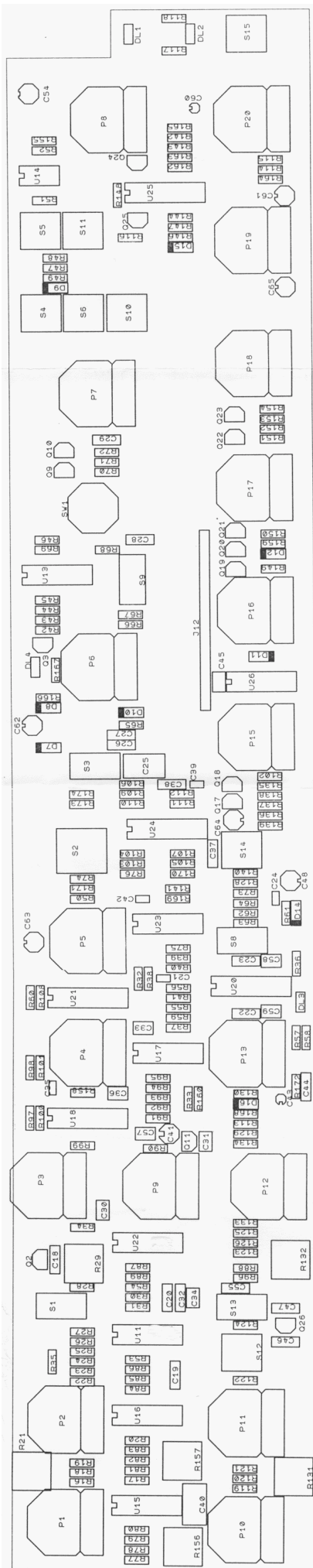

7.2 Part list

Resistors

R16	1M	
R17	100K *	
R18	270K *	
R19	220K	
R20	47K	
R21	100K	Trimmer
R22	100K	
R23	100K	
R24	100K	
R25	100K	
R26	10K	
R27	15K	
R28	1K	
R29	10K	Trimmer
R30	4K7	
R31	10K	
R32	1M	
R33	1M	
R34	300K	
R35	2K2	
R36	390	
R37	2K2	
R38	470	
R39	220	
R40	10K	
R41	1K	
R42	91K	
R43	15K	
R44	10K	
R45	91K	
R46	10K	
R47	15K	
R48	10K	
R49	10K	
R50	15K	
R51	24K	
R52	47K	
R53	100K *	
R54	10K	
R55	100	
R56	100	
R57	4K7	
R58	10K	
R59	30K	
R60	100	
R61	24K	
R62	2K2	
R63	1K	
R64	4K7	
R65	10K	

R66	22
R67	470K
R68	100K
R69	47K
R70	470K
R71	1M
R72	470K
R73	10K
R74	10K
R75	10K
R76	1K
R77	100K *
R78	100K *
R79	100K *
R80	220K
R81	5k1 *
R82	100 *
R83	1M *
R84	1M *
R85	100 *
R86	5k1 *
R87	10K
R88	10K
R89	100K *
R90	180K
R91	470K
R92	2M2
R93	470
R94	2M2
R95	220K
R96	220K
R97	24K
R98	300K
R99	62K
R100	24K
R101	300K
R102	470K
R103	100
R104	100
R105	4K7
R106	24K
R107	10K
R108	100
R109	2K2
R110	1K
R111	4K7
R112	10K
R113	220K
R114	47K
R115	100K
R116	4K7
R117	390
R118	390
R119	270K *
R120	1M
R121	1K

R122	4K7	
R123	15K	
R124	10K	
R125	100K	
R126	100K	
R128	47K	
R129	1K	
R130	24K	
R131	100K	Trimmer
R132	10K	Trimmer
R133	300K	
R134	120K	
R135	100K	
R136	100K	
R137	100K	
R138	30K	
R139	100K	
R140	220	
R141	180K	
R142	10K	
R143	470	
R144	470	
R146	15K	
R147	1K	
R148	1K	
R149	4K7	
R150	10K	
R151	24K	
R152	300K	
R153	10K	
R154	47K	
R155	100	
R156	1K	Trimmer
R157	1K	Trimmer
R158	30K	
R159	1K	
R160	470K	
R162	470	
R163	15K	
R164	1K	
R165	1K	
R166	24K	
R167	1K	
R168	47K	
R169	100K	
R170	100K	
R171	15K	
R172	15K	
R173	10M	
R174	4M7	
R175	NTC 68k	mounted with hot glue on U16 parallel to R81
R176	NTC 68k	mounted with hot glue on U16 parallel to R86

* must be a Metal Film Resistor, 1%

P1 47K LIN TUNE VCO1

Solder Temp. 235 Grad Celsius max,

P2	47K LIN	PW VCO1	solder time max. 5 sec
P3	47K LIN	VOL VCO1	
P4	47K LIN	CUTOFF	
P5	47K LIN	RESONANZ	
P6	10K LOG	F LFO	
P7	47K LIN	MOD LFO	
P8	10K LOG	LEVEL	
P9	47K LIN	VOL RING	
P10	1M LOG	SILDE	
P11	47K LIN	TUNE VCO2	
P12	47K LIN	VOL VCO2	
P13	47K LIN	ACCENT	
P15	1M LOG	ATTACK	
P16	1M LOG	DECAY	
P17	47K LIN	SUSTAIN	
P18	1M LOG	RELAISE	
P19	47K LIN	ENV MOD	
P20	47K LIN	PAN	

Capacitors		Kind	Gird [mm]	Dimensions [mm]	Producer
C18	3.3n	Foil	5	2.5 x 7.2	WIMA
C19	100p	Foil	5	2.5 x 7.2	WIMA
C20	100p	Foil	5	2.5 x 7.2	WIMA
C21	22p	Ker	2.54	1.8 x 3.5	Phillips
C22	470p	Foil	5	2.5 x 7.2	WIMA
C23	470p	Foil	5	2.5 x 7.2	WIMA
C24	4p7	Ker	2.54	1.8 x 3.5	Phillips
C25	1u	Foil	5	6 x 10.5	EVOX
C26	47n	Foil	5	2.5 x 7.2	EVOX
C27	470p	Foil	5	2.5 x 7.2	WIMA
C28	470p	Foil	5	2.5 x 7.2	WIMA
C29	47n	Foil	5	2.5 x 7.2	EVOX
C30	100n	Ker	2.54	3.2 x 5.1	
C31	100n	Ker	2.54	3.2 x 5.1	
C32	100p	Foil	5	2.5 x 7.2	WIMA
C33	100n	Ker	2.54	3.2 x 5.1	
C34	100n	Ker	2.54	3.2 x 5.1	
C35	22p	Ker	2.54	1.8 x 3.5	Phillips
C36	100n	Ker	2.54	3.2 x 5.1	
C37	470p	Foil	5	2.5 x 7.2	WIMA
C38	470p	Foil	5	2.5 x 7.2	WIMA
C39	4p7	Ker	2.54	1.8 x 3.5	Phillips
C40	470n	Foil	5	6 x 10.5	EVOX
C41	47u	Elko	2	d=10	
C42	1n	Ker	2.54	1.8 x 3.5	Phillips
C43	1u	Elko	2	d=5	
C44	47n	Foil	5	2.5 x 7.2	
C45	100n	Ker	2.54	3.2 x 5.1	
C46	470p	Foil	5	2.5 x 7.2	WIMA
C47	3.3n	Foil	5	2.5 x 7.2	WIMA
C48	2.2u	Elko	2	d=5	
C54	10u	Elko	2	d=5	
C55	100p	Foil	5	2.5 x 7.2	WIMA
C57	100n	Ker	2.54	3.2 x 5.1	
C58	100n	Ker	2.54	3.2 x 5.1	
C59	100n	Ker	2.54	3.2 x 5.1	

C60	1u	Elko	2	d=5
C61	1u	Elko	2	d=5
C62	1u	Elko	2	d=5
C63	1u	Elko	2	d=5
C64	1u	Elko	2	d=5
C65	1u	Elko	2	d=5

Semiconductors

Q2	BC 556 B
Q3	BC 546 B
Q9	BC 546 B
Q10	BF 245 B
Q11	BC 546 B
Q17	BC 556 B
Q18	BC 556 B
Q19	BC 546 B
Q20	BC 556 B
Q21	BC 546 B
Q22	BC 546 B
Q23	BC 546 B
Q24	BC 556 B
Q25	BC 556 B
Q26	BC 556 B

D7	1N4148
D8	1N4148
D9	1N4148
D10	1N4148
D11	1N4148
D12	1N4148
D14	1N4148
D15	1N4148
D16	1N4148

DL1	2.5 x 5mm	Green	Assemble with 8 mm spacer (Total 17mm)
DL2	2.5 x 5mm	Red	Assemble with 8 mm spacer (Total 17mm)
DL3	2.5 x 5mm	Red	Assemble with 8 mm spacer (Total 17mm)
DL4	2.5 x 5mm	Red	Assemble with 8 mm spacer (Total 17mm)

U11	TL 074 CN
U13	TL 074 CN
U14	TL 072 CN
U15	TL 074 CN
U16	CA 3046
U17	TL 074 CN
U18	XR 2208 CP
U20	LM 13700 N
U21	LM13700 N
U22	TL 074 CN
U23	TL 074 CN
U24	LM13700 N
U25	LM13700 N
U26	CD 4001 BCN

Various

S1 E103-SD1CBE	1pole on-off-on Toggle Switch	C&K
S2 E201-SD1CBE	2pole on-on Toggle Switch	C&K
S3 E103-SD1CBE	1pole on-off-on Toggle Switch	C&K
S4 PVA1-EE	1 pole on-off Push-Push Switch	ITT
S5 PVA1-EE	1 pole on-off Push-Push Switch	ITT
S6 PVA1-EE	1 pole on-off Push-Push Switch	ITT
S8 E101-SD1CBE	1pole on-on Toggle Switch	C&K
S9 E101-SD1CBE	1pole on-on Toggle Switch	C&K
S10 PVA1-EE	1 pole on-off Push-Push Switch	ITT
S11 PVA1-EE	1 pole on-off Push-Push Switch	ITT
S12 PVA1-EE	1 pole on-off Push-Push Switch	ITT
S13 E103-SD1CBE	1pole on-off-on Toggle Switch	C&K
S14 PVA1-EE	1 pole on-off Push-Push Switch	ITT
S15 PVA1-OA	1 pole on-off Momentary Switch	ITT
SW1 56P36-01-1-06N	6 pole Rotary Switch	Grayhill
J12 Connector 18 pole (Socket)	mounted on Solder Side	

8 Mechanical part list

Pcs. Part

- 1 Front Panel
- 1 Chassis
- 1 Backside
- 4 Screw M3 x 5mm with counter bore head black
- 5 Cylinder head screw M3 x 5mm black
- 1 Nut M3 for grounding
- 1 Washer for grounding
- 8 Sheet metal screw 2.9 x 6.5mm black
- 6 Sheet metal screw with counter bore head 2.9 x 22mm black
- 6 Spacer 14 mm
- 2 Spacer 25 mm metal with thread M3

- 1 Analog PCB assembled
- 1 Digital PCB assembled

- 6 Nuts for Phone Jack
- 19 Knobs 18 splines
- 1 Knob "D" Shape 1/8"

- 1 Inlet IEC Socket with Fuse Box
- 1 Fuse 250mA
- 1 Cable blue with thimbles 4.8mm
- 2 Cable brown with thimbles 4.8mm
- 1 Cable yellow-green with thimbles
- 1 Power switch 1 pole with 4.8mm terminals