

**BEFORE PROCEEDING WITH COMPLETE UNPACKING AND SETUP,  
READ THE SECTION ON UNPACKING AND INSPECTION**



**model 6230/6260  
POWER AMPLIFIER**

**JBL Incorporated  
8500 BALBOA BOULEVARD  
P.O. BOX 2200  
NORTHRIDGE, CA 91329, U.S.A.  
PHONE: (818) 893-8411  
TELEX: 4720424**

**SERVICE ADDRESS:  
8460 SAN FERNANDO ROAD  
SUN VALLEY, CA 91352, U.S.A.  
PHONE: (818) 767-1000**

## PREFACE

Thank you for purchasing this JBL Power Amplifier. We have prepared this instruction manual to enable you to achieve optimum utility and performance from your new amplifier. We encourage you to read it and to make use of the material contained in this manual.

We welcome your comments or suggestions on our products and on this manual.

This product was manufactured for JBL by UREI, Inc.

## TABLE OF CONTENTS

	PAGE
<u>SECTION I. INTRODUCTION</u>	1
1.1 SPECIFICATIONS	2
<u>SECTION II. INSPECTION AND INSTALLATION</u>	5
2.1 UNPACKING AND INSPECTION	5
2.2 ENVIRONMENTAL CONSIDERATIONS	5
2.3 AC POWER	6
2.4 AMPLIFIER MODE SWITCH	6
2.5 EXTERNAL CONNECTIONS	7
2.5.1 INPUT CONNECTIONS, GENERAL	7
2.5.2 INPUT CONNECTION, DUAL MONO MODE	8
2.5.3 INPUT CONNECTION, BRIDGED MONO MODE	8
2.5.4 FIVE-WAY BINDING POST OUTPUTS	8
2.5.5 ABOUT OUTPUT POLARITY AND BRIDGED MONO CONNECTION	8
2.6 INPUT IMPEDANCE AND TERMINATION	9
2.7 APPROPRIATELY RATED LOADS	10
2.7.1 IT IS THE USER'S RESPONSIBILITY TO AVOID OVERPOWERING	10
2.7.2 MORE ABOUT LOUDSPEAKER POWER RATINGS	11
2.7.3 SOMETIMES A LARGER AMPLIFIER CAN BE SAFER	12
2.7.4 REMEMBER THE DIVIDING NETWORK (CROSSOVER)	12
2.8 SPEAKER CABLES	13
2.8.1 TYPE OF WIRE	13
2.8.2 DAMPING FACTOR	13
2.8.3 CALCULATING LOSSES IN SPEAKER CABLE	14
2.9 GROUNDING	14
2.10 SECURITY COVERS	15
FIGURE 2-1 BALANCED INPUT CONNECTIONS	17
FIGURE 2-2 UNBALANCED INPUT CONNECTIONS	17
FIGURE 2-3 BARRIER STRIP CONNECTIONS	18
FIGURE 2-4 USE OF FIVE-WAY BINDING POSTS	19
FIGURE 2-5 OUTPUT CONNECTIONS TO TWO CHANNEL SPEAKER SYSTEM	19
FIGURE 2-6 BRIDGED OUTPUT CONNECTION TO MONAURAL SPEAKER SYSTEM	19
<u>SECTION III. OPERATING INSTRUCTIONS</u>	20
3.1 GENERAL	20
3.2 TURN ON AND SYSTEM CHECK	20
3.2.1 A NOTE ON AMPLIFIER COOLING	20
3.3 CLIP INDICATORS	20
3.3.1 ABOUT SENSITIVITY RATINGS	21

TABLE OF CONTENTS  
(Continued)

	PAGE
<u>SECTION IV. THEORY OF OPERATION</u>	22
4.1 INPUT DIFFERENTIAL AMPLIFIER	22
4.2 MODE SWITCH	22
4.3 POWER AMPLIFIER	23
4.4 RELAY DRIVER/DC DETECTOR	24
4.5 CLIP CIRCUIT	25
4.6 POWER SUPPLY	25
<u>SECTION V. MAINTENANCE</u>	26
5.1 GENERAL	26
5.2 REPAIRS AND WARRANTY	26
<u>SECTION VI. SCHEMATIC DIAGRAM</u>	

## SECTION I INTRODUCTION

The JBL Model 6230 and 6260 power amplifiers have been designed to meet the most critical professional sound requirements. They are rugged and road-worthy, conservatively rated, and can handle reactive loads with ease.

The engineering design approach stresses the optimization of each stage, allowing high slew rate and relatively low loop gain. Overall feedback has been held to a minimum and is employed only to stabilize the gain and the operating point. This design approach results in amplifiers with excellent performance under the most demanding dynamic input and load conditions. As evidence of the stress on dynamic rather than static or steady-state distortion mechanisms, transient intermodulation distortion measures less than 0.03% by the DIM 100 test. (Leinonen, Ojala, and Curl, "A Method for Measuring Transient Intermodulation Distortion (TIM)", Journal of the Audio Engineering Society, Vol. 25, No. 4, April, 1977, pp. 170-177.)

The front panel and heat sinks of the amplifiers are made of heavy aluminum extrusions; the chassis is fabricated of heavy gauge steel. All internal components are easily accessible through removal of top and bottom panels. Front panel graphic details are incorporated on the rear side of a polycarbonate laminate which is virtually indestructible.

JBL amplifiers use multiple 200-watt output devices in complementary configuration for high reliability and low distortion. At rated power into 8 ohms, these output devices are operated at less than 25% of their rated power dissipation. The benefit is high reliability and long component life.

Failsafe operation of these amplifiers is ensured through the following protection modes: Current is limited under improper load or drive conditions. An output relay, with front panel LED indication, protects the loudspeaker load under conditions of DC offset or large low-frequency transients. The relay also provides power-up, power-down, and "brown out" muting to protect loudspeakers from AC power transients generated anywhere in the signal path. LED's on the front panel indicate the onset of clipping and standby mode.

The JBL amplifiers may be operated in the normal stereophonic mode, dual monophonic mode, or bridged monophonic mode. Rear panel switching sets these modes, obviating the need for patch cords, level matching, etc.

Active differential input circuitry offers the benefits of balanced operation without the use of input transformers. Input connections may be made via 3-pin XL-type connector, three-cond-

uctor (TRS) 6.3 mm (1/4 in.) phone jack, or barrier strip. The barrier strip has separate terminals for audio ground and chassis ground.

The five-way output binding posts are arranged in a 19 mm (3/4 in.) array so that bridged as well as normal connections may be made with standard dual banana plugs, bare wire, or terminal lugs.

1.1 SPECIFICATIONS

(Common to both models except where noted)

OUTPUT POWER:

	6230		6260	
	Rated Power 20 Hz-20 kHz	Midband Power 1 kHz	Rated Power 20 Hz-20 kHz	Midband Power 1 kHz
8-ohm stereo (per channel)	75 W	110 W	150 W	190 W
4-ohm stereo (per channel)	150 W	175 W	300 W	315 W
16-ohm bridge	150 W	220 W	300 W	380 W
8-ohm bridge	300 W	350 W	600 W	630 W

Rated Power is minimum continuous sine wave output per channel, with both channels driving their rated load over a power bandwidth of 20 Hz to 20 kHz. Maximum total harmonic or intermodulation distortion measured at any power level from 250 milliwatts to rated power is less than 0.1% for 8 ohm stereo and 16 ohm bridge, 0.2% for 4 ohm stereo and 8 ohm bridge.

Midband Power is maximum output power at onset of clipping, both channels driven with 1 kHz sine wave, THD 1%.

TRANSIENT INTERMODULATION DISTORTION: .03% max at rated output

FREQUENCY RESPONSE: +0, -1 dB, 20 Hz to 20 kHz, at any level up to rated output

NOISE: At least 100 dB below rated output (15.7 kHz noise bandwidth)

INPUT: Balanced bridging differential amplifier

INPUT IMPEDANCE: 40k ohms used as balanced input; 20k ohms used as unbalanced (single-ended) input

MAXIMUM INPUT LEVEL: +20 dB\* (7.75 V rms)

INPUT SENSITIVITY: 1.1 V for rated output into 8-ohm load

VOLTAGE AMPLIFICATION: Variable; maximum 27 dB (6230), 30 dB (6260)

RISE TIME: Less than 7 microseconds

SLEW RATE: 40 V/microsecond into 8-ohm load

DAMPING FACTOR: With 8-ohm load, greater than 200 at any frequency from 20 Hz to 1 kHz

CHANNEL SEPARATION: Greater than 60 dB at 1 kHz

POLARITY: Output signal is in phase with pin 3 of XL-type connector, tip of 6.3 mm (1/4 in.) phone jack and the barrier strip "+" terminal

AC POWER: Typical AC power consumption

	<u>6230</u>	<u>6260</u>
At idle (approx.)	50 W	50 W
At rated output Both channels 8-ohms	420 W	600 W
At rated output Both channels 4-ohms	720 W	1180 W

DC OUTPUT OFFSET: +10 millivolts maximum

	<u>6230</u>	<u>6260</u>
DIMENSIONS:	133 x 483 mm (5-1/4 x 19 in.)	178 x 483 mm (7 x 19 in.)
DEPTH:**	280 mm (11 in.)	280 mm (11 in.)
NET WEIGHT:	11.9 kg (26.25 lbs)	20.2 kg (44.5 lbs)

\*In these specifications, where dB refers to a specific level, the 0 dB reference is 0.775 volts RMS unless otherwise noted.

\*\*Allow a minimum of 51 mm (2 in.) behind amplifier for connections and cooling air flow.

	<u>6230</u>	<u>6260</u>
SHIPPING WEIGHT:	15.9 kg (35 lbs)	24 kg (53 lbs)
OPTIONAL ACCESSORIES:	Attenuator security cover, 70 V and 100 V output transformer panels, input transformers	
PROTECTION CIRCUITRY:	The amplifier output is protected against short circuit and is stable into reactive loads. Short circuit protection is clean with no odd behavioral characteristics. The input amplifiers are protected against excess input current. The loudspeakers are protected against any failure in the amplifier by an internal relay which disconnects the load from the amplifier output and connects it to ground. The circuit is activated at turn on and turn off to prevent thumps in the loudspeaker during system power up/down. The relay also disconnects the load if excess DC voltage is detected at the output or upon failure of any of the amplifier power supplies. If the amplifier overheats due to a lack of ventilation the relay opens until the amplifier has begun to cool down.	
CONTROLS:	Independent channel level controls are detented. Illuminated rocker-type power switch. Rear panel recessed stereo/dual mono/bridged mono mode switch.	
INDICATORS:	Individual channel clip indicator LEDs. STANDBY LED indicates action of output protection circuit.	
CONNECTORS:		
Input:	3-pin XL-type 3 conductor 6.3 mm (1/4 in.) phone jacks and barrier strip. May be wired balanced or unbalanced.	
Ground:	Chassis ground and audio ground connected with removable shorting strap on rear panel barrier strip	
Output:	Color coded 5-way binding posts on 19 mm (3/4 in.) centers	
Power:	1.5 m (5-foot) 3-wire AC power cord with U-ground male connector	



## SECTION II INSPECTION AND INSTALLATION

### 2.1 UNPACKING AND INSPECTION

Your JBL Power Amplifier was carefully packed at the factory, and the container was designed to protect the unit from rough handling. Nevertheless, we recommend careful examination of the shipping carton and its contents for any sign of physical damage which could have occurred in transit.

Save the carton and packing in the unlikely event the unit must be returned for service; if you do not have a carton, call the factory for one before shipping the unit. If damage is evident, do not destroy any of the packing material or the carton, and immediately notify the carrier of a possible claim for damage. Shipping claims must be made by the consignee.

The shipment should include the Power Amplifier and the Instruction Manual (this book).

### 2.2 ENVIRONMENTAL CONSIDERATIONS

This amplifier has been constructed to operate satisfactorily with program material at normal room temperature and humidity. This presumes a free, unrestricted flow of cooling air to the rear mounted heatsink. When the amplifier is mounted in a rack it is important to ensure that cool air is allowed to reach the heatsink, and that heated air is allowed to flow away from the amplifier. In most cases this will only require ventilation grills to be provided so cool air can enter the rack at the bottom and hot air can exhaust at the top through natural convection.

In some installations it may be necessary to provide forced air cooling to the amplifier and the space in which it is mounted. These amplifiers have thermo-protective circuits that will operate if the amplifier overheats. This will happen for one or more of the following reasons:

1. Insufficient natural air flow.
2. Average power and duty cycle of the program material too high.
3. High ambient air temperature in which the amplifier is operating.

It is not really possible to state exact requirements for air flow because of the number of variables, but in most cases fans with 70-120 CFM will provide sufficient air flow.

Furthermore, remember that the amplifier is heavy. The rack, especially its mounting rails, should be capable of supporting the amplifier. When a rack is to be transported with a portable sound system, the amplifier also should be supported from below; a few pieces of angle iron secured to the sides of the rack will suffice. It is further recommended that the amplifier be placed low in the rack to keep the center of gravity low and thus avoid any tendency for the rack to tip over.

### 2.3 AC POWER

All JBL Power Amplifiers shipped to destinations in the USA and Canada are wired for 120 VAC 60 Hz operation. Amplifiers wired for operation on any other voltage are identified as such with a sticker on the rear panel and a tag attached to the amplifier power cord.

#### WARNING

BE SURE TO VERIFY BOTH THE ACTUAL LINE VOLTAGE AND THE VOLTAGE FOR WHICH THE AMPLIFIER HAS BEEN WIRED BEFORE CONNECTING AC POWER. APPLICATION OF EXCESSIVE VOLTAGE TO THE POWER SUPPLY MAY RESULT IN EXTENSIVE DAMAGE WHICH IS NOT COVERED BY THE WARRANTY.

To comply with most electrical codes this amplifier is supplied with a three-conductor AC power cable, the grounding pin of which is connected to the chassis. In some installations this may create ground loop problems when an AC potential exists between conduit ground and audio ground. This will be evidenced by hum or buzz in the amplifier output. If this should occur please refer to Section 2.9 for suggestions. Proper grounding of the amplifier is important for both noise and safety reasons. Be aware that unless the amplifier is properly grounded, a safety hazard can exist. JBL accepts no responsibility for legal actions or for direct, indirect or consequential damages that may result from violation of electrical codes.

### 2.4 AMPLIFIER MODE SWITCH

A recessed switch on the rear panel provides for convenient change of amplifier mode from stereo to dual mono and bridged mono output. The switch may be actuated with a small screwdriver. The functions are as follows:

#### Stereo:

Input to Channel A. Output is on Channel A and level is controlled by Channel A level control.

Input to Channel B. Output is on Channel B and level is controlled by Channel B level control.

## Dual Mono:

If both channels of the amplifier are driving the same signal to different loudspeakers the dual mono mode saves a patch cord or Y-cord. Input is to Channel A. Output on Channel A is controlled by the Channel A Level control. Output on Channel B is controlled by the Channel B Level control. Input B is not used.

## Bridged Mono:

This mode makes the stereo amplifier into a single mono amplifier with the power of both channels combined. Input is to Channel A. Level control is by Channel A Level control and output is taken from the red binding posts of Channels A and B as described in Section 2.5.5.

## 2.5 EXTERNAL CONNECTIONS

### 2.5.1 INPUT CONNECTIONS, GENERAL

Input signal wires should be shielded cable, and connected in accordance with standard wiring practice to either the three-conductor 6.3 mm (1/4 in) phone jacks, the XL-type connectors or the barrier strip on the back of the chassis. See Figures 2-1, 2-2 and 2-3.

NOTE: The JBL Amplifier input connectors are wired as follows:

<u>PHONE JACK</u>	<u>XL-TYPE CONNECTOR</u>	<u>BARRIER STRIP CONNECTION</u>
Tip	Pin #3	+ or HIGH
Ring	Pin #2	- or LOW
Sleeve	Pin #1	AUDIO GROUND

For a given channel, either the XL-type connector, the phone jack or the barrier strip may be used. Since all three connectors are wired in parallel, however, only one should be used at a given time (unless it is specifically desired to loop a signal through the amplifier input).

The amplifier will not unbalance floating or balanced input sources since the input circuits consist of balanced differential amplifiers. To use an unbalanced source, wire the signal carrying conductor of the cable from that source to XL-type pin 3 (phone plug tip), and wire the shield to XL-type pin 1 (phone plug sleeve). The unused connector terminal, pin 2 (ring), should also be connected to shield ground. Unbalanced connections are simplified by using two-conductor standard phone plugs because they automatically short the ring and sleeve together when inserted in the input jacks.

## 2.5.2 INPUT CONNECTION, DUAL MONO MODE

When operating the amplifier as two independent amplifiers, but with the same program signal, only the Channel A input need be used. Set the mode switch to Dual Mono. Do not apply signal to the Channel B input.

## 2.5.3 INPUT CONNECTION, BRIDGED MONO MODE

When operating the amplifier as a high powered single-channel amplifier, only the Channel A input is used. That signal is applied "in phase" to Channel A, and, with inverted polarity, to Channel B. No signal should be applied to the Channel B input, and the Channel B level control should be turned all the way down (fully counterclockwise).

## 2.5.4 FIVE-WAY BINDING POST OUTPUTS

Five-way binding post outputs have been chosen because they allow connections to be made quickly, they facilitate polarity reversals for speaker "phasing," and they can handle high current with a greater margin of safety than phone jacks. See Figure 2-4.

The preferred connection method is to use a dual banana plug for each speaker cable. Simply insert each plug into the corresponding channel's red and black binding posts. See Figure 2-5.

In the absence of a dual banana plug (or two single banana plugs), there are other alternatives. To connect stranded speaker cable, loosen the plastic terminal nut, wrap the stripped and twisted wire end clockwise around the terminal, and secure it by tightening the nut.

NOTE: It is preferable to tin the wire ends with solder to prevent unraveling; avoid excess solder as it can promote cable breakage. Smaller speaker cable could be pushed through the hole in the binding post shaft, but we recommend using heavier gauge cables that ought to be wrapped around the shaft.

If a lug is installed on the cable, loosen the terminal nut, push one "leg" of the lug through the hole in the shaft, and tighten the nut.

## 2.5.5 ABOUT OUTPUT POLARITY AND BRIDGED MONO CONNECTION

In normal stereo operation (or dual mono), a positive-going signal applied to an input's pin #3, the phone jack tip, or the + terminal of the barrier strip will cause a positive-going signal to appear at the corresponding channel's red output binding post.

In bridged mono operation the two amplifier channels are driven with the same signal, but with Channel B reversed in polarity. The speaker cable is then connected to the two channels' red binding posts (the black posts are not used in bridged mono mode). In this case, a positive-going signal applied to the Channel A input appears as a positive-going signal at the Channel A red binding post and as a negative-going signal at the B red binding post. See Figure 2-6.

NOTE: The two channels' binding posts are clustered to facilitate mono connection across the red posts with a standard dual banana plug. DO NOT CONNECT THE TWO RED BINDING POSTS TO EACH OTHER, and DO NOT GROUND EITHER SIDE OF THE OUTPUT IN BRIDGED MONO MODE.

## 2.6 INPUT IMPEDANCE AND TERMINATION

Audio engineering has its roots in the telephone industry, and "600 ohm circuits" (together with their predecessors, "500 ohm circuits") are carry-overs from telephone transmission practices. Long audio transmission lines, like their video counterparts, must be properly sourced from and terminated in equipment which matches their characteristic impedance if optimum frequency response and noise rejection are to be achieved.

However, transmission line theory and techniques are not only unnecessary but impractical within modern recording studios, broadcast studios and other local audio systems where transmission circuits are seldom more than several hundred feet in length. The advent of negative feedback circuitry and solid-state electronics has spawned modern audio amplifiers and other signal processing devices having source impedances of only a few ohms. They are essentially indifferent to load impedances and, by varying their output current inversely to changes in load impedance, maintain the same output voltage into any load impedance above a rated minimum, with no change in frequency response.

Modern audio systems, therefore, utilize amplifiers and other active devices which have very low output impedances and high (10K to 50K ohm) input impedances. These products may thus be cascaded (operated in series), or many inputs may be connected to a single output of a preceding device, without regard to impedance matching. Switching and patching is simplified because double loads and unterminated bugaboos are essentially eliminated. Floating (ungrounded) transformer outputs minimize ground loop problems, and differential transformerless input circuitry (or input transformers) minimize common mode noise or interference which may be induced into the interconnecting wires or cables.

Where audio must be transmitted through cables or wire pairs of more than several hundred feet in length, however, transmission line termination practices should still be observed.

This amplifier has input impedances of 40,000 ohms when used in a balanced, differential input configuration, and 20,000 ohms when used unbalanced (one side grounded). This makes the amplifier suitable for use with any normally encountered source impedance, low or high. Therefore, there are only two situations which will require an input load at the amplifier:

- 1) when the source requires a 600 ohm load, such as a passive equalizer, older vacuum tube equipment, etc.
- 2) when the source is a transmission line such as a telephone line.

In some instances it may prove beneficial to treat the input feed to the power amplifier as a transmission line to lower its impedance and its susceptibility to noise pickup.

Input load resistors, if required, may most conveniently be attached to the barrier strip connector of the amplifier.

## 2.7 APPROPRIATELY RATED LOADS

### 2.7.1 IT IS THE USER'S RESPONSIBILITY TO AVOID OVERPOWERING

It is essential that the amplifier be used with loudspeakers of suitable impedance that can handle the amplifier's power output. We realize this is not always easy to determine, especially since speaker power ratings have not been standardized. Nonetheless, JBL IS NOT RESPONSIBLE FOR DAMAGE TO LOUDSPEAKERS RESULTING FROM OVERPOWERING.

Fuses may be inserted in series with the loudspeaker to protect against overpowering. The fuse value must be chosen with some care. Ideally, the value will be high enough that the fuse does not excessively reduce the capability of the loudspeaker to handle peak transients which are above its continuous power rating. On the other hand, the fuse value must be low enough that the fuse can actually do its job. It takes some period of time to heat the fuse element enough to cause it to melt and break the circuit. If it takes too long, the loudspeaker may go first. Obviously, delayed action (slo-blo) fuses are not acceptable for use here. Also, if fuses are used, consideration must be given to their location. Put them where they are accessible for ease of replacement and provide clear labelling of the replacement fuse value. Place spare fuses nearby for ease of replacement with the correct type.

## 2.7.2 MORE ABOUT LOUDSPEAKER POWER RATINGS

While there is no cut-and-dried method to establish an appropriate amplifier power for a given speaker system, certain guidelines do exist. If a loudspeaker manufacturer specifies "to be used with amplifiers rated at no more than 'x' watts," then neither speaker nor amplifier warranty is likely to cover damage if a larger amplifier is used. If the amplifier power is only recommended, or if a power rating is given without mentioning the amplifier, then the question as to whether the amplifier is "safe" becomes more difficult to answer.

Loudspeakers usually fail due to one of two factors: thermal or mechanical overload. Thermal overload means overheating, and is almost always caused by applying too high a level of sustained, average power; the voice coil insulation may burn and short circuit, the coil may deform due to the heating and scrape in the gap, and, in some cases, speaker cones have been known to burst into flame. Mechanical overload is another way of describing excessive diaphragm/voice coil travel. A single very high power transient, especially at lower frequencies, can literally tear a loudspeaker apart. Sometimes mechanical overload is more gradual, with the voice coil "bottoming" against the magnetic assembly until it is deformed; a compression driver diaphragm can strike the phase plug and shatter, or the suspension can be over-extended and simply tear apart.

The frequency and waveform of a signal have a lot to do with the destructive potential of a given power output. Band limited pink noise is somewhat akin to "average program" power, although the meaning of such a rating depends heavily on crest factor (peak to average noise voltage) and specific frequency limits. Unfiltered or unweighted white noise stresses the tweeters more than the woofers. Swept sine waves may cause less thermal heating, but can cause larger excursions at low frequencies. With compression drivers, the mechanical power handling capability is approximately quadrupled simply by raising the minimum crossover frequency by an octave. If any conclusion can be drawn, it is this:

NO SINGLE POWER RATING REALLY DESCRIBES THE POWER HANDLING CAPABILITY OF ANY LOUDSPEAKER OR LOUDSPEAKER SYSTEM. ALSO, WHEN A LOUDSPEAKER SYSTEM IS MULTI-AMPLIFIED, i.e. A HIGH FREQUENCY DRIVER IS CONNECTED DIRECTLY TO THE POWER AMPLIFIER OUTPUT, A SERIES PROTECTION CAPACITOR IS STRONGLY RECOMMENDED TO REDUCE THE POSSIBILITY OF ACCIDENTAL DAMAGE TO THE DRIVER DIAPHRAGM. CONSULT THE MANUFACTURER OF THE DRIVER AND HORN FOR RECOMMENDATIONS ON PROTECTION CAPACITOR TYPES AND VALUES.

### 2.7.3 SOMETIMES A LARGER AMPLIFIER CAN BE SAFER

If the desired sound level is high enough that it requires a low powered amplifier to be operated at a fairly high distortion level (e.g., well into clipping), it may be safer to use a larger amplifier that will be free of distortion. It is true that in a small amp which is clipping, peak power is restricted by the size of the amplifier's power. However, the average power output rises due to the increased signal density caused by distortion components. Not only does this increase the thermal stress, it also increases mechanical stress because the squared waveforms place greater "G" loads on the moving parts, and abnormally high proportions of high frequency harmonics are generated which can fry the tweeter voice coils.

A more powerful amplifier which is able to generate the desired peak sound level without clipping avoids the large increase in average power (thermal) and the high acceleration (mechanical) stresses caused by the overdriven small amplifier. The major drawback of the larger amplifier is that it can produce higher peak outputs that may instantly destroy a loudspeaker. Therefore, great care must be exercised to ensure that the amplifier will not be driven at too high a level, certainly never at a clip. This can be accomplished either by knowing the program material (if recorded) and setting levels accordingly, or by using peak limiters (with live or unknown program material).

### 2.7.4 REMEMBER THE DIVIDING NETWORK (CROSSOVER)

If the amplifier is connected to a multi-way loudspeaker system that includes a passive, high-level dividing network (crossover), be sure to consider its presence. The network should be rated to handle the amplifier's power. Pre-packaged speaker system power ratings already take the crossover into account.

If you obtain separate components and assemble a system, the chances are that the higher frequency drivers will be rated at less power than the woofer(s). This works out overall because the higher frequency drivers tend to be more efficient (more sound per watt). In fact, higher sensitivity in the high frequency components usually requires some attenuation to be applied in the dividing network (remember, a 3 dB more sensitive driver must be driven with half the power to generate the same sound level).

For example, consider a typical two-way system with a 200 watt woofer and 50 watt high frequency compression driver. The woofer, 1 meter from its enclosure, generates 100 dB SPL with 1 watt at its input, and the compression driver, 1 meter from its horn, generates 106 dB SPL at 1 watt input. If both components are driven by a 200 watt program signal, the compression driver



will be 6 dB too loud (four times the level of the woofer). Therefore, the crossover network must provide 6 dB of attenuation for the compression driver, lowering its input power to 50 watts. The 200 watt amplifier turns out to be perfectly suited to driving this system, even though one driver is rated at just 50 watts.

## 2.8 SPEAKER CABLES

### 2.8.1 TYPE OF WIRE

A number of companies offer various special "speaker cables" which are claimed to vastly improve the signal delivered from amplifier to loudspeaker system. Without going into great details, suffice it to say that some special cables have merit, others may actually be detrimental, and overall the value will have to be determined by the user. In our opinion, for most applications just two factors need to be considered: DC resistance and durability.

Generally, the larger the wire gauge, the better. DC resistance is lower with larger wire, and hence more of the amplifier power gets to the loudspeaker (and damping factor is not degraded; see Section 2.8.2). More strands of wire in a given wire gauge are beneficial because they let the cable handle more flexing without fatigue.

### 2.8.2 DAMPING FACTOR

The higher the damping factor of an amplifier, the greater its ability to control unwanted speaker cone movements -- especially at low frequencies. Damping factor is easy to calculate; divide the speaker's rated load impedance by the amplifier's output source impedance. For example, an amplifier with 0.04 ohms output impedance at 1 kHz presents a damping factor of 200 to an 8 ohm speaker ( $8 / 0.04 = 200$ ). To understand how a high damping factor improves sound quality, one must first understand the underlying principles.

When an amplifier drives a woofer, current flowing through the voice coil creates a magnetic field which interacts with the permanent magnetic field in the gap and forces the diaphragm/voice coil assembly to move. Consider what happens when the resting cone is accelerated to a maximum velocity by a signal pulse; the maximum signal builds up, and the voice coil/diaphragm assembly tracks the current, moving outward proportionately. When the current returns to zero, the suspension and the air mass loading the diaphragm pull it back toward its original resting position, and momentum tends to cause overshoot past that point.

In the absence of an applied signal, the voice coil is moving through a magnetic field, and according to basic physical

laws, it generates a current opposite to that of the original driving signal. This current induces a voltage or "back EMF" at the amplifier's output terminals.

The back EMF travels through the amplifier's output source impedance to ground. The lower that impedance, the better the "braking" action on the voice coil; a direct short across the coil (zero ohms) would allow minimal overshoot. Low impedance equals high damping factor, so the benefits of high damping factor become obvious -- tighter control of the loudspeaker.

The theoretical damping factor of an amplifier may not be realized at the speaker because cables always have a finite resistance or impedance; the back EMF must also travel through the cable, so the damping becomes less. Hence, larger gauge cables not only reduce signal losses, they improve performance by affecting damping factor less than smaller gauge cables.

### 2.8.3 CALCULATING LOSSES IN SPEAKER CABLE

WIRE DIAM. (mm) SOLID	A.W.G. WIRE GAUGE	DC RESISTANCE PER 30 m (100 ft) OF TWO-CONDUCTOR CABLE (OHMS)	CABLE LENGTH WHICH WILL PRODUCE A ONE dB POWER LOSS			
			@ FOUR ohms		@ EIGHT ohms	
			meters	feet	meters	feet
4.115	6	0.08	366	1200	740	2425
3.264	8	0.13	244	800	488	1600
2.588	10	0.20	145	475	290	950
2.05	12	0.32	91	300	183	600
1.63	14	0.52	58	190	114	375
1.29	16	0.82	37	120	73	240
1.02	18	1.32	23	75	46	150
0.813	20	2.08	15	50	30	100
0.643	22	3.30	9	30	18	60

### POWER LOSSES IN SPEAKER CABLES

This chart may be consulted to establish the approximate power loss (and damping factor degradation) for various wire gauges.

### 2.9 GROUNDING

For safe operation the amplifier must be connected to a good mechanical ground. This provides for a current path for any voltage which should appear on the chassis due to a fault in the amplifier. This current path will result in blowing the main power supply fuse. Without this current path, the amplifier

would present a shock hazard. In addition, a good quality ground on the chassis provides shielding from external fields and minimizes radiation of internal fields to the outside world. To comply with safety regulations in many localities and to protect our customers, we provide this product with a ground connection through the 3-wire electrical cord. In many situations this will present no problem. But there are instances where a hum or buzz will be noticed in the amplifier output due to a phenomenon known as a ground loop. This results when there is a significant potential between the audio ground from the previous piece of equipment and the mechanical ground to which the amplifier has been connected.

If this is the case, the first attempt at a solution should be to remove the strap on the rear panel barrier strip which connects audio ground and chassis. Audio ground will then be referenced from the signal source and the chassis ground will be separate and still connected to mechanical ground. In some instances, the voltage difference between the grounds will be so great that a direct connection to mechanical ground is not possible without hum in the amplifier output. Check for this using a 3 prong to 2 prong AC adaptor between the power cord and the power outlet, temporarily ungrounding the amplifier. Try the amplifier both with and without the ground strap on the barrier strip. Determine which connection works best. Remember, however, that for safety you must still have a connection to chassis ground. This is normally made through a properly grounded third pin connection.

## 2.10 SECURITY COVERS

In some installations it may be necessary to safeguard the amplifier gain control settings from deliberate or accidental misadjustment. For this purpose the Model 6200SC Security Cover is made available. The 6200SC contains enough individual covers for six amplifiers. Installation is simple:

- 1) Remove the two Level control knobs. If they are on too tight to be removed by fingers, use a pair of long nose pliers to grasp the bar on the knob and pull outwards. Wrap the jaws of the pliers with masking tape to prevent scratching of the knob.
- 2) If necessary, adjust the gain controls using a small screwdriver.
- 3) Press each of the security covers into place to cover the holes in the front panel. Make sure they snap firmly into place.

To remove the cover, slip your fingernail under the edge of the cover and pry it up and off. Alternately, a small screwdriver or knife blade may be used, giving due care not to scratch the front panel.

**IMPORTANT: DO NOT POKE YOUR FINGERS OR METAL TOOLS INTO THE AMPLIFIER WHEN THE KNOBS ARE OFF. THERE IS THE POSSIBILITY OF SEVERE SHOCK HAZARD DUE TO THE HIGH VOLTAGE/HIGH CURRENT DC USED TO POWER THIS DEVICE. THE AMPLIFIER SHOULD NOT BE OPERATED WITHOUT EITHER THE KNOBS OR SECURITY COVERS IN PLACE.**

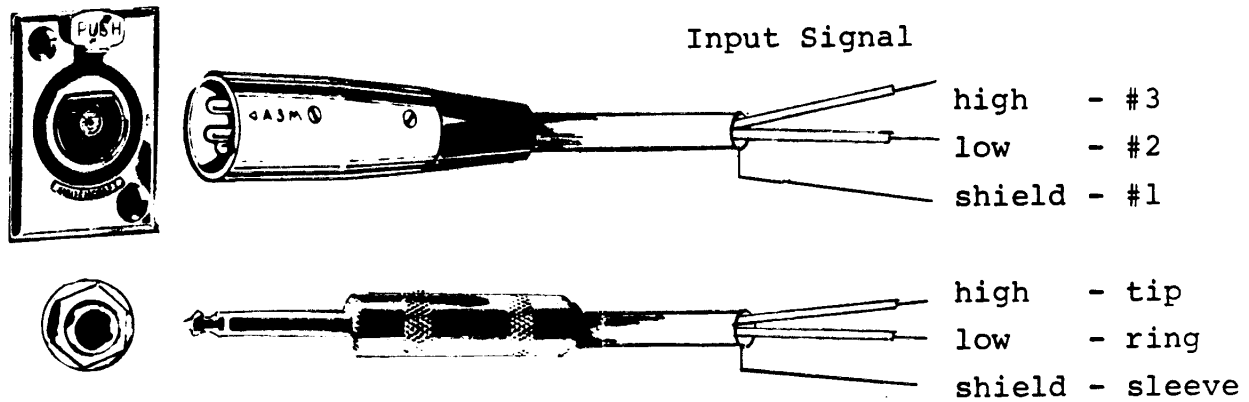

FIGURE 2-1. BALANCED INPUT CONNECTIONS\*

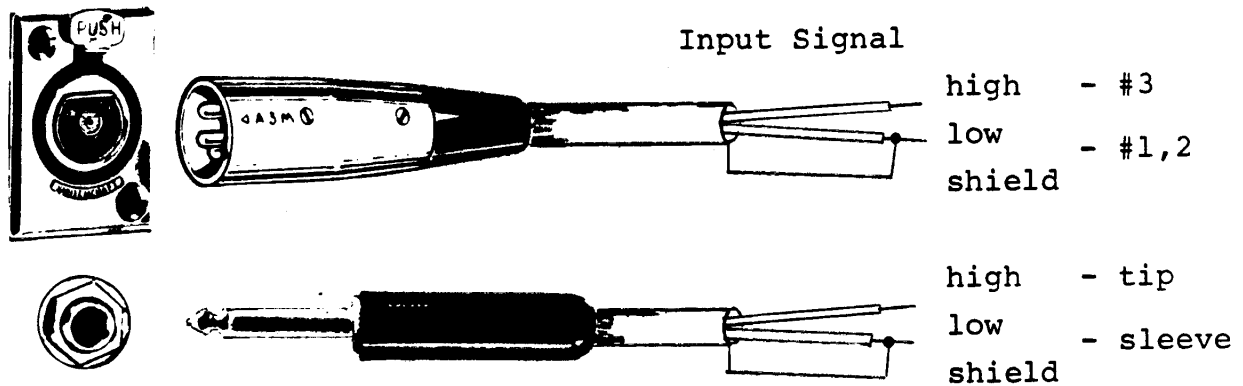

FIGURE 2-2. UNBALANCED INPUT CONNECTIONS\*

---

\* For a given channel, use either XL-type or phone jack, not both. For mono operation, use only Channel A.

---

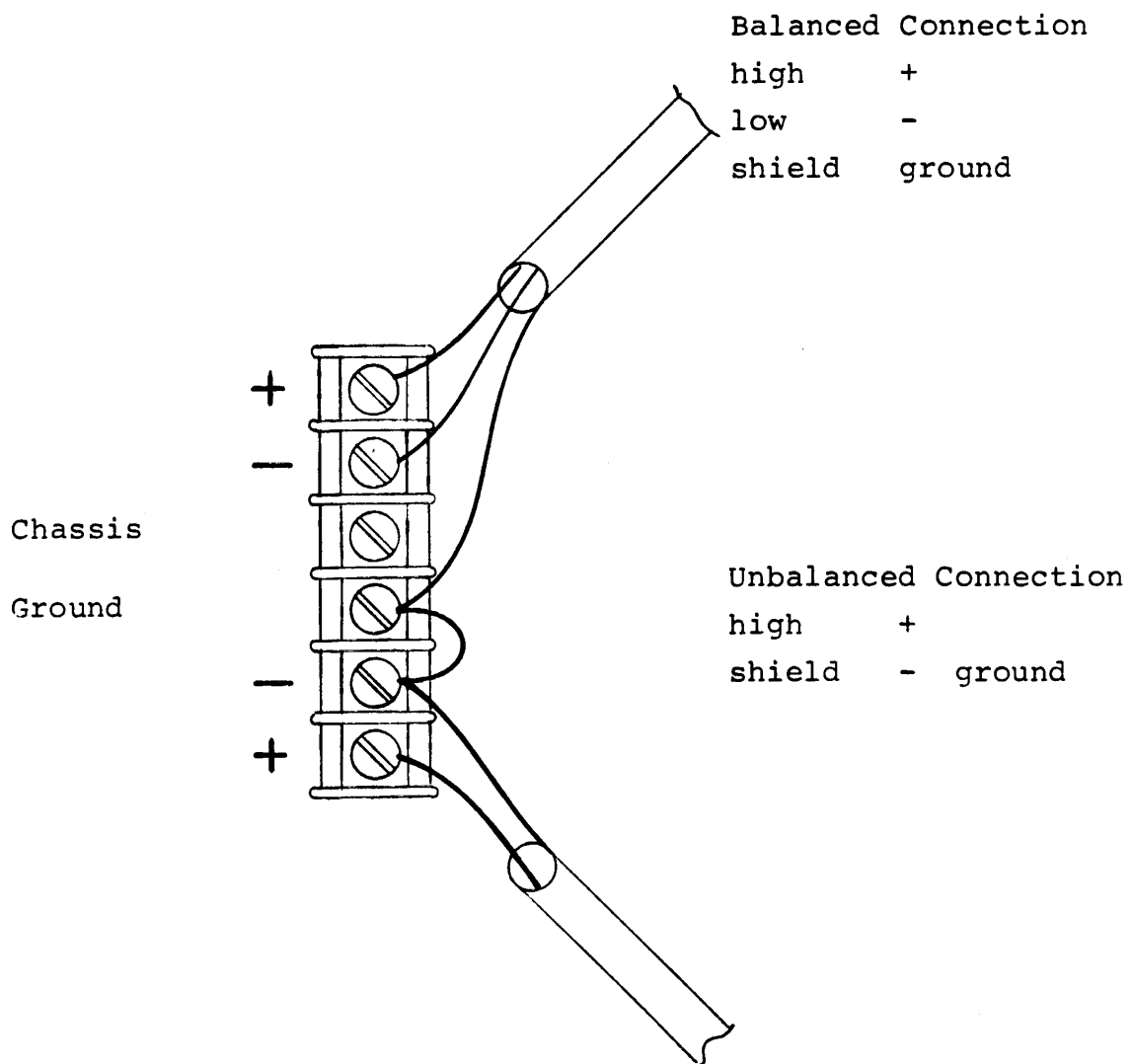

FIGURE 2-3. BARRIER STRIP CONNECTIONS

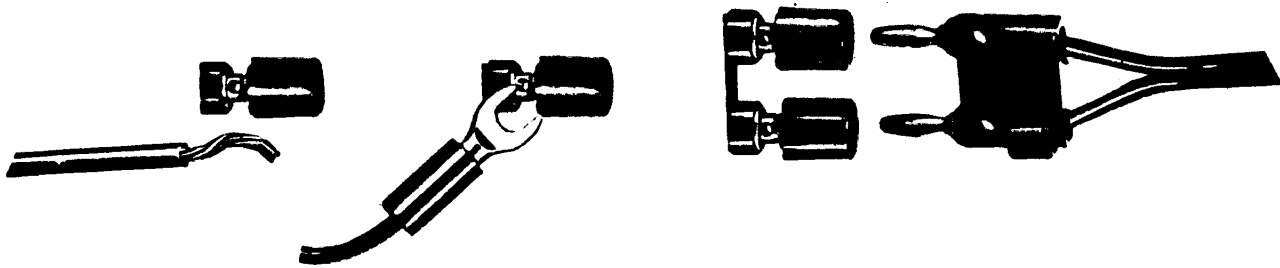

FIGURE 2-4. USE OF FIVE-WAY BINDING POSTS

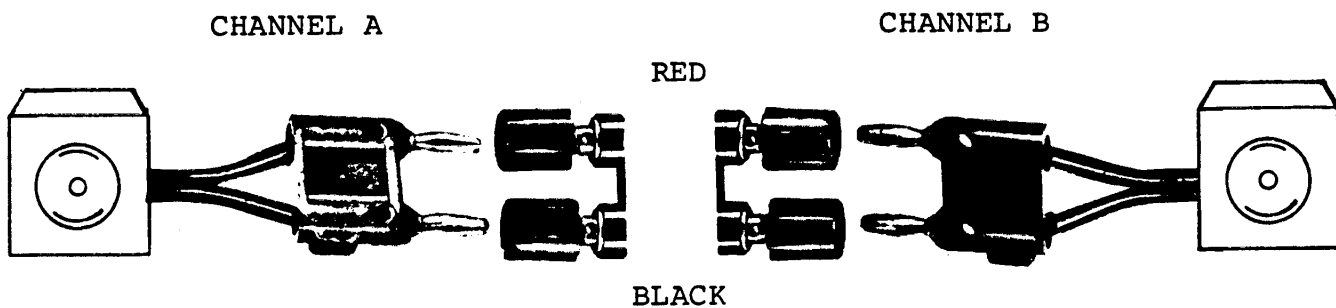

FIGURE 2-5. OUTPUT CONNECTIONS TO TWO CHANNEL SPEAKER SYSTEM

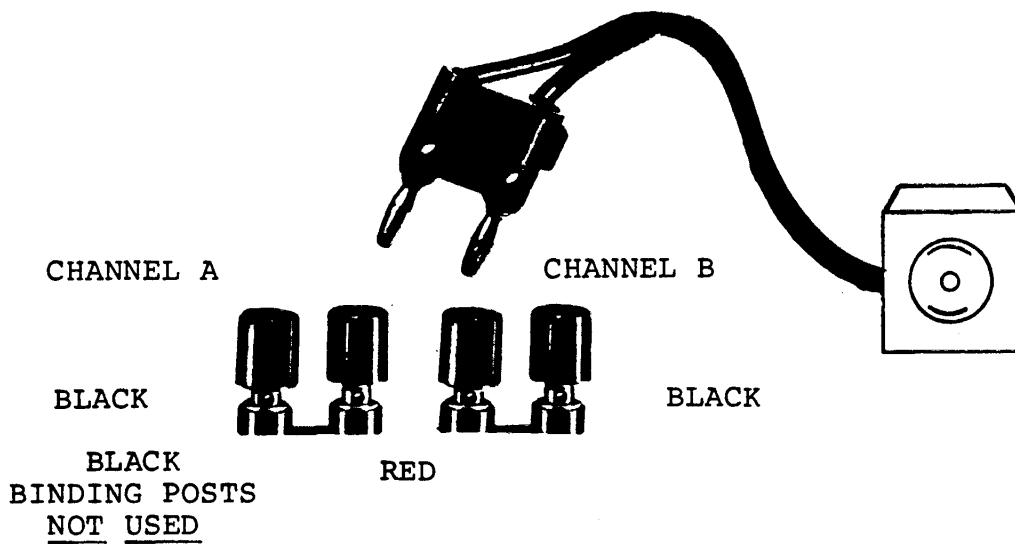

FIGURE 2-6. BRIDGED OUTPUT CONNECTION TO MONAURAL SPEAKER SYSTEM

## SECTION III OPERATING INSTRUCTIONS

### 3.1 GENERAL

The power amplifier should be installed and connected to both the signal source and the loudspeaker system according to Section II. Set the mode switch as appropriate. Set the Level controls to minimum. Then, after the preceding equipment is turned on to provide a stable input signal, the power amplifier may be turned on.

NOTE: IT IS ALWAYS A SAFE OPERATING PRACTICE TO TURN THE POWER AMPLIFIER ON LAST, AND TURN IT OFF FIRST. THIS PREVENTS ANY POSSIBLE TURN-ON/TURN-OFF TRANSIENTS OR EXCESS LEVELS THAT MIGHT BE GENERATED IN THE LINE LEVEL SIGNAL PROCESSING EQUIPMENT FROM REACHING THE LOUDSPEAKERS.

### 3.2 TURN ON AND SYSTEM CHECK

Apply program material, and be ready to monitor the speaker output. Turn on the POWER switch, and observe the STANDBY LED. Initially, it will turn on for a few seconds. No sound will be audible (regardless of Level control setting) because the protection relay has not yet connected the output stages to the five-way binding posts.

After a few seconds, the relay will actuate as the STANDBY LED turns off. At this point, bring up the Level controls until a suitable listening level is reached.

#### 3.2.1 A NOTE ON AMPLIFIER COOLING

Although the need for adequate cooling of the amplifier was briefly discussed under Section II, 2.2, it is necessary to describe the cooling system in more detail.

The amplifier will get hot when operated over a period of time at medium to high output levels. Under normal conditions, the amplifier does not overheat. However, if a fault exists or if the ventilation is not sufficient, the temperature may rise to a point which could cause damage to individual components. The protection circuit then opens the output relays until a safe operating temperature is reestablished. If such thermal cycling should occur, check whether cooling air flow over the amplifier heat sink is insufficient or the heated air cannot be vented away from the amplifier.

### 3.3 CLIP INDICATORS

The channel's front panel CLIP LED will turn on whenever signals exceed the clipping level at the output stage, enabling



the operator to take appropriate action. This LED will remain on long enough to be seen even if the excess signal is only a brief transient. To avoid audible distortion, when the LED indicator flashes more than occasionally, either lower the level of the source feeding the amplifier or turn down the amplifier's Level control. Overload conditions are monitored separately for each channel.

The input differential amplifiers are of sufficient sensitivity to be driven to full output by any medium or high line level source; an input of +3 dB (1.1 V rms) will produce rated output into 8 ohms. The Level control comes after the input stage. Therefore, signal levels up to a maximum of +20 dB (7.75 V rms) can be accommodated without overload. There is little likelihood of clipping in this stage without at the same time clipping the output; it is only possible when the amplifier's Level control is set at #28 or lower. The symptom of such input overdrive is audible distortion without any indication from the CLIP LED. In such cases, simply lower the signal level at the source and use a higher number on the amplifier's Level control.

### 3.3.1 ABOUT SENSITIVITY RATINGS

With regard to sensitivity ratings, power amplifiers are unique. Other audio signal processing and mixing equipment sensitivity describes the average input/output level, whereas a power amplifier's sensitivity describes the input signal required to obtain maximum power output. Therefore, if a mixer, equalizer, or other device is rated at +4 dB nominal output, that average level could continuously overdrive the power amplifier. This is why a level control is provided on the amplifier. By turning down the level at the amplifier, input sensitivity is effectively reduced to match the source so that only peaks drive the amplifier to full output. With a mixer, equalizer, etc. rated at -10 dB to -15 dB nominal output, little or no attenuation is required in the power amplifier.

## SECTION IV THEORY OF OPERATION

### IMPORTANT NOTE

The following descriptions of the circuitry used in the amplifier are presented here in order that the professional user may have a general understanding of how the amplifier works. They are not intended as a guide for service. Service on this product should be performed only by qualified technicians. THERE ARE NO USER SERVICEABLE PARTS INSIDE.

In the following descriptions the component designations for Channel A are used. Component designations for Channel B are included in the schematic diagram at the end of this manual.

#### 4.1 INPUT DIFFERENTIAL AMPLIFIER

The input differential amplifier is comprised of IC1 A and B and associated components. Input signals are coupled to the amplifier after passing through one of three input connector types and passing across RF suppression capacitors C45 and C46.

Two amplifier sections are used as unity gain inverters with the output of one summed to the input of the other to afford common mode cancellation. Thus signals which appear equally on both input terminals, such as common mode noise and hum, will be cancelled and unequal signals, such as legitimate input signals, will be summed. Use of the inverting mode in both sections assures high speed, good common mode rejection and equal impedance at both input terminals, a substantial advantage over less expensive single amplifier topologies.

#### 4.2 MODE SWITCH

The rear panel mode switch allows the amplifier to operate in the Stereo, Dual Mono or Bridged Mono modes. In the Stereo mode, the switch is out of the circuit and each channel input goes to its respective output. In the Dual Mono mode, the output of the Channel A differential amplifier is routed to both Channel A and B gain controls. The signal to the Channel B gain control is "impedance-switched", whereby the extremely low output impedance of the Channel A input amplifier becomes the source for the potentiometer rather than the higher impedance source from Channel B input amplifier through resistor R88. In the Bridged Mono mode, output from the Channel A amplifier is routed through IC2D configured as an inverting amplifier. The output of IC2D is "impedance-switched" to the input of the Channel B voltage amplifier.

The internal gain-match adjustment allows the level of the signal at the output of Channel B to be adjusted to the same level as the output of Channel A. This is done by making the loss through IC2D exactly equal to the gain through Channel A. Channel B, therefore, produces a mirror-image signal of Channel A: i.e. equal voltage but opposite polarity. Bridging the load across outputs A and B results in twice the voltage across the load and four times the power of one channel alone into the same load. The minimum load impedance in this configuration is 8 ohms.

#### 4.3 POWER AMPLIFIER

The JBL 6230/6260 power amplifier employs discrete transistor circuitry after the input gain control. A perfectly symmetrical topology is chosen in order to take advantage of distortion cancellation effects inherent in such arrangements and the equal group delay for each half of an amplified signal. This configuration allows simple compensation, exceedingly wide open loop frequency response and excellent transient intermodulation performance.

Examination of the accompanying schematic will aid in understanding the following circuit description:

Q26, Q27, Q28 and Q29 are configured in matching differential amplifiers loaded by the emitters of Q30 and Q19. Note that no inverting voltage amplifiers are used. All transistors are used in current mode, non-inverting connections. This eliminates bandwidth limiting due to Miller effect (the effective multiplication of collector base capacitance by voltage gain) and resultant reductions of high frequency response. Looking at the "top half" of Channel A, Q26 functions as an emitter follower driving Q27 in the common base mode. The feedback signal at R67 is subtracted from the input at this point. Collector current from Q27 is cascode connected to the emitter of Q30, which is also common base connected. Q30 functions as a non-inverting current to voltage converter with exceedingly high low frequency voltage gain and a dominant pole at 24 kHz with an 8 ohm load and nominal beta output transistors. Closed loop gain rolls at 6 dB/octave to the unity gain crossover (somewhere beyond 2 M<sup>Hz</sup>).

A conventional bias transistor with delta V<sub>be</sub> multiplication spreads the collectors of the upper and lower transconductance amplifiers to compensate for the V<sub>be</sub> drop of the output devices. The bias transistor is, of course, fastened to the heatsink assembly in order to temperature track the output devices.

The output stage is a conventional full complementary Darlington configuration. Again, full complementary is chosen to assure most symmetrical amplification of signals.

#### AN ASIDE: "The Great Quasi-comp Hype."

Some major amplifier manufacturers use all NPN output devices promoting NPNs as more rugged than PNPs. That's true. But think about it. What they don't tell you is that they're also cheaper. So...the logic goes in the Engineering Department; if we could use all NPNs we can squeak by with fewer output devices, and they'll be cheaper, too. "Boy! That ought to be good for my next raise." (And if I can put enough feedback around it I might be able to cancel most of the non-match linearity problems).

At JBL we don't work that way. We know we could save 10 or 15% on output devices if we gave up fully complementary operation but good design sense won't let us compromise our design for a small monetary reward. The ears are the final judge. Now, back down off of the soapbox we have...

The output short circuit protection is the simplest kind. Only non-feedback type current sensing is used. Under overload conditions, current is shunted from the collectors of the "transconductance" stage to the output line and into the load. This quite effectively protects the output stage from destruction with any possible load. No computers, time delays or other such nonsense are used. Simple, clean, fast, rugged design is all that is necessary or desirable unless the design goal is a minimum of output devices in order to save cost. We don't subscribe to such techniques.

#### 4.4 RELAY DRIVER/OUTPUT DC DETECTOR

The output relay K1 is driven by transistor Q23. Diode CR11 shorts out back EMF from the relay coil. Resistor R38 provides a current source for the STANDBY LED when the relay is open. The emitter of Q23 is clamped at -0.6 volts by R42 and CR14. Therefore, the transistor will turn ON when the voltage on its base becomes positive with respect to ground. When the transistor is ON the collector becomes approximately 0 volts and the relay turns on. Current which would have gone to the STANDBY LED is shunted by diode CR12.

The relay is driven by IC2C through current limiting resistor R13. The circuits configured around IC2C perform several functions. A resistor to each low voltage power supply rail in combination with capacitor C13 provide turn-on delay. Resistors R59 and R60 sense excess DC on the outputs of the amplifiers and resistor R41 with thermistor R35 determine overtemperature operation of the heatsink. All of these circuits are diode OR-ed to the inputs of the operational amplifier which is configured as a Schmitt trigger. Resistor R35 overcomes any possible input offset and R34 is positive feedback hysteresis for all circuits except overtemperature, for which resistor R33 provides hyster-

esis. The output of the operational amplifier is normally positive to turn the relay on and goes negative to turn it off.

#### 4.5 CLIP CIRCUIT

In the clip detector circuit, transistor Q36 is normally turned ON, shunting current away from CLIP LED DS1. The peak output voltage of the amplifier as it approaches the power supply rail voltage is sensed through diode CR24 and resistor R71 and turns the transistor OFF, thereby turning the LED ON. Capacitor C38 provides peak stretching to enable transient peaks of short duration to be seen.

#### 4.6 POWER SUPPLY

The power supply is conventional. The AC voltage from transformer T1 is rectified by bridge rectifier BR1 and filtered by the large storage capacitors C41 - C44. The resulting high voltage, high current DC is used in the voltage and output amplifier stages. An additional winding from the transformer is rectified and regulated to supply + 15 VDC for the operational amplifiers, and is rectified and filtered to supply + 24 VDC for the relay coil.

## SECTION V MAINTENANCE

### 5.1 GENERAL

This amplifier is an all solid-state unit, ruggedly constructed with only the highest quality components. As such, it should provide years of trouble free use with normal care. All parts used are conservatively rated for their application, and workmanship meets our rigid standards.

NO SPECIAL PREVENTIVE MAINTENANCE IS REQUIRED.

### 5.2 REPAIRS AND WARRANTY

This product is factory warranted to the original purchaser against defects in material and workmanship for three full years from the date of initial purchase. This limited warranty must be activated at the time of purchase by returning the registry portion of the Warranty Card to the factory. We suggest that you also retain a copy of your sales receipt for proof of warranty status, if necessary. Should a malfunction ever occur, the dealer from whom the unit was purchased will be glad to handle return for factory repair. Please call or write to the factory for a Return Authorization Number which must accompany all repairs. For prompt service, ship the unit prepaid directly to the factory with the RA Number visible on the shipping label. Use the original factory carton; if necessary, call the factory at the number listed below to secure a new carton at a nominal charge. The amplifier is heavy, and shipping to the factory is at the customer's risk; do not take a chance with inadequate packing materials. Tape a note to the top of the unit describing the malfunction, and instructions for return. We will pay one-way return shipping costs on any in-warranty repair.

Because of specially selected components in this product, field repairs are not authorized during the warranty period, and attempts to perform repairs may invalidate the warranty.

Even if your unit is out of warranty, we recommend that you return it to the factory for repairs. Our experienced personnel, supported by special test equipment, will be able to find and eliminate any problem in the most efficient way.

**WARNING:** The full AC line voltage as well as high voltage/high current DC are present at several points inside the chassis. Refer servicing to qualified technical personnel.

Contact:

UREI Incorporated  
8460 San Fernando Road  
Sun Valley, CA 91352 USA  
Telephone 818 767-1000

ZONE	LTR	REVISIONS	DATE	APPROVED
E	PER ECD	-0002	11-12-84	
F	PER ECD	0003		
G	PER ECD	0004		
H	PER ECD	0005		
J	PER ECD	0009	12-20-84	
K	PER ECD	0011	5-30-85	
L	PER ECD	0012	6-6-85	
M	PER ECD	0017	5-11-86	
N	PER ECD	0017	4-20-87	

VALUE CHANGES OF COMPONENTS USED ON BOTH AMP MODELS

COMPONENT VALUES	UNUSED PRT. NOS	LAST DESG. MOD
DESIG: 6230 6260	C 35	R 96
R14 22 27	C 36	C 52
R18 22 27	C 47	Q 37
R22 22 27	C 48	CR 31
R23 22 27	F 56	DS 3
F1 8A 3AB 12A 3AB		
F2 10A 3AB 15A 3AB		
F4-F7 6A 5A 5B 6A 5B		

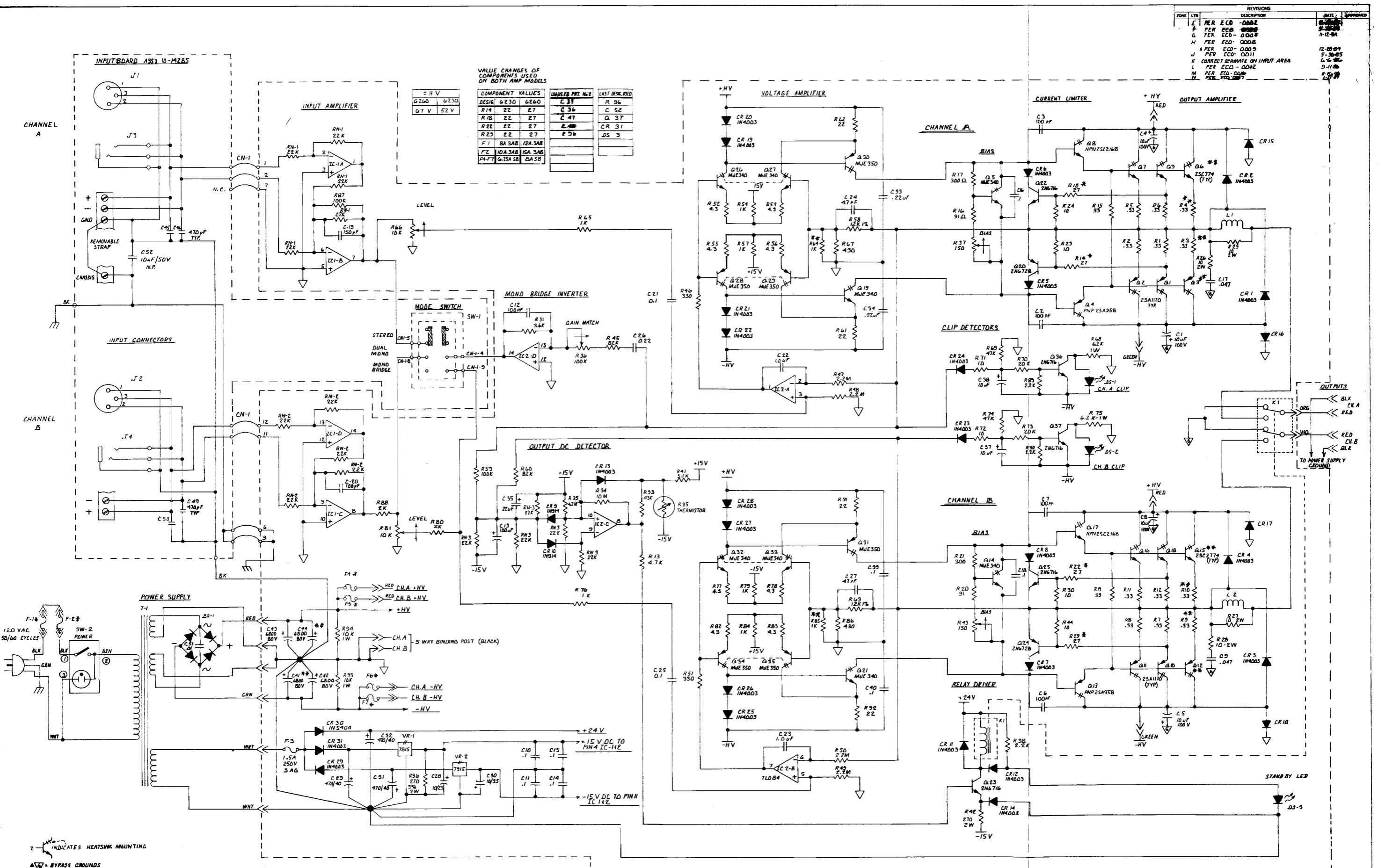

7 - INDICATES HEATSWK MOUNTING

4 - BYPASS GROUNDS

6 - OF AMPS ARE TYPE TL084

4 - ARE NOT USED ON MODEL 6230

3 - SEE COMPONENT TABLE FOR VALUE

2 - ALL CAPACITORS IN MICROFARADS

1 - ALL RESISTORS IN OHMS ± 5% 1/4 W.

NOTES UNLESS OTHERWISE SPECIFIED