

DN27A

**OPERATORS
MANUAL**

KLARK-TEKNIK

RESEARCH LIMITED

**Kidderminster Worcestershire England
Telephone (0562) 741515 Telex 339821**

CONTENTS

	<u>PAGE</u>
INTRODUCTION	3
FUNCTIONS EXPLAINED	4
CONNECTIONS	7
TECHNICAL SPECIFICATIONS	9
CIRCUIT DIAGRAMS	10
WARRANTY	12

INTRODUCTION

The Klark-Teknik DN27A 1/3rd Octave Graphic Equaliser is the successor of the widely acclaimed DN27. It is a totally professional unit which combines the ease of use and reliability of its predecessor with many new features and improvements, to give uncompromising performance and maximum possible flexibility.

Considerable experience in the field of equalisation coupled with a philosophy of continual research and development, has enabled the realisation of a product which meets the design criterion; simply the best.

Use of the highest quality materials and components is maintained throughout: Precision - ground air-gap ferrite cores and custom-wound coils are combined to produce the inductors required in each filter; the faders are oil-damped for smooth, positive operation. The construction is completely dependable and robust, every unit being thoroughly tested both electronically and subjectively before leaving the factory.

The new DN27A features delayed turn-on, "equaliser" and "total system" bypass, an earth-lift facility, and plug-in p.c.b options.

Operated according to this manual the DN27A should give years of trouble-free service.

NOTE

This manual does not include servicing information. Any maintenance or repairs should be carried out by a qualified engineer.

FIG 1

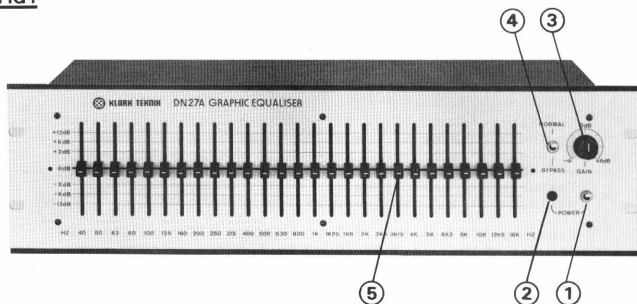
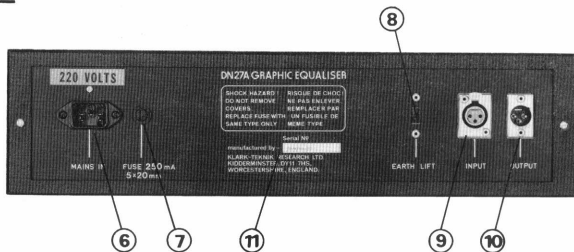

FIG 2



CONTROL CONNECTOR & INDICATOR FUNCTIONS

- (1) Power on/off is by a two-pole toggle switch (which disconnects live and neutral lines when off).
- (2) Power status is indicated by a red led.
- (3) The input level control facilitates input-output system gain of up to 6dB when fully clockwise, and full attenuation of input signal when anti-clockwise.
- (4) For instant A-B comparison between dry and equalised output an "eq" bypass switch is provided.
- (5) Each fader has a travel length of 60mm giving high resolution of settings, and a centre detent allowing accurate "flat" or 0dB setting.
- (6) Mains inlet is via an IEC standard 3-pin socket. (see page 7).
- (7) A separate holder contains the main fuse.
- (8) An earth lift switch is provided on the rear panel (see notes on page 6).
- (9) & (10) Input and output connections are made via complementary 3-pin XLR sockets situated on the rear panel (see page 8).
- (11) The serial number on this label should be quoted in any correspondence concerning the unit.

OTHER FEATURES

In addition to the functions previously mentioned, the DN27A has several note-worthy features.

The main p.c.b houses a relay and associated drive network which performs two important functions.

- 1) The output socket is isolated from the equaliser until power is switched on and all internal power rails are stable. This "delayed turn-on" prevents D.C. or transients caused by powering-up from being transmitted to successive pieces of equipment;
- 2) If, during operation, a loss of power to or power related failure in the DN27A should occur, the input is electronically connected directly to the output, providing "total system bypass". Subsequently, loss of power does not cause complete loss of signal; this may save considerable problems in a "live" situation.

The DN27A power supply includes output voltage regulators which are designed to shut-down if over-heated and are current-limiting. The supply rails are of higher voltage than used in previous units, and allow an output clipping level of +23dBm as well as an extremely good dynamic range.

Also provided on the main p.c.b is a 12 terminal connector (via which input and output lines travel) permitting easy addition of line balancing on an optional plug in board. Power rails are also present on this connector achieving maximum flexibility, i.e. a plug-in p.c.b could house transformer and/or electronic balancing, and could also include such facilities as active filters. (When no such option is used a dummy p.c.b is plugged-in to complete input and output lines.)

As mentioned earlier, an earth-lift switch is situated on the rear panel. Activating this switch connects/disconnects signal ground to/from the mains and chassis earth. Use of this feature may prove invaluable if earth-loop problems are encountered and may provide a quick, certainly safe, solution.

CONNECTIONS

(1) Mains

Connection by an IEC standard power socket, the nominal mains voltage required by the unit is indicated by a label underneath the inlet socket.

If the unit is to be used with any other mains voltage, selection is internally switchable.

NOTE

Any alteration of voltage selection should be made by a qualified engineer.

CAUTION

Before connecting the DN27A to mains power ensure that the correct mains fuse is fitted. Under no circumstances should any fuse other than the specified type be used.

WARNING

The DN27A is fitted with a 3-pin socket. For safety reasons the earth connection should not be removed.

(2) INPUT

Permissible input level is virtually unlimited due to the input attenuator, and A.C. coupling affords input protection from problems caused by D.C. offsets. The input impedance is nominally 10K ohms at any gain setting.

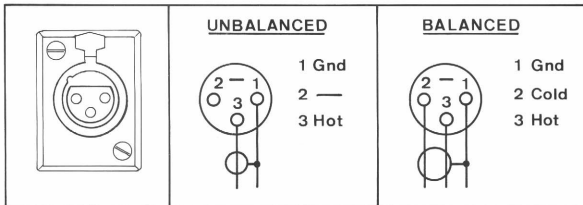

(3) OUTPUT

Output drive capability is +23dBm into a 600 ohms load.

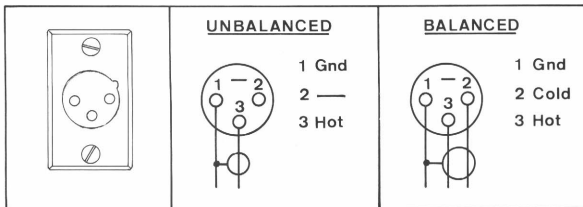

The input and output specifications make the DN27A readily compatible with the best professional quality equipment. One point regarding signal levels should however, be made. High level input signals should be attenuated sufficiently to allow gain in the equaliser section without exceeding the output clipping level. Transients should also be considered and adequate level headroom be allowed to process these accurately.

SPECIFICATIONS

Filters	:	27 filters with centres at 40, 50, 63, 80, 100, 125, 160, 200, 250, 315, 400, 500, 630, 800, 1K, 1.25K, 1.6K, 2K, 2.5K, 3.15K, 4K, 5K, 6.3K 8K, 10K, 12.5K, 16KHz.
Centre Frequency Accuracy	:	Better than $\pm 2\%$ of nominal.
Calibration Accuracy	:	± 0.5 dB.
Frequency Response	:	± 0.5 dB, 20-20KHz with controls flat
Output Clipping Point	:	+23dBm (11V) into 600 ohm load.
Distortion	:	Less than 0.01% 1KHz at +4dBm into 600 ohm load. Less than 0.05% 20Hz-20KHz at +18dBm into 600 ohm load.
Equivalent Input Noise	:	Less than -95dBm 20Hz-20KHz unweighted.
Dynamic Range	:	Greater than 115dB
Input Impedance	:	10K ohms nominal
Output Source Impedance	:	56 ohms short circuit protected
Bypass	:	Equaliser bypass via front panel control. System bypass via gold contact relay during "power down" or when unit is switched off.
Power Requirements	:	200-240v A.C. (100-120v internally switchable) 50-60Hz at 5VA.
Dimensions	:	Width 482 mm(19") Height 137 mm(5.4") Depth 212 mm(8.4")
Optional Accessories	:	Input and output balancing transformers; Perspex security covers; Teak veneered case; Heavy-duty wooden case.

27 slide controls for equaliser filters

By-pass switch

Level control

Power switch with L.E.D. indicator

Earth lift (on rear panel)

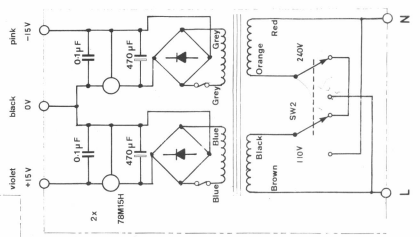
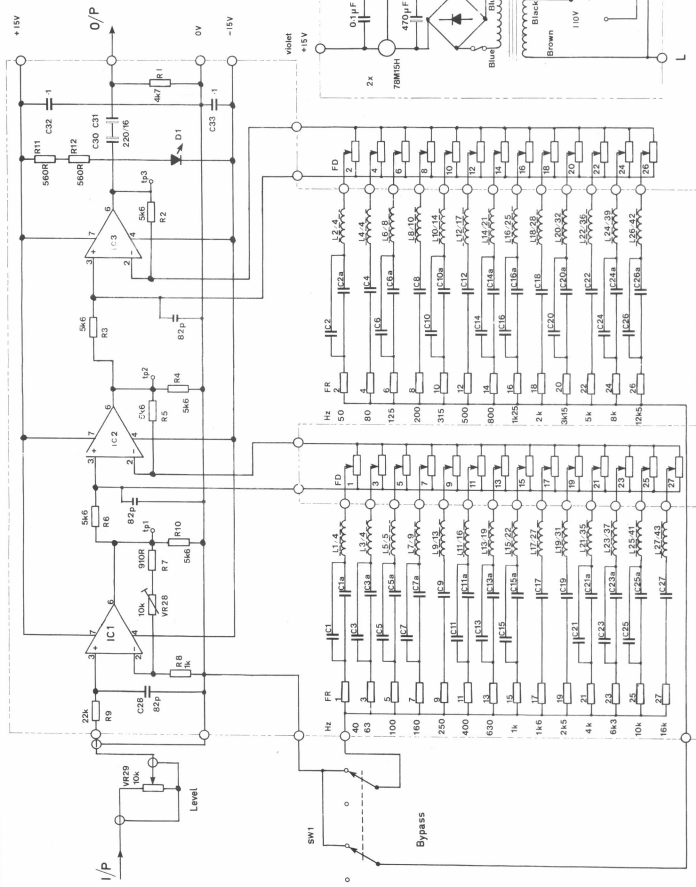

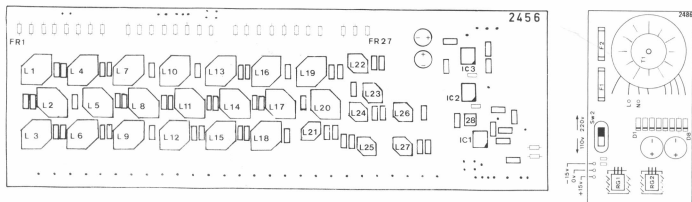

- 1 Preset potentiometer VR20 Adjusted for unity gain with panel level control
VR 29 at mid position.(5)
- 2 Voltage selector SW2 set for 110v or (220v) nominal.
Disconnect MAINS before changing
- 3 Dimensions shown below include dust cover sleeve. Panel height is $5\frac{1}{4}$ to
mount in standard G.P.O. rack.

