

**Operating
and service
information
DN301**

Attenuating equaliser



**Audio engineering
like no other
in the world**

CONTENTS

INTRODUCTION	4
INSTRUMENT FAMILIARISATION	7
AUDIO CONNECTIONS	8
SPECIFICATIONS	9
CIRCUIT DESCRIPTION	10
SCHEMATIC DIAGRAM	11
THE USE OF GRAPHIC EQUALISERS	12
EQUALISING A SOUND SYSTEM	17
INSERTING THE EQUALISER IN THE SIGNAL CHAIN	19
WARRANTY	21
SERVICE REQUEST FORM	22
FADER SETTING RECORD SHEET	24
FREQUENCY CHART	25

Thank You for using Klark-Teknik Product

To obtain maximum performance from this precision electronic product, please study these instructions carefully. Installing and operating the equaliser is not complicated, but the flexibility provided by its operating features merits familiarisation with its controls and connections. This unit has been prepared to comply with the power supply requirements, that exist in your location.

Precautions

Before connecting this unit to the mains power, ensure that the operating voltage is correct for your local supply.

It is important that you observe the following instructions if another voltage setting is required.

Do not install this unit in a location subjected to excessive heat, dust or mechanical vibrations.

Voltage Selection and Power Connection

Connection is by means of an IEC standard power socket. The rear panel voltage label, indicates the voltage required for the satisfactory operation of the unit.

Before connecting this unit to the mains supply, ensure the fuse fitted is the correct type and rating as indicated on the rear panel, adjacent to the fuse holder.

To change the mains voltage selector, remove the voltage label and move the switch over to the appropriate position. Replace the voltage label with the one showing the new voltage setting. Before changing the voltage selector switch, the power to the unit **must** be disconnected.

Safety Warning

This unit is fitted with 3-pin power socket: For safety reasons the earth lead should not be disconnected. If you encounter a problem with earth-loops, use the ground-lift switch on the rear panel to isolate the signal earth from the chassis earth.

To prevent shock or fire hazard, do not expose the unit to rain or moisture.

To avoid electrical shock do not remove covers. Refer servicing to qualified personnel only.

After you have unpacked the Unit

Save all the packing materials - they will prove valuable should it become necessary to transport or ship this product.

Please inspect this unit carefully for any signs of damage incurred during transportation. It has undergone stringent quality control inspection and tests prior to packing and left the factory in perfect operating and mechanical condition.

If, however, the unit shows a sign of damage, notify the transportation company without delay. Only you, the consignee, may institute a claim against the carrier for damage during transportation.

If necessary, contact your supplier or as a last resort, your Klark-Teknik importing agent,* who will fully co-operate under such circumstances.

* See enclosed world-wide importing agents list.

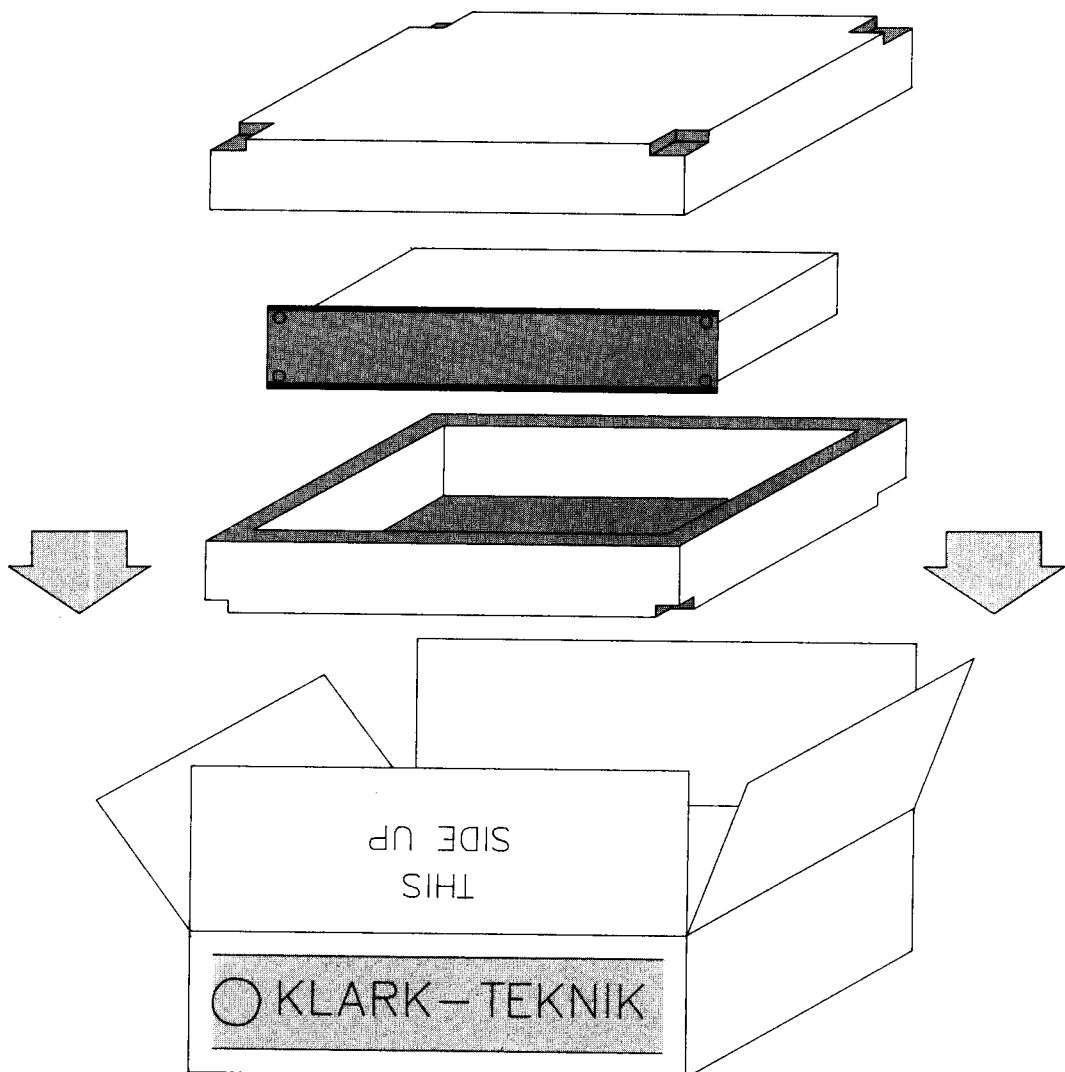

Introduction

The graphic equaliser is a vital component in any audio system. The entire signal passes through it and so any limitations imposed by the equaliser will compromise the performance of the whole system. For example, an indifferently designed equaliser may introduce severe phase distortion, noise and other anomalies related to centre frequency accuracy, filter shape and attenuation accuracy which may manifest themselves as an overall deterioration in the perceived sound quality of the system. Clearly this is an unacceptable state of affairs, but fortunately your choice to utilise Klark-Teknik graphic equaliser product will eliminate these problems, offering you unprecedented product performance coupled with the highest filter calibration and reliability standards in the industry.

For many years Klark-Teknik has been at the forefront of equaliser design, and have carried out detailed research into optimum filter response characteristics, including their sonic performance.

The Series 300 range of equalisers is a direct result of this research. It should be noted that graphic equalisation cannot always overcome all frequency response related problems. There are applications where the ability to cut or boost the response at a particular frequency, or over a certain bandwidth other than the equaliser specified one, is required to overcome exceptionally difficult response anomalies or narrow band feedback problems. When such an instance is encountered, it may be more appropriate to use the greater range of control provided by a parametric type equaliser, where the centre frequency, bandwidth and amplitude are all controllable.

Reliability is also of paramount importance which is why our filters are designed around a technique commonly used in computer manufacturing - thick film engineering. This technique has enabled Klark-Teknik to build these new filter circuits into self-contained packages which are referred to as "**MELT**". These micro-electronic circuits are so consistent and reliable that we are able to warrant those solid state devices for 5 years. This type of "fit and forget" technology, already proven all over the world, provides users with products that perform brilliantly year after year.

When using an equaliser remember that the need to use large amounts of boost or cut within the equalisation curve indicates that there may be something fundamentally wrong with the sound system or room acoustics, which should be further investigated and corrected before final equalisation is applied.

DN301 Graphic Equaliser

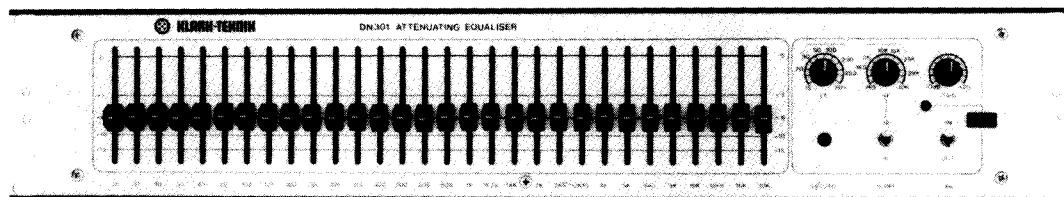

The Klark-Teknik DN301 is a single channel, 30 band equaliser offering 15dB of cut in 1/3 octave steps between the frequencies of 25Hz and 20kHz, with 20dB of available system make-up gain.

Filter Shape and Combining Action

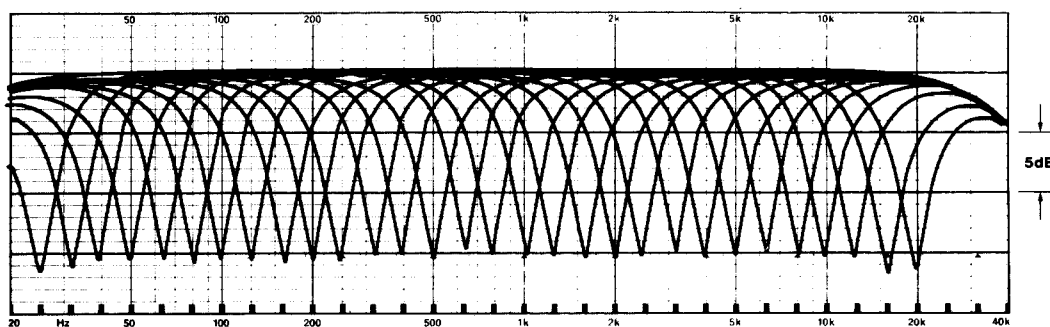

Cut Only 1/3 Octave Equaliser Filter Curves.

At the heart of any graphic equaliser is the bank of filters used to shape the signal response, and Klark-Teknik utilise a proprietary filter circuit which replaces the conventional inductor based circuit, at the same time, offering several performance advantages. Inductor based circuits are heavy, expensive to produce and suffer from low frequency distortion and induced hum. Klark-Teknik's proprietary filters on the contrary suffer none of these problems, yet offer unequalled phase response and control accuracy with the additional benefits of low noise and minimal ripple.

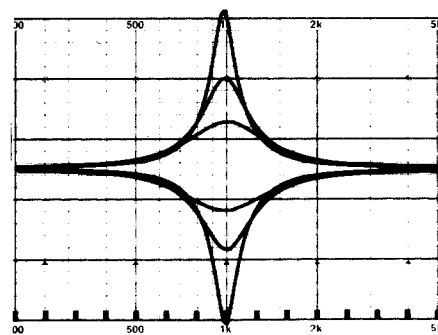

Single Filter Response Curves (1/3 Octave).

The nature, shape and way in which individual equaliser filters combine, has a profound effect on the control provided by the equaliser and on the resulting quality of sound. The majority of applications within the sound reinforcement, broadcast and recording fields, require a smooth and continuous equalisation response curve in order to correctly contour the overall response characteristics of a sound system, loudspeaker, recording effect or audio channel. To achieve this, the individual filters must be capable of combining smoothly together to result in a continuous response curve, free from shape discontinuities in order to avoid unwanted audible peaks or anomalies in the final sound.

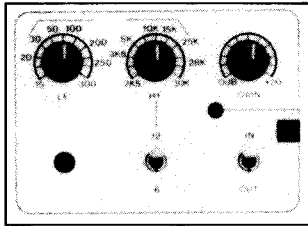

In order to offer the greatest flexibility, with more versatile approach to limiting the bandwidth of low and high frequency signals, high and low-pass filters with variable turnover frequencies are incorporated, the low-pass filter having a selectable slope from 6 to 12dB/octave.

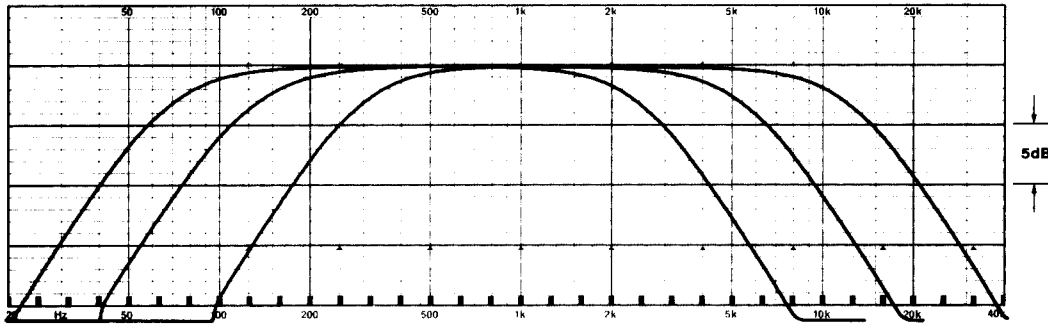

Variable High and Low cut filter response curves.

Other Features

The bypass switch silently removes both the graphic equaliser section and the high/low-pass filters from the signal path.

Other features include an overload LED, which warns of impending overload at any point in the equaliser, a signal ground lift switch and an optional security cover to prevent unauthorised personnel from tampering with the control settings. A failsafe relay is incorporated into the design, which automatically and silently bypass the equaliser in the event of power supply failure. This relay also acts at switch-on to isolate the equaliser until the power rails have settled, thus precluding the possibility of a potentially damaging switch-on thump.

This product is built to the same high electrical and mechanical standards as all Klark-Teknik equipment and is both robust and stylish. It occupies a standard two units of rack space and has an electronically balanced input and unbalanced output. Output balancing transformers are available and retrofittable.

Reliability Control

Even with the advanced technology incorporated in this product, each instrument is given the full backing of Klark-Teknik's "**reliability control**" which proves each product against a specification consistent with the highest professional standards. Only top quality components are used, and every unit is bench tested and aligned before a burn-in period and final performance test.

Options

Aluminium security cover

Perspex security cover

Transformer input*/output balancing

* input transformer balancing is non retrofittable and has to be specified with order.

Options Ordering Information

Perspex security cover

Aluminium security cover

Output balancing transformer

Input balancing transformer

Parts Number

SC30

SC31

BU37

BN37

Instrument Familiarisation

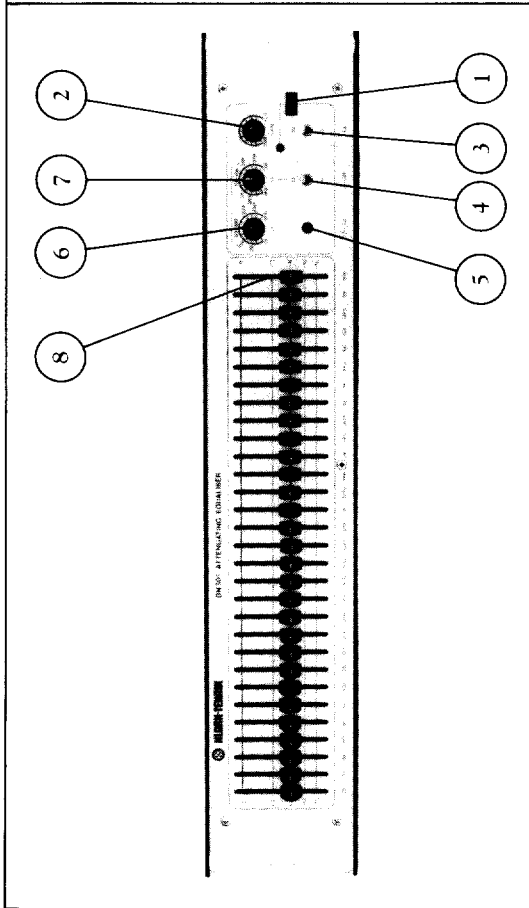

Front Panel Functions

1. The **power switch** is a two pole type isolating both the live and neutral conductors. When the power is on, a red status LED lights.
2. The **output level control** allows the system gain to be up to +20dB when in its fully clockwise position, and offers full attenuation in its anti-clockwise position.
3. The **bypass switch** silently removes both the high/low-pass filters and the graphic equaliser section from the signal path.
4. The **low-pass filter** may be switched to 12 or 6dB per octave response by means of the slope switch.
5. The **Overload LED** The signal level is monitored at several separate points within the circuitry of the unit, and any one of these signal exceeding a threshold, set 3dB below clipping, will cause the LED to light. This threshold is set at +19dB. Excessive amounts of gain applied with the Output Gain control may cause this level to be exceeded. In this event, the output gain control should be turned down to correct the problem. However, if the input signal itself exceeds +19dBm the input stage will be overloaded. If this problem arises, the signal level from the output of the preceding piece of equipment must be turned down.
6. The **low frequency filter** (high pass) has a continuously variable turnover frequency from 15Hz to 300Hz.
7. The **high frequency filter** (low pass) has a continuously variable turnover frequency from 2.5kHz to 30kHz.
8. The **high quality faders** used in this equaliser have an oil-damped action for smooth operation and feature a centre detent allowing accurate "flat" setting.

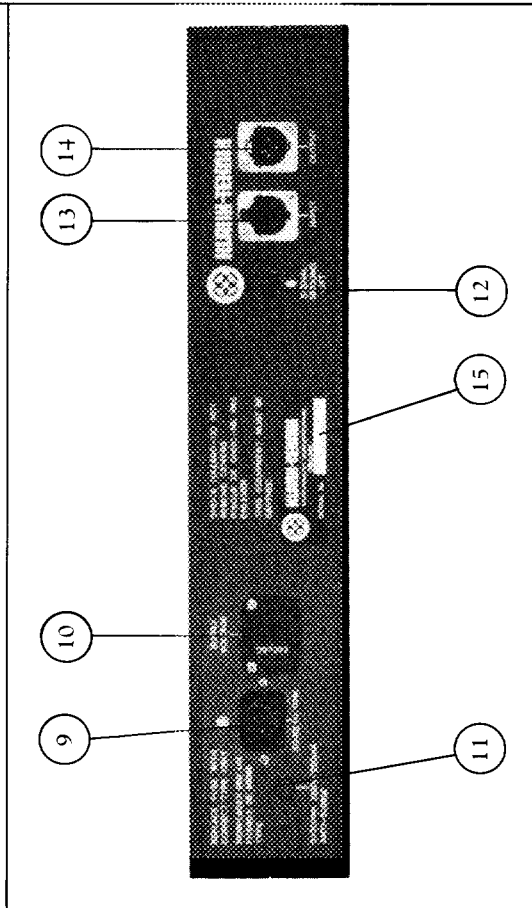

Rear Panel Functions

9. **Mains** is supplied via an IEC standard 3 pin connector. A compatible power cord is supplied with the unit.
10. **Voltage selector switch** This unit is designed to be switchable between two nominal supply voltages, 110V and 220V. To facilitate this, a slide switch is fitted, accessible from the rear panel. The power supply **MUST** be disconnected before the switch is reset. Note too that any attempt to operate the unit from a 220V supply with the switch set to 110V is liable to result in severe damage to the unit.
11. The **mains fuse** is located in a fuse holder fitted to the rear panel. Always replace with the correct type and rating of fuse, as indicated adjacent to the fuse holder.
12. **Earth-lift switch** Situated on the rear panel, this switch disconnects the signal ground from the mains and chassis earth. This should be used if hum attributable to earth-loops is experienced and will generally solve the problem. It is also safe, unlike the practice of disconnecting the mains earth from the power cord.
13. **Input and output connections** are made via complementary XLR style sockets. For wiring details see page entitled Audio Connections.
14. The **serial number** of this unit should be quoted in any correspondence concerning the unit.

Audio Connections

Input

The input circuitry is a transformerless, electronically balanced design which achieves a symmetry of better than -50dB from 20Hz to 10kHz .

If transformer balancing of the input is required, this must be stipulated at the time of order; it is not retro-fittable.

Output

The standard output is unbalanced, but balancing transformers are available and may be retrospectively fitted. The output circuitry is capable of driving a $600\ \text{ohm}$ load at a level of $+22\text{dBm}$.

Input

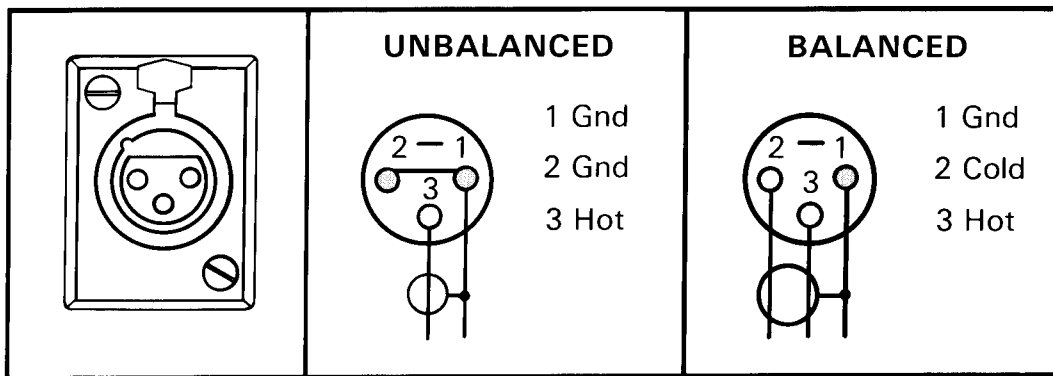

Output

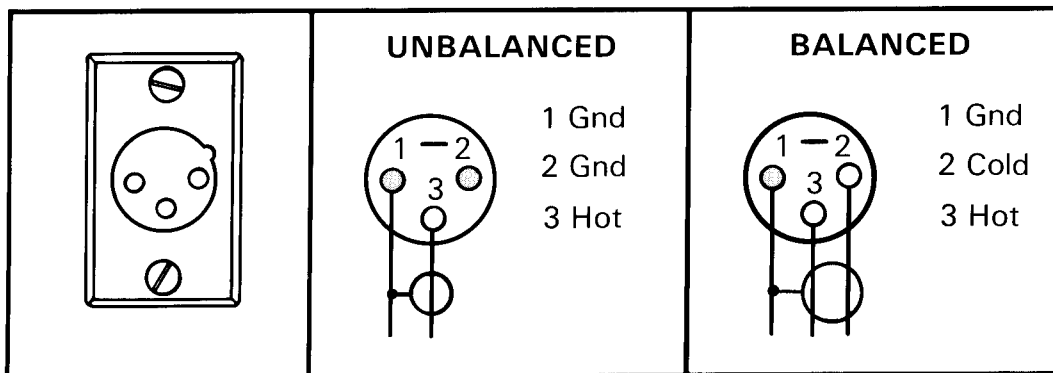

Note: When using a fully balanced system, either pin 2 or pin 3 may be the HOT terminal.

Balanced Circuits

Transformer or electronically balanced connections have the benefit of "common mode rejection" which eliminates externally induced interference such as mains hum etc. Balancing is especially useful when long cable runs are used between pieces of equipment.

Transformer balanced circuits have the added advantage of being, "fully floating" with the ground (earth) or screen being totally isolated from the signal. In installations where a difference in earth potential is likely to occur this isolation prevents grounding problems which can, in some cases, damage the equipment.

Specifications

Input

Type	Electronically balanced
Impedance (ohm)	
Balanced	20k
Unbalanced	10k

Output

Type	Unbalanced
Min. load impedance	600 ohms
Source impedance	<60 ohms
Max. level	+22dBm

Performance

Frequency response	Eq out	±0.5dB (20Hz - 20kHz)
	Eq in	User defined
Distortion (@ +4dBm)		<0.01% @ 1kHz
Equivalent input noise		<-90dBm (20Hz - 20kHz unweighted)
Overload indicator		+19dBu threshold
Gain control		0 to +20dB

Filters

Type	*MELT
Centre frequencies	30
ISO	25Hz - 20kHz 1/3 octave
Tolerance	±5%
Maximum cut	-15dB
High pass filter slope	15Hz - 300Hz 12dB/octave
Low pass filter slope	2k5Hz - 30kHz 6/12dB/octave

*MELT - Proprietary Microcircuit

Power Requirements

Voltage	110/120/220/240V 50/60Hz
Consumption	<15 VA

Weight

Nett	3.5kg
Shipping	6kg

Dimensions

Width	482mm (19 inch)
Depth	205mm (8 inch)
Height	89mm (3½ inch)

Terminations

Input	3 pin XLR
Output	3 pin XLR
Power	3 pin CEE

DN301 Circuit Description

Input Section

The input signal enters via XLR-type connector SKT2 and may be balanced or unbalanced (see audio connector wiring details). The signal is then connected via relay RL1 and first order R.F. filter networks R7/C20 and R12/C22 to the differential input amplifier IC1. Common mode rejection is factory set with P1 to give maximum rejection at 100Hz; typically 85dB. This stage is followed by the potential divider R16, R17 which attenuates by 4dB and voltage follower IC2B.

H.F. and L.F. Cut Filters

From IC2B the signal passes through the L.F. and H.F. cut filters. These are 12dB/octave second order Butterworth filters arranged around a single amplifier IC3A, with the H.F. cut filter also being switchable to first order, 6dB/octave slope. The turnover frequency for each filter is continuously variable; between 15Hz and 300Hz for L.F. cut and 2k5 to 30k for H.F. cut. Resistors R24 and R25 set filter characteristics, and result in a gain of 4dB for IC3A. The potential divider R26, R27 attenuates by 4dB and is buffered from the equaliser section by voltage follower IC3B.

Equaliser Section

The equaliser filters are arranged in 2 sections with odd no. filters (1,3,5....29) connected to IC4 and even nos. to IC5, via their respective faders.

To demonstrate the working principles of the equaliser section, the behaviour of one filter is now examined. The remaining filters perform in a similar manner.

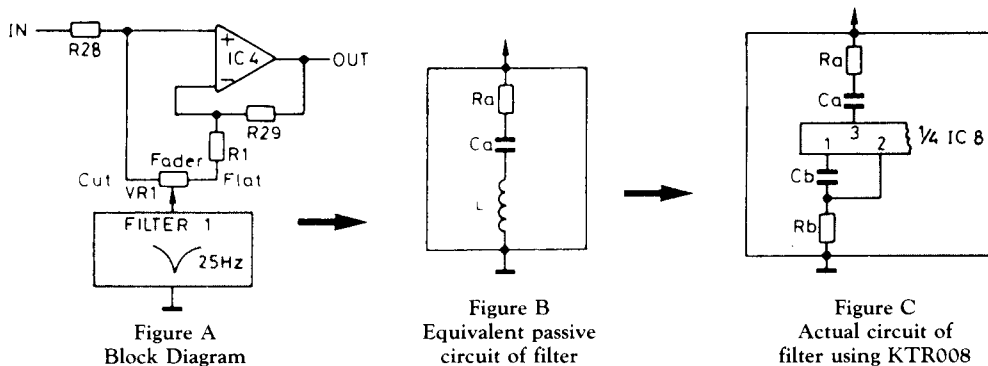

In Figure A the equaliser filter 'block' represents a minimal impedance to ground at its centre frequency, in this case 25Hz. Moving the fader towards 'cut' causes attenuation through R28 at the filter frequency only. With the fader set to 'flat' VR1 = R1, the filter has no effect and since R28 and R29 are equal in value, all frequencies are passed at unity gain.

Each filter circuit is functionally similar to the passive LCR network shown in figure B. The inductor, L, is however replaced by a better performing active circuit consisting of 1/4 of a proprietary KTR008 device plus Cb and Rb and, as in figure B, Ra sets the maximum cut figure for the filter at its centre frequency (nominally -16dB). Ca, as in figure B, is the frequency determining capacitor.

High frequency stability of the equaliser section is assured by capacitors C30, 31, 32, 33, 34, 35.

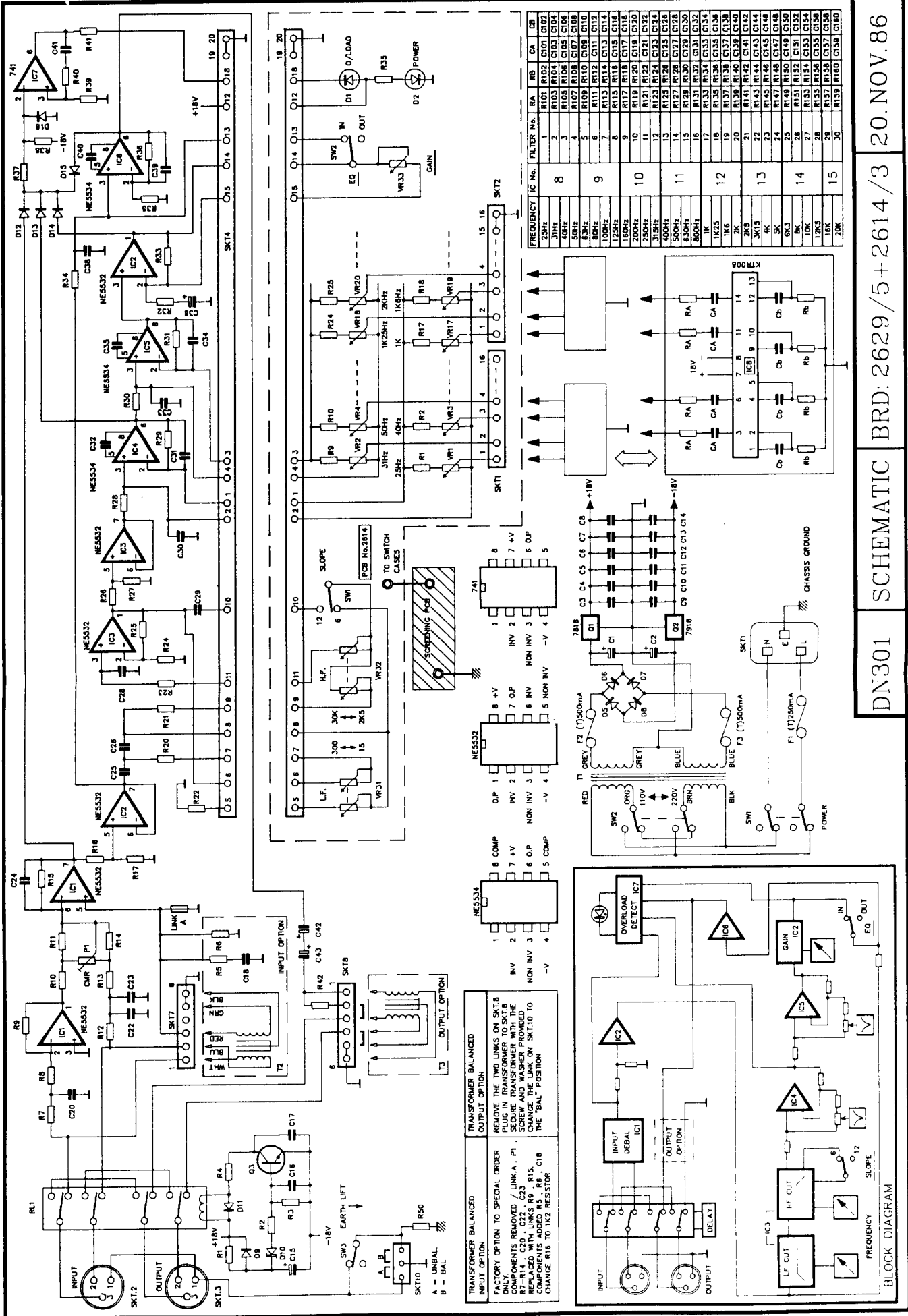

TRANSFORMER BALANCED OUTPUT OPTION
 REMOVE THE TWO LINKS ON SKT.8 ONLY.
 PLUG IN TRANSFORMER TO SKT.8 SECURE TRANSFORMER WITH THE SCREW AND WASHER PROVIDED.
 COMPONENTS REMOVED / LINK A, P1, R7-R14, C20, C22, C23, C25, C26, R9, R15, COMPONENTS ADDED R5, R6, C18 CHANGE R16 TO 1K2 RESISTOR

TRANSFORMER BALANCED INPUT OPTION
 REMOVE THE TWO LINKS ON SKT.8 ONLY.
 PLUG IN TRANSFORMER TO SKT.8 SECURE TRANSFORMER WITH THE SCREW AND WASHER PROVIDED.
 COMPONENTS REMOVED / LINK A, P1, R7-R14, C20, C22, C23, C25, C26, R9, R15, COMPONENTS ADDED R5, R6, C18 CHANGE R16 TO 1K2 RESISTOR

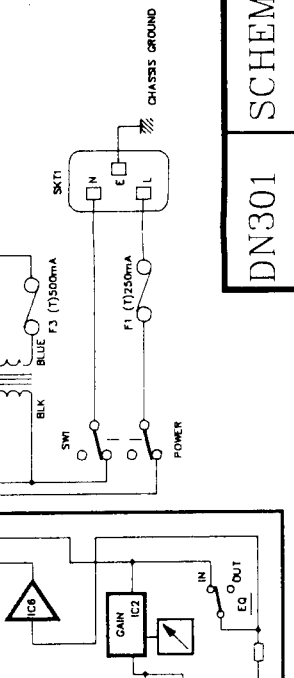
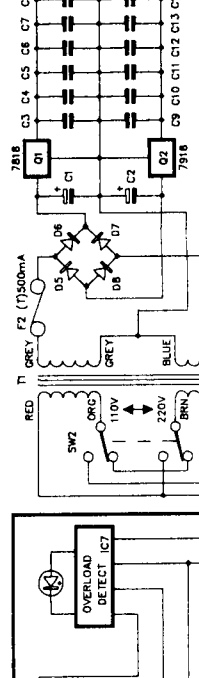
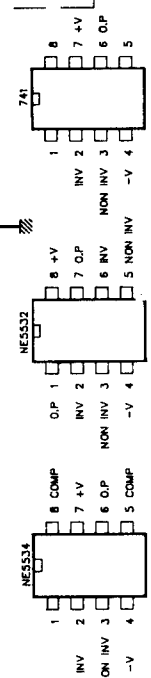
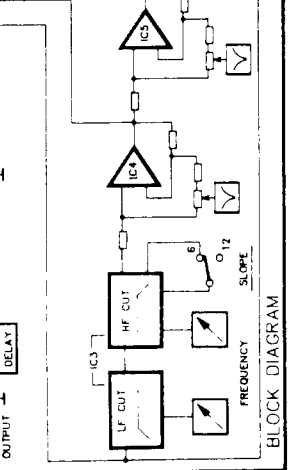

Gain Control

The output of IC5 is connected to non-inverting amplifier IC2A. Gain of IC2A is continuously variable between 0 and +20dB by 'Gain' potentiometer VR33.

Eq. In/Out Switch

With Eq. switch to 'out' the non-inverting output of IC6 is connected via R34 to the output of IC2B, bypassing low and high cut filters, equalisation section and gain control section. With Eq. switch to 'in' resistor R34 is in effect 'shorted' by the low impedance output of IC2A and only signal from the equaliser section via IC2A, is now passed.

This method gives an uninterrupted transition from Eq. 'out' to 'in' switch positions.

Output Section

Output amplifier IC6 is a non-inverting 5.5dB gain stage with a high current drive capability. High frequency stability is optimised with capacitors C38, 39, 40. The output of IC6 is A.C. coupled by C42, 43 and is connected to output transformer socket SKT8. On the standard (unbalanced output) unit, 2 plug-in links on SKT8 connect signal to pin 3, ground to pin 2, of the output XLR connector via bypass relay RL1. On units with transformer balanced output, the 2 links are removed and the transformer is connected to SKT8.

Bypass Relay

With power to the unit removed, input and output XLR pins 2 and 3 are connected together via relay RL1. When power is connected, the delay circuit waits 2 seconds before switching in RL1, so avoiding output 'clicks'. On power 'off' the relay is switched off instantly, again avoiding output 'clicks'.

Relay Delay Circuit

When power is turned on, C15 is charged via R1 until the voltage on C15 exceeds $-3V$. At this time (2 seconds from turn on), D10 conducts. When the voltage across R3 exceeds 0.6V, Q3 switches on applying $-18V$ to R4, so switching the relay RL1 'on'. R4 limits the voltage across RL1 to 20V. When power is turned off, the $+18V$ supply starts to fall and D9 discharges C15, immediately switching off Q3 and RL1.

Overload Detect Circuit

Negative bias on the inverting input of IC7 gives $+18V$ at the output of IC7, thus overload LED D1 is normally 'off'. Signal levels at 4 points within the equaliser are rectified through diodes D12, 13, 14, 15. When a high level signal (greater than $+19dB$) gives a voltage on the inverting input of IC7 that exceeds the OV threshold, the output of IC7 switches to $-18V$, so turning on LED D1.

R40 and C41 extend the 'on' time of the overload circuit to ensure signal transients are adequately displayed.

Power Supply

The power supply is a $\pm 18V$ design using a low noise toroidal transformer with split primary and secondary windings. The two primaries are connected in series or parallel by SW2 to give 220 or 110 Volt nominal operation. The secondaries drive a full wave bridge rectifier, 2 smoothing capacitors and integrated circuit positive and negative regulators. Decoupling capacitors C3 to C14 ensure low noise supply rails. Power "on" is indicated by LED D2 which is connected between $+18V$ and ground via R35.

The use of Graphic Equalisers

Equalisers may be used for corrective or creative purposes and the Klark-Teknik DN301 is applicable in both live sound and studio applications.

For studio use, a pair of 1/3 octave equalisers might typically be used to compensate for deficiencies in the control room acoustics and in this instance, the precision allowed by 30 bands is a great advantage. Because it is almost impossible to set up an equaliser accurately without first analysing the room response, the centre frequencies of the filters have been chosen to correspond with those of the Klark-Teknik spectrum analyser, Model number DN60. In this way, the readings can be transferred directly from the analyser to the equaliser.

It must be stressed however that even a good equaliser doesn't offer a complete solution where the room has severe, inherent acoustic problems. For example; standing waves and resonances cannot be made to disappear simply by using equalisation. True their effects can be reduced, but in a critical listening environment such as a studio control room or a concert hall, efforts must be made to minimize these problems at source before equalisation is employed. Also, equalisation cannot overcome the lack of sound clarity caused by rooms with unduly long reverberation times though they may be able to effect some improvement in the intelligibility.

On the other hand, the sound company who may well have to set up in different venues night after night have little or no control over the acoustics of the building and so have to use equalisers to arrive at a compromise solution. Depending on the room, some compromises will be more successful than others. Again, effective use of the equaliser means employing the services of a spectrum analyser. It is however not always desirable to achieve a dead flat room response. For example, applying substantial amounts of bass boost to try and restore a weak bottom end is going to use up large amounts of amplifier power and the extra loudspeaker cone excursions so caused will rob the system of headroom and may cause distortion. The harmonics produced by an amplifier driven into clipping may also damage the high frequency drivers and will at any rate sound unpleasant.

Therefore, reducing the low frequency output may produce real advantages by way of improved intelligibility and subjective naturalness and this is particularly true of

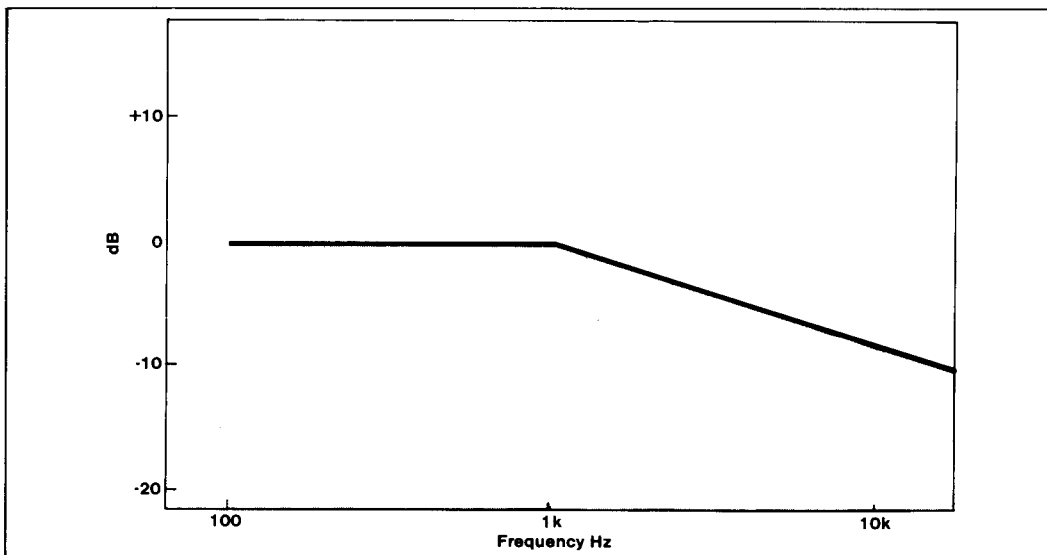

Typical House Curve.

buildings made from concrete or stone where much of the bass is reflected rather than absorbed. Equally, rolling off the high frequency end above 5kHz may also contribute to a more natural sound. The resulting house curve then is far from flat but may well be the ideal compromise. Depending on the individual sound system and the environment, the shape of the optimum house curve will vary and a degree of experience is needed in order to achieve the best results. It should also be borne in mind that the ideal house curves for pure speech and music will not be the same.

In live sound applications, graphic equalisation is almost always applied separately to the stage monitor or foldback system to reduce the level of those frequencies that would otherwise cause feedback problems. These problems come about due to peaks in the frequency response curves of the monitor speaker systems, monitor positioning, and sound reflected from the stage walls. An analyser is probably best employed to do this effectively but many experienced engineers rely on their ears.

In addition to compensating for room acoustics, equalisation can also be used to counteract some of the problems caused by microphone characteristics and positioning or to tailor the response to improve speech intelligibility. Also, many speaker systems have a far from flat response, particularly mobile systems that have to be positioned in physically convenient places rather than the acoustically ideal ones. When equalising the room, these deficiencies are also catered for to a large extent.

Whatever the application, it is generally better to try to attenuate peaks rather than to attempt to boost the surrounding frequencies to the same level. Furthermore, all peaks can be reduced by attenuating their respective bands but some response dips simply cannot be corrected. **An example is crossover cancellation where very deep notches may appear covering two or three bands.** Attempting to level the response by excessive boosting will simply eat up system power and achieve no useful result. Ultimately a dip in the response is not so audibly objectionable as a peak and so it may be as well to leave these dips alone or to try and solve the problem at source by checking your crossover systems and horn alignment.

In broadcast studios, graphic equalisers are often used during phone-in shows to help compensate for the restricted bandwidth of telephone lines. No equaliser can completely correct the signal in this way as it is impossible to boost frequencies that don't exist and telephone lines have a very restricted bandwidth. Nevertheless, the improvement in subjective terms can be dramatic.

Creative uses may include studio work, live or recorded drama and film soundtrack recording. Voices may be harshly filtered to simulate telephone conversation or the tonal characteristics of an instrument may be modified to fit in with a particular mix.

Though other types of equaliser can often do this job just as well, the graphic equaliser is still the easiest to set up and the controls give an instant visual representation of the response curve. In the commercial studio where time is often of the essence, this attribute should not be overlooked.

Table 1: Effects of Equalisation on Voice Reproduction

1/3 Octave centre frequency (Hz)	Effect on voice
40, 50, 63, 80, 100, 125	Sense of power in some outstanding bass singers.
160, 200, 250	Voice fundamentals.
315, 400, 500	Important for voice quality.
630, 800 1k	Important for voice naturalness. Too much boost in the 315 to 1k range produces a telephone-like quality.
1.25 to 4k	Vocal fricatives - accentuation of vocals. Important to speech intelligibility. Too much boost between 2 and 4kHz can mask certain speech sounds e.g. 'm', 'b' and 'v' can become indistinguishable. Too much boost anywhere between 1 and 4kHz can produce 'listening fatigue'. Vocals can be highlighted by slightly boosting the vocal at 3kHz and at the same time slightly dipping the instruments at the same frequency.
5, 6.3, 8k	Accentuation of voice.
	The range from 1.25 to 8k governs the clarity of voice.
10, 12.5, 16k	Too much boost causes sibilance.

Table 2: Effects of Equalisation on Music Reproduction

1/3 Octave centre frequency (Hz)	Effect on Music
31, 40, 50, 63	Fundamentals of bass drum, tuba, double bass and organ. These frequencies give music a sense of power. If over-emphasised they make the music 'muddy'. 50 or 60Hz band also used to reject ac. mains hum.
80, 100, 125	Fundamentals of lower tympani. Too much boost produces excessive 'boom'. 100 or 125Hz also used for hum rejection.
160, 200, 250	Drum and lower bass. Too much boost produces excessive 'boom'. Also useful for 3rd harmonic mains hum rejection.
315, 400, 500	Fundamentals of strings and percussion.
630, 800, 1k	Fundamentals and harmonics of strings, keyboards and percussion. Boosting the 600 - 1kHz range can make instruments sound horn-like.
1.25 to 4k	Drums, guitar, accentuation of vocals, strings and brass. Too much boost in the 1 to 2kHz range can make instruments sound tinny. Too much boost anywhere between 1 to 4kHz can produce 'listening fatigue'.
5, 6.3, 8k	Accentuation of percussion, cymbals and snare drum. Reduction at 5kHz makes overall sound more distant and transparent. Reduction of tape hiss and system noise. The 1.25 to 8k governs clarity and definition.
10, 12.5, 16k	Cymbals and overall brightness. Too much boost causes sibilance. Reduction of tape hiss and system noise.

Equalising a Sound System

When equalising a sound system you should always remember just what it is that you are trying to achieve. Two fundamental reasons for equalisation are:-

1. **To increase the potential gain or power output of the system before feedback.**
2. **To improve the naturalness or intelligibility of the sound system.**

In a space with poor acoustics or high levels of background noise, the most natural sound may well not be the most intelligible - a compromise must therefore be reached between these two qualities depending on the particular application in question - but at the end of the day it doesn't matter how natural the system sounds if no one can understand the sound it puts out!

SOUND SYSTEM EQUALISATION

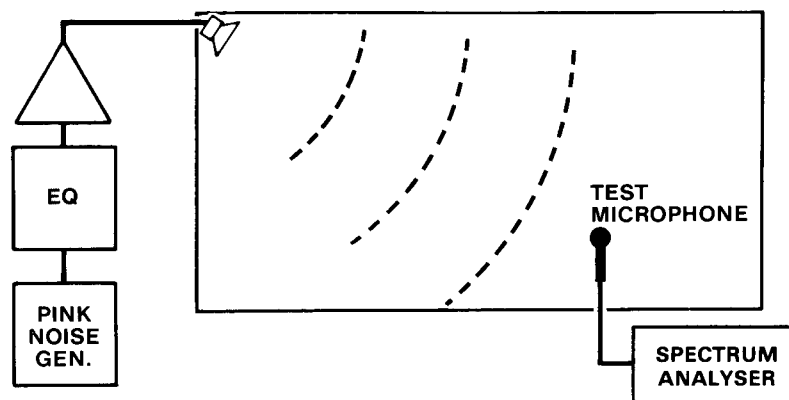

Sound System Equalisation.

Before beginning to equalise a system, it is a good practice to listen to the "raw" system with speech or music programme. If such signals are distorted then stop and rectify them before attempting to equalise. Another good pre-equalisation test is to use a slow sine-sweep. This can expose a number of problems such as rattles or distortion or poorly controlled room modes and resonances - which pink noise RTA cannot discover. Finally, before equalisation, check the coverage of the system over the 2 to 4kHz bank. (If necessary, use the equaliser as a band pass filter to produce the desired range). If coverage is poor to begin with then no amount of equalisation will overcome this. Again adjustments to the system itself are required. Equalisation is the final tuning stage. Generally, a gradual transition between adjacent bands should be aimed for, particularly in studio monitoring situations where the maximum difference between bands should only be 3dB or so. A warning bell should be ringing if you are using much more than this! This does not mean however that more drastic adjustments should not be used - this is very often necessary with sound systems operating in poor or severe acoustic environments, but the reason why such a particularly large fader excursion is being used at a given frequency should always be carefully considered.

Once satisfied with the basic system, performance equalisation can begin. If using a real time analyser ensure that the microphone is in a sensible position i.e. within the coverage area of the system and not in an area where strong local acoustic effects might be expected such as within 1 metre of a rear or side wall or in a balcony opening.

A good idea is to rotate the measuring microphone in a wide arc or circle round the measuring position and to see if any strong interactions occur causing large deviations in response. If necessary, move to another position. Also ensure that the ambient noise level is at least 6dB (preferably 10dB) below the signal level you are using.

Having set up the desired house curve as smoothly as possible, move round and check the response throughout the listening area. Good equalisation requires time and patience. Do not forget that some interaction will occur between a particular filter and its adjacent bands. A better sound may be produced by adjusting several bands rather than by strongly cutting just the centre one. Do not forget to pause to talk or play music through the system as you go, so that you keep in touch with what the resultant sound quality is like.

If the Real Time Analyser you are using is the Klark-Teknik DN60/RT60 you have a powerful averaging capability which means that averaging the response throughout the coverage area becomes very much easier. The response displayed by the analyser should also become smoother as local fluctuations are averaged out whilst persistent peaks and dips clearly stand out and show where adjustment is truly required.

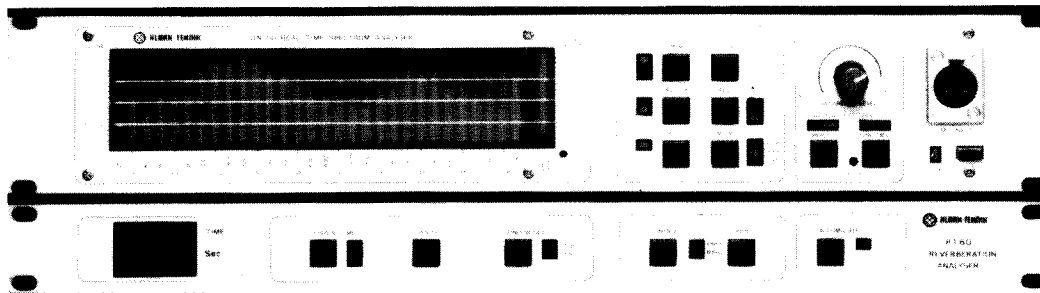

Real Time Spectrum Analyser with Averaging Model DN60/RT60.

Connecting a stage or house microphone into the analyser can be a most instructive exercise - showing up any local reflection or acoustic resonances or loudspeaker sidelobes. Generally repositioning the microphone or adjusting individual microphone channel equalisation will be needed, rather than adjustment to the overall house curve. This technique is particularly useful when investigating acoustic feedback after the initial house curve has been set.

Inserting the Equaliser in the Signal Chain

The exact point of insertion of an equaliser into the signal chain will very much depend on the task in hand e.g. mixer channel/line input, group insert point, group output, auxiliary send or between another signal processing device and the mixer or power amplifier, etc. When using delayed out signals for example, i.e. where a digital delay line is being used to synchronise sound arrivals in order to maintain intelligibility or source directionality, the option may exist to insert the equaliser either before or after the delay line e.g. in a conference venue employing similar loudspeaker types throughout the system, but connected to different delay outputs, the equaliser can be inserted before the delay line. In a more complex system where several loudspeaker types are employed, or where the local acoustic environment differs within the same system e.g. a theatre system with a central loudspeaker cluster and delayed side fills or underbalcony speakers, each delay channel will need its own separate equaliser in order to satisfactorily equalise out either the different loudspeaker responses or the effects of the different local acoustic environment.

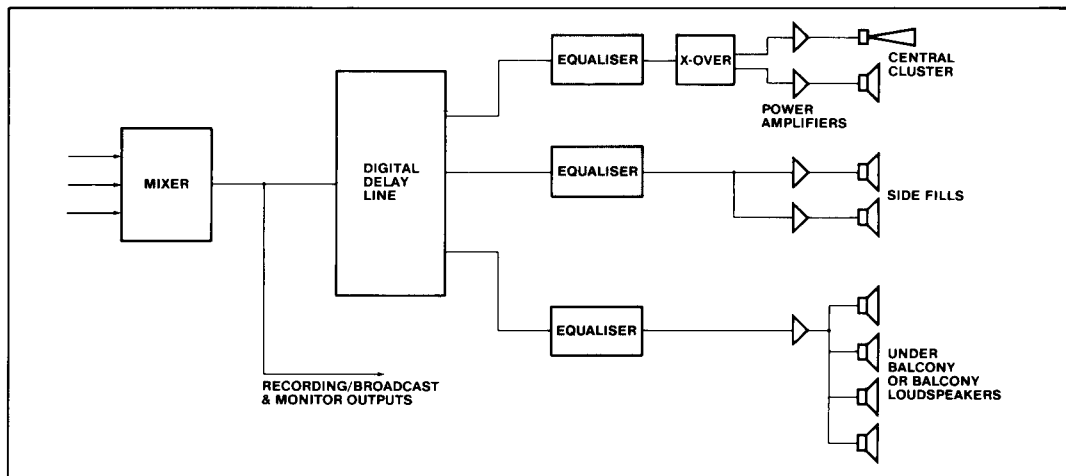

Simplified schematic diagram for a typical theatre sound system.

Equaliser Limitations

The equaliser is not the answer to poor sound system design - but instead it should be considered as a final tuning measure - such final tuning can often bring about quite remarkable improvements to the overall intelligibility and perceived sound quality of a system.

After an equaliser, a security cover is probably the most useful accessory a sound system could have. Equalisers, when used competently, can do wonders for your system - but when used badly.....

Warranty

This product is manufactured by Klark-Teknik and is warranted to be free from defects in components and factory workmanship under normal use and service for a period of one year from the date of purchase.

During the warranty period Klark-Teknik will undertake to repair or at its option, replace this product at no charge to its owner when failing to perform as specified, provided the unit is returned shipping pre-paid, to the factory or authorised service facility.*

No other warranty is expressed or implied.**

This warranty shall not be applicable and be void when this product is subjected to:-

- a) Repair work or alteration by persons other than those authorised by Klark-Teknik in such a manner as to injure, in the sole judgement of Klark-Teknik, the performance, stability, reliability or safety of this product.
- b) Misuse, negligence, accident, act of God, war or civil insurrection.
- c) Connection, installation, adjustment or use otherwise than in accordance with the instructions provided by Klark-Teknik.

* See enclosed service request form.

** "MELT" filter circuits used in the Series 300 Graphic Equalisers are warranted for 5 years.

Klark-Teknik reserves the right to alter specifications without notice. This warranty does not affect the statutory rights of the UK customer.



COPYMASTER DO NOT REMOVE

NOTE! This sheet is your Copymaster. Please duplicate on photocopier when needed.

Service Request Form

Please complete this form and send it to Klark-Teknik before returning the unit. Attach duplicate to the returned unit.

NAME TELEPHONE

ADDRESS
.....
.....
.....

MODEL No. SERIAL No.

PURCHASED FROM DATE

Please tick appropriate box

REPLACEMENT PACKING REQUIRED YES NO

- 1) Describe symptoms of malfunction.
- 2) Which channel(s) exhibit(s) the problem?
- 3) Under what conditions does the problem occur?
 - a) All the time
 - b) After a while
 - c) At high signal levels
 - d) At high temperatures
 - e) Other (please explain)

Is the fault: Permanent Intermittent

- 4) What did you do to isolate the problem to this unit?
- 5) Further comments.

Important Note:

It is often useful to call your dealer or the factory explaining the nature of the problem with the unit. In many instances the problem can be solved without returning the unit to the factory. If the unit has to be returned to the factory, use original packing only. If you do not have one, we will provide a replacement.

Factory authorised service facilities are located throughout the world. Call your dealer or the factory for the location of the service facility nearest you.

Klark Teknik Plc.
Klark Industrial Park
Walter Nash Road
Kidderminster
Worcs. DY11 7HJ
England.

Tel: (0562) 741515
Fax: (0562) 745371

COPYMASTER DO NOT REMOVE

NOTE! This sheet is your Copymaster. Please duplicate on photocopier when needed.

KLARK-TEKNIK DN301 GRAPHIC EQUALISER

0 -3 -6 -10 -15

25 31 40 50 63 80 100 125 160 200 250 315 400 500 630 800 1K 1K25 1K6 2K 2K5 3K15 4K 5K 6K3 8K 10K 12K5 16K 20K

D/LOAD SLOPE Eq.

12 6

IN OUT

50 100 150 200 250 300 3K5 5K 10K 15K 25K 30K 30K +20 dB LEVEL

LF HF

FADER SETTING RECORD CHART EQUALISER No. SERIAL No. LOCATION: DATE:

KLARK-TEKNIK DN301 GRAPHIC EQUALISER

0 -3 -6 -10 -15

25 31 40 50 63 80 100 125 160 200 250 315 400 500 630 800 1K 1K25 1K6 2K 2K5 3K15 4K 5K 6K3 8K 10K 12K5 16K 20K

D/LOAD SLOPE Eq.

12 6

IN OUT

50 100 150 200 250 300 3K5 5K 10K 15K 25K 30K 30K +20 dB LEVEL

LF HF

FADER SETTING RECORD CHART EQUALISER No. SERIAL No. LOCATION: DATE:

KLARK-TEKNIK DN301 GRAPHIC EQUALISER

0 -3 -6 -10 -15

25 31 40 50 63 80 100 125 160 200 250 315 400 500 630 800 1K 1K25 1K6 2K 2K5 3K15 4K 5K 6K3 8K 10K 12K5 16K 20K

D/LOAD SLOPE Eq.

12 6

IN OUT

50 100 150 200 250 300 3K5 5K 10K 15K 25K 30K 30K +20 dB LEVEL

LF HF

FADER SETTING RECORD CHART EQUALISER No. SERIAL No. LOCATION: DATE:

MARK TENTON FREQUENCY RANGE CHART

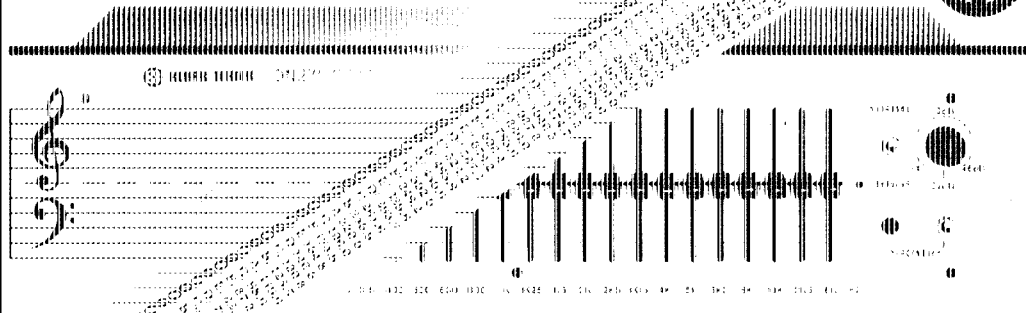

NOTES RELATED TO FREQUENCIES

This chart shows (above) the musical notes and octaves related to their actual frequencies. The details are cross-referenced (below) to the frequency ranges of our Graphic Equalisers and the range capabilities of most of our musical instruments.

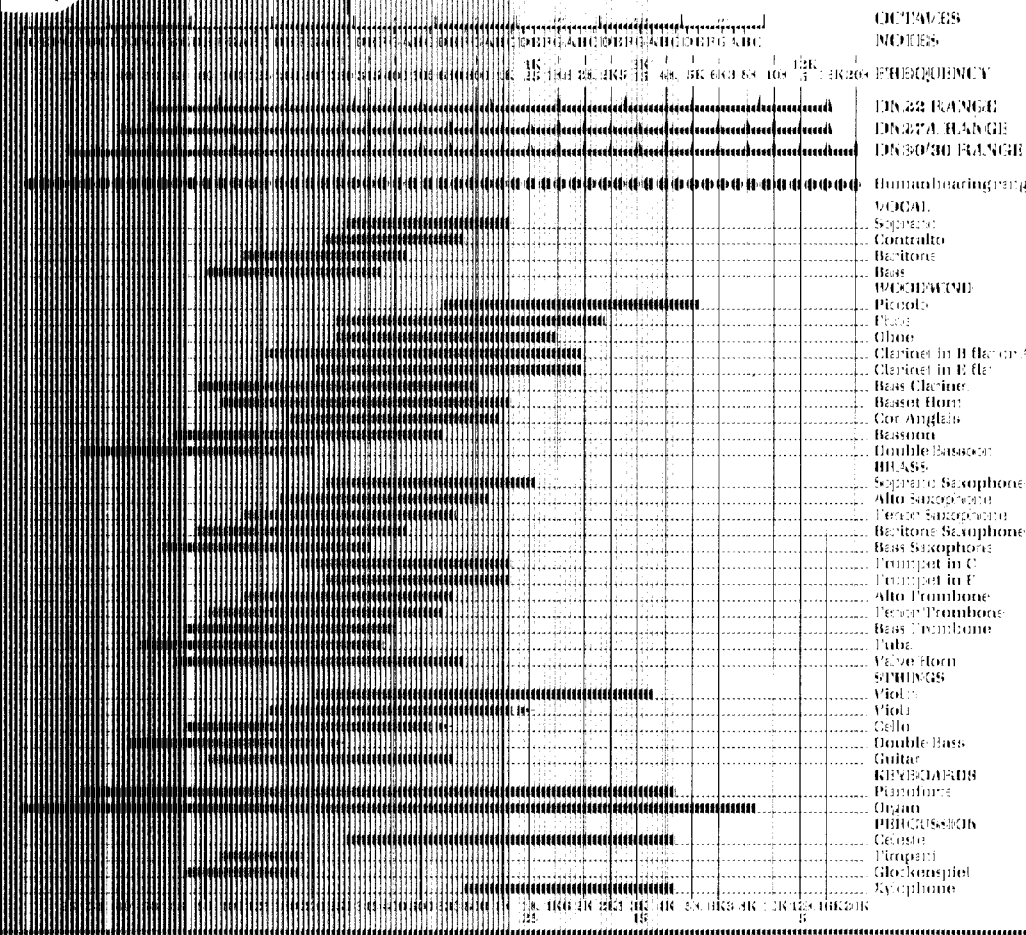

Frequency Range Chart